SAR Test Report

Report No.: AGC14075240803FH01

FCC ID : 2AWWH-CINSBBGA

PRODUCT DESIGNATION : Camera

BRAND NAME : Insta360

MODEL NAME : CINSBBGA,CINSBBGY (where Y would be any English letters or blank, different packing method, model designations on the marking plate for different commercial purpose)

APPLICANT : Arashi Vision Inc.

DATE OF ISSUE : Aug. 23,2024

STANDARD(S) : IEEE Std. 1528:2013
FCC 47 CFR Part 2§2.1093
IEEE Std C95.1™-2005

REPORT VERSION : V1.0

Attestation of Global Compliance(Shenzhen) Co., Ltd.



Any report having not been signed by authorized approver, or having been altered without authorization, or having not been stamped by the “Dedicated Testing/Inspection Stamp” is deemed to be invalid. Copying or excerpting portion of, or altering the content of the report is not permitted without the written authorization of AGC. The test results presented in the report apply only to the tested sample. Any objections to report issued by AGC should be submitted to AGC within 15days after the issuance of the test report. Further enquiry of validity or verification of the test report should be addressed to AGC by agc01@agccert.com.

Attestation of Global Compliance(Shenzhen)Co., Ltd
Attestation of Global Compliance(Shenzhen)Std & Tech Co., Ltd
Tel: +86-755 2523 4088 E-mail: agc@agccert.com Web: <http://www.agccert.com/>



Report Revise Record

Report Version	Revise Time	Issued Date	Valid Version	Notes
V1.0	/	Aug. 23,2024	Valid	Initial Release

Any report having not been signed by authorized approver, or having been altered without authorization, or having not been stamped by the "Dedicated Testing/Inspection Stamp" is deemed to be invalid. Copying or excerpting portion of, or altering the content of the report is not permitted without the written authorization of AGC. The test results presented in the report apply only to the tested sample. Any objections to report issued by AGC should be submitted to AGC within 15days after the issuance of the test report. Further enquiry of validity or verification of the test report should be addressed to AGC by agc01@agccert.com.

Attestation of Global Compliance(Shenzhen)Co., Ltd
Attestation of Global Compliance(Shenzhen)Std & Tech Co., Ltd
Tel: +86-755 2523 4088 E-mail: agc@agccert.com Web: <http://www.agccert.com/>

Test Report	
Applicant Name	Arashi Vision Inc.
Applicant Address	11th Floor, Building 2, Jinlitong Financial Center, Bao'an District, Shenzhen, Guangdong, China
Manufacturer Name	Arashi Vision Inc.
Manufacturer Address	11th Floor, Building 2, Jinlitong Financial Center, Bao'an District, Shenzhen, Guangdong, China
Factory Name	Arashi Vision Inc.
Factory Address	11th Floor, Building 2, Jinlitong Financial Center, Bao'an District, Shenzhen, Guangdong, China
Product Designation	Camera
Brand Name	Insta360
Test Model	CINSBBGA
Series Models	CINSBBGY (where Y would be any English letters or blank, different packing method, model designations on the marking plate for different commercial purpose)
Declaration of Difference	All the same, except for the model name.
EUT Voltage	DC 3.89V by battery
Applicable Standard	IEEE Std. 1528:2013 FCC 47 CFR Part 2§2.1093 IEEE Std C95.1™-2005
Date of receipt of test item	Aug. 06,2024
Test Date	Aug. 12,2024 to Aug. 16,2024
Report Template	AGCRT-US-4G/SAR (2021-04-20)

Note: The results of testing in this report apply to the product/system which was tested only.

Prepared By

Thea Huang

Thea Huang
(Project Engineer)

Aug. 23,2024

Reviewed By

Calvin Liu

Calvin Liu
(Reviewer)

Aug. 23,2024

Approved By

Max Zhang

Max Zhang
(Authorized Officer)

Aug. 23,2024

Any report having not been signed by authorized approver, or having been altered without authorization, or having not been stamped by the "Dedicated Testing/Inspection Stamp" is deemed to be invalid. Copying or excerpting portion of, or altering the content of the report is not permitted without the written authorization of AGC. The test results presented in the report apply only to the tested sample. Any objections to report issued by AGC should be submitted to AGC within 15days after the issuance of the test report. Further enquiry of validity or verification of the test report should be addressed to AGC by agc01@agccert.com.

TABLE OF CONTENTS

1. SUMMARY OF MAXIMUM SAR VALUE 5

2. GENERAL INFORMATION 6

 2.1. EUT DESCRIPTION 6

3. SAR MEASUREMENT SYSTEM 7

 3.1. THE SATIMO SYSTEM USED FOR PERFORMING COMPLIANCE TESTS CONSISTS OF FOLLOWING ITEMS 7

 3.2. COMOSAR E-FIELD PROBE 8

 3.3. ROBOT 8

 3.4. VIDEO POSITIONING SYSTEM 9

 3.5. DEVICE HOLDER 9

 3.6. SAM TWIN PHANTOM 10

4. SAR MEASUREMENT PROCEDURE 11

 4.1. SPECIFIC ABSORPTION RATE (SAR) 11

 4.2. SAR MEASUREMENT PROCEDURE 12

 4.3. RF EXPOSURE CONDITIONS 14

5. TISSUE SIMULATING LIQUID 15

 5.1. THE COMPOSITION OF THE TISSUE SIMULATING LIQUID 15

 5.2. TISSUE DIELECTRIC PARAMETERS FOR HEAD AND BODY PHANTOMS 16

 5.3. TISSUE CALIBRATION RESULT 17

6. SAR SYSTEM CHECK PROCEDURE 18

 6.1. SAR SYSTEM CHECK PROCEDURES 18

 6.2. SAR SYSTEM CHECK 19

7. EUT TEST POSITION 21

 7.1. TEST POSITION 21

8. SAR EXPOSURE LIMITS 22

9. TEST FACILITY 23

10. TEST EQUIPMENT LIST 24

11. MEASUREMENT UNCERTAINTY 25

12. CONDUCTED POWER MEASUREMENT 28

13. TEST RESULTS 30

 13.1. SAR TEST RESULTS SUMMARY 30

APPENDIX A. SAR SYSTEM CHECK DATA 34

APPENDIX B. SAR MEASUREMENT DATA 40

APPENDIX C. TEST SETUP PHOTOGRAPHS 48

APPENDIX D. CALIBRATION DATA 49

Any report having not been signed by authorized approver, or having been altered without authorization, or having not been stamped by the “Dedicated Testing/Inspection Stamp” is deemed to be invalid. Copying or excerpting portion of, or altering the content of the report is not permitted without the written authorization of AGC. The test results presented in the report apply only to the tested sample. Any objections to report issued by AGC should be submitted to AGC within 15days after the issuance of the test report. Further enquiry of validity or verification of the test report should be addressed to AGC by agc01@agccert.com.

1. SUMMARY OF MAXIMUM SAR VALUE

The maximum results of Specific Absorption Rate (SAR) found during testing for EUT are as follows:

Frequency Band	Highest Reported 1g-SAR(W/kg)	SAR Test Limit (W/kg)
	Body-worn(with 5mm separation)	
WIFI 2.4G	0.445	1.6
WIFI 5.2G	0.785	
WIFI 5.8G	0.789	
BT	0.185	
SAR Test Result	PASS	

This device is compliance with Specific Absorption Rate (SAR) for general population/uncontrolled exposure limits (1.6W/kg) specified in IEEE Std. 1528:2013; FCC 47CFR § 2.1093; IEEE/ANSI C95.1:2005 and the following specific FCC Test Procedures:

- KDB 447498 D01 General RF Exposure Guidance v06
- KDB 648474 D04 Handset SAR v01r03
- KDB 865664 D01 SAR Measurement 100MHz to 6GHz v01r04
- KDB 248227 D01 802 11 Wi-Fi SAR v02r02

Any report having not been signed by authorized approver, or having been altered without authorization, or having not been stamped by the "Dedicated Testing/Inspection Stamp" is deemed to be invalid. Copying or excerpting portion of, or altering the content of the report is not permitted without the written authorization of AGC. The test results presented in the report apply only to the tested sample. Any objections to report issued by AGC should be submitted to AGC within 15days after the issuance of the test report. Further enquiry of validity or verification of the test report should be addressed to AGC by agc01@agccert.com.

2. GENERAL INFORMATION

2.1. EUT Description

General Information	
Product Designation	Camera
Test Model	CINSBBGA
Sample ID	240822053
Hardware Version	V07
Software Version	V0.2.3
Device Category	Portable
RF Exposure Environment	Uncontrolled Environment General Population
Antenna Type	Internal
Bluetooth	
Bluetooth Version	V5.2
Operation Frequency	2402~2480MHz
Type of modulation	<input checked="" type="checkbox"/> GFSK <input checked="" type="checkbox"/> π/4-DQPSK <input checked="" type="checkbox"/> 8-DPSK
Max. Average Power	6.66dBm
Antenna gain	2.2dBi
2.4GHz WIFI	
WIFI Specification	<input checked="" type="checkbox"/> 802.11b <input checked="" type="checkbox"/> 802.11g <input checked="" type="checkbox"/> 802.11n(20)
Operation Frequency	2412~2462MHz
Max. Average Power	13.78dBm
Antenna gain	2.2dBi
5 GHz WIFI	
WIFI Specification	<input checked="" type="checkbox"/> 802.11a <input checked="" type="checkbox"/> 802.11n20 <input checked="" type="checkbox"/> 802.11n40 <input checked="" type="checkbox"/> 802.11ac20 <input checked="" type="checkbox"/> 802.11ac40 <input checked="" type="checkbox"/> 802.11ac80
Operation Frequency	U-NII-1: 5180MHz~5240MHz; U-NII-3: 5745MHz~5825MHz
Max. Average Power	U-NII-1: 10.72dBm; U-NII-3: 9.19dBm
Antenna gain	U-NII-1: 1.6dBi; U-NII-3: 4.2dBi
Accessories	
Battery	Brand name: N/A Voltage: DC 3.89V; Capacitance: 1800mAh;

Note:1. The sample used for testing is end product.

2. The test sample has no any deviation to the test method of standard mentioned in page 1.

Product	Type
	<input checked="" type="checkbox"/> Production unit <input type="checkbox"/> Identical Prototype

Any report having not been signed by authorized approver, or having been altered without authorization, or having not been stamped by the "Dedicated Testing/Inspection Stamp" is deemed to be invalid. Copying or excerpting portion of, or altering the content of the report is not permitted without the written authorization of AGC. The test results presented in the report apply only to the tested sample. Any objections to report issued by AGC should be submitted to AGC within 15days after the issuance of the test report. Further enquiry of validity or verification of the test report should be addressed to AGC by agc01@agccert.com.

3. SAR MEASUREMENT SYSTEM

3.1. The SATIMO system used for performing compliance tests consists of following items

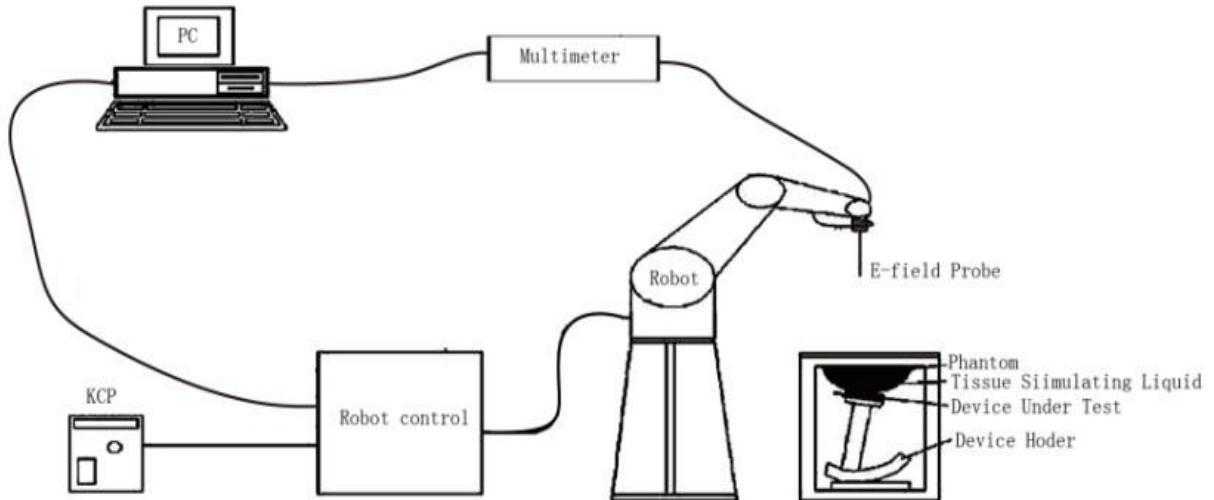

The COMOSAR system for performing compliance tests consists of the following items:

- The PC. It controls most of the bench devices and stores measurement data. A computer running WinXP and the Opensar software.
- The E-Field probe. The probe is a 3-axis system made of 3 distinct dipoles. Each dipole returns a voltage in function of the ambient electric field.
- The Keithley multimeter measures each probe dipole voltages.
- The SAM phantom simulates a human head. The measurement of the electric field is made inside the phantom.
- The liquids simulate the dielectric properties of the human head tissues.
- The network emulator controls the mobile phone under test.
- The validation dipoles are used to measure a reference SAR. They are used to periodically check the bench to make sure that there is no drift of the system characteristics over time.
- The phantom, the device holder and other accessories according to the targeted measurement.

Any report having not been signed by authorized approver, or having been altered without authorization, or having not been stamped by the “Dedicated Testing/Inspection Stamp” is deemed to be invalid. Copying or excerpting portion of, or altering the content of the report is not permitted without the written authorization of AGC. The test results presented in the report apply only to the tested sample. Any objections to report issued by AGC should be submitted to AGC within 15days after the issuance of the test report. Further enquiry of validity or verification of the test report should be addressed to AGC by agc01@agccert.com.

3.2. COMOSAR E-Field Probe

The SAR measurement is conducted with the dosimetric probe manufactured by SATIMO. The probe is specially designed and calibrated for use in liquid with high permittivity. The dosimetric probe has special calibration in liquid at different frequency. SATIMO conducts the probe calibration in compliance with international and national standards (e.g. IEEE 1528 and relevant KDB files.) The calibration data are in Appendix D.

Isotropic E-Field Probe Specification

Model	SSE2	
Manufacture	MVG	
Identification No.	2023-EPGO-414	
Frequency	0.15GHz-7.5GHz Linearity:±0.09dB(0.15GHz-7.5GHz)	
Dynamic Range	0.01W/kg-100W/kg Linearity:±0.09dB	
Dimensions	Overall length:330mm Length of individual dipoles:24.5mm Maximum external diameter:8mm Probe Tip external diameter:2.55mm Distance between dipoles/ probe extremity:12.7mm	
Application	High precision dosimetric measurements in any exposure scenario (e.g., very strong gradient fields). Only probe which enables compliance testing for frequencies up to 6 GHz with precision of better 30%.	

3.3. Robot

The COMOSAR system uses the KUKA robot from SATIMO SA (France).For the 6-axis controller COMOSAR system, the KUKA robot controller version from SATIMO is used.

The XL robot series have many features that are important for our application:

- High precision (repeatability 0.02 mm)
- High reliability (industrial design)
- Jerk-free straight movements
- Low ELF interference (the closed metallic construction shields against motor control fields)
- 6-axis controller



Any report having not been signed by authorized approver, or having been altered without authorization, or having not been stamped by the “Dedicated Testing/Inspection Stamp” is deemed to be invalid. Copying or excerpting portion of, or altering the content of the report is not permitted without the written authorization of AGC. The test results presented in the report apply only to the tested sample. Any objections to report issued by AGC should be submitted to AGC within 15days after the issuance of the test report. Further enquiry of validity or verification of the test report should be addressed to AGC by agc01@agccert.com.

3.4. Video Positioning System

The video positioning system is used in OpenSAR to check the probe. Which is composed of a camera, LED, mirror and mechanical parts. The camera is piloted by the main computer with firewire link. During the process, the actual position of the probe tip with respect to the robot arm is measured, as well as the probe length and the horizontal probe offset. The software then corrects all movements, such that the robot coordinates are valid for the probe tip. The repeatability of this process is better than 0.1 mm. If a position has been taught with an aligned probe, the same position will be reached with another aligned probe within 0.1 mm, even if the other probe has different dimensions. During probe rotations, the probe tip will keep its actual position.

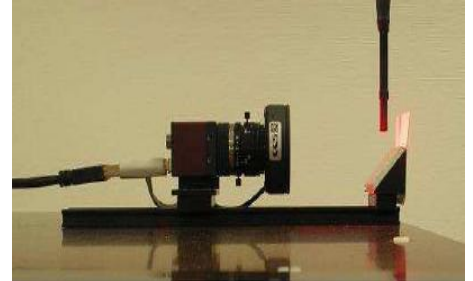

3.5. Device Holder

The COMOSAR device holder is designed to cope with different positions given in the standard. It has two scales for the device rotation (with respect to the body axis) and the device inclination (with respect to the line between the ear reference points). The rotation center for both scales is the ear reference point (EPR). Thus the device needs no repositioning when changing the angles. The COMOSAR device holder has been made out of low-loss POM material having the following dielectric parameters: relative permittivity $\epsilon_r = 3$ and loss tangent $\delta = 0.02$. The amount of dielectric material has been reduced in the closest vicinity of the device, since measurements have suggested that the influence of the clamp on the test results could thus be lowered.

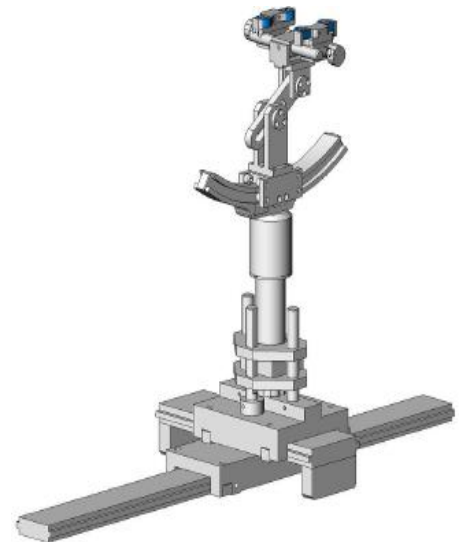

3.6. SAM Twin Phantom

The SAM twin phantom is a fiberglass shell phantom with 2mm shell thickness (except the ear region where shell thickness increases to 6mm). It has three measurement areas:

- Left head
- Right head
- Flat phantom



The bottom plate contains three pair of bolts for locking the device holder. The device holder positions are adjusted to the standard measurement positions in the three sections. A white cover is provided to tap the phantom during off-periods to prevent water evaporation and changes in the liquid parameters. On the phantom top, three reference markers are provided to identify the phantom position with respect to the robot.

ELLI39 Phantom

The Flat phantom is a fiberglass shellphantom with 2mm+/- 0.2 mm shell thickness. It has only one measurement area for Flat phantom



Any report having not been signed by authorized approver, or having been altered without authorization, or having not been stamped by the “Dedicated Testing/Inspection Stamp” is deemed to be invalid. Copying or excerpting portion of, or altering the content of the report is not permitted without the written authorization of AGC. The test results presented in the report apply only to the tested sample. Any objections to report issued by AGC should be submitted to AGC within 15days after the issuance of the test report. Further enquiry of validity or verification of the test report should be addressed to AGC by agc01@agccert.com.

4. SAR MEASUREMENT PROCEDURE

4.1. Specific Absorption Rate (SAR)

SAR is related to the rate at which energy is absorbed per unit mass in object exposed to a radio field. The SAR distribution in a biological body is complicated and is usually carried out by experimental techniques or numerical modeling. The standard recommends limits for two tiers of groups, occupational/controlled and occupational/uncontrolled, based on a person's awareness and ability to exercise control over his or her exposure. In general, occupational/controlled exposure limits are higher than the limits for general population/uncontrolled.

The SAR definition is the time derivative (rate) of the incremental energy (dW) absorbed by (dissipated in) an incremental mass (dm) contained in a volume element(dv) of given mass density (ρ). The equation description is as below:

$$SAR = \frac{d}{dt} \left(\frac{dW}{dm} \right) = \frac{d}{dt} \left(\frac{dW}{\rho dV} \right)$$

SAR is expressed in units of Watts per kilogram (W/kg)

SAR can be obtained using either of the following equations:

$$SAR = \frac{\sigma E^2}{\rho}$$

$$SAR = c_h \left. \frac{dT}{dt} \right|_{t=0}$$

Where

SAR	is the specific absorption rate in watts per kilogram;
E	is the r.m.s. value of the electric field strength in the tissue in volts per meter;
σ	is the conductivity of the tissue in siemens per metre;
ρ	is the density of the tissue in kilograms per cubic metre;
c _h	is the heat capacity of the tissue in joules per kilogram and Kelvin;

$\left. \frac{dT}{dt} \right|_{t=0}$ is the initial time derivative of temperature in the tissue in kelvins per second

4.2. SAR Measurement Procedure

Step 1: Power Reference Measurement

The Power Reference Measurement and Power Drift Measurement are for monitoring the power drift of the device under test in the batch process. The minimum distance of probe sensors to surface is 2.7mm This distance cannot be smaller than the distance os sensor calibration points to probe tip as `defined in the probe properties,

Step 2: Area Scan

The Area Scan is used as a fast scan in two dimensions to find the area of high field values, before doing a fine measurement around the hot spot. The sophisticated interpolation routines implemented in SATIMO software can find the maximum locations even in relatively coarse grids. When an Area Scan has measured all reachable points, it computes the field maximal found in the scanned area, within a range of the global maximum. The range (in db) is specified in the standards for compliance testing. For example, a 2db range is required in IEEE Standard 1528 standards, whereby 3db is a requirement when compliance is assessed in accordance with the ARIB standard (Japan) If one Zoom Scan follows the Area Scan, then only the absolute maximum will be taken as reference. For cases where multiple maximum are detected, the number of Zoom Scan has to be increased accordingly.

Area Scan Parameters extracted from KDB 865664 D01 SAR Measurement 100MHz to 6GHz

	≤ 3 GHz	> 3 GHz
Maximum distance from closest measurement point (geometric center of probe sensors) to phantom surface	5 ± 1 mm	$\frac{1}{2} \cdot \delta \cdot \ln(2) \pm 0.5$ mm
Maximum probe angle from probe axis to phantom surface normal at the measurement location	30° ± 1°	20° ± 1°
Maximum area scan spatial resolution: Δx_{Area} , Δy_{Area}	≤ 2 GHz: ≤ 15 mm 2 – 3 GHz: ≤ 12 mm	3 – 4 GHz: ≤ 12 mm 4 – 6 GHz: ≤ 10 mm
	When the x or y dimension of the test device, in the measurement plane orientation, is smaller than the above, the measurement resolution must be ≤ the corresponding x or y dimension of the test device with at least one measurement point on the test device.	

Step 3: Zoom Scan

Zoom Scan are used to assess the peak spatial SAR value within a cubic average volume containing 1g abd 10g of simulated tissue. The Zoom Scan measures points(refer to table below) within a cube whose base faces are centered on the maxima found in a preceding area scan job within the same procedure. When the measurement is done, the Zoom Scan evaluates the averaged SAR for 1g and 10g and displays these values next to the job's label.

Any report having not been signed by authorized approver, or having been altered without authorization, or having not been stamped by the “Dedicated Testing/Inspection Stamp” is deemed to be invalid. Copying or excerpting portion of, or altering the content of the report is not permitted without the written authorization of AGC. The test results presented in the report apply only to the tested sample. Any objections to report issued by AGC should be submitted to AGC within 15days after the issuance of the test report. Further enquiry of validity or verification of the test report should be addressed to AGC by agc01@agccert.com.

Zoom Scan Parameters extracted from KDB865664 d01 SAR Measurement 100MHz to 6GHz

Maximum zoom scan spatial resolution: Δx_{Zoom} , Δy_{Zoom}		≤ 2 GHz: ≤ 8 mm 2 – 3 GHz: ≤ 5 mm*	3 – 4 GHz: ≤ 5 mm* 4 – 6 GHz: ≤ 4 mm*
Maximum zoom scan spatial resolution, normal to phantom surface	uniform grid: $\Delta z_{Zoom}(n)$	≤ 5 mm	3 – 4 GHz: ≤ 4 mm 4 – 5 GHz: ≤ 3 mm 5 – 6 GHz: ≤ 2 mm
	graded grid	$\Delta z_{Zoom}(1)$: between 1 st two points closest to phantom surface	≤ 4 mm
		$\Delta z_{Zoom}(n>1)$: between subsequent points	$\leq 1.5 \cdot \Delta z_{Zoom}(n-1)$
Minimum zoom scan volume	x, y, z	≥ 30 mm	3 – 4 GHz: ≥ 28 mm 4 – 5 GHz: ≥ 25 mm 5 – 6 GHz: ≥ 22 mm
<p>Note: δ is the penetration depth of a plane-wave at normal incidence to the tissue medium; see draft standard IEEE P1528-2011 for details.</p> <p>* When zoom scan is required and the <i>reported</i> SAR from the <i>area scan based 1-g SAR estimation</i> procedures of KDB 447498 is ≤ 1.4 W/kg, ≤ 8 mm, ≤ 7 mm and ≤ 5 mm zoom scan resolution may be applied, respectively, for 2 GHz to 3 GHz, 3 GHz to 4 GHz and 4 GHz to 6 GHz.</p>			

Step 4: Power Drift Measurement

The Power Drift Measurement measures the field at the same location as the most recent power reference measurement within the same procedure, and with the same settings. The Power Drift Measurement gives the field difference in dB from the reading conducted within the same settings. This allows a user to monitor the power drift of the device under test within a batch process. The measurement procedure is the same as Step 1.

4.3. RF Exposure Conditions

Test Configuration and setting:

The EUT is a model of Portable Mobile Station (MS).

The EUT have only one Antenna and It supports BT and WIFI function.

For WLAN testing, the EUT is configured with the WLAN continuous TX tool through engineering command.

CINSBBGA Antenna Location: (The Front View)

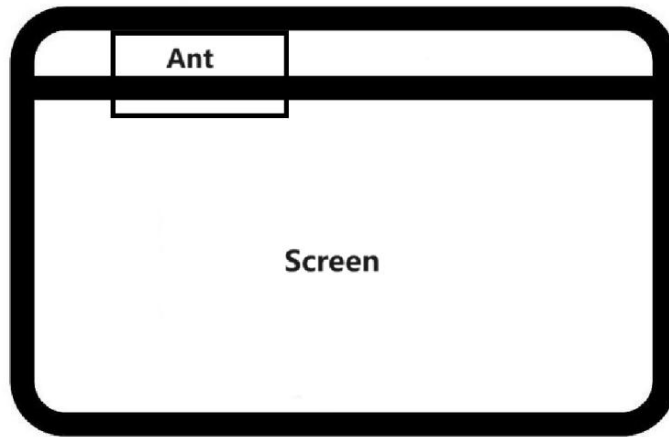

As shown above: The EUT antenna is less than 50mm away from each edge. Therefore the **Body_front & Body_back, and 4 edges** of EUT was tested.

EUT Sides for SAR Testing							
Mode	Exposure Condition	Body_front	Body_back	Left	Right	Top	Bottom
BT	Body	Yes	Yes	Yes	Yes	Yes	Yes
WIFI 2.4G	Body	Yes	Yes	Yes	Yes	Yes	Yes
WIFI 5.2G	Body	Yes	Yes	Yes	Yes	Yes	Yes
WIFI 5.8G	Body	Yes	Yes	Yes	Yes	Yes	Yes

Any report having not been signed by authorized approver, or having been altered without authorization, or having not been stamped by the "Dedicated Testing/Inspection Stamp" is deemed to be invalid. Copying or excerpting portion of, or altering the content of the report is not permitted without the written authorization of AGC. The test results presented in the report apply only to the tested sample. Any objections to report issued by AGC should be submitted to AGC within 15days after the issuance of the test report. Further enquiry of validity or verification of the test report should be addressed to AGC by agc01@agccert.com.

5. TISSUE SIMULATING LIQUID

For SAR measurement of the field distribution inside the phantom, the phantom must be filled with homogeneous tissue simulating liquid to a depth of at least 15cm. For head SAR testing the liquid height from the ear reference point (ERP) of the phantom to the liquid top surface is larger than 15cm For body SAR testing, the liquid height from the center of the flat phantom to the liquid top surface is larger than 15cm. The nominal dielectric values of the tissue simulating liquids in the phantom and the tolerance of 10% are listed in 6.2

5.1. The composition of the tissue simulating liquid

Frequency (MHz) \ Ingredient (% Weight)	Water	Nacl	Polysorbate 20	DGBE	1,2-Propanediol	Triton X-100	Diethylen glycol monohex ylether
2450 Head	71.88	0.16	0.0	7.99	0.0	19.97	0.0
5000 Head	65.52	0.0	0.0	0.0	0.0	17.24	17.24

Any report having not been signed by authorized approver, or having been altered without authorization, or having not been stamped by the "Dedicated Testing/Inspection Stamp" is deemed to be invalid. Copying or excerpting portion of, or altering the content of the report is not permitted without the written authorization of AGC. The test results presented in the report apply only to the tested sample. Any objections to report issued by AGC should be submitted to AGC within 15days after the issuance of the test report. Further enquiry of validity or verification of the test report should be addressed to AGC by agc01@agccert.com.

5.2. Tissue Dielectric Parameters for Head and Body Phantoms

The head and body tissue dielectric parameters recommended by the IEEE Std. 1528 have been incorporated in the following table.

Target Frequency (MHz)	head		body	
	ϵ_r	σ (S/m)	ϵ_r	σ (S/m)
300	45.3	0.87	45.3	0.87
450	43.5	0.87	43.5	0.87
750	41.9	0.89	41.9	0.89
835	41.5	0.90	41.5	0.90
900	41.5	0.97	41.5	0.97
915	41.5	1.01	41.5	1.01
1450	40.5	1.20	40.5	1.20
1610	40.3	1.29	40.3	1.29
1750	40.1	1.37	40.1	1.37
1800 – 2000	40.0	1.40	40.0	1.40
2300	39.5	1.67	39.5	1.67
2450	39.2	1.80	39.2	1.80
2600	39.0	1.96	39.0	1.96
3000	38.5	2.40	38.5	2.40
5200	36.0	4.66	36.0	4.66
5300	35.9	4.76	35.9	4.76
5600	35.5	5.07	35.5	5.07
5800	35.3	5.27	35.3	5.27

(ϵ_r = relative permittivity, σ = conductivity and $\rho = 1000 \text{ kg/m}^3$)

Any report having not been signed by authorized approver, or having been altered without authorization, or having not been stamped by the “Dedicated Testing/Inspection Stamp” is deemed to be invalid. Copying or excerpting portion of, or altering the content of the report is not permitted without the written authorization of AGC. The test results presented in the report apply only to the tested sample. Any objections to report issued by AGC should be submitted to AGC within 15days after the issuance of the test report. Further enquiry of validity or verification of the test report should be addressed to AGC by agc01@agccert.com.

5.3. Tissue Calibration Result

The dielectric parameters of the liquids were verified prior to the SAR evaluation using SATIMO Dielectric Probe Kit and R&S Network Analyzer ZVL6.

Tissue Stimulant Measurement for 2450MHz					
	Fr. (MHz)	Dielectric Parameters ($\pm 10\%$)		Tissue Temp [°C]	Test time
		ϵ_r 39.2(35.28-43.12)	δ [s/m]1.80(1.62-1.98)		
Head	2402	39.56	1.80	22.6	Aug. 14, 2024
	2412	39.51	1.82		
	2437	39.45	1.84		
	2441	39.42	1.85		
	2450	39.40	1.89		
	2462	39.34	1.90		
	2480	39.32	1.93		

Tissue Stimulant Measurement for 5200MHz					
	Fr. (MHz)	Dielectric Parameters ($\pm 10\%$)		Tissue Temp [°C]	Test time
		ϵ_r 36.0(32.4-39.6)	δ [s/m]4.66(4.194 -5.126)		
Head	5180	35.68	4.56	22.3	Aug. 15, 2024
	5200	35.53	4.60		
	5240	35.46	4.69		

Tissue Stimulant Measurement for 5800MHz					
	Fr. (MHz)	Dielectric Parameters ($\pm 10\%$)		Tissue Temp [°C]	Test time
		ϵ_r 35.3 (31.77-38.83)	δ [s/m]5.27 (4.743-5.797)		
Head	5745	35.05	5.13	22.3	Aug. 15, 2024
	5785	34.93	5.19		
	5800	34.85	5.20		
	5825	34.77	5.29		

Any report having not been signed by authorized approver, or having been altered without authorization, or having not been stamped by the “Dedicated Testing/Inspection Stamp” is deemed to be invalid. Copying or excerpting portion of, or altering the content of the report is not permitted without the written authorization of AGC. The test results presented in the report apply only to the tested sample. Any objections to report issued by AGC should be submitted to AGC within 15days after the issuance of the test report. Further enquiry of validity or verification of the test report should be addressed to AGC by agc01@agccert.com.

6. SAR SYSTEM CHECK PROCEDURE

6.1. SAR System Check Procedures

SAR system check is required to confirm measurement accuracy, according to the tissue dielectric media, probe calibration points and other system operating parameters required for measuring the SAR of a test device. The system verification must be performed for each frequency band and within the valid range of each probe calibration point required for testing the device. The same SAR probe(s) and tissue-equivalent media combinations used with each specific SAR system for system verification must be used for device testing. When multiple probe calibration points are required to cover substantially large transmission bands, independent system verifications are required for each probe calibration point. A system verification must be performed before each series of SAR measurements using the same probe calibration point and tissue-equivalent medium. Additional system verification should be considered according to the conditions of the tissue-equivalent medium and measured tissue dielectric parameters, typically every three to four days when the liquid parameters are remeasured or sooner when marginal liquid parameters are used at the beginning of a series of measurements.

Each SATIMO system is equipped with one or more system check kits. These units, together with the predefined measurement procedures within the SATIMO software, enable the user to conduct the system check and system validation. System kit includes a dipole, and dipole device holder.

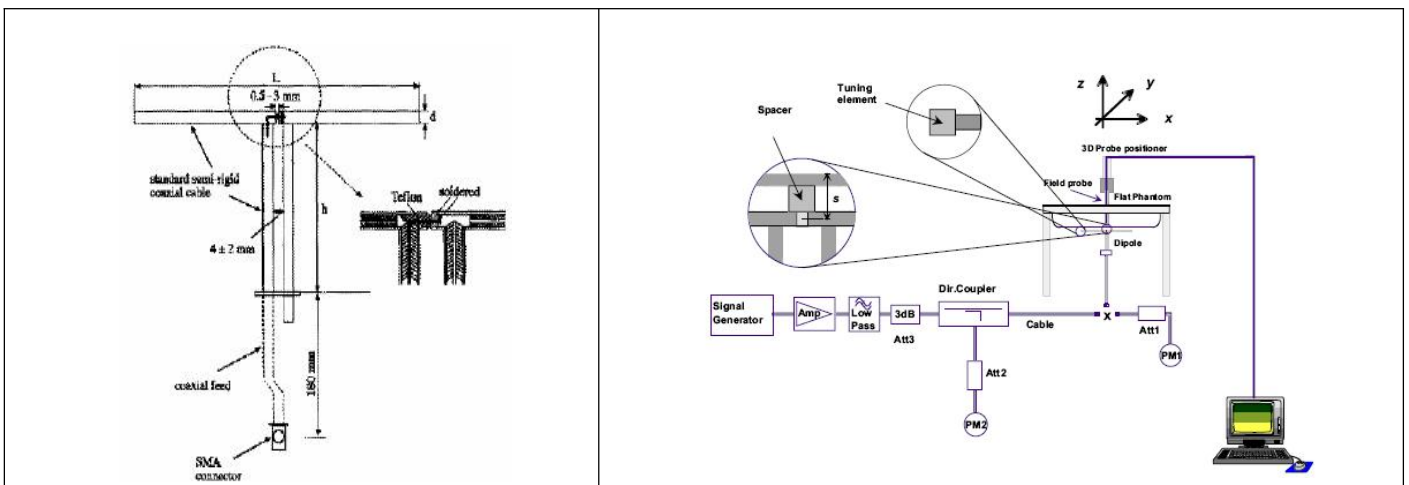

The system check verifies that the system operates within its specifications. It's performed daily or before every SAR measurement. The system check uses normal SAR measurement in the flat section of the phantom with a matched dipole at a specified distance. The system check setup is shown as below.



Any report having not been signed by authorized approver, or having been altered without authorization, or having not been stamped by the "Dedicated Testing/Inspection Stamp" is deemed to be invalid. Copying or excerpting portion of, or altering the content of the report is not permitted without the written authorization of AGC. The test results presented in the report apply only to the tested sample. Any objections to report issued by AGC should be submitted to AGC within 15 days after the issuance of the test report. Further enquiry of validity or verification of the test report should be addressed to AGC by agc01@agccert.com.

6.2. SAR System Check

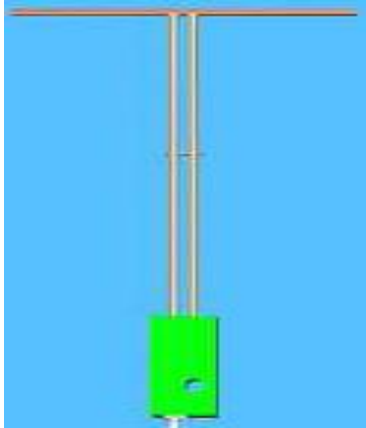
6.2.1. Dipoles

	<p>The dipoles are based on the IEEE-1528 standard, and are complied with mechanical and electrical specifications in line with the requirements of IEEE. the table below provides details for the mechanical and electrical Specifications for the dipoles.</p>
	<p>The dipole is based on the IEEE-1528 standard, and is complied with mechanical and electrical specifications in line with the requirements of IEEE. The table below provides details for the mechanical and electrical specifications for the wave guide.</p>

Frequency	L (mm)	h (mm)	d (mm)
2450MHz	51.5	30.4	3.6
5000MHz	20.6	40.3	3.6

Any report having not been signed by authorized approver, or having been altered without authorization, or having not been stamped by the “Dedicated Testing/Inspection Stamp” is deemed to be invalid. Copying or excerpting portion of, or altering the content of the report is not permitted without the written authorization of AGC. The test results presented in the report apply only to the tested sample. Any objections to report issued by AGC should be submitted to AGC within 15days after the issuance of the test report. Further enquiry of validity or verification of the test report should be addressed to AGC by agc01@agccert.com.

6.2.2. System Check Result

System Performance Check at 2450MHz & 5200MHz & 5800MHz for Head								
Validation Kit: SN 29/15 DIP 2G450-393 & SN 17/22 DIP 5G000-671								
Frequency [MHz]	Target Value(W/kg)		Reference Result ($\pm 10\%$)		Tested Value(W/kg)		Tissue Temp. [°C]	Test time
	1g	10g	1g	10g	1g	10g		
2450	54.32	24.25	48.888-59.752	21.825-26.675	53.41	23.83	22.6	Aug. 14, 2024
5200	73.43	21.83	66.087-80.773	19.647-24.013	73.11	21.22	22.3	Aug. 15, 2024
5800	75.69	22.44	68.121-83.259	20.196-24.684	75.05	22.23	22.3	Aug. 15, 2024

Note:

(1) We use a CW signal of 18dBm for system check, and then all SAR value are normalized to 1W forward power. The result must be within $\pm 10\%$ of target value.

Any report having not been signed by authorized approver, or having been altered without authorization, or having not been stamped by the "Dedicated Testing/Inspection Stamp" is deemed to be invalid. Copying or excerpting portion of, or altering the content of the report is not permitted without the written authorization of AGC. The test results presented in the report apply only to the tested sample. Any objections to report issued by AGC should be submitted to AGC within 15days after the issuance of the test report. Further enquiry of validity or verification of the test report should be addressed to AGC by agc01@agccert.com.

7. EUT TEST POSITION

This EUT was tested in **Body front & Body back, and 4 edges.**

7.1. Test Position

- (1) To position the EUT parallel to the phantom surface.
- (2) To adjust the EUT parallel to the flat phantom.
- (3) To adjust the distance between the EUT surface and the flat phantom to **5mm**.

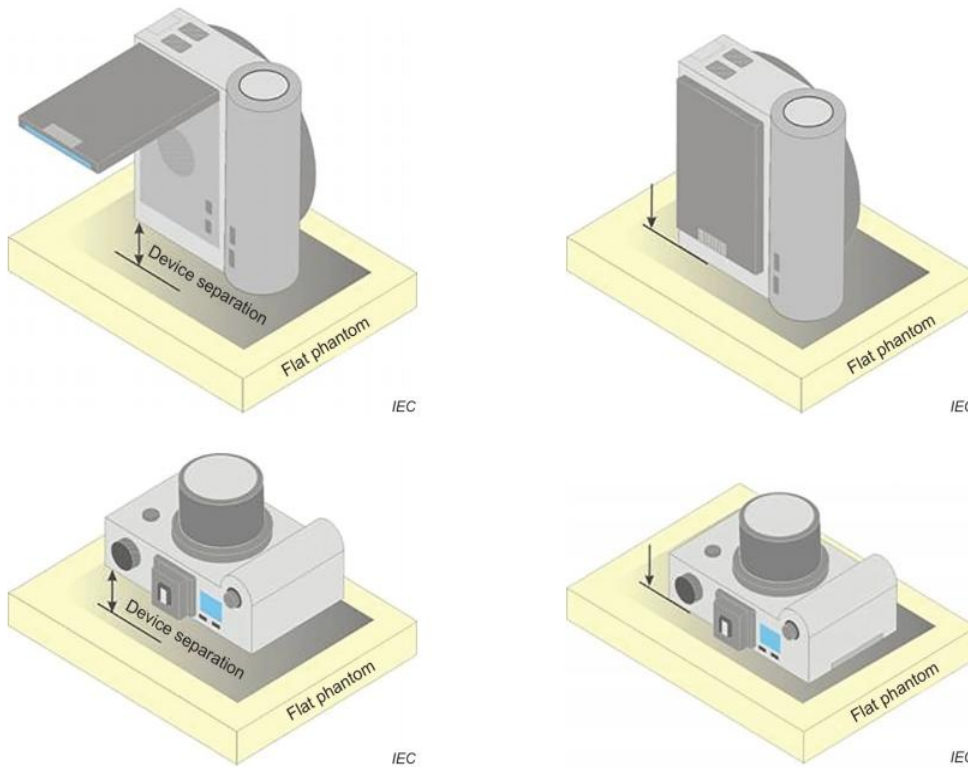

a) Still cameras and video cameras

Any report having not been signed by authorized approver, or having been altered without authorization, or having not been stamped by the “Dedicated Testing/Inspection Stamp” is deemed to be invalid. Copying or excerpting portion of, or altering the content of the report is not permitted without the written authorization of AGC. The test results presented in the report apply only to the tested sample. Any objections to report issued by AGC should be submitted to AGC within 15days after the issuance of the test report. Further enquiry of validity or verification of the test report should be addressed to AGC by agc01@agccert.com.

8. SAR EXPOSURE LIMITS

Limits for General Population/Uncontrolled Exposure (W/kg)

Type Exposure	Uncontrolled Environment Limit (W/kg)
Spatial Peak SAR (1g cube tissue for brain or body)	1.60
Spatial Average SAR (Whole body)	0.08
Spatial Peak SAR (Limbs)	4.0

Any report having not been signed by authorized approver, or having been altered without authorization, or having not been stamped by the "Dedicated Testing/Inspection Stamp" is deemed to be invalid. Copying or excerpting portion of, or altering the content of the report is not permitted without the written authorization of AGC. The test results presented in the report apply only to the tested sample. Any objections to report issued by AGC should be submitted to AGC within 15days after the issuance of the test report. Further enquiry of validity or verification of the test report should be addressed to AGC by agc01@agccert.com.

9. TEST FACILITY

Test Site	Attestation of Global Compliance (Shenzhen) Co., Ltd
Location	1-2/F, Building 19, Junfeng Industrial Park, Chongqing Road, Heping Community, Fuhai Street, Bao'an District, Shenzhen, Guangdong, China
Designation Number	CN1259
FCC Test Firm Registration Number	975832
A2LA Cert. No.	5054.02
Description	Attestation of Global Compliance(Shenzhen) Co., Ltd is accredited by A2LA

Any report having not been signed by authorized approver, or having been altered without authorization, or having not been stamped by the "Dedicated Testing/Inspection Stamp" is deemed to be invalid. Copying or excerpting portion of, or altering the content of the report is not permitted without the written authorization of AGC. The test results presented in the report apply only to the tested sample. Any objections to report issued by AGC should be submitted to AGC within 15days after the issuance of the test report. Further enquiry of validity or verification of the test report should be addressed to AGC by agc01@agccert.com.

Attestation of Global Compliance(Shenzhen)Co., Ltd
Attestation of Global Compliance(Shenzhen)Std & Tech Co., Ltd
Tel: +86-755 2523 4088 E-mail: agc@agccert.com Web: <http://www.agccert.com/>

10. TEST EQUIPMENT LIST

Equipment description	Manufacturer/ Model	Identification No.	Software version	Current calibration date	Next calibration date
SAR Probe	MVG	2023-EPGO-414	N/A	Apr 30, 2024	Apr 29, 2025
Phantom	SATIMO	SN_4511_SAM90	N/A	Validated. No cal required.	Validated. No cal required.
Liquid	SATIMO	N/A	N/A	Validated. No cal required.	Validated. No cal required.
Comm Tester	Agilent-8960	GB46310822	A.13.07	Jun. 03, 2024	Jun. 02, 2025
Comm Tester	R&S- CMW500	121209	V3.7.40	Jun. 01, 2024	May 31, 2025
Multimeter	Keithley 2000	4114939	N/A	Jun. 01, 2024	May 31, 2025
SAR Software	MVG-OpenSAR	N/A	OpenSAR V4_02_35	N/A	N/A
Dipole	SATIMO SID2450	SN 29/15 DIP 2G450-393	N/A	Apr. 28, 2022	Apr. 27, 2025
Dipole	SID5000	SN 17/22 DIP 5G000-671	N/A	Apr. 28, 2022	Apr. 27, 2025
Signal Generator	Agilent-E4438C	US41461365	V5.03	Jun. 01, 2024	May 31, 2025
Vector Analyzer	Agilent / E4440A	MY44303916	N/A	Jun. 01, 2024	May 31, 2025
Network Analyzer	Rhode & Schwarz ZVL6	SN101443	3.2	Sep. 21, 2023	Sep. 20, 2024
Amplifier	AS0104-55_55	1004793	N/A	N/A	N/A
Directional Couple	Werlatone/ C5571-10	SN99463	N/A	Feb. 01, 2024	Jan. 31, 2025
Directional Couple	Werlatone/ C6026-10	SN99482	N/A	Feb. 01, 2024	Jan. 31, 2025
Power Sensor	NRP-Z21	1137.6000.02	N/A	Sep. 05, 2023	Sep. 04, 2024
Power Viewer	R&S	V2.3.1.0	N/A	N/A	N/A
Calibration standard parts for network sub - port	R&S/ ZV-Z132	N/A	V2.3.1.0	Nov. 11, 2023	Nov. 10, 2024

Note: Per KDB 865664 Dipole SAR Validation, AGC Lab has adopted 3 years calibration intervals. On annual basis, every measurement dipole has been evaluated and is in compliance with the following criteria:

1. There is no physical damage on the dipole;
2. System validation with specific dipole is within 10% of calibrated value;
3. Return-loss is within 20% of calibrated measurement;
4. Impedance is within 5Ω of calibrated measurement.

Any report having not been signed by authorized approver, or having been altered without authorization, or having not been stamped by the “Dedicated Testing/Inspection Stamp” is deemed to be invalid. Copying or excerpting portion of, or altering the content of the report is not permitted without the written authorization of AGC. The test results presented in the report apply only to the tested sample. Any objections to report issued by AGC should be submitted to AGC within 15days after the issuance of the test report. Further enquiry of validity or verification of the test report should be addressed to AGC by agc01@agccert.com.

11. MEASUREMENT UNCERTAINTY

SATIMO Uncertainty- 2023-EPGO-414 Measurement uncertainty for DUT averaged over 1 gram / 10 gram.									
Uncertainty Component	Sec.	Tol (+-%)	Prob. Dist.	Div.	Ci (1g)	Ci (10g)	1g Ui (+-%)	10g Ui (+-%)	vi
Measurement System									
Probe calibration	E.2.1	7.000	N	1	1	1	7.000	7.000	∞
Axial Isotropy	E.2.2	1.695	R	1.732	0.707	0.707	0.692	0.692	∞
Hemispherical Isotropy	E.2.2	1.695	R	1.732	0.707	0.707	0.692	0.692	∞
Boundary effect	E.2.3	1.000	R	1.732	1	1	0.577	0.577	∞
Linearity	E.2.4	2.250	R	1.732	1	1	1.299	1.299	∞
System detection limits	E.2.4	1.000	R	1.732	1	1	0.577	0.577	∞
Modulation response	E.2.5	3.000	R	1.732	1	1	1.732	1.732	∞
Readout Electronics	E.2.6	0.021	N	1	1	1	0.021	0.021	∞
Response Time	E.2.7	0.000	R	1.732	1	1	0.000	0.000	∞
Integration Time	E.2.8	1.400	R	1.732	1	1	0.808	0.808	∞
RF ambient conditions-Noise	E.6.1	3.000	R	1.732	1	1	1.732	1.732	∞
RF ambient conditions-reflections	E.6.1	3.000	R	1.732	1	1	1.732	1.732	∞
Probe positioner mechanical tolerance	E.6.2	1.400	R	1.732	1	1	0.808	0.808	∞
Probe positioning with respect to phantom shell	E.6.3	1.400	R	1.732	1	1	0.808	0.808	∞
Extrapolation, interpolation, and integrations algorithms for max. SAR evaluation	E.5	2.300	R	1.732	1	1	1.328	1.328	∞
Test sample Related									
Test sample positioning	E.4.2	2.6	N	1	1	1	2.60	2.60	∞
Device holder uncertainty	E.4.1	3	N	1	1	1	3.00	3.00	∞
Output power variation—SAR drift measurement	E.2.9	5	R	1.732	1	1	2.89	2.89	∞
SAR scaling	E.6.5	5	R	1.732	1	1	2.89	2.89	∞
Phantom and tissue parameters									
Phantom shell uncertainty—shape, thickness, and permittivity	E.3.1	4	R	1.732	1	1	2.309	2.309	∞
Uncertainty in SAR correction for deviations in permittivity and conductivity	E.3.2	1.9	N	1	1	0.84	1.900	1.596	∞
Liquid conductivity measurement	E.3.3	4	N	1	0.78	0.71	3.120	2.840	M
Liquid permittivity measurement	E.3.3	5	N	1	0.23	0.26	1.150	1.300	M
Liquid conductivity—temperature uncertainty	E.3.4	2.5	R	1.732	0.78	0.71	1.126	1.025	∞
Liquid permittivity—temperature uncertainty	E.3.4	2.5	R	1.732	0.23	0.26	0.332	0.375	∞
Combined Standard Uncertainty			RSS				10.616	10.432	
Expanded Uncertainty (95% Confidence interval)			K=2				21.232	20.865	

Any report having not been signed by authorized approver, or having been altered without authorization, or having not been stamped by the “Dedicated Testing/Inspection Stamp” is deemed to be invalid. Copying or excerpting portion of, or altering the content of the report is not permitted without the written authorization of AGC. The test results presented in the report apply only to the tested sample. Any objections to report issued by AGC should be submitted to AGC within 15days after the issuance of the test report. Further enquiry of validity or verification of the test report should be addressed to AGC by agc01@agccert.com.

SATIMO Uncertainty- 2023-EPGO-414									
System Validation uncertainty for DUT averaged over 1 gram / 10 gram.									
Uncertainty Component	Sec.	Tol (+-%)	Prob. Dist.	Div.	Ci (1g)	Ci (10g)	1g Ui (+-%)	10g Ui (+-%)	vi
Measurement System									
Probe calibration	E.2.1	7.000	N	1	1	1	7.000	7.000	∞
Axial Isotropy	E.2.2	1.695	R	1.732	1.000	1.000	0.979	0.979	∞
Hemispherical Isotropy	E.2.2	1.695	R	1.732	0.000	0.000	0.000	0.000	∞
Boundary effect	E.2.3	1.000	R	1.732	1.000	1.000	0.577	0.577	∞
Linearity	E.2.4	2.250	R	1.732	1.000	1.000	1.299	1.299	∞
System detection limits	E.2.4	1.000	R	1.732	1.000	1.000	0.577	0.577	∞
Modulation response	E.2.5	3.000	R	1.732	0.000	0.000	0.000	0.000	∞
Readout Electronics	E.2.6	0.021	N	1.000	1.000	1.000	0.021	0.021	∞
Response Time	E.2.7	0.000	R	1.732	0.000	0.000	0.000	0.000	∞
Integration Time	E.2.8	1.400	R	1.732	0.000	0.000	0.000	0.000	∞
RF ambient conditions-Noise	E.6.1	3.000	R	1.732	1.000	1.000	1.732	1.732	∞
RF ambient conditions-reflections	E.6.1	3.000	R	1.732	1.000	1.000	1.732	1.732	∞
Probe positioner mechanical tolerance	E.6.2	1.400	R	1.732	1.000	1.000	0.808	0.808	∞
Probe positioning with respect to phantom shell	E.6.3	1.400	R	1.732	1.000	1.000	0.808	0.808	∞
Extrapolation, interpolation, and integrations algorithms for max. SAR evaluation	E.5	2.300	R	1.732	1.000	1.000	1.328	1.328	∞
System validation source									
Deviation of experimental dipole from numerical dipole	E.6.4	5	N	1	1	1	5	5	∞
Input power and SAR drift measurement	8,6.6.4	5	R	1.732	1	1	2.887	2.887	∞
Dipole axis to liquid distance	8,E.6.6	2	R	1.732	1	1	1.155	1.155	∞
Phantom and set-up									
Phantom shell uncertainty—shape, thickness, and permittivity	E.3.1	4	R	1.732	1	1	2.309	2.309	∞
Uncertainty in SAR correction for deviations in permittivity and conductivity	E.3.2	1.9	N	1	1	0.84	1.9	1.596	∞
Liquid conductivity (temperature uncertainty)	E.3.3	4	N	1	0.78	0.71	3.12	2.84	∞
Liquid conductivity (measured)	E.3.3	5	N	1	0.23	0.26	1.15	1.3	M
Liquid permittivity (temperature uncertainty)	E.3.4	2.5	R	1.732	0.78	0.71	1.126	1.025	∞
Liquid permittivity (measured)	E.3.4	2.5	R	1.732	0.23	0.26	0.332	0.375	M
Combined Standard Uncertainty			RSS				10.572	10.387	
Expanded Uncertainty (95% Confidence interval)			K=2				21.143	20.775	

Any report having not been signed by authorized approver, or having been altered without authorization, or having not been stamped by the “Dedicated Testing/Inspection Stamp” is deemed to be invalid. Copying or excerpting portion of, or altering the content of the report is not permitted without the written authorization of AGC. The test results presented in the report apply only to the tested sample. Any objections to report issued by AGC should be submitted to AGC within 15days after the issuance of the test report. Further enquiry of validity or verification of the test report should be addressed to AGC by agc01@agccert.com.

SATIMO Uncertainty- 2023-EPGO-414									
System Check uncertainty for DUT averaged over 1 gram / 10 gram.									
Uncertainty Component	Sec.	Tol (+-%)	Prob. Dist.	Div.	Ci (1g)	Ci (10g)	1g Ui (+-%)	10g Ui (+-%)	vi
Measurement System									
Probe calibration drift	E.2.1.3	0.5	N	1	1	1	0.5	0.5	∞
Axial Isotropy	E.2.2	1.695	R	$\sqrt{3}$	0	0	0	0	∞
Hemispherical Isotropy	E.2.2	1.695	R	$\sqrt{3}$	0	0	0	0	∞
Boundary effect	E.2.3	1.000	R	$\sqrt{3}$	0	0	0	0	∞
Linearity	E.2.4	2.250	R	$\sqrt{3}$	0	0	0	0	∞
System detection limits	E.2.4	1	R	$\sqrt{3}$	0	0	0	0	∞
Modulation response	E.2.5	3	R	$\sqrt{3}$	0	0	0	0	∞
Readout Electronics	E.2.6	0.021	N	$\sqrt{3}$	0	0	0	0	∞
Response Time	E.2.7	0	R	$\sqrt{3}$	0	0	0	0	∞
Integration Time	E.2.8	1.4	R	$\sqrt{3}$	0	0	0	0	∞
RF ambient conditions-Noise	E.6.1	3	R	$\sqrt{3}$	0	0	0	0	∞
RF ambient conditions-reflections	E.6.1	3	R	$\sqrt{3}$	0	0	0	0	∞
Probe positioner mechanical tolerance	E.6.2	1.4	R	$\sqrt{3}$	1	1	0.81	0.81	∞
Probe positioning with respect to phantom shell	E.6.3	1.4	R	$\sqrt{3}$	1	1	0.81	0.81	∞
Extrapolation, interpolation, and integrations algorithms for max. SAR evaluation	E.5	2.3	R	$\sqrt{3}$	0	0	0	0.00	∞
System check source (dipole)									
Deviation of experimental dipoles	E.6.4	2	N	1	1	1	2	2	∞
Input power and SAR drift measurement	8,6.6.4	5	R	$\sqrt{3}$	1	1	2.89	2.89	∞
Dipole axis to liquid distance	8,E.6.6	2	R	$\sqrt{3}$	1	1	1.15	1.15	∞
Phantom and tissue parameters									
Phantom shell uncertainty—shape, thickness, and permittivity	E.3.1	4	R	$\sqrt{3}$	1	1	2.31	2.31	∞
Uncertainty in SAR correction for deviations in permittivity and conductivity	E.3.2	1.9	N	1.000	1	0.84	1.90	1.60	∞
Liquid conductivity measurement	E.3.3	4	N	1.000	0.78	0.71	3.12	2.84	∞
Liquid permittivity measurement	E.3.3	5	N	1.000	0.23	0.26	1.15	1.30	M
Liquid conductivity—temperature uncertainty	E.3.4	2.5	R	$\sqrt{3}$	0.78	0.71	1.13	1.02	∞
Liquid permittivity—temperature uncertainty	E.3.4	2.5	R	$\sqrt{3}$	0.23	0.26	0.33	0.38	M
Combined Standard Uncertainty			RSS				5.562	5.203	
Expanded Uncertainty (95% Confidence interval)			K=2				11.124	10.406	

Any report having not been signed by authorized approver, or having been altered without authorization, or having not been stamped by the “Dedicated Testing/Inspection Stamp” is deemed to be invalid. Copying or excerpting portion of, or altering the content of the report is not permitted without the written authorization of AGC. The test results presented in the report apply only to the tested sample. Any objections to report issued by AGC should be submitted to AGC within 15days after the issuance of the test report. Further enquiry of validity or verification of the test report should be addressed to AGC by agc01@agccert.com.

12. CONDUCTED POWER MEASUREMENT

Bluetooth_BT

BT	Average Power(dBm)			
	Max. Tune up	CH0	CH39	CH78
		2402MHz	2441MHz	2480MHz
DH5	7.00	5.39	6.22	5.83
2DH5	7.00	6.14	6.56	6.25
3DH5	7.00	6.32	6.66	6.46

BT	Average Power(dBm)			
	Max. Tune up	CH0	CH19	CH39
		2402MHz	2440MHz	2480MHz
BLE(1M)	5.50	4.84	5.34	4.99
BLE(2M)	3.00	2.15	2.58	2.26

Note:

1) The tested channel results are marks in bold.

WIFI_WIFI2.4G

Band	Mode	Channel	Frequency (MHz)	Data Rate (Mbps)	Max. Tune up	Average Power(dBm)
2.4G WIFI	802.11b	1	2412	1	14.00	13.44
		6	2437		14.00	13.02
		11	2462		14.00	13.38
	802.11g	1	2412	6	14.00	13.61
		6	2437		14.00	13.31
		11	2462		14.00	13.15
	802.11n HT20	1	2412	HT0	14.00	13.78
		6	2437		14.00	13.75
		11	2462		14.00	13.46

Note:

1) The tested channel results are marks in bold.

Any report having not been signed by authorized approver, or having been altered without authorization, or having not been stamped by the "Dedicated Testing/Inspection Stamp" is deemed to be invalid. Copying or excerpting portion of, or altering the content of the report is not permitted without the written authorization of AGC. The test results presented in the report apply only to the tested sample. Any objections to report issued by AGC should be submitted to AGC within 15days after the issuance of the test report. Further enquiry of validity or verification of the test report should be addressed to AGC by agc01@agccert.com.

WIFI_WIFI5G

Band	Mode	Channel	Frequency (MHz)	Data Rate (Mbps)	Max. Tune-up	Average Power(dBm)
5.2G	802.11a	36	5180	6	11.00	10.31
		40	5200		11.00	10.63
		48	5240		11.00	10.72
	802.11n HT20	36	5180	HT0	11.00	9.94
		40	5200		11.00	10.25
		48	5240		11.00	10.41
	802.11n HT40	38	5190	HT0	11.00	10.70
		46	5230		11.00	10.62
	802.11ac VHT20	36	5180	VHT0	11.00	10.00
		40	5200		11.00	10.07
		48	5240		11.00	10.40
	802.11ac VHT40	38	5190	VHT0	11.00	10.68
		46	5230		11.00	10.62
	802.11ac VHT80	42	5210	VHT0	11.00	10.70
5.8G	802.11a	149	5745	6	10.00	8.78
		157	5785		10.00	9.01
		165	5825		10.00	9.19
	802.11n HT20	149	5745	HT0	10.00	8.22
		157	5785		10.00	8.59
		165	5825		10.00	8.85
	802.11n HT40	151	5755	HT0	10.00	8.74
		159	5795		10.00	9.05
	802.11ac VHT20	149	5745	VHT0	10.00	8.22
		157	5785		10.00	8.55
		165	5825		10.00	8.87
	802.11ac VHT40	151	5755	VHT0	10.00	8.73
		159	5795		10.00	9.08
	802.11ac VHT80	155	5775	VHT0	10.00	8.92

Note:

1) The tested channel results are marks in bold.

Any report having not been signed by authorized approver, or having been altered without authorization, or having not been stamped by the "Dedicated Testing/Inspection Stamp" is deemed to be invalid. Copying or excerpting portion of, or altering the content of the report is not permitted without the written authorization of AGC. The test results presented in the report apply only to the tested sample. Any objections to report issued by AGC should be submitted to AGC within 15days after the issuance of the test report. Further enquiry of validity or verification of the test report should be addressed to AGC by agc01@agccert.com.

13. TEST RESULTS

13.1. SAR Test Results Summary

13.1.1. Test position and configuration

Body_front&Body_back and 4 Edges SAR was performed with the device 5mm from the phantom.

13.1.2. Operation Mode

1. Per KDB 447498 D01 v06 ,for each exposure position, if the highest 1-g SAR is ≤ 0.8 W/kg, testing for low and high channel is optional.
2. Per KDB 865664 D01 v01r04,for each frequency band, if the measured SAR is ≥ 0.8 W/kg, testing for repeated SAR measurement is required , that the highest measured SAR is only to be tested. When the SAR results are near the limit, the following procedures are required for each device to verify these types of SAR measurement related variation concerns by repeating the highest measured SAR configuration in each frequency band.
 - (1) When the original highest measured SAR is ≥ 0.8 W/kg, repeat that measurement once.
 - (2) Perform a second repeated measurement only if the ratio of largest to smallest SAR for the original and first repeated measurements is >1.20 or when the original or repeated measurement is ≥ 1.45 W/kg.
 - (3) Perform a third repeated measurement only if the original, first and second repeated measurement is ≥ 1.5 W/kg and ratio of largest to smallest SAR for the original, first and second measurement is ≥ 1.20 .
3. Per KDB 248227 D01v02r02,for 2.4GHz 802.11g/n SAR testing is not required when the highest reported SAR for DSSS is adjusted by the ratio of OFDM to DSSS specified maximum output power and the adjusted SAR is ≤ 1.2 W/kg.
4. Per KDB 248227 D01 v02r02 Chapter 5.3.4, SAR measurement requirements for the remaining 802.11 transmission mode configurations that have not been tested in the initial test configuration are determined separately for each standalone and aggregated frequency band, in each exposure condition, according to the maximum output power specified for production units. The initial test position procedure is applied to next to the ear, UMPC mini-tablet and hotspot mode configurations. When the same maximum output power is specified for multiple transmission modes, the procedures in 5.3.2 are applied to determine the test configuration. Additional power measurements may be required to determine if SAR measurements are required for subsequent highest output power channels in a subsequent test configuration. The subsequent test configuration and SAR measurement procedures are described in the following.
 - (1) When SAR test exclusion provisions of KDB Publication 447498 D01 are applicable and SAR measurement is not required for the initial test configuration, SAR is also not required for the next highest maximum output power transmission mode subsequent test configuration(s) in that frequency band or aggregated band and exposure configuration.
 - (2) When the highest reported SAR for the initial test configuration (when applicable, include subsequent highest output channels), according to the initial test position or fixed exposure position requirements, is adjusted by the ratio of the subsequent test configuration to initial test configuration specified maximum output power and the adjusted SAR is ≤ 1.2 W/kg, SAR is not required for that subsequent test configuration.
5. Maximum Scaling SAR in order to calculate the Maximum SAR values to test under the standard Peak Power, Calculation method is as follows:
Maximum Scaling SAR =tested SAR (Max.) \times [maximum turn-up power (mw)/ maximum measurement output power(mw)]

Any report having not been signed by authorized approver, or having been altered without authorization, or having not been stamped by the "Dedicated Testing/Inspection Stamp" is deemed to be invalid. Copying or excerpting portion of, or altering the content of the report is not permitted without the written authorization of AGC. The test results presented in the report apply only to the tested sample. Any objections to report issued by AGC should be submitted to AGC within 15days after the issuance of the test report. Further enquiry of validity or verification of the test report should be addressed to AGC by agc01@agccert.com.

13.1.3. Test Result

SAR MEASUREMENT									
Depth of Liquid (cm):>15					Relative Humidity (%): 53.2				
Product:Camera									
Test Mode:802.11n20									
Position	Mode	Ch.	Fr. (MHz)	Power Drift (<±5%)	SAR (1g) (W/kg)	Max. Tune-up Power(dBm)	Meas. output Power (dBm)	Scaled SAR (W/kg)	Limit (W/kg)
Body front	802.11n20	1	2412	0	<0.01	14	13.78	<0.01	1.6
Body back	802.11n20	1	2412	0	<0.01	14	13.78	<0.01	1.6
Edge (Left)	802.11n20	1	2412	0.03	0.069	14	13.78	0.073	1.6
Edge (Right)	802.11n20	1	2412	0	<0.01	14	13.78	<0.01	1.6
Edge (Top)	802.11n20	1	2412	0.16	0.335	14	13.78	0.352	1.6
Edge (Bottom)	802.11n20	1	2412	0	<0.01	14	13.78	<0.01	1.6
Edge (Top)	802.11n20	6	2437	0.13	0.348	14	13.75	0.369	1.6
Edge (Top)	802.11n20	11	2462	-0.01	0.393	14	13.46	0.445	1.6

SAR MEASUREMENT									
Depth of Liquid (cm):>15					Relative Humidity (%): 53.2				
Product:Camera									
Test Mode:BT									
Position	Mode	Ch.	Fr. (MHz)	Power Drift (<±5%)	SAR (1g) (W/kg)	Max. Tune-up Power(dBm)	Meas. output Power (dBm)	Scaled SAR (W/kg)	Limit (W/kg)
Body front	3DH5	39	2441	0	<0.01	7	6.66	<0.01	1.6
Body back	3DH5	39	2441	0	<0.01	7	6.66	<0.01	1.6
Edge (Left)	3DH5	39	2441	0.07	0.033	7	6.66	0.036	1.6
Edge (Right)	3DH5	39	2441	0	<0.01	7	6.66	<0.01	1.6
Edge (Top)	3DH5	39	2441	0.11	0.171	7	6.66	0.185	1.6
Edge (Bottom)	3DH5	39	2441	0	<0.01	7	6.66	<0.01	1.6
Edge (Top)	3DH5	0	2402	0.02	0.126	7	6.32	0.147	1.6
Edge (Top)	3DH5	78	2480	-0.06	0.133	7	6.46	0.151	1.6

Any report having not been signed by authorized approver, or having been altered without authorization, or having not been stamped by the “Dedicated Testing/Inspection Stamp” is deemed to be invalid. Copying or excerpting portion of, or altering the content of the report is not permitted without the written authorization of AGC. The test results presented in the report apply only to the tested sample. Any objections to report issued by AGC should be submitted to AGC within 15days after the issuance of the test report. Further enquiry of validity or verification of the test report should be addressed to AGC by agc01@agccert.com.

SAR MEASUREMENT									
Depth of Liquid (cm):>15					Relative Humidity (%): 52.6				
Product:Camera									
Test Mode:802.11a									
Position	Mode	Ch.	Fr. (MHz)	Power Drift (<±5%)	SAR (1g) (W/kg)	Max. Tune-up Power(dBm)	Meas. output Power (dBm)	Scaled SAR (W/kg)	Limit (W/kg)
Body front	802.11a	48	5240	0	<0.01	11	10.72	<0.01	1.6
Body back	802.11a	48	5240	0	<0.01	11	10.72	<0.01	1.6
Edge (Left)	802.11a	48	5240	-0.12	0.225	11	10.72	0.240	1.6
Edge (Right)	802.11a	48	5240	0	<0.01	11	10.72	<0.01	1.6
Edge (Top)	802.11a	48	5240	0.07	0.736	11	10.72	0.785	1.6
Edge (Bottom)	802.11a	48	5240	0	<0.01	11	10.72	<0.01	1.6
Edge (Top)	802.11a	40	5200	0.15	0.711	11	10.63	0.774	1.6
Edge (Top)	802.11a	36	5180	-0.03	0.663	11	10.31	0.777	1.6

SAR MEASUREMENT									
Depth of Liquid (cm):>15					Relative Humidity (%): 53.0				
Product:Camera									
Test Mode:802.11a									
Position	Mode	Ch.	Fr. (MHz)	Power Drift (<±5%)	SAR (1g) (W/kg)	Max. Tune-up Power(dBm)	Meas. output Power (dBm)	Scaled SAR (W/kg)	Limit (W/kg)
Body front	802.11a	165	5825	0	<0.01	10	9.19	<0.01	1.6
Body back	802.11a	165	5825	0	<0.01	10	9.19	<0.01	1.6
Edge (Left)	802.11a	165	5825	0.07	0.203	10	9.19	0.245	1.6
Edge (Right)	802.11a	165	5825	0	<0.01	10	9.19	<0.01	1.6
Edge (Top)	802.11a	165	5825	-0.19	0.531	10	9.19	0.640	1.6
Edge (Bottom)	802.11a	165	5825	0	<0.01	10	9.19	<0.01	1.6
Edge (Top)	802.11a	157	5785	0.02	0.560	10	9.01	0.703	1.6
Edge (Top)	802.11a	149	5745	-0.14	0.596	10	8.78	0.789	1.6

Note:

- When the 1-g Reported SAR is ≤ 0.8 W/kg, testing for low and high channel is optional. Refer to KDB 447498.
- The test separation for body_front and body_back, and 4 Edges is 5mm of all above table
- Plots are only shown for the bold marked worst case SAR results.

Any report having not been signed by authorized approver, or having been altered without authorization, or having not been stamped by the "Dedicated Testing/Inspection Stamp" is deemed to be invalid. Copying or excerpting portion of, or altering the content of the report is not permitted without the written authorization of AGC. The test results presented in the report apply only to the tested sample. Any objections to report issued by AGC should be submitted to AGC within 15days after the issuance of the test report. Further enquiry of validity or verification of the test report should be addressed to AGC by agc01@agccert.com.

Simultaneous Multi-band Transmission Evaluation:

This device have only one antenna,don't contain multiple transmitters that operate simultaneously, and therefore simultaneous transmission analysis are not requires.

Value of the SAR for WIFI & BT:

Test position		Max 1g-SAR (W/kg)			
		BT	WLAN 2.4G	WLAN 5.2G	WLAN 5.8G
Body	Body_Front	<0.01	<0.01	<0.01	<0.01
	Body_Back	<0.01	<0.01	<0.01	<0.01
	Edge Left	0.036	0.073	0.240	0.245
	Edge Right	<0.01	<0.01	<0.01	<0.01
	Edge Top	0.185	0.445	0.785	0.789
	Edge Bottom	<0.01	<0.01	<0.01	<0.01
Limit		1.6 W/kg			

NOTE:

1. WIFI and BT share the same antenna, and cannot transmit simultaneously.

Any report having not been signed by authorized approver, or having been altered without authorization, or having not been stamped by the "Dedicated Testing/Inspection Stamp" is deemed to be invalid. Copying or excerpting portion of, or altering the content of the report is not permitted without the written authorization of AGC. The test results presented in the report apply only to the tested sample. Any objections to report issued by AGC should be submitted to AGC within 15days after the issuance of the test report. Further enquiry of validity or verification of the test report should be addressed to AGC by agc01@agccert.com.

APPENDIX A. SAR SYSTEM CHECK DATA

Test Laboratory: AGC Lab

Date: Aug. 14, 2024

System Check Head 2450 MHz

DUT: Dipole 2450 MHz Type: SID 2450

Communication System CW; Communication System Band: D2450 (2450.0 MHz); Duty Cycle: 1:1; Conv.F=2.16
Frequency: 2450 MHz; Medium parameters used: $f = 2450$ MHz; $\sigma = 1.89$ mho/m; $\epsilon_r = 39.40$; $\rho = 1000$ kg/m³ ;
Phantom section: Flat Section; Input Power=18dBm

Ambient temperature (°C):22.9, Liquid temperature (°C): 22.6

SATIMO Configuration

- Probe: SSE2; Calibrated: Apr 30, 2024; Serial No.: 2023-EPGO-414
- Sensor-Surface: 4mm (Mechanical Surface Detection)
- Phantom: SAM twin phantom
- Measurement SW: OpenSAR V4_02_35

Configuration/System Check 2450MHz Head/Area Scan: Measurement grid: dx=8mm, dy=8mm

Configuration/System Check 2450MHz Head/Zoom Scan: Measurement grid: dx=5mm,dy=5mm, dz=5mm

Area Scan	dx=8mm dy=8mm, h= 5.00 mm
ZoomScan	7x7x7,dx=5mm dy=5mm dz=5mm
Phantom	SAM twin phantom
Device Position	Flat
Band	CW 2450
Channels	Middle
Signal	Crest factor: 1.0

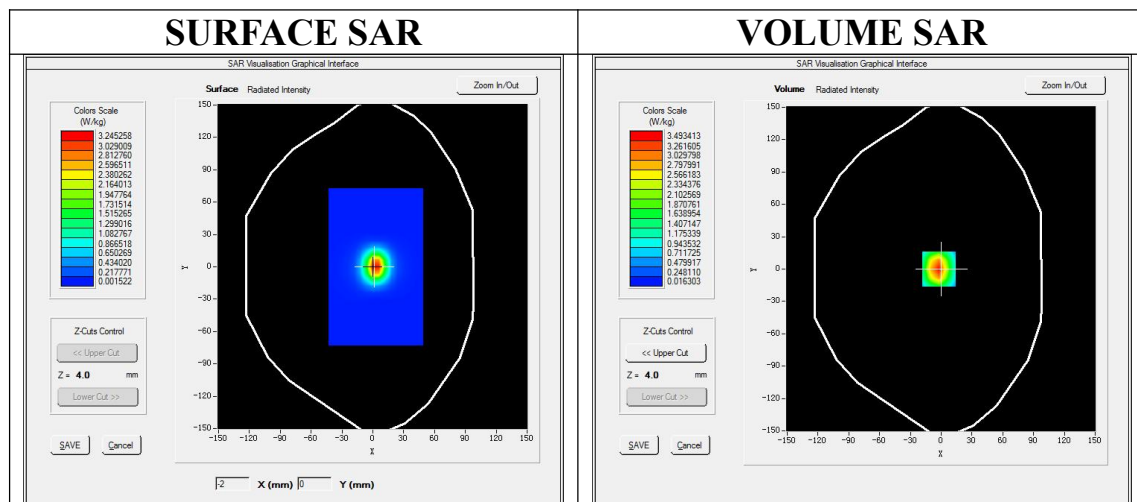

Maximum location: X=1.00, Y=0.00

SAR Peak: 6.01 W/kg

SAR 10g (W/Kg)	1.503381
SAR 1g (W/Kg)	3.370214

Any report having not been signed by authorized approver, or having been altered without authorization, or having not been stamped by the "Dedicated Testing/Inspection Stamp" is deemed to be invalid. Copying or excerpting portion of, or altering the content of the report is not permitted without the written authorization of AGC. The test results presented in the report apply only to the tested sample. Any objections to report issued by AGC should be submitted to AGC within 15days after the issuance of the test report. Further enquiry of validity or verification of the test report should be addressed to AGC by agc01@agccert.com.

Attestation of Global Compliance(Shenzhen)Co., Ltd

Attestation of Global Compliance(Shenzhen)Std & Tech Co., Ltd

Tel: +86-755 2523 4088 E-mail: agc@agccert.com Web: http://www.agccert.com/

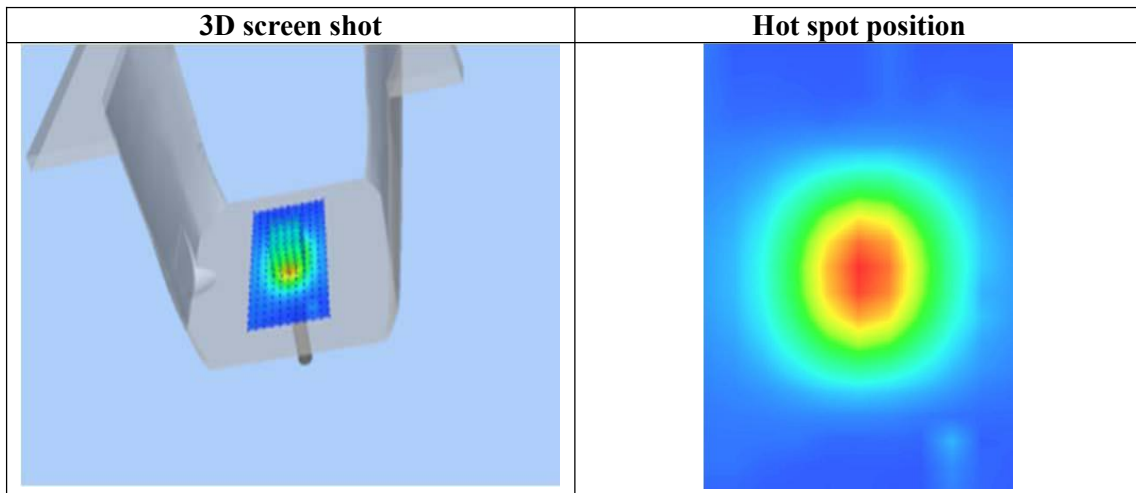
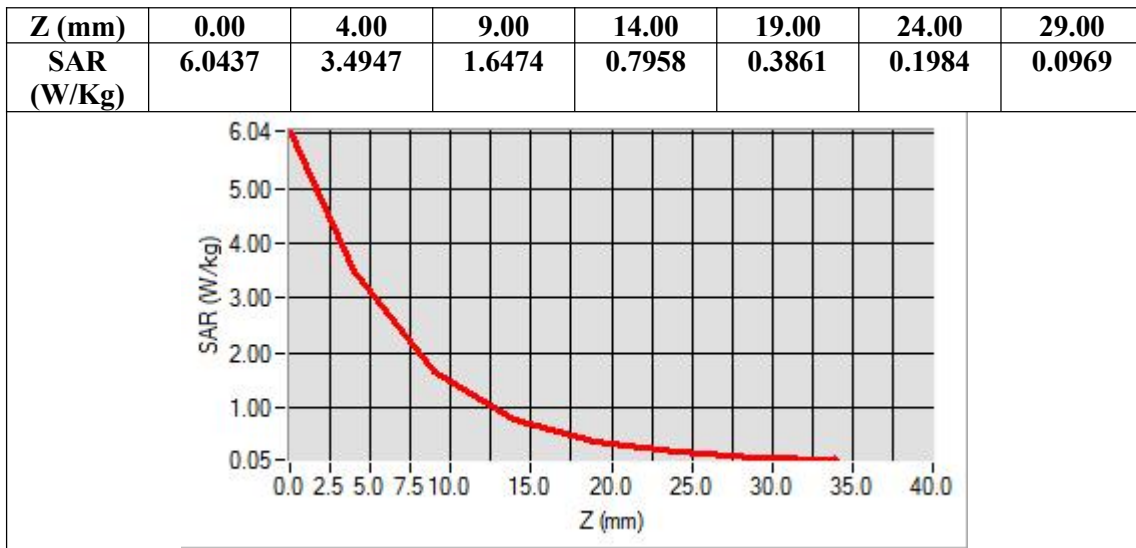

Any report having not been signed by authorized approver, or having been altered without authorization, or having not been stamped by the "Dedicated Testing/Inspection Stamp" is deemed to be invalid. Copying or excerpting portion of, or altering the content of the report is not permitted without the written authorization of AGC. The test results presented in the report apply only to the tested sample. Any objections to report issued by AGC should be submitted to AGC within 15days after the issuance of the test report. Further enquiry of validity or verification of the test report should be addressed to AGC by agc01@agccert.com.

Test Laboratory: AGC Lab
System Check 5200 MHz

Date: Aug. 15, 2024

DUT: Dipole 5000MHz Type: SID5000

Communication System: CW; Communication System Band: D5000 (5000.0 MHz); Duty Cycle: 1:1; Conv.F=1.53
Frequency: 5200 MHz; Medium parameters used: $f = 5200$ MHz; $\sigma = 4.60$ mho/m; $\epsilon_r = 35.53$; $\rho = 1000$ kg/m³ ;
Phantom section: Flat Section; Input Power=18dBm
Ambient temperature (°C): 22.8, Liquid temperature (°C): 22.3

SATIMO Configuration:

- Probe: SSE2; Calibrated: Apr 30, 2024; Serial No.: 2023-EPGO-414
- Sensor-Surface: 4mm (Mechanical Surface Detection)
- Phantom: SAM twin phantom
- Measurement SW: OpenSAR V4_02_35

Configuration/System Check 5200 MHz Body/Area Scan: Measurement grid: dx=8mm, dy=8mm

Configuration/System Check 5200 MHz Body/Zoom Scan: Measurement grid: dx=4mm,dy=4mm, dz=2mm

Area Scan	dx=8mm dy=8mm, h= 5.00 mm
ZoomScan	7x7x12,dx=4mm dy=4mm dz=2mm
Phantom	SAM twin phantom
Device Position	Flat
Band	CW 5200
Channels	Middle
Signal	Crest factor: 1.0

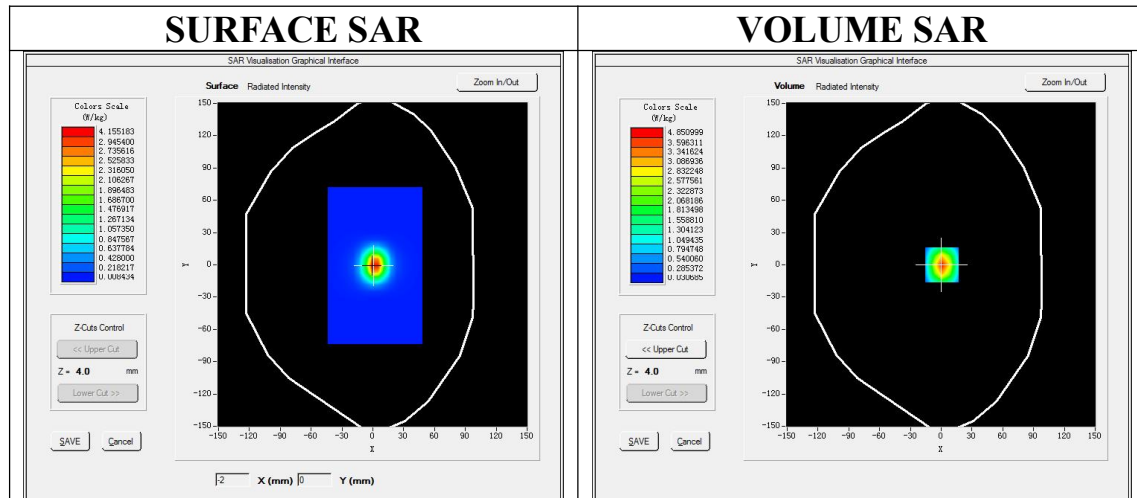

Maximum location: X=1.00, Y=0.00

SAR Peak: 6.86 W/kg

SAR 10g (W/Kg)	1.339091
SAR 1g (W/Kg)	4.613129

Any report having not been signed by authorized approver, or having been altered without authorization, or having not been stamped by the "Dedicated Testing/Inspection Stamp" is deemed to be invalid. Copying or excerpting portion of, or altering the content of the report is not permitted without the written authorization of AGC. The test results presented in the report apply only to the tested sample. Any objections to report issued by AGC should be submitted to AGC within 15days after the issuance of the test report. Further enquiry of validity or verification of the test report should be addressed to AGC by agc01@agccert.com.

Attestation of Global Compliance(Shenzhen)Co., Ltd

Attestation of Global Compliance(Shenzhen)Std & Tech Co., Ltd

Tel: +86-755 2523 4088 E-mail: agc@agccert.com Web: http://www.agccert.com/

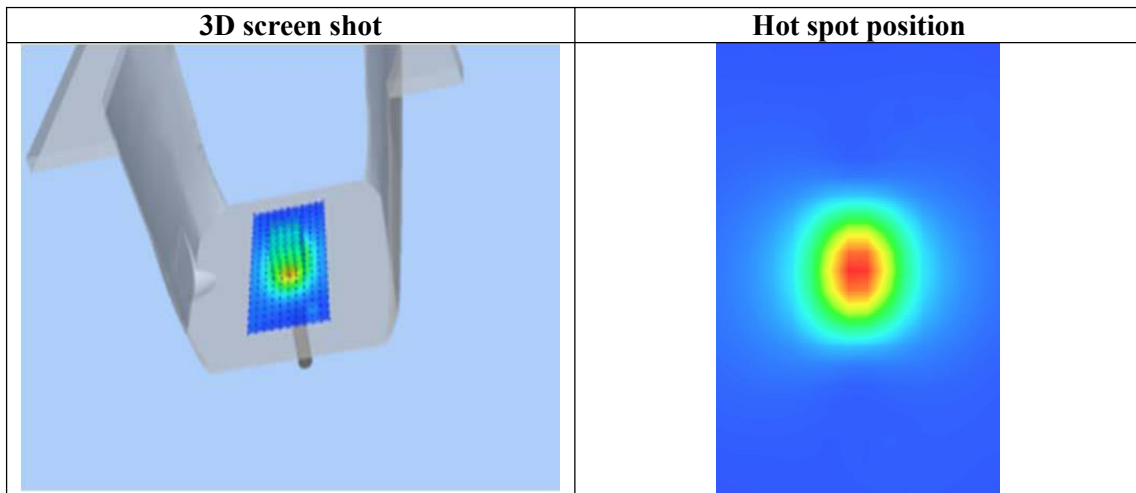
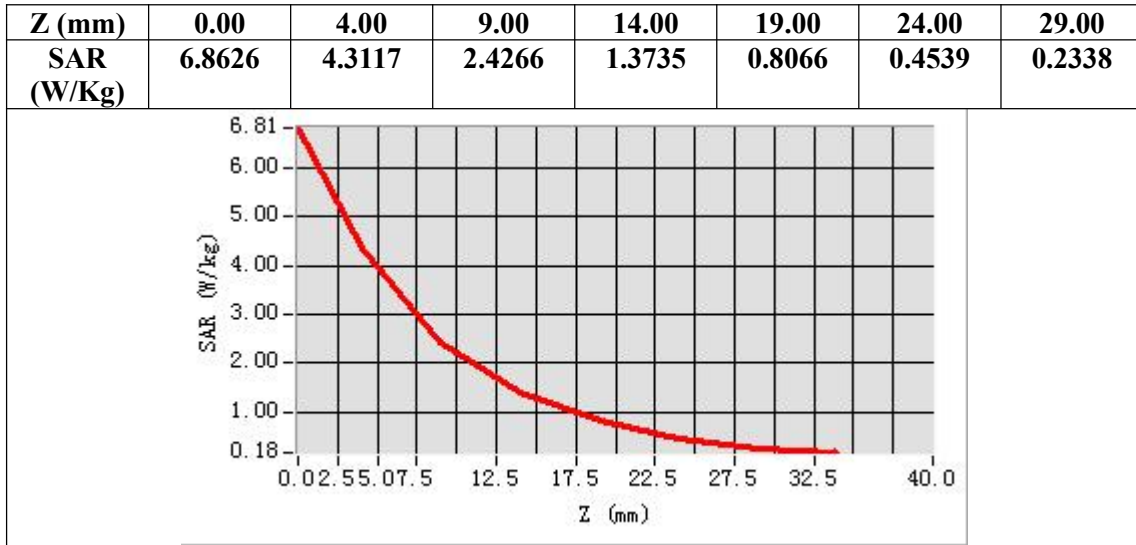

Any report having not been signed by authorized approver, or having been altered without authorization, or having not been stamped by the "Dedicated Testing/Inspection Stamp" is deemed to be invalid. Copying or excerpting portion of, or altering the content of the report is not permitted without the written authorization of AGC. The test results presented in the report apply only to the tested sample. Any objections to report issued by AGC should be submitted to AGC within 15days after the issuance of the test report. Further enquiry of validity or verification of the test report should be addressed to AGC by agc01@agccert.com.

Test Laboratory: AGC Lab
System Check Head 5800 MHz
DUT: Dipole 5000MHz Type: SID5000

Date: Aug. 15, 2024

Communication System: CW; Communication System Band: D5000 (5000.0 MHz); Duty Cycle: 1:1; Conv.F=1.37
Frequency: 5800 MHz; Medium parameters used: $f = 5800$ MHz; $\sigma = 5.20$ mho/m; $\epsilon_r = 34.85$; $\rho = 1000$ kg/m³ ;
Phantom section: Flat Section; Input Power=18dBm
Ambient temperature (°C): 22.8, Liquid temperature (°C): 22.3

SATIMO Configuration:

- Probe: SSE2; Calibrated: Apr 30, 2024; Serial No.: 2023-EPGO-414
- Sensor-Surface: 4mm (Mechanical Surface Detection)
- Phantom: SAM twin phantom
- Measurement SW: OpenSAR V4_02_35

Configuration/System Check 5800 MHz Head/Area Scan: Measurement grid: dx=8mm, dy=8mm

Configuration/System Check 5800 MHz Head/Zoom Scan: Measurement grid: dx=4mm,dy=4mm, dz=2mm

Area Scan	dx=8mm dy=8mm, h= 5.00 mm
ZoomScan	7x7x12,dx=4mm dy=4mm dz=2mm
Phantom	SAM twin phantom
Device Position	Flat
Band	CW 5800
Channels	Middle
Signal	Crest factor: 1.0

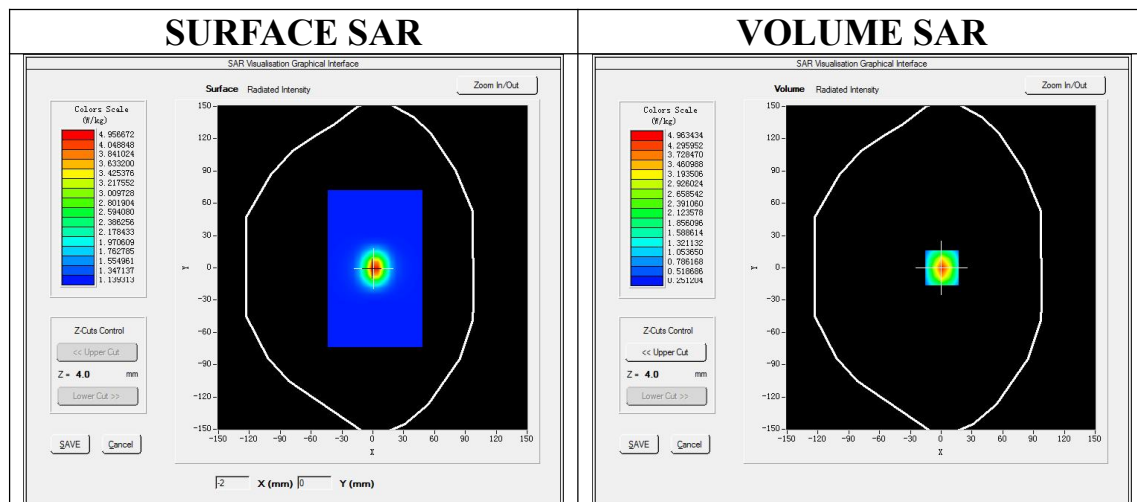

Maximum location: X=1.00, Y=0.00

SAR Peak: 6.93 W/kg

SAR 10g (W/Kg)	1.402733
SAR 1g (W/Kg)	4.735211

Any report having not been signed by authorized approver, or having been altered without authorization, or having not been stamped by the "Dedicated Testing/Inspection Stamp" is deemed to be invalid. Copying or excerpting portion of, or altering the content of the report is not permitted without the written authorization of AGC. The test results presented in the report apply only to the tested sample. Any objections to report issued by AGC should be submitted to AGC within 15days after the issuance of the test report. Further enquiry of validity or verification of the test report should be addressed to AGC by agc01@agccert.com.

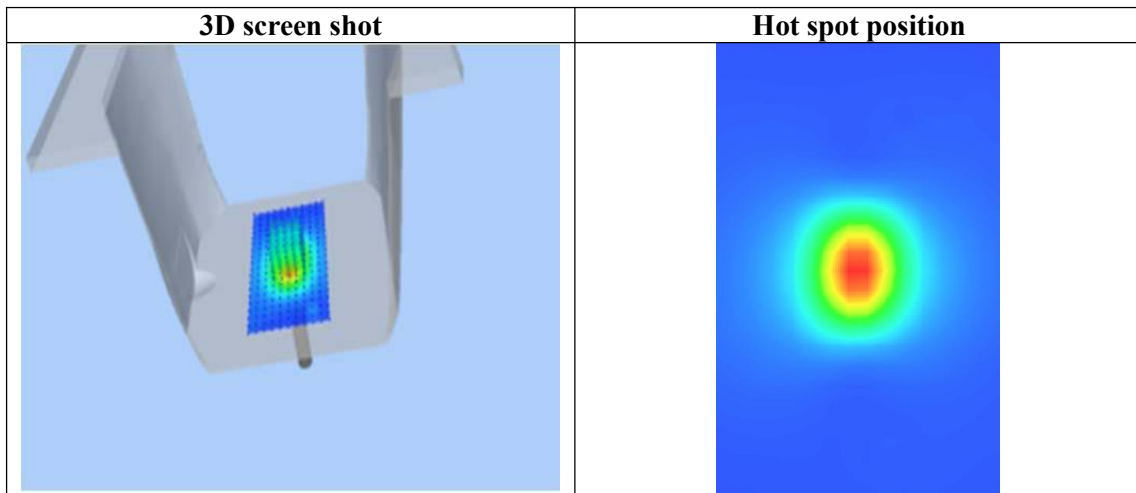
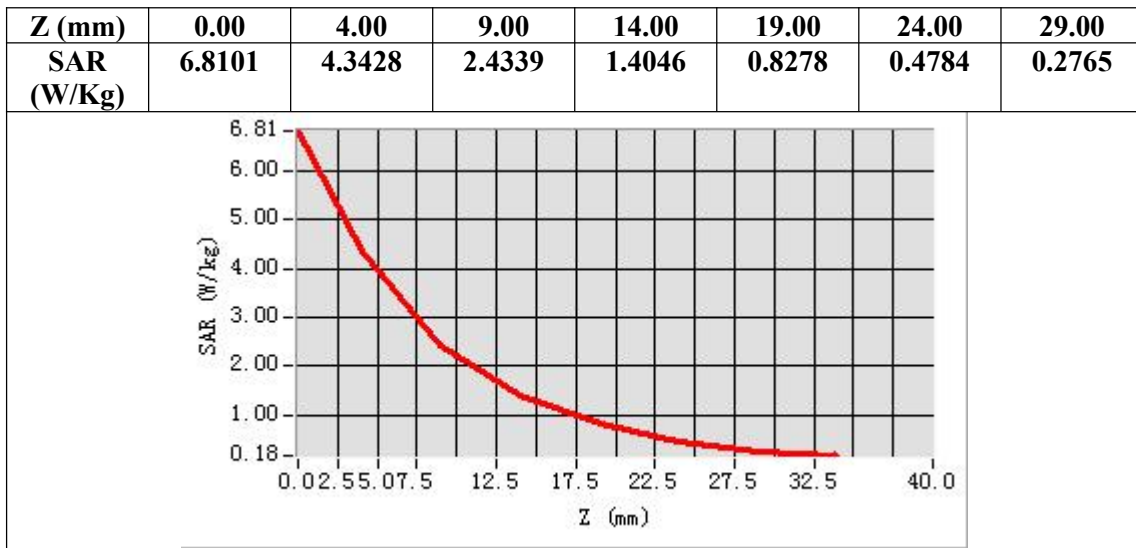

Any report having not been signed by authorized approver, or having been altered without authorization, or having not been stamped by the “Dedicated Testing/Inspection Stamp” is deemed to be invalid. Copying or excerpting portion of, or altering the content of the report is not permitted without the written authorization of AGC. The test results presented in the report apply only to the tested sample. Any objections to report issued by AGC should be submitted to AGC within 15days after the issuance of the test report. Further enquiry of validity or verification of the test report should be addressed to AGC by agc01@agccert.com.

APPENDIX B. SAR MEASUREMENT DATA

Test Laboratory: AGC Lab
802.11n20 High- Edge- Top
DUT: Camera ; Type: CINSBBGA

Date: Aug. 14, 2024

Communication System: Wi-Fi; Communication System Band: 802.11n20; Duty Cycle: 1:1; Conv.F=2.16;
Frequency: 2462 MHz; Medium parameters used: $f = 2450$ MHz; $\sigma = 1.90$ mho/m; $\epsilon_r = 39.34$; $\rho = 1000$ kg/m³ ;
Phantom section: Flat Section
Ambient temperature (°C):22.9, Liquid temperature (°C): 22.6

SATIMO Configuration:

- Probe: SSE2; Calibrated: Apr 30, 2024; Serial No.: 2023-EPGO-414
- Sensor-Surface: 4mm (Mechanical Surface Detection)
- Phantom: SAM twin phantom
- Measurement SW: OpenSAR V4_02_35

Configuration/802.11n20 High- Edge- Top /Area Scan: Measurement grid: dx=8mm, dy=8mm
Configuration/802.11n20 High- Edge- Top /Zoom Scan: Measurement grid: dx=5mm,dy=5mm, dz=5mm;

Area Scan	dx=8mm dy=8mm, h= 5.00 mm
ZoomScan	7x7x7,dx=5mm dy=5mm dz=5mm
Phantom	SAM twin phantom
Device Position	Edge- Top
Band	2450MHz
Channels	High
Signal	Crest factor: 1.0

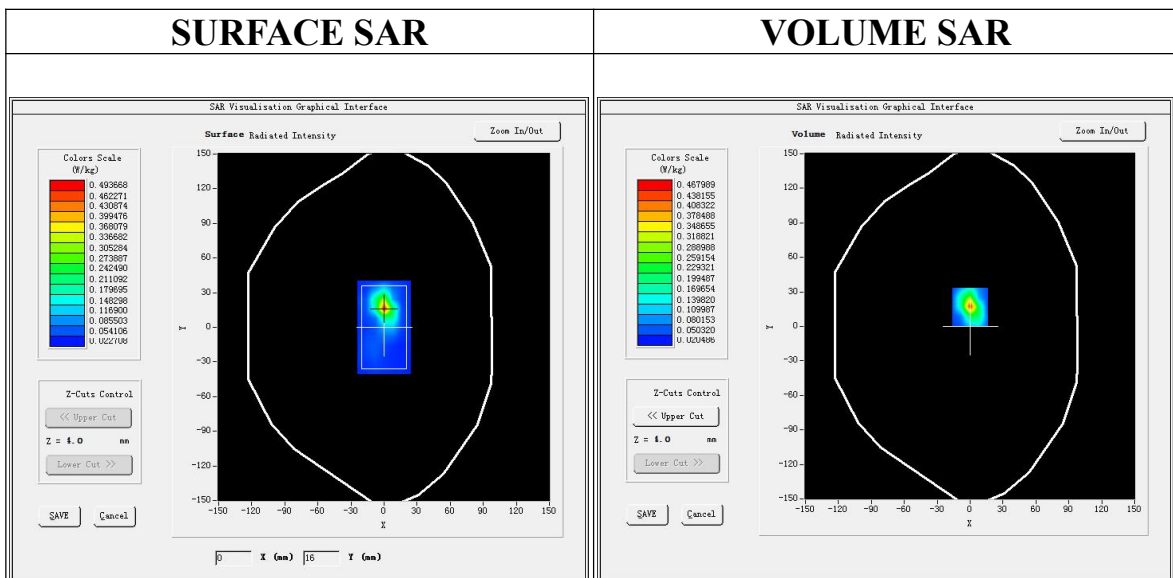

Maximum location: X=0.00, Y=16.00
SAR Peak: 0.863 W/kg

Any report having not been signed by authorized approver, or having been altered without authorization, or having not been stamped by the “Dedicated Testing/Inspection Stamp” is deemed to be invalid. Copying or excerpting portion of, or altering the content of the report is not permitted without the written authorization of AGC. The test results presented in the report apply only to the tested sample. Any objections to report issued by AGC should be submitted to AGC within 15days after the issuance of the test report. Further enquiry of validity or verification of the test report should be addressed to AGC by agc01@agccert.com.

SAR 10g (W/Kg)	0.140125
SAR 1g (W/Kg)	0.392604

Z (mm)	0.00	4.00	9.00	14.00	19.00	24.00	29.00
SAR (W/Kg)	0.8713	0.4679	0.1959	0.0991	0.0549	0.0393	0.0329

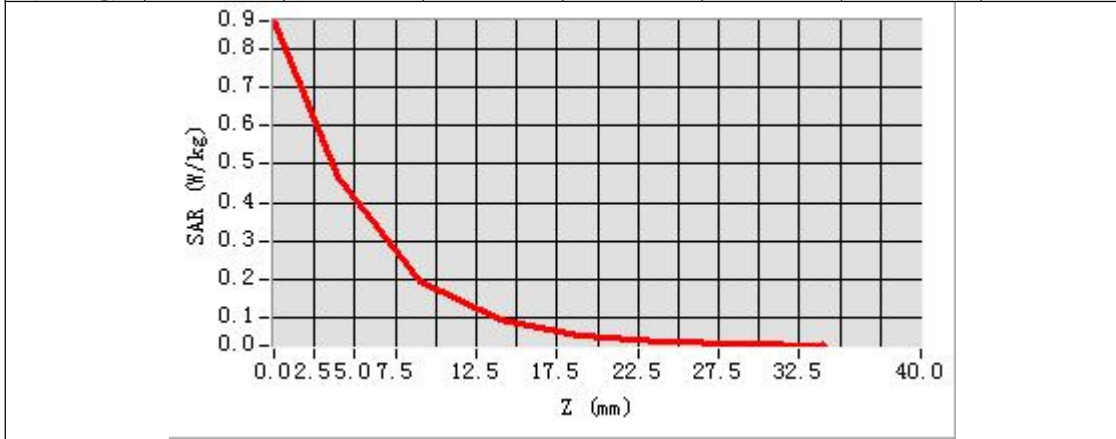

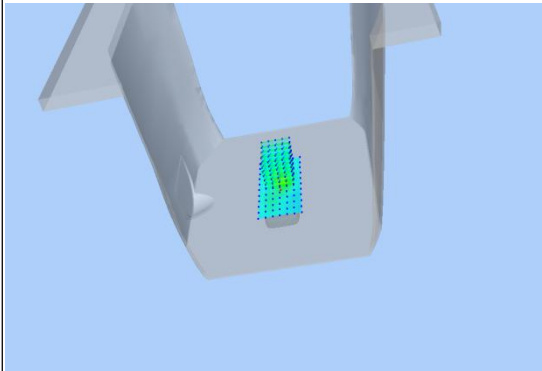
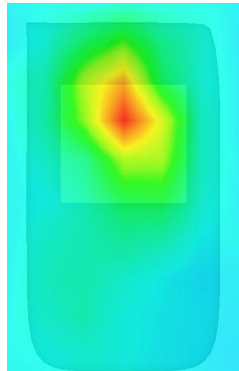
3D screen shot	Hot spot position
	

Any report having not been signed by authorized approver, or having been altered without authorization, or having not been stamped by the “Dedicated Testing/Inspection Stamp” is deemed to be invalid. Copying or excerpting portion of, or altering the content of the report is not permitted without the written authorization of AGC. The test results presented in the report apply only to the tested sample. Any objections to report issued by AGC should be submitted to AGC within 15days after the issuance of the test report. Further enquiry of validity or verification of the test report should be addressed to AGC by agc01@agccert.com.

Test Laboratory: AGC Lab
BT Mid- Edge- Top
DUT: Camera ; Type: CINSBBGA

Date: Aug. 14, 2024

Communication System: BT; Communication System Band: 3DH5; Duty Cycle: 1:1; Conv.F=2.16;
Frequency: 2441 MHz; Medium parameters used: $f = 2450$ MHz; $\sigma = 1.85$ mho/m; $\epsilon_r = 39.42$; $\rho = 1000$ kg/m³ ;
Phantom section: Flat Section
Ambient temperature (°C):22.9, Liquid temperature (°C): 22.6

SATIMO Configuration:

- Probe: SSE2; Calibrated: Apr 30, 2024; Serial No.: 2023-EPGO-414
- Sensor-Surface: 4mm (Mechanical Surface Detection)
- Phantom: SAM twin phantom
- Measurement SW: OpenSAR V4_02_35

Configuration/BT Mid- Edge- Top/Area Scan: Measurement grid: dx=8mm, dy=8mm
Configuration/BT Mid- Edge- Top/Zoom Scan: Measurement grid: dx=5mm,dy=5mm, dz=5mm;

Area Scan	dx=8mm dy=8mm, h= 5.00 mm
ZoomScan	7x7x7,dx=5mm dy=5mm dz=5mm
Phantom	SAM twin phantom
Device Position	Edge- Top
Band	2450MHz
Channels	Middle
Signal	Crest factor: 1.0

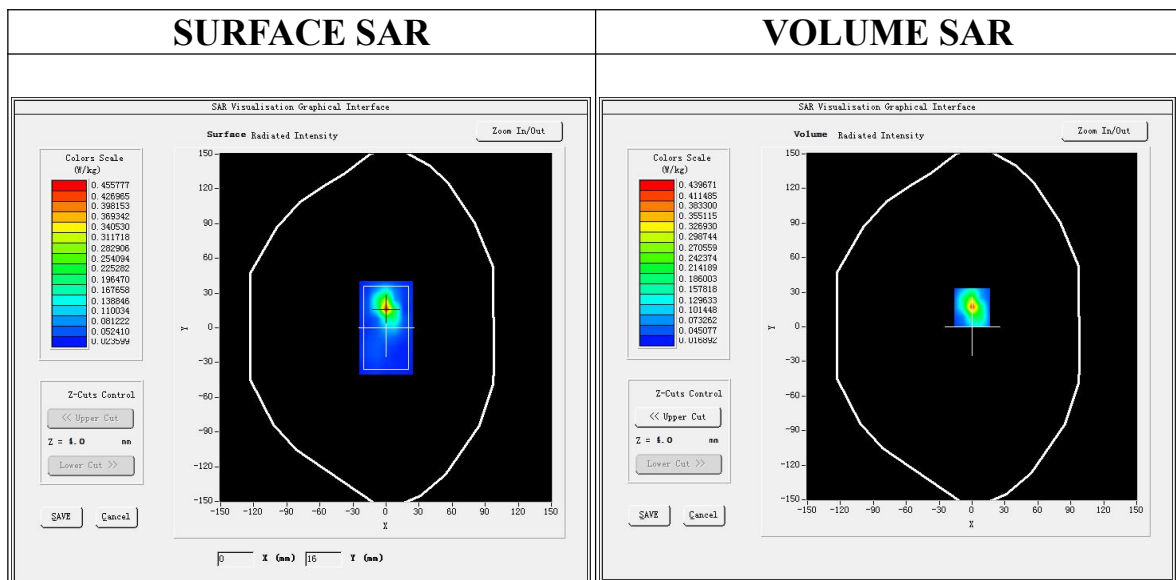

Maximum location: X=0.00, Y=16.00
SAR Peak: 0.818 W/kg

Any report having not been signed by authorized approver, or having been altered without authorization, or having not been stamped by the “Dedicated Testing/Inspection Stamp” is deemed to be invalid. Copying or excerpting portion of, or altering the content of the report is not permitted without the written authorization of AGC. The test results presented in the report apply only to the tested sample. Any objections to report issued by AGC should be submitted to AGC within 15days after the issuance of the test report. Further enquiry of validity or verification of the test report should be addressed to AGC by agc01@agccert.com.

SAR 10g (W/Kg)	0.092075
SAR 1g (W/Kg)	0.170589

Z (mm)	0.00	4.00	9.00	14.00	19.00	24.00	29.00
SAR (W/Kg)	0.8279	0.4396	0.1811	0.0950	0.0529	0.0351	0.0297

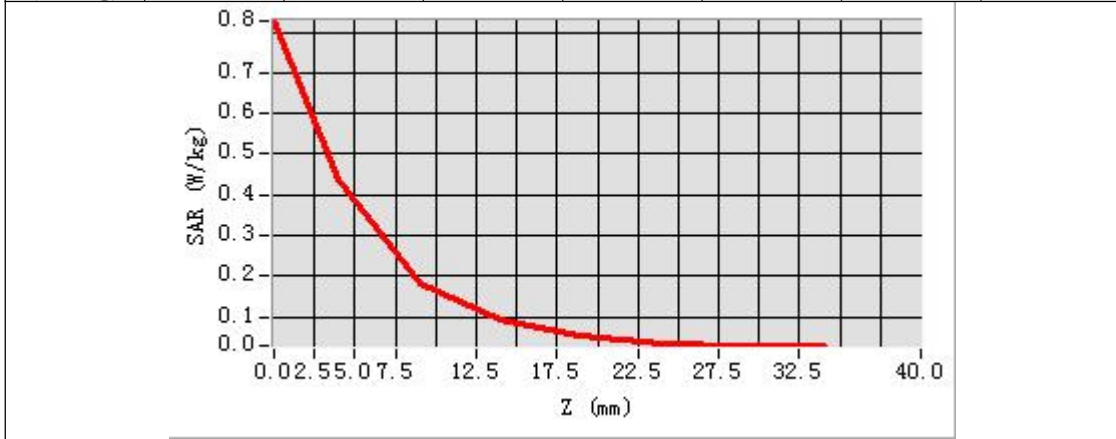

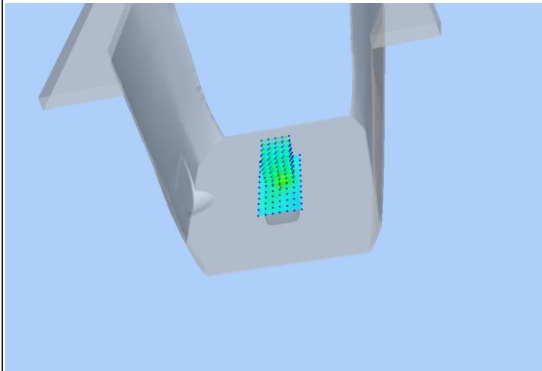
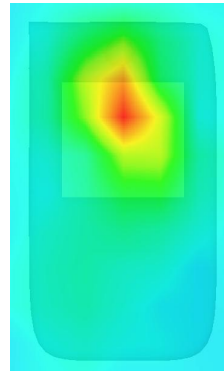
3D screen shot	Hot spot position
	

Any report having not been signed by authorized approver, or having been altered without authorization, or having not been stamped by the “Dedicated Testing/Inspection Stamp” is deemed to be invalid. Copying or excerpting portion of, or altering the content of the report is not permitted without the written authorization of AGC. The test results presented in the report apply only to the tested sample. Any objections to report issued by AGC should be submitted to AGC within 15days after the issuance of the test report. Further enquiry of validity or verification of the test report should be addressed to AGC by agc01@agccert.com.

Test Laboratory: AGC Lab
802.11a High- Edge- Top
DUT: Camera ; Type: CINSBBGA

Date: Aug. 15, 2024

Communication System: Wi-Fi; Communication System Band: 802.11a; Duty Cycle: 1:1; Conv.F=1.53;
Frequency: 5240 MHz; Medium parameters used: $f = 5200$ MHz; $\sigma = 4.69$ mho/m; $\epsilon_r = 35.46$; $\rho = 1000$ kg/m³ ;
Phantom section: Flat Section
Ambient temperature (°C):22.8, Liquid temperature (°C): 22.3

SATIMO Configuration:

- Probe: SSE2; Calibrated: Apr 30, 2024; Serial No.: 2023-EPGO-414
- Sensor-Surface: 4mm (Mechanical Surface Detection)
- Phantom: SAM twin phantom
- Measurement SW: OpenSAR V4_02_35

Configuration/802.11a High- Edge- Top/Area Scan: Measurement grid: dx=8mm, dy=8mm
Configuration/802.11a High- Edge- Top/Zoom Scan: Measurement grid: dx=4mm,dy=4mm, dz=2mm;

Area Scan	dx=8mm dy=8mm, h= 5.00 mm
ZoomScan	7x7x12,dx=4mm dy=4mm dz=2mm
Phantom	SAM twin phantom
Device Position	Edge- Top
Band	5200MHz
Channels	High
Signal	Crest factor: 1.0

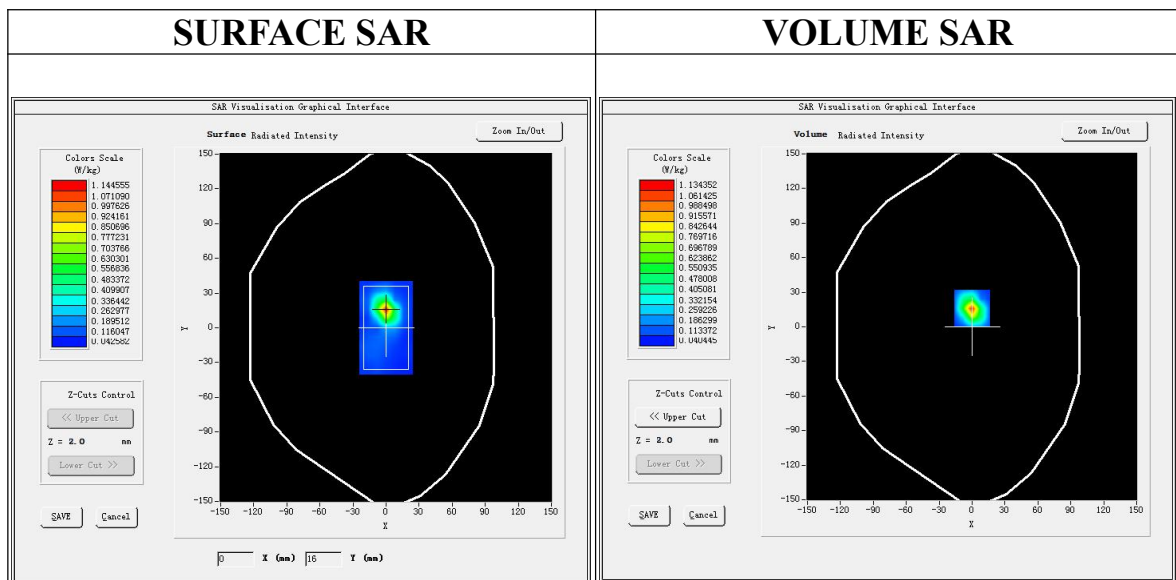

Maximum location: X=0.00, Y=16.00
SAR Peak: 1.463 W/kg

Any report having not been signed by authorized approver, or having been altered without authorization, or having not been stamped by the “Dedicated Testing/Inspection Stamp” is deemed to be invalid. Copying or excerpting portion of, or altering the content of the report is not permitted without the written authorization of AGC. The test results presented in the report apply only to the tested sample. Any objections to report issued by AGC should be submitted to AGC within 15days after the issuance of the test report. Further enquiry of validity or verification of the test report should be addressed to AGC by agc01@agccert.com.

SAR 10g (W/Kg)	0.323423
SAR 1g (W/Kg)	0.736499

Z (mm)	0.00	4.00	9.00	14.00	19.00	24.00	29.00
SAR (W/Kg)	1.4357	1.1343	0.6258	0.3593	0.2314	0.1465	0.1119

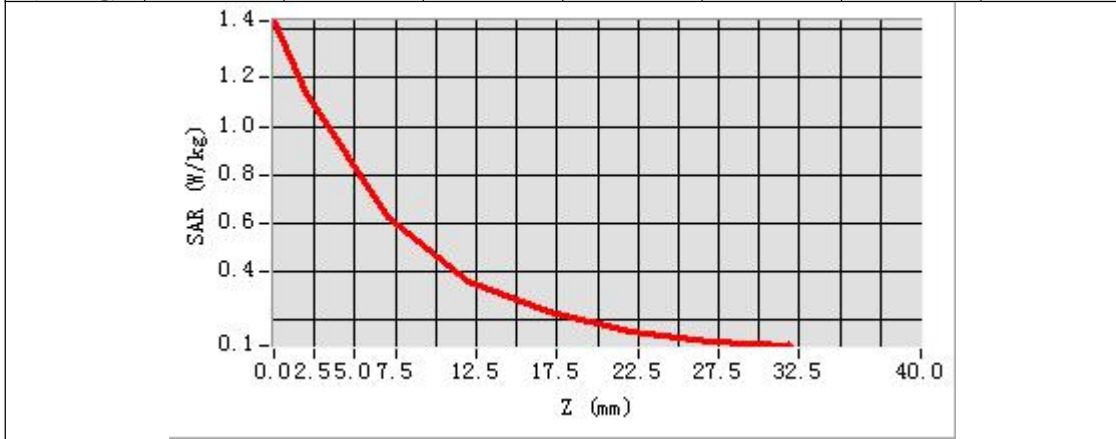

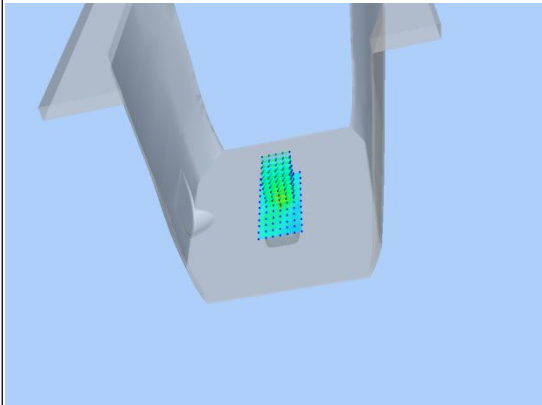
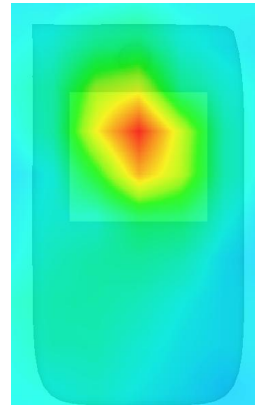
3D screen shot	Hot spot position
	

Any report having not been signed by authorized approver, or having been altered without authorization, or having not been stamped by the “Dedicated Testing/Inspection Stamp” is deemed to be invalid. Copying or excerpting portion of, or altering the content of the report is not permitted without the written authorization of AGC. The test results presented in the report apply only to the tested sample. Any objections to report issued by AGC should be submitted to AGC within 15days after the issuance of the test report. Further enquiry of validity or verification of the test report should be addressed to AGC by agc01@agccert.com.

Test Laboratory: AGC Lab
802.11a Low- Edge- Top
DUT: Camera ; Type: CINSBBGA

Date: Aug. 15, 2024

Communication System: Wi-Fi; Communication System Band: 802.11a; Duty Cycle: 1:1; Conv.F=1.37;
Frequency: 5745 MHz; Medium parameters used: $f = 5800$ MHz; $\sigma = 5.13$ mho/m; $\epsilon_r = 35.05$; $\rho = 1000$ kg/m³ ;
Phantom section: Flat Section
Ambient temperature (°C):22.8, Liquid temperature (°C): 22.3

SATIMO Configuration:

- Probe: SSE2; Calibrated: Apr 30, 2024; Serial No.: 2023-EPGO-414
- Sensor-Surface: 4mm (Mechanical Surface Detection)
- Phantom: SAM twin phantom
- Measurement SW: OpenSAR V4_02_35

Configuration/802.11a Low- Edge- Top/Area Scan: Measurement grid: dx=8mm, dy=8mm
Configuration/802.11a Low- Edge- Top/Zoom Scan: Measurement grid: dx=4mm,dy=4mm, dz=2mm;

Area Scan	dx=8mm dy=8mm, h= 5.00 mm
ZoomScan	7x7x12,dx=4mm dy=4mm dz=2mm
Phantom	SAM twin phantom
Device Position	Edge- Top
Band	5800MHz
Channels	Low
Signal	Crest factor: 1.0

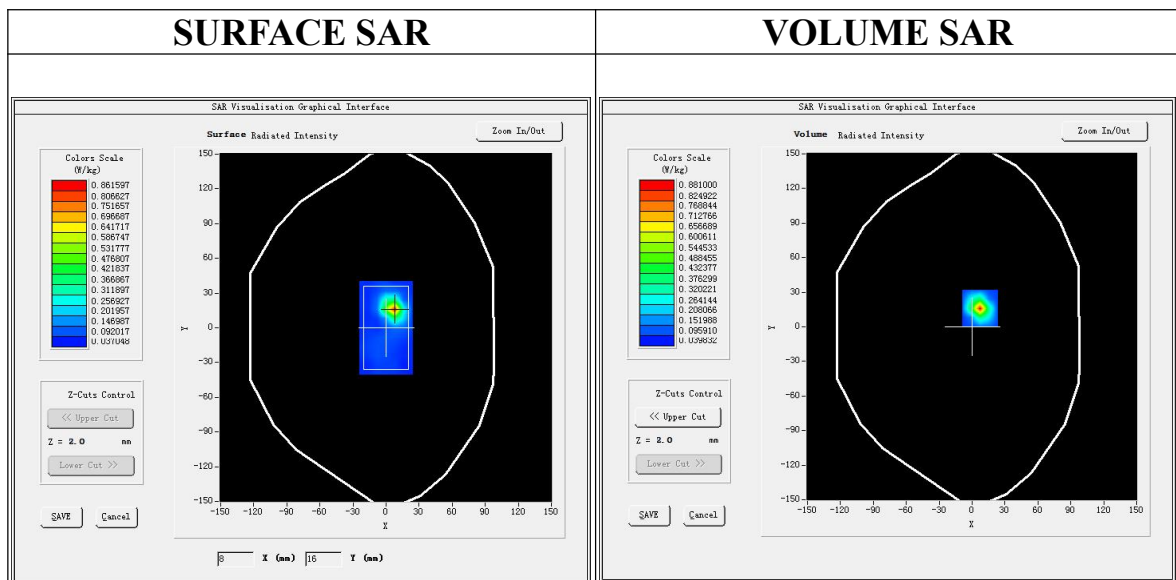

Maximum location: X=0.00, Y=16.00
SAR Peak: 1.139 W/kg

Any report having not been signed by authorized approver, or having been altered without authorization, or having not been stamped by the “Dedicated Testing/Inspection Stamp” is deemed to be invalid. Copying or excerpting portion of, or altering the content of the report is not permitted without the written authorization of AGC. The test results presented in the report apply only to the tested sample. Any objections to report issued by AGC should be submitted to AGC within 15days after the issuance of the test report. Further enquiry of validity or verification of the test report should be addressed to AGC by agc01@agccert.com.

SAR 10g (W/Kg)	0.216917
SAR 1g (W/Kg)	0.595823

Z (mm)	0.00	4.00	9.00	14.00	19.00	24.00	29.00
SAR (W/Kg)	1.1292	0.8810	0.4608	0.2502	0.1502	0.1072	0.0871

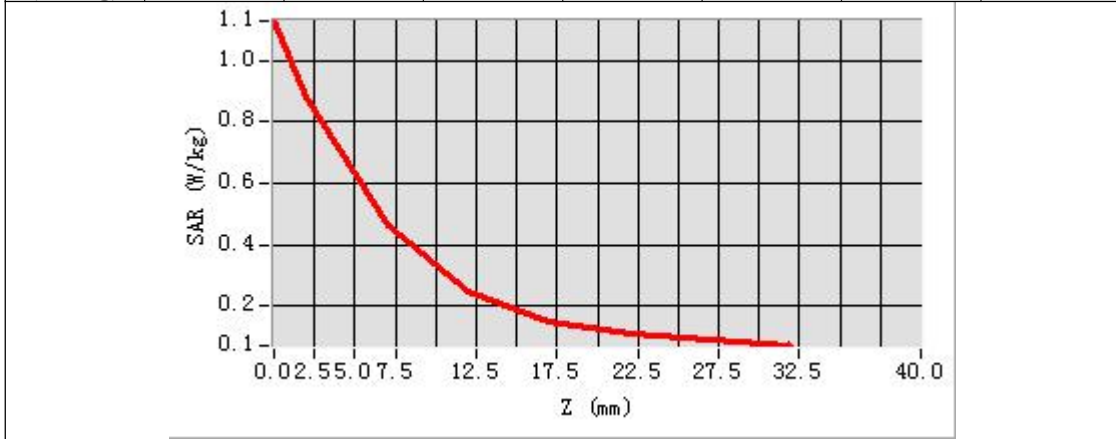

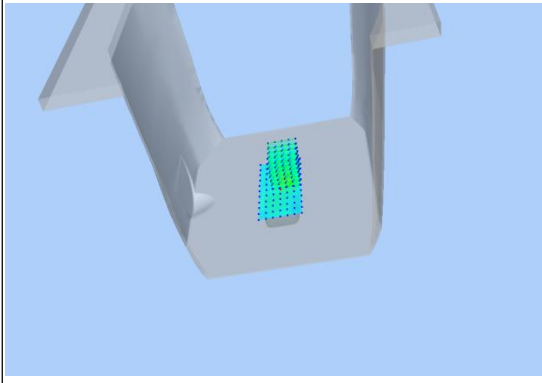
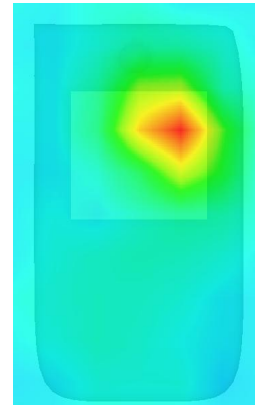
3D screen shot	Hot spot position
	

Any report having not been signed by authorized approver, or having been altered without authorization, or having not been stamped by the "Dedicated Testing/Inspection Stamp" is deemed to be invalid. Copying or excerpting portion of, or altering the content of the report is not permitted without the written authorization of AGC. The test results presented in the report apply only to the tested sample. Any objections to report issued by AGC should be submitted to AGC within 15days after the issuance of the test report. Further enquiry of validity or verification of the test report should be addressed to AGC by agc01@agccert.com.

APPENDIX C. TEST SETUP PHOTOGRAPHS

Refer to the Report No.: AGC14075240803AP01

DEPTH OF THE LIQUID IN THE PHANTOM—ZOOM IN

Note : The position used in the measurement were according to IEEE 1528-2013



Any report having not been signed by authorized approver, or having been altered without authorization, or having not been stamped by the “Dedicated Testing/Inspection Stamp” is deemed to be invalid. Copying or excerpting portion of, or altering the content of the report is not permitted without the written authorization of AGC. The test results presented in the report apply only to the tested sample. Any objections to report issued by AGC should be submitted to AGC within 15days after the issuance of the test report. Further enquiry of validity or verification of the test report should be addressed to AGC by agc01@agccert.com.

APPENDIX D. CALIBRATION DATA

Refer to Attached files.

----END OF REPORT----

Any report having not been signed by authorized approver, or having been altered without authorization, or having not been stamped by the “Dedicated Testing/Inspection Stamp” is deemed to be invalid. Copying or excerpting portion of, or altering the content of the report is not permitted without the written authorization of AGC. The test results presented in the report apply only to the tested sample. Any objections to report issued by AGC should be submitted to AGC within 15days after the issuance of the test report. Further enquiry of validity or verification of the test report should be addressed to AGC by agc01@agccert.com.

Attestation of Global Compliance(Shenzhen)Co., Ltd
Attestation of Global Compliance(Shenzhen)Std & Tech Co., Ltd
Tel: +86-755 2523 4088 E-mail: agc@agccert.com Web: <http://www.agccert.com/>



Conditions of Issuance of Test Reports

1. All samples and goods are accepted by the Attestation of Global Compliance (Shenzhen) Co., Ltd (the “Company”) solely for testing and reporting in accordance with the following terms and conditions. The company provides its services on the basis that such terms and conditions constitute express agreement between the company and any person, firm or company requesting its services (the “Clients”).
2. Any report issued by Company as a result of this application for testing services (the “Report”) shall be issued in confidence to the Clients and the Report will be strictly treated as such by the Company. It may not be reproduced either in its entirety or in part and it may not be used for advertising or other unauthorized purposes without the written consent of the Company. The Clients to whom the Report is issued may, however, show or send it, or a certified copy thereof prepared by the Company to its customer, supplier or other persons directly concerned. The Company will not, without the consent of the Clients, enter into any discussion or correspondence with any third party concerning the contents of the Report, unless required by the relevant governmental authorities, laws or court orders.
3. The Company shall not be called or be liable to be called to give evidence or testimony on the Report in a court of law without its prior written consent, unless required by the relevant governmental authorities, laws or court orders.
4. In the event of the improper use of the report as determined by the Company, the Company reserves the right to withdraw it, and to adopt any other additional remedies which may be appropriate.
5. Samples submitted for testing are accepted on the understanding that the Report issued cannot form the basis of, or be the instrument for, any legal action against the Company.
6. The Company will not be liable for or accept responsibility for any loss or damage however arising from the use of information contained in any of its Reports or in any communication whatsoever about its said tests or investigations.
7. Clients wishing to use the Report in court proceedings or arbitration shall inform the Company to that effect prior to submitting the sample for testing.
8. The Company is not responsible for recalling the electronic version of the original report when any revision is made to them. The Client assumes the responsibility to providing the revised version to any interested party who uses them.
9. Subject to the variable length of retention time for test data and report stored hereinto as otherwise specifically required by individual accreditation authorities, the Company will only keep the supporting test data and information of the test report for a period of six years. The data and information will be disposed of after the aforementioned retention period has elapsed. Under no circumstances shall we provide any data and information which has been disposed of after retention period. Under no circumstances shall we be liable for damage of any kind, including (but not limited to) compensatory damages, lost profits, lost data, or any form of special, incidental, indirect, consequential or punitive damages of any kind, whether based on breach of contract of warranty, tort (including negligence), product liability or otherwise, even if we are informed in advance of the possibility of such damages.

Any report having not been signed by authorized approver, or having been altered without authorization, or having not been stamped by the “Dedicated Testing/Inspection Stamp” is deemed to be invalid. Copying or excerpting portion of, or altering the content of the report is not permitted without the written authorization of AGC. The test results presented in the report apply only to the tested sample. Any objections to report issued by AGC should be submitted to AGC within 15days after the issuance of the test report. Further enquiry of validity or verification of the test report should be addressed to AGC by agc01@agccert.com.