

# SMART TEAM Robot

AGES 6+



## CAUTION:

Hair entanglement may result if child's hair comes in contact with moving parts of toy. Adult supervision is required.

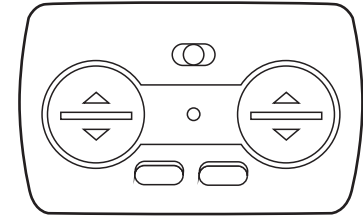
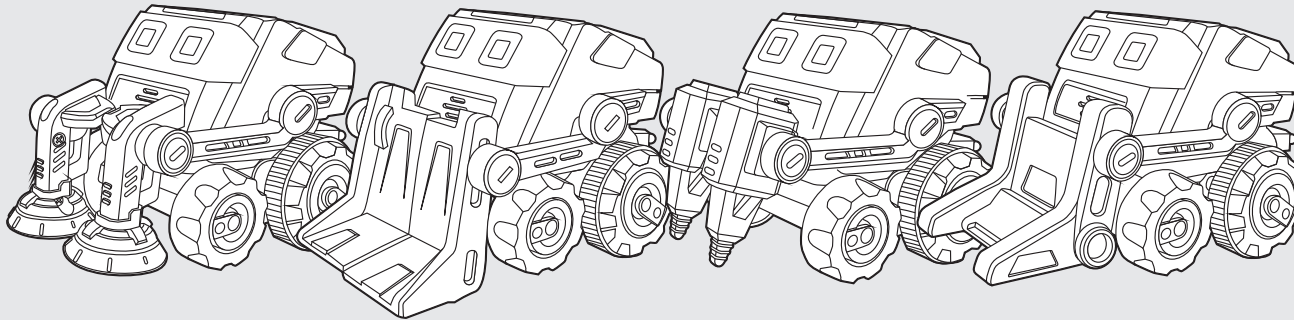

**Warning:** Changes or modifications to this unit not expressly approved by the party responsible for compliance could void the user's authority to operate the equipment.

**NOTE:** This equipment has been tested and found to comply with the limits for a Class B digital device, pursuant to Part 15 of the FCC Rules. These limits are designed to provide reasonable protection against harmful interference in a residential installation. This equipment generates, uses and can radiate radio frequency energy and, if not installed and used in accordance with the instructions, may cause harmful interference to radio communications.

However, there is no guarantee that interference will not occur in a particular installation. If this equipment does cause harmful interference to radio or television reception, which can be determined by turning the equipment off and on, the user is encouraged to try to correct the interference by one or more of the following measures:

- Reorient or relocate the receiving antenna.
- Increase the separation between the equipment and receiver.
- Connect the equipment into an outlet on a circuit different from that to which the receiver is connected.
- Consult the dealer or an experienced radio/TV technician for help.
- This device complies with Part 15 of the FCC Rules.

Operation is subject to the following two conditions:  
(1) this device may not cause harmful interference, and  
(2) this device must accept any interference received, including interference that may cause undesired operation.

## TO INSERT BATTERIES IN VEHICLE

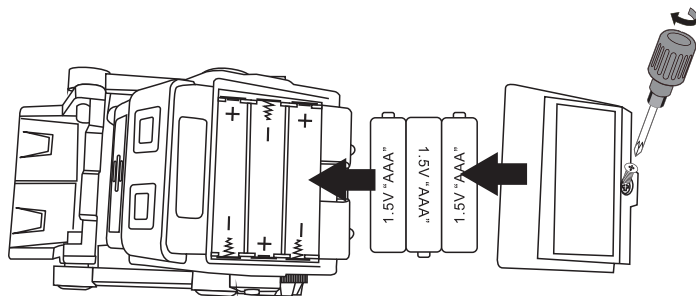

## TO INSERT BATTERIES IN REMOTE

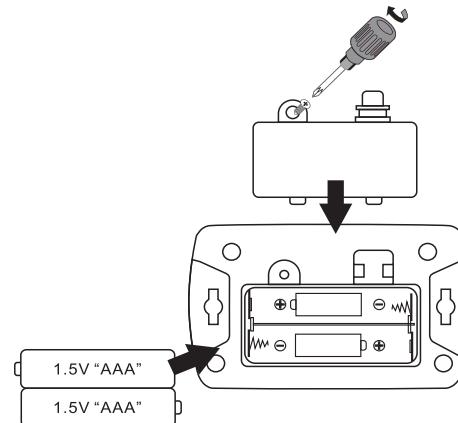

RADIO CONTROL **2.4**GHz

## TO PLAY

Make sure the vehicle and remote controller are turned ON.

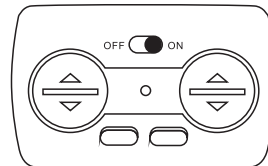
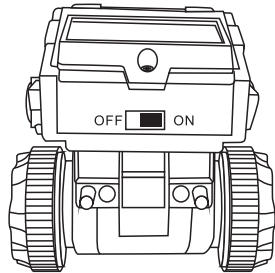

If your vehicle is not responding to the remote:  
 .make sure the vehicle and remote are turned ON.  
 .Replace the batteries in both the vehicle and Remote with the correct polarity.

## Remote controller operation

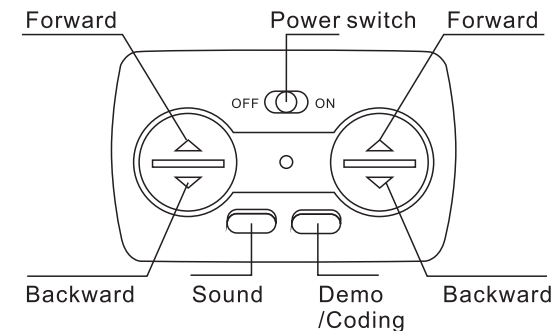

## IMPORTANT: BATTERY INFORMATION



### CAUTION:

1. As with all small batteries, the batteries used with this toy should be kept away from small children who still put things in their mouths.
2. TO AVOID BATTERY LEAKAGE
  - a. Always follow the instructions carefully, Use only batteries specified and be sure to insert them correctly by matching the + and - polarity markings.
  - b. Do not mix old batteries and new batteries or standard (carbon-zinc) with alkaline batteries.
  - c. Remove exhausted or dead batteries from the product.
  - d. Remove batteries if product is not to be played with for a long time.
  - e. Do not short-circuit the supply terminals.
  - f. RECHARGEABLE BATTERIES: Do not mix these with any other types of batteries. Always remove from the product before recharging. Recharge batteries under adult supervision. DO NOT RECHARGE OTHER TYPES OF BATTERIES.
3. Should this product cause, or be affected by, local electrical interference, move it away from other electrical equipment. Reset (switching off and back on again or removing and re-inserting batteries) if necessary.

1. To Move Stunt Car Straight Forward, push both left and right forward buttons together.
2. To Move Stunt Car Straight Reverse, push both left and right backward buttons together.
3. To Left Spinning Stunt Car, press both the Left forward button and the Right button backward together.  
 To Right Spinning Stunt Car, press both the Left backward and Right button forward together.
4. To Steer Stunt Car to the Left, press the left forward button.  
 To Steer Stunt Car to the Right, press the right forward button.  
 To Steer Stunt Car to the reverse Left, press the right backward button.  
 To Steer Stunt Car to the reverse Right, press the right backward button.
5. STUNT
 

For Wheelie function, press the both left and right backward button, then switch to press both left and right forward button **quickly**. Reverse the action to return back.

In Wheelie, to steer the stunt car spinning left, press both Left forward and Right backward button.

In Wheelie, to steer the stunt car spinning right, press both right forward and left backward button.
6. Press sound button to shift 3 default songs
7. To Demo, press the button once.  
 To Coding, press the demo button until beep sound. Then, set up your coding procedures freely. Afterward, press the demo button again to confirm. The Stunt car will demo your coding instruction accordingly.

## FOR BEST PERFORMANCE

- Use powerful alkaline batteries.
- Do not operate your vehicle on slippery surfaces.
- Clean up the tires if they are dirty.

