

## FCC Test Report

**Report No.:** RFBDIS-WTW-P20110097-1

**FCC ID:** 2AWUU6040001

**Test Model:** AD31-HW

**Received Date:** Nov. 04, 2020

**Test Date:** Nov. 11, 2020

**Issued Date:** Nov. 20, 2020

**Applicant:** Verkada Inc.

**Address:** 405 E. 4th Ave., San Mateo, CA 94401, USA

**Issued By:** Bureau Veritas Consumer Products Services (H.K.) Ltd., Taoyuan Branch  
Lin Kou Laboratories

**Lab Address:** No. 47-2, 14th Ling, Chia Pau Vil., Lin Kou Dist., New Taipei City, Taiwan

**Test Location:** No.19, Hwa Ya 2nd Rd., Wen Hwa Vil., Kwei Shan Dist., Taoyuan City  
33383, Taiwan

**FCC Registration /  
Designation Number:** 788550 / TW0003



This report is for your exclusive use. Any copying or replication of this report to or for any other person or entity, or use of our name or trademark, is permitted only with our prior written permission. This report sets forth our findings solely with respect to the test samples identified herein. The results set forth in this report are not indicative or representative of the quality or characteristics of the lot from which a test sample was taken or any similar or identical product unless specifically and expressly noted. Our report includes all of the tests requested by you and the results thereof based upon the information that you provided to us. You have 60 days from date of issuance of this report to notify us of any material error or omission caused by our negligence, provided, however, that such notice shall be in writing and shall specifically address the issue you wish to raise. A failure to raise such issue within the prescribed time shall constitute your unqualified acceptance of the completeness of this report, the tests conducted and the correctness of the report contents. Unless specific mention, the uncertainty of measurement has been explicitly taken into account to declare the compliance or non-compliance to the specification.

## Table of Contents

<b>Release Control Record .....</b>	<b>3</b>
<b>1 Certificate of Conformity .....</b>	<b>4</b>
<b>2 Summary of Test Results.....</b>	<b>5</b>
2.1 Measurement Uncertainty.....	5
2.2 Modification Record .....	5
<b>3 General Information .....</b>	<b>6</b>
3.1 General Description of EUT .....	6
3.2 Description of Test Modes.....	7
3.2.1 Test Mode Applicability and Tested Channel Detail.....	7
3.3 Description of Support Units .....	8
3.3.1 Configuration of System under Test .....	8
3.4 General Description of Applied Standards and references.....	8
<b>4 Test Types and Results .....</b>	<b>9</b>
4.1 Radiated Emission Measurement.....	9
4.1.1 Limits of Radiated Emission Measurement .....	9
4.1.2 Test Instruments .....	10
4.1.3 Test Procedures.....	11
4.1.4 Deviation from Test Standard .....	11
4.1.5 Test Set Up .....	12
4.1.6 EUT Operating Conditions.....	12
4.1.7 Test Results .....	13
4.2 Conducted Emission Measurement.....	18
4.2.1 Limits of Conducted Emission Measurement .....	18
4.2.2 Test Instruments .....	18
4.2.3 Test Procedures.....	19
4.2.4 Deviation from Test Standard .....	19
4.2.5 Test Setup.....	19
4.2.6 EUT Operating Conditions.....	19
4.2.7 Test Results .....	20
<b>5 Pictures of Test Arrangements.....</b>	<b>22</b>
<b>Appendix – Information of the Testing Laboratories .....</b>	<b>23</b>

### Release Control Record

Issue No.	Description	Date Issued
RFBDIS-WTW-P20110097-1	Original Release	Nov. 20, 2020

## 1 Certificate of Conformity

**Product:** Verkada Reader  
**Brand:** Verkada  
**Test Model:** AD31-HW  
**Sample Status:** Engineering Sample  
**Applicant:** Verkada Inc.  
**Test Date:** Nov. 11, 2020  
**Standards:** 47 CFR FCC Part 15, Subpart C (Section 15.225)  
47 CFR FCC Part 15, Subpart C (Section 15.215)  
ANSI C63.10:2013

This report is issued as a supplementary report to BV CPS report no.: RF200619C17-1. This report shall be used by combining with its original report.

Prepared by :  , Date: Nov. 20, 2020  
Lena Wang / Specialist

Approved by :  , Date: Nov. 20, 2020  
Dylan Chiou / Senior Project Engineer

## 2 Summary of Test Results

47 CFR FCC Part 15, Subpart C (Section 15.225, 15.215)			
FCC Clause	Test Item	Result	Remarks
15.207	Conducted emission test	Pass	Meet the requirement of limit. Minimum passing margin is -19.43 dB at 0.41550 MHz.
15.225 (a)	The field strength of any emissions within the band 13.553-13.567 MHz	Pass	Meet the requirement of limit. Minimum passing margin is -71.03 dB at 13.56 MHz.
15.225 (b)	The field strength of any emissions within the bands 13.410-13.553 MHz and 13.567-13.710 MHz	N/A	Refer to Note
15.225 (c)	The field strength of any emissions within the bands 13.110-13.410 MHz and 13.710-14.010 MHz	N/A	Refer to Note
15.225 (d)	The field strength of any emissions appearing outside of the 13.110-14.010 MHz band	Pass	Meet the requirement of limit. Minimum passing margin is -7.09 dB at 47.46 MHz.
15.225 (e)	The frequency tolerance	N/A	Refer to Note
15.215 (c)	20 dB Bandwidth	N/A	Refer to Note
15.203	Antenna Requirement	N/A	Refer to Note

Note:

1. Only Conducted Emission and Radiated Emissions (below 1GHz) tests was verified on the worst case and recorded in this report. Refer to original report for other test data.
2. Determining compliance based on the results of the compliance measurement, not taking into account measurement instrumentation uncertainty.

### 2.1 Measurement Uncertainty

Where relevant, the following measurement uncertainty levels have been estimated for tests performed on the EUT as specified in CISPR 16-4-2:

Measurement	Frequency	Expanded Uncertainty (k=2) (±)
Conducted Emissions at mains ports	150 kHz ~ 30 MHz	2.79 dB
Radiated Emissions up to 1 GHz	9 kHz ~ 30 MHz	3.04 dB
	30 MHz ~ 200 MHz	2.93 dB
	200 MHz ~ 1000 MHz	2.95 dB

### 2.2 Modification Record

There were no modifications required for compliance.

### 3 General Information

#### 3.1 General Description of EUT

<b>Product</b>	Verkada Reader
<b>Brand</b>	Verkada
<b>Test Model</b>	AD31-HW
<b>Status of EUT</b>	Engineering Sample
<b>Power Supply Rating</b>	12.0 Vdc (adapter)
<b>Modulation Type</b>	ASK
<b>Data Rate</b>	Type A: 106 kbit/s Type F: 212 kbit/s, 424 kbit/s
<b>Operating Frequency</b>	13.56 MHz
<b>Field Strength (Maximum)</b>	50.97 dBuV/m (3m)
<b>Antenna Type</b>	PCB Antenna
<b>Accessory Device</b>	N/A
<b>Data Cable Supplied</b>	0.17m cable attached on EUT

Note:

1. This report is prepared for FCC class II permissive change. This report is issued as a supplementary report to BV CPS report no: RF200619C17-1. The difference compared with original report is removing capacitive touch feature including controller (IQS231A) and FPC (Flexible Printed Circuit) sensing copper. Therefore, only Conducted Emission and Radiated Emissions (below 1GHz) tests was verified on the worst case and recorded in this report.
2. The test support units which provided by client is listed as below.

Product	Brand	Model	Description
Adapter	DVE	DSA-12PFT-12 FUS 120100	I/P: 100-240 Vac, 50/60 Hz, 0.5 A O/P: 12 Vdc, 1 A 1.47m power cable without core

3. The EUT supports NFC Type: Type A, F. The Type F is the worst for the final tests.
4. The above Antenna information is declared by manufacturer and for more detailed features description, please refer to the manufacturer's specifications, the laboratory shall not be held responsible.
5. The above EUT information is declared by manufacturer and for more detailed features description, please refers to the manufacturer's specifications or user's manual.
6. BT & NFC & RFID can transmit simultaneously.

### 3.2 Description of Test Modes

One channel was provided to this EUT:

Channel	Frequency (MHz)
1	13.56

#### 3.2.1 Test Mode Applicability and Tested Channel Detail

EUT Configure Mode	Applicable To				Description
	RE	PLC	FS	EB	
-	√	√	-	-	-

Where **RE:** Radiated Emission **PLC:** Power Line Conducted Emission  
**FS:** Frequency Stability **EB:** 20 dB Bandwidth measurement

**NOTE:** The EUT had been pre-tested on the positioned of each 3 axis. The worst case was found when positioned on **Z-plane**.

**NOTE:** "-" means no effect.

#### Radiated Emission Test:

- Pre-Scan has been conducted to determine the worst-case mode from all possible combinations between available modulations, data rates and antenna ports (if EUT with antenna diversity architecture).
- Following channel(s) was (were) selected for the final test as listed below.

EUT Configure Mode	Available Channel	Tested Channel	Modulation Type	Axis
-	1	1	ASK	Z

#### Power Line Conducted Emission Test:

- Pre-Scan has been conducted to determine the worst-case mode from all possible combinations between available modulations, data rates and antenna ports (if EUT with antenna diversity architecture).
- Following channel(s) was (were) selected for the final test as listed below.

EUT Configure Mode	Available Channel	Tested Channel	Modulation Type	Axis
-	1	1	ASK	Z

#### Test Condition:

Applicable To	Environmental Conditions	Input Power	Tested By
RE	25 deg. C, 65 % RH	120 Vac, 60 Hz	Tim Chen
PLC	25 deg. C, 65 % RH	120 Vac, 60 Hz	Getaz Yang

### 3.3 Description of Support Units

The EUT has been tested as an independent unit together with other necessary accessories or support units. The following support units or accessories were used to form a representative test configuration during the tests.

No.	Product	Brand	Model No.	Serial No.	FCC ID
1.	Adapter	DVE	DSA-12PFT-12 FUS 120100	N/A	N/A

No.	Signal Cable Description Of The Above Support Units
1.	1.47m power cable without core provided by client

Note:

1. All power cords of the above support units are non-shielded (1.8m).

#### 3.3.1 Configuration of System under Test

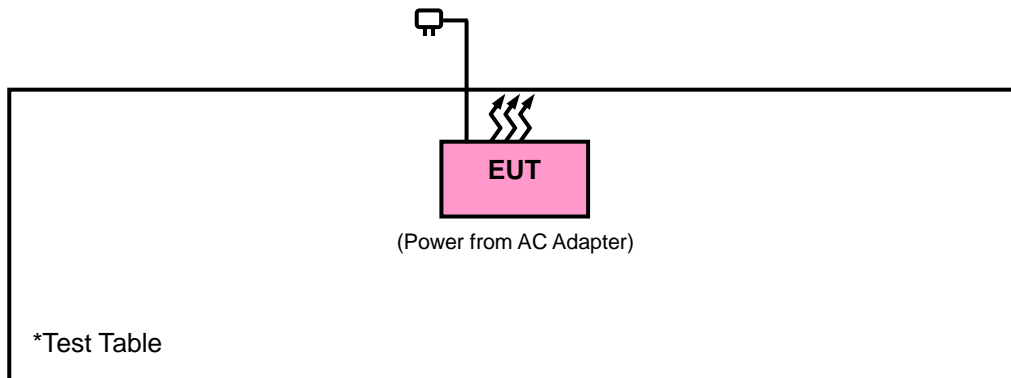

### 3.4 General Description of Applied Standards and references

The EUT is a RF Product. According to the specifications of the manufacturer, it must comply with the requirements of the following standards and references:

**FCC Part 15, Subpart C (15.225)**

**FCC Part 15, Subpart C (15.215)**

ANSI C63.10-2013

All test items have been performed and recorded as per the above standards.

References Test Guidance :

KDB 414788 D01 Radiated Test Site v01r01

All test items have been performed as a reference to the above KDB test guidance.



## 4 Test Types and Results

### 4.1 Radiated Emission Measurement

#### 4.1.1 Limits of Radiated Emission Measurement

- a. The field strength of any emissions within the band 13.553-13.567 MHz shall not exceed 15,848 microvolts/meter at 30 meters.
- b. Within the bands 13.410-13.553 MHz and 13.567-13.710 MHz, the field strength of any emissions shall not exceed 334 microvolts/meter at 30 meters.
- c. Within the bands 13.110-13.410 MHz and 13.710-14.010 MHz the field strength of any emissions shall not exceed 106 microvolts/meter at 30 meters.
- d. The field strength of any emissions appearing outside of the 13.110-14.010 MHz band shall not exceed the general radiated emission limits in §15.209 as below table:

Frequencies (MHz)	Field Strength (microvolts/meter)	Measurement Distance (meters)
0.009 ~ 0.490	2400/F (kHz)	300
0.490 ~ 1.705	24000/F (kHz)	30
1.705 ~ 30.0	30	30
30 ~ 88	100	3
88 ~ 216	150	3
216 ~ 960	200	3
Above 960	500	3

**NOTE:**

1. The lower limit shall apply at the transition frequencies.
2. Emission level (dBuV/m) = 20 log Emission level (uV/m).
3. For frequencies above 1000 MHz, the field strength limits are based on average detector, however, the peak field strength of any emission shall not exceed the maximum permitted average limits, specified above by more than 20 dB under any condition of modulation.

#### 4.1.2 Test Instruments

Description & Manufacturer	Model No.	Serial No.	Date of Calibration	Due Date of Calibration
Test Receiver Agilent	N9038A	MY51210203	Mar. 18, 2020	Mar. 17, 2021
Spectrum Analyzer Agilent	N9010A	MY52220314	Dec. 12, 2019	Dec. 11, 2020
Spectrum Analyzer ROHDE & SCHWARZ	FSU43	101261	Apr. 16, 2020	Apr. 15, 2021
BILOG Antenna SCHWARZBECK	VULB 9168	9168-472	Nov. 06, 2020	Nov. 05, 2021
Loop Antenna	EM-6879	269	Sep. 17, 2020	Sep. 16, 2021
Preamplifier EMCI	EMC001340	980201	Oct. 21, 2020	Oct. 20, 2021
Preamplifier EMCI	EMC 012645	980115	Oct. 07, 2020	Oct. 06, 2021
RF Coaxial Cable Worken	8D-FB	Cable-Ch10-01	Oct. 07, 2020	Oct. 06, 2021
Software BV ADT	E3 6.120103	NA	NA	NA
Antenna Tower MF	MFA-440H	NA	NA	NA
Turn Table MF	MFT-201SS	NA	NA	NA
Antenna Tower & Turn Table Controller MF	MF-7802	NA	NA	NA
WIT Standard Temperature And Humidity Chamber	TH-4S-C	W981030	Jun. 01, 2020	May 31, 2021
Digital Multimeter Fluke	87-III	70360742	Jun. 23, 2020	Jun. 22, 2021
DC Power Supply Topward	3303D	803136	NA	NA
Voltage Meter Fluke	179	89610322	Sep. 23, 2020	Sep. 22, 2021

- Note: 1. The calibration interval of the above test instruments is 12 months and the calibrations are traceable to NML/ROC and NIST/USA.  
 2. The test was performed in HwaYa Chamber 10.

#### 4.1.3 Test Procedures

##### **For Radiated Emission below 30 MHz**

- a. The EUT was placed on the top of a rotating table 0.8 meters above the ground at a 3 meter chamber room. The table was rotated 360 degrees to determine the position of the highest radiation.
- b. The EUT was set 3 meters away from the interference-receiving antenna, which was mounted on the top of a variable-height antenna tower.
- c. Parallel, perpendicular, and ground-parallel orientations of the antenna are set to make the measurement.
- d. For each suspected emission, the EUT was arranged to its worst case and the rotatable table was turned from 0 degrees to 360 degrees to find the maximum reading.
- e. The test-receiver system was set to Quasi-Peak Detect Function and Specified Bandwidth with Maximum Hold Mode, except for the frequency band (9kHz-90kHz, 110Hz-490kHz) set to average detect function.

##### **Note:**

1. The resolution bandwidth and video bandwidth of test receiver/spectrum analyzer is 9 kHz at frequency below 30 MHz.
2. There is a comparison data of both open-field test site and semi-Anechoic chamber, and the result came out very similar.

##### **For Radiated Emission above 30 MHz**

- a. The EUT was placed on the top of a rotating table 0.8 meters above the ground at 3 meter chamber room for test. The table was rotated 360 degrees to determine the position of the highest radiation.
- b. The EUT was set 3 meters away from the interference-receiving antenna, which was mounted on the top of a variable-height antenna tower.
- c. The height of antenna is varied from one meter to four meters above the ground to determine the maximum value of the field strength. Both horizontal and vertical polarizations of the antenna are set to make the measurement.
- d. For each suspected emission, the EUT was arranged to its worst case and then the antenna was tuned to heights from 1 meter to 4 meters and the rotatable table was turned from 0 degrees to 360 degrees to find the maximum reading.
- e. The test-receiver system was set to quasi-peak detect function and specified bandwidth with maximum hold mode when the test frequency is below 1 GHz.
- f. The test-receiver system was set to peak and average detected function and specified bandwidth with maximum hold mode when the test frequency is above 1 GHz. If the peak reading value also meets average limit, measurement with the average detector is unnecessary.

##### **Note:**

1. The resolution bandwidth and video bandwidth of test receiver/spectrum analyzer is 120 kHz for Quasi-peak detection (QP) or Peak detection (PK) at frequency below 1 GHz.
2. The resolution bandwidth of test receiver/spectrum analyzer is 1 MHz and the video bandwidth is 3 MHz for Peak detection (PK) at frequency above 1 GHz.
3. The resolution bandwidth of test receiver/spectrum analyzer is 1 MHz and the video bandwidth is  $\geq 1/T$  (Duty cycle < 98 %) or 10 Hz (Duty cycle  $\geq 98$  %) for Average detection (AV) at frequency above 1 GHz.
4. All modes of operation were investigated and the worst-case emissions are reported.

#### 4.1.4 Deviation from Test Standard

No deviation.

#### 4.1.5 Test Set Up

##### <Radiated Emission below 30 MHz>

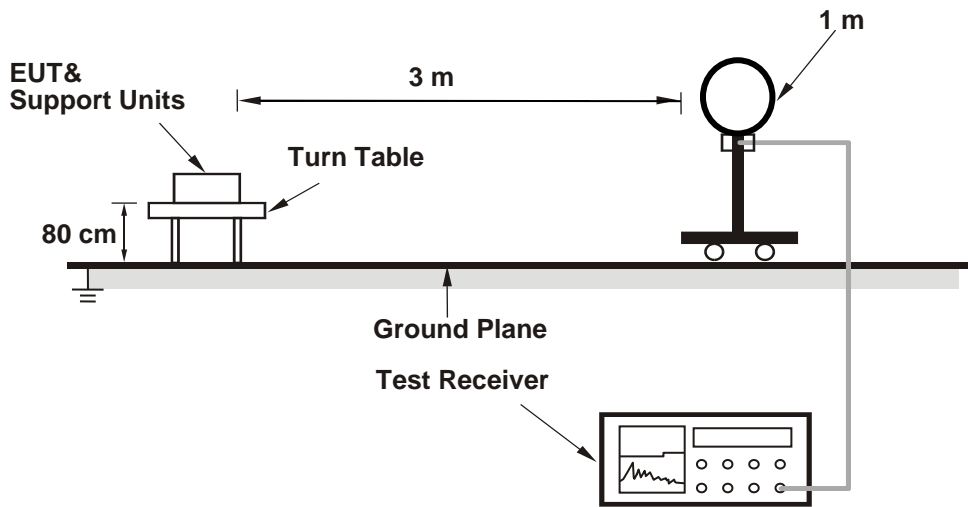

##### <Radiated Emission 30 MHz to 1 GHz>

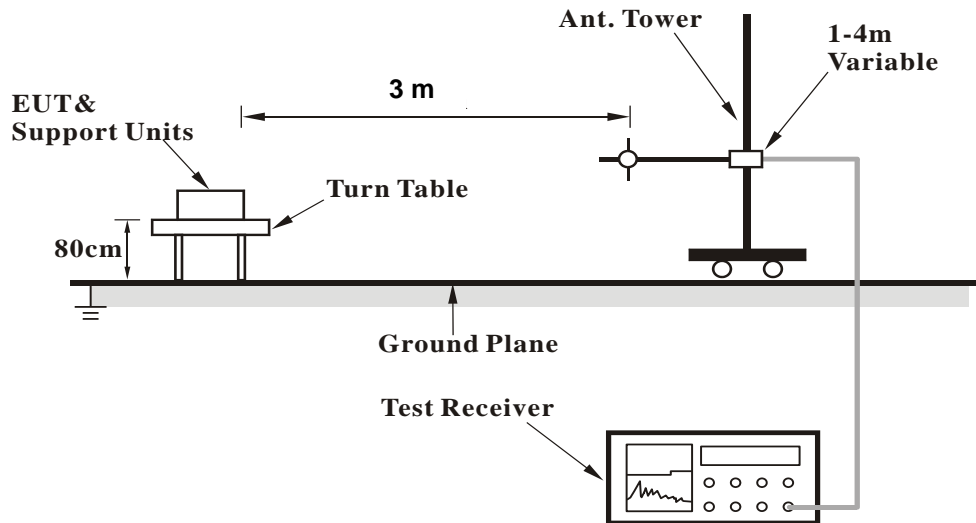

For the actual test configuration, please refer to the attached file (Test Setup Photo).

#### KDB 414788 OFS and Chamber Correlation Justification

- Base on FCC 15.31 (f) (2): measurements may be performed at a distance closer than that specified in the regulations; however, an attempt should be made to avoid making measurements in the near field.
- Open-field site and chamber correlation testing had been performed and chamber measured test result is the worst case test result.

#### 4.1.6 EUT Operating Conditions

- a. Placed the EUT on the testing table.
- b. Set the EUT under transmission condition continuously at specific channel frequency.

4.1.7 Test Results

EUT Test Condition		Measurement Detail	
Channel	Channel 1	Frequency Range	13.553 ~ 13.567 MHz
Input Power	120 Vac, 60 Hz	Detector Function	Quasi-Peak
Environmental Conditions	25 deg. C, 65 % RH	Tested By	Tim Chen

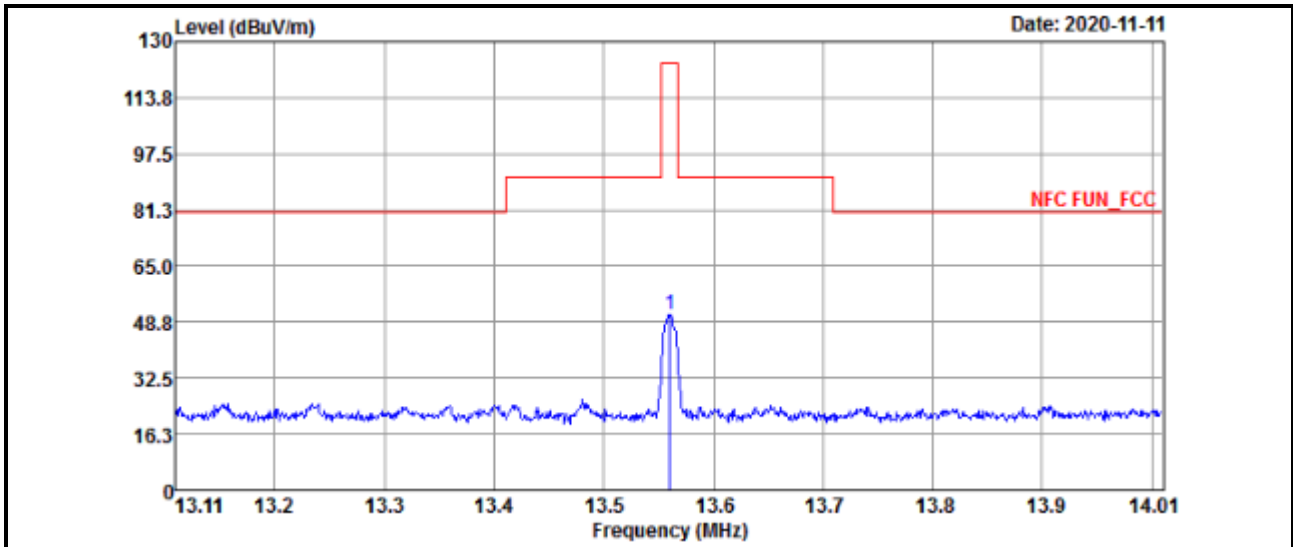

Antenna Polarity & Test Distance: Loop Antenna Parallel at 3 m								
Frequency (MHz)	Emission Level (dBuV/m)	Read Level (dBuV)	Factor (dB/m)	Limit (dBuV/m)	Margin (dB)	Antenna Height (cm)	Table Angle (Degree)	Remark
13.56	50.97	54.88	-3.91	124	-73.03	100	0	Peak

Remarks:

1. Emission level (dBuV/m) = Raw Value (dBuV) + Factor (dB/m)
2. The other emission levels were very low against the limit.
3. Margin value = Emission level – Limit value.
4. Above limits have been translated by the formula

The measured field strength was extrapolated to distance 30 meters, using the formula that the limit of field strength varies as the inverse distance square (40dB per decade of distance)

Example:

$$\begin{aligned}
 13.56 \text{ MHz} &= 15848 \text{ uV/m} && 30\text{m} \\
 &= 84 \text{ dBuV/m} && 30\text{m} \\
 &= 84+20\log(30/3)^2 && 3\text{m} \\
 &= 124 \text{ dBuV/m}
 \end{aligned}$$

EUT Test Condition		Measurement Detail	
Channel	Channel 1	Frequency Range	13.553 ~ 13.567 MHz
Input Power	120 Vac, 60 Hz	Detector Function	Quasi-Peak
Environmental Conditions	25 deg. C, 65 % RH	Tested By	Tim Chen

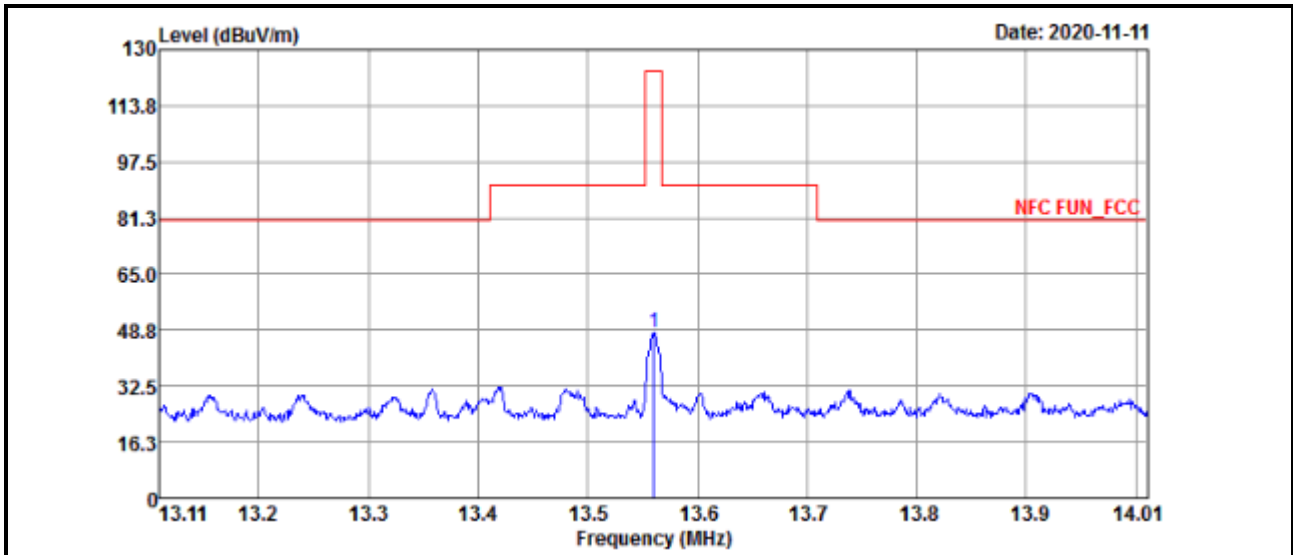

Antenna Polarity & Test Distance: Loop Antenna Perpendicular at 3 m								
Frequency (MHz)	Emission Level (dBuV/m)	Read Level (dBuV)	Factor (dB/m)	Limit (dBuV/m)	Margin (dB)	Antenna Height (cm)	Table Angle (Degree)	Remark
13.56	47.79	51.7	-3.91	124	-76.21	100	360	QP

Remarks:

1. Emission level (dBuV/m) = Raw Value (dBuV) + Factor (dB/m)
2. The other emission levels were very low against the limit.
3. Margin value = Emission level – Limit value.
4. Above limits have been translated by the formula

The measured field strength was extrapolated to distance 30 meters, using the formula that the limit of field strength varies as the inverse distance square (40dB per decade of distance)

Example:

$$\begin{aligned}
 13.56 \text{ MHz} &= 15848 \text{ uV/m} && 30\text{m} \\
 &= 84 \text{ dBuV/m} && 30\text{m} \\
 &= 84 + 20\log(30/3)^2 && 3\text{m} \\
 &= 124 \text{ dBuV/m}
 \end{aligned}$$

EUT Test Condition		Measurement Detail	
Channel	Channel 1	Frequency Range	13.553 ~ 13.567 MHz
Input Power	120 Vac, 60 Hz	Detector Function	Quasi-Peak
Environmental Conditions	25 deg. C, 65 % RH	Tested By	Tim Chen

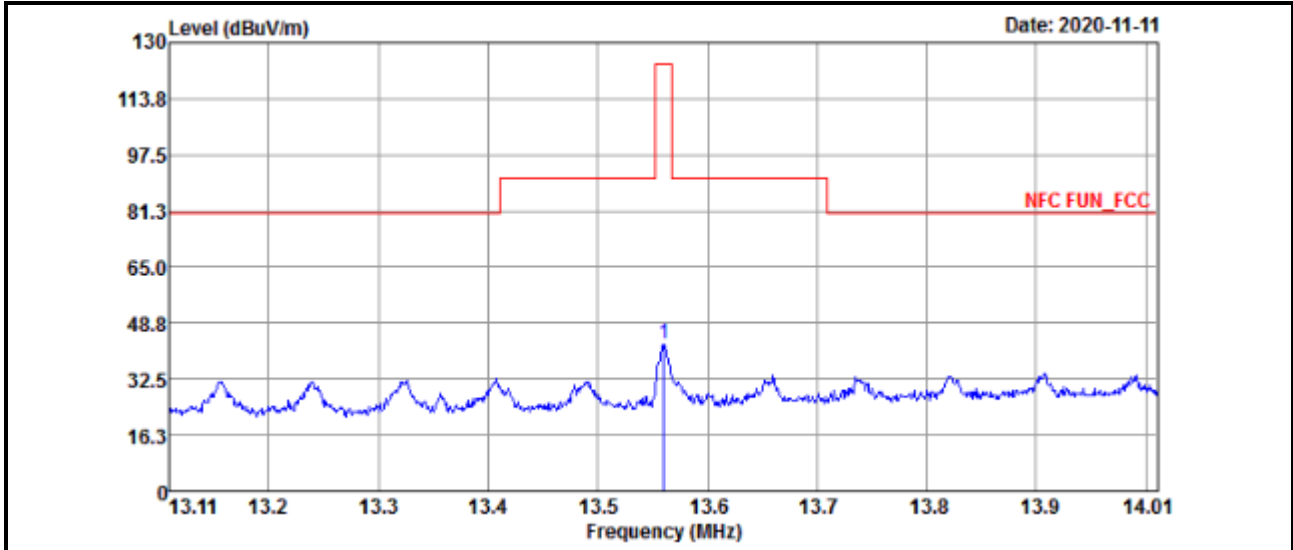

Antenna Polarity & Test Distance: Loop Antenna Ground-parallel at 3 m								
Frequency (MHz)	Emission Level (dBuV/m)	Read Level (dBuV)	Factor (dB/m)	Limit (dBuV/m)	Margin (dB)	Antenna Height (cm)	Table Angle (Degree)	Remark
13.56	42.49	46.4	-3.91	124	-81.51	100	360	QP

Remarks:

1. Emission level (dBuV/m) = Raw Value (dBuV) + Factor (dB/m)
2. The other emission levels were very low against the limit.
3. Margin value = Emission level – Limit value.
4. Above limits have been translated by the formula

The measured field strength was extrapolated to distance 30 meters, using the formula that the limit of field strength varies as the inverse distance square (40dB per decade of distance)

Example:

$$\begin{aligned}
 13.56 \text{ MHz} &= 15848 \text{ uV/m} && 30\text{m} \\
 &= 84 \text{ dBuV/m} && 30\text{m} \\
 &= 84 + 20\log(30/3)^2 && 3\text{m} \\
 &= 124 \text{ dBuV/m}
 \end{aligned}$$

EUT Test Condition		Measurement Detail	
Channel	Channel 1	Frequency Range	Below 1000 MHz
Input Power	120 Vac, 60 Hz	Detector Function	Quasi-Peak
Environmental Conditions	25 deg. C, 65 % RH	Tested By	Tim Chen

Horizontal

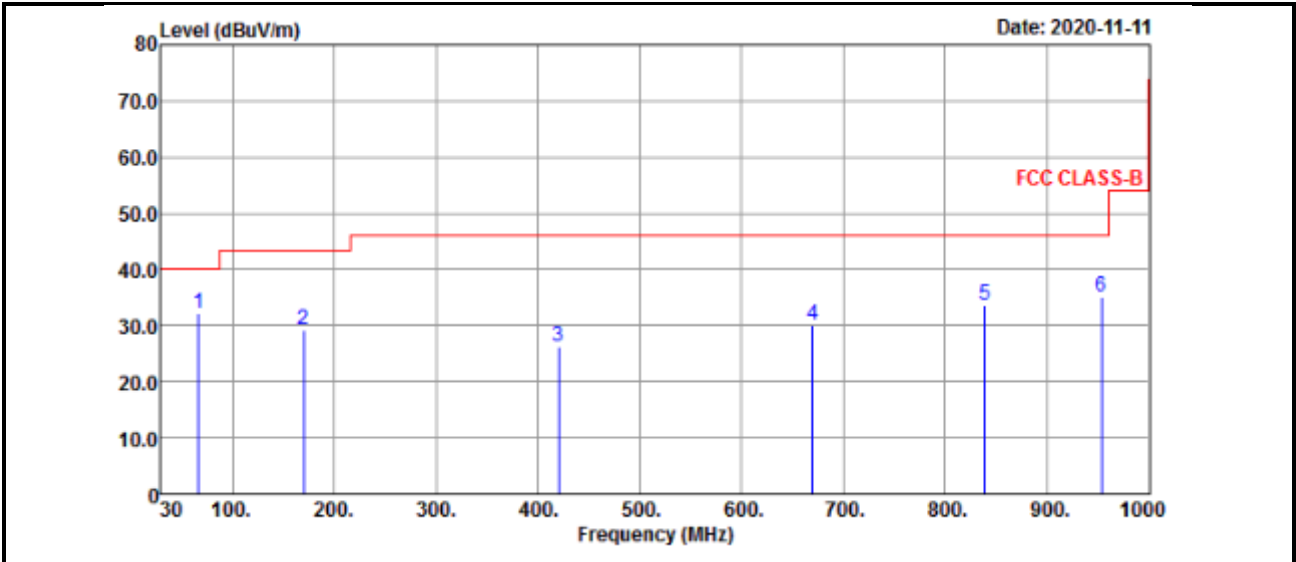

Vertical

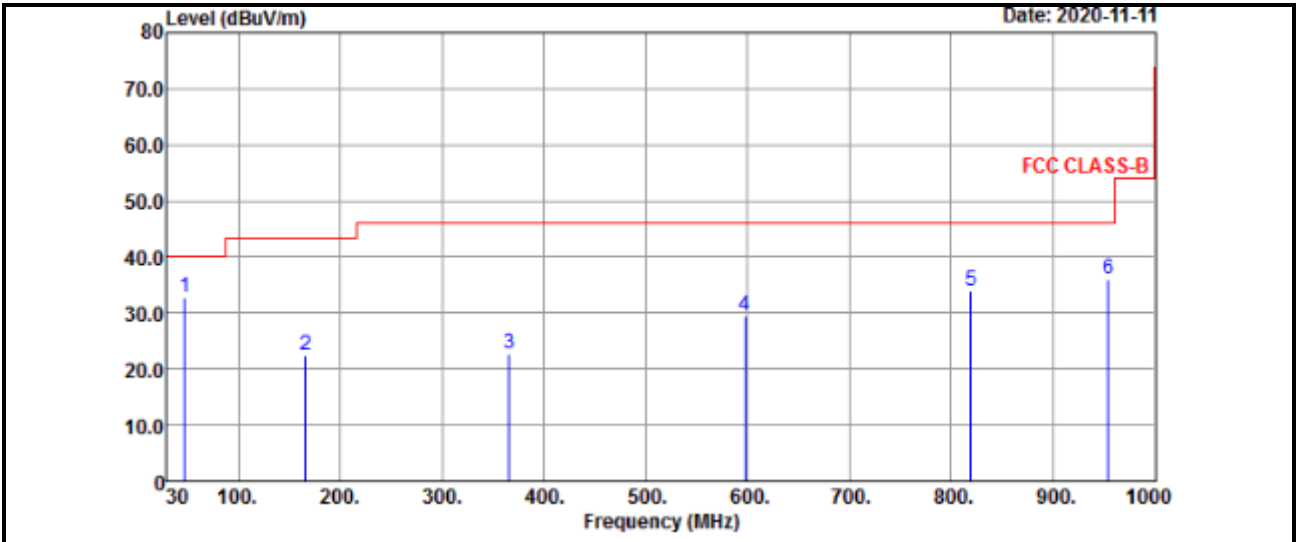



**Antenna Polarity & Test Distance: Horizontal at 3 m**

Frequency (MHz)	Emission Level (dBuV/m)	Read Level (dBuV)	Factor (dB/m)	Limit (dBuV/m)	Margin (dB)	Antenna Height (cm)	Table Angle (Degree)	Remark
66.86	32.32	45.51	-13.19	40	-7.68	171	223	QP
169.68	29.36	41.71	-12.35	43.5	-14.14	104	271	QP
419.94	26.4	33.92	-7.52	46	-19.6	198	69	QP
670.2	30.11	31.41	-1.3	46	-15.89	153	156	QP
838.98	33.69	31.33	2.36	46	-12.31	196	31	QP
953.44	35.19	31.48	3.71	46	-10.81	121	185	QP

**Antenna Polarity & Test Distance: Vertical at 3 m**

Frequency (MHz)	Emission Level (dBuV/m)	Read Level (dBuV)	Factor (dB/m)	Limit (dBuV/m)	Margin (dB)	Antenna Height (cm)	Table Angle (Degree)	Remark
47.46	32.91	44.68	-11.77	40	-7.09	119	235	QP
165.8	22.38	34.38	-12	43.5	-21.12	112	176	QP
365.62	22.81	32.02	-9.21	46	-23.19	111	148	QP
597.45	29.57	32.37	-2.8	46	-16.43	192	183	QP
819.58	33.93	31.75	2.18	46	-12.07	135	136	QP
954.41	36.08	32.37	3.71	46	-9.92	113	169	QP

## Remarks:

1. Emission Level = Read Level + Factor
2. Margin value = Emission level – Limit value.
3. The other emission levels were very low against the limit.
4. Correction Factor(dB/m) = Antenna Factor(dB/m) + Cable Factor(dB)  
– Pre-Amplifier Factor (dB)

## 4.2 Conducted Emission Measurement

### 4.2.1 Limits of Conducted Emission Measurement

Frequency (MHz)	Conducted Limit (dBuV)	
	Quasi-Peak	Average
0.15 - 0.5	66 - 56	56 - 46
0.50 - 5.0	56	46
5.0 - 30.0	60	50

Note:

1. The lower limit shall apply at the transition frequencies.
2. The limit decreases in line with the logarithm of the frequency in the range of 0.15 to 0.50 MHz.
3. All emanations from a class A/B digital device or system, including any network of conductors and apparatus connected thereto, shall not exceed the level of field strengths specified above.

### 4.2.2 Test Instruments

Description & Manufacturer	Model No.	Serial No.	Date of Calibration	Due Date of Calibration
Test Receiver ROHDE & SCHWARZ	ESR3	102412	Feb. 17, 2020	Feb. 16, 2021
RF signal cable (with 10dB PAD) Woken	5D-FB	Cable-cond2-01	Sep. 04, 2020	Sep. 03, 2021
LISN ROHDE & SCHWARZ (EUT)	ESH2-Z5	100100	Jan. 20, 2020	Jan. 19, 2021
LISN ROHDE & SCHWARZ (Peripheral)	ESH3-Z5	100312	Aug. 18, 2020	Aug. 17, 2021
Software ADT	BV ADT_Cond_ V7.3.7.4	NA	NA	NA

- Note: 1. The calibration interval of the above test instruments is 12 months and the calibrations are traceable to NML/ROC and NIST/USA.
2. The test was performed in HwaYa Shielded Room 2 (Conduction 2).
  3. The VCCI Site Registration No. is C-12047.

#### 4.2.3 Test Procedures

- a. The EUT was placed 0.4 meters from the conducting wall of the shielded room with EUT being connected to the power mains through a line impedance stabilization network (LISN). Other support units were connected to the power mains through another LISN. The two LISNs provide 50 ohm/50 uH of coupling impedance for the measuring instrument.
- b. Both lines of the power mains connected to the EUT were checked for maximum conducted interference.
- c. The frequency range from 150 kHz to 30 MHz was searched. Emission levels under (Limit – 20 dB) was not recorded.

**Note:** The resolution bandwidth and video bandwidth of test receiver is 9 kHz for quasi-peak detection (QP) and average detection (AV) at frequency 0.15 MHz - 30 MHz.

#### 4.2.4 Deviation from Test Standard

No deviation.

#### 4.2.5 Test Setup

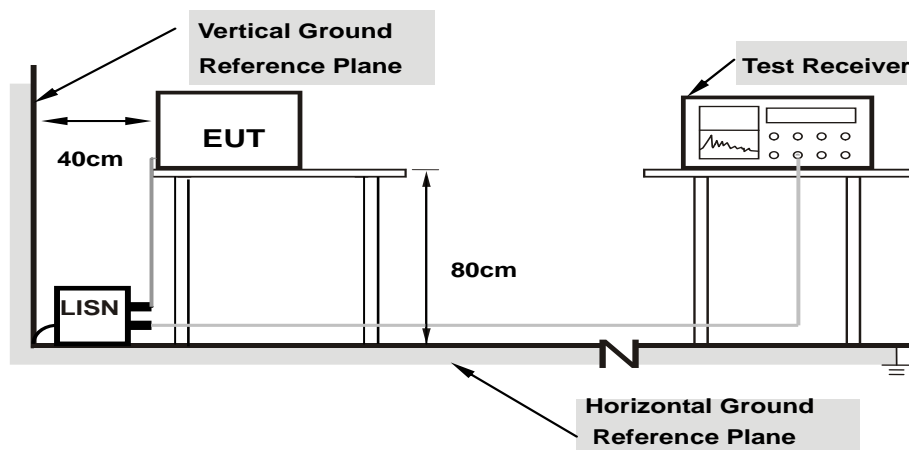

- Note:**
1. Support units were connected to second LISN.
  2. Both of LISNs (AMN) are 80 cm from EUT and at least 80 cm from other units and other metal planes

For the actual test configuration, please refer to the attached file (Test Setup Photo).

#### 4.2.6 EUT Operating Conditions

- a. Placed the EUT on the testing table.
- b. Set the EUT under transmission condition continuously at specific channel frequency.

#### 4.2.7 Test Results

<b>Frequency Range</b>	150kHz ~ 30MHz	<b>Detector Function &amp; Resolution Bandwidth</b>	Quasi-Peak (QP) / Average (AV), 9kHz
<b>Input Power</b>	120Vac, 60Hz	<b>Environmental Conditions</b>	25°C, 65%RH
<b>Tested by</b>	Getaz Yang	<b>Test Date</b>	2020/11/11

Phase Of Power : Line (L)										
No	Frequency (MHz)	Correction Factor (dB)	Reading Value (dBuV)		Emission Level (dBuV)		Limit (dBuV)		Margin (dB)	
			Q.P.	AV.	Q.P.	AV.	Q.P.	AV.	Q.P.	AV.
1	0.17700	10.09	25.19	16.10	35.28	26.19	64.63	54.63	-29.35	-28.44
2	0.42225	10.10	20.69	12.57	30.79	22.67	57.40	47.40	-26.61	-24.73
3	1.11300	10.15	6.67	2.80	16.82	12.95	56.00	46.00	-39.18	-33.05
4	5.06625	10.24	16.57	9.23	26.81	19.47	60.00	50.00	-33.19	-30.53
5	9.29850	10.29	16.79	9.50	27.08	19.79	60.00	50.00	-32.92	-30.21
6	13.56000	10.34	21.42	19.74	31.76	30.08	60.00	50.00	-28.24	-19.92

#### Remarks:

1. Q.P. and AV. are abbreviations of quasi-peak and average individually.
2. The emission levels of other frequencies were very low against the limit.
3. Margin value = Emission level – Limit value
4. Correction factor = Insertion loss + Cable loss
5. Emission Level = Correction Factor + Reading Value

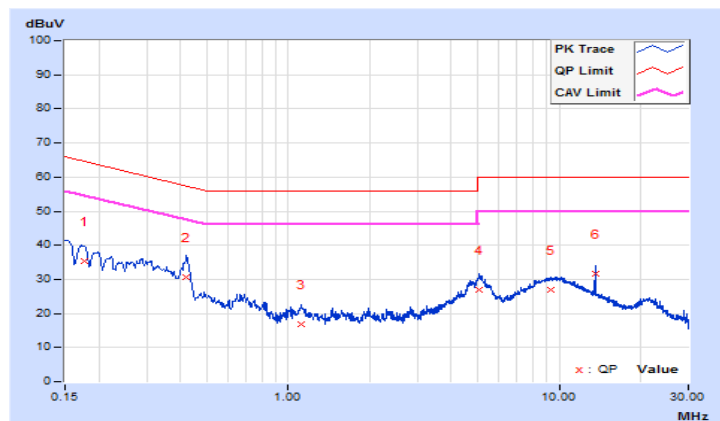

<b>Frequency Range</b>	150kHz ~ 30MHz	<b>Detector Function &amp; Resolution Bandwidth</b>	Quasi-Peak (QP) / Average (AV), 9kHz
<b>Input Power</b>	120Vac, 60Hz	<b>Environmental Conditions</b>	25°C, 65%RH
<b>Tested by</b>	Getaz Yang	<b>Test Date</b>	2020/11/11

Phase Of Power : Neutral (N)										
No	Frequency (MHz)	Correction Factor (dB)	Reading Value (dBuV)		Emission Level (dBuV)		Limit (dBuV)		Margin (dB)	
			Q.P.	AV.	Q.P.	AV.	Q.P.	AV.	Q.P.	AV.
1	0.16800	10.06	24.31	16.04	34.37	26.10	65.06	55.06	-30.69	-28.96
<b>2</b>	<b>0.41550</b>	<b>10.08</b>	<b>21.06</b>	<b>18.03</b>	<b>31.14</b>	<b>28.11</b>	<b>57.54</b>	<b>47.54</b>	<b>-26.40</b>	<b>-19.43</b>
3	0.84257	10.12	8.69	3.69	18.81	13.81	56.00	46.00	-37.19	-32.19
4	1.57425	10.14	8.46	3.91	18.60	14.05	56.00	46.00	-37.40	-31.95
5	5.12475	10.26	15.73	8.20	25.99	18.46	60.00	50.00	-34.01	-31.54
6	13.56000	10.47	13.25	12.06	23.72	22.53	60.00	50.00	-36.28	-27.47

**Remarks:**

1. Q.P. and AV. are abbreviations of quasi-peak and average individually.
2. The emission levels of other frequencies were very low against the limit.
3. Margin value = Emission level – Limit value
4. Correction factor = Insertion loss + Cable loss
5. Emission Level = Correction Factor + Reading Value

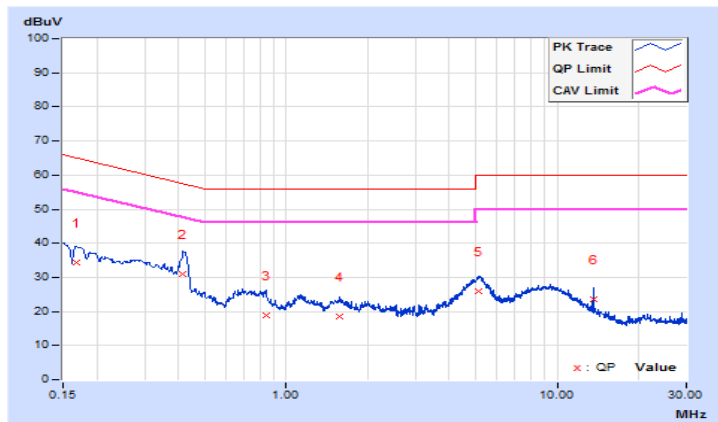

## 5 Pictures of Test Arrangements

Please refer to the attached file (Test Setup Photo).

## Appendix – Information of the Testing Laboratories

We, Bureau Veritas Consumer Products Services (H.K.) Ltd., Taoyuan Branch, were founded in 1988 to provide our best service in EMC, Radio, Telecom and Safety consultation. Our laboratories are FCC recognized accredited test firms and accredited according to ISO/IEC 17025.

If you have any comments, please feel free to contact us at the following:

**Lin Kou EMC/RF Lab**

Tel: 886-2-26052180

Fax: 886-2-26051924

**Hsin Chu EMC/RF/Telecom Lab**

Tel: 886-3-6668565

Fax: 886-3-6668323

**Hwa Ya EMC/RF/Safety Lab**

Tel: 886-3-3183232

Fax: 886-3-3270892

**Email:** [service.adt@tw.bureauveritas.com](mailto:service.adt@tw.bureauveritas.com)

**Web Site:** [www.bureauveritas-adt.com](http://www.bureauveritas-adt.com)

The address and road map of all our labs can be found in our web site also.

--- END ---