

FCC Test Report (Co-Located)

Report No.: RF200619C17-3

FCC ID: 2AWUU6040001

Test Model: AD31-HW

Received Date: Jun. 19, 2020

Test Date: Jul. 08 ~ Jul. 11, 2020

Issued Date: Aug. 17, 2020

Applicant: Verkada Inc.

Address: 405 E. 4th Ave., San Mateo, CA 94401, USA

Issued By: Bureau Veritas Consumer Products Services (H.K.) Ltd., Taoyuan Branch
Lin Kou Laboratories

Lab Address: No. 47-2, 14th Ling, Chia Pau Vil., Lin Kou Dist., New Taipei City, Taiwan

Test Location: No. 19, Hwa Ya 2nd Rd., Wen Hwa Vil., Kwei Shan Dist., Taoyuan City
33383, TAIWAN

**FCC Registration /
Designation Number:** 788550 / TW0003



This report is for your exclusive use. Any copying or replication of this report to or for any other person or entity, or use of our name or trademark, is permitted only with our prior written permission. This report sets forth our findings solely with respect to the test samples identified herein. The results set forth in this report are not indicative or representative of the quality or characteristics of the lot from which a test sample was taken or any similar or identical product unless specifically and expressly noted. Our report includes all of the tests requested by you and the results thereof based upon the information that you provided to us. You have 60 days from date of issuance of this report to notify us of any material error or omission caused by our negligence, provided, however, that such notice shall be in writing and shall specifically address the issue you wish to raise. A failure to raise such issue within the prescribed time shall constitute your unqualified acceptance of the completeness of this report, the tests conducted and the correctness of the report contents. Unless specific mention, the uncertainty of measurement has been explicitly taken into account to declare the compliance or non-compliance to the specification.

Table of Contents

Release Control Record	3
1 Certificate of Conformity	4
2 Summary of Test Results	5
2.1 Measurement Uncertainty	5
2.2 Modification Record	5
3 General Information	6
3.1 General Description of EUT	6
3.2 Description of Test Modes	7
3.2.1 Test Mode Applicability and Tested Channel Detail	8
3.3 Description of Support Units	9
3.3.1 Configuration of System under Test	9
3.4 General Description of Applied Standards	9
4 Test Types and Results	10
4.1 Radiated Emission and Bandedge Measurement	10
4.1.1 Limits of Radiated Emission and Bandedge Measurement	10
4.1.2 Test Instruments	11
4.1.3 Test Procedures	12
4.1.4 Deviation from Test Standard	12
4.1.5 Test Setup	13
4.1.6 EUT Operating Conditions	14
4.1.7 Test Results	15
5 Pictures of Test Arrangements	19
Appendix – Information of the Testing Laboratories	20

Release Control Record

Issue No.	Description	Date Issued
RF200619C17-3	Original Release	Aug. 17, 2020

1 Certificate of Conformity

Product: Verkada Reader
Brand: Verkada
Test Model: AD31-HW
Sample Status: Engineering Sample
Applicant: Verkada Inc.
Test Date: Jul. 08 ~ Jul. 11, 2020
Standards: 47 CFR FCC Part 15, Subpart C (Section 15.247)
47 CFR FCC Part 15, Subpart C (Section 15.225)
47 CFR FCC Part 15, Subpart C (Section 15.215)
47 CFR FCC Part 15, Subpart C (Section 15.209)
ANSI C63.10:2013

The above equipment has been tested by **Bureau Veritas Consumer Products Services (H.K.) Ltd., Taoyuan Branch**, and found compliance with the requirement of the above standards. The test record, data evaluation & Equipment Under Test (EUT) configurations represented herein are true and accurate accounts of the measurements of the sample's RF characteristics under the conditions specified in this report.

Prepared by :  , Date: Aug. 17, 2020
Lena Wang / Specialist

Approved by :  , Date: Aug. 17, 2020
Dylan Chiou / Senior Project Engineer

2 Summary of Test Results

Applied Standard:	47 CFR FCC Part 15, Subpart C (Section 15.247) 47 CFR FCC Part 15, Subpart C (Section 15.225) 47 CFR FCC Part 15, Subpart C (Section 15.215) 47 CFR FCC Part 15, Subpart C (Section 15.209)		
FCC Clause	Test Item	Result	Remarks
15.205 / 15.209 / 15.247(d) (1/2/3/4(i/ii)/6)	Radiated Emissions	Pass	Meet the requirement of limit. Minimum passing margin is -4.09dB at 7206 MHz.

Note: Determining compliance based on the results of the compliance measurement, not taking into account measurement instrumentation uncertainty.

2.1 Measurement Uncertainty

Where relevant, the following measurement uncertainty levels have been estimated for tests performed on the EUT as specified in CISPR 16-4-2:

Measurement	Frequency	Expanded Uncertainty (k=2) (\pm)
Radiated Emissions up to 1 GHz	9 kHz ~ 30 MHz	3.04 dB
	30MHz ~ 200MHz	3.86 dB
	200MHz ~1000MHz	3.87 dB
Radiated Emissions above 1 GHz	1GHz ~ 18GHz	2.29 dB
	18GHz ~ 40GHz	2.29 dB

2.2 Modification Record

There were no modifications required for compliance.

3 General Information

3.1 General Description of EUT

Product	Verkada Reader	
Brand	Verkada	
Test Model	AD31-HW	
Sample Status	Engineering sample	
Power Supply rating	12.0 Vdc (adapter)	
Modulation Type	BT LE	GFSK
	NFC	ASK
	RFID	FSK
Transfer Rate	BT LE	1 Mbps
	NFC	Type A: 106 kbit/s Type F: 212 kbit/s, 424 kbit/s
	RFID	2Kbit/s
Operating Frequency	BT LE	2402 ~ 2480 MHz
	NFC	13.56 MHz
	RFID	129.42kHz
Output Power	BT LE	4.178 mW
Field Strength (Maximum)	NFC	51.23 dBuV/m (3m)
	RFID	70.52 dBuV/m (3m)
Antenna Type	Refer to Note as below	
Antenna Connector	N/A	
Accessory Device	N/A	
Cable Supplied	0.17m cable attached on EUT	

Note:

1. The following antennas were provided to the EUT.

Antenna Spec.	Ant. No.	Model name	Ant. Type	Gain (dBi)
	1	NFC (125KHz)	Coil and capacitor	Not applicable
	2	NFC (13.56MHz)	PCB	Not applicable
	3	BLE (2.4G)	PCB	0

2. The test support units which provided by client is listed as below.

Product	Brand	Model	Description
Adapter	DVE	DSA-12PFT-12 FUS 120100	I/P: 100-240 Vac, 50/60 Hz, 0.5 A O/P: 12 Vdc, 1 A 1.47m power cable without core

3. The above Antenna information is declared by manufacturer and for more detailed features description, please refer to the manufacturer's specifications, the laboratory shall not be held responsible.

4. The above EUT information is declared by manufacturer and for more detailed features description, please refers to the manufacturer's specifications or user's manual.

3.2 Description of Test Modes

BT LE:

40 channels are provided provided to this EUT:

Channel	Freq. (MHz)	Channel	Freq. (MHz)	Channel	Freq. (MHz)	Channel	Freq. (MHz)
0	2402	10	2422	20	2442	30	2462
1	2404	11	2424	21	2444	31	2464
2	2406	12	2426	22	2446	32	2466
3	2408	13	2428	23	2448	33	2468
4	2410	14	2430	24	2450	34	2470
5	2412	15	2432	25	2452	35	2472
6	2414	16	2434	26	2454	36	2474
7	2416	17	2436	27	2456	37	2476
8	2418	18	2438	28	2458	38	2478
9	2420	19	2440	29	2460	39	2480

NFC:

1 channel was provided to this EUT:

Channel	Frequency (MHz)
1	13.56

RFID:

1 channel is provided to this EUT:

Channel	Frequency (kHz)
1	129.42

3.2.1 Test Mode Applicability and Tested Channel Detail

EUT Configure Mode	Applicable to		Description
	RE \geq 1G	RE<1G	
-	√	√	-

Where RE \geq 1G: Radiated Emission above 1GHz & Bandedge Measurement RE<1G: Radiated Emission below 1GHz

NOTE: The EUT had been pre-tested on the positioned of each 3 axis. The worst case was found when positioned on **Z-plane**
NOTE: "-" means no effect.

Radiated Emission Test (Above 1 GHz):

- Pre-Scan has been conducted to determine the worst-case mode from all possible combinations between available modulations, data rates and antenna ports (if EUT with antenna diversity architecture).
- Following channel(s) was (were) selected for the final test as listed below.

EUT Configure Mode	Mode	Freq. Range	Available Channel	Tested Channel	Modulation Technology
-	BT LE + NFC + RFID	2402 ~ 2480 MHz	0, 19, 39	0 + 1 + 1	GFSK
		13.56 MHz	1		ASK
		129.42kHz	1		FSK

Radiated Emission Test (Below 1GHz):

- Pre-Scan has been conducted to determine the worst-case mode from all possible combinations between available modulations, data rates and antenna ports (if EUT with antenna diversity architecture).
- Following channel(s) was (were) selected for the final test as listed below.

EUT Configure Mode	Mode	Freq. Range (MHz)	Available Channel	Tested Channel	Modulation Technology
-	BT LE + NFC + RFID	2402 ~ 2480 MHz	0, 19, 39	0 + 1 + 1	GFSK
		13.56 MHz	1		ASK
		129.42kHz	1		FSK

Test Condition:

Applicable to	Environmental Conditions	Input Power (System)	Tested by
RE \geq 1G	23 deg. C, 67% RH	120 Vac, 60 Hz	Tim Chen
RE<1G	23 deg. C, 67% RH	120 Vac, 60 Hz	Tim Chen

3.3 Description of Support Units

The EUT has been tested as an independent unit together with other necessary accessories or support units. The following support units or accessories were used to form a representative test configuration during the tests.

ID	Product	Brand	Model No.	Serial No.	FCC ID
A.	Adapter	DVE	DSA-12PFT-12 FUS 120100	N/A	N/A

Note:

1. All power cords of the above support units are non-shielded (1.8m).
2. Item A acted as communication partner to transfer data.
3. Items B was provided by client.

ID	Cable Descriptions	Qty.	Length (m)	Shielding (Yes/No)	Cores (Qty.)	Remarks
1.	Power Cable	1	1.47	N	0	-

3.3.1 Configuration of System under Test

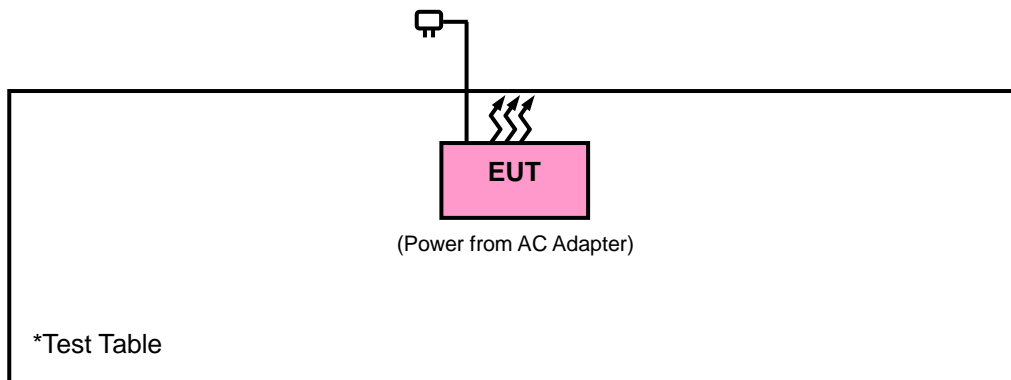

3.4 General Description of Applied Standards

The EUT is a RF Product. According to the specifications of the manufacturer, it must comply with the requirements of the following standards and references:

Test Standard:

FCC Part 15, Subpart C (15.247)

FCC Part 15, Subpart C (15.225)

FCC Part 15, Subpart C (15.215)

FCC Part 15, Subpart C (15.209)

ANSI C63.10-2013

All test items have been performed and recorded as per the above standards.

References Test Guidance:

KDB 558074 D01 15.247 Meas Guidance v05r02

KDB 414788 D01 Radiated Test Site v01r01

All test items have been performed as a reference to the above KDB test guidance.

4 Test Types and Results

4.1 Radiated Emission and Bandedge Measurement

4.1.1 Limits of Radiated Emission and Bandedge Measurement

Radiated emissions which fall in the restricted bands must comply with the radiated emission limits specified as below table. Other emissions shall be at least 30dB below the highest level of the desired power:

Frequencies (MHz)	Field Strength (microvolts/meter)	Measurement Distance (meters)
0.009 ~ 0.490	2400/F(kHz)	300
0.490 ~ 1.705	24000/F(kHz)	30
1.705 ~ 30.0	30	30
30 ~ 88	100	3
88 ~ 216	150	3
216 ~ 960	200	3
Above 960	500	3

Note:

1. The lower limit shall apply at the transition frequencies.
2. Emission level (dBuV/m) = 20 log Emission level (uV/m).
3. For frequencies above 1000MHz, the field strength limits are based on average detector, however, the peak field strength of any emission shall not exceed the maximum permitted average limits, specified above by more than 20dB under any condition of modulation.

Limits of unwanted emission out of the restricted bands

Applicable To	Limit	
789033 D02 General UNII Test Procedure New Rules v02r01	Field Strength at 3m	
	PK: 74 (dBµV/m)	AV: 54 (dBµV/m)
*1 beyond 75 MHz or more above of the band edge.	*2 below the band edge increasing linearly to 10 dBm/MHz at 25 MHz above.	
*3 below the band edge increasing linearly to a level of 15.6 dBm/MHz at 5 MHz above.	*4 from 5 MHz above or below the band edge increasing linearly to a level of 27 dBm/MHz at the band edge.	

Note: The following formula is used to convert the equipment isotropic radiated power (eirp) to field strength:

$$E = \frac{1000000\sqrt{30P}}{3} \mu\text{V/m, where } P \text{ is the eirp (Watts).}$$

4.1.2 Test Instruments

Description & Manufacturer	Model No.	Serial No.	Date of Calibration	Due Date of Calibration
Test Receiver Agilent	N9038A	MY51210203	Mar. 18, 2020	Mar. 17, 2021
Spectrum Analyzer Agilent	N9010A	MY52220314	Dec. 12, 2019	Dec. 11, 2020
Spectrum Analyzer ROHDE & SCHWARZ	FSU43	101261	Apr. 16, 2020	Apr. 15, 2021
HORN Antenna SCHWARZBECK	BBHA 9120D	9120D-969	Nov. 24, 2019	Nov. 23, 2020
BILOG Antenna SCHWARZBECK	VULB 9168	9168-472	Nov. 08, 2019	Nov. 07, 2020
Fixed Attenuator WORKEN	MDCS18N-10	MDCS18N-10-01	Apr. 14, 2020	Apr. 13, 2021
Loop Antenna	EM-6879	269	Sep. 16, 2019	Sep. 15, 2020
Preamplifier EMCI	EMC001340	980201	Oct. 14, 2019	Oct. 13, 2020
Preamplifier EMCI	EMC 012645	980115	Oct. 08, 2019	Oct. 07, 2020
Power Meter Anritsu	ML2495A	1012010	Sep. 04, 2019	Sep. 03, 2020
Power Sensor Anritsu	MA2411B	1315050	Sep. 04, 2019	Sep. 03, 2020
RF Coaxial Cable HUBER+SUHNNER	EMC104-SM-SM-8000&3000	140811+170717	Oct. 08, 2019	Oct. 07, 2020
RF Coaxial Cable HUBER+SUHNNER	SUCOFLEX 104	EMC104-SM-SM-1000(140807)	Oct. 08, 2019	Oct. 07, 2020
RF Coaxial Cable Worken	8D-FB	Cable-Ch10-01	Oct. 08, 2019	Oct. 07, 2020
Boresight Antenna Fixture	FBA-01	FBA-SIP01	NA	NA
Software BV ADT	E3 6.120103	NA	NA	NA
Antenna Tower MF	MFA-440H	NA	NA	NA
Turn Table MF	MFT-201SS	NA	NA	NA
Antenna Tower & Turn Table Controller MF	MF-7802	NA	NA	NA

- Note: 1. The calibration interval of the above test instruments is 12 months and the calibrations are traceable to NML/ROC and NIST/USA.
2. The test was performed in HwaYa Chamber 10.

4.1.3 Test Procedures

For Radiated emission below 30MHz

- a. The EUT was placed on the top of a rotating table 0.8 meters above the ground at a 3 meter chamber room. The table was rotated 360 degrees to determine the position of the highest radiation.
- b. The EUT was set 3 meters away from the interference-receiving antenna, which was mounted on the top of a variable-height antenna tower.
- c. Parallel, perpendicular, and ground-parallel orientations of the antenna are set to make the measurement.
- d. For each suspected emission, the EUT was arranged to its worst case and the rotatable table was turned from 0 degrees to 360 degrees to find the maximum reading.
- e. The test-receiver system was set to Quasi-Peak Detect Function and Specified Bandwidth with Maximum Hold Mode.

Note:

1. The resolution bandwidth and video bandwidth of test receiver/spectrum analyzer is 9kHz at frequency below 30MHz.

For Radiated emission above 30MHz

- a. The EUT was placed on the top of a rotating table 0.8 meters (for 30MHz ~ 1GHz) / 1.5 meters (for above 1GHz) above the ground at 3 meter chamber room for test. The table was rotated 360 degrees to determine the position of the highest radiation.
- b. The EUT was set 3 meters away from the interference-receiving antenna, which was mounted on the top of a variable-height antenna tower.
- c. The height of antenna is varied from one meter to four meters above the ground to determine the maximum value of the field strength. Both horizontal and vertical polarizations of the antenna are set to make the measurement.
- d. For each suspected emission, the EUT was arranged to its worst case and then the antenna was tuned to heights from 1 meter to 4 meters and the rotatable table was turned from 0 degrees to 360 degrees to find the maximum reading.
- e. The test-receiver system was set to quasi-peak detect function and specified bandwidth with maximum hold mode when the test frequency is below 1 GHz.
- f. The test-receiver system was set to peak and average detect function and specified bandwidth with maximum hold mode when the test frequency is above 1 GHz. If the peak reading value also meets average limit, measurement with the average detector is unnecessary.

Note:

1. The resolution bandwidth and video bandwidth of test receiver/spectrum analyzer is 120kHz for Quasi-peak detection (QP) at frequency below 1GHz.
2. The resolution bandwidth of test receiver/spectrum analyzer is 1 MHz and the video bandwidth is 3 MHz for Peak detection (PK) at frequency above 1GHz.
3. The resolution bandwidth of test receiver/spectrum analyzer is 1MHz and the video bandwidth is $\geq 1/T$ (Duty cycle < 98%) or 10Hz (Duty cycle $\geq 98\%$) for Average detection (AV) at frequency above 1GHz.
4. All modes of operation were investigated and the worst-case emissions are reported.

4.1.4 Deviation from Test Standard

No deviation.

4.1.5 Test Setup

For Radiated emission below 30MHz

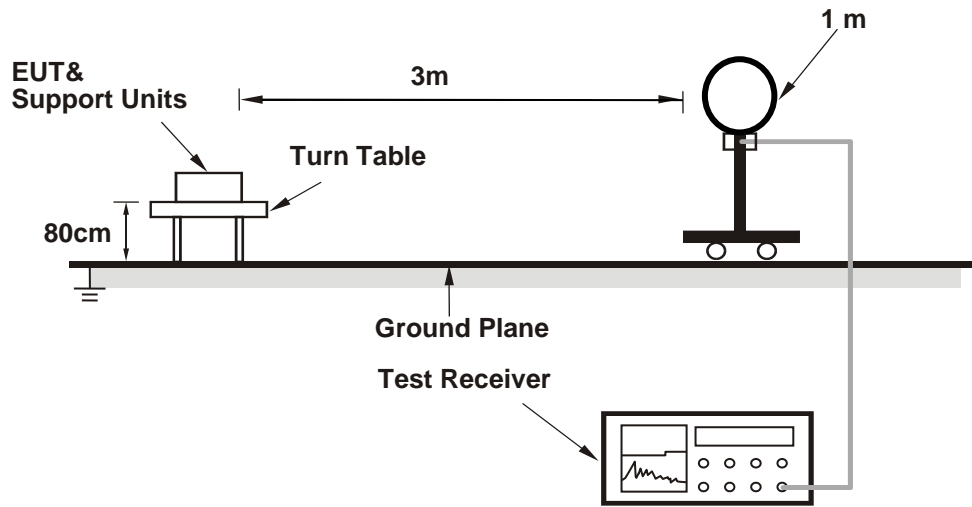

For Radiated emission 30MHz to 1GHz

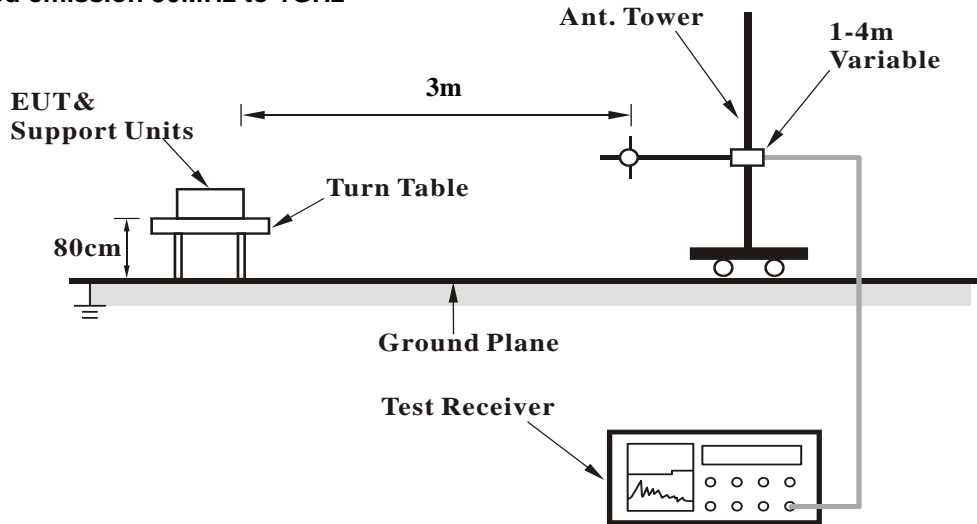

For Radiated emission above 1GHz

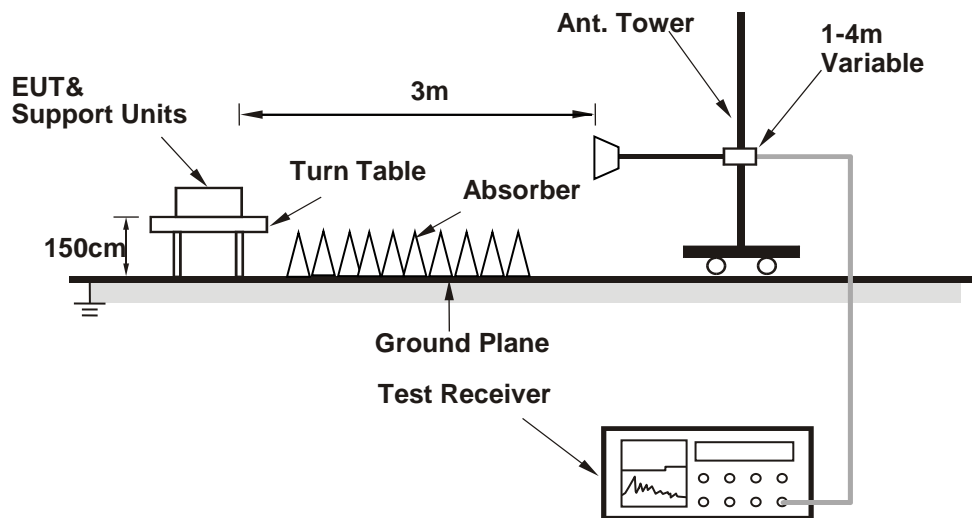

For the actual test configuration, please refer to the attached file (Test Setup Photo).

4.1.6 EUT Operating Conditions

- a. Placed the EUT on the testing table.
- b. Prepared a notebook to act as a communication partner and placed it outside of testing area.
- c. The communication partner connected with EUT via a RJ45 cable and ran a test program (provided by manufacturer) to enable EUT under transmission condition continuously at specific channel frequency.
- d. The communication partner sent data to EUT by command "PING".

4.1.7 Test Results

Above 1GHz Data:

BT LE + NFC +RFID:

EUT Test Condition		Measurement Detail	
Channel	Channel 0	Frequency Range	1 GHz ~ 25 GHz
Input Power	120 Vac, 60 Hz	Detector Function	Peak (PK) Average (AV)
Environmental Conditions	25 deg. C, 65 % RH	Tested By	Tim Chen

Antenna Polarity & Test Distance: Horizontal at 3 m								
Frequency (MHz)	Emission Level (dBuV/m)	Read Level (dBuV)	Factor (dB/m)	Limit (dBuV/m)	Margin (dB)	Antenna Height (cm)	Table Angle (Degree)	Remark
2390	36.05	41.97	-5.92	54	-17.95	100	187	Average
2390	45.89	51.81	-5.92	74	-28.11	100	187	Peak
2402	98.7	104.64	-5.94	-----	-----	100	187	Average
2402	100.12	106.06	-5.94	-----	-----	100	187	Peak
2426	99.7	105.59	-5.89	-----	-----	100	187	Average
2426	100.24	106.13	-5.89	-----	-----	100	187	Peak
2480	97.34	103.04	-5.7	-----	-----	100	187	Average
2480	98.41	104.11	-5.7	-----	-----	100	187	Peak
2483.5	35.79	41.49	-5.7	54	-18.21	100	187	Average
2483.5	50.32	56.02	-5.7	74	-23.68	100	187	Peak
4804	38.81	54.45	-15.64	54	-15.19	154	284	Average
4804	43.01	58.65	-15.64	74	-30.99	154	284	Peak
7206	49.91	58.47	-8.56	54	-4.09	154	284	Average
7206	57.63	66.19	-8.56	74	-16.37	154	284	Peak
Antenna Polarity & Test Distance: Vertical at 3 m								
Frequency (MHz)	Emission Level (dBuV/m)	Read Level (dBuV)	Factor (dB/m)	Limit (dBuV/m)	Margin (dB)	Antenna Height (cm)	Table Angle (Degree)	Remark
2390	36.29	42.21	-5.92	54	-17.71	182	288	Average
2390	46.22	52.14	-5.92	74	-27.78	182	288	Peak
2402	94.13	62.55	31.58	-----	-----	182	288	Average
2402	95.04	63.46	31.58	-----	-----	182	288	Peak
2426	93.09	61.52	31.57	-----	-----	182	288	Average
2426	93.97	62.4	31.57	-----	-----	182	288	Peak
2480	92.1	60.48	31.62	-----	-----	182	288	Average
2480	93.24	61.62	31.62	-----	-----	182	288	Peak
2483.5	35.48	41.18	-5.7	54	-18.52	182	288	Average
2483.5	45.55	51.25	-5.7	74	-28.45	182	288	Peak
4804	40.61	56.25	-15.64	54	-13.39	172	221	Average
4804	45.03	60.67	-15.64	74	-28.97	172	221	Peak
7206	46.06	54.62	-8.56	54	-7.94	172	221	Average
7206	52.91	61.47	-8.56	74	-21.09	172	221	Peak

Remarks:

- Emission Level = Read Level + Factor
Margin value = Emission level – Limit value
- 2402 MHz: Fundamental frequency.
- The emission levels of other frequencies were very low against the limit.

BT LE + NFC +RFID:

EUT Test Condition		Measurement Detail	
Input Power	120 Vac, 60 Hz	Frequency Range	0.009 ~ 30 MHz
Environmental Conditions	25 deg. C, 65 % RH	Detector Function	Average Quasi-Peak
Tested By	Tim Chen		

Antenna Polarity & Test Distance: Parallel at 3 m								
Frequency (MHz)	Emission Level (dBuV/m)	Read Level (dBuV)	Factor (dB/m)	Limit (dBuV/m)	Margin (dB)	Antenna Height (cm)	Table Angle (Degree)	Remark
0.12974	70.86	57.17	13.69	105.34	-34.48	100	0	Average
0.25948	33.24	24.62	8.62	99.32	-66.08	100	0	Average
0.38922	38.05	32.26	5.79	95.8	-57.75	100	0	Average
13.56	51.17	55.08	-3.91	69.54	-18.37	100	0	QP
22.322	33.68	38.34	-4.66	69.54	-35.86	100	0	QP
27.12	26.88	30.52	-3.64	69.54	-42.66	100	0	QP
Antenna Polarity & Test Distance: Perpendicular at 3 m								
Frequency (MHz)	Emission Level (dBuV/m)	Read Level (dBuV)	Factor (dB/m)	Limit (dBuV/m)	Margin (dB)	Antenna Height (cm)	Table Angle (Degree)	Remark
0.12974	64.58	50.89	13.69	105.34	-40.76	100	0	Average
0.25948	31.29	22.67	8.62	99.32	-68.03	100	0	Average
0.38922	35.86	30.07	5.79	95.8	-59.94	100	0	Average
13.56	47.93	51.84	-3.91	69.54	-21.61	100	0	QP
21.752	36.27	41.11	-4.84	69.54	-33.27	100	0	QP
27.12	26.28	29.92	-3.64	69.54	-43.26	100	0	QP
Antenna Polarity & Test Distance: Ground-parallel at 3 m								
Frequency (MHz)	Emission Level (dBuV/m)	Read Level (dBuV)	Factor (dB/m)	Limit (dBuV/m)	Margin (dB)	Antenna Height (cm)	Table Angle (Degree)	Remark
0.12974	55.04	41.35	13.69	105.34	-50.3	100	0	Average
0.25948	30.25	21.63	8.62	99.32	-69.07	100	0	Average
0.38922	34.97	29.18	5.79	95.8	-60.83	100	0	Average
13.56	39.36	43.27	-3.91	69.54	-30.18	100	0	QP
22.172	38.21	42.92	-4.71	69.54	-31.33	100	0	QP
27.12	22.64	26.28	-3.64	69.54	-46.9	100	0	QP

Remarks:

1. Emission level (dBuV/m) = Raw Value (dBuV) + Factor (dB/m)
2. The other emission levels were very low against the limit.
3. Margin value = Emission level – Limit value.
4. Above limits have been translated by the formula

Below 1GHz data

BT LE + NFC +RFID:

EUT Test Condition		Measurement Detail	
Channel	Channel 0	Frequency Range	30 MHz ~ 1 GHz
Input Power	120 Vac, 60 Hz	Detector Function	Peak (PK) Quasi-peak (QP)
Environmental Conditions	25 deg. C, 65 % RH	Tested By	Tim Chen

Horizontal

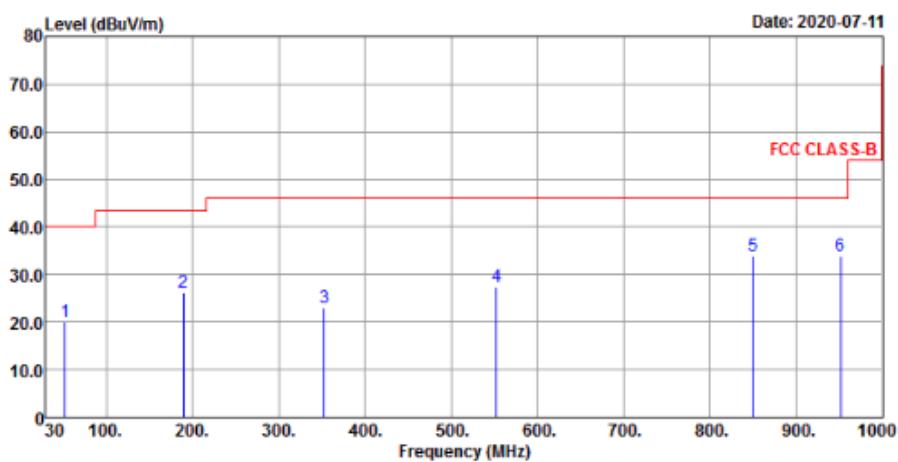

Vertical

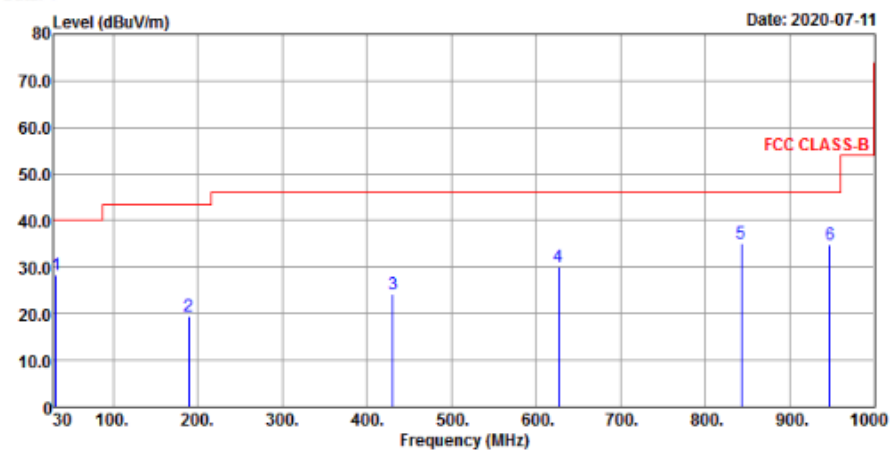

Antenna Polarity & Test Distance: Horizontal at 3 m								
Frequency (MHz)	Emission Level (dBuV/m)	Read Level (dBuV)	Factor (dB/m)	Limit (dBuV/m)	Margin (dB)	Antenna Height (cm)	Table Angle (Degree)	Remark
52.31	20.14	31.96	-11.82	40	-19.86	173	332	Peak
189.84	26.42	40.99	-14.57	43.5	-17.08	113	303	Peak
353.01	23.12	32.79	-9.67	46	-22.88	156	194	Peak
552.83	27.51	31.89	-4.38	46	-18.49	112	86	Peak
850.62	34.05	31.6	2.45	46	-11.95	124	73	Peak
951.5	34.03	30.34	3.69	46	-11.97	139	113	Peak
Antenna Polarity & Test Distance: Vertical at 3 m								
Frequency (MHz)	Emission Level (dBuV/m)	Read Level (dBuV)	Factor (dB/m)	Limit (dBuV/m)	Margin (dB)	Antenna Height (cm)	Table Angle (Degree)	Remark
32.91	28.21	41.16	-12.95	40	-11.79	137	273	Peak
189.84	19.35	33.92	-14.57	43.5	-24.15	123	319	Peak
430.61	24.18	31.25	-7.07	46	-21.82	121	198	Peak
626.55	30.13	31.99	-1.86	46	-15.87	146	91	Peak
842.86	35.04	32.64	2.4	46	-10.96	103	165	Peak
947.62	34.88	31.21	3.67	46	-11.12	155	99	Peak

Remarks:

- Emission Level = Read Level + Factor
Margin value = Emission level – Limit value
- The emission levels of other frequencies were very low against the limit.

5 Pictures of Test Arrangements

Please refer to the attached file (Test Setup Photo).

Appendix – Information of the Testing Laboratories

We, Bureau Veritas Consumer Products Services (H.K.) Ltd., Taoyuan Branch, were founded in 1988 to provide our best service in EMC, Radio, Telecom and Safety consultation. Our laboratories are FCC recognized accredited test firms and accredited and approved according to ISO/IEC 17025.

If you have any comments, please feel free to contact us at the following:

Lin Kou EMC/RF Lab

Tel: 886-2-26052180

Fax: 886-2-26051924

Hsin Chu EMC/RF/Telecom Lab

Tel: 886-3-6668565

Fax: 886-3-6668323

Hwa Ya EMC/RF/Safety

Tel: 886-3-3183232

Fax: 886-3-3270892

Email: service.adt@tw.bureauveritas.com

Web Site: www.bureauveritas-adt.com

The address and road map of all our labs can be found in our web site also.

--- END ---