

FUNMAT PRO 410 3D PRINTER

User Manual

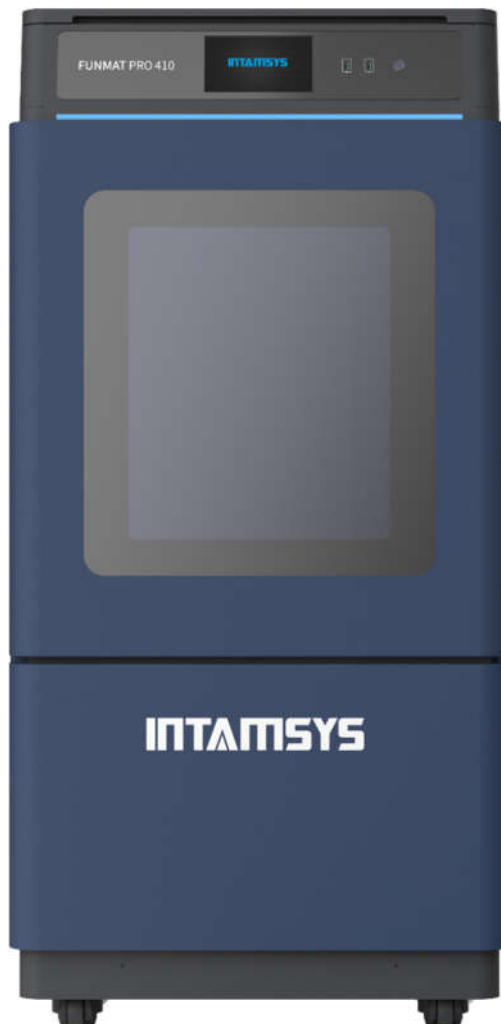

ONTENTS

1 SERVICE AND SUPPORT	1
1.1 SERVICE	1
1.2 SAFETY INSTRUCTIONS.....	1
1.2.1 CLASSIFICATION OF HAZARDS	1
1.2.2 POTENTIAL SAFETY HAZARD AREA.....	2
1.3 DOOR LOCK.....	2
1.4 ENVIRONMENTAL REQUIREMENTS	3
2 SETUP AND INSTALLATION.....	5
2.1 GENERAL INFORMATION.....	5
2.1.1 ATTACHMENT TOOLS.....	5
2.1.2 WORKING SPACE REQUIREMENTS.....	5
2.1.3 INSPECTION OF THE PRINTER'S NAMEPLATE	5
2.2 MACHINE PREPARATION	6
2.2.1 REMOVE PACKAGE	6
2.2.2 TAKE OUT THE ACCESSORIES.....	7
2.2.3 RELEASE THE FIXATION OF XY AXIS.....	8
2.2.4 ADD LIQUID COOLANT	8
2.2.5 INSTALL THE PRINTING BUILDPLATE.....	9
3 SYSTEM COMPONENTS	11
3.1 OVERVIEW OF THE PRINTER.....	11
3.2 TOP DOOR SUBASSEMBLY	12
3.3 PRINTING CHAMBER SUBASSEMBLY.....	13
3.4 MATERIAL CHAMBER SUBASSEMBLY	13
3.5 PRINTING HEAD SUBASSEMBLY.....	14
3.6 XY AXIS SUBASSEMBLY.....	15
3.7 Z AXIS SUBASSEMBLY	16
3.8 CASTERS	16
4 USER INTERFACE	17

4.1 OVERVIEW	18
4.1.1 STATUS BAR.....	19
4.1.2 NAVIGATION BAR.....	21
4.1.3 DISPLAY AREA.....	21
4.2 PRINT INTERFACE	21
4.2.1 MAIN STATE AREA.....	22
4.2.2 AUXILIARY STATE AREA	23
4.2.3 CONTROL AREA.....	24
4.3 TUNING INTERFACE.....	26
4.4 INCHING INTERFACE.....	26
4.5 MATERIAL INTERFACE	27
4.5.1 NOZZLE SETTING AREA.....	28
4.5.1 MATERIAL MANAGEMENT INTERFACE	28
4.6 SYSTEM INTERFACE	29
4.7 OTHER INTERFACES.....	31
4.7.1 REMOTE PRINTING INTERFACE	31
4.7.2 WIRED NETWORK IP SETTING INTERFACE	31
4.7.3 WIRELESS NETWORK IP SETTING INTERFACE	32
5 PRINTER OPERATION.....	36
5.1 BASIC USER OPERATIONS.....	36
5.1.1 POWER ON THE PRINTER.....	36
5.1.2 POWER OFF THE PRINTER	37
5.2 MATERIAL, MATERIAL CHAMBER AND NOZZLE.....	37
5.2.1 MATERIAL LOADING.....	37
5.2.2 MATERIAL UNLOADING	39
5.2.3 MATERIAL EDITING.....	40
5.3 REPLACEMENT OF NOZZLE OR MATERIAL	41
5.3.1 REPLACEMENT OF NOZZLE.....	41
5.3.2 MATERIAL CHANGE BEFORE PRINTING	42
5.3.3 PAUSE TO CHANGE MATERIAL	43
5.3.4 REPLENISH MATERIAL AFTER STARVED FEEDING ALARM	43
5.4 BASIC PRINTING OPERATIONS.....	43
5.4.1 PREPARE THE PRINTER	43
5.4.2 IMPORT THE PRINT FILE INTO THE PRINTER.....	44

5.4.3 LOAD THE PRINT FILE	45
5.4.4 PRINTING PROCESS	46
5.4.5 SETTING OF PRINTING PARAMETERS.....	47
5.4.6 PRINTING ALARM	47
5.4.7 PAUSE THE PRINTING	48
5.4.8 CEASE THE PRINTING	48
5.4.9 AFTER THE COMPLETION OF PRINTING	48
5.5 CHANGE DEFAULT SETTINGS OF THE PRINTER.....	49
5.5.1 CHANGE THE SYSTEM DATE AND TIME.....	49
5.5.2 ENABLE/DISABLE THE FUNCTION OF ALLOWING NETWORK REMOTE ACCESS	50
5.5.3 ENABLE/DISABLE WIFI AUTO-RECONNECT.....	50
5.5.4 ENABLE/DISABLE DEVELOPER MODE	50
5.5.5 ENABLE/DISABLE USB PRINTING MODE.....	50
5.5.6 LOCK THE FRONT DOOR AND CAP	51
5.5.7 LIQUID COOLER CONTROL	52
5.5.8 ENABLE MOTOR.....	52
5.6 PRINTER STATE.....	53
5.6.1 TEMPERATURE AND HUMIDITY STATE.....	53
5.6.2 MATERIAL STATE	53
5.6.4 STATE OF LIQUID COOLING SYSTEM	54
5.6.4 SOFTWARE VERSION	54
<u>6 LEVELING AND CALIBRATION</u>	<u>55</u>
6.1 MANUAL LEVELING AND XYZ CALIBRATION	55
6.1.1 MANUAL LEVELING	56
6.1.2 Z CALIBRATION.....	56
6.1.3 XY CALIBRATION	57
6.2 AUTO LEVELING AND XYZ CALIBRATION.....	59
6.2.1 AUTO LEVELING.....	60
6.2.2 Z CALIBRATION.....	61
6.2.3 XY CALIBRATION	61
6.3 CALIBRATION OF MATERIAL WEIGHT	61
6.4 CALIBRATION OF THE CLAMP FORCE OF EXTRUDER.....	62
<u>7 MAINTENANCE.....</u>	<u>65</u>

7.1 INSPECTIONS BEFORE EACH PRINT	65
7.1.1 INSPECT THE PRINTING BUILDPLATE	65
7.1.2 EMPTY THE PRINTING CHAMBER	65
7.1.3 INSPECT NOZZLES	65
7.2 MAINTENANCE AFTER EACH PRINT	65
7.2.1 CLEAN THE GLASS BUILDPLATE	65
7.2.2 CLEAN AND REPLACE THE NOZZLE BRUSH.....	65
7.2.3 CLEAN THE CHAMBER	66
7.2.4 CLEAN THE NOZZLE	66
7.3 PERIODIC MAINTENANCE	66
7.3.1 CLEANSING OF THE FEEDING GEAR OF EXTRUDER.....	66
7.3.2 MAINTENANCE OF MOVING PARTS	67
7.3.3 MAINTENANCE OF CHAMBER FILTER SCREEN	67
7.3.4 MAINTENANCE OF FEEDING PIPE AND COOLING PIPE	67
7.3.5 LIQUID COOLANT	68
7.4 OTHERS	68
<u>8 TROUBLESHOOTING</u>	<u>69</u>

1 Service and Support

The information in terms of service and support for FUNMAT PRO 410, as well as the safety information and safety label position are provided in this chapter.

1.1 Service

Please contact INTAMSYS customer support for any problem not covered by this guide during your use of the printer.

Region	E-mail	Tel.
Asia Pacific	Support_APAC@intamsys.com	+86-21-5846 5932
Europe, Middle East and Africa	Support_EMEA@intamsys.com	+86-21-5846 5932
North America / Latin America	Support_America@intamsys.com	+86-21-5846 5932

1.2 Safety Instructions

Following basic safety instructions are provided to ensure the safe installation, operation and maintenance of INTAMSYS equipment, which shall not be regarded as the comprehensive safety problems. FUNMAT PRO 410 Printer is a safe and reliable 3D printer in industrial grade. There is potential hazard in the printer overhauling area.

1.2.1 Classification of hazards

It is recommended by INTAMSYS that all services should be executed by qualified personnel. All personnel operating the printer or near by the printer shall understand the meaning of following hazard classification used in this guide.

[HIGH VOLTAGE]: The sign of high voltage indicates the existence of high voltage. Be sure to keep away from exposed circuits. It is suggested to take off all accessories.



[HIGH TEMPERATURE]: It indicates that the equipment is in high temperature. Take extra care when working near by heated components. Be sure to wear the safety gloves provided in the attachment tools.

The temperature of printing nozzle in the printer can reach up to 500°C.

The temperature of printing buildplate in the printer can reach up to 160°C.

The temperature of chamber in the printer can reach up to 90°C.



[PINCH POINT]: It indicates that you may have a risk to pinch hand between two objects. There are one or multiple objects moving in your working area.



1.2.2 Potential safety hazard area

The following components and areas have been highlighted as having potential safety hazard. Failure to follow the safety procedure will cause system fault or problem in reliability.

- Nozzle

[HIGH TEMPERATURE] Warning: During the heating of nozzle, please be sure to wear the safety gloves when maintaining the nozzle or working in the chamber.

- Printing buildplate

[HIGH TEMPERATURE] Warning: During the heating of hot bed, please be sure to wear the safety gloves when taking off the buildplate glass or working in the chamber.

- Chamber

[HIGH TEMPERATURE] Warning: During the heating of chamber, please be sure to wear the safety gloves when working in the chamber.

- XY movement frame

[PINCH POINT] Warning: Do not wear tie, loose clothes or hanging ornament when working near by any moving component of the printer.

Take extra care when maintaining such moving components.

- Z-axis buildplate

[PINCH POINT] Warning: Do not wear tie, loose clothes or hanging ornament when working near by any moving component of the printer.

Don't put anything on the bottom of the chamber.

1.3 Door lock

The sensor is used to transmit the state of chamber front door and top door. For safety reason, the chamber front door and top door must be closed before the chamber is heated or the X/Y/Z motor starts working. The electromagnetic lock can ensure that the chamber door and cap are firmly closed when the printer is executing the printing operation.

1.4 Environmental Requirements

- The printer is for indoor use only.
- The condition of air quality with excessive solid particles (conductive or non-conductive) may cause damage to the system.
- The system operating temperature shall be kept between 15°C and 30°C (59°F to 86°F), and the relative humidity shall be kept between 30% and 70% (non-condensate).
- The system storage temperature shall be kept between 0°C and 35°C (32°F to 95°F), and the relative humidity shall be kept between 20% and 90% (non-condensate).

RISK OF FIRE
Install only on concrete
or other non-combustible floor

This equipment is not suitable for use in locations
where children are likely to be present.

- Please take attention that changes or modification not expressly approved by the party responsible for compliance could void the user's authority to operate the equipment.
- This device complies with Part 15 of the FCC Rules. Operation is subject to the following two conditions:
 - (1) This device may not cause harmful interference, and
 - (2) This device must accept any interference received, including interference that may cause undesired operation.
- This equipment complies with FCC radiation exposure limits set forth for an uncontrolled environment. This equipment should be installed and operated with minimum distance 20cm between the radiator & your body.
- This device complies with Industry Canada licence-exempt RSS standard(s). Operation is subject to the following two conditions:
 - (1) this device may not cause interference, and
 - (2) this device must accept any interference, including interference that may cause undesired operation of the device.
- Le présent appareil est conforme aux CNR d'Industrie Canada applicables aux appareils radioexempts de licence. L'exploitation est autorisée aux deux conditions suivantes :
 - (1) l'appareil ne doit pas produire de brouillage, et
 - (2) l'utilisateur de l'appareil doit accepter tout brouillage radioélectrique subi, même si le brouillage est susceptible d'en compromettre le fonctionnement.

1 SERVICE AND SUPPORT

- This equipment complies with FCC/IC RSS-102 radiation exposure limits set forth for an uncontrolled environment. This equipment should be installed and operated with minimum distance 20cm between the radiator & your body.
- ce matériel est conforme aux limites de dose d'exposition aux rayonnements, FCC / CNR-102 énoncée dans un autre environnement.cette eqipment devrait être installé et exploité avec distance minimale de 20 entre le radiateur et votre corps.

2 Setup and Installation

The basic setup and installation of FUNMAT PRO 410 are described in this chapter.

2.1 General Information

2.1.1 Attachment tools

Please check the attachment tools in the packing list. These attachment tools are the frequently used tools in printing and spare parts in maintenance of the printer.

2.1.2 Working space requirements

It is the guide for installation site preparation, which can ensure the efficient and safe preparation of related facilities to install the printer.

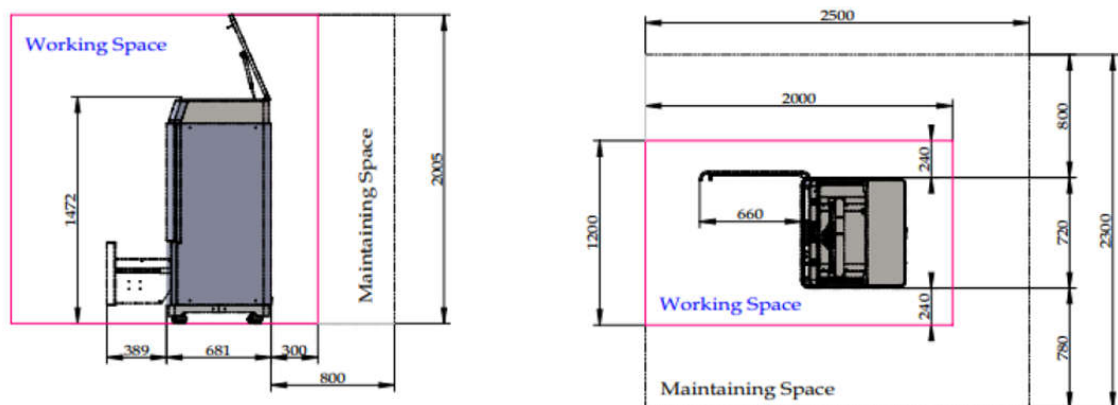

Figure 2.1 Space for installation and maintenance (Unit:mm)

2.1.3 Inspection of the printer's nameplate

Identify your printer by following figure.

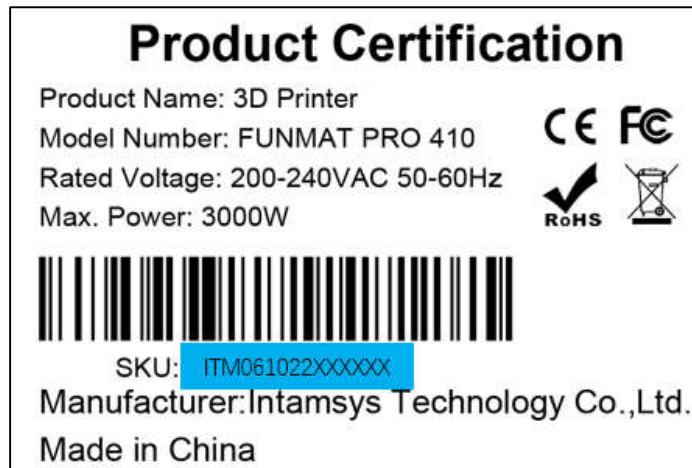

Figure 2.2 Printer nameplate

Model designation: It lists the product name, the model number and power requirement of the printer. The nameplate also lists the related certification information and the company information of INTAMSYS.

Serial number: It lists the serial number of the printer, which will be provided to agent or INTAMSYS for requesting services, so that the service personnel can quickly identify the configuration of your printer.

2.2 Machine Preparation

2.2.1 Remove package

- Step 1: Please remove the screws on wooden case with wrench having a 8mm sleeve. Remove the packing cases on the top and around, and take off the fixing band, foam and packaging film on the printer;
- Step 2: Take out the wooden plate placed at the bottom of the printer, and fix it as two slope structures with cross screwdriver. Based on the printer's wheel span, place the slope structures close to the printer's bottom tray, and make them closely contact with the tray;
- Step 3: There are four casters installed at the bottom of the machine. Clockwise rotate the knobs above the casters to make the casters in movable state, and push the machine slowly onto floor along the slope. Where any caster is too tight to be rotated by fingers, the spanner in packing case may be used to help rotating (the spanner is in accessory box);
- Step 4: In the process of printing, the movement of the printer's XY axis in high speed causes vibration of machine, thus impacting the printing quality. To avoid the impact of machine vibration on printing quality, please be sure to lock the 4 casters at the bottom of the printer. Anticlockwise rotate the knobs above the casters to make the casters in fixed state.

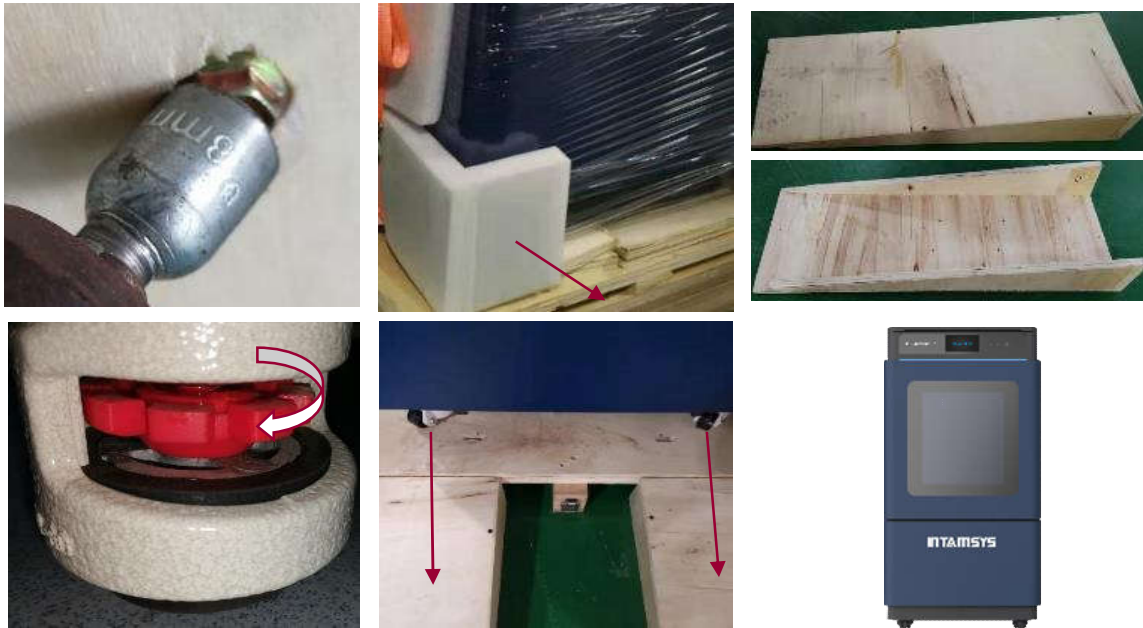

Figure 2.3 Diagram for package removal

2.2.2 Take out the accessories

- Step 1: Connect the power cable to the power socket on the back of the printer, and then turn on the power switch besides the power socket to make the power switch in ON (I) position;
- Step 2: Press the round start button on the right of the panel. Turn to the screensaver mode after the machine is started up. Click any place on the screen to quit the screensaver mode.



Figure 2.4 Power switch and startup button

- Step 3: The accessory box is under the printing buildplate in the chamber. Click "Axis" button to enter into the interface, and then click "Home Z". After the printing buildplate rises, all accessory boxes can be taken out.

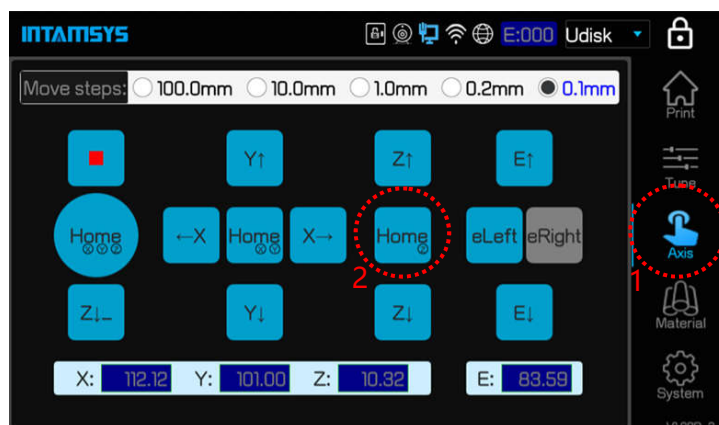

Figure 2.5 Power switch and startup button

2.2.3 Release the fixation of XY axis

- Step 1: Press the round start button on the right of the panel to shut down the printer. Gently pull the right side of the front door, open the printer's front door, and then open the top door upwards;
- Step 2: The fixed block on X axis guideway is used for ensuring the steadiness of the nozzle device during transportation. Unscrew the two bolts on the fixed block with a 4mm socket head wrench (the socket head wrench is placed in the accessory box) to take off the X axis fixed block;
- Step 3: On the linear guideway on the left side, upwards drag the buckle to take out the Y axis left fixed block;
- Step 4: In power-off state, gently push the printing head towards the left on X axis direction to leave sufficient operating space, and take out the Y axis right fixed block by same method.

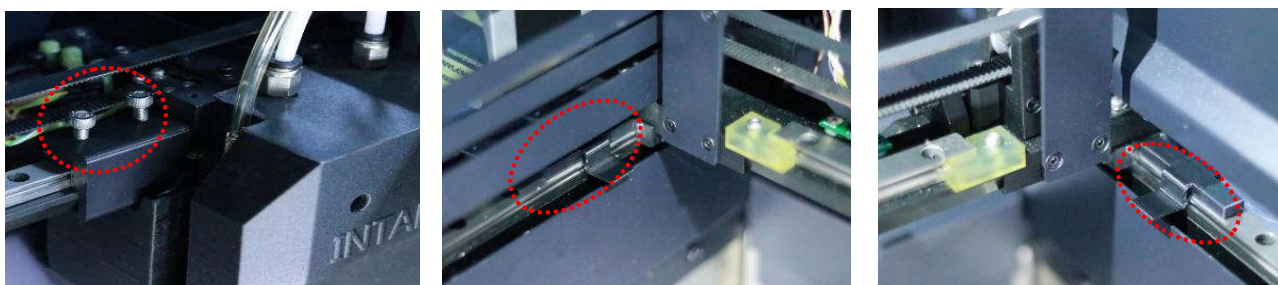

Figure 2.6 Positions of fixed blocks on XY axis

2.2.4 Add liquid coolant

- Step 1: Remove the charge coverplate on the back of the machine with 2mm socket head wrench (the 2mm socket head wrench is placed in the accessory box).
- Step 2: It can be seen that one end of the charge pipe is fixed on a support by the buckle. Press the buckle to pull out one end of the liquid adding pipe.
- Step 3: Unscrew the screw cap of charge pipe and insert funnel (the funnel is in the spare accessory box). There is a scale observation window on the left side of the charging inlet. Inject 750~950ml of liquid coolant via the funnel (it is suggested to add water-free liquid coolant for automobile engine to reduce the erosion and the generation of incrustation, and colored liquid coolant is

recommended for easier observation).

Step 4: After charging, screw down the screw cap of charge pipe, put the charge pipe back and install the coverplate.



Figure 2.7 Position of charging inlet and method to charge

2.2.5 Install the printing buildplate

Step 1: In the "Axis" interface, click the key "Home XYZ".

Step 2: Select the option "100.0mm" in the "Move steps" above, then click "Z↓" (no more than 3 times) and adjust the printing buildplate to a position convenient for the installation of printing buildplate.

Step 3: Install the printing buildplate according to the direction as shown on the label on printing buildplate, make the four magnet blocks on the glass be placed into the corresponding magnet holes, and gently press the four magnet blocks with hand to confirm the magnet blocks are fully placed in the magnet holes.

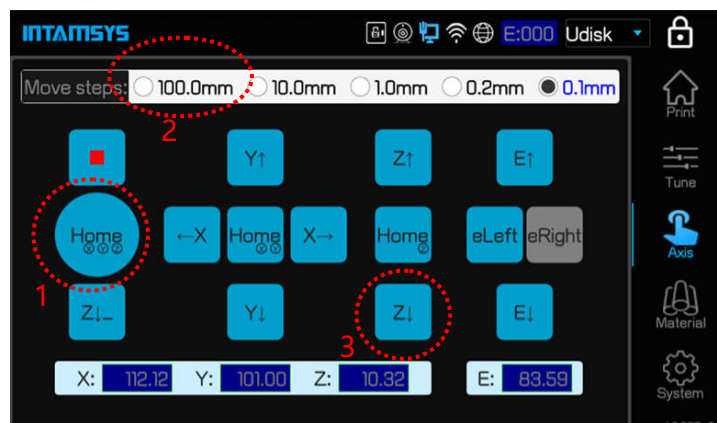

Figure 2.8 Buildplate descending method

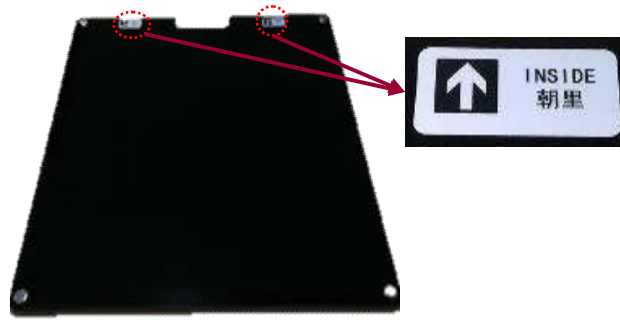

Figure 2.9 Buildplate glass installation direction

3 System Components

The system components of FUNMATPRO 410 are described in this chapter, to help users better understanding the composition principle of the printer, and knowing about the functions of each part.

3.1 Overview of the Printer

The visible parts of the printer from appearance are shown as following figure. Among them, the right lateral plate, left lateral plate, and back lateral plate are all dismantlable, which are used for the maintenance of internal components; the top door and front door shall be in closed state and be locked by electromagnetic lock in the process of printing; the material chamber can be seen by opening the lower door, which is opened by "pushing and bouncing".

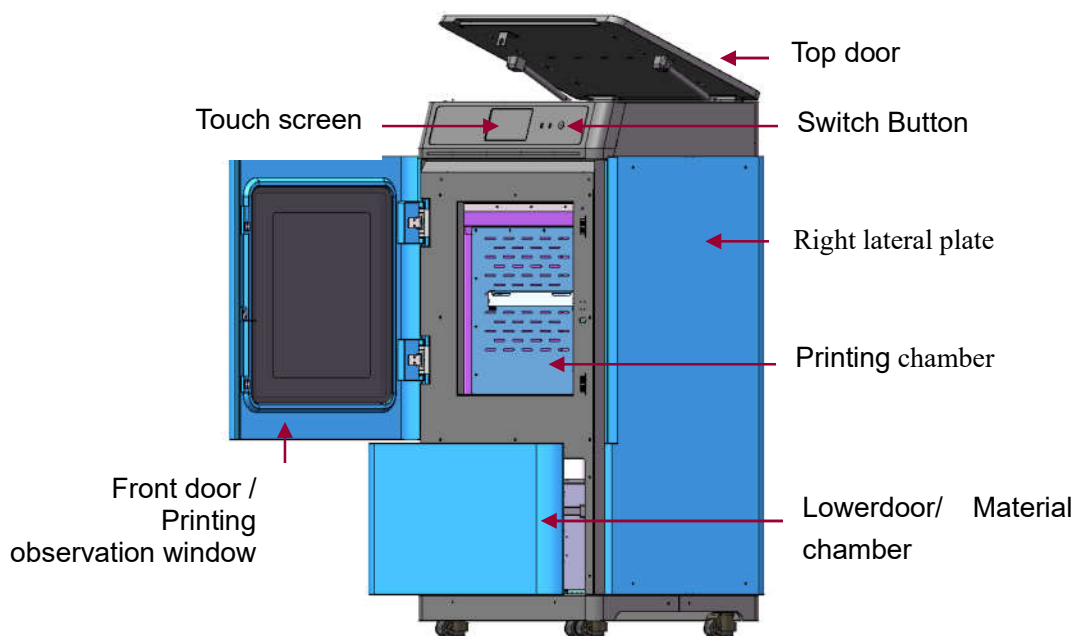

Figure 3.1 Front view of the printer

3 SYSTEM COMPONENTS

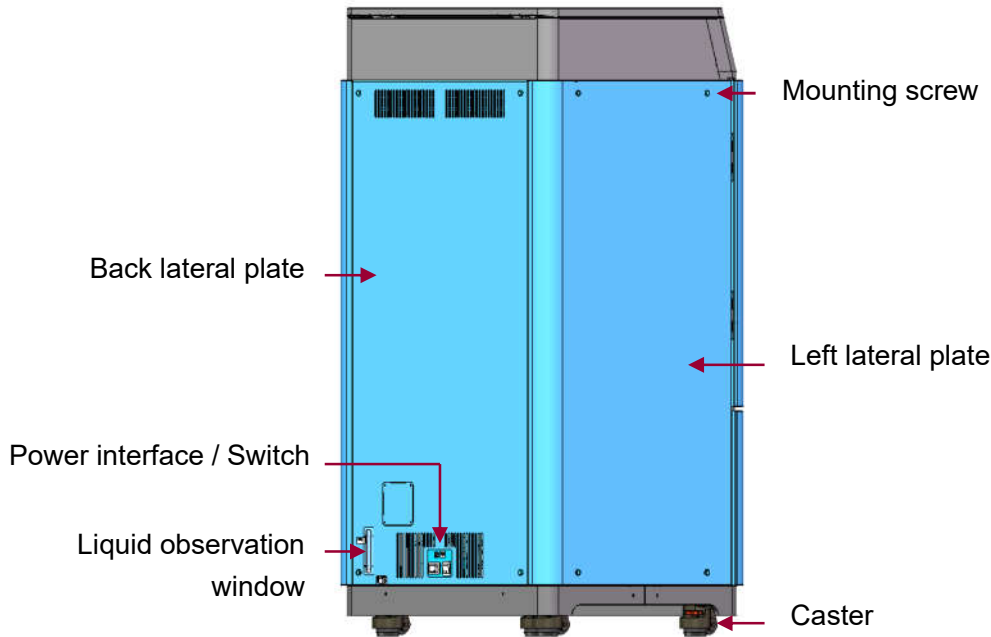

Figure 3.2 Rear view of the printer

3.2 Top Door Subassembly

By pushing up the top door, the printing state can be observed, and it is also convenient for the maintenance of XY rack and printing head component.

Release the electromagnetic lock to push up the top door, where the top door is supported by air spring. Where the opening angle is greater than the critical angle, the support moment of air spring will be greater than the gravity moment of the top door, which can keep the top door in its opening position. Where the opening angle of the top door is less than the critical angle, the air spring does not have sufficient support moment yet, and the top door will fall down freely. Therefore, when opening the top door, please note to not release your hand when the door opening angle is less than the critical angle, and release hand when you feel the top door is supported by sufficient force from the air spring.

The user interaction area is under the top door, including the touch screen, USB interface, button switch. Users can control the printed piece and obtain the information about machine state through the touch screen. The USB on the left side is only used for printing via computer.

The USB on the right side is used for printing by plugging in USB flash disk. The button switch is used for normal switching on and off, and emergency shutdown.

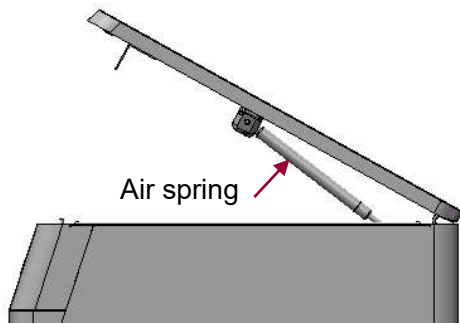

Figure 3.3 Diagram for top door opening angle

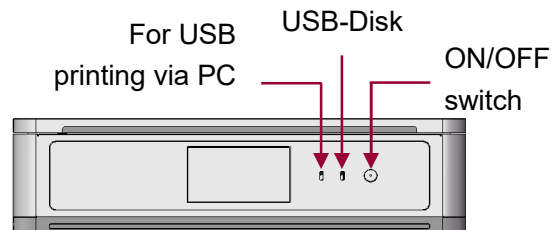

Figure 3.4 Diagram for user operating Area

3.3 Printing Chamber Subassembly

The front door can be pulled out from the right side through releasing the electromagnetic lock by screen operation, and then it can be seen that following components are included in the printing chamber: front door, hot bed, dual nozzle component, brass wire brush, electromagnetic lock, magnet, door sensor, heating and heat maintaining component, etc.

When the printing chamber is heating, please do not touch the stainless steel bottom plate and lateral plates to avoid scald as they are in high temperature.

The four leveling rotary knobs under the hot bed are used for the manual leveling of the printing buildplate.

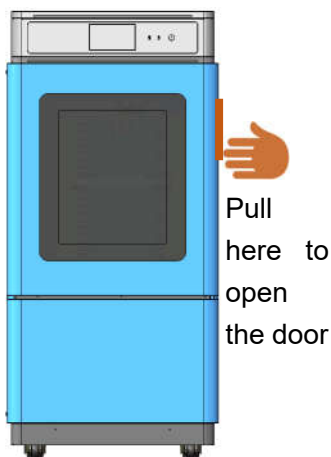

Figure 3.5 Diagram for front door opening mode

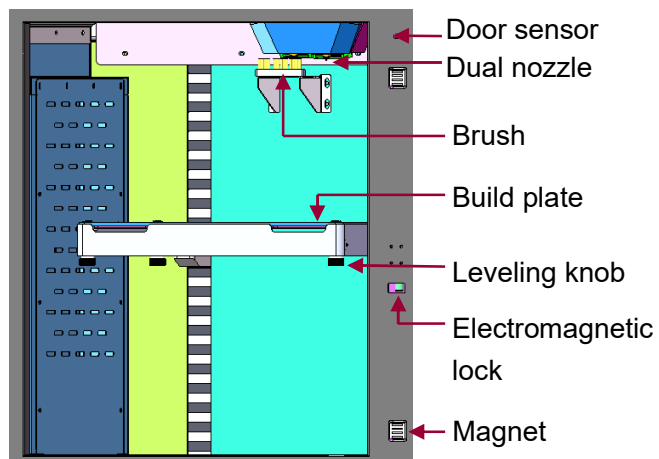

Figure 3.6 Printing chamber

3.4 Material Chamber Subassembly

The material chamber contains two material rolls on the right and left, of which normally model materials are installed on left material roll and the support materials are installed on the right material roll. There is

3 SYSTEM COMPONENTS

weight sensor on each material roll. An alarm will be given on the screen when the weight of materials are lower than the materials required by printing. There is heating device in the material chamber, which can be used for auxiliary drying of material chamber, and the maximum temperature of material chamber can reach up to 70°C. To ensure the dryness of materials, the slide door of material chamber shall be kept in closed state all the time. The sliding door are held closed by magnetic force when it is in closed state. To replace materials or do troubleshooting, the sliding door can be opened by pushing it forward slightly, and the light will be enabled automatically with the opening of chamber.

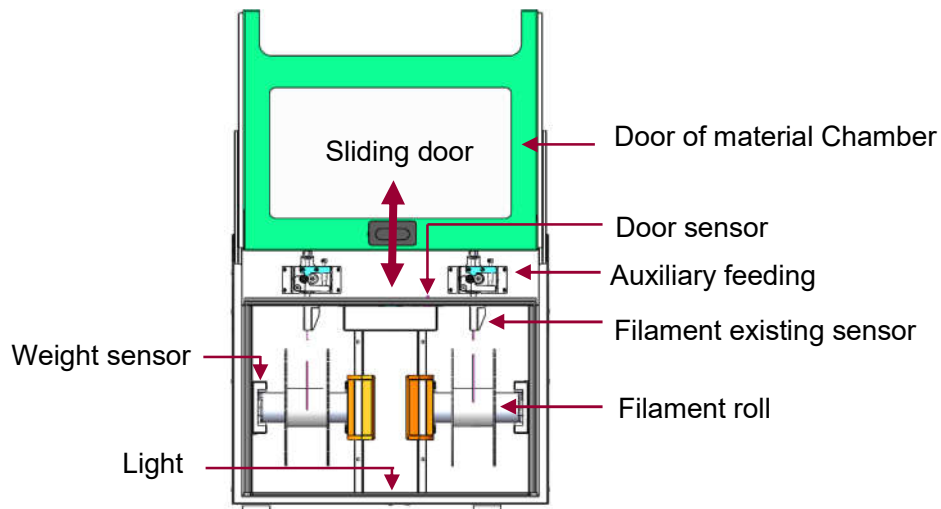

Figure 3.7 Material chamber

3.5 Printing Head Subassembly

The printing head subassembly is used for fusing wire, and forming the required model on the printing glass plate in combination with the movement of XYZ axis. The subassembly contains two nozzles, of which the left nozzle is used to print model material and the right nozzle is used to print support material in normal cases. The left and right nozzle can be switched by the up and down movement of the right nozzle, and only one nozzle will execute the printing at one time.

There is also feeding state monitoring sensors (each one on the left and right respectively) on the printing head subassembly, which will alarm for abnormal material feeding. Refer to Chapter 5 for the loading and unloading of materials.

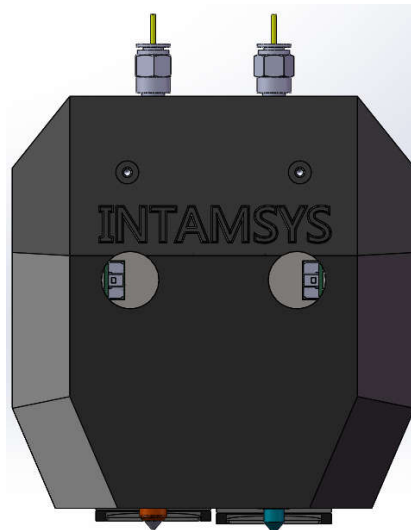

Figure 3.8 Nozzle subassembly

3.6 XY Axis Subassembly

The XY axis subassembly drives the dual nozzle extruder to move within the XY plane as instructed. Both X axis and Y axis are driven by synchronous belt, which does not require further adjustment as its tensile force has been adjusted to a suitable state when the machine leaves the factory. After a certain period of use, the obvious reduction of printing quality may be caused by the looseness of synchronous belts for various reasons. In that case, remove the left and right lateral plate of the machine to inspect the left and right synchronous belt of Y axis for their tensile force, and open the top door to inspect the synchronous belt of X axis for its tensile force. In case of too low tensile force on any one synchronous belt, such synchronous belt may be adjusted by the method as shown in following figure. The left and right synchronous belt of Y axis shall be kept in consistent tensile force.

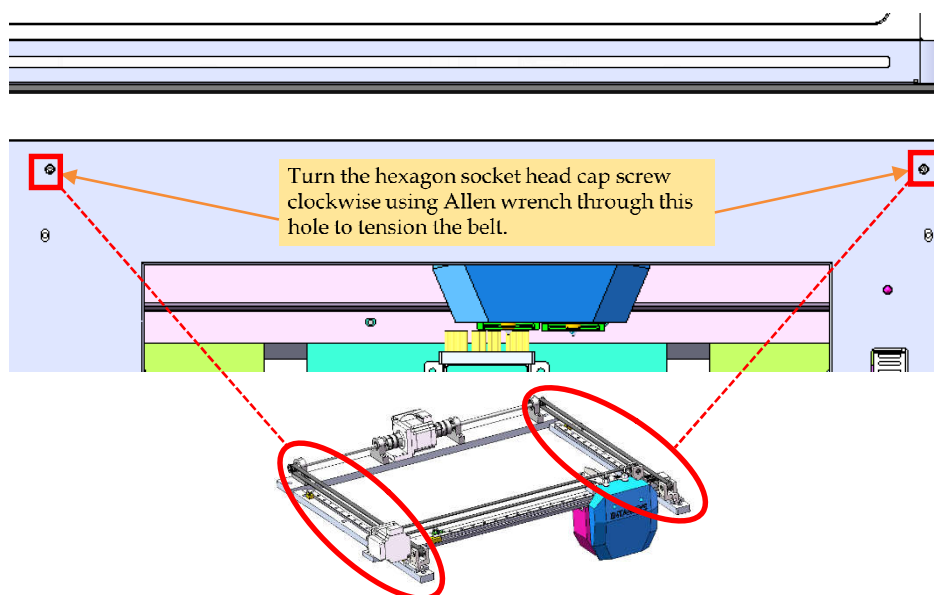

Figure 3.9 Adjustment of tensile force of synchronous belts on Y axis

3 SYSTEM COMPONENTS

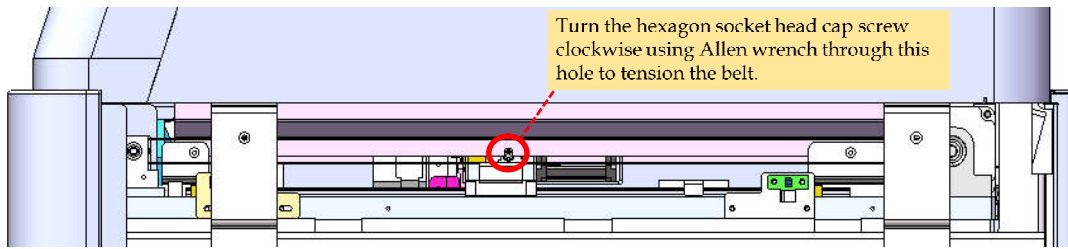

Figure 3.10 Adjustment of tensile force of synchronous belt on X axis

3.7 Z Axis Subassembly

Z axis subassembly drive the hot bed to move up and down. Z axis subassembly can be maintained by removing the rear lateral plate.

The trigger plate of photoelectric sensor has been in its position, no further adjustment by user is required. Only when there is any problem in manual leveling of the hot bed, users may be required to inspect and adjust the position of the trigger plate. Upward adjustment of the trigger plate of photoelectric sensor can make the zero point of hot bed move downwards, and downward adjustment of the trigger plate of photoelectric sensor can make the zero point of hot bed move upwards.

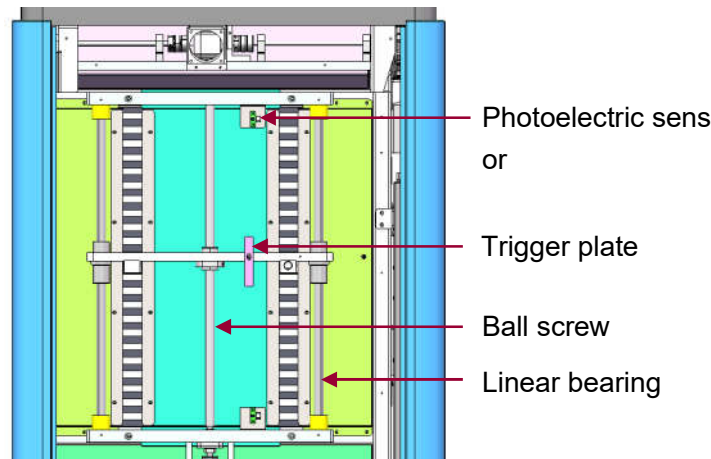

Figure 3.11 Z Axis subassembly

3.8 Casters and Skirt plate

There are 4 casters under the machine, which are used for the short-distance movement in door and the adjustment of orientation. They shall not be used for long-distance movement out door, otherwise the casters may be damaged.

Clockwise turn the casters to make them in movable state, and anticlockwise turn the casters to make them in locked state. After the placement position of the printer is confirmed, the casters shall be kept in locked state, otherwise the printing quality may be impacted.

During long-distance transportation, the printer shall be placed on support plate first before being transported by forklift. Be sure not to transport the printer by forklift directly, otherwise the bottom of the printer may be damaged.

If the printer is to be transported directly by forklift, 2 Skirt plates must be removed first as shown in following figure.

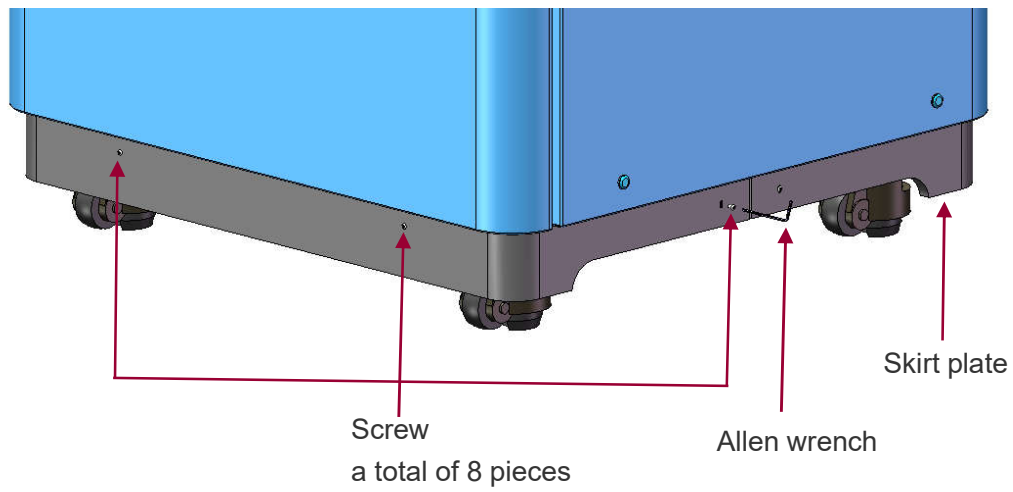

Each skirt is fixed with four screws.

Unscrew all these 8 screws using Allen wrench, and then take off skirt plates.

Figure 3.12 Remove Skirt Plate

4 User Interface

4.1 Overview

The main User Interface (UI) of FUNMAT PRO 410 is summarized in this chapter. See Chapter 5 Operation of the Printer for specific information about the printer operation and programs. The printer must be powered on before the use of touch screen.

FUNMAT PRO 410 User Interface is composed of the touch screen in the middle of the printer's front side. The main interface of such touch screen contains three main functional areas.



Figure 4. 1 Overview of user interface

FUNMAT PRO 410 is equipped with IPS hard screen, whose visual angle can reach up to 170 degrees. Within the range of visual angle, the contents displayed on the screen can be viewed clearly. But it is still suggested to stand in front of the touch screen for easier operation.

Following operations can be performed through the screen Navigation Bar:

- “Print” for normal printing of documents, preheating, heat maintaining settings; progress display, temperature display, etc.
- “Tune” for setting of parameters related to printing when printing or standing by
- “Axis” for inching operation of each movement axis and extruder of the printer
- “Material” for loading and unloading, leveling, material management and other operations related to specific materials
- “System” for view of system parameters and related system settings

Following operations can be performed by clicking the Status Bar:

- INTAMSYS information inquiry (logo icon)
- Door opening and closing operation (door lock icon)
- Camera display (camera icon)

- Ethernet configuration (wired network connection icon)
- Wifi configuration (wireless network icon)
- Remote printing service configuration (globe icon)
- Error diagnosis (E:000)
- Selection of printing data (combo box)
- Screen lock (lock icon)

4.1.1 Status bar

The status bar is on the top of the touch screen display, appearing on each page of the user interface. Various information are displayed in the information bar, including the INTAMSYS logo, system status indicator, network state indicator, error state indicator, display of printing data source, etc.

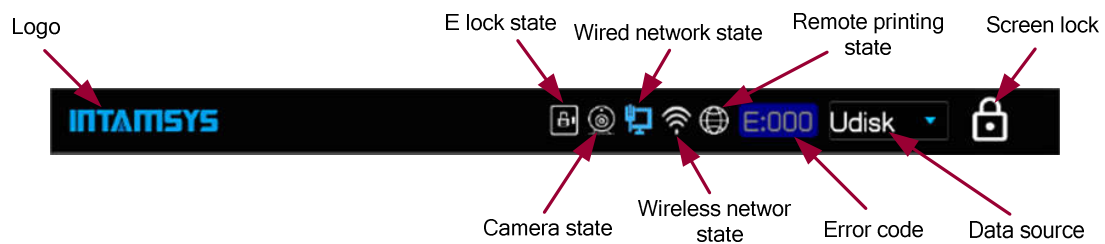























Figure 4. 2 Status bar

The display of status bar is shown as the figure, and meanwhile the objects in status bar may be clicked for operation.

Table 4.1 Icon State and Clicking Operation

Meaning of icon	Description and operation
Logo 	Click to turn to the page of INTAMSYS company profile, where the QR code, contact number and e-mail address are provided
E-lock state  E-lock unlocked  E-lock locked	Click to lock the e-lock when the e-lock is unlocked Click to unlock the e-lock when the e-lock is locked
Camera state  Camera disabled  Camera enabled	Click to disable the camera when the camera is enabled Click to enable the camera when the camera is disabled
Wired network state  No wired network access  Wired network access	Click to view and configure the IP address of wired network Only view of the wired network IP address is available when there is no wired network access
Wireless network state	Click to view and configure the IP address of wireless

4 USER INTERFACE

		network Only view of wireless network IP address is available when there is no wireless network access
Remote printing state		Grey icon indicates the disabled state of remote printing service Blue icon indicates the enabled state of remote printing service Rotating blue icon indicates there is remote user access currently Click the icon to turn to the remote printing service monitoring and configuration interface, and click again to close the interface
		
		
Error code		The error code background color indicates different severity Blue for normal Yellow for warning Orange for common error, the system will automatically cease the printing Red for serious error, the system will automatically cease the printing
		
		
Data source		
		Click the combo box to select data source SD for SD card Udisk for USB flash disk Ftp for file transfer directory Flash for internal memory
		
Screen lock		
		Click to lock the screen

In addition: The status bar will display an icon for insertion of SD card or UBS flash disk (state indication only, clicking unavailable).

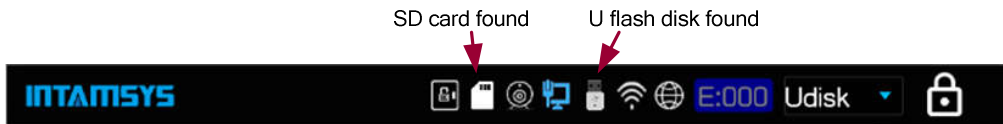

Figure 4. 3 Supplement 1 to status bar

The status bar will display an icon for insertion of mouse or keyboard (state indication only, clicking unavailable).

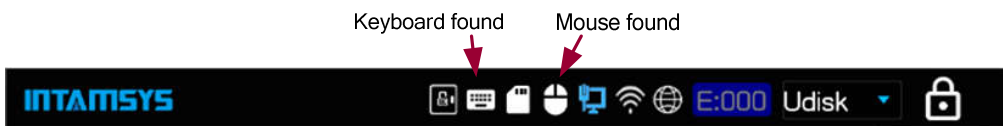

Figure 4. 4 Supplement 2 to status bar

4.1.2 Navigation bar

The navigation bar is displayed on each main page of the User Interface, providing the single touch access to the printer's function of "Print", "Tune", "Axis", "Material" and "System". The User Interface is decomposed to multiple pages containing the related functions. Selection of one button in the navigation bar will open the page corresponding to such button, where the relevant tasks in the page can be executed. Where a page contains sub-pages or wizard, the additional buttons corresponding to these items will be displayed in the display area of such page above the navigation bar.

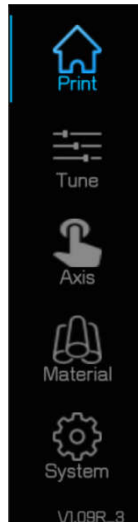

Figure 4. 5 Navigation bar

The buttons in the navigation bar are mutually exclusive, which means only one button can be selected in any given time. In some cases, all or part of the buttons in the navigation bar will be disabled.

4.1.3 Display area

The display area is used to display the relevant information corresponding to the functional module selected, including the operation button, text description, image display or motion graphics schematic, etc. When the user selects different functional module, the display area will be switched to the contents corresponding to the functional module selected.

- After the machine is powered on and started up, this area will display the contents corresponding to printing functional module as default.
- When the corresponding icon in navigation bar is selected, the area will be switched to the settings or display interface related to such state
- After the corresponding functional button in navigation bar is selected, the display area will be switched to the operation interface of the corresponding functional module.
- During the use of wizard, the display area will display the contents corresponding to different steps according to the operation sequence.

4.2 Print Interface

The "Print" page is composed of three main functional areas, which are the essential parts to select and execute model printing on the printer. In the "Print" page, you may choose to print documents, start, pause

4 USER INTERFACE

or cease the printing, understand how the documents selected to print matches with current configuration of the printer, and view the progress of current printing task and the estimated time remaining. To access the “Print” page, press the “Print” button in the navigation bar.

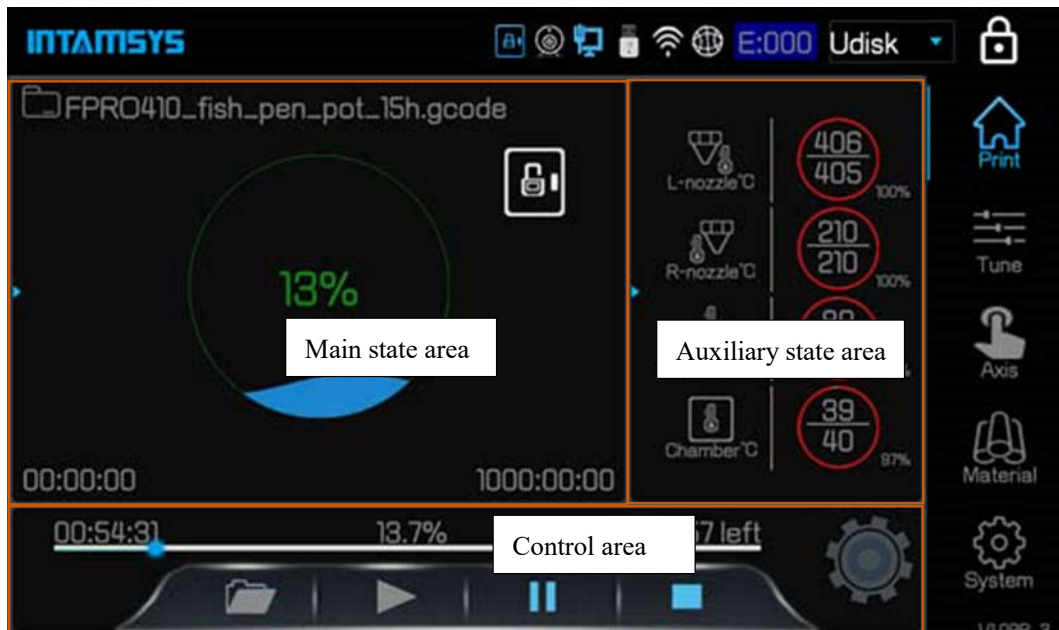

Figure 4. 6 Print page

4.2.1 Main state area

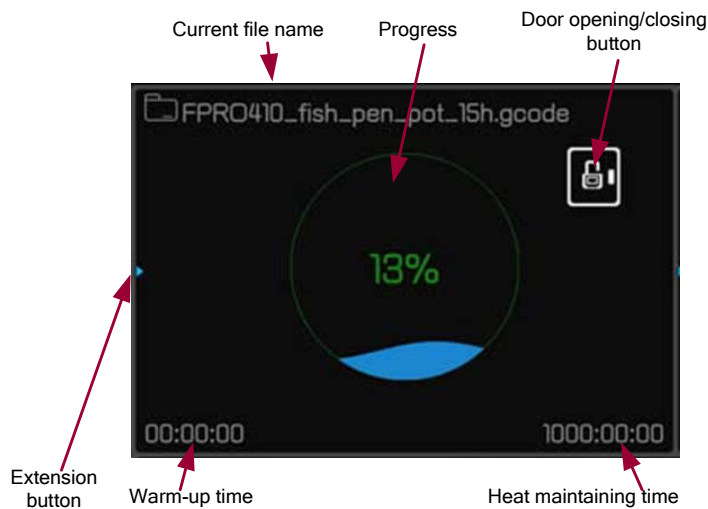

Figure 4. 7 Main state area

Click the extension button to open/close the setting interface for preheating and heat maintaining.

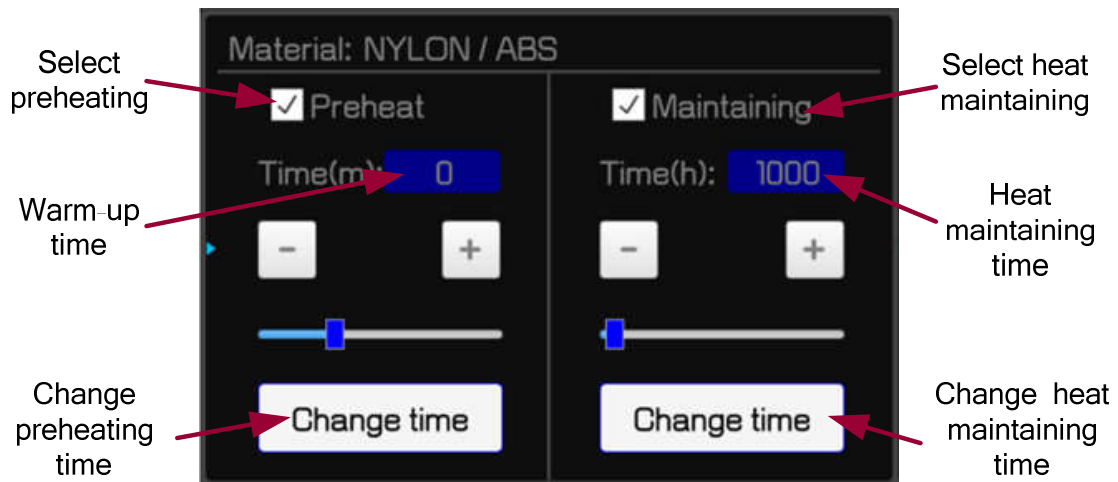

Figure 4. 8 Setting interface for preheating and heat maintaining

Check the Preheat check box to enable the preheating, and check the Maintaining check box to enable the heat maintaining. The default preheating and heat maintaining time is based on the data setting of the material chamber. To adjust the time, use the sliding bar or "+" / "-", and then click "Change time" to bring the time into effect.

When the system finds a default, the error code will be displayed in the status bar. An error indication interface will pop up, including the Error code, error description (Description), and the treatment measure (Action). After troubleshooting, click "Clear" button to clear the error.

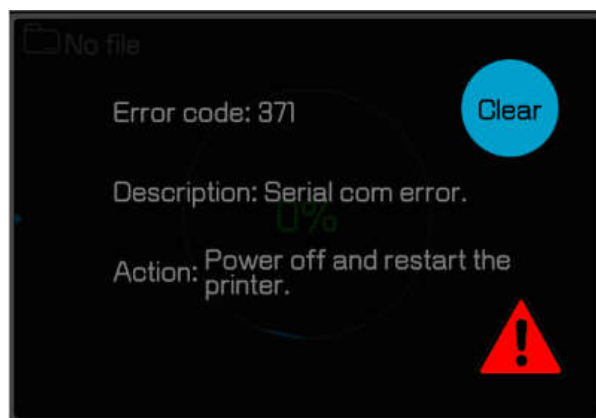

Figure 4. 9 Error indication interface

4.2.2 Auxiliary state area

The auxiliary state area displays the current temperature state of different components. The current temperature is displayed above the transverse line of temperature display module, under which the target temperature is displayed. The percentage at the bottom right corner is the progress. Click the extension button to display the status of extension parameters.

Click "Wl" or "Wr" to calibrate the material weight.

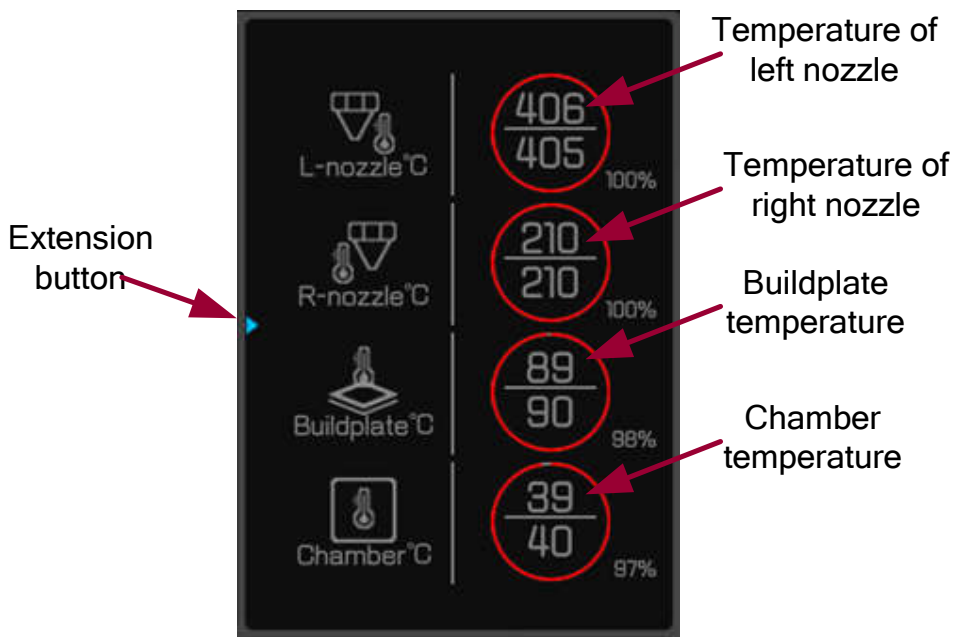

Figure 4. 10 Auxiliary state area

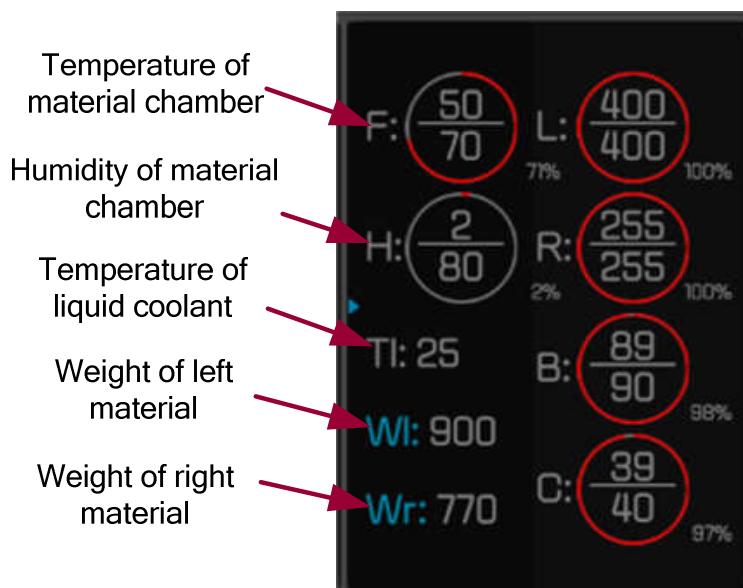

Figure 4. 11 Extension display in auxiliary state area

4.2.3 Control area

The control area is used to display the printing progress and control the printing, including open, start, pause, cease and other operations. The status gear will rotate after the printing is started, and will stop rotating when the printing is ceased or paused.

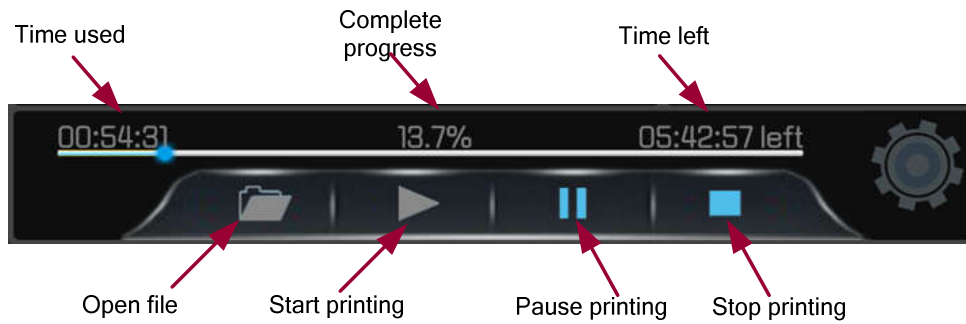

Figure 4.12 Control area

In the system setting interface, if the Developer mode is enabled,

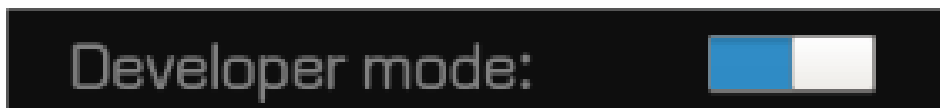

Figure 4.13 Enable developer mode

The control area will be extended to following form:

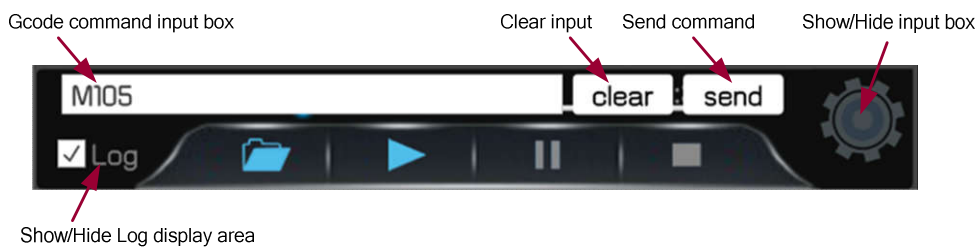

Figure 4.14 Control area under developer mode

Click the status gear to display/hide the command input box.

Check the log check box to display and open the Log display area.

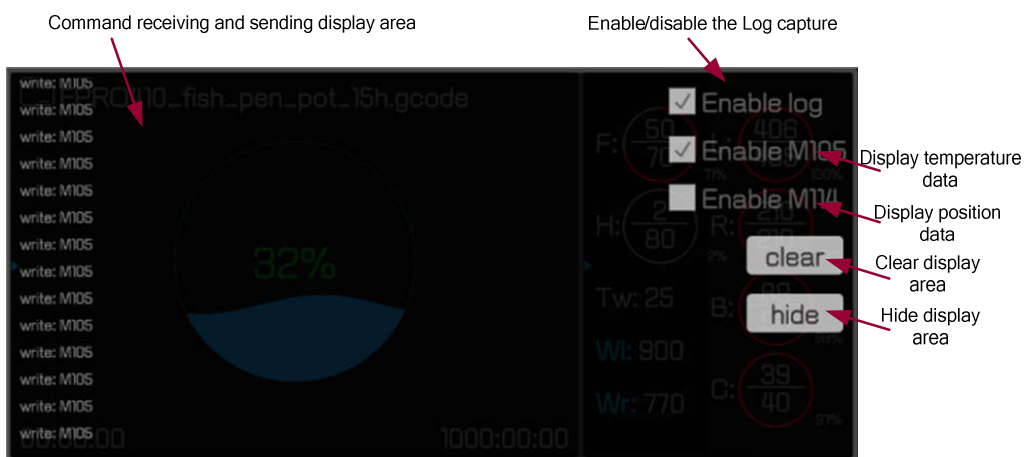

Figure 4.15 Log display area

Log display can be used for auxiliary default diagnosis.

Note: In the process of printing, please uncheck the Enable log, otherwise the printing speed and quality

4 USER INTERFACE

may be influenced.

4.3 Tuning Interface

The tuning interface is used to tune the printing related parameters. It includes the temperature of left nozzle (L-Nozzle T), temperature of right nozzle (R-Nozzle T), buildplate temperature (Buildplate T), chamber temperature (Chamber T), temperature of material chamber (Filament T), Print Speed, Material flow, speed of left fan (L-Fan Speed), and speed of right fan (R-Fan Speed). Click the corresponding block in the nine-block box to select, adjust the target value and then click the “Set” button to complete setting.

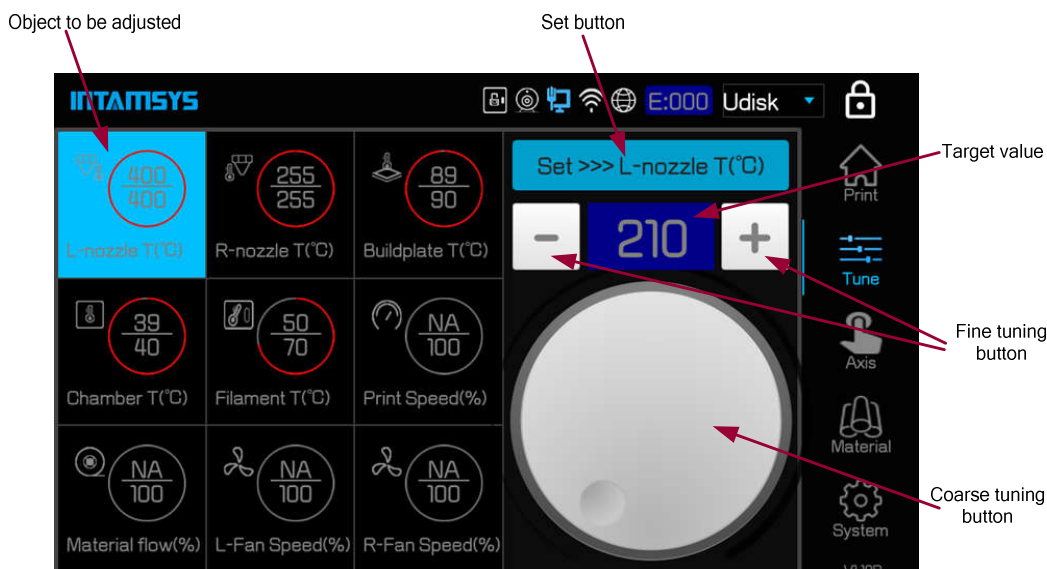

Figure 4. 16 Tuning interface

4.4 Inching Interface

The inching interface is used to manually operate the buildplate and printing head, extrude and pump back materials.

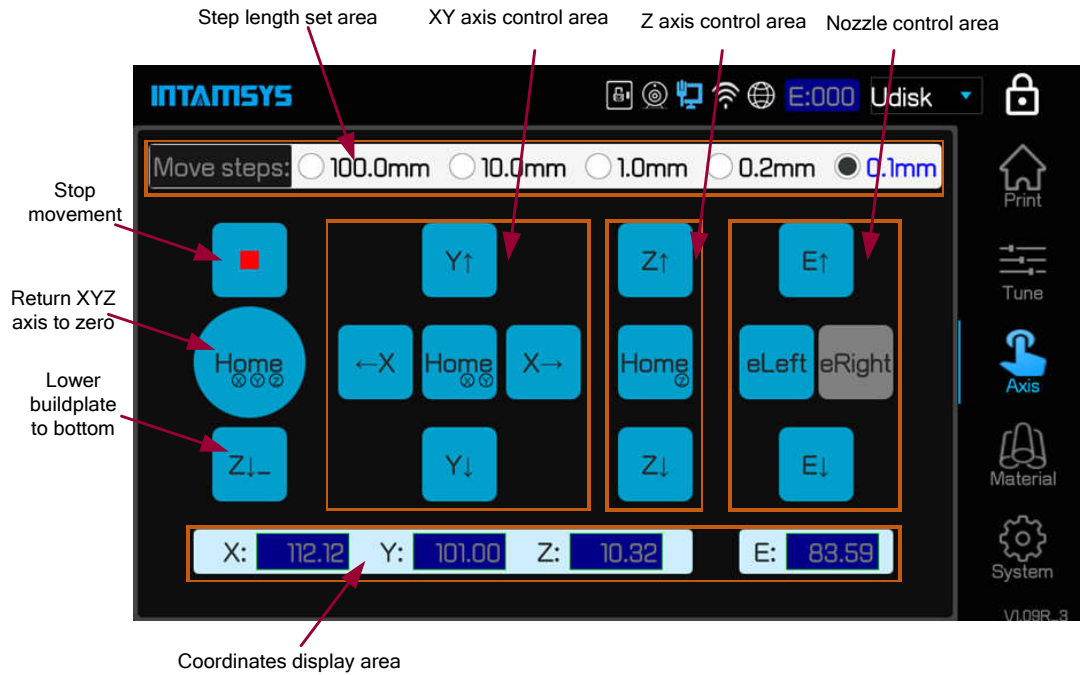

Figure 4. 17 Inching interface

4.5 Material Interface

The “Material” interface is used for material setting, material loading/unloading, manual/automatic leveling and calibration, and material database management.

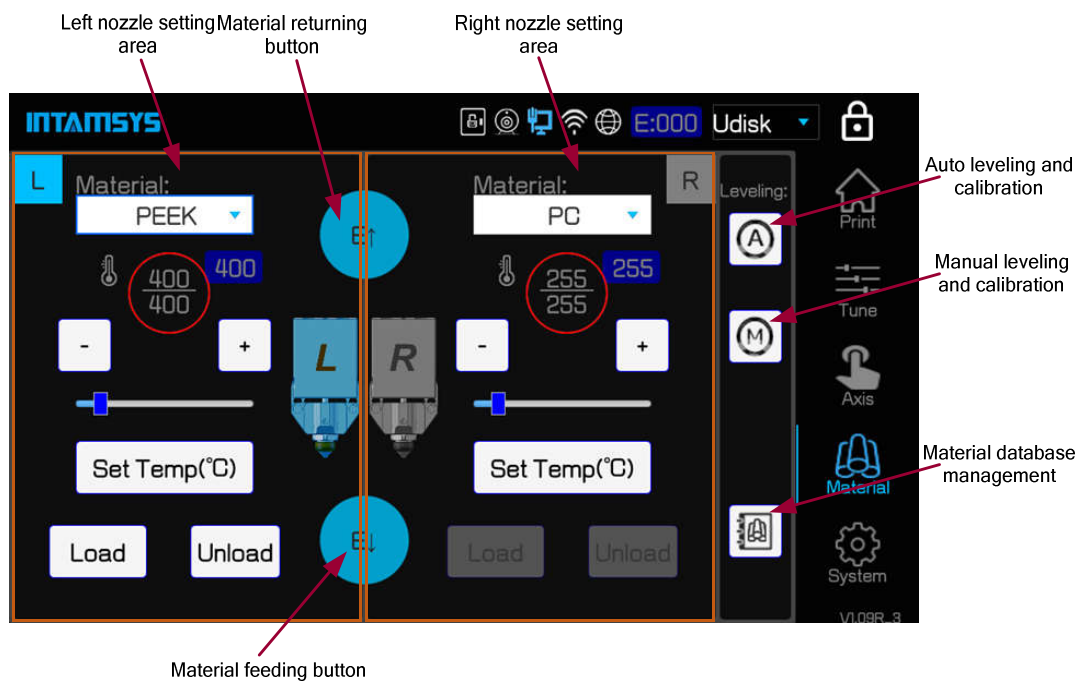

Figure 4. 18 Material Interface

4.5.1 Nozzle setting area

The nozzle setting area is shown as following figure. Click the nozzle icon to switch current nozzle. The nozzle setting area is available for material selection, nozzle temperature setting, material loading/unloading (refer to Chapter 5) and other related operations. Click the "Auto leveling and calibration button" to turn to the auto leveling and calibration interface (refer to Chapter 5). Click the "Manual leveling and calibration button" to turn to the manual leveling and calibration interface (refer to Chapter 5). Click the "Material database management button" to turn to the material database management interface.

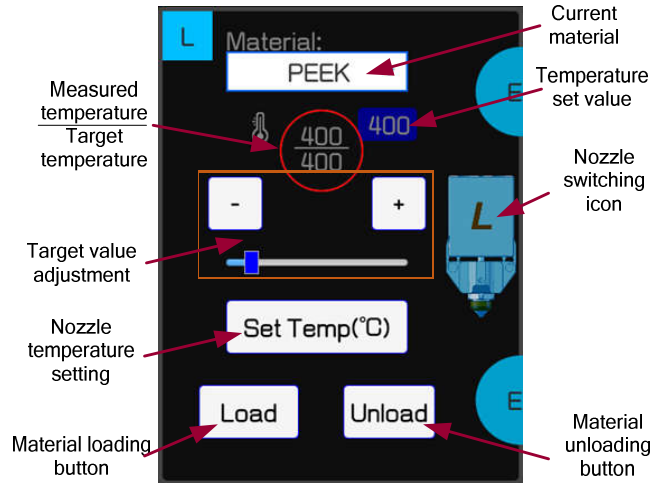

Figure 4. 19 Nozzle setting area

4.5.1 Material management interface

The material management interface shown as following figure is used to browse the system material database, and customize the user material database.

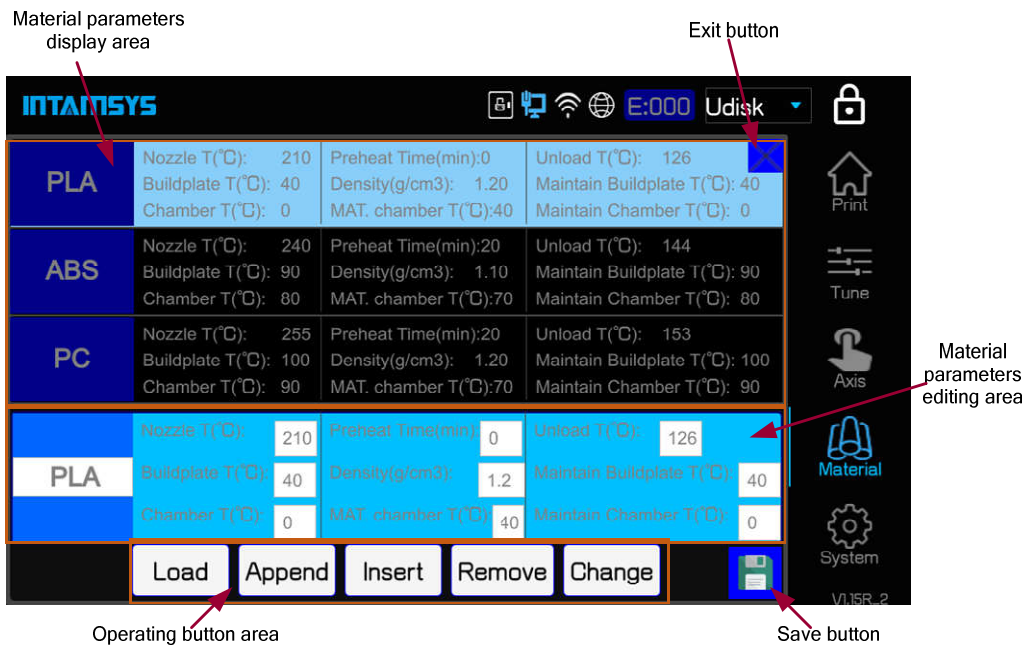

Figure 4. 20 Material database management interface

The material operation interface is used to edit the material data. The material parameters display area displays all materials, where user can slide up and down to display other materials. After the user clicks the material to be edited, the material editing area will display the parameters of the material selected currently. Click the corresponding text box to change the parameter. Change the material database in memory by the buttons in operating area:

- Load: Give up the current change, and load the material database content saved last
- Append: Append the material in current editing area to the end of material database
- Insert: Insert the material in current editing area before the material currently selected
- Remove: Remove the material currently selected
- Change: Change the content in current editing area to the material selected currently

The “Save” button is used to save the change of material database.

Note: Be sure to click the “Save” button after editing the material database. Otherwise, the change will not be saved.

If the entries in material database are deleted to 0 entry and saved, the system's initial database will be automatically loaded next user enters the material interface. This method can be used to restore the system database or update the system database after the upgrade of system database.

4.6 System Interface

The system interface is used for the relevant settings of the system, including the view and upgrade of system information, setting of system relevant parameters, setting of printer system parameters, etc.

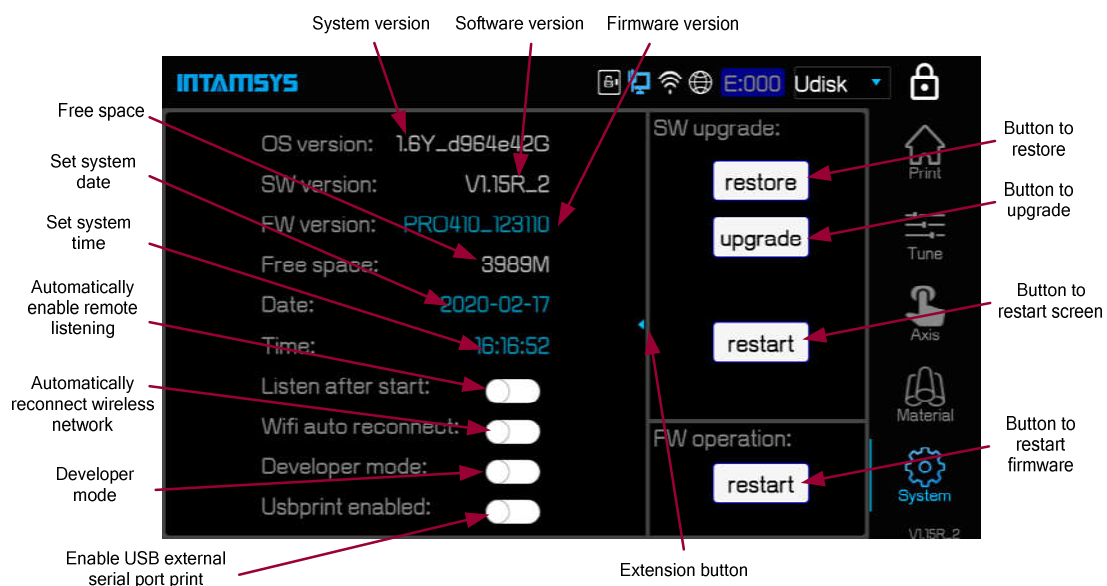

Figure 4. 21“System” interface

Software upgrade operation area (SW upgrade):

- restore: the button to restore the last version of the screen software
- upgrade: the button to upgrade after the USB disk carrying the new version of software is plugged in

4 USER INTERFACE

- restart: restart the screen after upgrade
- Firmware upgrade operation area (FW operation):
- Restart: the button to restart the firmware, i.e. restart the motion control card
- System setting area:
- Listen after start: Set to automatically allow the remote access after the system is restarted, or manually click the "Listen" button in remote printing service interface to enable the service manually.
- Wifi auto reconnect: The system will automatically connect to the last WiFi network after restart, or user may click "Connect" button in the WiFi setting interface to connect manually.
- Developer mode: Enabled developer mode is available for user to customize the sending G code and enable Logo for fault diagnosis.
- Usb print enabled: Under this mode, user can do a printing in direct connection with USB serial port by external computer. When the mode is enabled, the mainboard will disconnect the communication with screen, and switch to USB serial port equipment communication. It is used for the printing in direct connection with USB serial port by external computer. Note: This system setting will not be saved, and it will be restored to disabled state after restart.
Click the extension button to turn to the extension interface for system settings.

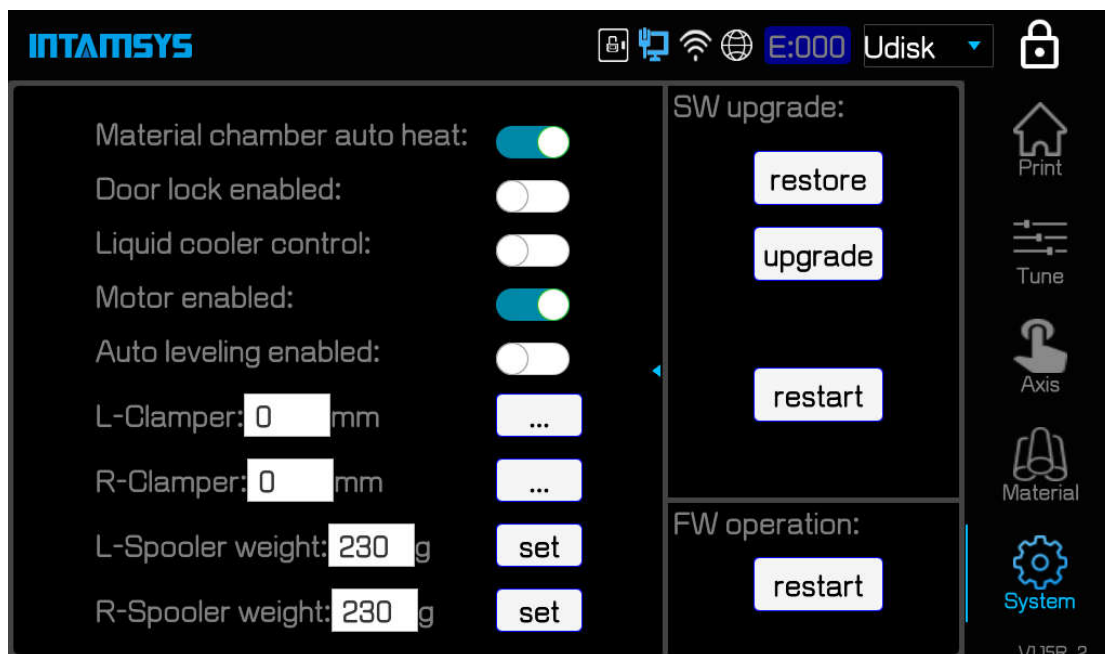

Figure 4. 22 Extension interface for system settings

- Material chamber auto heat: material chamber auto heat switch. Heat material chamber when system starts or material is changed. Blue for enabled, and gray for disabled
- Door lock enabled: the e-lock enabling switch, blue for enabled (locked), and gray for disabled (unlocked)
- Liquid cooler control: the liquid cooler control switch, blue for liquid cooler enabled, and gray for liquid cooler disabled
- Motor enabled: Motor enabling switch, blue for enabled, and gray for disabled
- Auto leveling enabled: Automatic leveling enabling switch, blue for enabled, and gray for disabled

- L-Clamper: Calibrate the clamp force of left nozzle
- R-Clamper: Calibrate the clamp force of right nozzle
- L-Spooler weight: Set the weight of left spooler
- R-Spooler weight: Set the weight of right spooler

4.7 Other Interfaces

4.7.1 Remote printing interface

The remote printing interface is used to enable the remote printing service. Click the remote printing state in status bar to turn to the interface



Figure 4.23 Remote printing state button

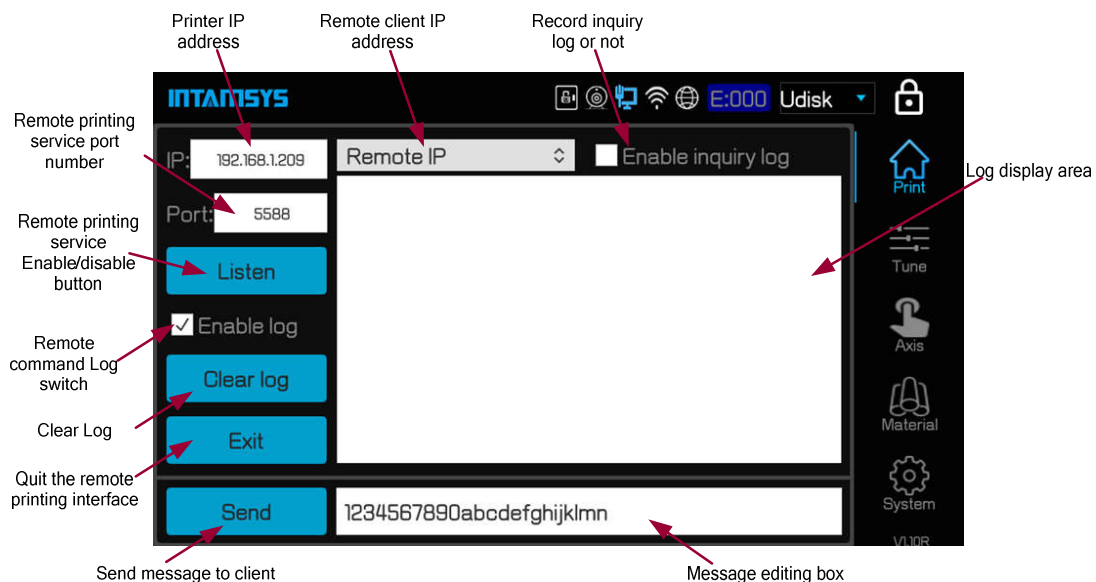

Figure 4. 23 Remote printing interface

Note: Before the use of remote printing service, the IP address should be set successfully first. It only needs to select any one of the wired and wireless network to configure IP. Currently it does not support the simultaneous working under both two network configuration.

4.7.2 Wired network IP setting interface



Figure 4. 24 Wired network state button

Click the wired network state icon in the status bar to turn to the wired network IP setting interface. In the setting area, select DHCP IP address (dynamic IP address) or Static IP address, where static IP address requires manual inputting of IP address, and the Netmask (subnet mask), Gateway and DNS (domain

4 USER INTERFACE

name server) may be input optionally based on the actual conditions. In the test area, user may send Ping package to test the network for successful connection.

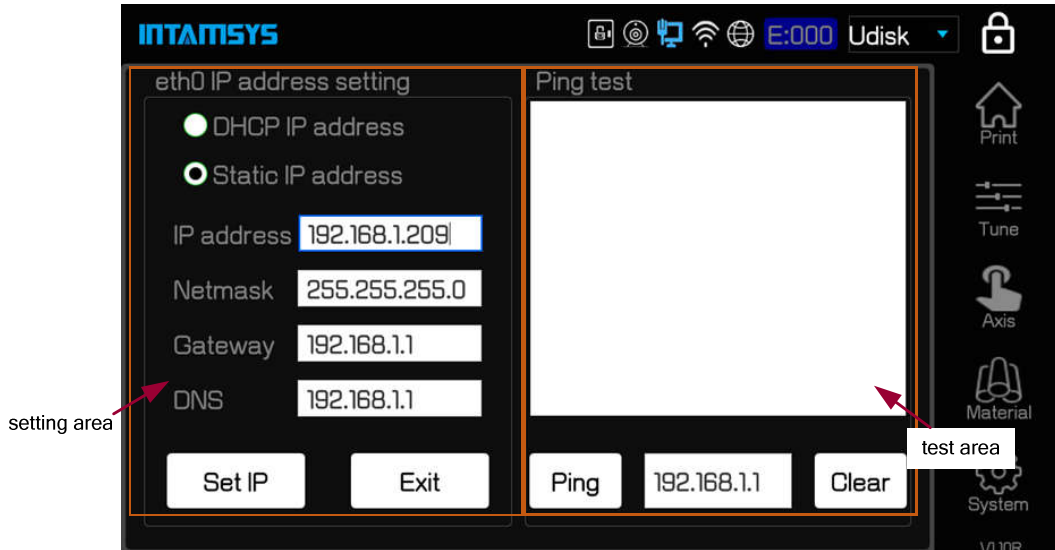

Figure 4. 25 Wired network IP setting interface

After the configuration of IP address, click "Ping" button to test the connection between printer and gateway. The following figure shows the interface of test with successful connection.

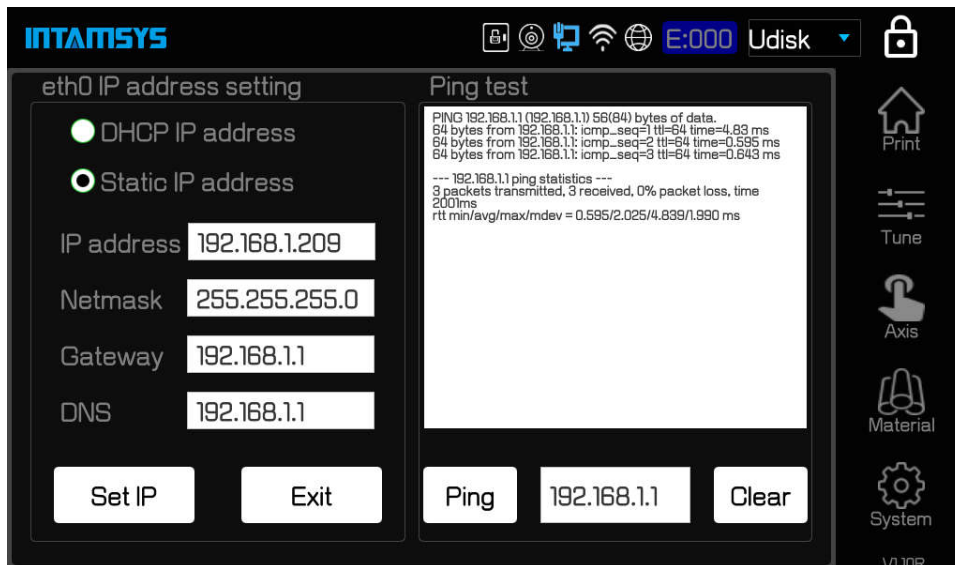

Figure 4. 26 Interface of successful wired network IP setting test

4.7.3 Wireless network IP setting interface

The wireless network (Wifi) IP setting interface is shown as following figure. Click the Wifi icon in status bar to enter the interface.

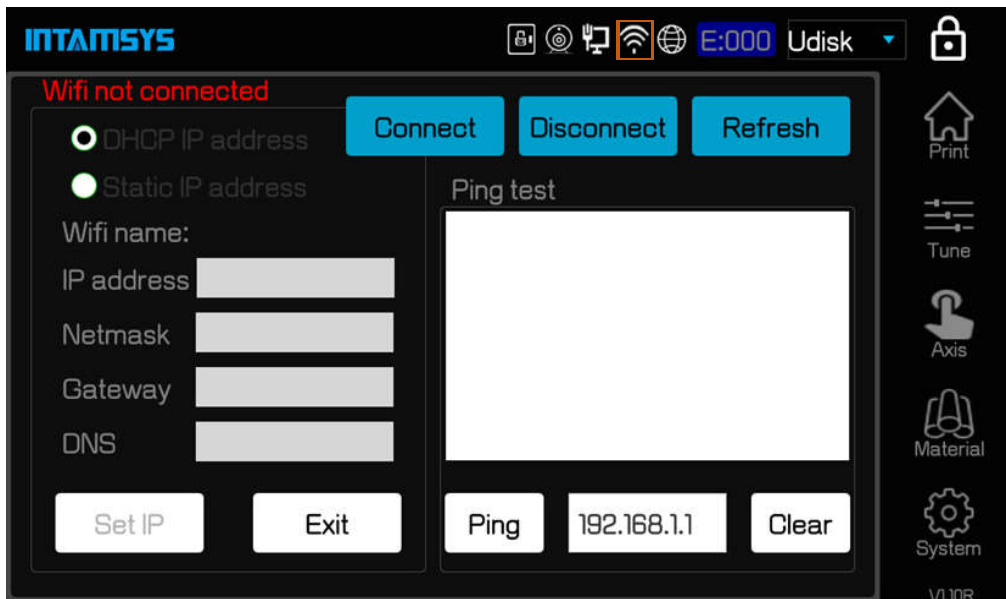

Figure 4. 27 Wireless network IP setting interface

In the wireless network setting interface, click the "Connect" button to turn to the hotspot connection interface shown as following figure to select a Wifi hotspot.

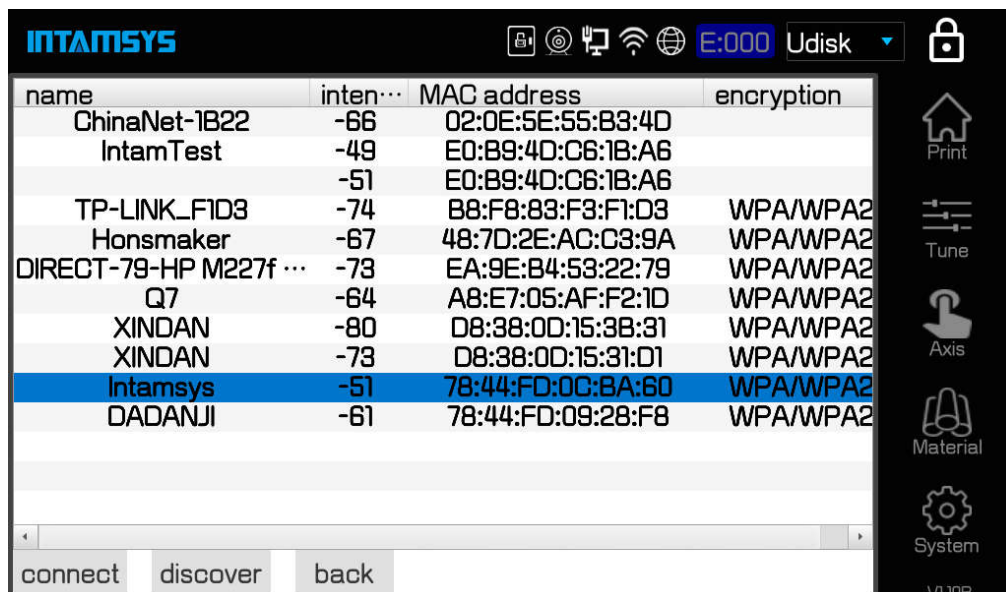

Figure 4. 28Wifi hotspot connection interface

Click the "discover" button, and discover the Wifi hotspots available for connection. Select the hotspot you want to connect to, and click "connect" button. The system will ask for password. Input the correct password. The Wifi status icon in status bar will become blue, which means the wireless network is connected successfully.

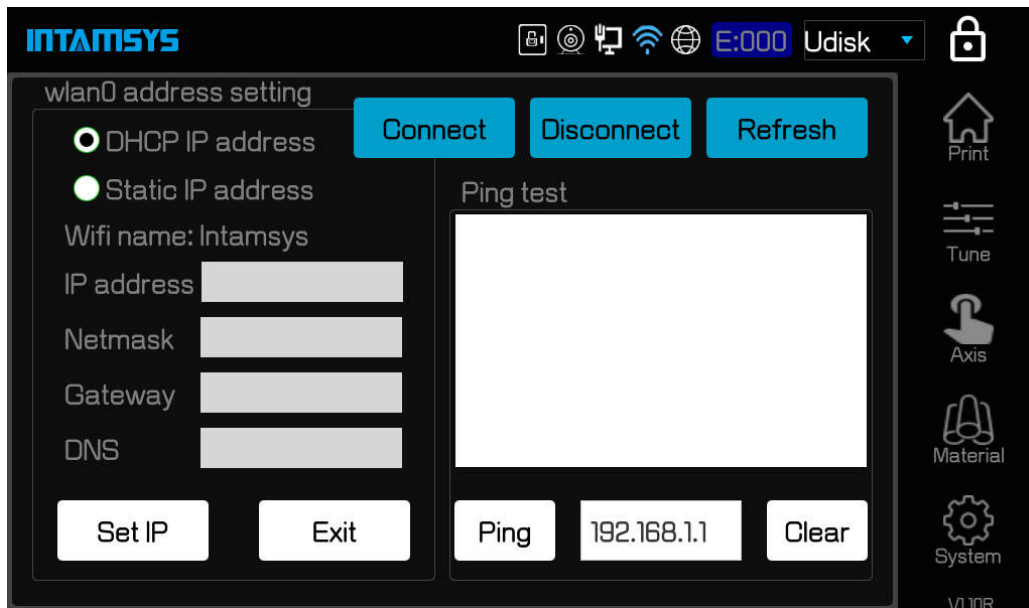

Figure 4. 29 Interface after a wireless network is connected successfully

As shown in following figure, select DHCP IP address, and then click "Set IP" button to obtain the dynamic IP address. Alternatively, select Static IP address for static IP mode, and then manually input the IP address to configure as static IP.

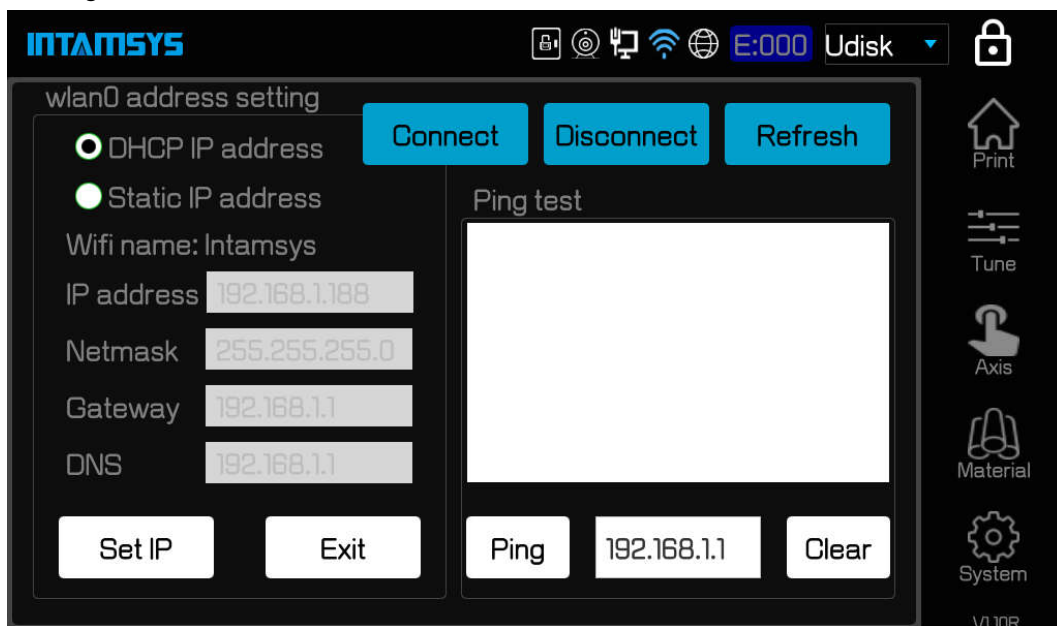

Figure 4. 30 Wireless network dynamic IP address configured successfully

After successful configuration, user may also click "Ping" button, select the target IP address and make Ping test to verify the successful connection.

Note: It is default to ping the gateway address. If no gateway is set in the local network, it is required to change to other valid address for test.

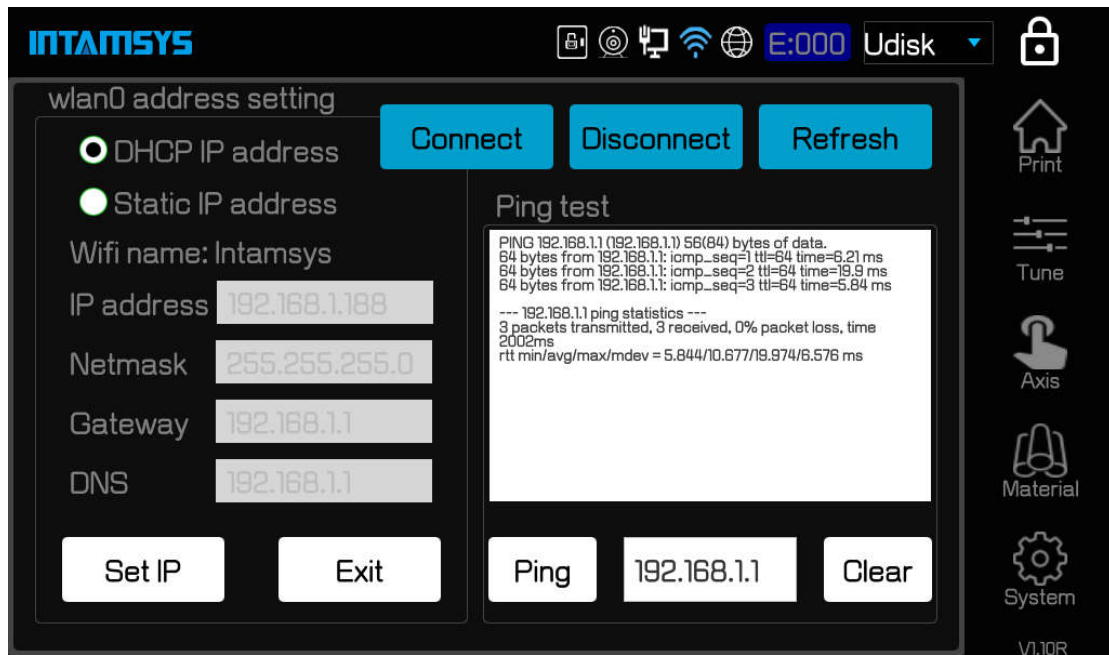

Figure 4. 31 Wireless network ping test

5 Printer Operation

The basic steps to operate FUNMATPRO 410 are described in this chapter.

5.1 Basic User Operations

5.1.1 Power on the printer

To power on the printer:

1. Take out the power cable, and connect the two ends of the cable to AC power supply plug (200-240V~50-60Hz) and the printer's power socket respectively (the power socket is located at the lower part on the back of the machine);
2. Plug in the power cable, then turn on the power switch beside the printer's power socket to make the power switch in the ON (I) position;

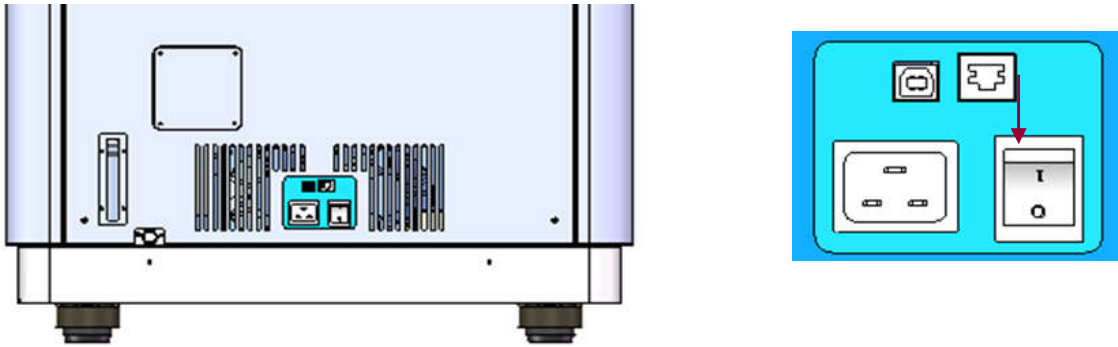

Figure 5. 1 Printer's power interface and switch

3. On the front side of the printer, switch on the front ON/OFF switch on the right of the screen. At this time, the indicator light of front ON/OFF switch lights, and meanwhile the operating screen enters the starting interface. The printer is starting up. A moment later, the screen turn to the screensaver interface. Click any position on the screen to quit the screensaver interface. Following interface will be displayed, and the startup is completed.



Figure 5. 2 ON/OFF Switch and startup interface

5.1.2 Power off the printer

To power off the printer:

Press the power button on the front side of the printer (same button for power-on).

Please note: this operation only shut down this printer. To completely power off the printer, it must turn the power master switch to the OFF (O) position.

! For long-term idleness of the printer, please disconnect the AC power supply connection of the power cable.

5.2 Material, Material Chamber and Nozzle

Note: In material loading and unloading operation, please ensure that there is no printed piece or other object on the printing buildplate. This is because XYZ axis will execute the zero returning in these operations. Print piece or other object on printing buildplate will collide with the nozzle or X cross beam. Material chamber of the printer contains two bins, which can accommodate 1 roll of material for left and right nozzle respectively. Left bin supplies to the printing on left nozzle, which is mainly the printing of model material, while the right bin supplies to the printing on right nozzle, which is mainly the printing of support material. To execute the parts printing, the left and right bin must be installed with material in any case.

5.2.1 Material loading

The information in this section will guide you to complete loading material to the nozzle. Please be sure to refer to the operation tips displayed on touch screen when completing the required steps.

1. The material chamber is located at the lower part of the printer, which will pop up via the guideway by gently pushing the material chamber forward;
2. Push the transparent top door of the material chamber forward to open the material chamber;

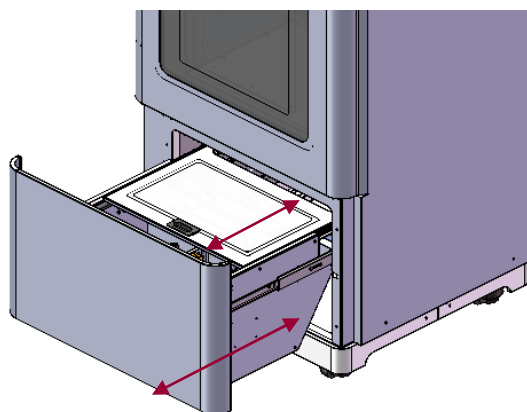

Figure 5. 3 Material chamber

3. On the screen operation interface, select the “Material” button to enter the interface similar to the following figure. Click “L”/ “R” to select the nozzle for material loading, where the icon highlighted as blue indicates the nozzle activated;
4. In the pull-down menu of “Material”, select the type of material to be loaded. (If the material to be

5 PRINTER OPERATION

loaded are not included in the options, you may refer to the new material option and add the material type.)

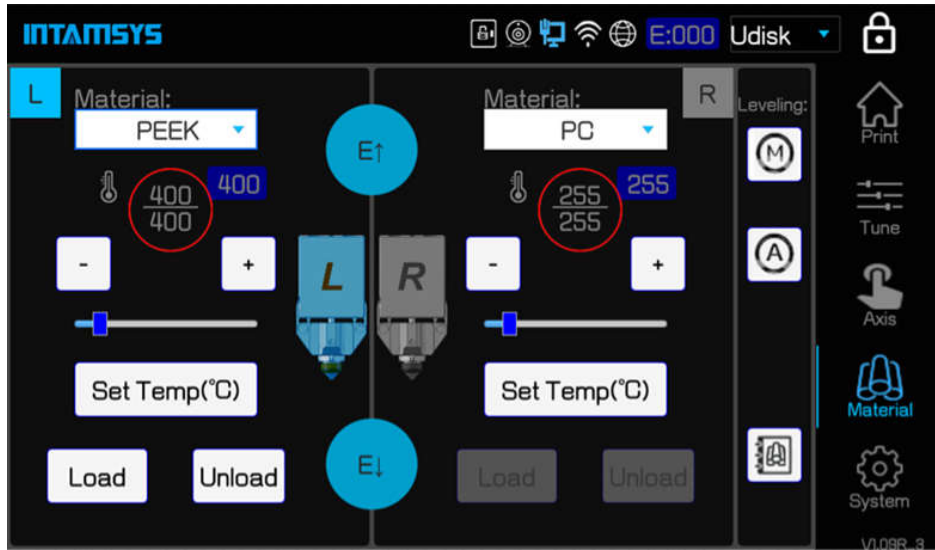

Figure 5. 4 Material interface

5. Take off the material roll to be loaded, then pull the roll through the spooler, and put the material roll back. Note: The material coil shall follow the upward coiling out direction, i.e. the tangential direction of coiling out on the upper half part of the material roll, which can ensure a smoother feeding.



Figure 5. 5 Filament coiling out direction

6. Click the "Load" button on screen. The material loading is totally divided into 4 steps. Load the material by following each step of instruction displayed on the screen.
Step 1: Check if old material was out. If yes, press 'Next', else to do Unload process;
Inspect the material chamber or feeding pipe for any residual material. If no residue, press "Next", and execute the next step operation. If there is material, click the "x" on the top right corner of the dialog box, and execute the "Unload" operation to unload the old material. Refer to 5.2.2 for the material unloading material.
Step 2: Please wait...The nozzle is heating...
This step is to heat the nozzle. Wait until the nozzle is heated to the material melting

temperature before turning to the next step. Please be patient as the target temperature and heating time of different material are different.

Step 3: Please install the material. And insert it into extruder.

Thread the end of the material through the starved feeding alarm switch, insert it between the auxiliary feeding gears, and insert it in place. Click "Next" when you find the material is being conveyed forward by the gears. The auxiliary feeding gears will accelerate the conveyance of material.

Step 4: Material is on loading. Please wait...

The gears will feeding material in high speed and then in low speed. The whole conveying process is in "high-low-high" speed, and takes totally 120s.

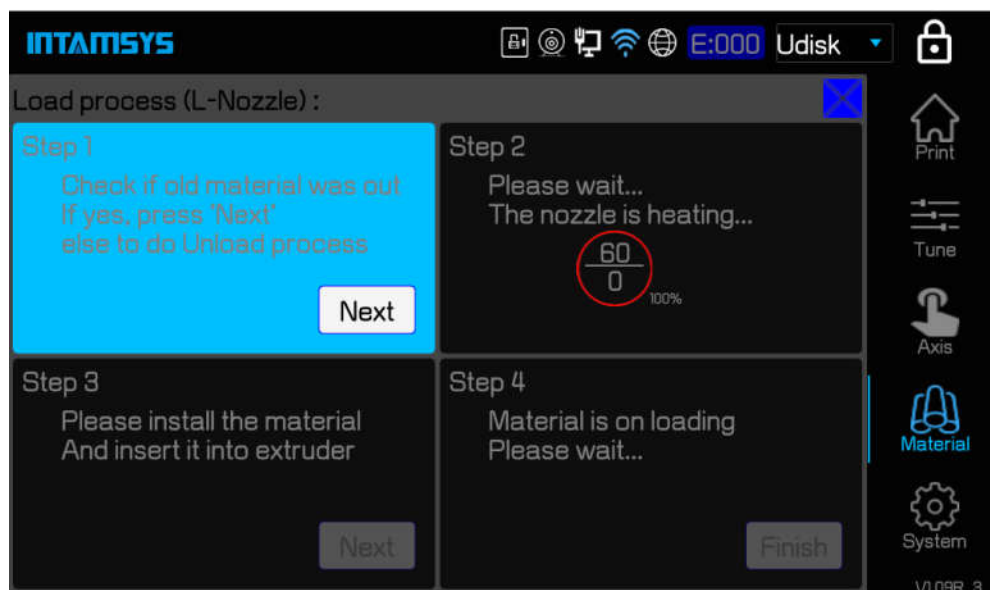

Figure 5. 6 Material loading steps

7. If "Load Failed" is displayed on the screen, user shall close the dialog box first, then click "Load" button again and repeat the operation to try loading material again.

Note: In any step of material loading (such as Step 3 or the ongoing Step 4), user may click "Finish" button in the dialog in Step 4 to end and finish the loading if the material has been ejected from nozzle.

5.2.2 Material unloading

The information in this section will guide you to complete unloading material from the nozzle and feeding pipe. Please be sure to refer to the operation tips displayed on touch screen when completing the required steps.

1. Select the "Material" button to enter the interface similar to material loading. Click "L"/ "R" to select the nozzle for material unloading, where the icon highlighted as blue indicates the nozzle activated;
2. Click the "Unload" button on screen. The material unloading is totally divided into 4 steps. Unload the material by following each step of instruction displayed on the screen.

Step 1: Please note that machine will heat the nozzle and unload material, ready?

The printer is about to perform the material unloading operation. Click "Next" to start such

5 PRINTER OPERATION

operation.

Step 2: Please wait...The nozzle is heating...

Firstly, the printer will heat the nozzle for material unloading. Wait until the nozzle is heated to the material unloading temperature before turning to the next step.

Step 3: Please wait...The material is retracting...

After reaching the unloading temperature, the material will be retracted continuously in high speed.

Step 4: Retracting completed. Please take out the material.

The material retracting process continues about 90s.

3. Open the material chamber, take out the consumable coil, and wind the retracted filament in over 2 meters long on the material coil. To prevent such coil of material from snarling in next time of use, please be sure to insert one end of the material into the small hole in the side of the material coil.
4. Close the top door of the material chamber to protect against moisture.

5.2.3 Material editing

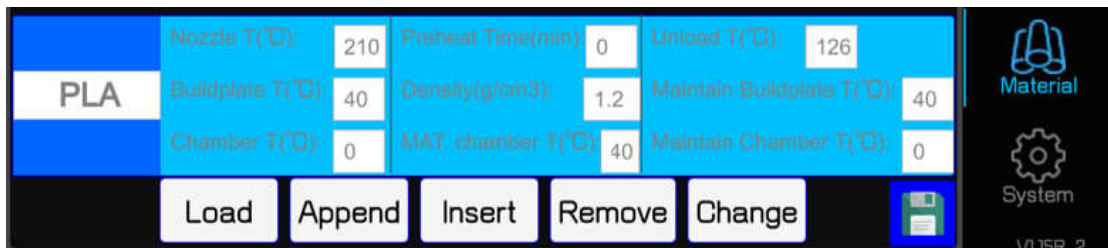

Figure 5. 7 Material editing interface

5.2.3.1 Change the material parameters

Click "Material" button, and then select the material editing button at the bottom right corner to turn to the material editing interface. Following processing parameters of the material can be edited:

Nozzle T (°C): Temperature of the nozzle for material loading.

Buildplate T (°C): Temperature of the printing buildplate for preheating and heat maintaining.

Chamber T (°C): Temperature of the chamber for preheating and heat maintaining.

Preheat Time (min): Time of buildplate and chamber preheating before printing.

Density (g/cm3): Density of the material.

MAT. chamber (°C): Temperature of the heating filament chamber.

Unload T (°C): Temperature of the nozzle for material unloading.

Maintain Buildplate T (°C): Temperature of the buildplate to be maintained after the completion of printing.

Maintain Chamber T (°C): Temperature of the chamber to be maintained after the completion of printing.

Note: The material processing parameters here are only used for the operations on the printer other than the formal printing, where the operations on the printer include material loading, material unloading, leveling, XY calibration, Z calibration, preheating, heat maintaining, etc. In the process of formal printing, the loaded G-code directive files will be loaded, and the preset parameters in the printer will not be executed any more.

Steps to change the material parameters are as below:

1. Click the material whose parameters are to be changed. At this time, such material line will be highlighted.

2. Click each input box respectively to pop up the input keyboard, and then modify the material name and the parameters.
3. After the modification, click "Change", and click the save icon.

5.2.3.2 Material appending, inserting, removal and change

Following operations can be made on each type of material:

Load: Give up the current change, and load the material database content saved last;

Append: Append the material in current editing area to the end of material database;

Insert: Insert the material in current editing area before the material currently selected;

Remove: Remove the material currently selected;

Change: Change the content in current editing area to the material selected currently.

The operating steps are as below:

1. Click the material to be copied. At this time, such material line will be highlighted.
2. Click "Load", "Append", "Insert", "Remove" and "Change" to operate loading, appending, inserting, removal and change respectively.
3. After the operation, click the save icon.

5.3 Replacement of Nozzle or Material

5.3.1 Replacement of nozzle

The left and right nozzle of the printer are in different structures, of which the automatic leveling is realized by the left nozzle. The left nozzle is movable, while the right nozzle is fixed.



Left nozzle



Right nozzle

Figure 5. 8 Appearance of left and right nozzle

Steps to replace nozzles are as below:

1. Click the "Material" button to turn to the material interface.
2. Click "Set Temp(°C)" button, and wait for the nozzle for heating.
3. When the temperature reaches the set value and the material in nozzle has melted, long press "E↑" button for over 3s to retract the material out of the nozzle range.
4. Anticlockwise rotate and take off the old nozzle with M13 (left) / M12 (right) socket wrench. Be careful to avoid scald due to the high temperature of the nozzle.

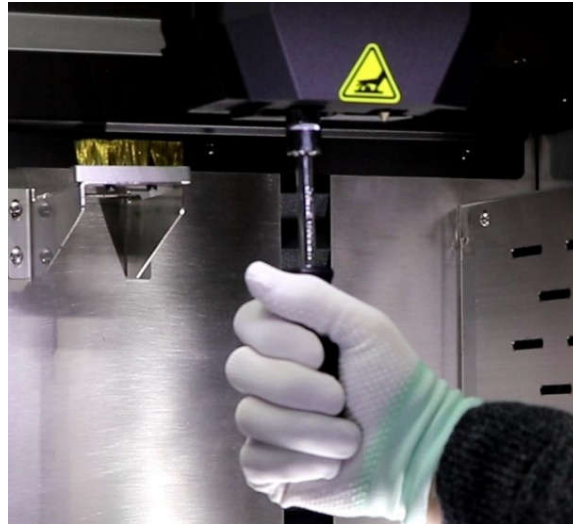

Figure 5. 9 Replacement of nozzle

5. Replace new nozzle, and tighten it with wrench.
6. Long press the "E↓" button until there is material ejected from the nozzle. The replacement is so completed.
7. After the replacement of nozzle, the leveling, XY calibration and Z calibration is required again.

5.3.2 Material change before printing

If it needs to change the type of material before printing, it is required to change the material in the "Material" interface, and also replace the printing nozzle selectively. Different materials shall be printed by different nozzle. To use a same nozzle for different materials, the printing nozzle must be in very close temperature with suggested temperature difference no greater than 50°C.

Note: A nozzle, which has been used to print any material in high melting point, shall not be used to print any material in low melting point. For example, the use of a nozzle which has been used to print PEEK in PLA printing will cause nozzle blocking and printing failure.

No replacement of nozzle is required if two materials are in same type or the nozzle temperatures required by their printing are close. The procedure is as follows:

1. Unload the old material. Refer to 5.2.2 for detailed steps;
2. Select the new material to be loaded, and execute the loading operation. Refer to 5.2.1 for detailed steps;

The steps to replace nozzle shall be added if two materials are in different types or the nozzle temperatures required by their printing are very different. Accordingly, the leveling, Z axis calibration and XY calibration are required again. The procedure is as follows:

1. Unload the old material. Refer to 5.2.2 for detailed steps;
2. Replace the nozzle. Refer to 5.3.1 for detailed steps;
3. Select the new material to be loaded, and execute the loading operation. Refer to 5.2.1 for detailed steps;
4. Perform the leveling, Z axis calibration and XY axis calibration steps.

5.3.3 Pause to change material

If the printer is printing but the user needs to change the material, the operations are as below:

1. Click the “Pause” button in "Print" interface on the screen, and wait until the movement of the printer's nozzle stops completely;
2. Unload the old material.
3. Load the new material.
4. After the completion of loading, click the “Start” button in "Print" interface on the screen to continue the printing.

5.3.4 Replenish material after starved feeding alarm

The printer is equipped with the function of starved feeding alarm. When the materials is used out, the printer stops working, and meanwhile an alarm code will be popped up on the screen to reminder user to change material. Click "Supply filament" button on the screen and then change material according to the instructions on screen. The operations to replenish material are as below:

1. Unload the old material.
2. Load the new material.
3. After the completion of loading, click the “Start” button in "Print" interface on the screen to continue the printing.



Figure 5. 10 Starved feeding alarm interface

5.4 Basic Printing Operations

5.4.1 Prepare the printer

To prepare the printer to be used for printing:

1. Power on the printer (refer to 5.1.1 for details);
2. Clear the material residues on the nozzle brush the inside the chamber;
3. Clean the printing buildplate, and apply printing glue. Before the installation, clean the printing buildplate with water and wipe dry it, and then evenly apply glue for printing base plate on the

5 PRINTER OPERATION

printing buildplate;

4. Note: PVP glue is recommended as the glue for printing base plater, which shall be evenly applied for at least 4 layers. Do not apply PVP glue directly on hot printing buildplate, as the hot printing buildplate will inactivate PVP glue and weaken its adhesive strength with the base of the printed piece. Wait until the printing buildplate is cooled to near the room temperature and then apply glue.

Note: The printing buildplate glass is fragile. Please handle with care in the process of use.

5. Install the printing buildplate. Put the printing buildplate on the hot bed and place the four magnet blocks on glass into the four corresponding magnet holes on the hot bed. Please note, the glass should be placed in the way with its notched direction on the inner side of the chamber. **After the placement, gently press the four magnet blocks with hand to confirm that the magnet blocks be fully seated in magnet holes;**



Figure 5. 11 Installation of printing buildplate glass

6. Load material according to the printing task and requirement. Refer to 5.2.1 for detailed steps;
7. Perform the leveling, Z axis calibration and XY axis calibration steps. This step may be skipped if the leveling and calibration have been completed;
8. The preparation is completed, and the printer is ready to perform printing task formally.

5.4.2 Import the print file into the printer

1. Import the STL model file into the slice software Intamsuite, where the G-code file will be generated after slicing;
2. The G-code file upon slicing may be placed in two optional positions:
 - a. U-disk. Copy the file into U-disk and insert the U-disk into the USB port on the right side of the printer operating panel for reading by the printer;



Figure 5. 12 Printer operating panel

- b. Ftp (network). Input the printer's IP address in the address bar of the PC windows folder, and transmit the G-code file to the printer via network for reading by the printer.

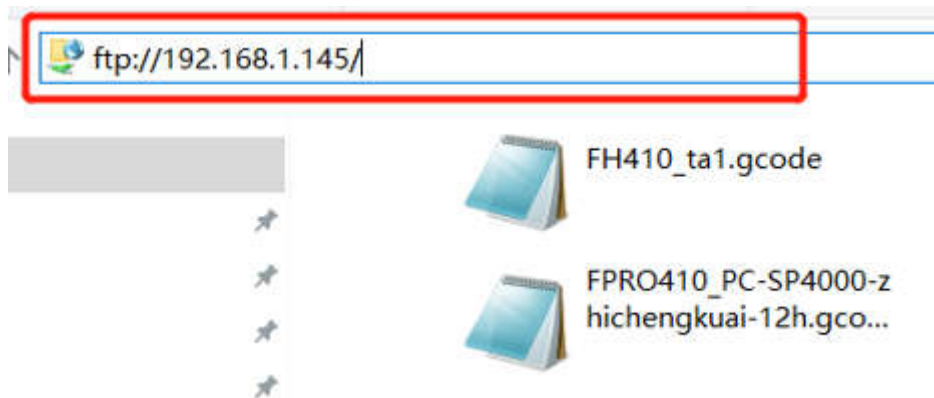

Figure 5. 13 Ftp transmission PC interface

5.4.3 Load the print file

1. Select the location of the print file first. Select the location where the file is saved in the pull-down menu at the top right corner on screen, such as U-disk or file transfer protocol (Ftp);
2. Click the file opening icon at the bottom left corner on screen to pop up the list of print files;



Figure 5. 14 Position of the button to open file

3. Select the print file to be printed, and then click "Open" button to load the print file. In U-disk import mode, the U-disk may be pulled out after the print file is loaded, which does not impact the printing.

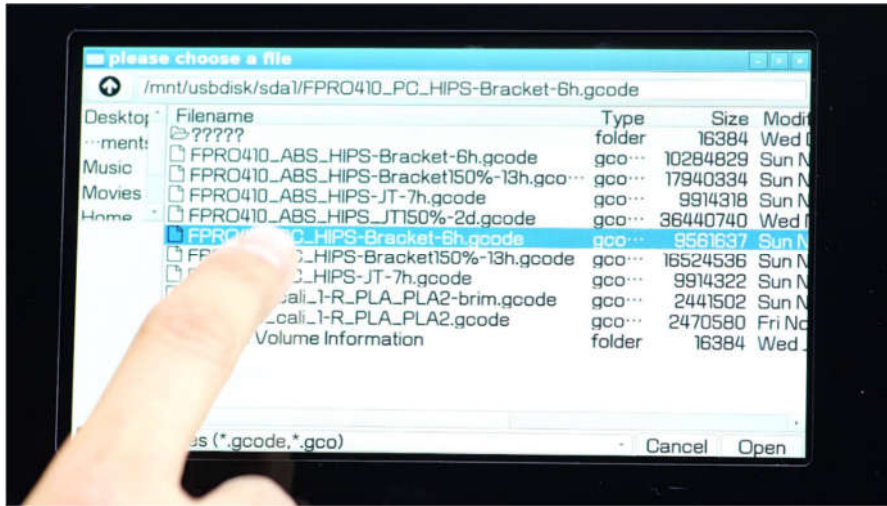

Figure 5. 15 Print files interface

5.4.4 Printing process

5.4.4.1 Main process of printing

Click the "Start" button on screen to start the printing. The printing process is divided into three steps: "preheating-printing-heat maintaining".

1. Preheating. Before printing, preheat the printing buildplate and chamber first. The preheating temperature and preheating time are the buildplate temperature, chamber temperature and preheating temperature of the left nozzle material on the printer. After the buildplate temperature and chamber temperature are close to the target value, start the preheating timing;
2. Printing. After the preheating time is end, the printer starts to read the G-code file, and perform the printing formally.
3. Heat maintaining. After the printing is finished, the nozzle is cooled, while the printing buildplate and chamber are kept in high temperature. The heat maintaining temperature and time are based on the buildplate heat maintaining temperature, chamber heat maintaining temperature and heat maintaining time for the left nozzle material.

5.4.4.2 Change of the preheating time and heat maintaining time

The preheating time and heat maintaining time may be changed in the process of printing.

1. Click the extension button on the left side of Print interface to display the interface for changing the preheating time and heat maintaining time;
2. Enable or disable them by checking the Preheat and Maintaining or not.
3. Change the time by operating "-" / "+" or scrolling, and finally press the "Change time" button to save the change.

Note: Before the printing is started, only when the chamber has been maintained hot for a long time should the preheating be disabled or the preheating time be reduced. Otherwise, the printing quality next time will be impacted.

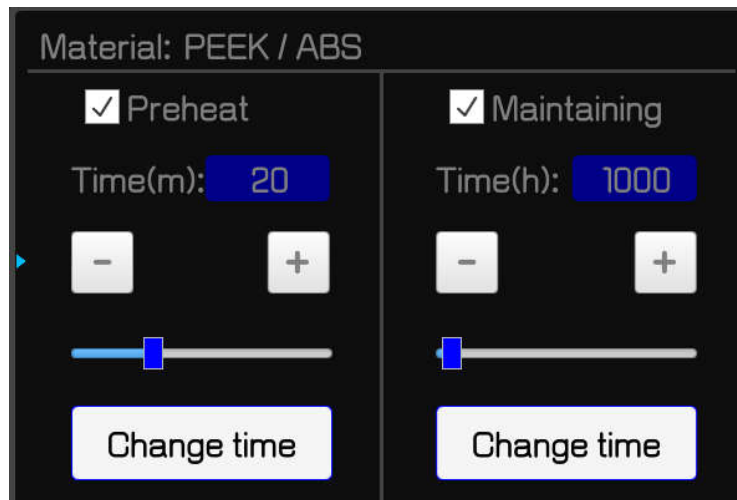

Figure 5. 16 Preheating and heat maintaining interface

5.4.5 Setting of printing parameters

During the printing, following processing parameters of the printer may be tuned in the “Tune” interface: temperature of left nozzle (L-nozzle), temperature of right nozzle (R-nozzle), buildplate temperature (Buildplate T), chamber temperature (Chamber T), material chamber temperature (Filament T), Print Speed, Material Flow, speed of left fan (L-Fan Speed), and speed of right fan (R-Fan Speed).

Steps to tune parameters are as below:

1. Click the icon of the parameter to be tuned to make it be highlighted;
2. Change the parameter value by clicking the “-”/“+” on right side or turning the rotary knob below, where exact value is displayed in the box;
3. Click “Set” button to complete setting such parameter.



Figure 5. 32 Tuning interface

5.4.6 Printing alarm

The printer will give alarm on the display screen when detecting any fault likely to impact the printing.

5 PRINTER OPERATION

Based on the severity of the alarm, the alarm state button will turn yellow, orange or red.

Press the alarm state button to open a dialog box, where the reason of alarm will be indicated. The main body of such dialog box will contain the information related to the alarm reason.

In some cases, the alarm will prevent you from starting the printing, and the printer will not execute the printing until the error is corrected. When the printer is executing a printing task, various alarms will be displayed, some of which may cause a pause or cease of printing. Based on the severity of alarm, you may restore the printing, or not restore.

Refer to Chapter 8 for the trouble alarm list and treating methods.

5.4.7 Pause the printing

During the printing, the pause button will be optional in the Print interface. The printer may be paused automatically, or manually paused by this button.

5.4.7.1 Auto pause

1. When an orange alarm is detected (see 8.1 for the list of orange alarms), an auto pause directive will be generated;
2. After the path in memory is completed, Z axis buildplate will be lowered slightly, and then the nozzle will move near the nozzle brush and stop. The nozzle will be stopped heating, and meanwhile an alarm dialog box will be popped up, indicating the reason for pause state;
3. You have to correct this alarm before clicking "Clear" button to clear the alarm;
4. To restore the printing, press the "Start" button in "Print" interface. The restoring directive will be sent to the printer, directing it to restore the printing.

5.4.7.2 Manual pause

1. Press the "Pause" button to pause manually;
2. After the path in memory is completed, Z axis buildplate will be lowered slightly, then the nozzle will move near the nozzle brush and stop and the nozzle will be stopped heating;
3. To restore the printing, press the "Start" button in "Print" interface. The restoring directive will be sent to the printer, directing it to restore the printing.

5.4.8 Cease the printing

After a printing task is started, the "Cease" button in "Print" interface will be optional. The printer may be ceased automatically, or manually ceased by this button:

5.4.8.1 Auto cease

When a red alarm occur (see 8.1 for the list of red alarms), an auto cease directive will be generated. Upon receiving the cease directive, the printer will close the nozzle, buildplate and chamber heating, and return XY axis to zero.

5.4.8.2 Manual cease

Press the "Cease" button to cease manually. When the printer receives the cease directive, a dialog box will be displayed, which is used to confirm or cancel the cease. The printing will be ceased by pressing to confirm. Upon receiving the cease directive, the printer will close the nozzle, buildplate and chamber heating, and return XY axis to zero.

5.4.9 After the completion of printing

After the completion of printing, the printing head will be returned to zero and stop. The printing progress

on screen will be displayed as 100%, indicating the completion of printing. The buildplate and chamber of the printer may be maintained in certain temperature according to the presetting.

To remove printed piece from the printer:

1. Unlock the door, and open the front door of the chamber. To end the heat maintaining, it just needs to uncheck the “Maintaining” button, where the front door and cap will be unlocked; to keep maintaining the temperature, click the door lock button in status bar on screen to unlock the front door and cap;
2. Click “Axis” interface, and click "Z↓_" button to lower the buildplate to the bottom. At this time, the buildplate will go down to the bottom of the chamber for taking out the printing buildplate glass plate;
3. Wear gloves, and take out the buildplate glass plate and printed piece together;
4. Separate the printed piece from the buildplate glass plate carefully with scraper knife. Please note, the separating shall be operated when the glass plate in hot state is just taken out from the chamber. This is because the shrinkage of printed piece is far greater than the shrinkage of glass plate, and the cooled glass plate is vulnerable to damage due to the shrinkage of printed piece.
5. Remove the support material from the printed piece.

5.5 Change Default Settings of the Printer

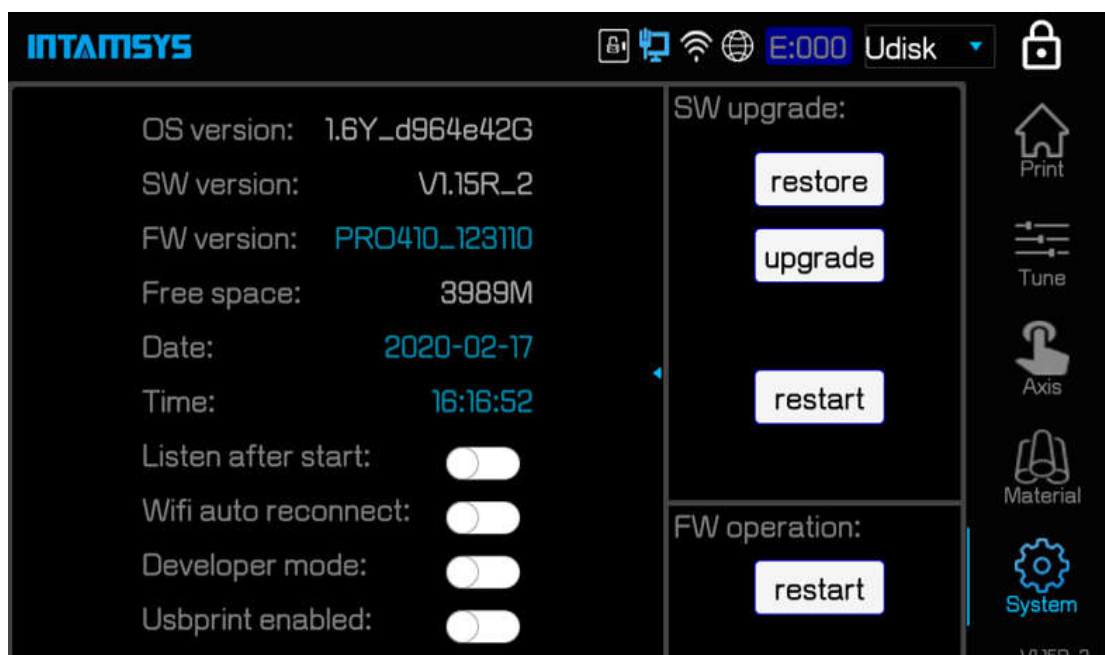

Figure 5. 17“System” interface

5.5.1 Change the system date and time

The system time of the printer will not be updated automatically according to the time zone of its location, which requires the manual change by user. Click the “Date / Time” in “System” interface, and change the date and time in the changing box, and quit the changing box to complete the change.

5.5.2 Enable/disable the function of allowing network remote access

Listen after start: Set to automatically allow the remote access after the system is restarted.

Click the switch on the right side of "Listen after start" in System interface to enable/disable, where blue indicates function enabled. Alternatively, manually click the "Listen" button in remote printing service interface to enable it manually.

5.5.3 Enable/disable Wifi auto-reconnect

Wifi auto reconnect means the system will automatically connect to the last WiFi network after restart.

Click the switch on the right side of "Wifi auto reconnect" in "System" interface to enable/disable, where blue indicates function enabled. Alternatively, click "Connect" button in the WiFi setting interface to connect manually.

5.5.4 Enable/disable developer mode

Developer mode refers to the mode that the printer opens to developers, which is mainly used for the debugging of the printer, and is not required in normal printing. Under the developer mode: Enabled developer mode is available for user to customize the sending G code and enable Logo for fault diagnosis.

Click the switch on the right side of "Developer mode" in System interface to enable/disable, where blue indicates function enabled.

5.5.5 Enable/disable USB printing mode

Usb print enabled refers to the mode under which user can do a printing in direct connection with USB serial port. When the mode is enabled, the mainboard will disconnect the communication with screen, and switch to USB serial port equipment communication. It is used for external computer to print by connecting to the printer via USB serial port. This mode shall be enabled before use, and must be disabled after use, otherwise the printing in other mode will be impacted.

Click the switch on the right side of "Usb print enabled" in System interface to enable/disable, where blue indicates function enabled.



Figure 5. 18 Connection method of USB print mode

5.5.6 Lock the front door and cap

Door lock enabled refers to enabling the front door and cap lock.

Click the switch on the right side of "Door lock enabled" in System interface to enable/disable, where blue indicates lock enabled. Alternatively, click the lock icon in status bar on screen to enable/disable, where blue indicates lock enabled.



Figure 5. 19 Door lock button interface

To protect the safety of user, the printer will lock the front door and cap when it starts printing or the chamber starts heating, and the front door and cap will be unable to be opened. To force unlocking in this process, click the lock button to unlock the front door and cap.

Note: After forced unlocking, do not put your hand into the chamber for fear of scald or pinching.

5.5.7 Liquid cooler control

Liquid cooler control refers to enabling/disabling the liquid cooling system.

Click the switch on the right side of "Liquid cooler control" in System interface to enable/disable, where blue indicates liquid cooler enabled.

The liquid cooler is automatically enabled under the nozzle heating or chamber heating condition, and is automatically disabled under certain temperature. This button is used to force enabling/disabling the liquid cooling system. Do not operate this button in normal use.

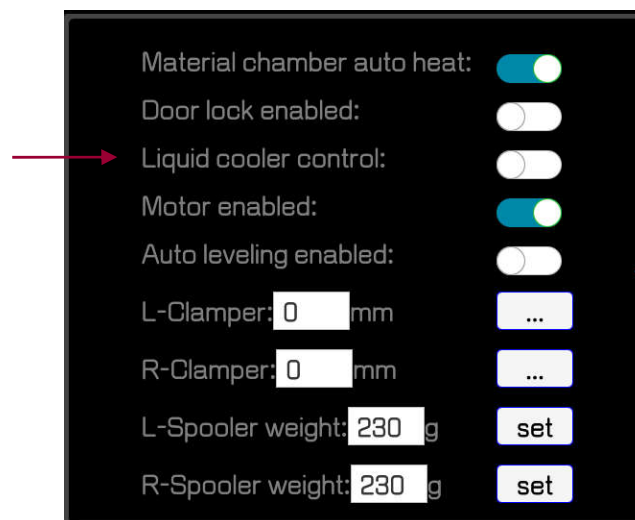

Figure 5. 20 Liquid cooler control interface

5.5.8 Enable motor

Motor enabled refers to enabling/disabling the X axis, Y axis, Z axis, extruding motor, auxiliary feeding motor, etc.

Click the switch on the right side of "Motor enabled" in System interface to enable/disable, where blue indicates motor enabled.

Enabled means all motors are powered on, and disabled means all motors are powered off. After motor disabled, the motors may be pushed by hand for free motion, for easier maintenance.

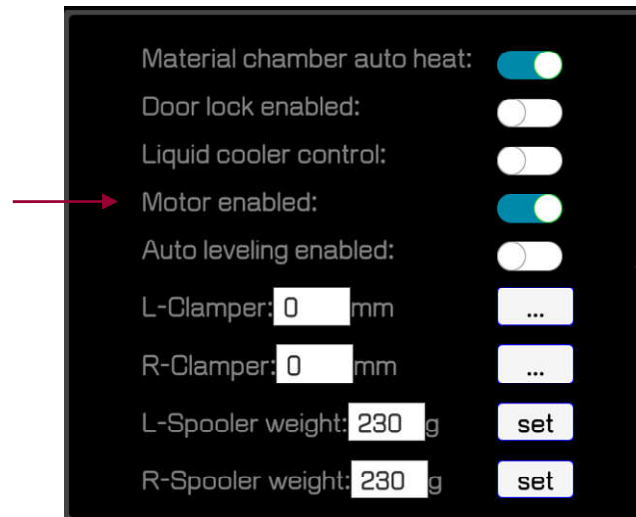

Figure 5. 21 Motor control interface

5.6 Printer State

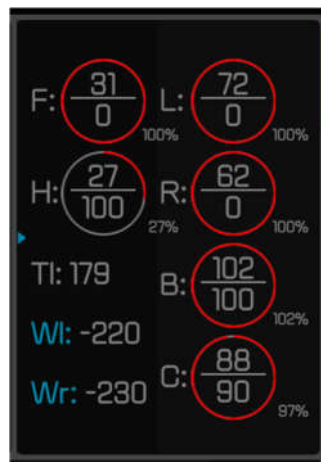

Figure 5. 22 Printer state

5.6.1 Temperature and humidity state

The temperature and humidity state of the printer can be viewed in real time on the Print interface.

- L: Target temperature and real-time temperature of the left nozzle;
- R: Target temperature and real-time temperature of the right nozzle;
- B: Target temperature and real-time temperature of the buildplate;
- C: Target temperature and real-time temperature of the chamber;
- F: Target temperature and real-time temperature of the material chamber;
- H: Real-time humidity of the material chamber.

5.6.2 Material state

The state of the residual material in the printer's material chamber can be viewed in real time on the Print

5 PRINTER OPERATION

interface.

Wl: Remained weight of left nozzle consumables;

Wr: Remained weight of right nozzle consumables.

5.6.4 State of liquid cooling system

The state of the liquid coolant in the printer's cooling system can be viewed in real time on the Print interface.

Tl: Temperature of the liquid coolant in liquid cooler.

5.6.4 Software version

Access the software version through the "System" interface.

OS version: Operating system version;

SW version: Screen version;

FW version: Firmware version.

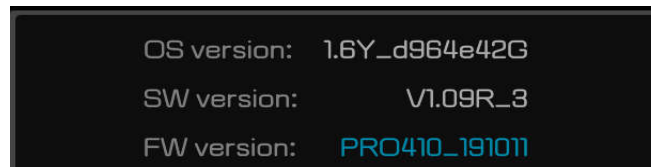

Figure 5. 23 Operating system, screen and firmware version number

6 Leveling and Calibration

The methods to level and calibrate FUNMATPRO 410 are described in this chapter.

6.1 Manual Leveling and XYZ Calibration

Manual leveling includes the main operations of measuring the 4 points on the buildplate with filler gauge (in 0.2mm thick), and meanwhile rotating the rotary knobs under the printing buildplate with hand respectively to keep the same distances from the nozzle cusp of 4 points to the buildplate glass, so as to make the whole XY motion plane parallel to the buildplate glass. Manual leveling shall only be realized through the left nozzle.

To realize the dual nozzle printing, it is also required to determine the deviation of right nozzle relative to left nozzle on Z direction and XY direction, so the Z calibration and XY calibration are required. To calibrate the Z deviation, respectively measure the distances between the left/right nozzle cusp and the buildplate glass with filler gauge, the difference value of which is the Z offset value. To calibrate the XY offset, the left and right nozzle prints scale on the buildplate glass respectively, on which the X offset value and Y offset value can be read.

In the "Material" interface, click "M" button to turn to the manual leveling and XYZ calibration interface. The three steps from left to right are Leveling, Z calibration and XY calibration respectively.

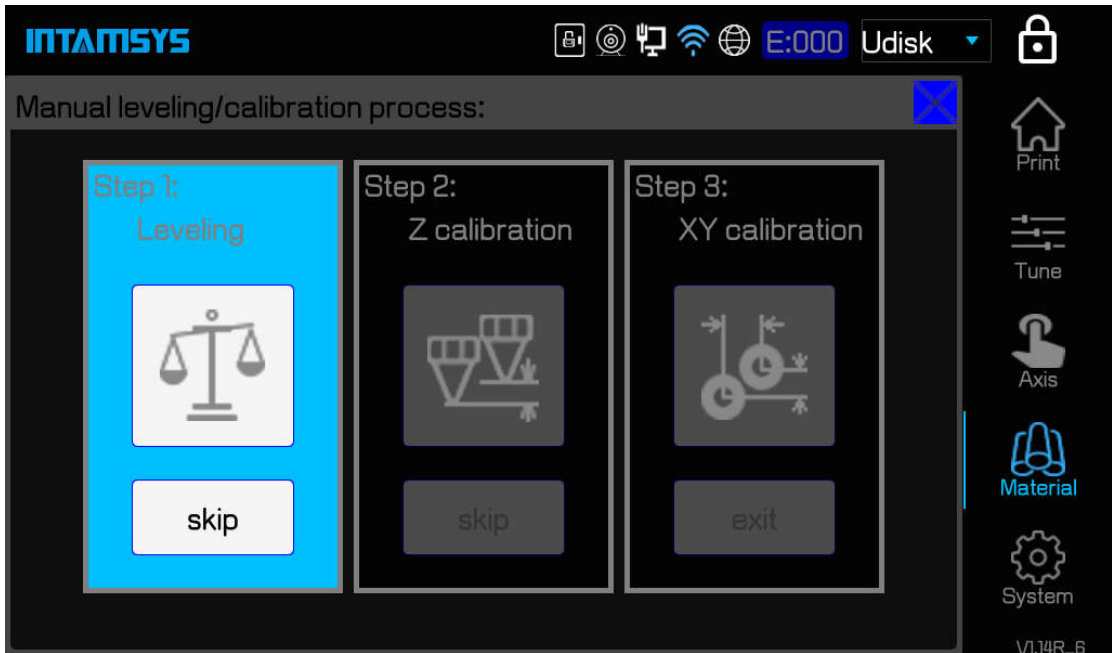

Figure 6. 1 Manual leveling and XYZ calibration steps

User may selectively perform any one or several steps, but the three steps from left to right must be performed in order. The step(s) not required may be skipped by clicking the "Skip" button under such step(s).

After different operations, the following table will guide user to selectively perform the step(s) among three.

6 LEVELING AND CALIBRATION

Table 6.1 Conditions required for manual leveling and XYZ calibration

Use condition	Step I: Leveling	Step II: Z calibration	Step III: XY calibration
After replacement of left nozzle	•	•	•
After replacement of right nozzle		•	•
After replacement of new glass buildplate	•		
Leveling error	•		
Z calibration error		•	
XY calibration error			•

6.1.1 Manual leveling

1. Click the “Leveling” icon. A prompt dialog box will be popped up, prompting to clean the printing buildplate and chamber to prevent interference with the leveling operation. If the cleaning has been completed, click "OK" button to formally enter the manual leveling operation;
2. Heat the nozzle first. Clear the residual material on the nozzle with tweezers or brush after the heating. Screw down the 4 rotary knobs under the printing buildplate to prevent the nozzle from colliding with the glass plate during the leveling. Click the “Next” button last;
3. According to the prompts on screen, rotate the rotary knobs under the printing buildplate with hand respectively, and meanwhile measure the distance between the nozzle and the buildplate glass plate with filler gauge (in 0.2mm thick). Pull the filler gauge back and forth and adjust the filler gauge to just pass through the distance, and then click the “Next” button;
4. After the 4 points on the buildplate are adjusted for the first time, “Redo2-5” button will be displayed on screen. Click this button to repeat the leveling;
5. After the completion of the second manual leveling, “Finish” button will be popped up on screen. Click this button to lower the buildplate to the bottom of Z axis, and then return. The manual leveling is finished.

NOTE:

- Before the leveling, press the four magnet blocks with hand to make them be fully seated in the magnet holes of the hot bed, so as to exclude the gaps between them;
- The residual material on nozzle cusp should be cleared before leveling;
- Before leveling, the printing buildplate should be cleaned up without any printed piece, large piece of glue or other foreign matter remained on it;
- Before leveling, the chamber should be cleaned up to prevent a collision when the buildplate is being lowered;
- Be careful to prevent scald in operations as the nozzle is in high temperature during the leveling.

6.1.2 Z calibration

1. Click “Zcalibrate” icon to pop up a prompt dialog box, prompting to clean up the printing buildplate. If the cleaning has been completed, click "OK" to formally enter the Z calibration operation;
2. Calibrate the left nozzle first. According to the instructions on screen, place the filler gauge between the nozzle and the glass buildplate, make coarse tuning with the "Z↑0.05" / "Z↓0.05"

button, and make fine tuning with the "Z↑0.01" / "Z↓0.01" button to the extent that the distance between nozzle and glass just fits the insertion of filler gauge. Press Next button after the tuning;

3. Calibrate the right nozzle with same operation method as the calibration of left nozzle. After the tuning, press "OK" button to finish.

6.1.3 XY calibration

1. Click the "XYcalibrate" icon. It will prompt to confirm the material of left and right nozzle has been loaded, and prompt to clean up the printing buildplate. After confirmation, click "Next" button to start printing the calibration model. (If the XY offset values are known, no need to press "Next" button, but click the "Skip" button directly and then input the X offset value and Y offset value);
2. The printer will successively print the model scale with left nozzle and right nozzle respectively. After the completion of printing, click "Next" button. The nozzles will move to the top left corner of the buildplate for easier reading of scales. Read the scales to obtain the X offset value and Y offset value respectively, and click "+" / "-" button to input the numerical values.
3. X offset value should be obtained by reading the scale on horizontal direction, with the method as below:
 - (1) With the model printed by left nozzle as benchmark, read the model scale printed by right nozzle;
 - (2) Firstly, confirm whether the center line of right nozzle model is located on the left or right of the center line of left nozzle model. Take "-" value if on left, and take "+" value if on right;
 - (3) Find out the scale line where the two models align best, count from the center line to this scale line and take the numerical value as "N";
 - (4) Input the value of "N" in the input box.

Y offset value should be obtained by reading the scale on numerical direction, with the method as below:

- (1) With the model printed by left nozzle as benchmark, read the model scale printed by right nozzle;
- (2) Firstly, confirm whether the center line of right nozzle model is located above or below the center line of left nozzle model. Take "-" value if below, and take "+" value if above;
- (3) Find out the scale line where the two models align best, count from the center line to this scale line and take the numerical value as N;
- (4) Input the value of "N" in the input box.

For illustration, the following figure shows the scale printed for a XY calibration. After reading, the X offset value should be "+6", while the Y offset value should be "-6".

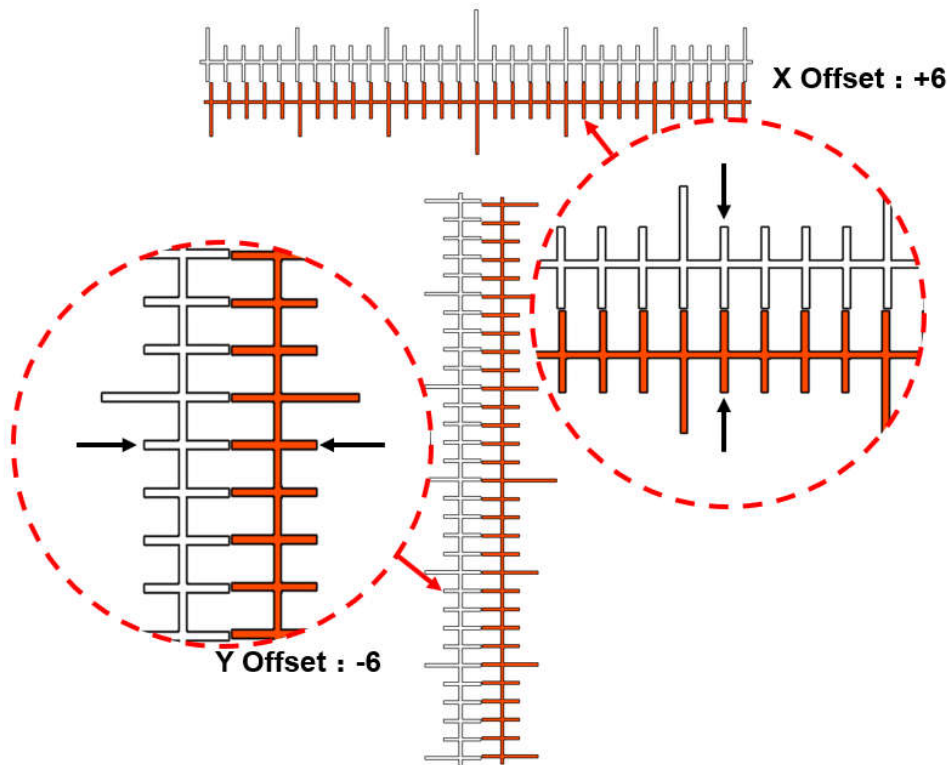

Figure 6. 2 Method to read XY calibration scale

Note: The offset 1 denotes one scale, and the actual offset should be 0.05mm.

If after the reading of printed scale, the center line of printed scale range on horizontal or vertical direction have large deviation and other scales are difficult to be coincided, this indicates that the XY deviations have exceeded the measurable range (maximum scale range 15, i.e. 0.75mm). Take following steps:

- (1) Firstly, observe the position of the center line of right nozzle model relative to the centerline of left nozzle model, to determine the deviation direction "-" / "+";
- (2) Set the offset value as the maximum value, and click "OK" button;
- (3) Carry out XY calibration again, and print the test model, until the confirmed deviation value is read.

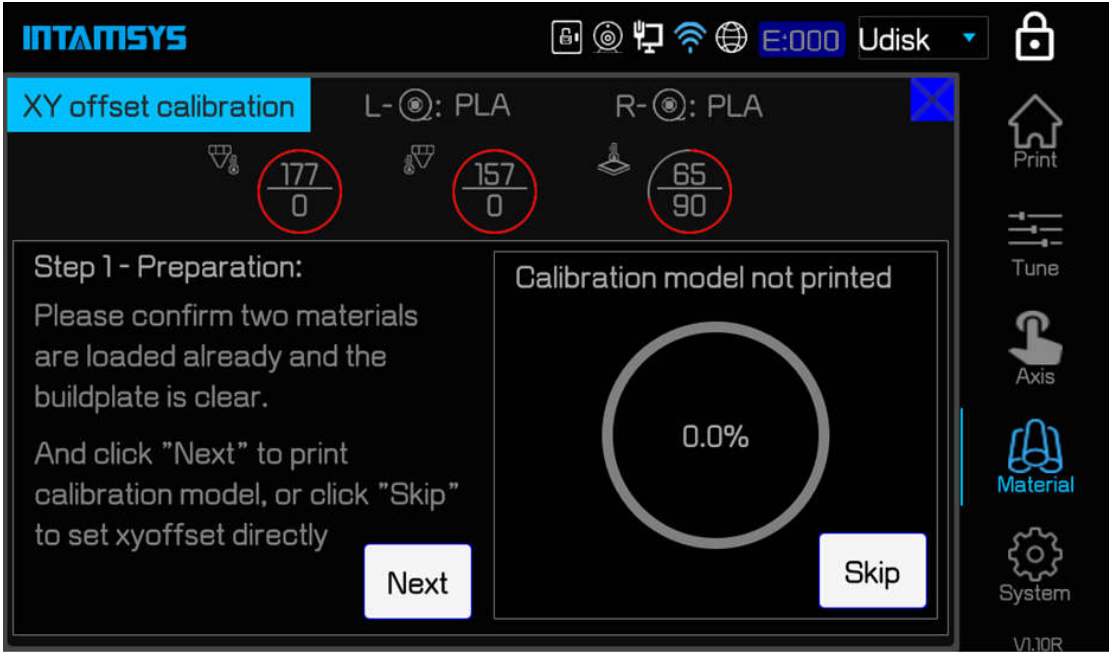
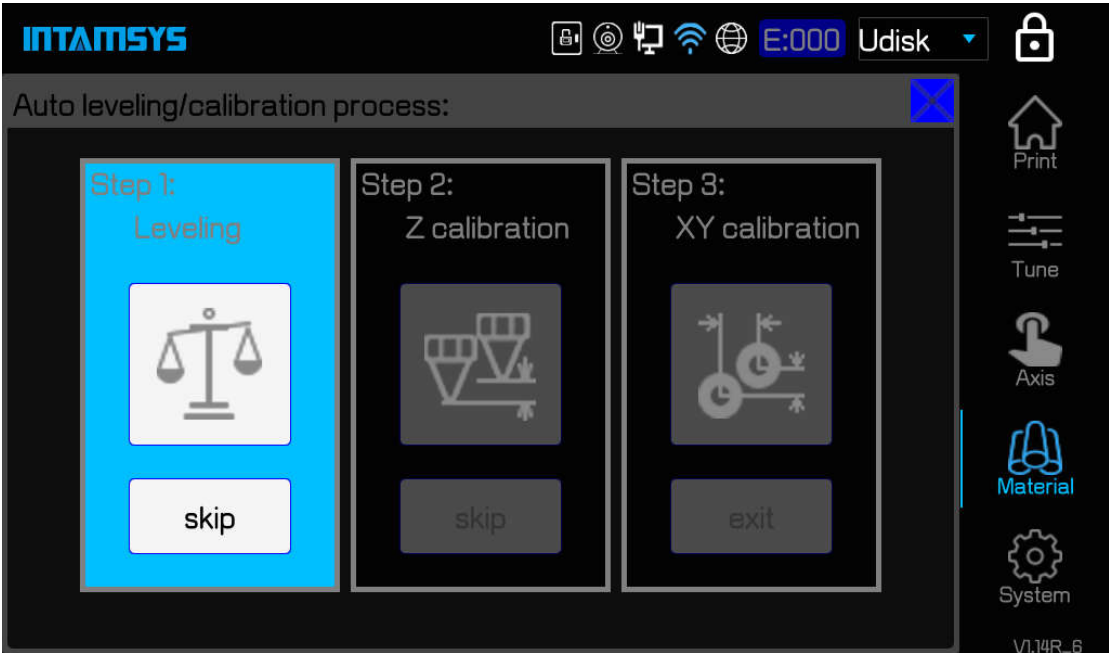

Figure 6. 3 XY offset calibration interface

6.2 Auto leveling and XYZ calibration

Auto leveling, mainly by virtue of the sensor installed on the left nozzle, measures the positions of 3 points on the buildplate, where the printer will determine by itself the relative position of the printing platform glass and the XY motion plane, and make real-time compensation by raising or lowering the Z axis in the process of printing. Even if the printing buildplate glass has a certain angle of inclination, the printing can also be executed by compensation. Same as the manual leveling, the auto leveling is realized by the left nozzle only.

In the “Material” interface, click “A” button to turn to the auto leveling and XYZ calibration interface. The three steps from left to right are Leveling, Z calibration and XY calibration respectively.



6 LEVELING AND CALIBRATION

Figure 6. 4 Auto leveling and XYZ calibration interface

Use may selectively perform any one or several steps, but the three steps from left to right must be performed in order. The step(s) not required may be skipped by clicking the “Skip” button under such step(s).

After different operations, the following table will guide user to selectively perform the step(s) among three.

Table 6.2 Conditions required for manual leveling and XYZ calibration (same as Table 6.1)

Use condition	Step I: Leveling	Step II: Z calibration	Step III: XY calibration
After replacement of left nozzle	•	•	•
After replacement of right nozzle		•	•
After replacement of new glass buildplate	•		
Leveling error	•		
Z calibration error		•	
XY calibration error			•

6.2.1 Auto leveling

1. Click the “Leveling” icon. A prompt dialog box will be popped up, prompting to clean the printing buildplate and chamber to prevent interference with the leveling operation. If the cleaning has been completed, click "OK" button to formally enter the manual leveling operation;
2. Firstly, carry out the leveling sensor triggering test. Heat the nozzle. After heating, it will prompt on the screen to uplift the left nozzle with scraper knife. After the test is passed, Triggering succeeded will be displayed on the screen. Click the “Next” button;
3. Calibration of the triggering distance of leveling sensor. Clean the nozzle and printing buildplate, and then place the filler gauge (in 0.2mm thick) between the nozzle and the printing buildplate glass. Click the "Z↑" / "Z↓" button to tune the up/down going of Z axis, so as to make the distance between the nozzle and the buildplate glass just fits the insertion of filler gauge;
4. Take out the filler gauge, and click the “Calibrate” button. Z axis buildplate glass firstly goes up to touch the nozzle, triggering the leveling sensor, and then goes down. Then click the “Next” button;
5. It will prompt on the screen to clean the printing buildplate. If the cleaning has been completed, click “Autolevel” button to prepare to enter the formal execution of auto leveling;
6. The printing buildplate and chamber will be preheated first. After they reach the preset temperature, the nozzle will be preheated. Finally the auto leveling will be executed. During the auto leveling, the nozzle will detect 3 points on the buildplate. After completion, it will prompt on the screen that the auto leveling is succeeded. It also will prompt to clean up the chamber. If the cleaning has been completed, click "Finish" button. The buildplate will go down to the bottom of the chamber and return. The auto leveling is so finished.

In following cases, please give up the auto leveling, and select manual leveling, of which the manual leveling is in higher accuracy.

- (1) The leveling sensor cannot be triggered or the triggering fails;
- (2) The left nozzle used for auto leveling cannot rebound or the rebound is not smooth;
- (3) The auto leveling fails;

(4) Failure of printing caused by error in auto leveling.

NOTE:

- Before the leveling, press the four magnet blocks with hand to make them be fully seated in the magnet holes of the hot bed, so as to exclude the gaps between them;
- The residual material on nozzle cusp should be cleared before leveling;
- Before leveling, the printing buildplate should be cleaned up without any printed piece, large piece of glue or other foreign matter remained on it;
- Before leveling, the chamber should be cleaned up to prevent a collision when the buildplate is being lowered;
- Be careful to prevent scald in operations as the nozzle is in high temperature during the leveling.

6.2.2 Z calibration

Completely consistent with the Z calibration in manual leveling, refer to 6.1.2.

6.2.3 XY calibration

Completely consistent with the XY calibration in manual leveling, refer to 6.1.3.

6.3 Calibration of Material Weight

As shown in the figure, the weight sensor in the material chamber is loaded with material roll, spooler and material. To obtain the accurate weight of material, the weight of material roll and spooler should be deducted.

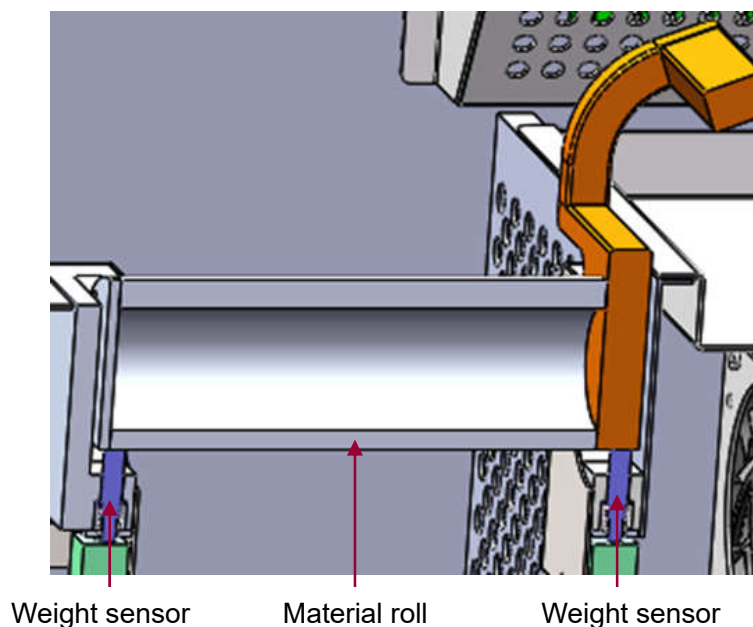

Figure 6. 5 Position of weight sensor in material chamber

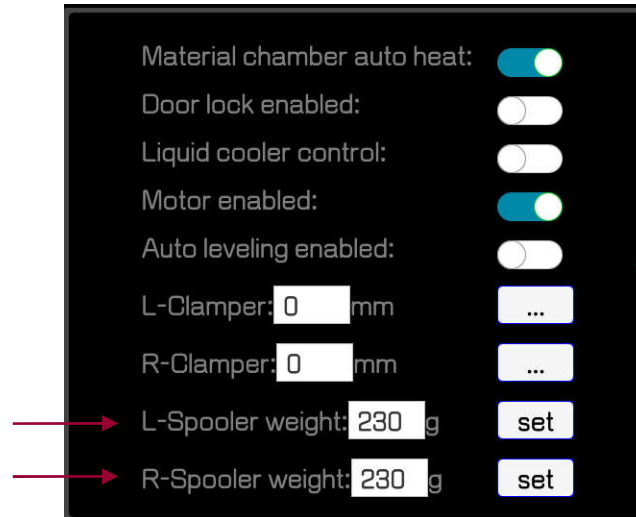

Figure 6. 6 Material calibration interface

Steps to calibrate the weight of materials in left and right bin are as below:

1. Click the blue "Wl" / "Wr" icon in Print interface to pop up a dialog box, and take off the material and spooler of left and right bin, and leave only the left and right material roll on the weight sensor;
2. Click "OK" button to complete the calibration;
3. Click "System" interface, input the weight of empty spoolers in the "L-Spooler" and "R-Spooler" input box respectively. The printer will automatically calculate the actual weight of left and right material, where the values are displayed at the "Wl" / "Wr" item in Print interface.

6.4 Calibration of the Clamp Force of Extruder

During the printing, the filament threads between the movable drive gear and the fixed driven gear, of which the driven gear can be moved to the left side or right side according to the directive from the printer, and there are spaces on the left and right for the limit switch to control the motion of driven gear.

The clamping value of left and right nozzle can be set at the item of "L-Clamper" and "R-Clamper" in the "System" interface, where the clamping value denotes the distance in mm of the forward movement of drive gear after triggering the position switch. The clamping value directly affects the smoothness of filament feeding. Generally, the greater the clamping value is, the smaller the distance between drive gear and driven gear will be. However, the clamping value shall be set in a suitable range. An excessively small clamping value will cause the under-extrusion of material; an excessively large clamping value will cause the drive gear bounced by the filament, and the distance between drive gear and driven gear will increase instead, also causing an under-extrusion of material.

To calibrate the clamping value, use the steel bar with 1.3mm of diameter in the accessory box as the calibration benchmark. and operate the calibration of clamping value according to the instructions on screen. Taking the calibration of "L-Clamper" as example, the steps are as below:

1. Retract the filament in left nozzle. (Click the "Material" button to enter the material interface; click "Set Temp(°C)" button, and wait for nozzle heating; when the temperature reaches the set value, the material in nozzle has been melted, long press "E↑" for over 3s to retract the material out of the nozzle range; finally disable the nozzle heating);
2. Press the quick snap joint and meanwhile pull out the feeding pipe;

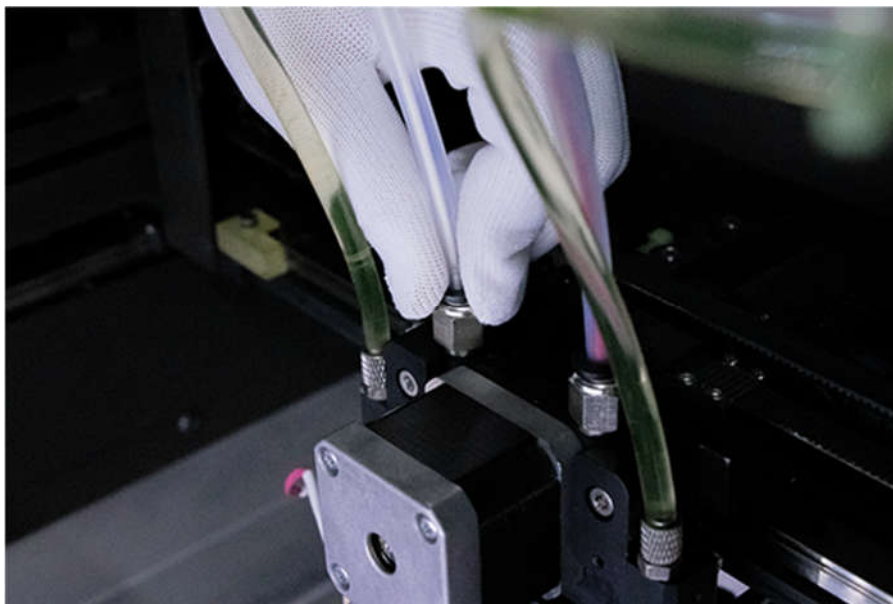
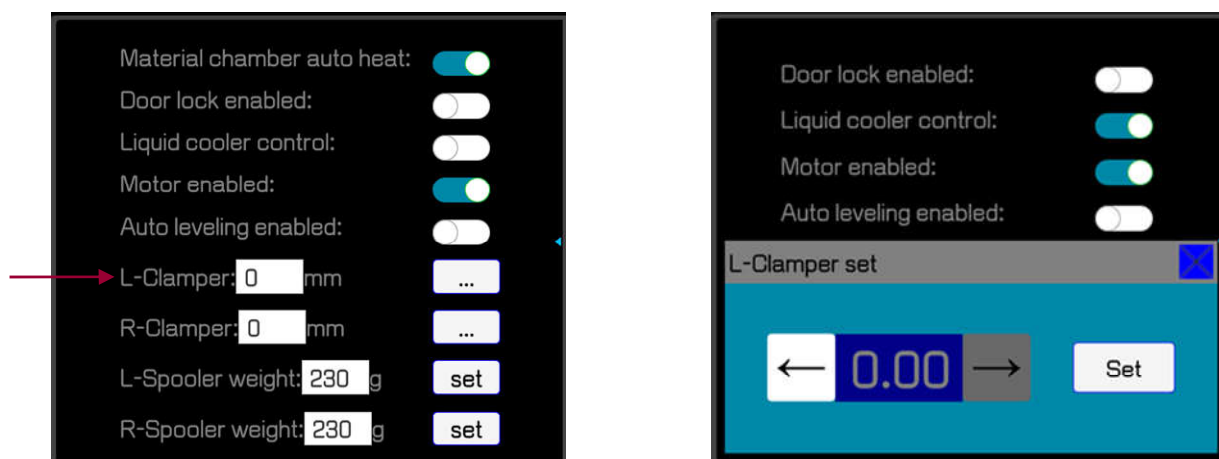

Figure 6. 7 Press the quick snap joint and pull out the feeding pipe

3. In the “System” interface, click the "Set" on the right side of the “L-Clamper”display box. At this



time, the nozzle is switched to left nozzle again, and the clamping value is refreshed to 0.

Figure 6. 8 Material calibration interface

4. Insert the clamping value calibration bar between the drive gear and the driven gear along the channel of filament. Pull the calibration bar up and down and meanwhile click the "←" button on screen until you feel the calibration bar just touches the gears on both sides. At this time, the drive gear just reach its suitable position. Click the "Set" button on screen to load the calibration value of clamp force.

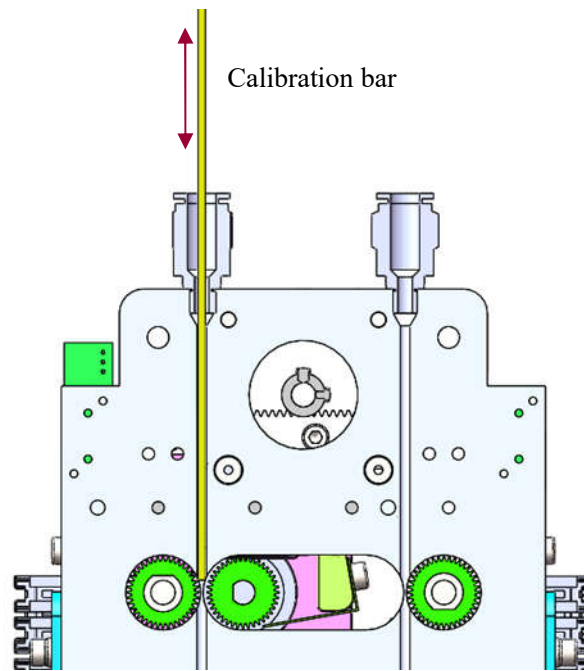

Figure 6. 9 Schematic diagram of calibration

5. The calibration is completed. Cut away the irregular part of the front end of filament with diagonal pliers, place the filament in the left nozzle again, insert the feeding pipe into the quick connector, heat the left nozzle and reload the filament into the left nozzle.
Refer to above left nozzle calibration method for the method to calibrate clamping value of right nozzle.

7 Maintenance

Correct and frequent maintenance not only is beneficial to prolonging the machine's service life, but also greatly improves your printing success rate and printing effect each time. The maintenance tasks that the user is required to perform on Pro410 are described in this chapter.

7.1 Inspections before Each Print

Inspections before print can ensure the safety of the printing process, and improve the printing success rate.

7.1.1 Inspect the printing buildplate

Inspection of buildplate glass:

1. Ensure the cleanliness of the glass plane. Where necessary, the glass shall be taken out of the chamber, be washed with water and be dried by wipe or oven;
2. Take the glass back to the hot bed. Ensure that the four contact salient points of the buildplate glass are firm without looseness and are reliably attach into the magnet holes in the hot bed;
3. Evenly apply glue on the glass surface.

7.1.2 Empty the printing chamber

The heated chamber may melt the filament remained on the chamber's base plate, which may adhere to the base plate. The foreign matters in the chamber under the hot bed may occupy the moving space of Z axis. So before printing, please clear all matters and material residues in the printing chamber carefully.

7.1.3 Inspect nozzles

To avoid the impact of material residues on nozzle on the printing quality of the printed product, the nozzles shall be inspected for cleanliness before each print. If not clean, the nozzle shall be heated to the melting temperature of the residual material, and be cleaned up with wooden handle brass wire brush.

7.2 Maintenance after Each Print

7.2.1 Clean the glass buildplate

After the completion of printing, lower the printing buildplate for certain distance, wear gloves and take out the glass buildplate together with printed piece from the printer, separate the printed piece from the glass buildplate with scraper, then clean up the glass buildplate and take it back to the hot bed.

7.2.2 Clean and replace the nozzle brush

After a print, some material may adhere to the nozzle brush. Please carefully clear all material and other

7 MAINTENANCE

foreign matters on the nozzle brush. If most of the brass wire cannot keep upright, the nozzle brush shall be replaced by a new one. As shown in following figure, the position of nozzle brush may be adjusted by up and down adjusting the 4 retaining screws on the nozzle brush support, so as to keep about 1mm of overlapping distance between the nozzle and the brush on Z axis direction.

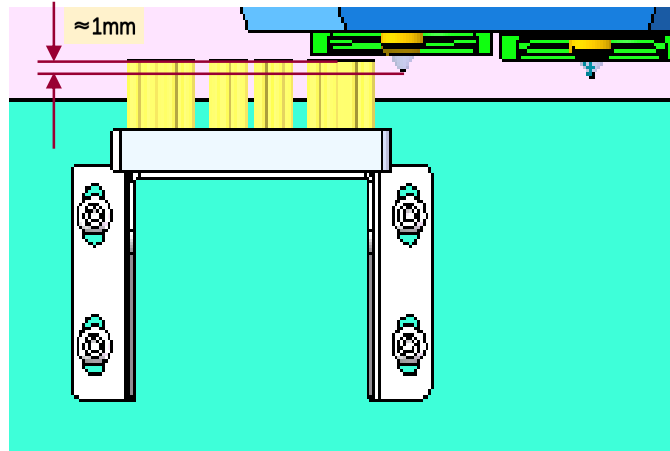

Figure 7. 1 Nozzle brush

7.2.3 Clean the chamber

In the process of printing, the nozzle brush will scrape some material fragments down to the chamber. So please carefully clean up the interior of chamber after each product is printed.

7.2.4 Clean the nozzle

After the completion of each print, the nozzle shall be inspected for any printing material adhering to its surface. To avoid the impact of residual material covering the nozzle on the nozzle's service life, and also to make better preparation for the next print, please pay close attention to the cleanliness of the nozzle surface. Where too much material adhere to the nozzle, the nozzle shall be heated and then be cleaned up by wooden handle brass wire brush.

7.3 Periodic Maintenance

7.3.1 Cleansing of the feeding gear of extruder

After long-term use, the more and more material fines cut off are accumulated in the gear groove of the feeding gear, causing the reduction in feeding force of the extruder. It is suggested to dismantle the front cover of the nozzle and inspect the gear grooves of the feeding gear for material accumulation once every month. Where necessary, carefully clear each gear groove with small brass wire bush, tweezers or similar tools.

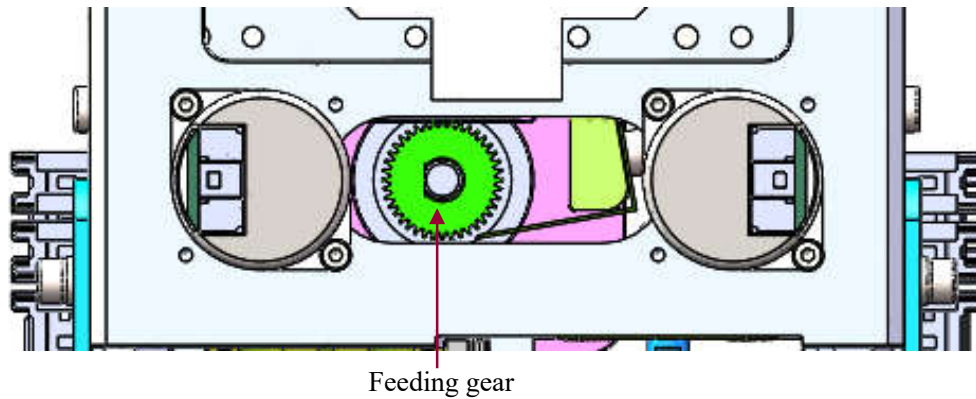

Figure 7. 2 Position of feeding gear

7.3.2 Maintenance of moving parts

The movement guiding unit of X axis and Y axis is linear guide rail. It is suggest to supplement perfluoropolyether lubricating grease once every 6 months for the linear guide rail(the left and right lateral plateneed to be dismounted to supplement perfluoropolyether lubricating grease for Y axis guideway).

The moving parts of Z axis include linear bearing and ball screw. It is suggested supplement perfluoropolyether lubricating grease (or lithium soap lubricating grease) once every 3 months (the back lateral plateneed to be dismounted).

Before supplementing grease, wipe up the surface of the moving parts with dust-free cloth dipped in alcohol, and then evenly apply grease on the surface.

7.3.3 Maintenance of chamber filter screen

Air filter screen is installed in the heating interlayer on the left side of the printing chamber. Screw off the bolts of the heating interlayer coverplate, and take out the interlayer coverplate to expose the filter screen. It is suggested to inspect or replace the filter screen once every 12 months.

7.3.4 Maintenance of feeding pipe and cooling pipe

Feeding pipe and cooling pipe, especially the sections inside the printing chamber, work in high temperature, so it is suggested to replace one of them every 12 months to avoid aging and causing reduction in flexibility.

As shown in following figure, there are four quick connectors at the position close to the rear in the upper part of the chamber. They are used to pass through and fix the two feeding pipe and two cooling pipes. The release cover of the quick connector is located at the rear part of the machine. Open the back plate of the machine, upward press the release cover of the quick connector, and extract the corresponding feeding pipe or cooling pipe from the rear, and then place the new feeding pipe or cooling pipe.

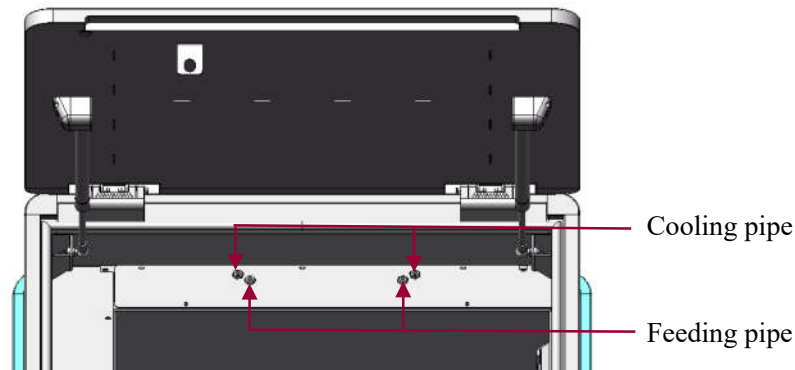

Figure 7. 3 Position of the feeding pipe and cooling pipe in the rear of chamber

7.3.5 Liquid coolant

The water-free liquid coolant of liquid cooler normally has two years of validity period (longer for individual products). When adding, confirm the product is within the validity period and remember to replace the liquid coolant before the expiration date.

7.4 Others

It is suggested to have personnel with certain professional knowledge make a thorough inspection of your machine before the one-year warranty period expires, to inspect whether the fans, heater, liquid cooler and other units are still in normal conditions. In case of any abnormal condition found, please contact with our local dealer. The inspection may require dismantling the protective parts, and place the units to be inspected in an observable state, which can be dangerous. Please take care of safety.

The latest version of firmware and screen software can be obtained from following website:

<https://www.intamsys.com/>

8 Troubleshooting

Some modes of trouble likely to occur in the process of printing, and the troubleshooting measures required after the occurrence of each type of trouble are listed in this chapter.

Please contact with our customer support in your area for any problem that you meet when following this User Manual for operations.

Table 8.1 List of Fault Codes

Error Code	Error Name	Error Type	Maintenance Action
105	Filament chamber T too high	remind	Check filament Chamber sensor and wire
123	Filament chamber door is open	remind	Close the filament chamber door
129	Cooling liquid T is high	remind	Check liquid T sensor or liquid-cooling compressor
130	L-Filament weight is probably not enough	remind	Check left filament
131	R-Filament weight is probably not enough	remind	Check right filament
212	L-Nozzle heating is too slow	warning	Check L-Nozzle heater
213	R-Nozzle heating is too slow	warning	Check R-Nozzle heater
214	Buildplate heat is too slow	warning	Check buildplate sensor or heater
215	Chamber heat is too slow	warning	Check chamber sensor or heater
217	L-Extruder is out of material	warning	Check load/change the material for L-Extruder
218	R-Extruder is out of material	warning	Check load/change the material for R-Extruder
219	L-Extruder is in feeding error	warning	Check left feeding system, nozzle, filament and encoder wire
220	R-Extruder is in feeding error	warning	Check right feeding system, nozzle, filament and encoder wire
221	Chamber front door is open	warning	Close the front door
222	Chamber top door is open	warning	Close the top door
224	L-Extruder switch position abnormal	warning	Try to switch extruder, if error still exists, recalibrate L-clamper or re-adjust limit sensor
225	R-Extruder switch position abnormal	warning	Try to switch extruder, if error still exists, recalibrate R-clamper or re-adjust limit sensor
235	L-Nozzle leveling sensor is triggered	warning	Check if left nozzle leveling sensor position state, wire or connector

8 TROUBLESHOOTING

Error Code	Error Name	Error Type	Maintenance Action
237	Cooling liquid T is too high	warning	Check liquid T sensor or liquid-cooling compressor
238	Cooling liquid level is too low	warning	Add liquid / check liquid level sensor
301	L-Nozzle T too high	error	Check L-Nozzle sensor or heater
302	R-Nozzle T too high	error	Check R-Nozzle sensor or heater
303	Buildplate T too high	error	Check buildplate sensor or heater
304	Chamber T too high	error	Check chamber sensor or heater
306	L-Nozzle T Sensor wire is broken	error	Check L-Nozzle sensor wire
307	R-Nozzle T Sensor wire is broken	error	Check R-Nozzle sensor wire
308	Buildplate T Sensor wire is broken	error	Check buildplate sensor wire
309	Chamber T Sensor wire is broken	error	Check chamber sensor wire
326	Buildplate overheating switch is triggered	error	Check the buildplate heater or overheat switch wire
332	X limit switch is triggered	error	Check if layer shift happens or exceeding X range
333	Y limit switch is triggered	error	Check if layer shift happens or exceeding Y range
334	Z limit switch is triggered	error	Check if leveling is ok or exceeding Z range
370	Serial com error(FW)	error	Power off and restart the printer
371	Serial com error(SW)	error	Power off and restart the printer
406	Power is down (leftnozzle)	error	Check the power supply
416	Power is down (rightnozzle)	error	Check the power supply