

Haloview

User Manual



MC7108

720P Wireless Monitor Camera System

Please read all instructions carefully before using, and keep the manual for future reference.

V1.2

Contents

1. Precautions	1
2. Accessories	3
3. Features	4
4. Specifications	4
5. Functions of each part	5
6. Basic Operation	6
7. Trigger Wire Function	7
8. Wiring Instruction	8
9. Installation	9
10. Menu	11
10.01 Button Function	11
10.02 Menu	11
10.03 Volume	12
10.04 Picture	12
10.05 Mirror	13
10.06 Qmode	13
10.07 Setting	14
10.08 Autoscan	15
10.09 Park-line	16
10.10 Record	17
10.11 Play Recorded File	19
10.12 Pairing	20
11. Troubleshooting	21

1 Precautions

● Storage

1. Do not expose the monitor to extreme heat, cold, or sudden temperature changes. The storage temperature of this device is -30 to +80°C or -22 to +176°F. The operating temperature is -20 to +70°C or -4 to 158°F with the humidity under RH90%.
2. Never use this device in environments with excessive moisture, dust or smoke.
3. Avoid dropping or striking this device.
4. Never puncture, scratch or use abrasive cleaning materials on this device.
5. Leave at least a 2" space between the monitor and walls, cabinets or other objects to allow adequate air circulation around the device.
6. The monitor is not designed to be waterproof.

● Operating Precautions

1. The device can be powered by a 10 -32 volt automotive battery or vehicle electrical system.
2. Improper cable connections may damage the monitor. Remove the power cable connections when you do not intend to use the device.

Warning

1. High voltage is present within the monitor. The opening of the case should be by professionals.
2. Do not watch the video while driving unless you are monitoring the rear view camera display.

Special Notice

Occasionally, a few highlights or dark spots may occur on the LCD screen. This is a very common phenomenon in active matrix display technology, and doesn't necessarily indicate any defects or faults. Never try to repair this device by yourself. In case of any problems, please turn off the display at once and notify our company or authorized dealer. The monitor is a complex device. Any disassembly or modification may lead to damage and void the warranty.

● Maintenance

1. Remove all the cable connections from the monitor before cleaning the device.
2. Use a mild household detergent and clean the unit with a slightly damp, soft cloth. Never use strong solvents such as thinner or benzine, as they might damage the finish of the device.

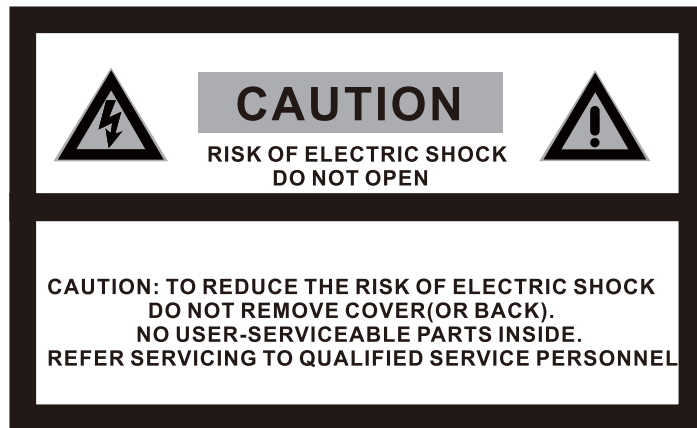

This symbol is intended to alert the user to the presence of uninsulated "dangerous voltage" within the product's enclosure that may be of sufficient magnitude to constitute risk of electric shock to persons.



This symbol is intended to alert the user to the presence of important operating and maintenance (servicing) instructions in the literature accompanying the appliance.

● **Declaration of conformity**

This device complies with Part 15 of the FCC Rules. Operation is subject to the following two conditions:

- (1) This device may not cause harmful interference.
- (2) This device must accept any interference received, including interference that may cause undesired operation.

FC RED

2 Accessories

 U-Support Bracket X 1	 Center Mount Bracket X 1	 Sun Shield X 1
 Trigger Wires X 1	 Angle Adjustment Screws X 4	 Cigarette Lighter X 1
 Camera conversion cable X 1	 BMW connector adaptor X 1	 User Manual X 1

Special Notice

Accessories supplied in kit may be different for each application.

3 Features

1. NORMAL, MIRROR, FLIP and MIR-FLIP viewing available.
2. Split mode, auto-scan mode and single-display mode available.
3. Auto pairing: Auto pairing happens when camera is activated.
4. Support 4-channel composite and single-channel recording in AVI signal format.
5. Auto dim function available.
6. 4 wireless camera inputs.
7. Video input: 720P.
8. Wide voltage input: 10 - 32V.

4 Specifications

LCD size	7" 16:9
Resolution	1024 x 3 (RGB) x 600
Contrast	800:1
Brightness	500 cd/m ²
Viewing Angle	U/D: 85, R/L: 85
Aspect Ratio	16:9
Channel	4 channels
Operating Frequency	2400 - 2483.5 MHz
Receiving Sensitivity	-85 dBm
Video Compression	H.264
Latency	200ms
Transmitting Distance	984ft line of sight
Micro-SD /TF Card	Max. 128G
Video Format	AVI
Power Supply	DC 10-32V
Power Consumption	Max. 8W
Loudspeaker	1W/8Ω
Operating temperature	-20~+70°C,RH90%
Storage temperature	-30~+80°C,RH90%

5 Functions of each part

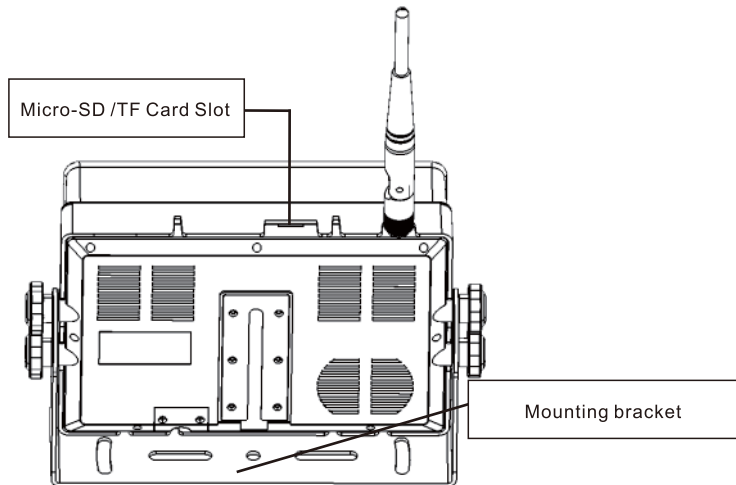
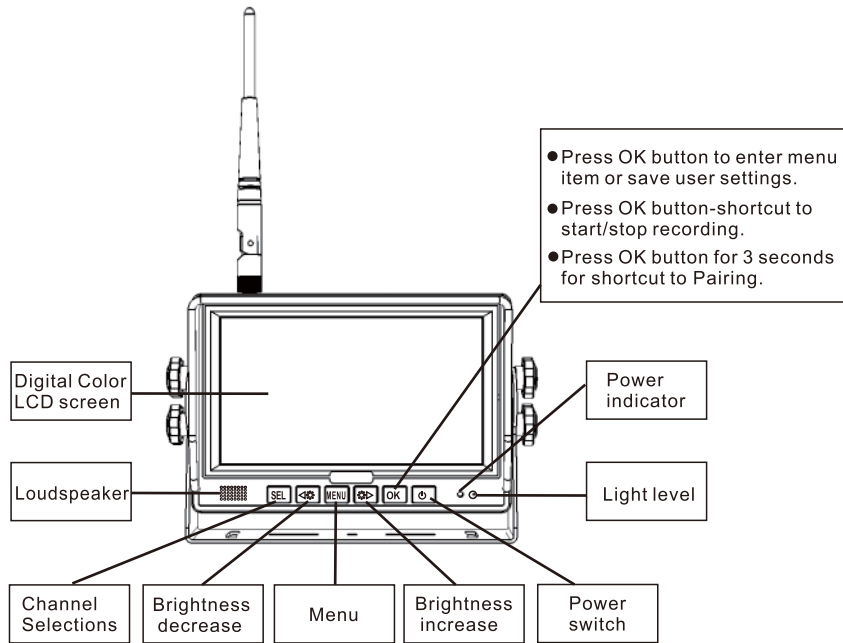

6 Basic Operation

1) Installation of Center Mounting Bracket:

- ① Adjust monitor height by sliding monitor up or down in slot, then tight knob.
- ② Adjust monitor angle by loosening lower knob on center mounting bracket, tilting monitor to desired angle, and re-tighten knob.

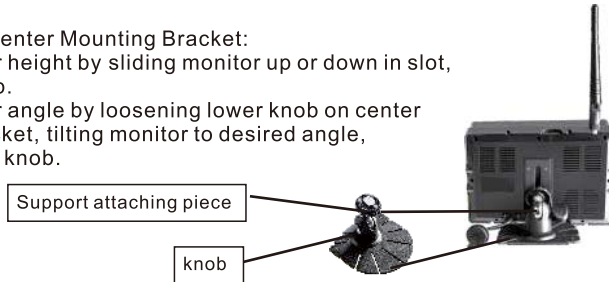

2) Installation of U-support Bracket

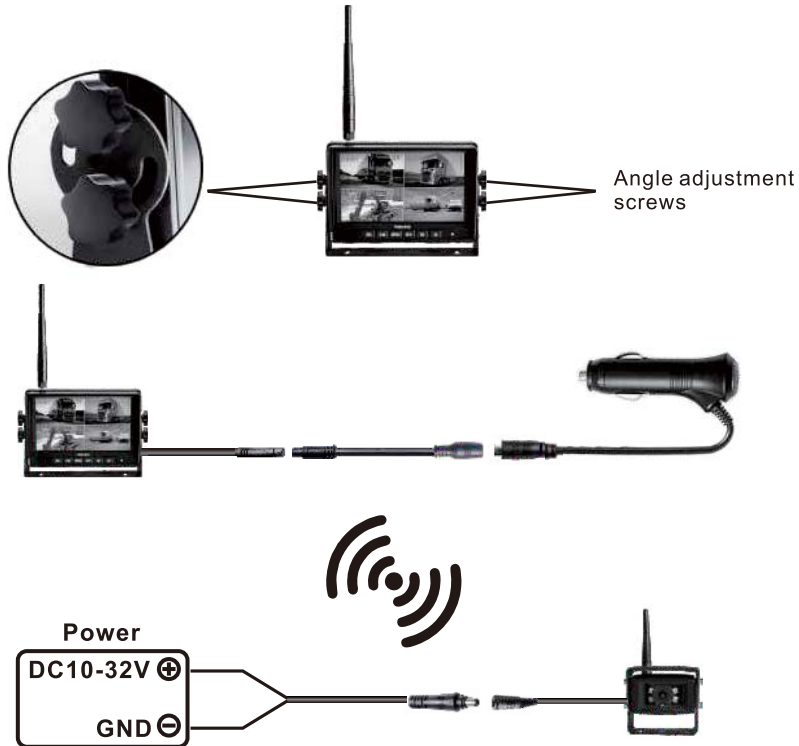

7 Trigger Wire Function



7 PIN Cable Wiring Instruction

Power Wire	
Red Wire	DC IN 10-32V (Positive Wire)
Black Wire	GND (Negative Wire)
Trigger Wire	
Brown Trigger Wire	When it's activated, the monitor automatically switches to CAM1. All buttons invalid once Brown Trigger Wire triggered
Blue Trigger Wire	When it's activated, the monitor automatically switches to CAM2. (left side camera). All buttons invalid once Blue Trigger Wire triggered
Purple Trigger Wire	When it's activated, the monitor automatically switches to CAM3. (right side camera). All buttons invalid once Purple Trigger Wire triggered
Green Trigger Wire	When it's activated, the monitor automatically switches to CAM4. (rear view camera). All buttons invalid once Green Trigger Wire triggered
Yellow Trigger Wire	When it's activated, the monitor automatically switches to quad or split display. Connection depends on the application request. All buttons invalid once Yellow Trigger Wire triggered.

Trigger Function Introduction

1. When brown/blue/purple/green/yellow wires triggered at the same time by 10-32V, the monitor will display CAM4 as a default priority choice.
2. The proper installation of trigger wires will save battery power. The system will use very little power when monitor is in standby mode. Once any trigger wire is triggered, corresponding channel of CAM will be activated and displayed on the monitor. The system will reenter low power consumption status when triggered wire deactivated.
3. For multi cameras, trigger wires can help switch screen display automatically without pressing SEL button to avoid diverting the driver's attention during driving.

⑧ Wiring Instruction

Camera Wiring

Power on the camera by connecting the Red positive wire to 10 - 32 VDC power source, Black to Negative/Ground source, and connecting camera plug.



Monitor Wiring

Wiring Without Trigger Wires

This is the most commonly used method for users who have the single camera system. (one monitor and one camera). Connect the monitor with BMW connector adaptor, connect the DC connector of BMW connector adaptor to cigarette lighter. Power the monitor by vehicle 12V through cigarette lighter.



For more cameras, extra cameras can be paired separately to CAM1/CAM2/CAM3/CAM4. Please refer to page 20 PAIRING.

Wiring With Trigger Wires

If you are familiar with automobile wiring, you can try wiring with trigger wires.



Red wire connects to automobile positive power supply, 10 - 32VDC.
Black wire connects to automobile negative power supply, GND.

Blue trigger wire connects to positive wire of left turn signal light. When left turn signal light turned on, the display will automatically switch to CAM2.

Purple trigger wire connects to positive wire of right turn signal light. When right turn signal light turned on, the display will automatically switch to CAM3.

Green trigger wire connects to positive wire of rear view signal light. When rear view signal light turned on, the display will automatically switch to CAM4.

Brown trigger wire and Yellow trigger wire connects to other positive wires, which depends on your application requirements.

Note: If power supply is only energized when the ignition is on, then your monitor will not operate unless the automobile is running.

⑨ Installation

Please find best signal reception position before installation

The metal body of the vehicle can attenuate wireless signal strength sharply. It is necessary to test the signal strength before installation.

- ① Please connect monitor and camera as below picture

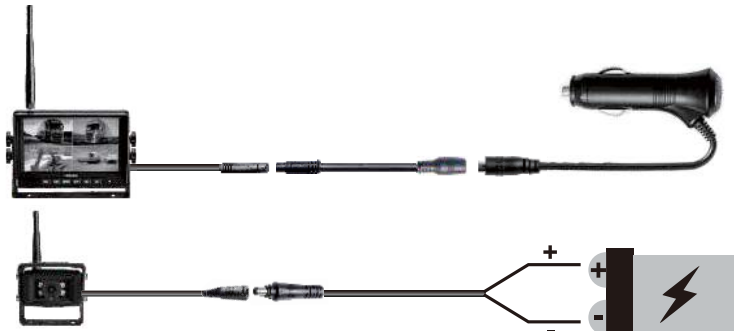

- ② Pairing the camera to the monitor, please refer to page 20 PAIRING. 4 cameras can be paired separately to CAM1/CAM2/CAM3/CAM4.
- ③ Put the monitor and the camera at the intended position to test signal strength.

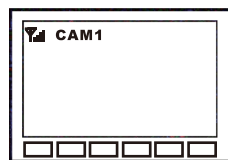

Good signal

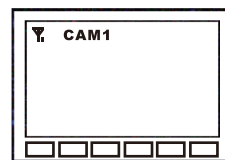

Poor signal

If signal strength of the position that you planned to install a camera is under 3 bars, please change to another position, or mount the camera higher to make sure the antenna highest of the top without being blocked. Please refer to below pictures:

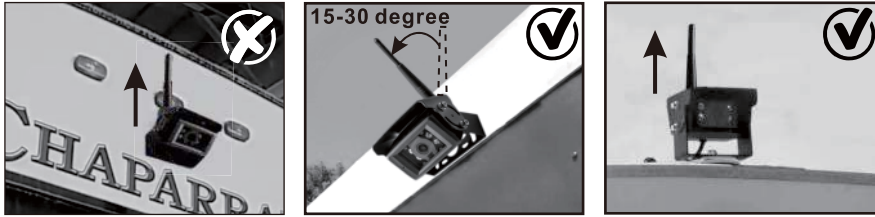

Installation Position 1: Mount the camera higher than your vehicle's roof, keeping the antenna vertical.

Installation Position 2: Mount the camera lower but as close as possible to vehicle's roof, and move the antenna outward **15-30 degree**. The antennas proximity to any metal surfaces on the vehicle may affect signal strength.

⚠ Special Notice

After position adjustment, you can start installation if your signal strength is still above 3 bars.

Installation

1) Antennas should be vertically lined to the ground. Make sure there is no obstacle around antennas.

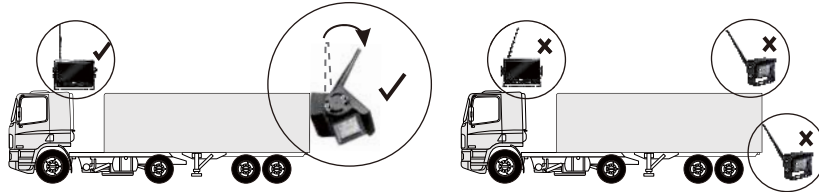

2) Magnet based extension antenna should be attached on the top of the vehicle. Make sure there is no obstacle around.

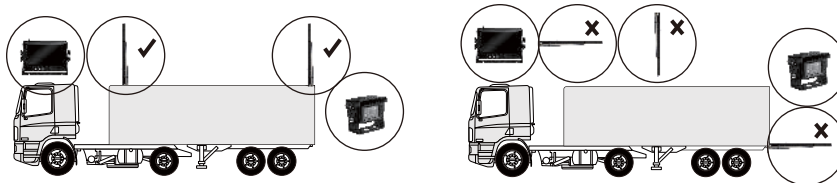

Antenna

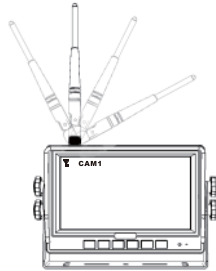

If you get poor signal reception, or signal cannot reach at least 3 bars, please adjust the angle of antenna to find best signal reception position.

10 Menu

10.01 Button Function



Button	Function
SEL	Switch among cameras
◀☼	Decrease brightness
MENU	Enter menu or return to previous menu
☼▶	Increase brightness
OK	Function① : "Start recording" and "pause recording" Function② : "Start playing" and "pause playing" in video playback interface. Function③ : Press for 3 seconds to enter pairing status Function④ : Press OK button to enter menu item or save user settings.
⏻	Turn on/off monitor and standby

10.02 Menu

1) Press menu button to enter below interface.

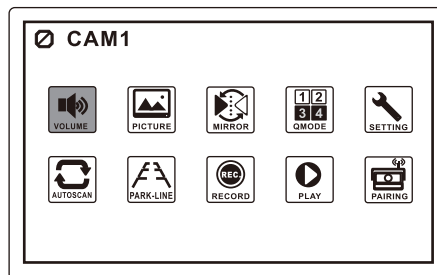

10.03 Volume

MENU is only allowed for operation under single image mode, not quad mode.
Press MENU to display the following options and settings:

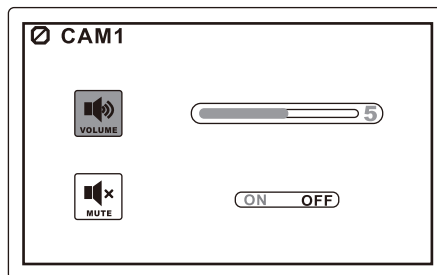

2) Press ◀⚙ or ⚙▶ to select VOLUME, Press OK to confirm. Press ◀⚙ or ⚙▶ to adjust settings.

3) Press ◀⚙ or ⚙▶ and OK button to set MUTE or UNMUTE.

10.04 Picture

1) Press MENU button to enter menu interface.

2) Press ◀⚙ or ⚙▶ to select PICTURE, Press OK to enter.

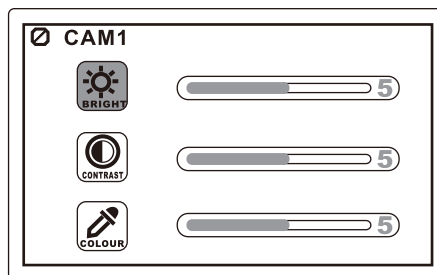

3) Press ◀⚙ or ⚙▶ to select BRIGHTNESS/CONTRAST/COLOR, Press OK to confirm. Press ◀⚙ or ⚙▶ to adjust settings.

10.05 Mirror

1) Press MENU button to switch to enter menu interface. Press ◀⚙ or ⚙▶ to select MIRROR. Press OK button to enter MIRROR setting.

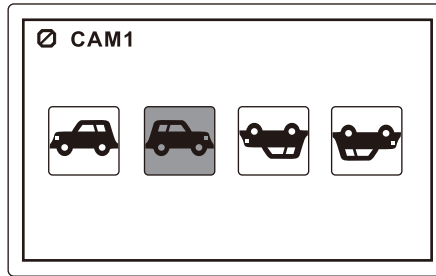

2) Press ◀⚙ or ⚙▶ to select NORMAL/MIRROR/MIR-FLIP/FLIP.

10.06 QMODE

1) Press MENU button to enter menu interface. Press ◀⚙ or ⚙▶ and OK button to enter QMODE.

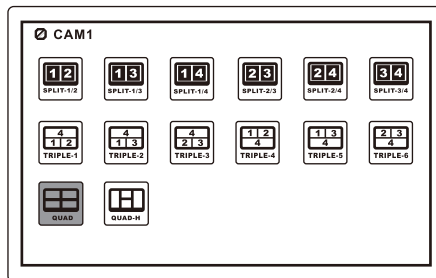

2) Press ◀⚙ or ⚙▶ to select display mode.

3) After setting, press SEL button to change display mode. For example, If you set QUAD mode “”

Pressing SEL button 4 times, the display will switch CAM1 to QUAD.

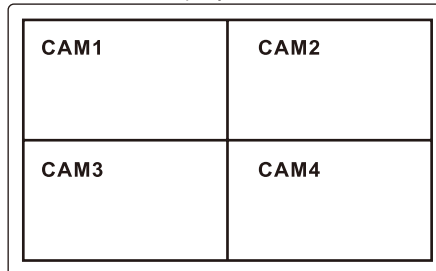



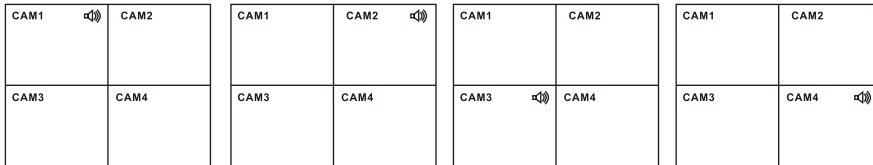

4) Quad or Split Audio Setting



When the monitor display Quad or Split picture, you can press  or  button to play audio of any of the CAM channel.

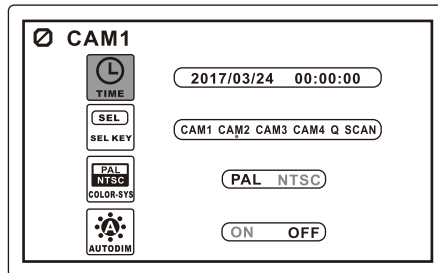

10.07 Setting

- 1) Press MENU button to enter menu interface. Press  or  to select SETTING. Press OK button to enter SETTING.
- 2) SEL KEY: User defined CAM switching. For example, if CAM1, CAM2, Q(QUAD MODE) are selected, When pressing SEL key, the display will switch from CAM1 to CAM2, and QUAD MODE, it will skip CAM3, CAM4, and SCAN.
- 3) Press OK to move selection, press  or  key to select or cancel. The bottom yellow dot indicates current selection.



ICON	FUNCTION
	Set current time. Please make sure your setting is correct, otherwise the time display on recorded videos will be incorrect.
	Set video format of the camera. Please refer to below table.
	When the option is turned "ON", monitor will automatically decrease brightness in low light. Or you can turn "OFF" the auto-dim function.

VIDEO FORMAT	COUNTRY
PAL	Argentina, Australia, Austria, Belgium, Brazil, Bulgaria, China, Cyprus, Czechoslovakia, Denmark, Dubai, Egypt, Finland, France, Germany, Gibraltar, Greece, Hungary, Iceland, India, Indonesia, Ireland, Israel, Italy, Jordan, Kuwait, Luxembourg, Malaysia, Netherlands, New Zealand, Norway, Sultanate of Oman, Poland, Portugal, San Marino, Saudi Arabia, Singapore, Spain, Sweden, Switzerland, Turkey, United Kingdom,
NTSC	Bolivia, Canada, Chile, Colombia, Costa Rica, Ecuador, Japan, South Korea, Mexico, United States

2) Press ◀⚙ or ⚙▶ and OK button to set TIME/PAL-NTSC/AUTODIM.

10.08 Autoscan

1) Press MENU button to enter menu interface. Press ◀⚙ or ⚙▶ and OK button to enter AUTOSCAN setting.

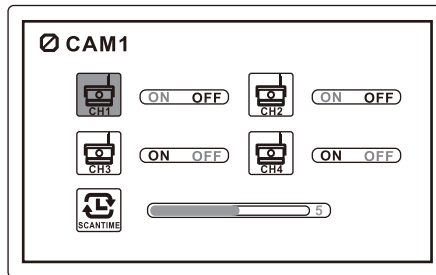

2) Press ◀⚙ or ⚙▶ and OK button to set AUTOSCAN channels and SCANTIME.

3) Press SEL button to switch to SCAN interface. A SCAN icon will appear on the display. Press again to exit SCAN mode.

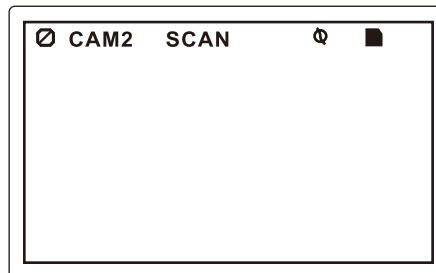

10.09 Park-line

1) Press MENU button to enter menu interface. Press ◀⚙ or ⚙▶ and OK button to enter PARK-LINE.

Display: To set the park line display in a certain channel of CAM. Press ◀⚙ or ⚙▶ button to select, press OK button to confirm.

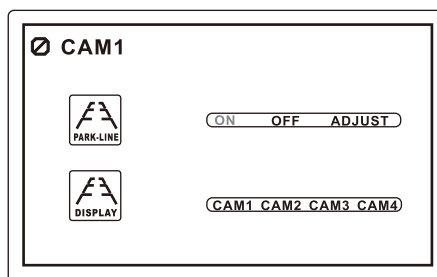

2) Turn on/off parking lines or enter adjust parking lines setting.

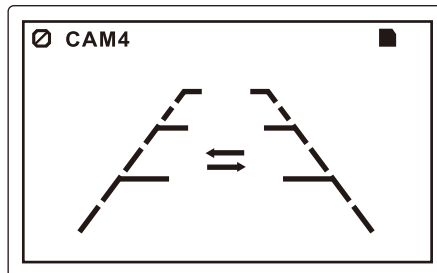

3) Press ◀⚙ or ⚙▶ button to adjust the position of parking lines.

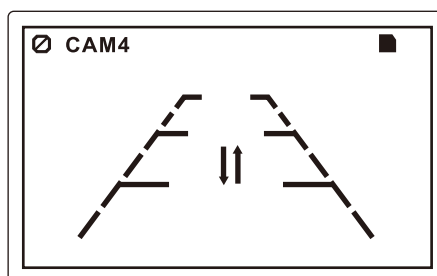

4) Press ◀⚙ or ⚙▶ button to adjust the position of parking lines

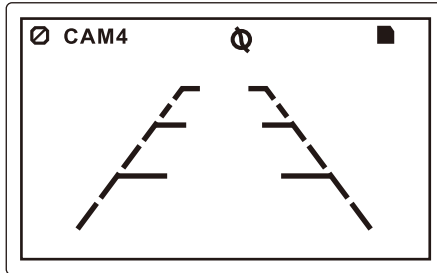

5) **Note:** Park line display in CAM4 as default, but it is settable if you want it display in other channels of CAM.

10.10 Record

1) Insert TF Card

Please insert TF card in TF card slot, max 128G Micro-SD/TF Card

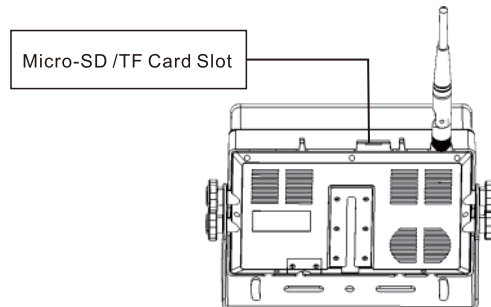

2) Format the TF card.

Note: TF card must be formatted before using.

Press MENU button to enter menu interface, and enter RECORD setting

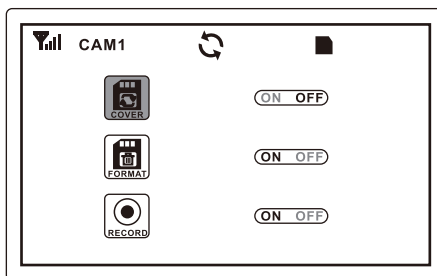

When COVER is turned on, overwrite function will be activated. Previous recorded video files will be overwritten when TF card memory is full.

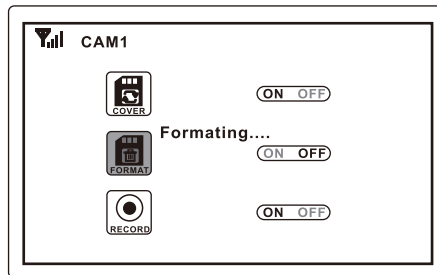

After TF card formatted, a yellow folder icon will be shown on the screen, indicating TF card is available now.

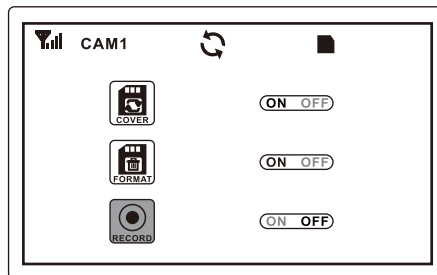

3) After setting, turn on RECORD to start recording or pause recording, or, you can press OK button to start recording or pause recording.



Note: Pressing OK button in QUAD or SPLIT display, the monitor will record all displayed channel of CAM at the same time.

10.11 Play Recorded File

Recorded videos can be played by monitor.

- 1) Press ◀⚙ or ⚙▶ and OK button to enter PLAY.
- 2) Press ◀⚙ or ⚙▶ and OK button to select a file.

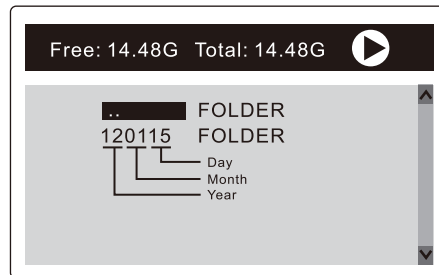

- 3) Press ◀⚙ or ⚙▶ to select TIME& CHANNEL, Press OK to enter.

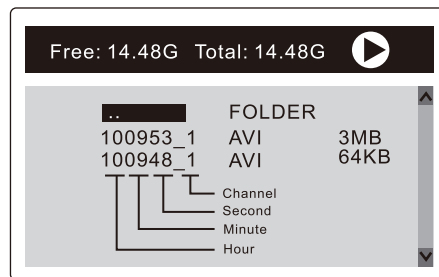

- 4) Press OK button to PLAY or PAUSE the file.

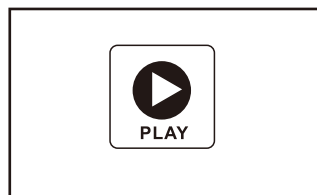
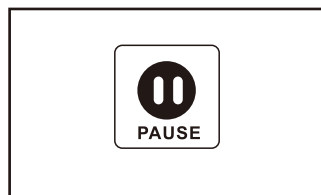

Recording Time

For Micro SD cards with different capacities, please refer to the table below for recording time under 3 different image modes.

This table is for reference only.
Data may vary under different environments.

MODE \ TF	8G	16G	32G	64G	128G
SINGLE (1280x720x1)	9H	18H	36H	72H	144H
QUAD (512x352x4)	10H	20H	40H	80H	160H
SPLIT (512x592x2)	11H	22H	44H	88H	176H

10.12 Pairing

Camera and monitor are paired at the channel of CAM 4 as factory default setting. When you open the box, power on the monitor and camera, press SEL button to switch to CAM 4, the image will be displayed. Otherwise, please try below methods for pairing.

Please finish pairing before installation.

- 1) Press SEL button to select a channel that needs to be paired.
- 2) Monitor Pairing
 - Method 1: Enter menu interface and select PAIRING, press OK to confirm, you will have 20 seconds for pairing.
 - Method 2: Press OK button for 3 seconds to enter PAIRING status, you will have 20 seconds for pairing.

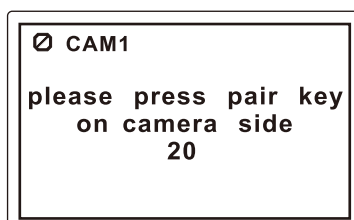

- 3) Camera Pairing
 - Method 1: Press the pairing button on the back of the camera.
 - Method 2: Power off the camera and power on it again.

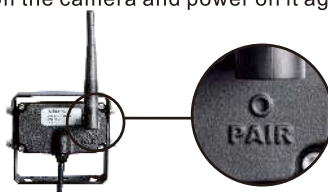

- 4) Video will be displayed after pairing complete.

Special Notice

If no picture displayed after pairing, please retry pairing steps and power-on again the camera. The pairing must be completed within 20 seconds, otherwise you need to re-power the camera for pairing.

11 Troubleshooting

The symptoms described below do not necessarily mean a failure within the display. Please check the following items before you initiate request for repair.

Symptoms	Possible Causes/Solutions
No picture No sound	Improper connection of automobile adapter. Use of unauthorized power supply. Power switch is OFF. Please re-pairing the system. Refer to page 20 PAIRING.
No signal	Check whether the camera is powered on. Please check whether antennas are plugged on both monitor and camera. Please check the angle of the antenna. Please check whether metal obstacles near the antenna. Please re-pairing the system. Refer to page 20 PAIRING.
No sound	Check whether the sound volume is turned off or set too low.
Dark picture	Check whether brightness and contrast are adjusted correctly.
No color	Adjust the HUE settings.
Button invalid	All Button invalid when trigger wire is activated. Please deactivate trigger wire signal to get the button function valid. For example, you need to turn off LEFT TURN light or REVERSING light to deactivate trigger wire signal of CAM2 or CAM4. MENU button invalid in split display. If MENU button invalid, please check whether it is under split display. You need to switch to single display by pressing SEL button to get the MENU button valid.
Unable to record	Please check whether TF card inserted Please check whether TF card formatted before recording Please check whether TF card storage full

The monitor is equipped with Anti-Glare screen. Please remove the screen protector to get best picture quality after installation.

Haloview
www.haloview.com



FCC WARNING

This device complies with part 15 of the FCC Rules. Operation is subject to the following two conditions: (1) this device may not cause harmful interference, and (2) this device must accept any interference received, including interference that may cause undesired operation.

Any changes or modifications not expressly approved by the party responsible for compliance could void the user's authority to operate the equipment.

NOTE: This equipment has been tested and found to comply with the limits for a Class B digital device, pursuant to Part 15 of the FCC Rules. These limits are designed to provide reasonable protection against harmful interference in a residential installation. This equipment generates, uses and can radiate radio frequency energy and, if not installed and used in accordance with the instructions, may cause harmful interference to radio communications. However, there is no guarantee that interference will not occur in a particular installation. If this equipment does cause harmful interference to radio or television reception, which can be determined by turning the equipment off and on, the user is encouraged to try to correct the interference by one or more of the following measures:

- Reorient or relocate the receiving antenna.
- Increase the separation between the equipment and receiver.
- Connect the equipment into an outlet on a circuit different from that to which the receiver is connected.
- Consult the dealer or an experienced radio/TV technician for help.

To maintain compliance with FCC's RF Exposure guidelines, This equipment should be installed and operated with minimum distance between 20cm the radiator your body: Use only the supplied antenna.