

# FCC TEST REPORT

Client Name : AuVerte AG

Address : Rothusmatt 14, CH-6300 Zug, Switzerland

Product Name : Ondur C504

Date : Sept. 03, 2020



**Shenzhen Anbotek Compliance Laboratory Limited**

# Contents

1. General Information.....	5
1.1. Client Information.....	5
1.2. Description of Device (EUT).....	5
1.3. Auxiliary Equipment Used During Test.....	5
1.4. Description of Test Modes.....	5
1.5. List of channels.....	6
1.6. Description Of Test Setup.....	7
1.7. Test Equipment List.....	8
1.8. Measurement Uncertainty.....	9
1.9. Description of Test Facility.....	9
2. Summary of Test Results.....	10
3. Conducted Emission Test.....	11
3.1. Test Standard and Limit.....	11
3.2. Test Setup.....	11
3.3. Test Procedure.....	11
3.4. Test Data.....	11
4. Radiation Spurious Emission and Band Edge.....	16
4.1. Test Standard and Limit.....	16
4.2. Test Setup.....	16
4.3. Test Procedure.....	17
4.4. Test Data.....	18
5. Output Power Test.....	26
5.1. Test Standard and Limit.....	26
5.2. Test Setup.....	26
5.3. Test Procedure.....	26
5.4. Test Data.....	26
6. 6DB Occupy Bandwidth Test.....	29
6.1. Test Standard and Limit.....	29
6.2. Test Setup.....	29
6.3. Test Procedure.....	29
6.4. Test Data.....	29
7. Power Spectral Density Test.....	32
7.1. Test Standard and Limit.....	32
7.2. Test Setup.....	32
7.3. Test Procedure.....	32
7.4. Test Data.....	32
8. 100kHz Bandwidth of Frequency Band Edge Requirement.....	35
8.1. Test Standard and Limit.....	35

8.2. Test Setup..... 35

8.3. Test Procedure..... 35

8.4. Test Data..... 35

9. Antenna Requirement..... 39

9.1. Test Standard and Requirement..... 39

9.2. Antenna Connected Construction..... 39

PENDIX I -- TEST SETUP PHOTOGRAPH..... 40

APPENDIX II -- EXTERNAL PHOTOGRAPH..... 42

APPENDIX III -- INTERNAL PHOTOGRAPH..... 45



# TEST REPORT

Applicant : AuVerte AG  
Manufacturer : Display electronics (Shenzhen)co.,ltd  
Product Name : Ondur C504  
Model No. : 003001.C504  
Trade Mark :  AuVerte  
Rating(s) : Input: DC 5V, 50mA

**Test Standard(s) : FCC Part15 Subpart C 2019, Section 15.247**

**Test Method(s) : ANSI C63.10: 2013, KDB558074 D01 DTS Meas Guidance v05r02**

The device described above is tested by Shenzhen Anbotek Compliance Laboratory Limited to determine the maximum emission levels emanating from the device and the severe levels of the device can endure and its performance criterion. The measurement results are contained in this test report and Shenzhen Anbotek Compliance Laboratory Limited is assumed full of responsibility for the accuracy and completeness of these measurements. Also, this report shows that the EUT (Equipment Under Test) is technically compliant with the FCC Part 15 Subpart C requirements.

This report applies to above tested sample only and shall not be reproduced in part without written approval of Shenzhen Anbotek Compliance Laboratory Limited.

Date of Receipt : May 29, 2020  
Date of Test : May 29~Jun. 15, 2020

Prepared By :   
\_\_\_\_\_  
(Engineer / Dolly Mo)

Reviewer :   
\_\_\_\_\_  
(Supervisor / Bibo Zhang)

Approved & Authorized Signer :   
\_\_\_\_\_  
(Manager / Tom Chen)

# 1. General Information

## 1.1. Client Information

Applicant	:	AuVerte AG
Address	:	Rothusmatt 14, CH-6300 Zug, Switzerland
Manufacturer	:	Display electronics (Shenzhen)co.,ltd
Address	:	No.1,Fifth Road, Yangyong Industrial Park, Shapu Community, Songgang, Bao An District, Shenzhen, China
Factory	:	Display electronics (Shenzhen)co.,ltd
Address	:	No.1,Fifth Road, Yangyong Industrial Park, Shapu Community, Songgang, Bao An District, Shenzhen, China

## 1.2. Description of Device (EUT)

Product Name	:	Ondur C504	
Model No.	:	003001.C504	
Trade Mark	:	 AuVerte	
Test Power Supply	:	AC 120V, 60Hz for adapter / AC 240V, 60Hz for adapter	
Test Sample No.	:	1-2-1(Normal Sample), 1-2-2(Engineering Sample)	
Product Description	:	Operation Frequency:	2405-2480MHz
		Number of Channel:	16 Channels
		Modulation Type:	O-QPSK
		Antenna Type:	Ceramic Antenna
		Antenna Gain(Peak):	1 dBi
Remark: 1)For a more detailed features description, please refer to the manufacturer's specifications or the User's Manual.			

## 1.3. Auxiliary Equipment Used During Test

Adapter	:	M/N: ETB-U80F412 Input: 100-240V~ 50/60Hz, 0.3A Output: DC 5V, 100mA
---------	---	--

### 1.4. Description of Test Modes

To investigate the maximum EMI emission characteristics generates from EUT, the test system was pre-scanning tested base on the consideration of following EUT operation mode or test configuration mode which possible have effect on EMI emission level. Each of these EUT operation mode(s) or test configuration mode(s) mentioned above was evaluated respectively.

Pretest Mode	Description	
Mode 1	CH11	TX+Charging Mode/TX Only
Mode 2	CH18	
Mode 3	CH26	

Note:

- (1) The measurements are performed at the highest, middle, lowest available channels.
- (2)The data rate was set in 1Mbps for radiated emission due to the highest RF output power.

### 1.5. List of channels

Channel	Freq. (MHz)	Channel	Freq. (MHz)
11	2405	21	2455
12	2410	22	2460
13	2415	23	2465
14	2420	24	2470
15	2425	25	2475
16	2430	26	2480
17	2435		
18	2440		
19	2445		
20	2450		



### 1.6. Description Of Test Setup

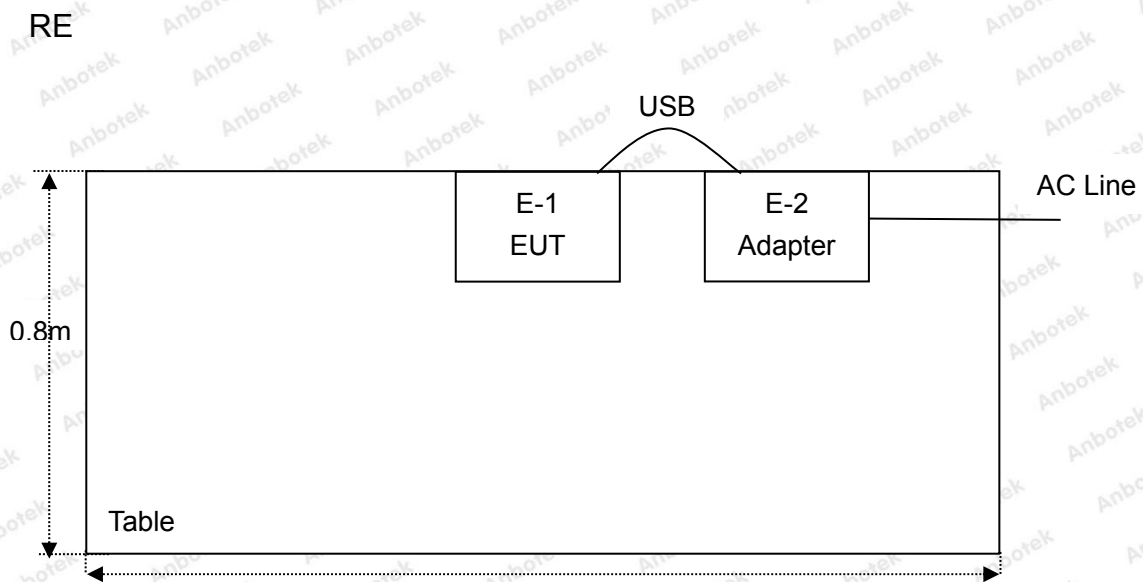
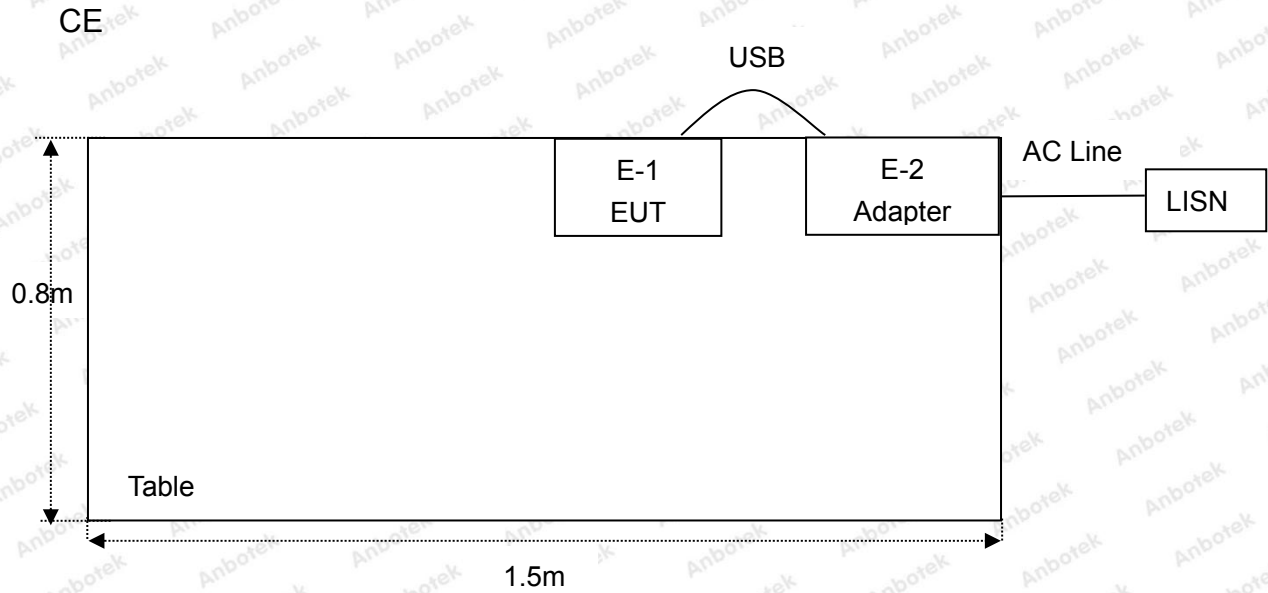

## 1.7. Test Equipment List

Item	Equipment	Manufacturer	Model No.	Serial No.	Last Cal.	Cal. Interval
1.	L.I.S.N. Artificial Mains Network	Rohde & Schwarz	ENV216	100055	Nov. 04, 2019	1 Year
2.	EMI Test Receiver	Rohde & Schwarz	ESPI3	101604	Nov. 04, 2019	1 Year
3.	RF Switching Unit	Compliance Direction	RSU-M2	38303	Nov. 04, 2019	1 Year
4.	MAX Spectrum Analysis	Agilent	N9020A	MY51170037	Nov. 04, 2019	1 Year
5.	Preamplifier	SKET Electronic	BK1G18G30 D	KD17503	Nov. 04, 2019	1 Year
6.	Double Ridged Horn Antenna	Instruments corporation	GTH-0118	351600	Nov. 01, 2019	1 Year
7.	Bilog Broadband Antenna	Schwarzbeck	VULB9163	VULB 9163-289	Nov. 01, 2019	1 Year
8.	Loop Antenna	Schwarzbeck	FMZB1519B	00053	Nov. 01, 2019	1 Year
9.	Horn Antenna	A-INFO	LB-180400-K F	J211060628	Nov. 01, 2019	1 Year
10.	Pre-amplifier	SONOMA	310N	186860	Nov. 04, 2019	1 Year
11.	EMI Test Software EZ-EMC	SHURPLE	N/A	N/A	N/A	N/A
12.	RF Test Control System	YIHENG	YH3000	2017430	Nov. 04, 2019	1 Year
13.	Power Sensor	DAER	RPR3006W	15100041SN045	Nov. 04, 2019	1 Year
14.	Power Sensor	DAER	RPR3006W	15100041SN046	Nov. 04, 2019	1 Year
15.	MXA Spectrum Analysis	Agilent	N9020A	MY51170037	Nov. 04, 2019	1 Year
16.	MXG RF Vector Signal Generator	Agilent	N5182A	MY48180656	Nov. 04, 2019	1 Year
17.	Signal Generator	Agilent	E4421B	MY41000743	Nov. 04, 2019	1 Year
18.	DC Power Supply	LW	TPR-6420D	374470	Nov. 04, 2019	1 Year
19.	Constant Temperature Humidity Chamber	ZHONGJIAN	ZJ-KHWS80 B	N/A	Nov. 04, 2019	1 Year



**1.8. Measurement Uncertainty**

Radiation Uncertainty	:	Ur = 3.9 dB (Horizontal)
		Ur = 3.8 dB (Vertical)
Conduction Uncertainty	:	Uc = 3.4 dB

**1.9. Description of Test Facility**

The test facility is recognized, certified, or accredited by the following organizations:

**FCC-Registration No.: 184111**

Shenzhen Anbotek Compliance Laboratory Limited, EMC Laboratory has been registered and fully described in a report filed with the (FCC) Federal Communications Commission. The acceptance letter from the FCC is maintained in our files. Registration No. 184111, September 27, 2019.

**ISED-Registration No.: 8058A**

Shenzhen Anbotek Compliance Laboratory Limited, EMC Laboratory has been registered and fully described in a report filed with the (ISED) Innovation, Science and Economic Development Canada. The acceptance letter from the ISED is maintained in our files. Registration 8058A, March 07, 2019.

**Test Location**

Shenzhen Anbotek Compliance Laboratory Limited.

1/F, Building D, Sogood Science and Technology Park, Sanwei community, Hangcheng Street, Bao'an District, Shenzhen, Guangdong, China.518102

## 2. Summary of Test Results

Standard Section	Test Item	Result
15.203/15.247(c)	Antenna Requirement	PASS
15.207	Conducted Emission	PASS
15.205/15.209	Spurious Emission	PASS
15.247(b)(3)	Maximum Peak Output Power	PASS
15.247(a)(2)	6dB Occupied Bandwidth	PASS
15.247(e)	Power Spectral Density	PASS
15.247(d)	Band Edge	PASS
<b>Remark:</b> "N/A" is an abbreviation for Not Applicable.		

### 3. Conducted Emission Test

#### 3.1. Test Standard and Limit

Test Standard	FCC Part15 Section 15.207		
Test Limit	Frequency	Maximum RF Line Voltage (dBuV)	
		Quasi-peak Level	Average Level
	150kHz~500kHz	66 ~ 56 *	56 ~ 46 *
	500kHz~5MHz	56	46
	5MHz~30MHz	60	50
<b>Remark:</b> (1) *Decreasing linearly with logarithm of the frequency. (2) The lower limit shall apply at the transition frequency.			

#### 3.2. Test Setup

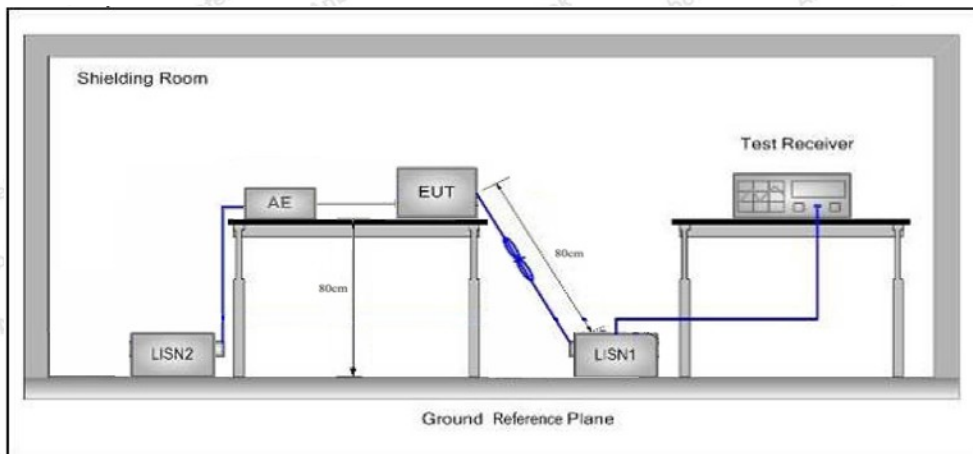

#### 3.3. Test Procedure

The EUT system is connected to the power mains through a line impedance stabilization network (L.I.S.N.). This provides a 50ohm coupling impedance for the EUT system. Please refer the block diagram of the test setup and photographs. Both sides of AC line are checked to find out the maximum conducted emission. In order to find the maximum emission levels, the relative positions of equipment and all of the interface cables shall be changed according to FCC ANSI C63.10-2013 on Conducted Emission Measurement.

The bandwidth of test receiver (ESCI) set at 9kHz.

The frequency range from 150kHz to 30MHz is checked.

#### 3.4. Test Data

Please to see the following pages.

During the test, pre-scan all the modes, and found Low channel(TX+Charging Mode) which is the worst case, only the worst case is recorded in the report.



**Conducted Emission Test Data**

Test Site: 1# Shielded Room  
 Operating Condition: Mode 1  
 Test Specification: AC 120V, 60Hz for adapter  
 Comment: Live Line  
 Tem.: 24.3°C Hum.: 62%

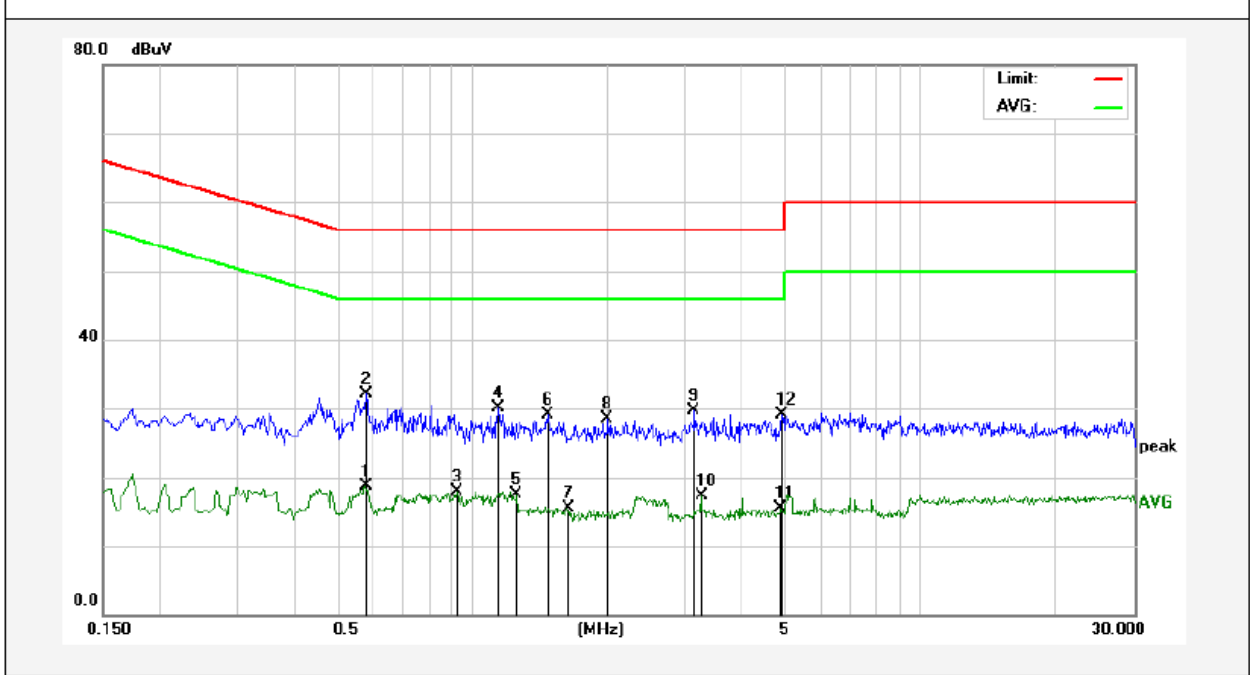

No.	Freq. (MHz)	Reading (dBuV)	Factor (dB)	Result (dBuV)	Limit (dBuV)	Over Limit (dB)	Detector	Remark
1	0.5777	-1.23	20.00	18.77	46.00	-27.23	AVG	
2	0.5817	12.09	20.00	32.09	56.00	-23.91	QP	
3	0.9260	-2.18	20.10	17.92	46.00	-28.08	AVG	
4	1.1457	10.02	20.12	30.14	56.00	-25.86	QP	
5	1.2620	-2.59	20.13	17.54	46.00	-28.46	AVG	
6	1.4737	8.94	20.13	29.07	56.00	-26.93	QP	
7	1.6337	-4.71	20.13	15.42	46.00	-30.58	AVG	
8	2.0019	8.45	20.14	28.59	56.00	-27.41	QP	
9	3.1339	9.55	20.16	29.71	56.00	-26.29	QP	
10	3.2580	-2.94	20.17	17.23	46.00	-28.77	AVG	
11	4.8897	-4.69	20.20	15.51	46.00	-30.49	AVG	
12	4.9019	8.89	20.20	29.09	56.00	-26.91	QP	

**Conducted Emission Test Data**

Test Site: 1# Shielded Room  
 Operating Condition: Mode 1  
 Test Specification: AC 120V, 60Hz for adapter  
 Comment: Neutral Line  
 Tem.: 24.3°C Hum.: 62%

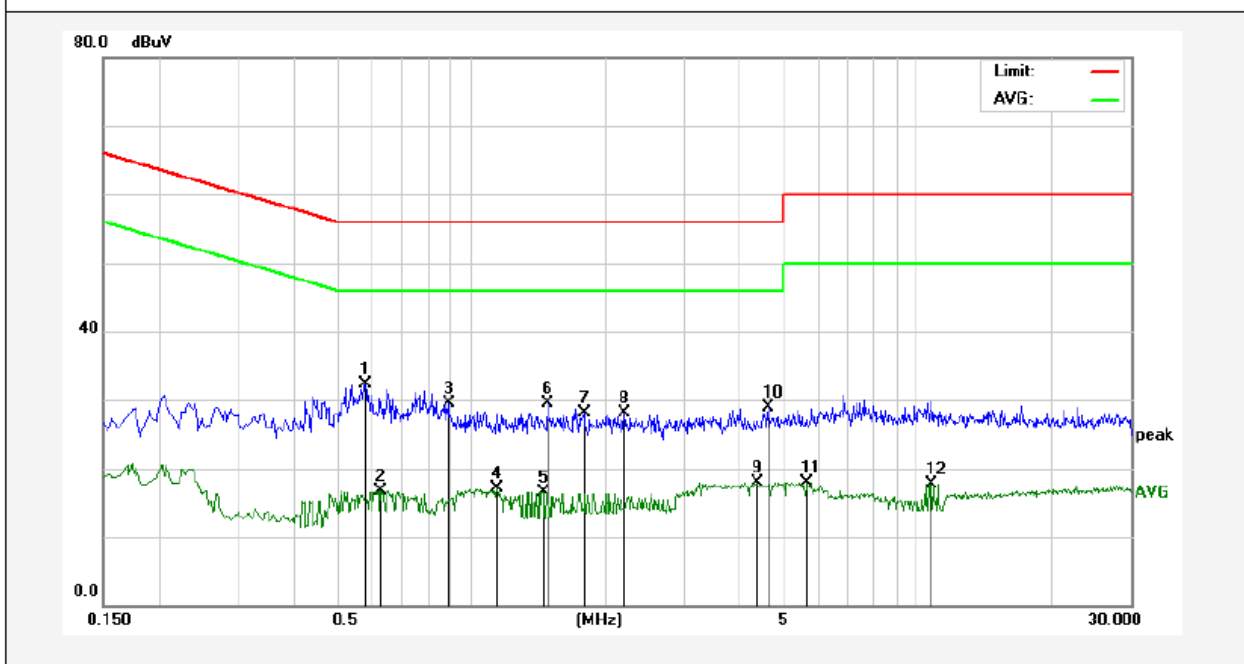

No.	Freq. (MHz)	Reading (dBuV)	Factor (dB)	Result (dBuV)	Limit (dBuV)	Over Limit (dB)	Detector	Remark
1	0.5819	12.26	20.00	32.26	56.00	-23.74	QP	
2	0.6300	-3.37	20.02	16.65	46.00	-29.35	AVG	
3	0.8900	9.49	20.09	29.58	56.00	-26.42	QP	
4	1.1459	-3.07	20.12	17.05	46.00	-28.95	AVG	
5	1.4539	-3.54	20.13	16.59	46.00	-29.41	AVG	
6	1.4819	9.42	20.13	29.55	56.00	-26.45	QP	
7	1.7940	7.87	20.14	28.01	56.00	-27.99	QP	
8	2.2058	8.04	20.14	28.18	56.00	-27.82	QP	
9	4.4019	-2.27	20.19	17.92	46.00	-28.08	AVG	
10	4.6299	8.68	20.20	28.88	56.00	-27.12	QP	
11	5.6539	-2.23	20.22	17.99	50.00	-32.01	AVG	
12	10.7619	-2.54	20.33	17.79	50.00	-32.21	AVG	

**Conducted Emission Test Data**

Test Site: 1# Shielded Room  
 Operating Condition: Mode 1  
 Test Specification: AC 240V, 60Hz for adapter  
 Comment: Live Line  
 Tem.: 24.3°C Hum.: 62%

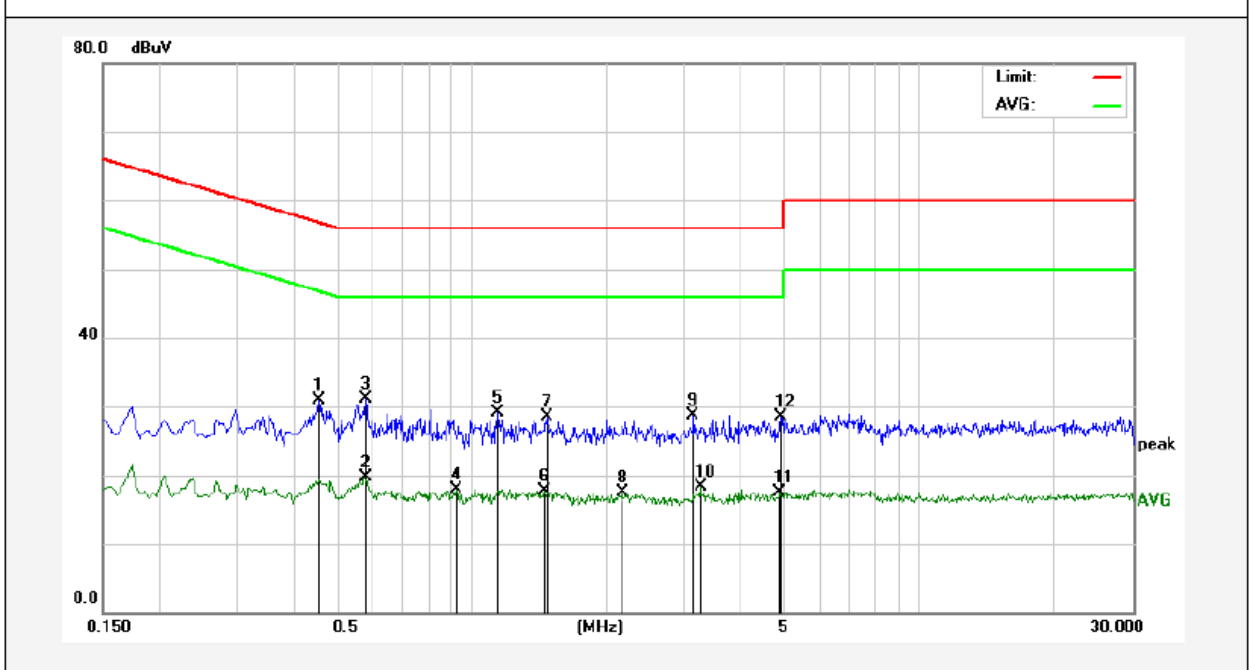

No.	Freq. (MHz)	Reading (dBuV)	Factor (dB)	Result (dBuV)	Limit (dBuV)	Over Limit (dB)	Detector	Remark
1	0.4580	11.01	19.96	30.97	56.73	-25.76	QP	
2	0.5778	-0.23	20.00	19.77	46.00	-26.23	AVG	
3	0.5818	11.09	20.00	31.09	56.00	-24.91	QP	
4	0.9260	-2.18	20.10	17.92	46.00	-28.08	AVG	
5	1.1458	9.02	20.12	29.14	56.00	-26.86	QP	
6	1.4497	-2.34	20.13	17.79	46.00	-28.21	AVG	
7	1.4738	8.44	20.13	28.57	56.00	-27.43	QP	
8	2.1779	-2.69	20.14	17.45	46.00	-28.55	AVG	
9	3.1339	8.55	20.16	28.71	56.00	-27.29	QP	
10	3.2580	-1.94	20.17	18.23	46.00	-27.77	AVG	
11	4.8897	-2.69	20.20	17.51	46.00	-28.49	AVG	
12	4.9019	8.39	20.20	28.59	56.00	-27.41	QP	



**Conducted Emission Test Data**

Test Site: 1# Shielded Room  
 Operating Condition: Mode 1  
 Test Specification: AC 240V, 60Hz for adapter  
 Comment: Neutral Line  
 Tem.: 24.3°C Hum.: 62%

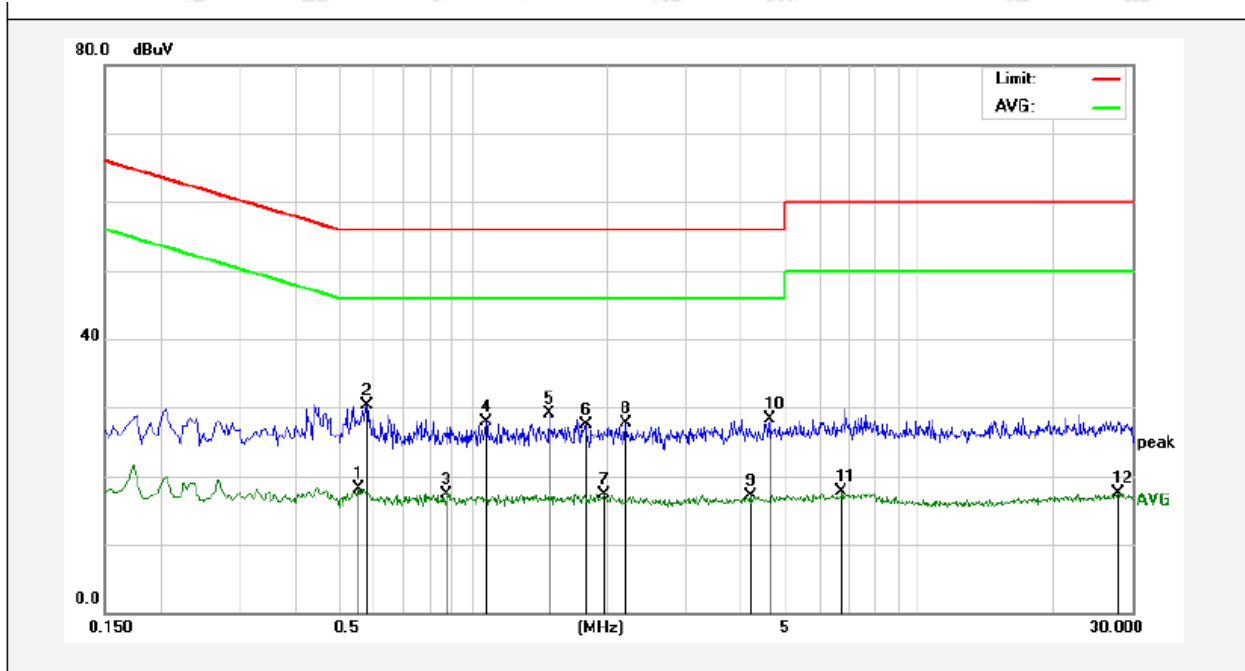

No.	Freq. (MHz)	Reading (dBuV)	Factor (dB)	Result (dBuV)	Limit (dBuV)	Over Limit (dB)	Detector	Remark
1	0.5580	-1.82	20.00	18.18	46.00	-27.82	AVG	
2	0.5820	10.26	20.00	30.26	56.00	-25.74	QP	
3	0.8780	-2.73	20.09	17.36	46.00	-28.64	AVG	
4	1.0740	7.75	20.12	27.87	56.00	-28.13	QP	
5	1.4819	8.92	20.13	29.05	56.00	-26.95	QP	
6	1.7940	7.37	20.14	27.51	56.00	-28.49	QP	
7	1.9780	-2.78	20.14	17.36	46.00	-28.64	AVG	
8	2.2060	7.54	20.14	27.68	56.00	-28.32	QP	
9	4.1819	-3.12	20.18	17.06	46.00	-28.94	AVG	
10	4.6299	8.18	20.20	28.38	56.00	-27.62	QP	
11	6.7099	-2.56	20.25	17.69	50.00	-32.31	AVG	
12	27.9300	-2.79	20.27	17.48	50.00	-32.52	AVG	

## 4. Radiation Spurious Emission and Band Edge

### 4.1. Test Standard and Limit

Test Standard	FCC Part15 C Section 15.209 and 15.205				
Test Limit	Frequency (MHz)	Field strength (microvolt/meter)	Limit (dBuV/m)	Remark	Measurement distance (m)
	0.009MHz~0.490MHz	2400/F(kHz)	-	-	300
	0.490MHz-1.705MHz	24000/F(kHz)	-	-	30
	1.705MHz-30MHz	30	-	-	30
	30MHz~88MHz	100	40.0	Quasi-peak	3
	88MHz~216MHz	150	43.5	Quasi-peak	3
	216MHz~960MHz	200	46.0	Quasi-peak	3
	960MHz~1000MHz	500	54.0	Quasi-peak	3
	Above 1000MHz	500	54.0	Average	3
-		74.0	Peak	3	

**Remark:**

- (1) The lower limit shall apply at the transition frequency.
- (2) 15.35(b), Unless otherwise specified, the limit on peak radio frequency emissions is 20dB above the maximum permitted average emission limit applicable to the equipment under test. This peak limit applies to the total peak emission level radiated by the device.

### 4.2. Test Setup

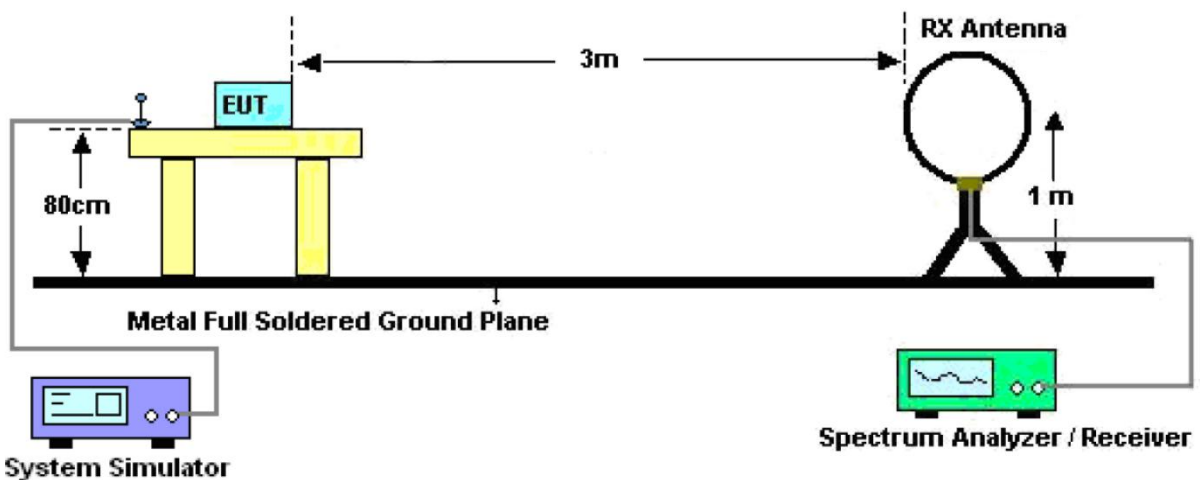

Figure 1. Below 30MHz

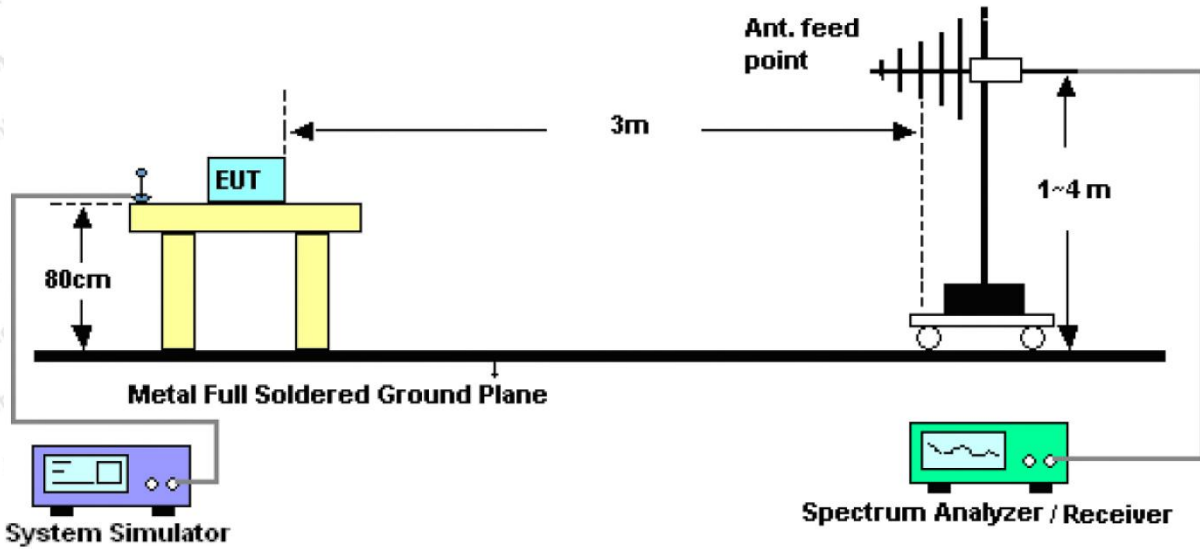

Figure 2. 30MHz to 1GHz

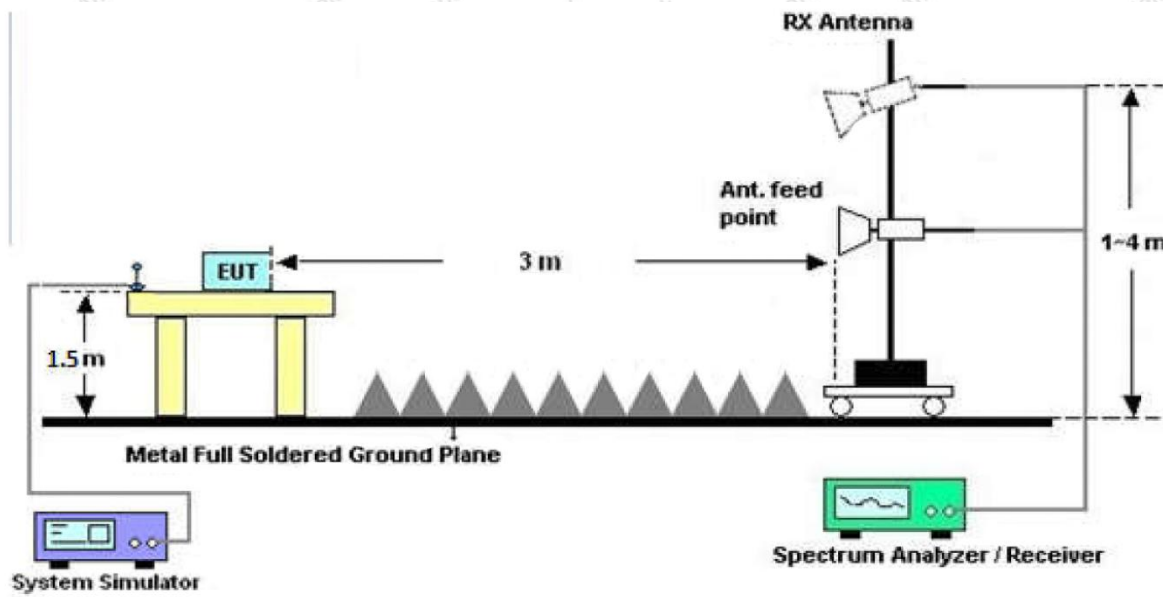

Figure 3. Above 1 GHz

### 4.3. Test Procedure

For below 1GHz: The EUT is placed on a turntable, which is 0.8m above the ground plane.

For above 1GHz: The EUT is placed on a turntable, which is 1.5m above the ground plane.

The turn table can rotate 360 degrees to determine the position of the maximum emission level. The EUT is set 3 meters away from the receiving antenna which is mounted on a antenna tower. The antenna can be moved up and down from 1 to 4 meters to find out the maximum emission level. Rotated the EUT through three orthogonal axes to determine the maximum emissions, both horizontal and vertical polarization of the antenna are set on test. The EUT is tested in 9\*6\*6 Chamber. The device is evaluated in xyz orientation.



For 9kHz to 150kHz, Set the spectrum analyzer as:

RBW = 200Hz, VBW = 1kHz, Detector= Quasi-Peak, Trace mode= Max hold, Sweep- auto couple.

For 150kHz to 30MHz, Set the spectrum analyzer as:

RBW = 9KHz, VBW = 30kHz, Detector= Quasi-Peak, Trace mode= Max hold, Sweep- auto couple.

For 30MHz to 1000MHz, Set the spectrum analyzer as:

RBW = 100kHz, VBW = 300kHz, Detector= Quasi-Peak, Trace mode= Max hold, Sweep- auto couple.

For above 1GHz, Set the spectrum analyzer as:

RBW = 1MHz, VBW = 1MHz, Detector= Peak, Trace mode= Max hold, Sweep- auto couple.

RBW = 1MHz, VBW = 10Hz, Detector= Average, Trace mode= Max hold, Sweep- auto couple.

#### 4.4. Test Data

##### PASS

During the test, pre-scan all the modes, and found the Low channel(TX+Charging Mode) which is the worst case, only the worst case is recorded in the report.

The test results of 9kHz-30MHz was attenuated more than 20dB below the permissible limits, so the results don't record in the report.

**Test Results (30~1000MHz)**

Job No.: 18220WC00061901      Temp.(°C)/Hum.(%RH): 25.7°C/ 49%RH  
 Standard: FCC PART 15C      Power Source: AC 120V, 60Hz for adapter  
 Test Mode: CH11      Polarization: Horizontal

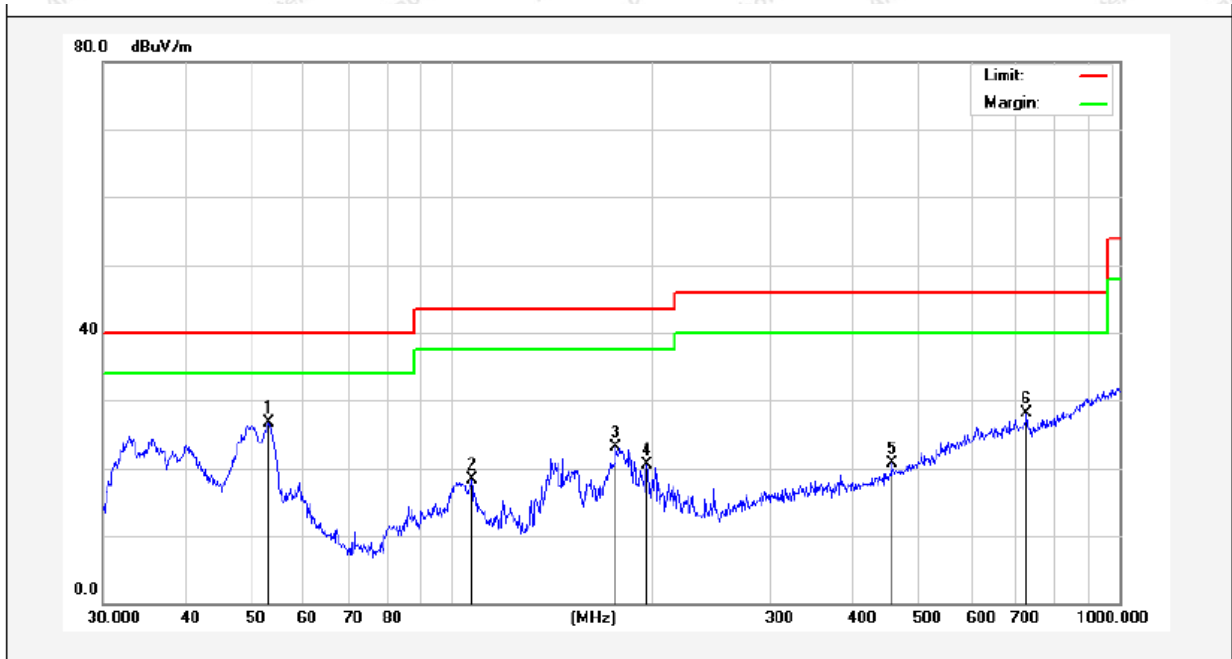

No.	Freq. (MHz)	Reading (dBuV)	Factor (dB/m)	Result (dBuV/m)	Limit (dBuV/m)	Over Limit (dB)	Detector	Height (cm)	degree (deg)	Remark
1	53.1313	42.64	-15.90	26.74	40.00	-13.26	QP	100	0	
2	107.1337	34.04	-15.79	18.25	43.50	-25.25	QP	100	360	
3	176.2686	41.48	-18.47	23.01	43.50	-20.49	QP	100	0	
4	195.8220	37.91	-17.43	20.48	43.50	-23.02	QP	100	360	
5	455.9058	30.84	-10.05	20.79	46.00	-25.21	QP	100	0	
6	726.8052	33.68	-5.60	28.08	46.00	-17.92	QP	100	360	

**Test Results (30~1000MHz)**

Job No.: 18220WC00061901

Temp.(°C)/Hum.(%RH): 25.7°C/ 49%RH

Standard: FCC PART 15C

Power Source: AC 120V, 60Hz for adapter

Test Mode: CH11

Polarization: Vertical

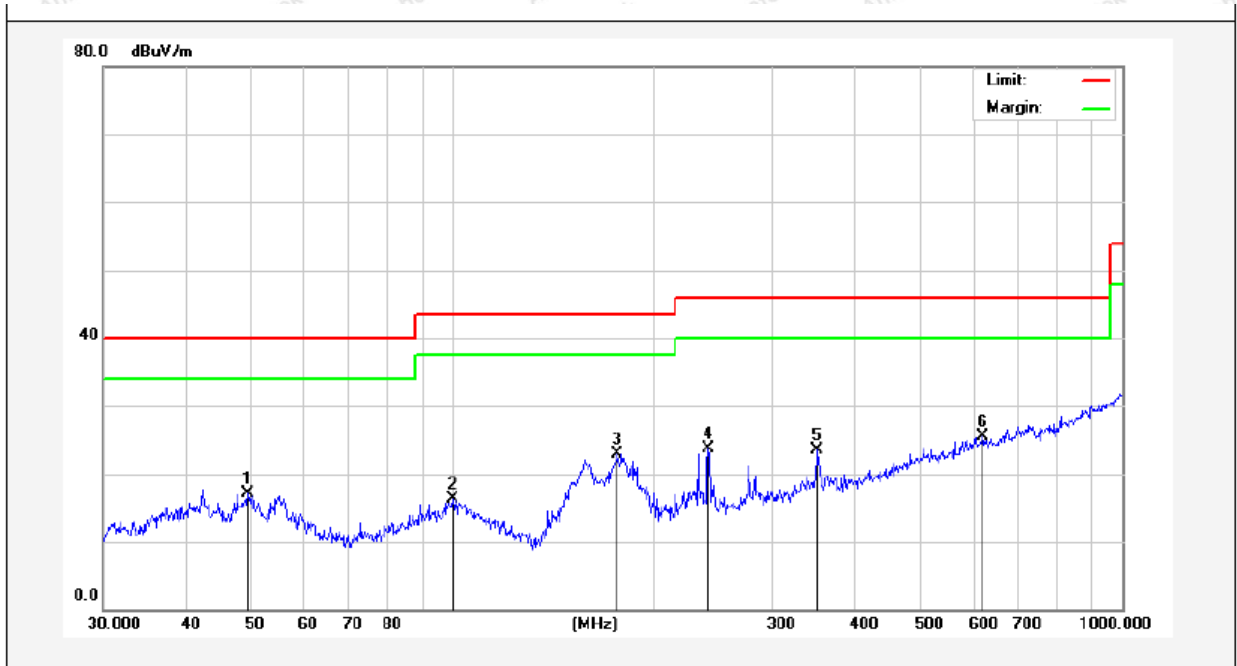

No.	Freq. (MHz)	Reading (dBuV)	Factor (dB/m)	Result (dBuV/m)	Limit (dBuV/m)	Over Limit (dB)	Detector	Height (cm)	degree (deg)	Remark
1	49.3594	31.80	-14.78	17.02	40.00	-22.98	QP	100	0	
2	99.8777	35.61	-19.39	16.22	43.50	-27.28	QP	100	360	
3	176.2686	43.99	-21.01	22.98	43.50	-20.52	QP	100	0	
4	240.8304	42.82	-19.03	23.79	46.00	-22.21	QP	100	360	
5	350.4768	36.46	-12.99	23.47	46.00	-22.53	QP	100	0	
6	618.5369	32.22	-6.76	25.46	46.00	-20.54	QP	100	360	



**Test Results (Above 1000MHz)**

Test Mode: CH11					Test channel: Lowest			
Peak Value								
Frequency (MHz)	Read Level (dBuV)	Antenna Factor (dB/m)	Cable Loss (dB)	Preamp Factor (dB)	Level (dBuV/m)	Limit (dBuV/m)	Over Limit (dB)	Pol.
4810.00	39.37	34.04	6.58	34.09	45.90	74.00	-28.10	V
7215.00	33.20	37.11	7.73	34.50	43.54	74.00	-30.46	V
9620.00	32.69	39.31	9.23	34.79	46.44	74.00	-27.56	V
12025.00	*					74.00		V
14430.00	*					74.00		V
4810.00	44.08	34.04	6.58	34.09	50.61	74.00	-23.39	H
7215.00	35.14	37.11	7.73	34.50	45.48	74.00	-28.52	H
9620.00	32.30	39.31	9.23	34.79	46.05	74.00	-27.95	H
12025.00	*					74.00		H
14430.00	*					74.00		H
Average Value								
Frequency (MHz)	Read Level (dBuV)	Antenna Factor (dB/m)	Cable Loss (dB)	Preamp Factor (dB)	Level (dBuV/m)	Limit (dBuV/m)	Over Limit (dB)	Pol.
4810.00	27.79	34.04	6.58	34.09	34.32	54.00	-19.68	V
7215.00	21.65	37.11	7.73	34.50	31.99	54.00	-22.01	V
9620.00	20.60	39.31	9.23	34.79	34.35	54.00	-19.65	V
12025.00	*					54.00		V
14430.00	*					54.00		V
4810.00	32.25	34.04	6.58	34.09	38.78	54.00	-15.22	H
7215.00	23.96	37.11	7.73	34.50	34.30	54.00	-19.70	H
9620.00	20.50	39.31	9.23	34.79	34.25	54.00	-19.75	H
12025.00	*					54.00		H
14430.00	*					54.00		H

**Test Results (Above 1000MHz)**

Test Mode: CH18					Test channel: Middle			
Peak Value								
Frequency (MHz)	Read Level (dBuV)	Antenna Factor (dB/m)	Cable Loss (dB)	Preamp Factor (dB)	Level (dBuV/m)	Limit (dBuV/m)	Over Limit (dB)	Pol.
4880.00	38.27	34.38	6.69	34.09	45.25	74.00	-28.75	V
7320.00	32.47	37.22	7.78	34.53	42.94	74.00	-31.06	V
9760.00	32.04	39.46	9.35	34.80	46.05	74.00	-27.95	V
12200.00	*					74.00		V
14640.00	*					74.00		V
4880.00	42.75	34.38	6.69	34.09	49.73	74.00	-24.27	H
7320.00	34.31	37.22	7.78	34.53	44.78	74.00	-29.22	H
9760.00	31.55	39.46	9.35	34.80	45.56	74.00	-28.44	H
12200.00	*					74.00		H
14640.00	*					74.00		H
Average Value								
Frequency (MHz)	Read Level (dBuV)	Antenna Factor (dB/m)	Cable Loss (dB)	Preamp Factor (dB)	Level (dBuV/m)	Limit (dBuV/m)	Over Limit (dB)	Pol.
4880.00	26.92	34.38	6.69	34.09	33.90	54.00	-20.10	V
7320.00	21.06	37.22	7.78	34.53	31.53	54.00	-22.47	V
9760.00	20.07	39.46	9.35	34.80	34.08	54.00	-19.92	V
12200.00	*					54.00		V
14640.00	*					54.00		V
4880.00	31.25	34.38	6.69	34.09	38.23	54.00	-15.77	H
7320.00	23.30	37.22	7.78	34.53	33.77	54.00	-20.23	H
9760.00	19.88	39.46	9.35	34.80	33.89	54.00	-20.11	H
12200.00	*					54.00		H
14640.00	*					54.00		H

**Test Results (Above 1000MHz)**

Test Mode: CH26					Test channel: Highest			
Peak Value								
Frequency (MHz)	Read Level (dBuV)	Antenna Factor (dB/m)	Cable Loss (dB)	Preamp Factor (dB)	Level (dBuV/m)	Limit (dBuV/m)	Over Limit (dB)	Pol.
4960.00	36.48	34.72	6.79	34.09	43.90	74.00	-30.10	V
7440.00	31.28	37.34	7.82	34.57	41.87	74.00	-32.13	V
9920.00	30.98	39.62	9.46	34.81	45.25	74.00	-28.75	V
12400.00	*					74.00		V
14880.00	*					74.00		V
4960.00	40.60	34.72	6.79	34.09	48.02	74.00	-25.98	H
7440.00	32.96	37.34	7.82	34.57	43.55	74.00	-30.45	H
9920.00	30.32	39.62	9.46	34.81	44.59	74.00	-29.41	H
12400.00	*					74.00		H
14880.00	*					74.00		H
Average Value								
Frequency (MHz)	Read Level (dBuV)	Antenna Factor (dB/m)	Cable Loss (dB)	Preamp Factor (dB)	Level (dBuV/m)	Limit (dBuV/m)	Over Limit (dB)	Pol.
4960.00	25.51	34.72	6.79	34.09	32.93	54.00	-21.07	V
7440.00	20.10	37.34	7.82	34.57	30.69	54.00	-23.31	V
9920.00	19.23	39.62	9.46	34.81	33.50	54.00	-20.50	V
12400.00	*					54.00		V
14880.00	*					54.00		V
4960.00	29.66	34.72	6.79	34.09	37.08	54.00	-16.92	H
7440.00	22.23	37.34	7.82	34.57	32.82	54.00	-21.18	H
9920.00	18.89	39.62	9.46	34.81	33.16	54.00	-20.84	H
12400.00	*					54.00		H
14880.00	*					54.00		H

Remark:

1. Level =Receiver Read level + Antenna Factor + Cable Loss – Pre-amplifier Factor
2. “\*”, means this data is the too weak instrument of signal is unable to test.



**Radiated Band Edge:**

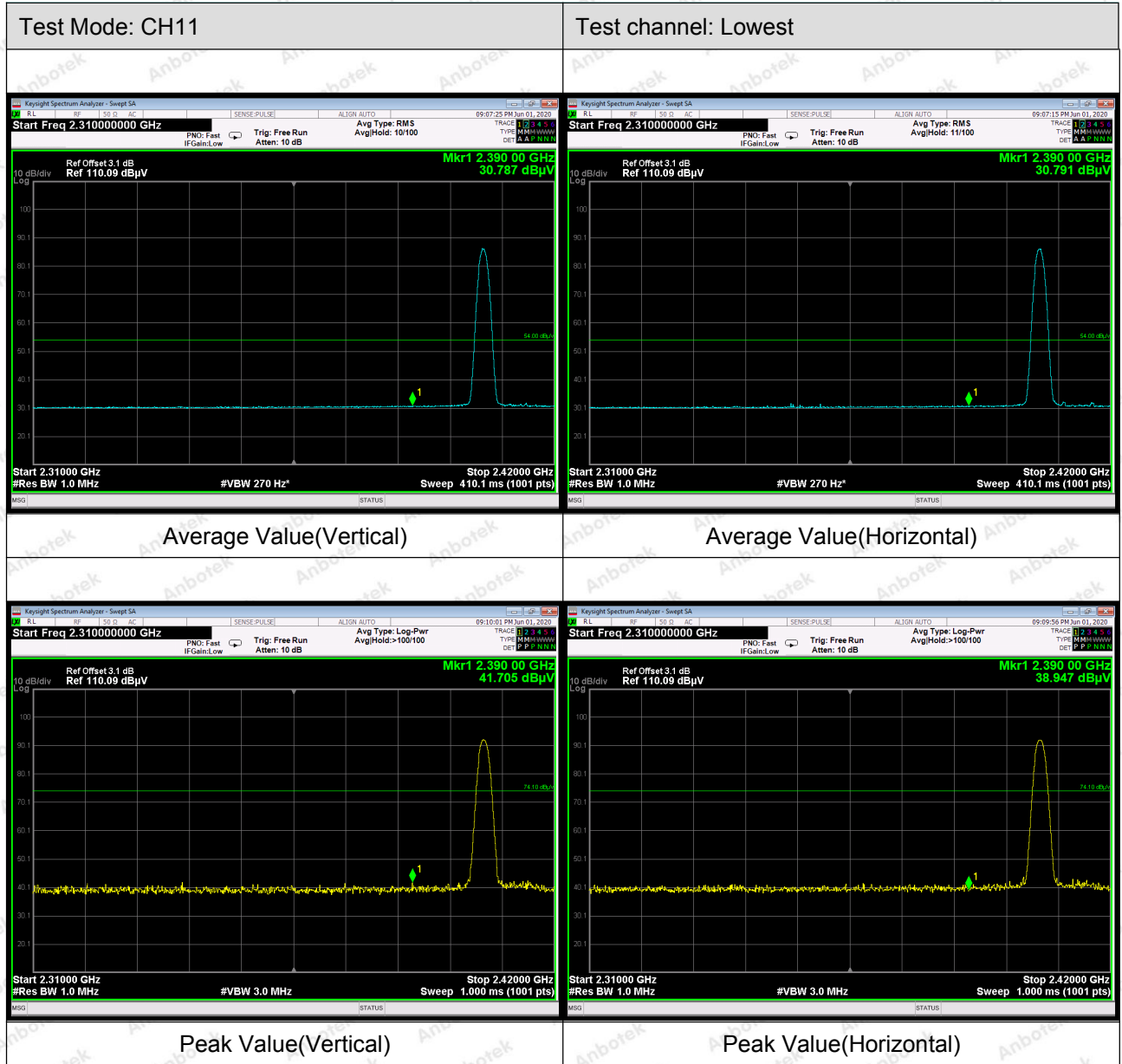



Remark:

1. Level =Receiver Read level + Antenna Factor + Cable Loss – Pre-amplifier Factor

## 5. Output Power Test

### 5.1. Test Standard and Limit

Test Standard	FCC Part15 C Section 15.247 (b)(3)
Test Limit	30dBm

### 5.2. Test Setup

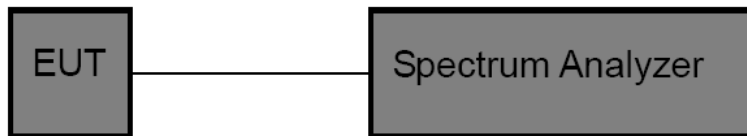

### 5.3. Test Procedure

- The EUT was directly connected to the spectrum analyzer and antenna output port as show in the block diagram above,
- Spectrum Setting:
  - RBW > the 20 dB bandwidth of the emission being measured
  - Span = approximately 5 times the 20 dB bandwidth, centered on a hopping channel
  - VBW ≥ RBW
  - Sweep = auto
  - Detector function = peak
  - Trace = max hold

### 5.4. Test Data

Test Item	: Output power	Test Mode	: CH Low ~ CH High
Test Voltage	: AC 120V, 60Hz for adapter	Temperature	: 24°C
Test Result	: PASS	Humidity	: 55%RH

Channel Frequency (MHz)	Maximum Power output(AV) (dBm)	Limit (dBm)	Results
2405	-0.915	30	PASS
2440	-0.567	30	PASS
2480	-0.662	30	PASS

For power test the duty cycle is 100% in continous transmitting mode





Test Mode: Low



Test Mode: Middle



Test Mode: High

## 6. 6DB Occupy Bandwidth Test

### 6.1. Test Standard and Limit

Test Standard	FCC Part15 C Section 15.247 (a)(2)
Test Limit	>500kHz

### 6.2. Test Setup

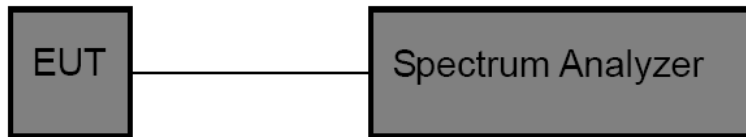

### 6.3. Test Procedure

1. Place the EUT on the table and set it in the transmitting mode.
2. Remove the antenna from the EUT and then connect a low loss RF cable from the antenna port to the spectrum analyzer.
3. Set the spectrum analyzer as:  
 RBW = 100kHz, VBW≥3\*RBW =300kHz,  
 Detector= Peak  
 Trace mode= Max hold.  
 Sweep- auto couple.
4. Mark the peak frequency and -6dB (upper and lower) frequency.
5. Repeat until all the rest channels are investigated.

### 6.4. Test Data

Test Item	: 6dB Bandwidth	Test Mode	: CH Low ~ CH High
Test Voltage	: AC 120V, 60Hz for adapter	Temperature	: 24℃
Test Result	: PASS	Humidity	: 55%RH

Channel	Frequency(MHz)	Bandwidth (kHz)	Limit (kHz)	Results
Low	2405	1577	>500	PASS
Middle	2440	1583		PASS
High	2480	1725		PASS



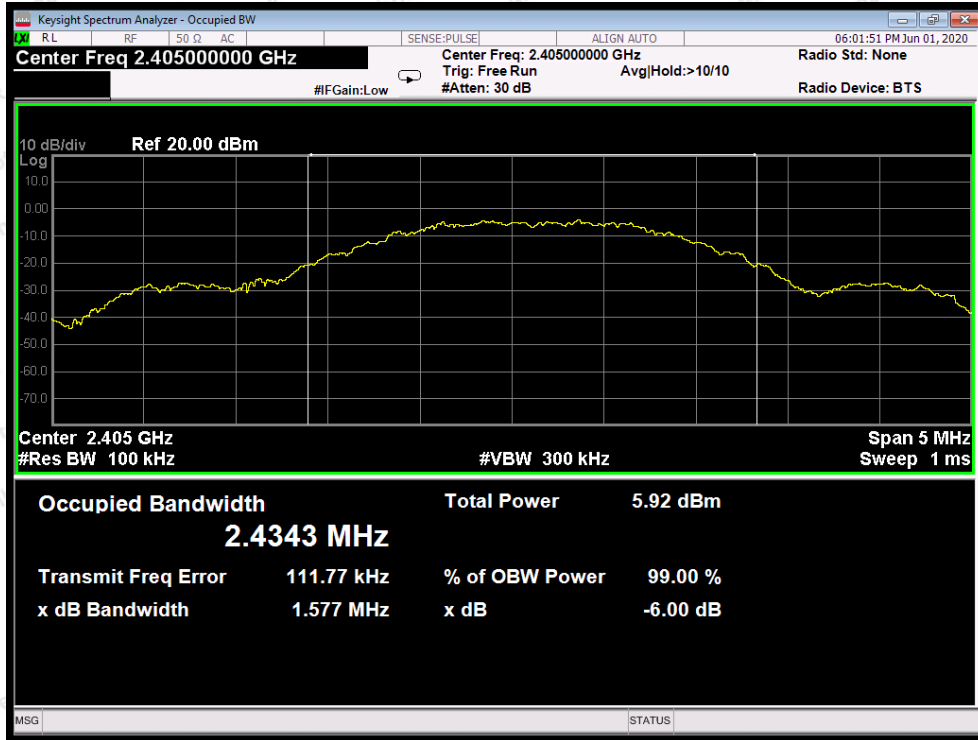

CH: Low

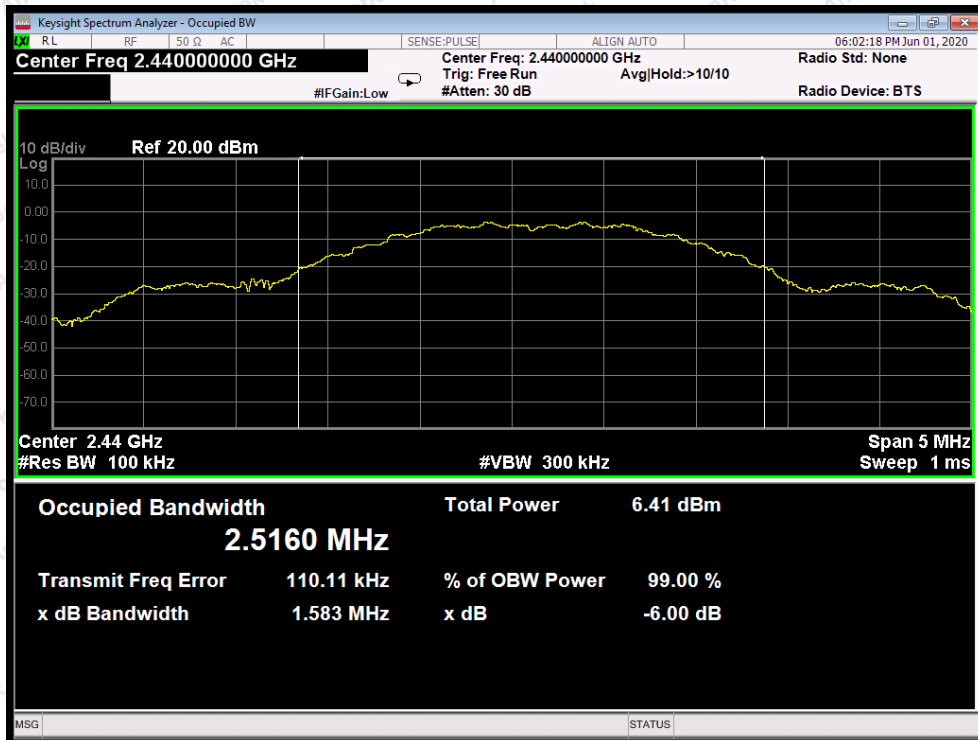

CH: Middle

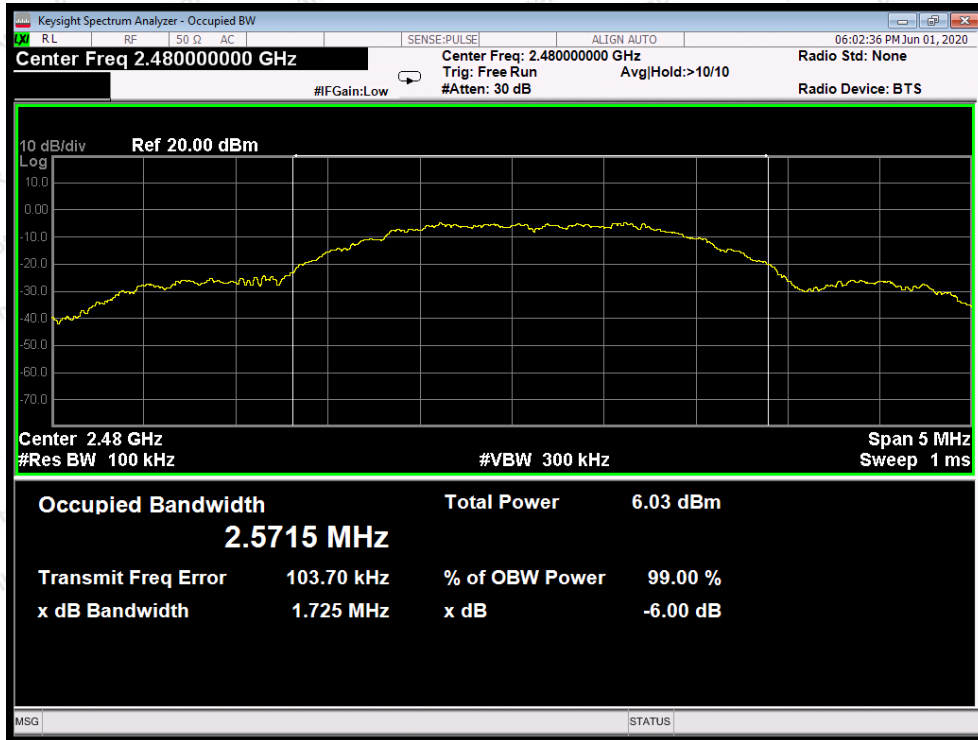

CH: High

## 7. Power Spectral Density Test

### 7.1. Test Standard and Limit

Test Standard	FCC Part15 C Section 15.247 (e)
Test Limit	8dBm

### 7.2. Test Setup

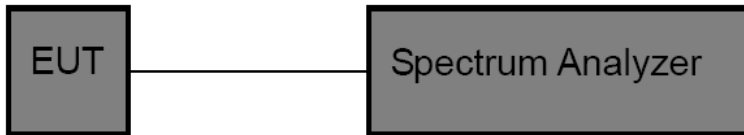

### 7.3. Test Procedure

1. Place the EUT on the table and set it in transmitting mode. Remove the antenna from the EUT and then connect a low loss RF cable from the antenna port to the spectrum analyzer.
2. Set the spectrum analyzer as RBW = 3kHz, VBW = 10kHz, Span = 1.5xDTS BW
3. Record the max. reading.
4. Repeat the above procedure until the measurements for all frequencies are completed.

### 7.4. Test Data

Test Item	: Power Spectral Density	Test Mode	: CH Low ~ CH High
Test Voltage	: AC 120V, 60Hz for adapter	Temperature	: 24°C
Test Result	: PASS	Humidity	: 55%RH

Channel	Frequency (MHz)	PSD (dBm/3KHz)	Limit (dBm/3KHz)	Results
Low	2405	-8.977	8	PASS
Middle	2440	-8.898	8	PASS
High	2480	-10.409	8	PASS



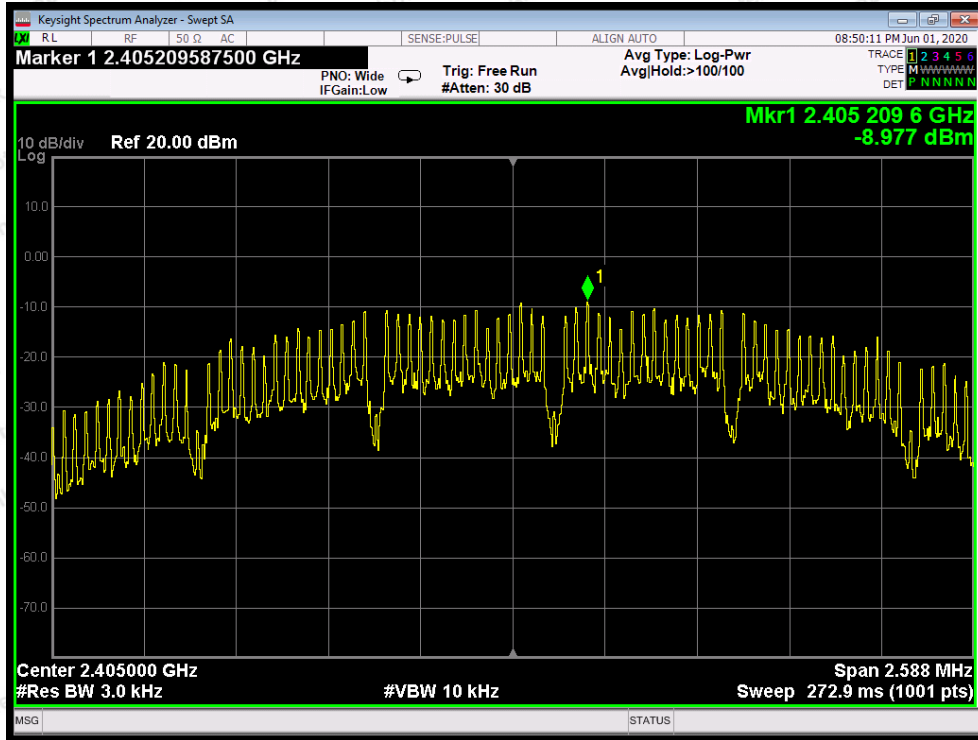

CH: Low

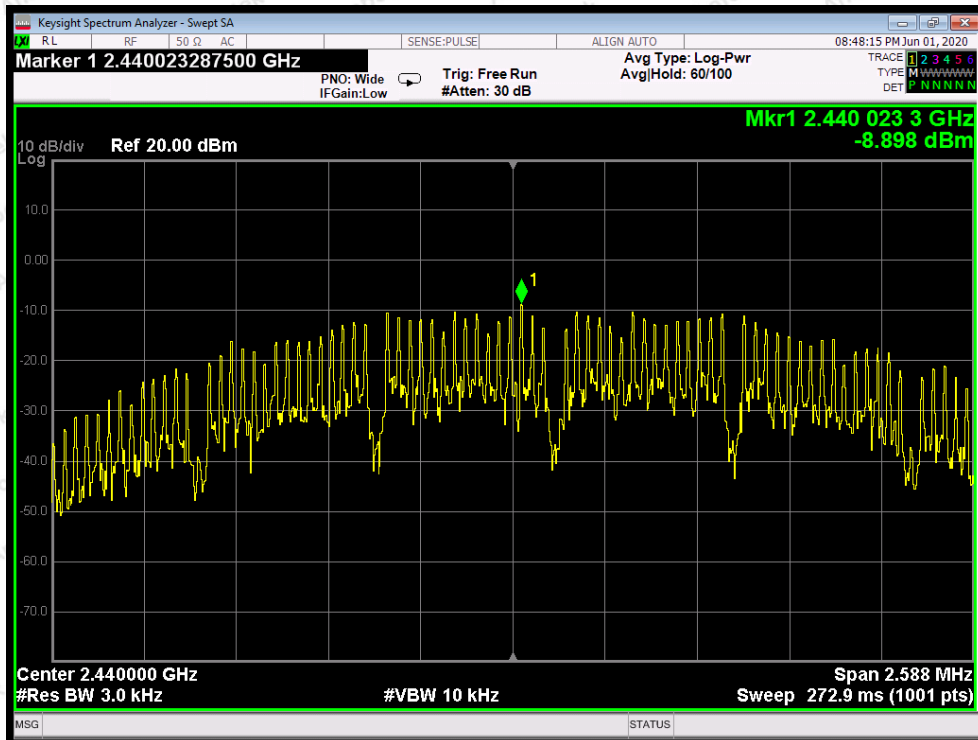

CH: Middle

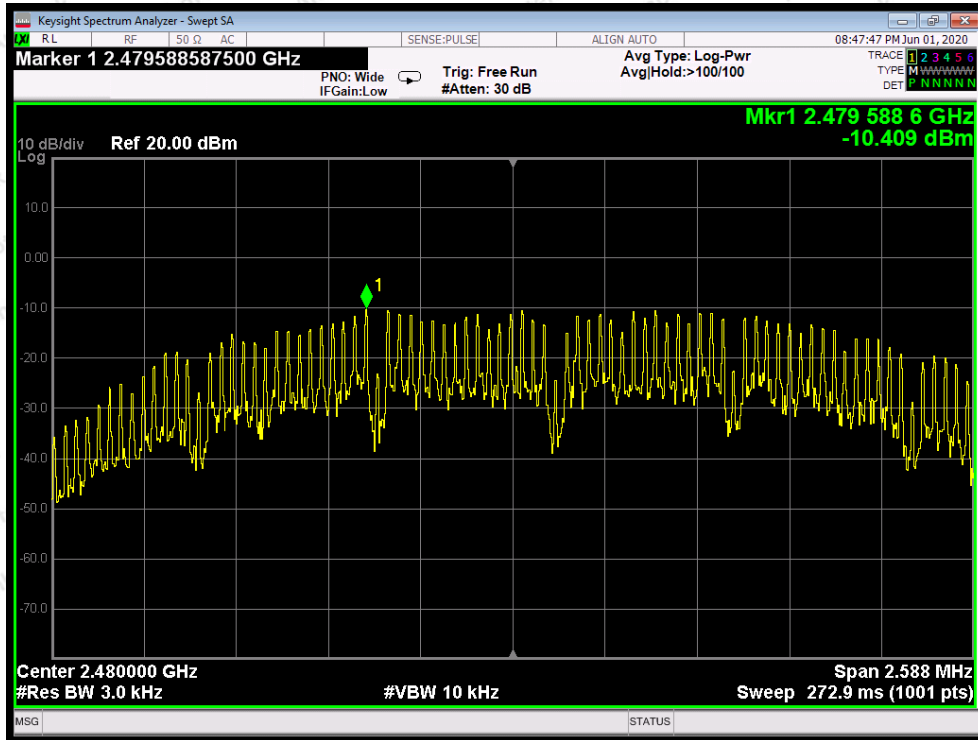

CH: High

## 8. 100kHz Bandwidth of Frequency Band Edge Requirement

### 8.1. Test Standard and Limit

Test Standard	FCC Part15 C Section 15.247 (d)
Test Limit	in any 100 kHz bandwidth outside the frequency bands in which the spread spectrum intentional radiator in operating, the radio frequency power that is produced by the intentional radiator shall be at least 20dB below that in the 100kHz bandwidth within the band that contains the highest level of the desired power, In addition, radiated emissions which fall in the restricted bands, as defined in §15.205(a), must also comply with the radiated emission limits specified in15.209(a).

### 8.2. Test Setup

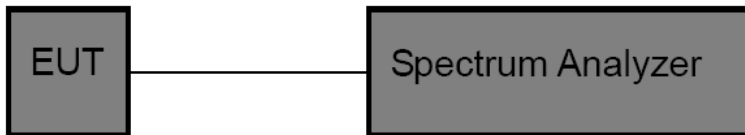

### 8.3. Test Procedure

Using the following spectrum analyzer setting:

1. Set the RBW = 100KHz.
2. Set the VBW = 300KHz.
3. Sweep time = auto couple.
4. Detector function = peak.
5. Trace mode = max hold.
6. Allow trace to fully stabilize.

### 8.4. Test Data

Test Item	: Band edge	Test Mode	: CH Low ~ CH High
Test Voltage	: AC 120V, 60Hz for adapter	Temperature	: 24°C
Test Result	: PASS	Humidity	: 55%RH

Frequency Band (MHz)	Delta Peak to Band Emission (dBc)	Limit (dBc)	Results
2405	40.199	>30	PASS
2483.5	39.211	>30	PASS



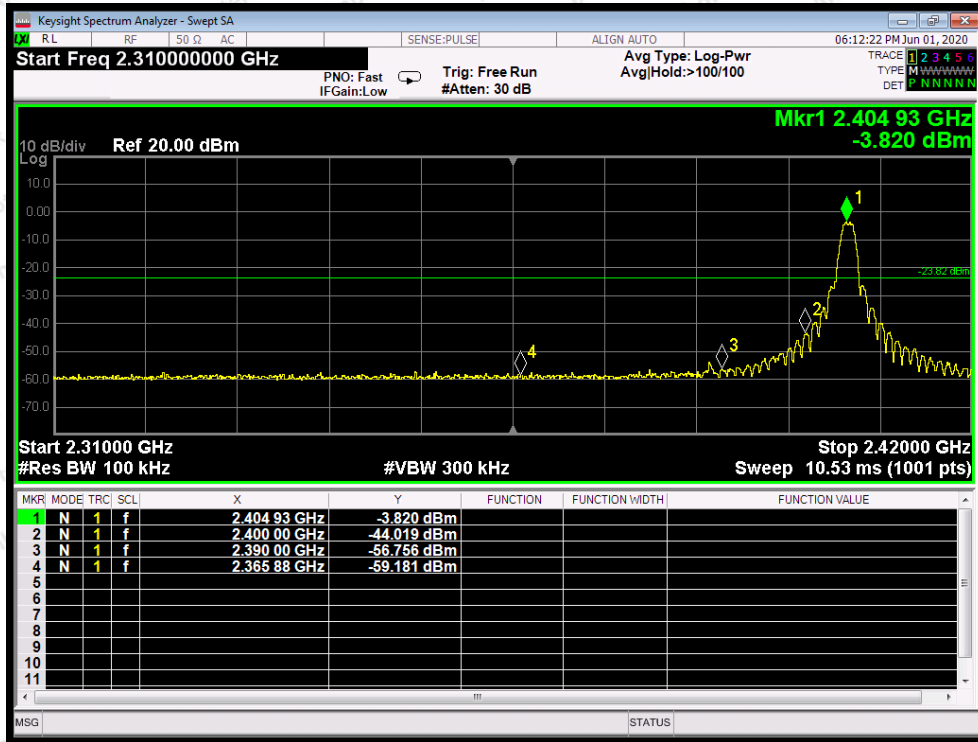

CH: Low

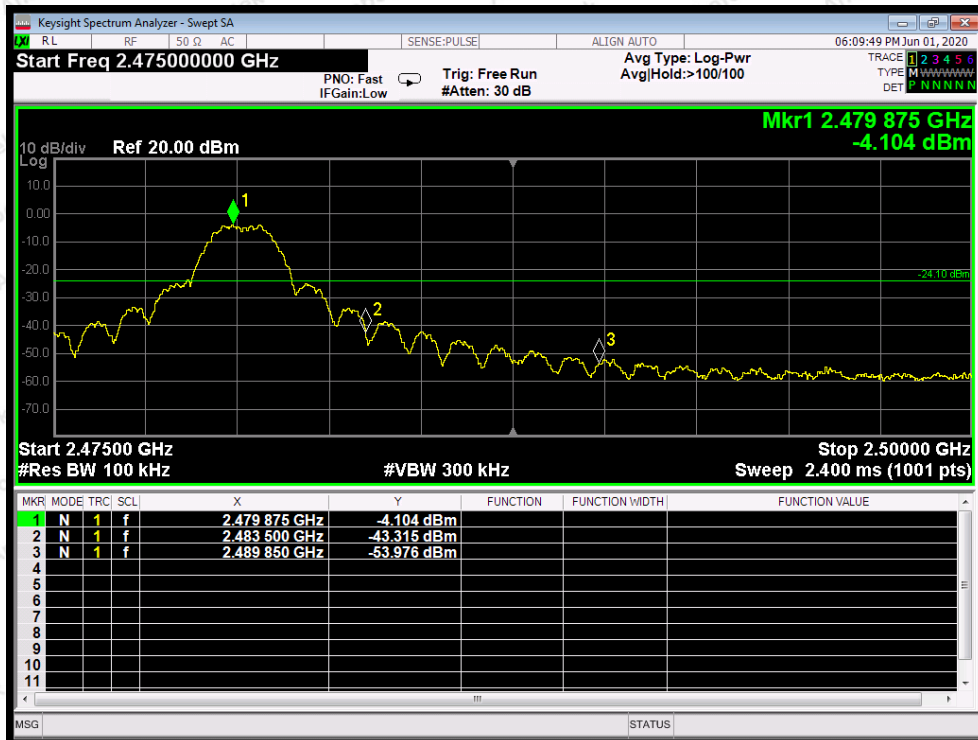

CH: High

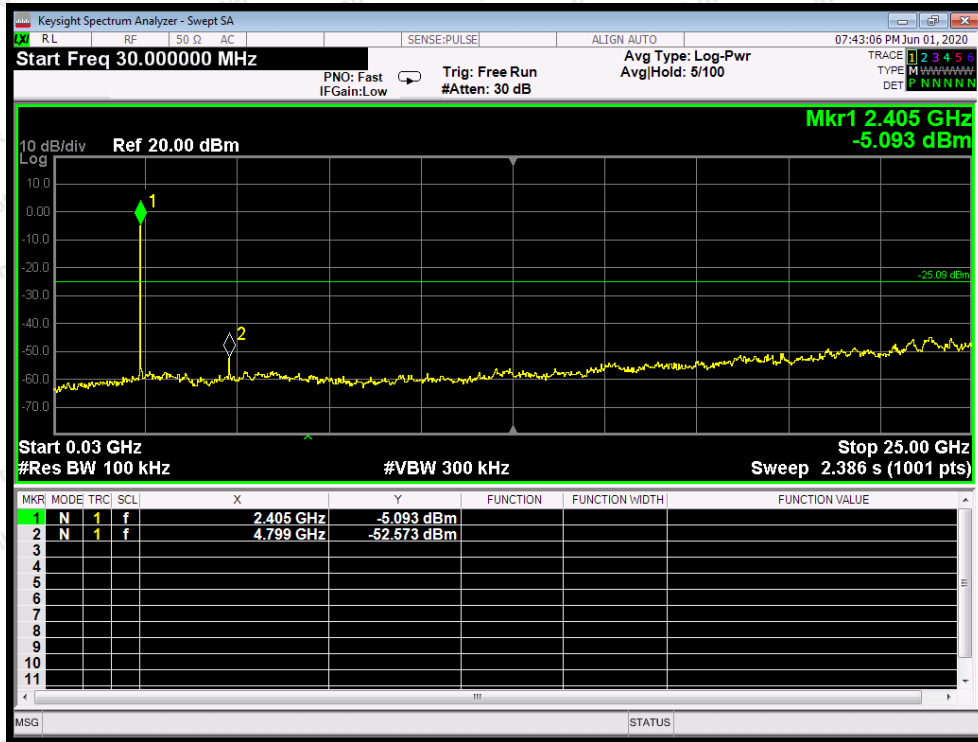

CH: Low

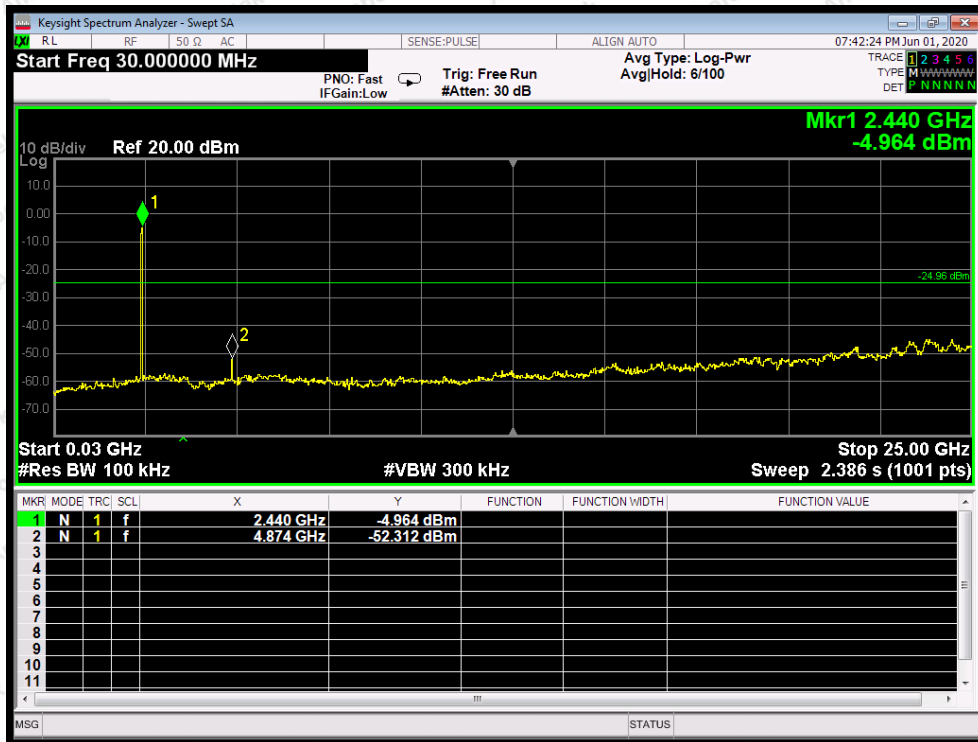

CH: Middle

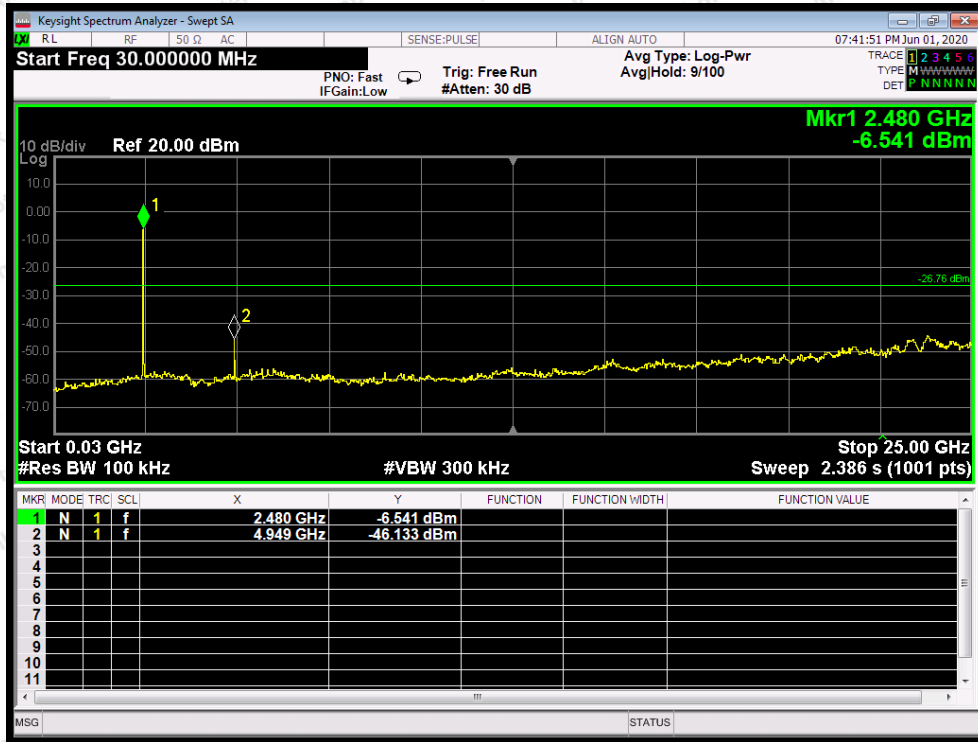

CH: High



## 9. Antenna Requirement

### 9.1. Test Standard and Requirement

Test Standard	FCC Part15 Section 15.203 /247(c)
Requirement	<p>1) 15.203 requirement: An intentional radiator shall be designed to ensure that no antenna other than that furnished by the responsible party shall be used with the device. The use of a permanently attached antenna or of an antenna that uses a unique coupling to the intentional radiator, the manufacturer may design the unit so that a broken antenna can be replaced by the user, but the use of a standard antenna jack or electrical connector is prohibited.</p> <p>2) 15.247(c) (1)(i) requirement: Systems operating in the 2400-2483.5 MHz band that is used exclusively for fixed. Point-to-point operations may employ transmitting antennas with directional gain greater than 6dBi provided the maximum conducted output power of the intentional radiator is reduced by 1 dB for every 3 dB that the directional gain of the antenna exceeds 6 dBi.</p>

### 9.2. Antenna Connected Construction

The antenna is a ceramic antenna which permanently attached, and the best case gain of the antenna is 1 dBi. It complies with the standard requirement.

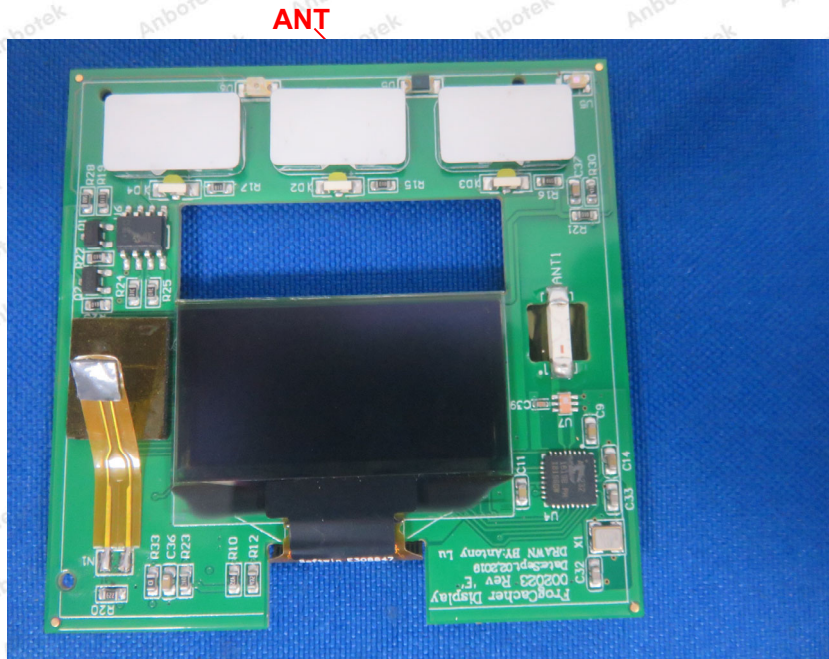

# PENDIX I -- TEST SETUP PHOTOGRAPH

Photo of Power Line Conducted Emission Test



Photo of Radiation Emission Test









## APPENDIX II -- EXTERNAL PHOTOGRAPH

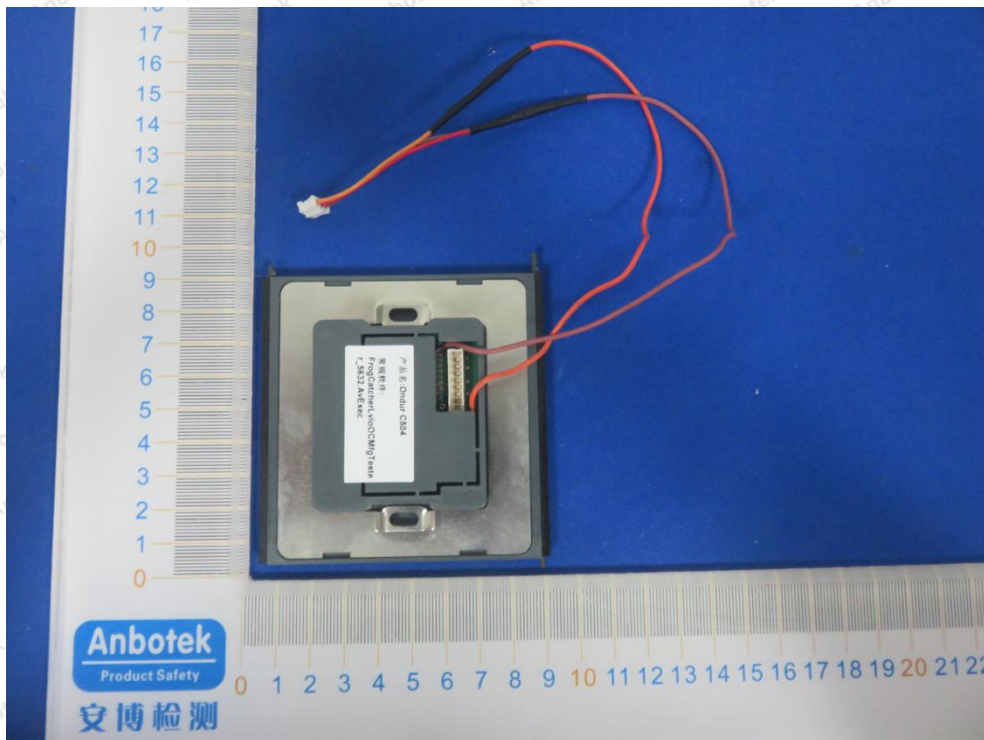
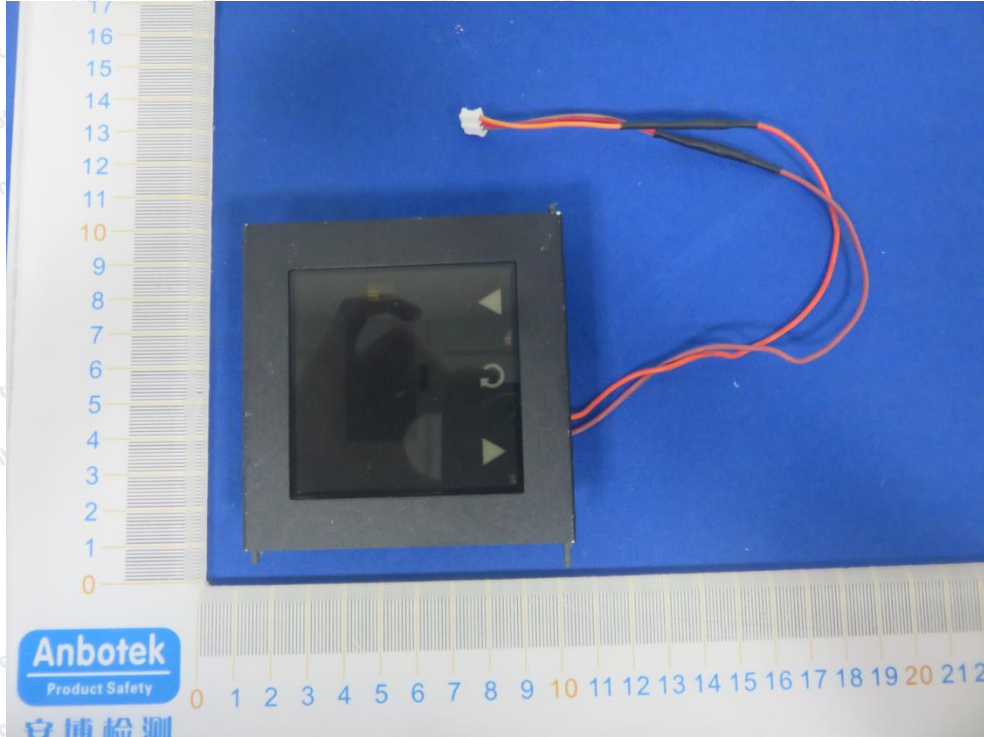

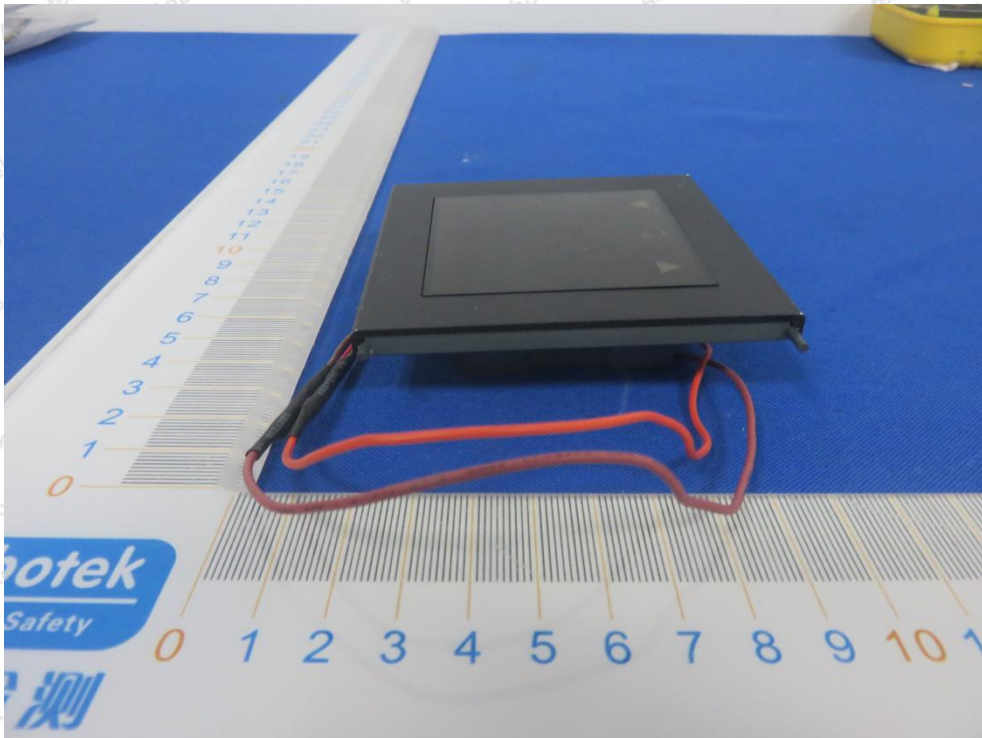
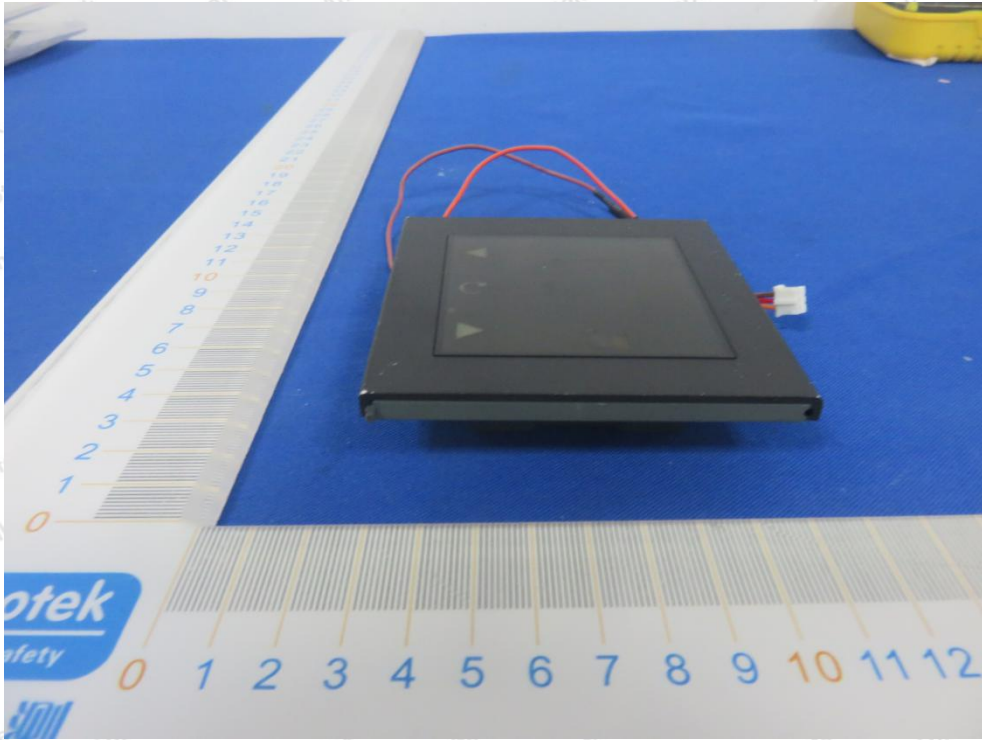



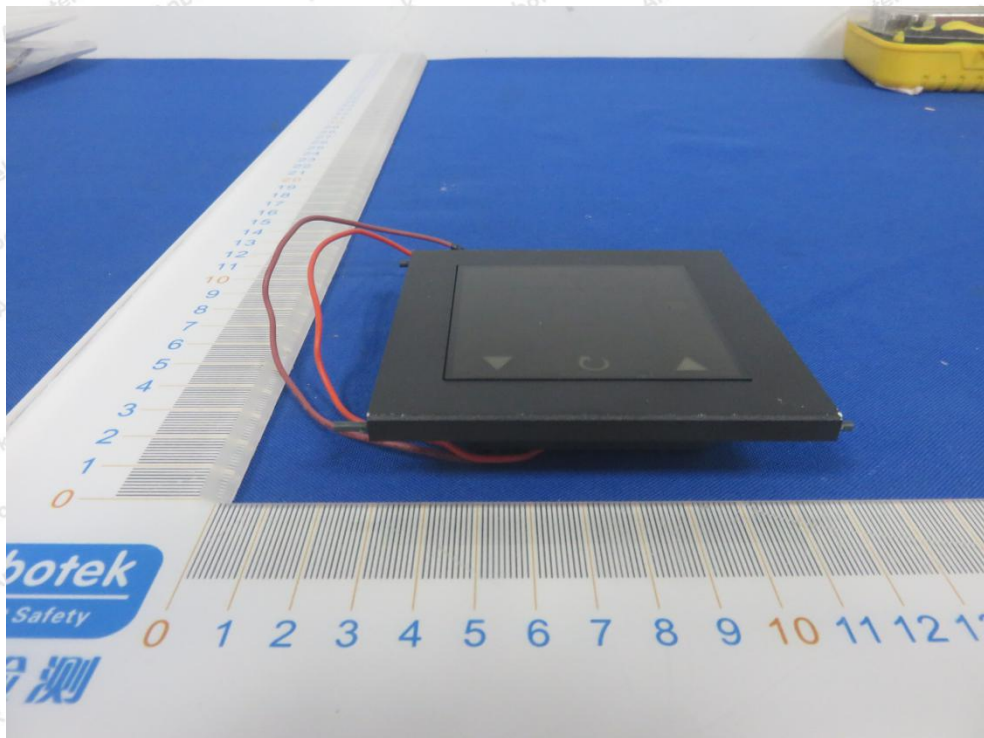
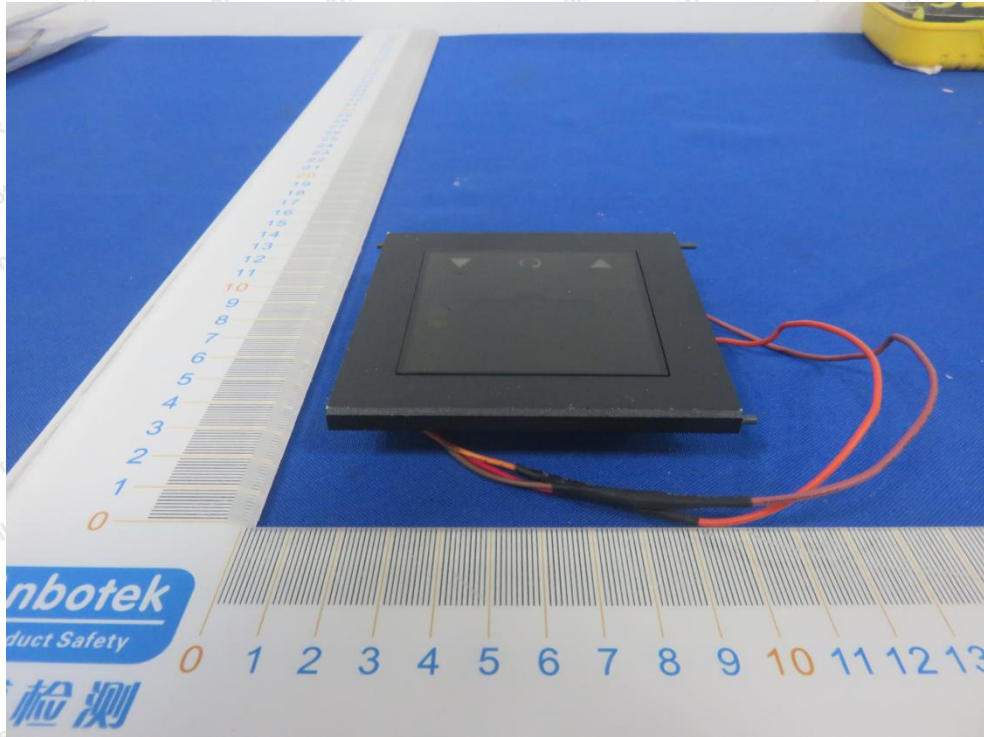



### APPENDIX III -- INTERNAL PHOTOGRAPH

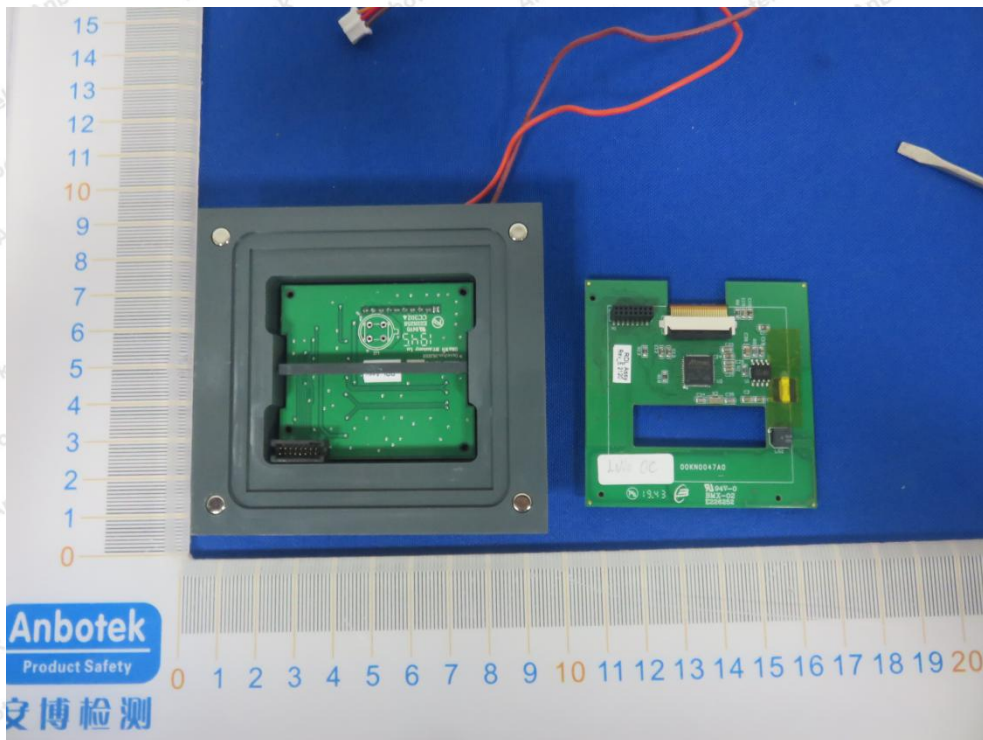

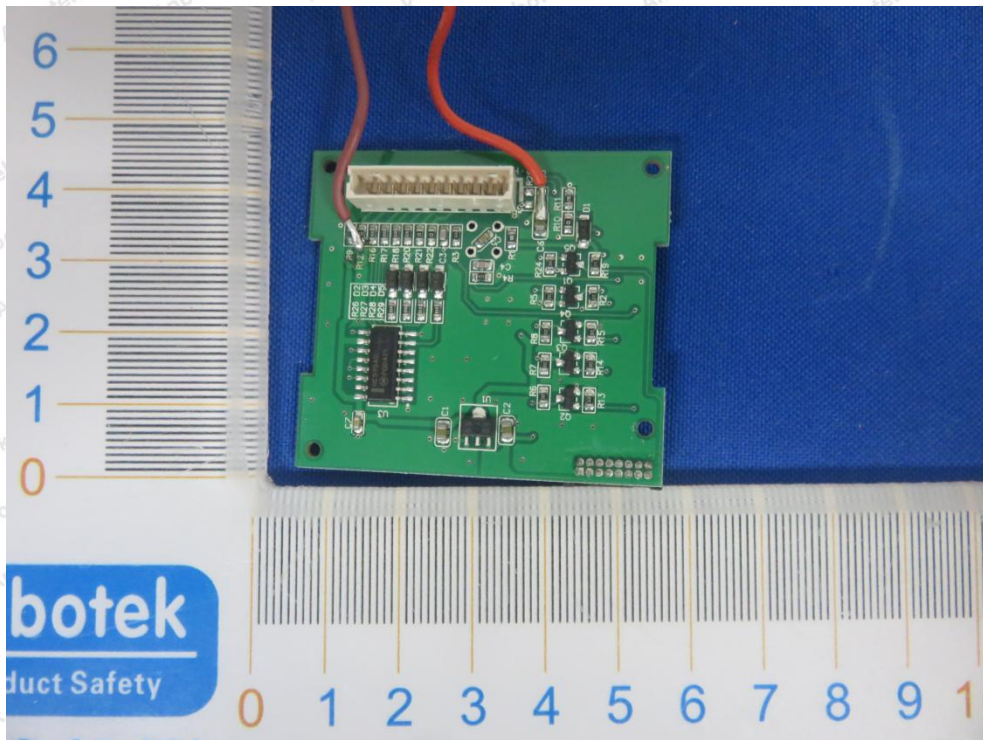
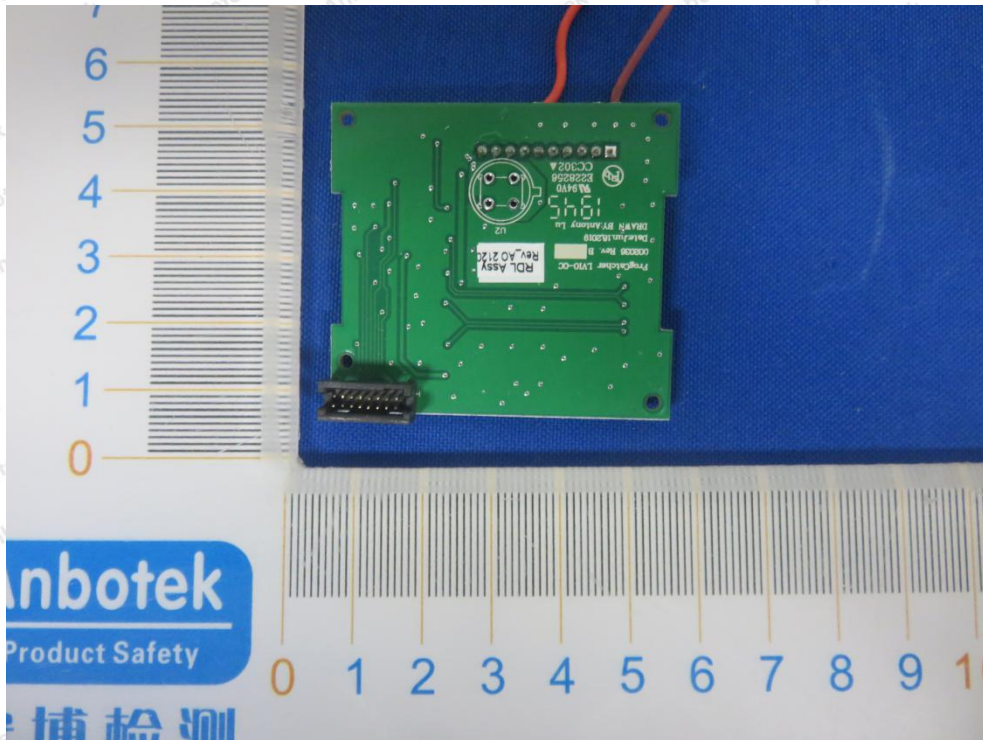



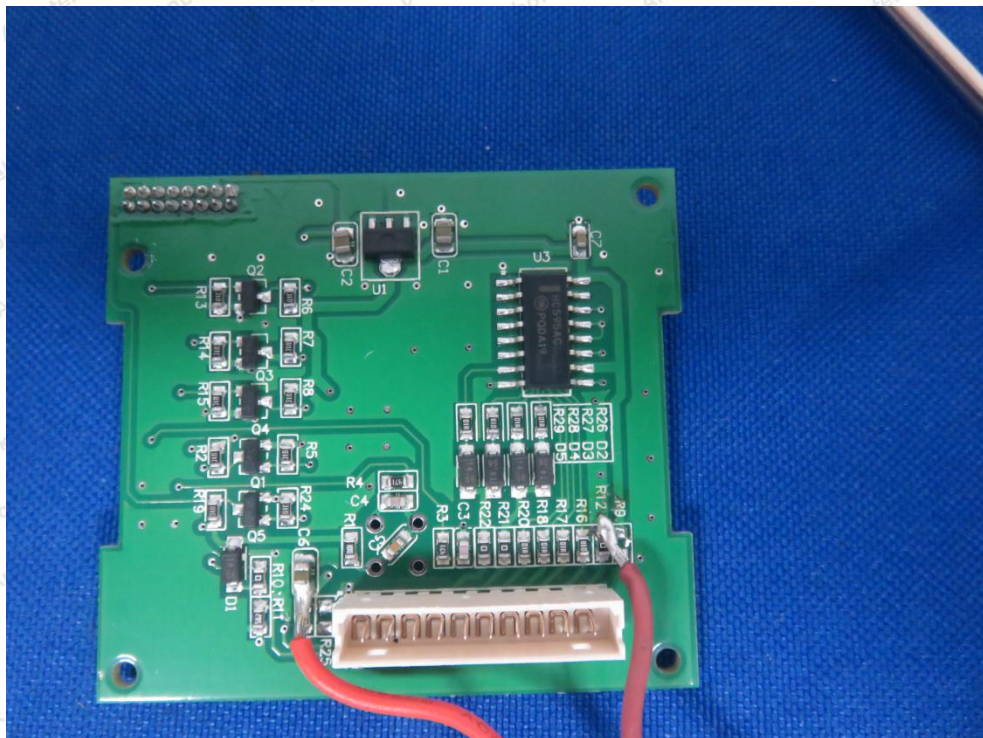
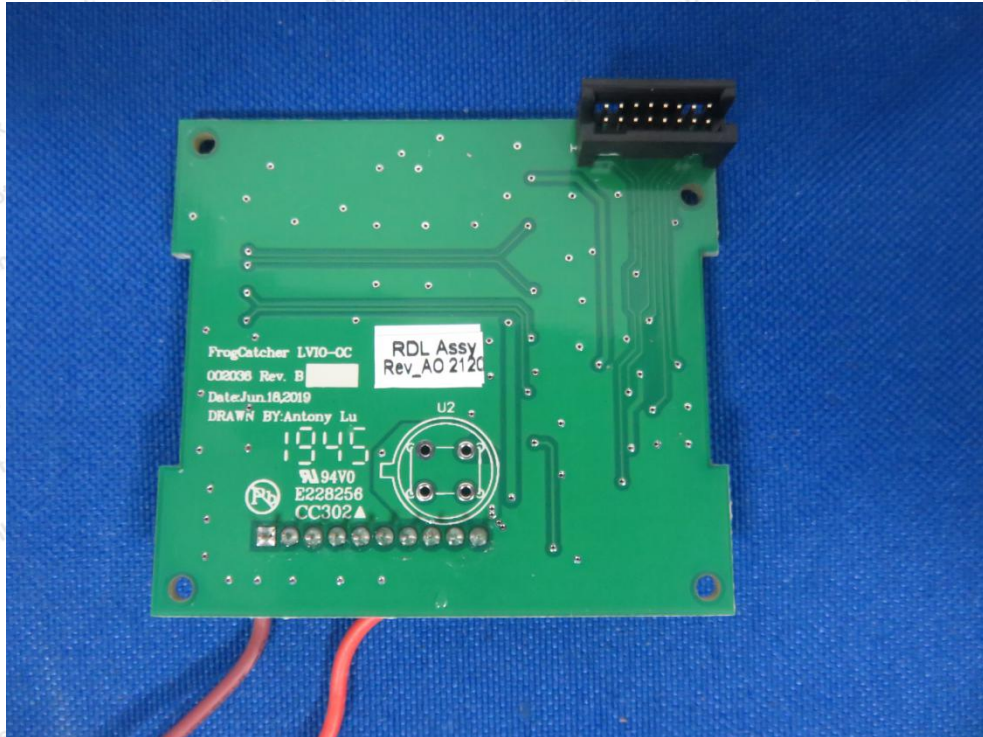



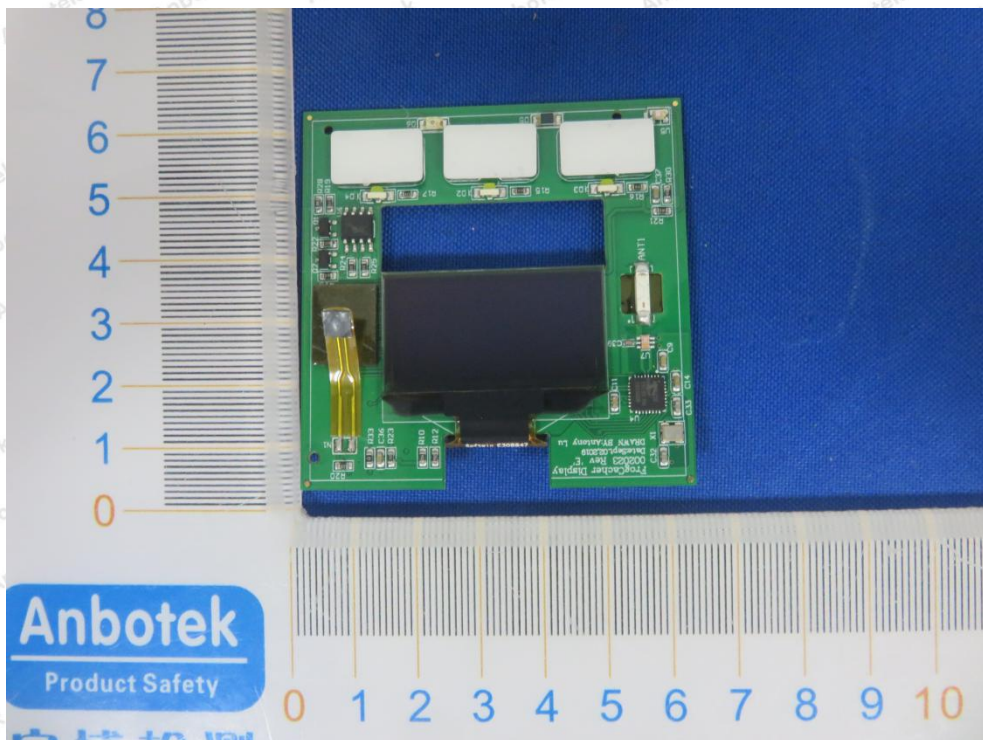
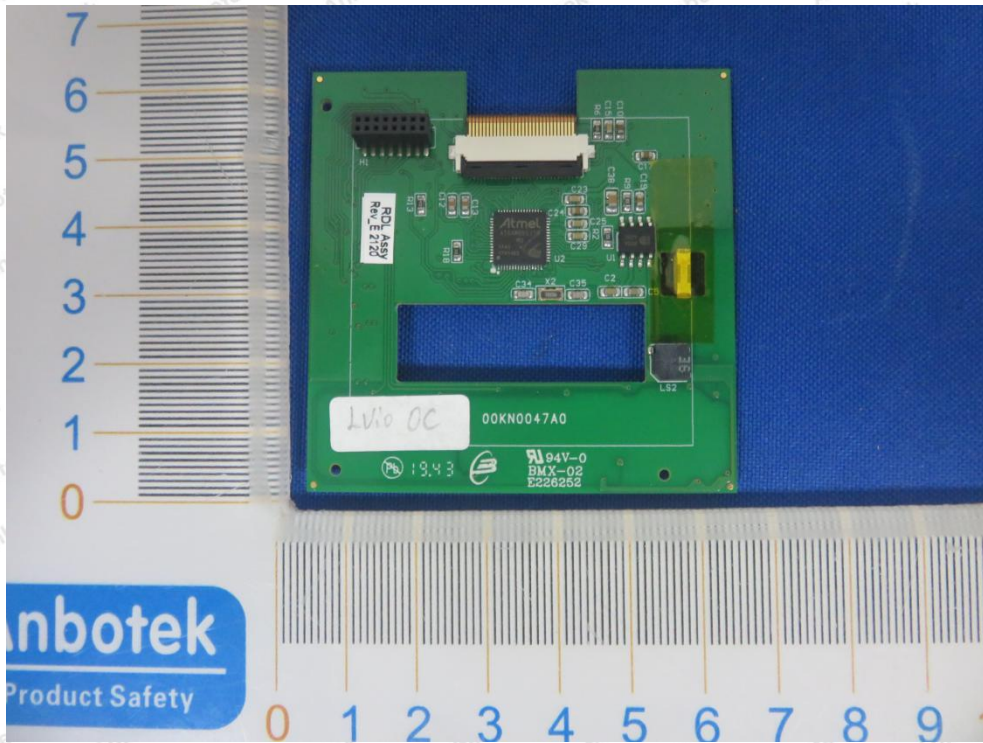



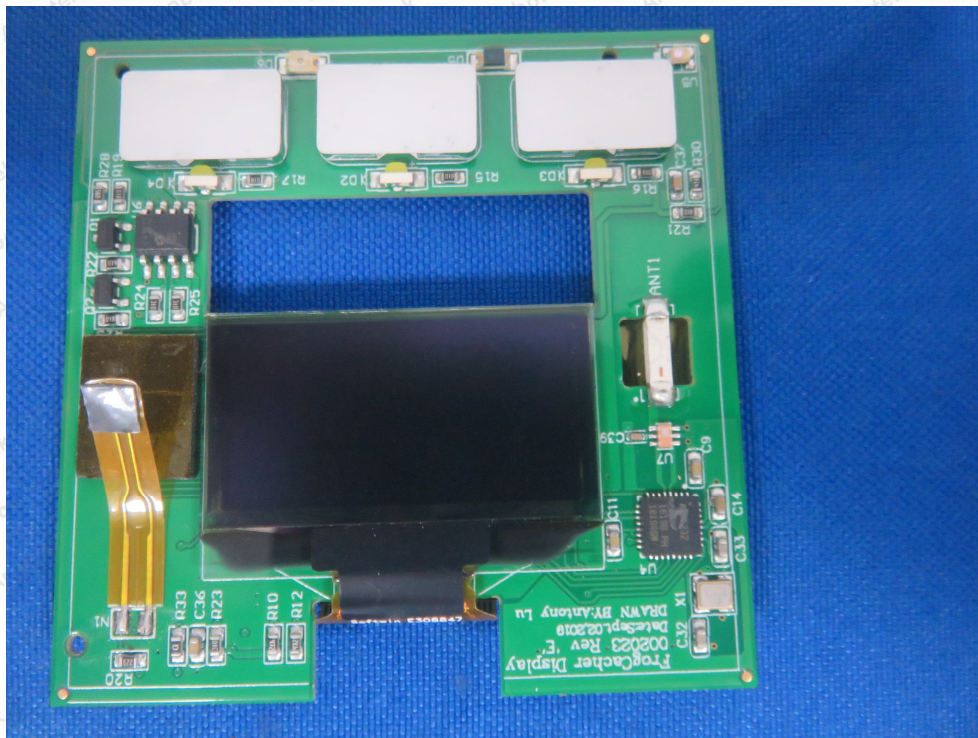

----- End of Report -----