

# 22

Finish

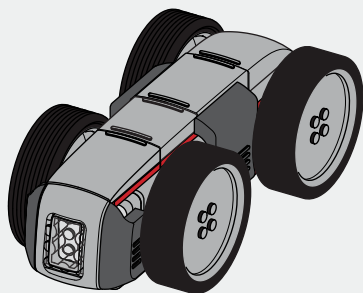

30

# 23

Turn on Window cube

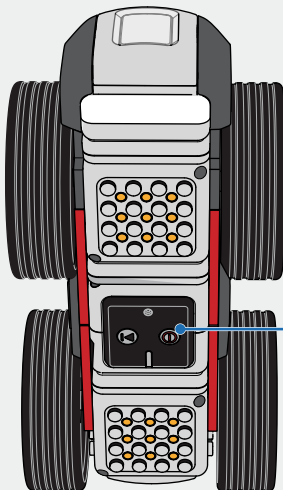
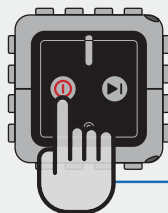

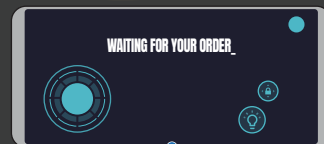
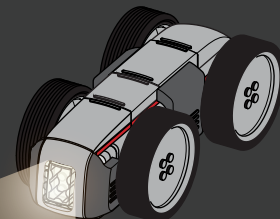

# 24

Playing with App



## NOTE

Maunzi RC App - Willy control mode

-  Joystick controls motion direction
-  Direction fix fixes motion direction
-  Light turn on or off light

# COBI

## Dynamic Wheeler Kit Burning Cannon Kit

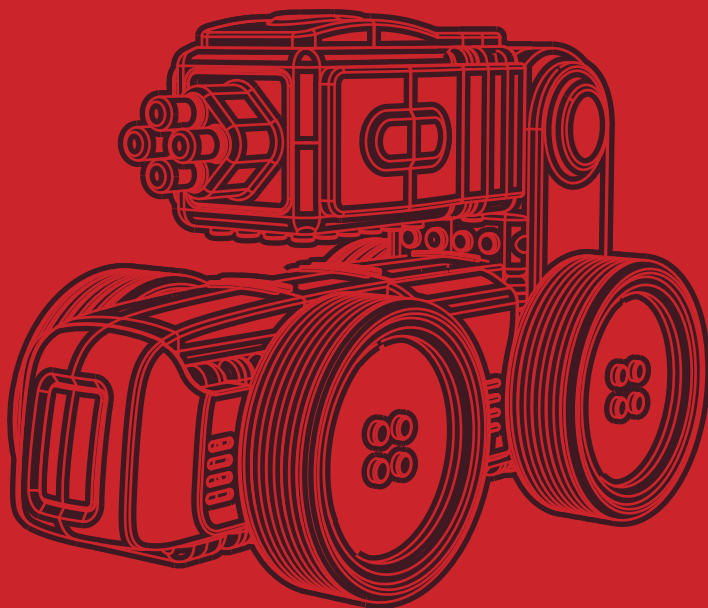
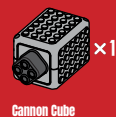
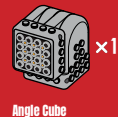
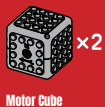

# 1

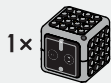

## NOTE

Place it so that the red side of Window cube shows on top.

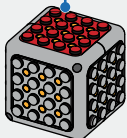

# 2

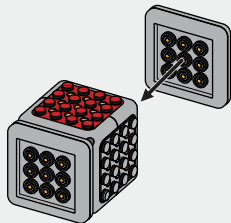

# 3

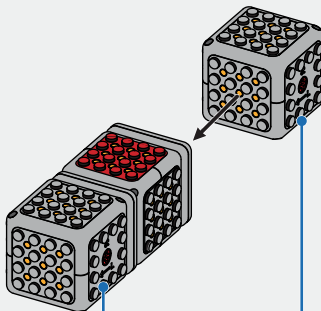
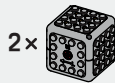

## NOTE

1 Place it so that  shows on top.

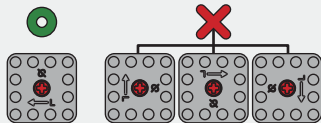

2 Place cubes so that  on the cubes point to the same direction.



# 4

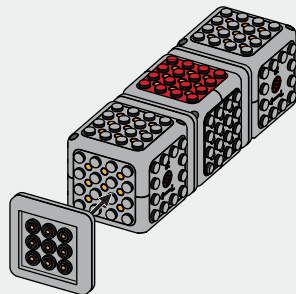

# 5

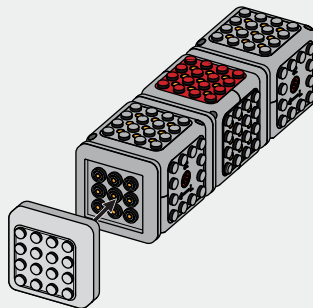

# 6

2x 

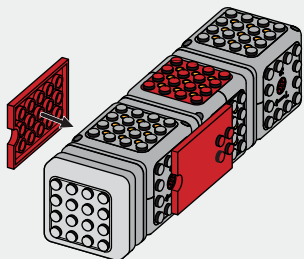

# 7

2x 

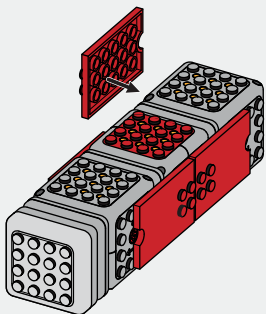

# 8

2x 

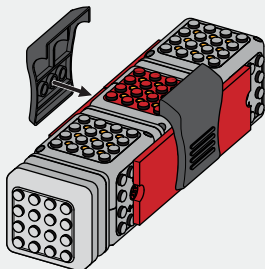

# 9

1x 

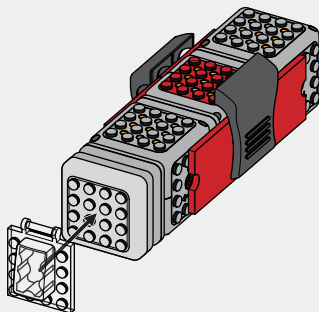

# 10

1x 

 **NOTE**

Insert transparent brick's pole into red brick's hook.

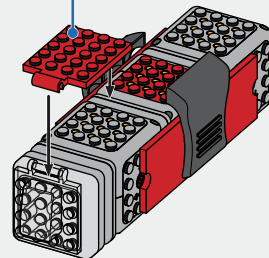

# 11

1× 

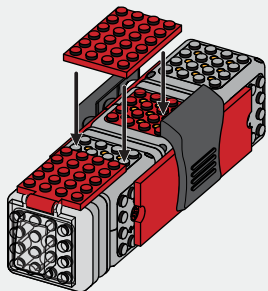

# 12

1× 

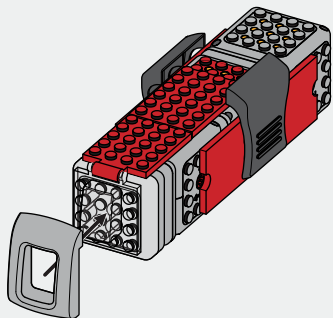

# 13

1×  1× 



**NOTE**

Notice the different shapes of left and right.

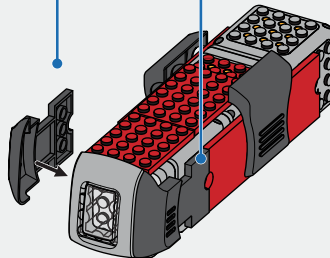

# 14

1× 

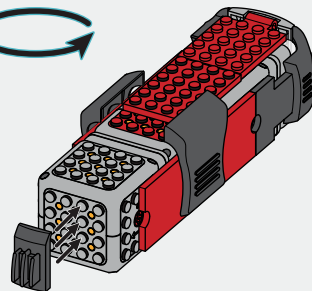

# 15

1× 

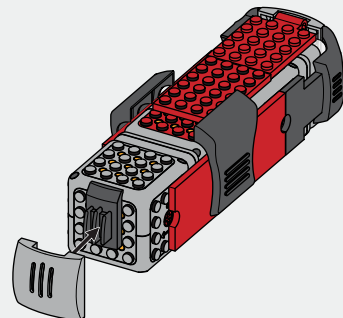

# 16

1× 

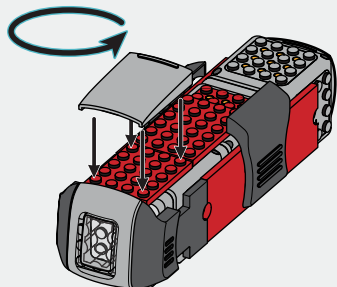

# 17

1× 

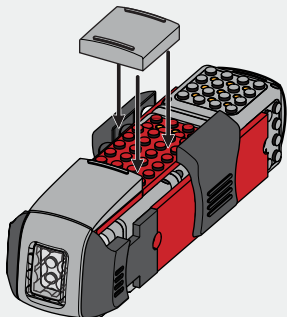

# 18

1× 

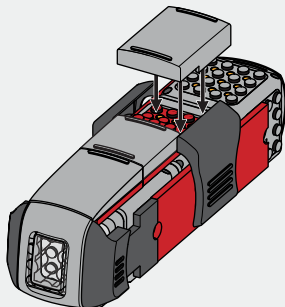

# 19

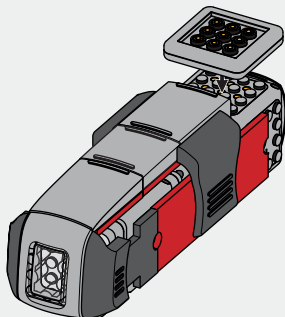

1× 



# 20

1× 

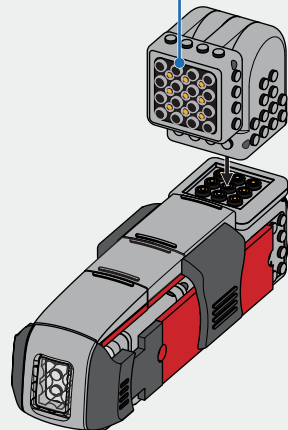
 **NOTE**  
Have the black side of Angle cube face forward.



# 21

1× 

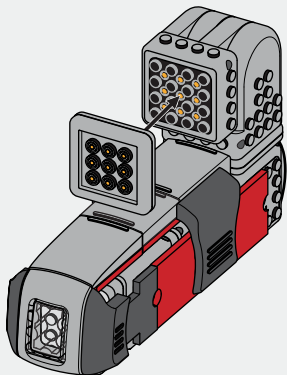

# 22

1× 

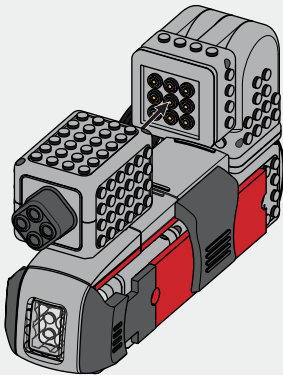

# 23

4× 

