

# 1

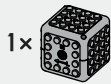

**NOTE**

1 Place it so that shows on top.

2 Make sure the direction of ← .

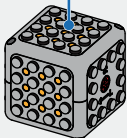

# 2

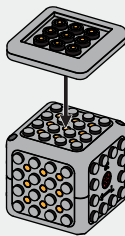

# 3

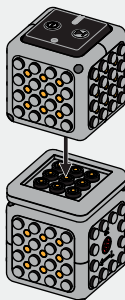
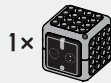

# 4

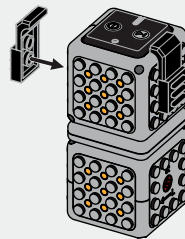

# 5

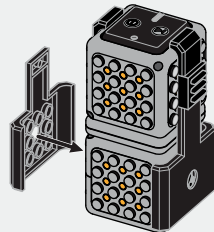

# 6

2x 

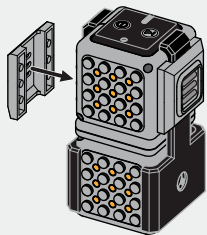

# 8

1x 

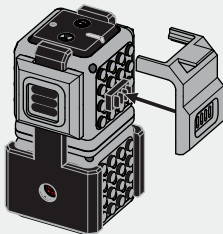

# 10

1x 

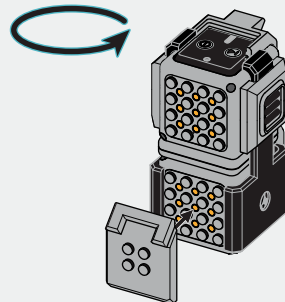

# 7

1x 

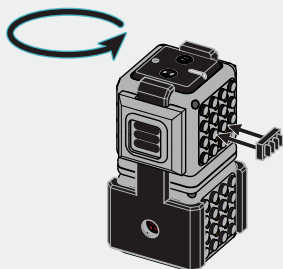

# 9

1x 

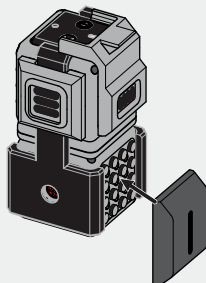

# 11

1x 

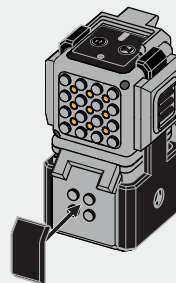

# 12

1x 

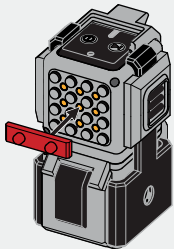

# 14

1x 

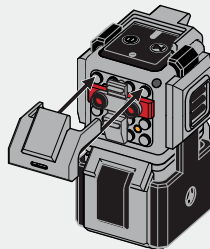

# 16

2x 

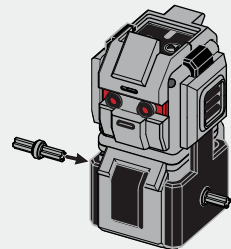

# 13

1x 

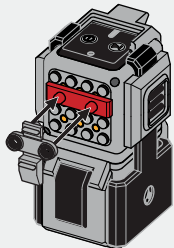

# 15

1x 

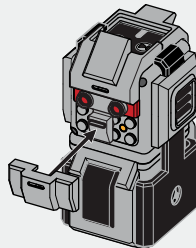

# 17

2x 

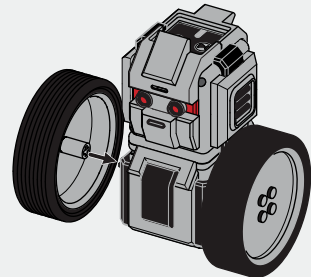

# 18

Finish

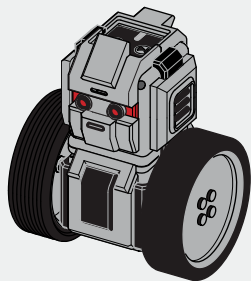

# 19

Turn on Window cube

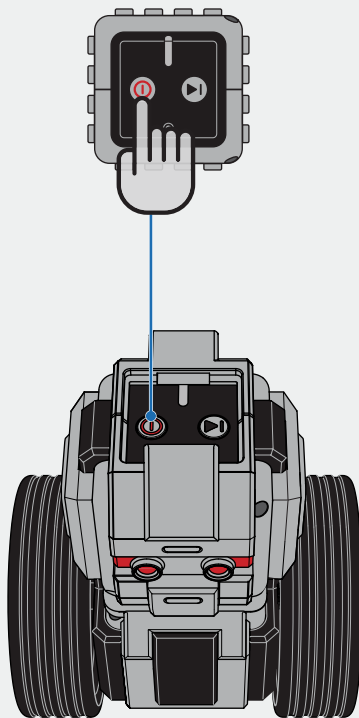

# 20

Playing with App

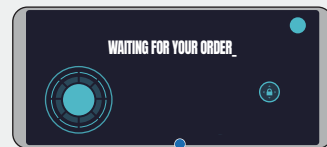
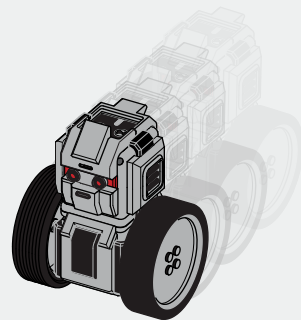

## NOTE

Maunzi RC App - Nick control mode

-  Joystick controls motion direction
-  Direction fix fixes motion direction

# WILLY

## Dynamic Wheeler Kit Burning Cannon Kit

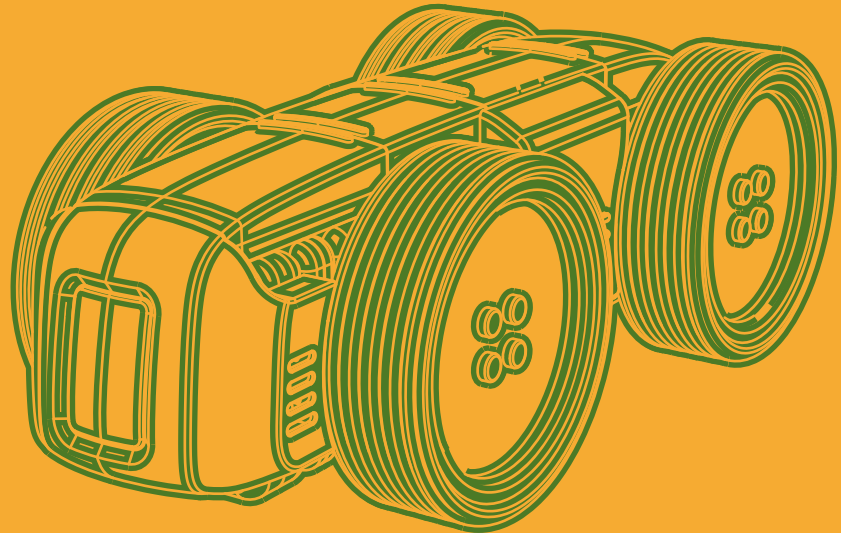
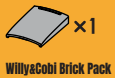
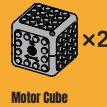

# 1

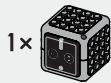

## NOTE

Place it so that the red side of Window cube shows on top.

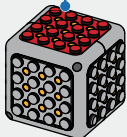

# 2

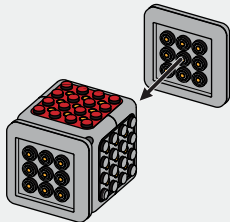

# 3

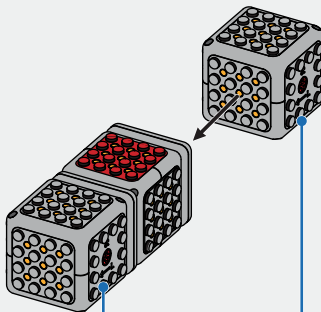
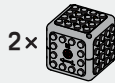

## NOTE

1 Place it so that shows on top.

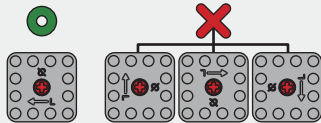

2 Place cubes so that on the cubes point to the same direction.

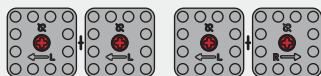

# 4

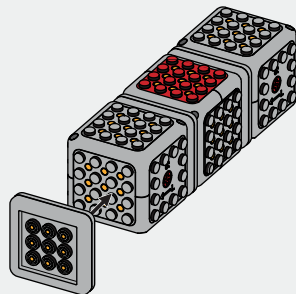

# 5

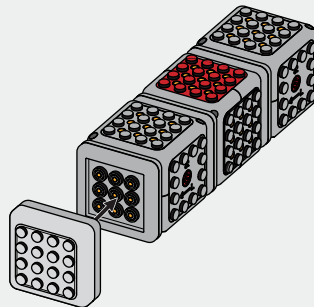

# 6

2x 

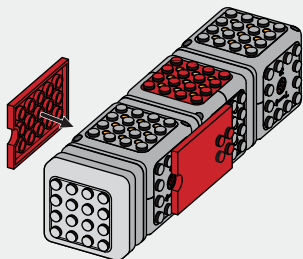

# 7

2x 

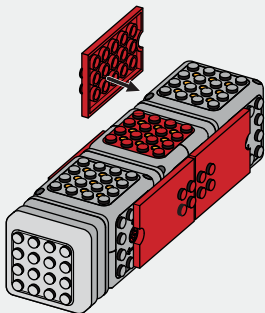

# 8

2x 

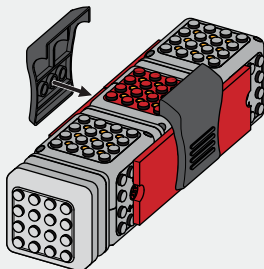

# 9

1x 

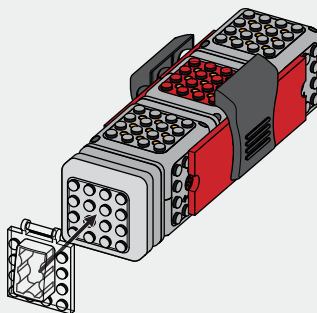

# 10

1x 

 **NOTE**

Insert transparent brick's pole into red brick's hook.

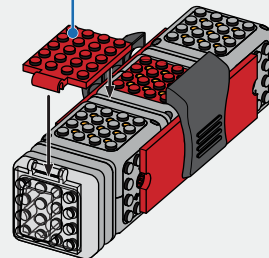

# 11

1× 

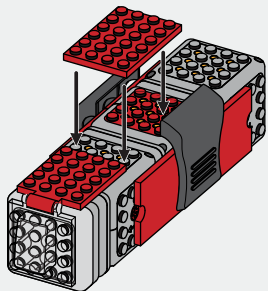

# 12

1× 

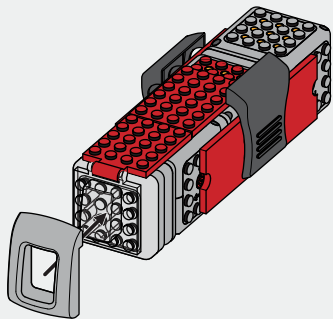

# 13

1×  1× 



**NOTE**

Notice the different shapes of left and right.

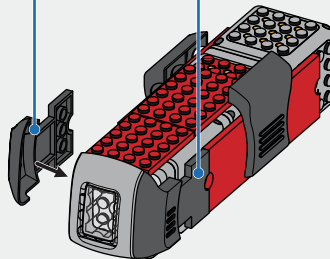

# 14

1× 

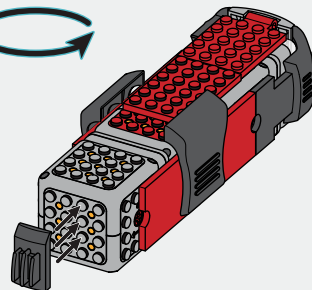

# 15

1× 

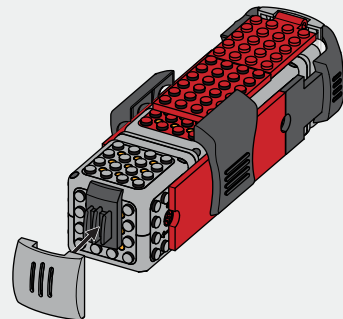



# 16

1 ×

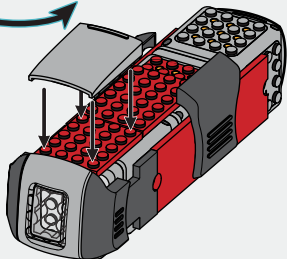

# 18

1 ×

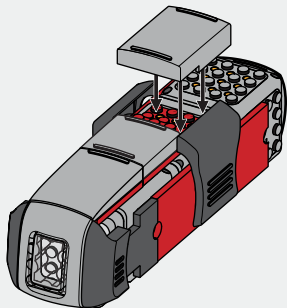

# 20

4 ×

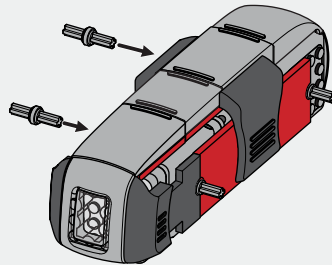

# 17

1 ×

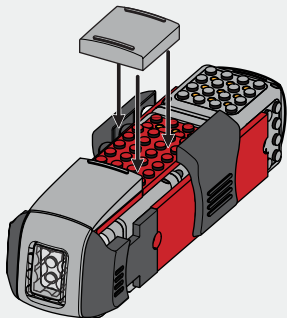

# 19

1 ×

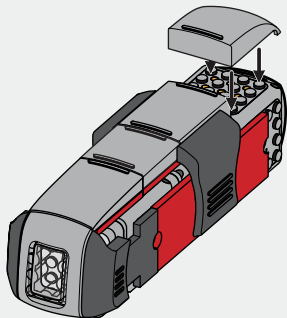

# 21

4 ×

