



FCC RADIO TEST REPORT

FCC ID : 2AWNP-AP20-48
Equipment : 5G AP-Indoor (B48+n48)
Brand Name : Celona
Model Name : AP20-48
Applicant : Celona Inc.
 900 E. Hamilton Avenue, Suite
 200,CAMPBELL,CA 95008. United States.
Manufacturer : Celona Inc.
 900 E. Hamilton Avenue, Suite
 200,CAMPBELL,CA 95008. United States.
Standard : FCC 47 CFR Part 2, 96

The product was received on Mar. 07, 2023 and testing was performed from Apr. 06, 2023 to Jun. 08, 2023. We, Sporton International Inc. EMC & Wireless Communications Laboratory, would like to declare that the tested sample has been evaluated in accordance with the test procedures given in ANSI / TIA-603-E and has been in compliance with the applicable technical standards.

The test results in this report apply exclusively to the tested model / sample. Without written approval from Sporton International Inc. EMC & Wireless Communications Laboratory, the test report shall not be reproduced except in full.

Louis Wu

Approved by: Louis Wu

Sporton International Inc. EMC & Wireless Communications Laboratory

No. 52, Huaya 1st Rd., Guishan Dist., Taoyuan City 333, Taiwan (R.O.C.)



Table of Contents

History of this test report..... 3

Summary of Test Result..... 4

1 General Description 5

 1.1 Product Feature of Equipment Under Test 5

 1.2 Modification of EUT 5

 1.3 Testing Location 6

 1.4 Applied Standards 7

2 Test Configuration of Equipment Under Test 8

 2.1 Test Mode..... 8

 2.2 Connection Diagram of Test System 9

 2.3 Measurement Results Explanation Example 9

 2.4 Frequency List of Low/Middle/High Channels..... 10

3 Conducted Test Items..... 11

 3.1 Measuring Instruments..... 11

 3.2 Conducted Output Power 12

 3.3 Peak-to-Average Ratio 13

 3.4 EIRP 14

 3.5 Occupied Bandwidth 15

 3.6 Conducted Band Edge 16

 3.7 Conducted Spurious Emission 17

 3.8 Frequency Stability..... 18

4 Radiated Test Items 19

 4.1 Measuring Instruments..... 19

 4.2 Test Setup 19

 4.3 Test Result of Radiated Test..... 20

 4.4 Radiated Spurious Emission 21

5 List of Measuring Equipment..... 22

6 Measurement Uncertainty 23

Appendix A. Test Results of Conducted Test

Appendix B. Test Results of Radiated Test

Appendix C. Test Setup Photographs



Summary of Test Result

Report Clause	Ref Std. Clause	Test Items	Result (PASS/FAIL)	Remark
3.2	§2.1046 RSS-192 8.6	Conducted Output Power	Reporting only	-
3.3	§96.41	Peak-to-Average Ratio	Pass	
3.4	§96.41	Effective Isotropic Radiated Power	Pass	-
3.5	§2.1049 §96.41	Occupied Bandwidth	Reporting only	-
3.6	§2.1051 §96.41	Conducted Band Edge Measurement	Pass	-
3.7	§2.1051 §96.41	Conducted Spurious Emission	Pass	
3.8	§2.1055	Frequency Stability for Temperature & Voltage	Pass	-
4.4	§2.1051 §96.41	Radiated Spurious Emission	Pass	2.68 dB under the limit at 14760.000 MHz

Conformity Assessment Condition:

1. The test results (PASS/FAIL) with all measurement uncertainty excluded are presented against the regulation limits or in accordance with the requirements stipulated by the applicant/manufacturer who shall bear all the risks of non-compliance that may potentially occur if measurement uncertainty is taken into account.
2. The measurement uncertainty please refer to each test result in the section "Measurement Uncertainty".

Disclaimer:

The product specifications of the EUT presented in the test report that may affect the test assessments are declared by the manufacturer who shall take full responsibility for the authenticity.

Reviewed by: Keven Cheng

Report Producer: Doris Chen



1 General Description

1.1 Product Feature of Equipment Under Test

Product Feature	
General Specs 5G NR and GPS.	
Antenna Type WWAN: Dipole Antenna GPS: External active Antenna	
Antenna Gain	<Ant. 1>: 6.59 dBi <Ant. 2>: 6.59 dBi

Remark:

1. The EUT's information above is declared by manufacturer. Please refer to Disclaimer in report summary.
2. The device is a 5G NR CBSD operation in the 3.55-3.7GHz CBRS band.
The device support 2T2R MIMO configuration and the antenna is completely uncorrelated.

1.2 Modification of EUT

No modifications made to the EUT during the testing.



1.3 Testing Location

Test Site	Sporton International Inc. EMC & Wireless Communications Laboratory
Test Site Location	No.52, Huaya 1st Rd., Guishan Dist., Taoyuan City 333, Taiwan (R.O.C.) TEL: +886-3-327-3456 FAX: +886-3-328-4978
Test Site No.	Sporton Site No. TH03-HY
Test Engineer	Hao Syu and Jimmy Chang
Temperature (°C)	20.1~23.7 °C
Relative Humidity (%)	49.6~54.4 %

Test Site	Sporton International Inc. Wensan Laboratory
Test Site Location	No.58, Aly. 75, Ln. 564, Wenhua 3rd, Rd., Guishan Dist., Taoyuan City 333010, Taiwan (R.O.C.) TEL: +886-3-327-0868 FAX: +886-3-327-0855
Test Site No.	Sporton Site No. 03CH12-HY (TAF Code: 3786)
Test Engineer	Jesse Fan, Tim Lee and Wilson Wu
Temperature (°C)	20~25
Relative Humidity (%)	50~60
Remark	The Radiated Spurious Emission test item subcontracted to Sporton International Inc. Wensan Laboratory.

Note: The test site complies with ANSI C63.4 2014 requirement.

FCC Designation No.: TW1190 and TW3786



1.4 Applied Standards

According to the specifications of the manufacturer, the EUT must comply with the requirements of the following standards:

- ♦ ANSI C63.26-2015
- ♦ ANSI / TIA-603-E
- ♦ FCC 47 CFR Part 2, 96
- ♦ FCC KDB 971168 D01 Power Meas. License Digital Systems v03r01
- ♦ FCC KDB 940660 D01 Part 96 CBRS Eqpt v03
- ♦ FCC KDB 412172 D01 Determining ERP and EIRP v01r01
- ♦ FCC KDB 414788 D01 Radiated Test Site v01r01
- ♦ FCC KDB 662911 D01 Multiple Transmitter Output v02r01.

Remark:

1. All the test items were validated and recorded in accordance with the standards without any modification during the testing.
2. The TAF code is not including all the FCC KDB listed without accreditation.



2 Test Configuration of Equipment Under Test

2.1 Test Mode

Antenna port conducted and radiated test items listed below are performed according to KDB 971168 D01 Power Meas. License Digital Systems v03r01 with maximum output power.

The conducted power for signal antenna would not exceed the conducted power for 2T2R MIMO configuration, so only MIMO configuration data is tested and reported.

Test Items	Band	Bandwidth (MHz)				Modulation				Test Channel		
		10	20	40	50	QPSK	16QAM	64QAM	256QAM	L	M	H
Max. Output Power	n48	-	v	v	-	v	-	v	v	v	v	v
E.I.R.P and EIRP PSD	n48	-	v	v	-	v	-	v	v	v		
26dB and 99% Bandwidth	n48	-	v	v	-	v	-	v	v		v	
Conducted Band Edge	n48	-	v	v	-	v	-	v	v	v	v	v
Conducted Spurious Emission	n48	-	v	v	-	v	-	v	v	v	v	v
Peak-to-Average Ratio	n48	-	v		-	v	-	v	v		v	
Frequency Stability	n48	-	v		-	v	-				v	
Radiated Spurious Emission	n48	Worst Case								v	v	v
Remark	<ol style="list-style-type: none"> The mark "v " means that this configuration is chosen for testing The mark "-" means that this bandwidth is not supported. The device is investigated from 30MHz to 10 times of fundamental signal for radiated spurious emission test. One representative bandwidth is selected to perform PAR and frequency stability. 											

2.2 Connection Diagram of Test System

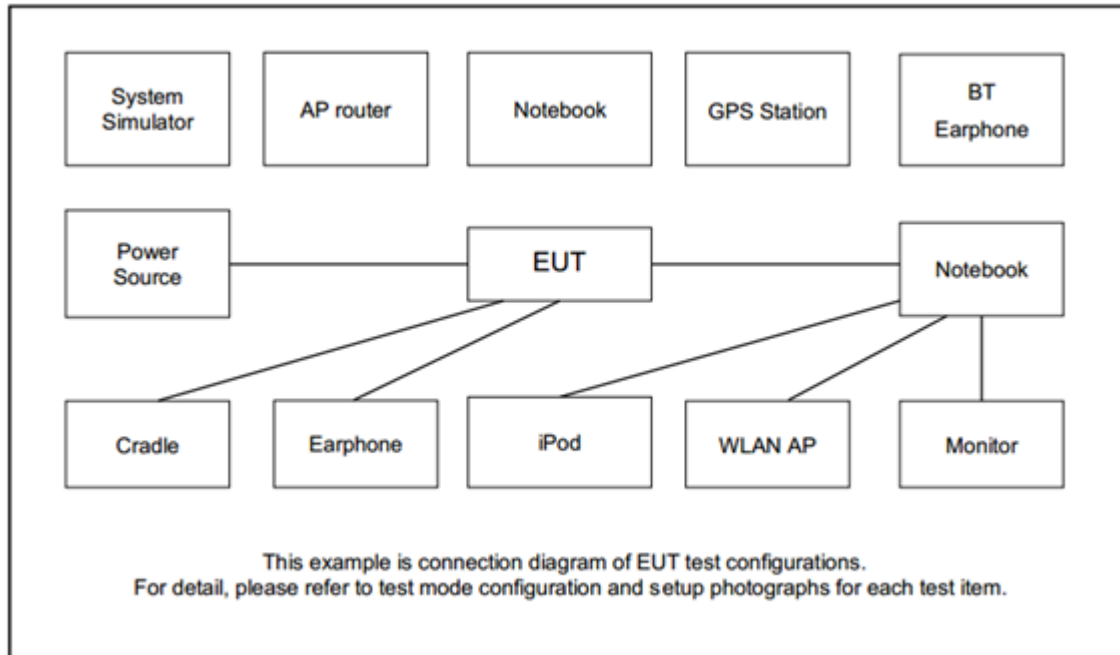

2.3 Measurement Results Explanation Example

For all conducted test items:

The offset level is set in the spectrum analyzer to compensate the RF cable loss and attenuator factor between EUT conducted output port and spectrum analyzer. With the offset compensation, the spectrum analyzer reading level is exactly the EUT RF output level.

The spectrum analyzer offset is derived from RF cable loss and attenuator factor.

Offset = RF cable loss + attenuator factor.

Following shows an offset computation example with cable loss 4.2 dB and 10dB attenuator.

Example :

Offset(dB) = RF cable loss(dB) + attenuator factor(dB).

$$= 4.2 + 10 = 14.2 \text{ (dB)}$$



2.4 Frequency List of Low/Middle/High Channels

5G NR n48 Channel and Frequency List				
BW [MHz]	Channel/Frequency (MHz)	Lowest	Middle	Highest
40	Channel	638000	641666	645332
	Frequency	3570	3624.99	3679.98
20	Channel	637334	641666	646000
	Frequency	3560.01	3624.99	3690

3 Conducted Test Items

3.1 Measuring Instruments

See list of measuring instruments of this test report.

3.1.1 Test Setup

3.1.2 Conducted Output Power

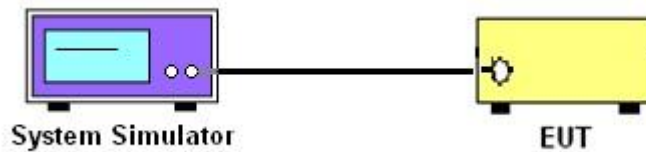

3.1.3 EIRP, Peak-to-Average Ratio, Occupied Bandwidth, Conducted Band-Edge and Conducted Spurious Emission

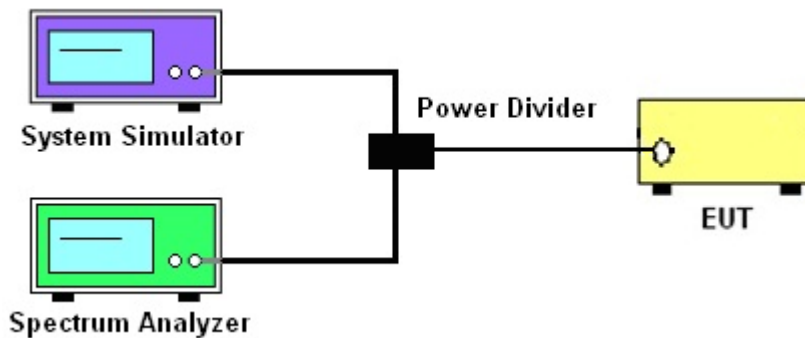

3.1.4 Frequency Stability

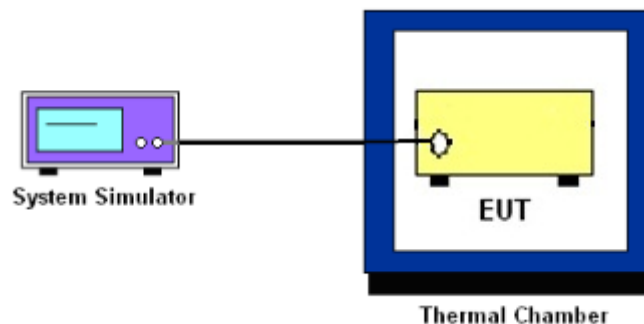

3.1.5 Test Result of Conducted Test

Please refer to Appendix A.



3.2 Conducted Output Power

3.2.1 Description of the Conducted Output Power Measurement

A power sensor was used to establish communication with the EUT. Its parameters were set to force the EUT transmitting at maximum output power. The measured power in the radio frequency on the transmitter output terminals shall be reported.

3.2.2 Test Procedures

1. The transmitter output port was connected to the system simulator.
 2. Set EUT at maximum power through the system simulator.
 3. Select lowest, middle, and highest channels for each band and different modulation.
 4. Measure and record the power level from the system simulator.
 5. The measure-and-sum technique is used for measuring in-band transmit power of a device.
- Total power is the sum of the conducted power levels measured at the various output ports.



3.3 Peak-to-Average Ratio

3.3.1 Description of the PAR Measurement

96.41(g)

The peak-to-average power ratio (PAPR) of any CBSD transmitter output power must not exceed 13 dB. PAPR measurements should be made using either an instrument with complementary cumulative distribution function (CCDF) capabilities or another Commission approved procedure. The measurement must be performed using a signal corresponding to the highest PAPR expected during periods of continuous transmission.

3.3.2 Test Procedures

The testing follows ANSI C63.26-2015 Section 5.2.6

1. The EUT was connected to spectrum.
2. Set the CCDF (Complementary Cumulative Distribution Function) option in spectrum analyzer.
3. The highest RF powers were measured and recorded the maximum PAPR level associated with a probability of 0.1 %.
4. Record the deviation as Peak to Average Ratio



3.4 EIRP

3.4.1 Description of the EIRP Measurement

3.4.2 Description of the EIRP Measurement

The EIRP of mobile transmitters must not exceed 23 dBm /10 megahertz for 5G NR n48.

The testing follows ANSI C63.26-2015 Section 5.2.5.5

According to KDB 412172 D01 Power Approach,

$EIRP = P_T + G_T - LC$, where

P_T = transmitter output power in dBm

G_T = gain of the transmitting antenna in dBi

LC = signal attenuation in the connecting cable between the transmitter and antenna in dB

Device	Maximum EIRP (dBm/10 MHz)	Maximum PSD (dBm/MHz)
Category A CBSD	30	20

3.4.3 Test Procedures

1. The testing follows procedure in Section 5.2 of ANSI C63.26-2015 and KDB 940660 D01 Part 96 CBRS Eqpt v03 Section 3.2(b)(2) and 3.2(b)(3)
2. Determine the EIRP by adding the effective antenna gain to the measured average conducted power level.
3. For MIMO measurement, the KDB 662911 E)2)c) is used as following:
Measure and add $10 \log(NANT)$ dB, where NANT is the number of outputs. With this technique, spectrum measurements are performed at each output of the device, but rather than summing the spectra or the spectral peaks across the outputs, the quantity $10 \log(NANT)$ dB is added to each spectrum value before comparing to the emission limit.



3.5 Occupied Bandwidth

3.5.1 Description of Occupied Bandwidth Measurement

The occupied bandwidth is the width of a frequency band such that, below the lower and above the upper frequency limits, the mean powers emitted are each equal to a specified percentage 0.5% of the total mean transmitted power.

The 26 dB emission bandwidth is defined as the frequency range between two points, one above and one below the carrier frequency, at which the spectral density of the emission is attenuated 26 dB below the maximum in-band spectral density of the modulated signal. Spectral density (power per unit bandwidth) is to be measured with a detector of resolution bandwidth equal to approximately 1.0% of the emission bandwidth.

3.5.2 Test Procedures

The testing follows ANSI C63.26-2015 Section 5.4.3 (26dB) and Section 5.4.4 (99OB)

1. The EUT was connected to spectrum analyzer.
2. The spectrum analyzer center frequency is set to the nominal EUT channel center frequency. The span range for the spectrum analyzer shall be between two and five times the anticipated OBW.
3. The nominal resolution bandwidth (RBW) shall be in the range of 1 to 5 % of the anticipated OBW, and the VBW shall be at least 3 times the RBW.
4. Set the detection mode to peak, and the trace mode to max hold.
5. Determine the reference value: Set the EUT to transmit a modulated signal. Allow the trace to stabilize. Set the spectrum analyzer marker to the highest level of the displayed trace.
(this is the reference value)
6. Determine the “-26 dB down amplitude” as equal to (Reference Value – X).
7. Place two markers, one at the lowest and the other at the highest frequency of the envelope of the spectral display such that each marker is at or slightly below the “-X dB down amplitude” determined in step 6. If a marker is below this “-X dB down amplitude” value it shall be placed as close as possible to this value. The OBW is the positive frequency difference between the two markers.
8. Use the 99 % power bandwidth function of the spectrum analyzer and report the measured bandwidth.



3.6 Conducted Band Edge

3.6.1 Description of Conducted Band Edge Measurement

96.41(e)(1)

The conducted power of any CBSD emission outside the fundamental emission bandwidth shall not exceed -13 dBm/MHz within 0-10 megahertz above the upper SAS-assigned channel edge and within 0-10 megahertz below the lower SAS-assigned channel edge. At all frequencies greater than 10 megahertz above the upper SAS assigned channel edge and less than 10 MHz below the lower SAS assigned channel edge, the conducted power of any CBSD emission shall not exceed -25 dBm/MHz. The upper and lower SAS assigned channel edges are the upper and lower limits of any channel assigned to a CBSD by an SAS, or in the case of multiple contiguous channels, the upper and lower limits of the combined contiguous channels.

96.41(e)(2)

The conducted power of emissions below 3540 MHz or above 3710 MHz shall not exceed -25 dBm/MHz, and the conducted power of emissions below 3530 MHz or above 3720 MHz shall not exceed -40 dBm/MHz.

3.6.2 Test Procedures

The testing follows FCC KDB 971168 D01 v03r01 Section 6.1.

1. The EUT was connected to spectrum analyzer.
2. The band edges of low and high channels for the highest RF powers were measured.
3. Set RBW $\geq 1\%$ EBW in the 1MHz band immediately outside and adjacent to the band edge.
4. Beyond the 1 MHz band from the band edge, RBW=1MHz was used
5. Set spectrum analyzer with RMS detector.
6. The RF fundamental frequency should be excluded against the limit line in the operating frequency band.
7. For MIMO measurement, the KDB 662911 E)2)c) is used as following:
Measure and add $10 \log(\text{NANT})$ dB, where NANT is the number of outputs. With this technique, spectrum measurements are performed at each output of the device, but rather than summing the spectra or the spectral peaks across the outputs, the quantity $10 \log(\text{NANT})$ dB is added to each spectrum value before comparing to the emission limit.



3.7 Conducted Spurious Emission

3.7.1 Description of Conducted Spurious Emission Measurement

96.41 (e)(2)

The conducted power of any emissions below 3530 MHz or above 3720 MHz shall not exceed -40dBm/MHz.

3.7.2 Test Procedures

The testing follows FCC KDB 971168 D01 v03r01 Section 6.1.

1. The EUT was connected to spectrum analyzer.
2. The RF output of EUT was connected to the spectrum analyzer by RF cable and attenuator. The path loss was compensated to the results for each measurement.
3. The middle channel for the highest RF power within the transmitting frequency was measured.
4. The conducted spurious emission for the whole frequency range was taken.
5. Make the measurement with the spectrum analyzer's RBW = 1MHz, VBW = 3MHz.
6. Set spectrum analyzer with RMS detector.
7. Taking the record of maximum spurious emission.
8. The RF fundamental frequency should be excluded against the limit line in the operating frequency band.
9. The limit line is -40dBm/MHz.
10. For MIMO measurement, the KDB 662911 E)2)c) is used as following:
Measure and add $10 \log(\text{NANT})$ dB, where NANT is the number of outputs. With this technique, spectrum measurements are performed at each output of the device, but rather than summing the spectra or the spectral peaks across the outputs, the quantity $10 \log(\text{NANT})$ dB is added to each spectrum value before comparing to the emission limit.



3.8 Frequency Stability

3.8.1 Description of Frequency Stability Measurement

The frequency stability shall be measured by variation of ambient temperature and variation of primary supply voltage to ensure that the fundamental emission stays within the authorized frequency block. The frequency stability of the transmitter shall be maintained within $\pm 0.00025\%$ ($\pm 2.5\text{ppm}$) of the center frequency

3.8.2 Test Procedures for Temperature Variation

The testing follows FCC KDB 971168 D01 v03r01 Section 9.0.

1. The EUT was set up in the thermal chamber and connected with the system simulator.
2. With power OFF, the temperature was decreased to -30°C and the EUT was stabilized before testing. Power was applied and the maximum change in frequency was recorded within one minute.
3. With power OFF, the temperature was raised in 10°C step up to 50°C . The EUT was stabilized at each step for at least half an hour. Power was applied and the maximum frequency change was recorded within one minute.

3.8.3 Test Procedures for Voltage Variation

The testing follows FCC KDB 971168 D01 v03r01 Section 9.0.

1. The EUT was placed in a temperature chamber at $25\pm 5^{\circ}\text{C}$ and connected with the system simulator.
2. The power supply voltage to the EUT was varied from 85% to 115% of the nominal value measured at the input to the EUT.
3. The variation in frequency was measured for the worst case.

4 Radiated Test Items

4.1 Measuring Instruments

See list of measuring instruments of this test report.

4.2 Test Setup

For radiated emissions below 30MHz

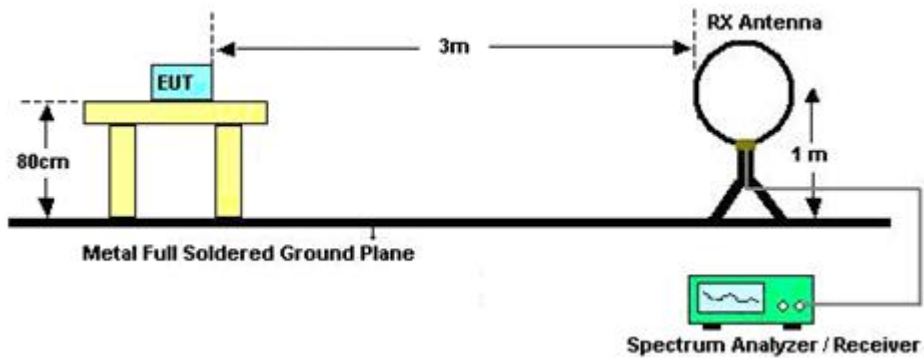

For radiated emissions from 30MHz to 1GHz

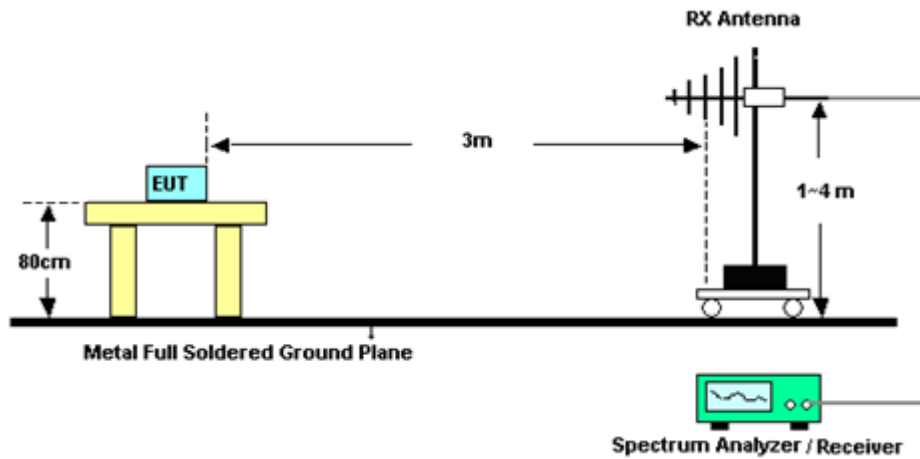

For radiated test from 1GHz to 18GHz

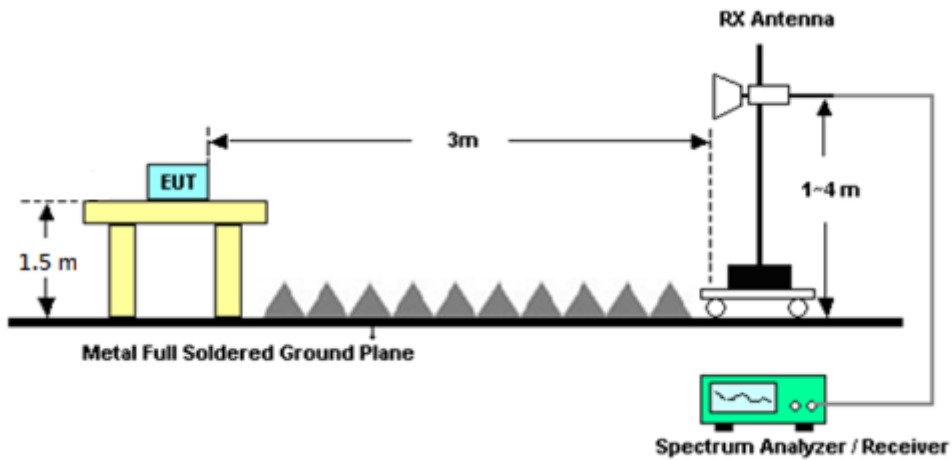

For radiated test above 18GHz

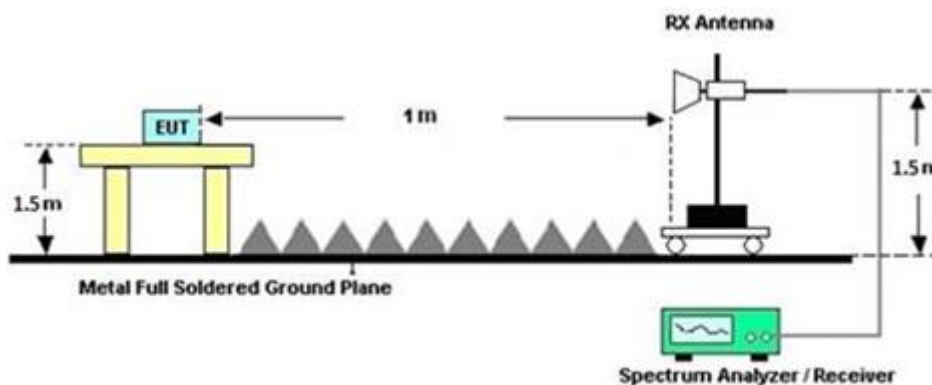

4.3 Test Result of Radiated Test

Please refer to Appendix B.

Note:

The low frequency, which started from 9 kHz to 30MHz, was pre-scanned and the result which was 20dB lower than the limit line was not reported.

There is adequate comparison measurement of both open-field test site and alternative test site - semi-Anechoic chamber according to 414788 D01 Radiated Test Site v01r01, and the result came out very similar.



4.4 Radiated Spurious Emission

4.4.1 Description of Radiated Spurious Emission Measurement

The radiated spurious emission was measured by substitution method according to ANSI / TIA-603-E. The power of any emission outside of the authorized operating frequency ranges must be attenuated below the transmitter power (P) by a factor of at least -40dBm / MHz .

The spectrum is scanned from 30 MHz up to a frequency including its 10th harmonic.

4.4.2 Test Procedures

The testing follows FCC KDB 971168 D01 v03r01 Section 7 and ANSI / TIA-603-E Section 2.2.12.

1. The EUT was placed on a turntable with 0.8 meter height for frequency below 1GHz and 1.5 meter height for frequency above 1GHz respectively above ground.
2. The EUT was set 3 meters from the receiving antenna mounted on the antenna tower.
3. The table was rotated 360 degrees to determine the position of the highest spurious emission.
4. The height of the receiving antenna is varied between 1m to 4m to search the maximum spurious emission for both horizontal and vertical polarizations.
5. During the measurement, the system simulator parameters were set to force the EUT transmitting at maximum output power.
6. Make the measurement with the spectrum analyzer's RBW = 1MHz, VBW = 3MHz, taking the record of maximum spurious emission.
7. A horn antenna was substituted in place of the EUT and was driven by a signal generator. Tune the output power of signal generator to the same emission level with EUT maximum spurious emission.
$$\text{EIRP (dBm)} = \text{S.G. Power} - \text{Tx Cable Loss} + \text{Tx Antenna Gain}$$
$$\text{ERP (dBm)} = \text{EIRP} - 2.15$$
8. The RF fundamental frequency should be excluded against the limit line in the operating frequency band.



5 List of Measuring Equipment

Instrument	Brand Name	Model No.	Serial No.	Characteristics	Calibration Date	Test Date	Due Date	Remark
Signal Analyzer	Rohde & Schwarz	FSV3044	101103	10Hz~44GHz	Feb. 09, 2023	Apr. 06, 2023~ Jun. 03, 2023	Feb. 08, 2024	Conducted (TH03-HY)
Thermal Chamber	Ten Billion	TTH-D3SP	TBN-930701	-40°C~90°C	Oct. 19, 2022	Apr. 06, 2023~ Jun. 03, 2023	Oct. 18, 2023	Conducted (TH03-HY)
USB Power Sensor	DARE	RPR3006W	13I00030SNO 32 (NO:43)	9kHz~6GHz	Dec. 07, 2022	Apr. 06, 2023~ Jun. 03, 2023	Dec. 06, 2023	Conducted (TH03-HY)
Loop Antenna	Rohde & Schwarz	HFH2-Z2	100488	9 kHz~30 MHz	Sep. 20, 2022	Apr. 21, 2023~ Jun. 08, 2023	Sep. 19, 2023	Radiation (03CH12-HY)
Bilog Antenna	TESEQ	CBL 6111D & 00800N1D01 N-06	37059 & 01	30MHz~1GHz	Nov. 10, 2022	Apr. 21, 2023~ Jun. 08, 2023	Nov. 09, 2023	Radiation (03CH12-HY)
Horn Antenna	SCHWARZBE CK	BBHA 9120 D	9120D-02114	1GHz~18GHz	Aug. 09, 2022	Apr. 21, 2023~ Jun. 08, 2023	Aug. 08, 2023	Radiation (03CH12-HY)
SHF-EHF Horn Antenna	SCHWARZBE CK	BBHA9170	00993	18GHz-40GHz	Nov. 24, 2022	Apr. 21, 2023~ Jun. 08, 2023	Nov. 23, 2023	Radiation (03CH12-HY)
Preamplifier	COM-POWER	PA-103	161075	10MHz~1GHz	Mar. 21, 2023	Apr. 21, 2023~ Jun. 08, 2023	Mar. 20, 2024	Radiation (03CH12-HY)
Preamplifier	E-INSTRUME NT TECH LTD.	ERA-100M-18 G-56-01-A70	EC1900249	1GHz~18GHz	Dec. 21, 2022	Apr. 21, 2023~ Jun. 08, 2023	Dec. 20, 2023	Radiation (03CH12-HY)
Preamplifier	EMEC	EM18G40G	060715	18GHz~40GHz	Dec. 07, 2022	Apr. 21, 2023~ Jun. 08, 2023	Dec. 06, 2023	Radiation (03CH12-HY)
Spectrum Analyzer	Agilent	N9010A	MY53470118	10Hz~44GHz	Jan. 10, 2023	Apr. 21, 2023~ Jun. 08, 2023	Jan. 09, 2024	Radiation (03CH12-HY)
Filter	Wainwright	WHKX8-5872. 5-6750-18000 -40ST	SN2	6.75GHz High Pass Filter	Mar. 14, 2023	Apr. 21, 2023~ Jun. 08, 2023	Mar. 13, 2024	Radiation (03CH12-HY)
RF Cable	HUBER + SUHNER	SUCOFLEX 102	803951/2	9kHz~30MHz	Mar. 07, 2023	Apr. 21, 2023~ Jun. 08, 2023	Mar. 06, 2024	Radiation (03CH12-HY)
RF Cable	HUBER + SUHNER	SUCOFLEX 126E	0058/126E	30MHz~18GHz	Dec. 20, 2022	Apr. 21, 2023~ Jun. 08, 2023	Dec. 19, 2023	Radiation (03CH12-HY)
RF Cable	HUBER + SUHNER	SUCOFLEX 102	505134/2	30MHz~40GHz	Dec. 20, 2022	Apr. 21, 2023~ Jun. 08, 2023	Dec. 19, 2023	Radiation (03CH12-HY)
RF Cable	HUBER + SUHNER	SUCOFLEX 102	803953/2	30MHz~40GHz	Dec. 20, 2022	Apr. 21, 2023~ Jun. 08, 2023	Dec. 19, 2023	Radiation (03CH12-HY)
Hygrometer	TECPEL	DTM-303B	TP210090	N/A	Oct. 03, 2022	Apr. 21, 2023~ Jun. 08, 2023	Oct. 02, 2023	Radiation (03CH12-HY)
Controller	EMEC	EM1000	N/A	Control Turn table & Ant Mast	N/A	Apr. 21, 2023~ Jun. 08, 2023	N/A	Radiation (03CH12-HY)
Antenna Mast	EMEC	AM-BS-4500- B	N/A	1m~4m	N/A	Apr. 21, 2023~ Jun. 08, 2023	N/A	Radiation (03CH12-HY)
Turn Table	EMEC	TT2000	N/A	0~360 Degree	N/A	Apr. 21, 2023~ Jun. 08, 2023	N/A	Radiation (03CH12-HY)
Software	Audix	E3 6.2009-8-24	RK-000989	N/A	N/A	Apr. 21, 2023~ Jun. 08, 2023	N/A	Radiation (03CH12-HY)



6 Measurement Uncertainty

Uncertainty of Radiated Emission Measurement (30 MHz ~ 1000 MHz)

Measuring Uncertainty for a Level of Confidence of 95% ($U = 2Uc(y)$)	3.31 dB
---	---------

Uncertainty of Radiated Emission Measurement (1 GHz ~ 18 GHz)

Measuring Uncertainty for a Level of Confidence of 95% ($U = 2Uc(y)$)	3.25 dB
---	---------

Uncertainty of Radiated Emission Measurement (18 GHz ~ 40 GHz)

Measuring Uncertainty for a Level of Confidence of 95% ($U = 2Uc(y)$)	3.81 dB
---	---------



Appendix A. Test Results of Conducted Test



QPSK	Average Burst Power (dBm)											
	Low Channel				Middle Channel				High Channel			
	ANT0	ANT1	SUM	EIRP	ANT0	ANT1	SUM	EIRP	ANT0	ANT1	SUM	EIRP
20MHz	21.30	22.30	24.84	31.43	21.50	22.00	24.77	31.36	21.80	22.00	24.91	31.50
40MHz	21.90	22.10	25.01	31.60	22.40	23.10	25.77	32.36	23.40	22.80	26.12	32.71

64QAM	Average Burst Power (dBm)											
	Low Channel				Middle Channel				High Channel			
	ANT0	ANT1	SUM	EIRP	ANT0	ANT1	SUM	EIRP	ANT0	ANT1	SUM	EIRP
20MHz	21.30	22.20	24.78	31.37	21.50	22.00	24.77	31.36	21.70	21.20	24.47	31.06
40MHz	21.80	22.10	24.96	31.55	22.40	23.00	25.72	32.31	23.40	22.70	26.07	32.66

256QAM	Average Burst Power (dBm)											
	Low Channel				Middle Channel				High Channel			
	ANT0	ANT1	SUM	EIRP	ANT0	ANT1	SUM	EIRP	ANT0	ANT1	SUM	EIRP
20MHz	21.20	22.20	24.74	31.33	21.40	21.90	24.67	31.26	21.60	21.20	24.41	31.00
40MHz	21.80	22.10	24.96	31.55	22.40	23.00	25.72	32.31	23.30	22.80	26.07	32.66



FR1 n48

<MIMO ANT 0>

Maximum EIRP (dBm/10MHz)

Mode	FR1 n48 : Conducted (dBm/10MHz) <SISO> Lowest Channel							
	10MHz		20MHz		40MHz		50MHz	
Mod.	QPSK	16QAM	QPSK	16QAM	QPSK	16QAM	QPSK	16QAM
Lowest CH	-	-	18.79	-	16.31	-	-	-
Mod.	64QAM	256QAM	64QAM	256QAM	64QAM	256QAM	64QAM	256QAM
Lowest CH	-	-	18.79	18.61	16.14	16.03	-	-

Mode	FR1 n48 : Maximum EIRP (dBm/10MHz) <MIMO 2TX> Lowest Channel							
	10MHz		20MHz		40MHz		50MHz	
Mod.	QPSK	16QAM	QPSK	16QAM	QPSK	16QAM	QPSK	16QAM
Lowest CH	-	-	28.39	-	25.91	-	-	-
Mod.	64QAM	256QAM	64QAM	256QAM	64QAM	256QAM	64QAM	256QAM
Lowest CH	-	-	28.39	28.21	25.74	25.63	-	-
Limit	30dBm/10MHz							
Result	PASS							

Note

1. The measured conducted result has included duty cycle offset factor.
2. The Maximum EIRP = conducted result + 3.01dB (2TX) + 6.59dBi MIMO antenna gain.



Mode	FR1 n48 : Conducted (dBm/10MHz) <SISO> Middle Channel							
	10MHz		20MHz		40MHz		50MHz	
BW								
Mod.	QPSK	16QAM	QPSK	16QAM	QPSK	16QAM	QPSK	16QAM
Middle CH	-	-	19.07	-	16.35	-	-	-
Mod.	64QAM	256QAM	64QAM	256QAM	64QAM	256QAM	64QAM	256QAM
Middle CH	-	-	19.11	19.00	16.43	16.31	-	-

Mode	FR1 n48 : Maximum EIRP (dBm/10MHz) <MIMO 2TX> Middle Channel							
	10MHz		20MHz		40MHz		50MHz	
BW								
Mod.	QPSK	16QAM	QPSK	16QAM	QPSK	16QAM	QPSK	16QAM
Middle CH	-	-	28.67	-	25.95	-	-	-
Mod.	64QAM	256QAM	64QAM	256QAM	64QAM	256QAM	64QAM	256QAM
Middle CH	-	-	28.71	28.60	26.03	25.91	-	-
Limit	30dBm/10MHz							
Result	PASS							

Note

1. The measured conducted result has included duty cycle offset factor.
2. The Maximum EIRP = conducted result + 3.01dB (2TX) + 6.59dBi MIMO antenna gain.



Mode	FR1 n48 : Conducted (dBm/10MHz) <SISO> Highest Channel							
	10MHz		20MHz		40MHz		50MHz	
BW								
Mod.	QPSK	16QAM	QPSK	16QAM	QPSK	16QAM	QPSK	16QAM
Highest CH	-	-	19.09	-	17.74	-	-	-
Mod.	64QAM	256QAM	64QAM	256QAM	64QAM	256QAM	64QAM	256QAM
Highest CH	-	-	18.76	19.01	17.34	18.04	-	-

Mode	FR1 n48 : Maximum EIRP (dBm/10MHz) <MIMO 2TX> Highest Channel							
	10MHz		20MHz		40MHz		50MHz	
BW								
Mod.	QPSK	16QAM	QPSK	16QAM	QPSK	16QAM	QPSK	16QAM
Highest CH	-	-	28.69	-	27.34	-	-	-
Mod.	64QAM	256QAM	64QAM	256QAM	64QAM	256QAM	64QAM	256QAM
Highest CH	-	-	28.36	28.61	26.94	27.64	-	-
Limit	30dBm/10MHz							
Result	PASS							

Note

1. The measured conducted result has included duty cycle offset factor.
2. The Maximum EIRP = conducted result + 3.01dB (2TX) + 6.59dBi MIMO antenna gain.



FR1 n48 / 20MHz / Lowest Channel / Conducted (dBm/10MHz)

QPSK

16QAM

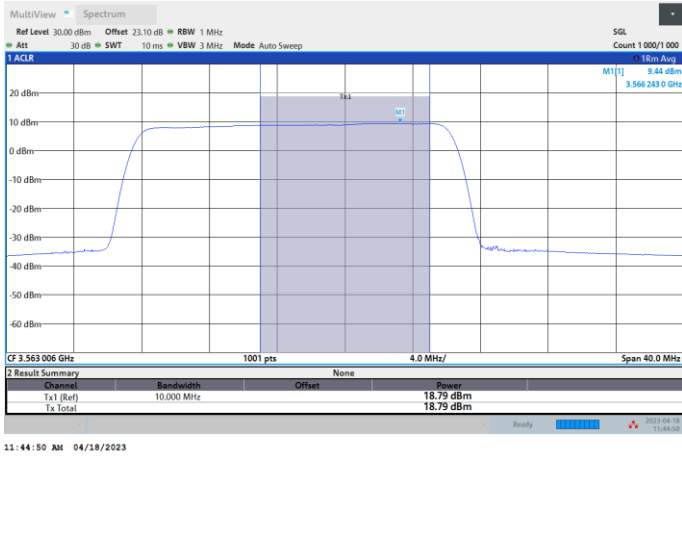

N/A

64QAM

256QAM

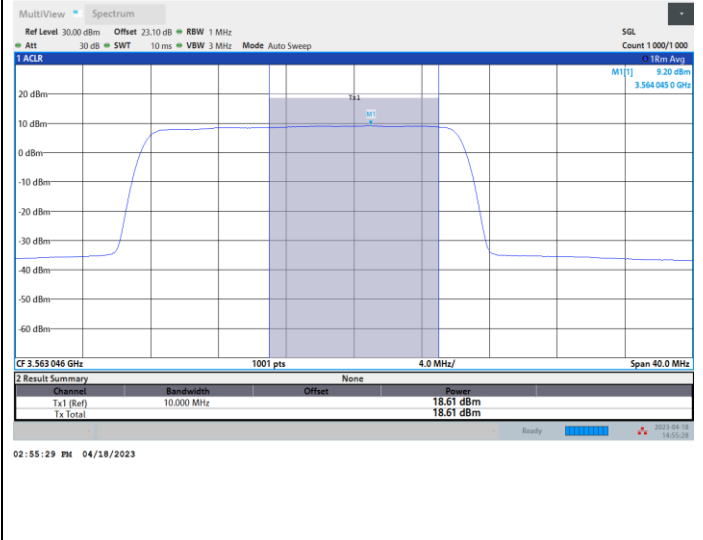
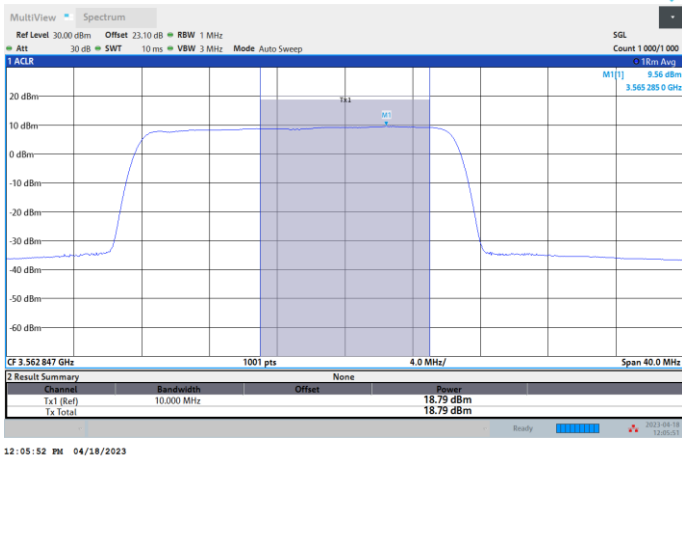



FR1 n48 / 20MHz / Middle Channel / Conducted (dBm/10MHz)

QPSK

16QAM

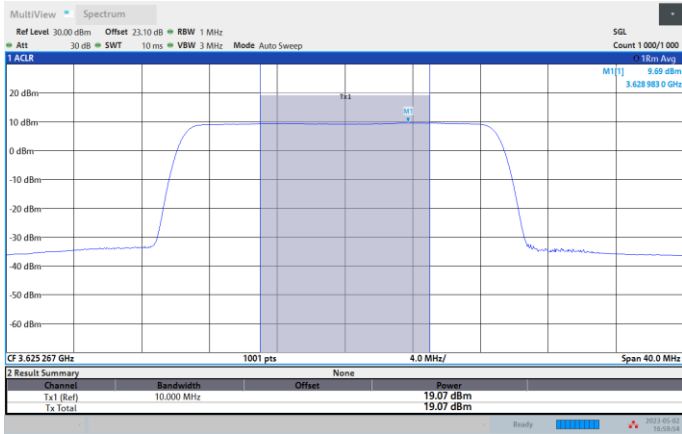

N/A

64QAM

256QAM

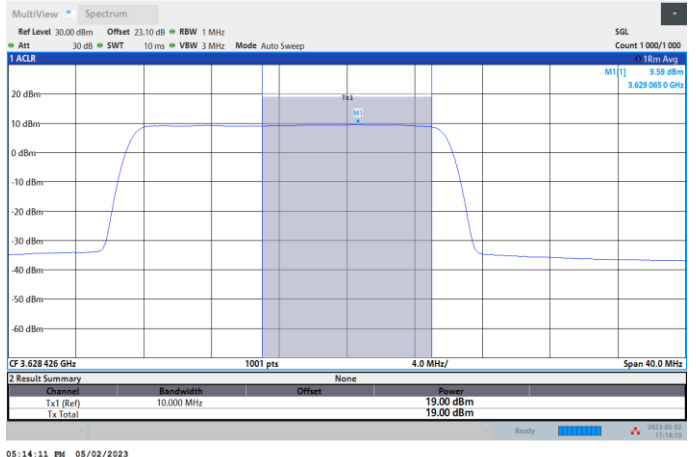
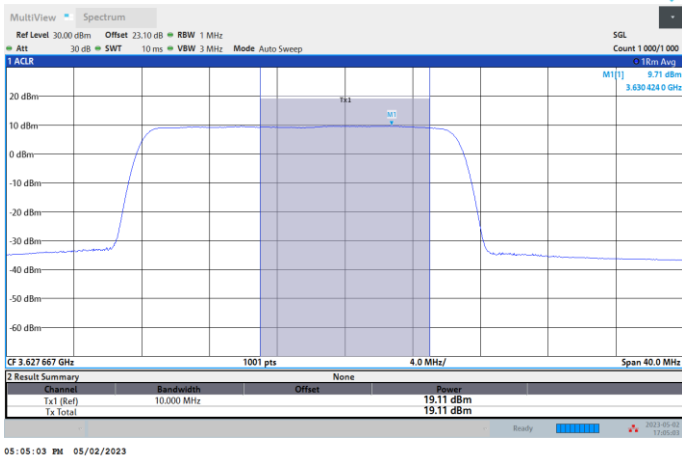



FR1 n48 / 20MHz / Highest Channel / Conducted (dBm/10MHz)

QPSK

16QAM

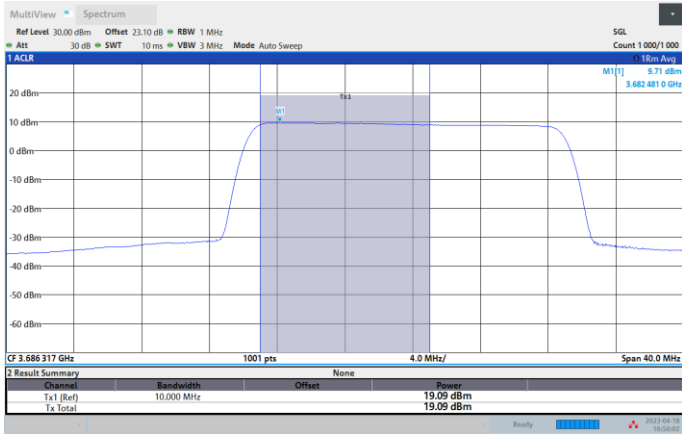

N/A

64QAM

256QAM

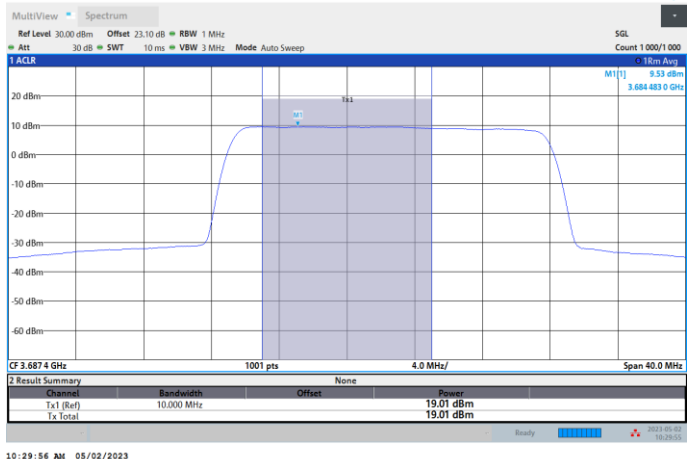
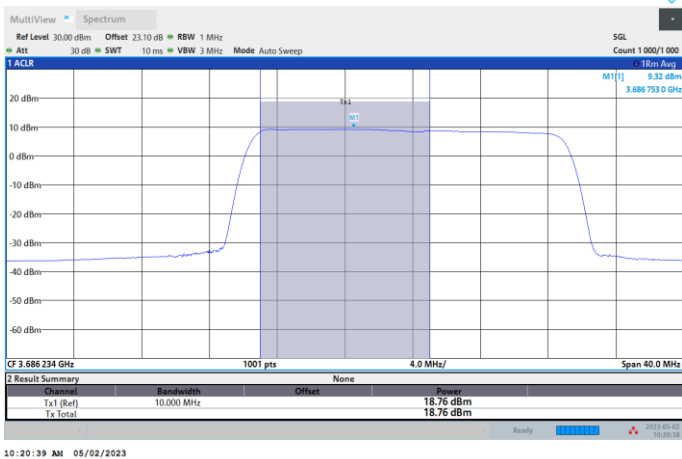



FR1 n48 / 40MHz / Lowest Channel / Conducted (dBm/10MHz)

QPSK

16QAM

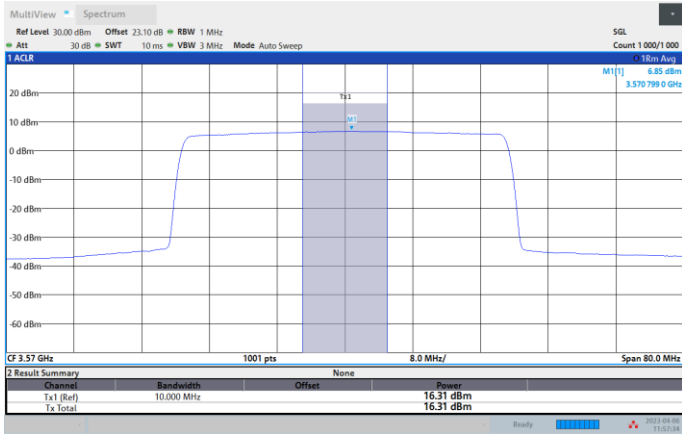

N/A

64QAM

256QAM

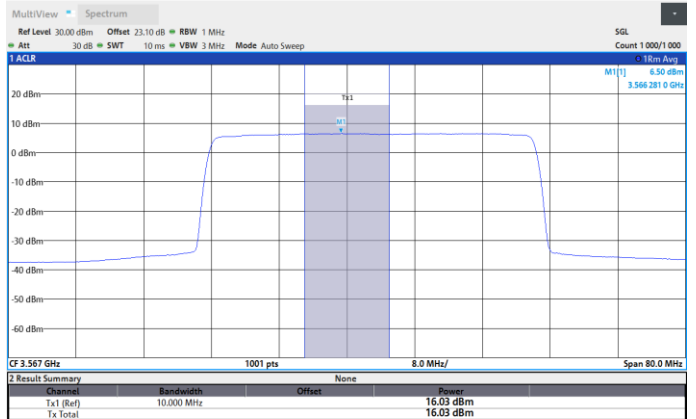
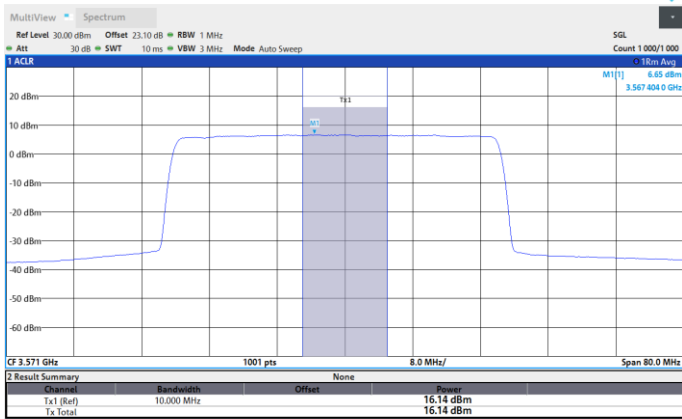



FR1 n48 / 40MHz / Middle Channel / Conducted (dBm/10MHz)

QPSK

16QAM

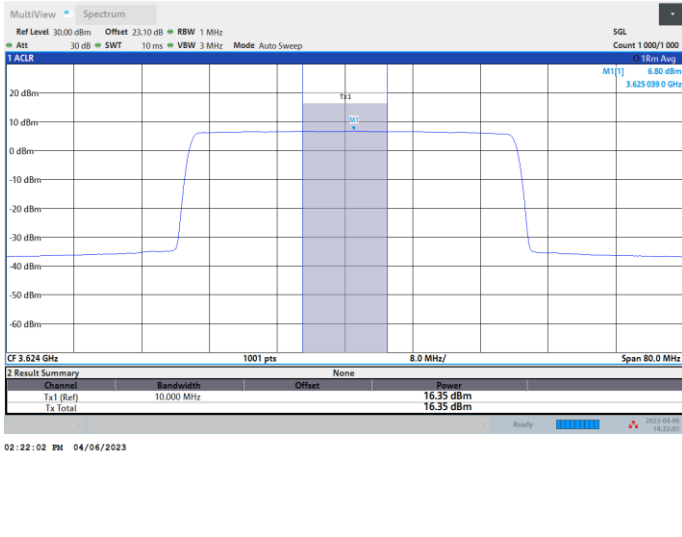

N/A

64QAM

256QAM

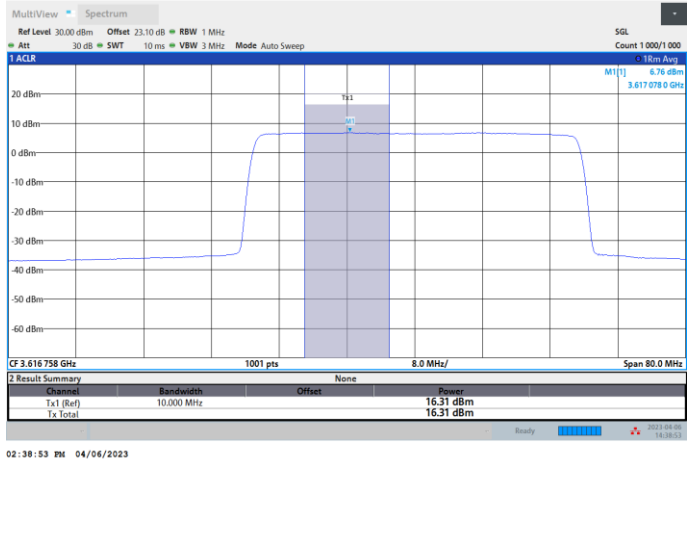
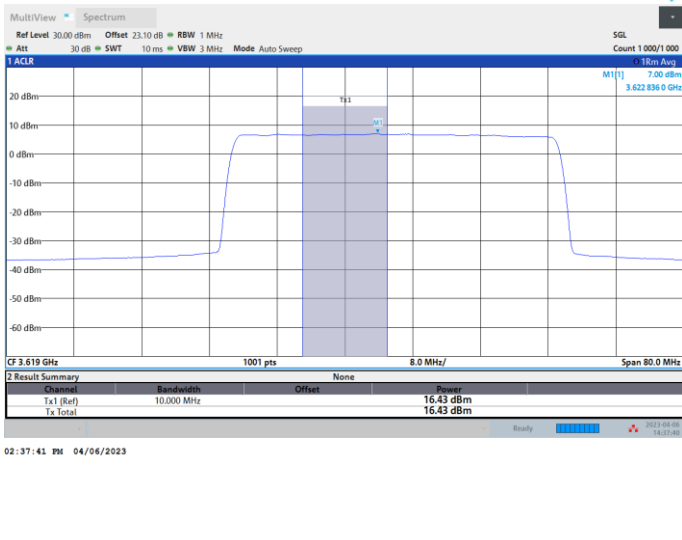



FR1 n48 / 40MHz / Highest Channel / Conducted (dBm/10MHz)

QPSK

16QAM

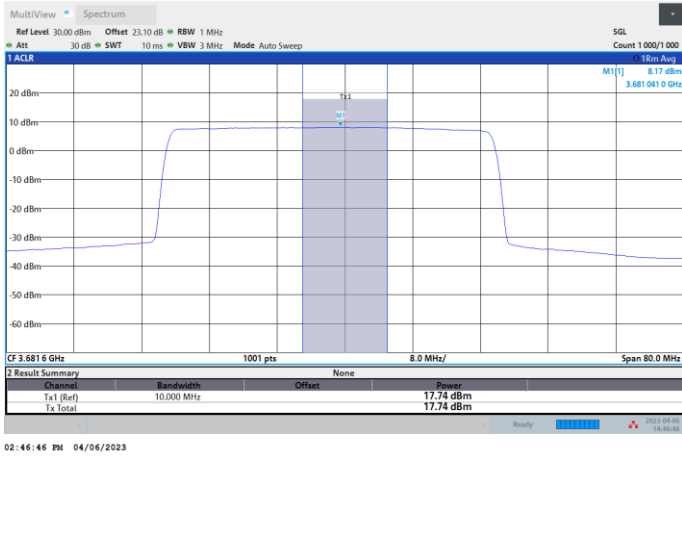

N/A

64QAM

256QAM

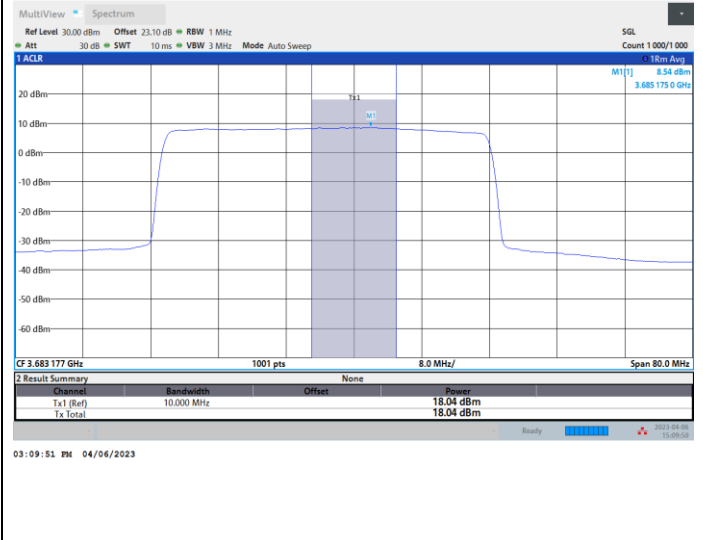
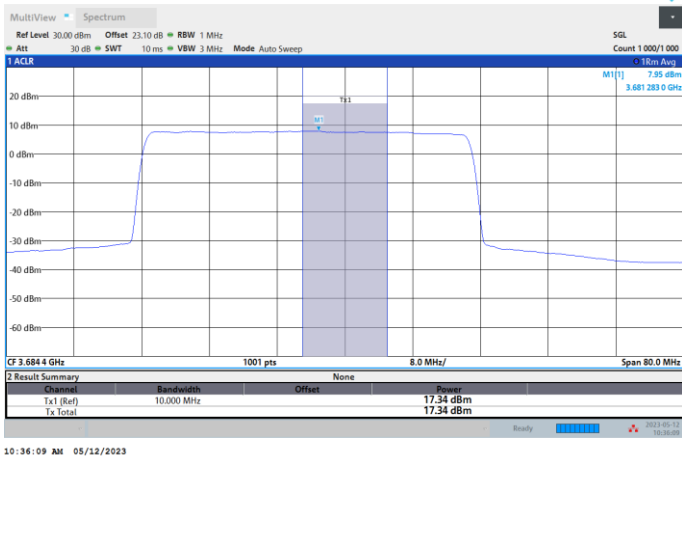



Power Spectral Density

Mode	FR1 n48 : Conducted PSD (dBm/MHz) <SISO> Lowest Channel							
	10MHz		20MHz		40MHz		50MHz	
Mod.	QPSK	16QAM	QPSK	16QAM	QPSK	16QAM	QPSK	16QAM
Lowest CH	-	-	10.01	-	6.89	-	-	-
Mod.	64QAM	256QAM	64QAM	256QAM	64QAM	256QAM	64QAM	256QAM
Lowest CH	-	-	9.97	9.41	7.10	7.23	-	-

Mode	FR1 n48 : EIRP PSD (dBm/MHz) <MIMO 2TX> Lowest Channel							
	10MHz		20MHz		40MHz		50MHz	
Mod.	QPSK	16QAM	QPSK	16QAM	QPSK	16QAM	QPSK	16QAM
Lowest CH	-	-	19.61	-	16.49	-	-	-
Mod.	64QAM	256QAM	64QAM	256QAM	64QAM	256QAM	64QAM	256QAM
Lowest CH	-	-	19.57	19.01	16.70	16.83	-	-
Limit	20dBm/MHz							
Result	PASS							

Note

1. The measured conducted PSD result has included duty cycle offset factor.
2. The EIRP PSD = conducted PSD result + 3.01dB (2TX) + 6.59dBi MIMO antenna gain.



Mode	FR1 n48 : Conducted PSD (dBm/MHz) <SISO> Middle Channel							
	10MHz		20MHz		40MHz		50MHz	
BW								
Mod.	QPSK	16QAM	QPSK	16QAM	QPSK	16QAM	QPSK	16QAM
Middle CH	-	-	10.13	-	7.02	-	-	-
Mod.	64QAM	256QAM	64QAM	256QAM	64QAM	256QAM	64QAM	256QAM
Middle CH	-	-	10.10	9.98	7.24	7.01	-	-

Mode	FR1 n48 : EIRP PSD (dBm/MHz) <MIMO 2TX> Middle Channel							
	10MHz		20MHz		40MHz		50MHz	
BW								
Mod.	QPSK	16QAM	QPSK	16QAM	QPSK	16QAM	QPSK	16QAM
Middle CH	-	-	19.73	-	16.62	-	-	-
Mod.	64QAM	256QAM	64QAM	256QAM	64QAM	256QAM	64QAM	256QAM
Middle CH	-	-	19.70	19.58	16.84	16.61	-	-
Limit	20dBm/MHz							
Result	PASS							

Note

1. The measured conducted PSD result has included duty cycle offset factor.
2. The EIRP PSD = conducted PSD result + 3.01dB (2TX) + 6.59dBi MIMO antenna gain.



Mode	FR1 n48 : Conducted PSD (dBm/MHz) <SISO> Highest Channel							
	10MHz		20MHz		40MHz		50MHz	
BW								
Mod.	QPSK	16QAM	QPSK	16QAM	QPSK	16QAM	QPSK	16QAM
Highest CH	-	-	10.01	-	8.56	-	-	-
Mod.	64QAM	256QAM	64QAM	256QAM	64QAM	256QAM	64QAM	256QAM
Highest CH	-	-	10.19	10.29	8.17	8.50	-	-

Mode	FR1 n48 : EIRP PSD (dBm/MHz) <MIMO 2TX> Highest Channel							
	10MHz		20MHz		40MHz		50MHz	
BW								
Mod.	QPSK	16QAM	QPSK	16QAM	QPSK	16QAM	QPSK	16QAM
Highest CH	-	-	19.61	-	18.16	-	-	-
Mod.	64QAM	256QAM	64QAM	256QAM	64QAM	256QAM	64QAM	256QAM
Highest CH	-	-	19.79	19.89	17.77	18.10	-	-
Limit	20dBm/MHz							
Result	PASS							

Note

1. The measured conducted PSD result has included duty cycle offset factor.
2. The EIRP PSD = conducted PSD result + 3.01dB (2TX) + 6.59dBi MIMO antenna gain.



FR1 n48 / 20MHz / Lowest Channel / PSD

QPSK

16QAM

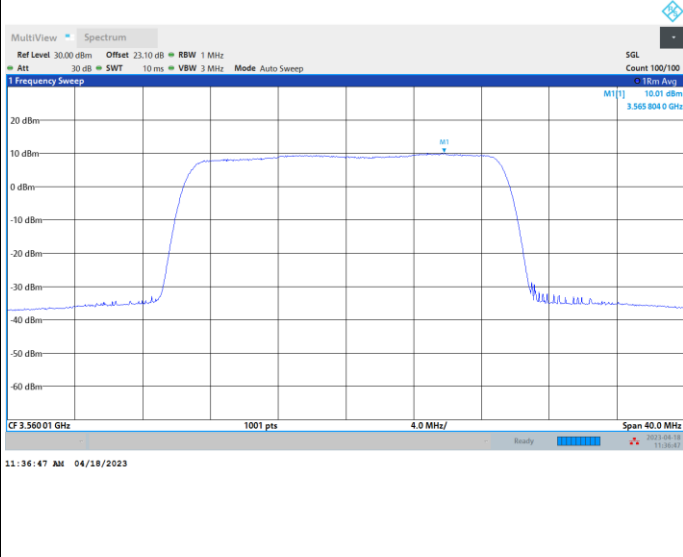

N/A

64QAM

256QAM

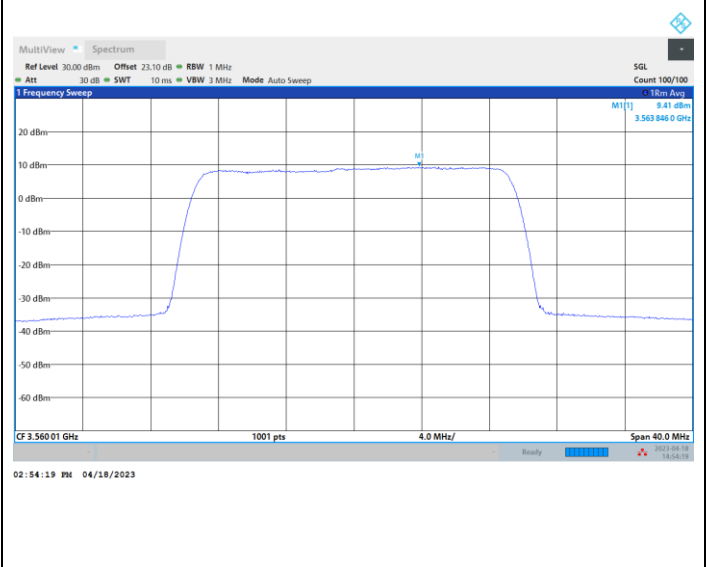
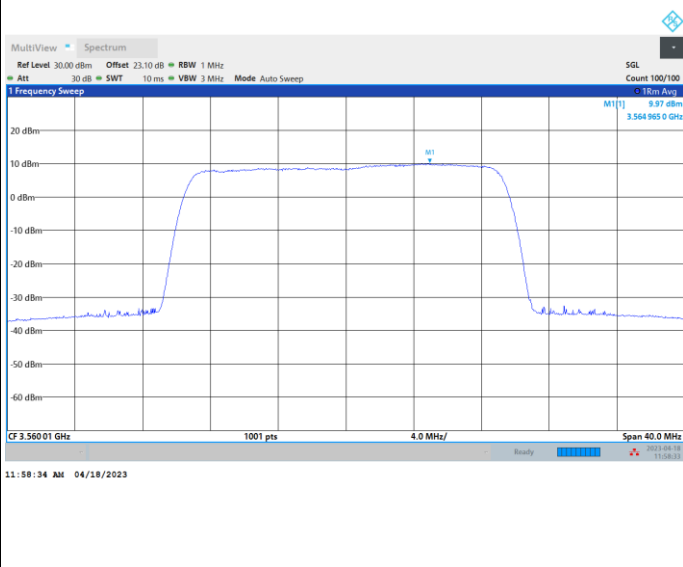



FR1 n48 / 20MHz / Middle Channel / PSD

QPSK

16QAM

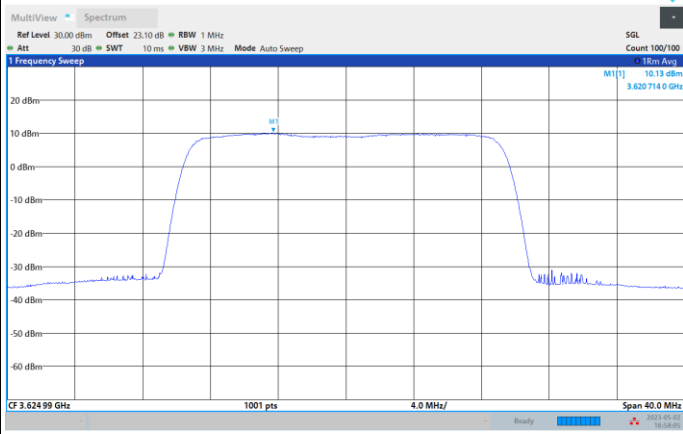

N/A

64QAM

256QAM

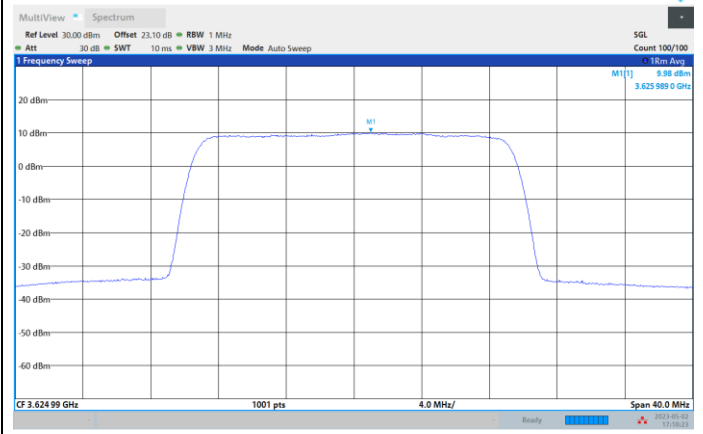
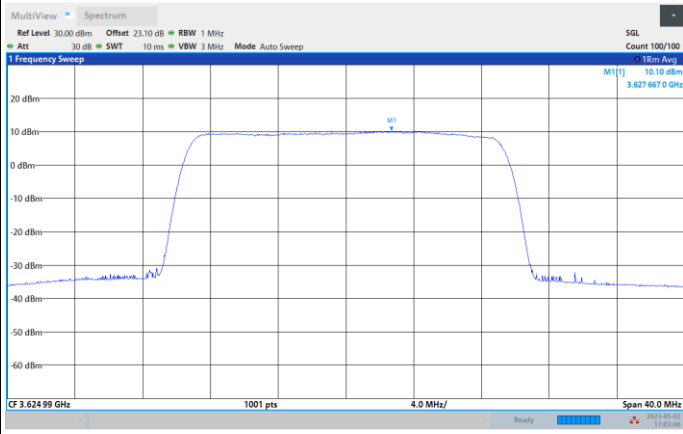



FR1 n48 / 20MHz / Highest Channel / PSD

QPSK

16QAM

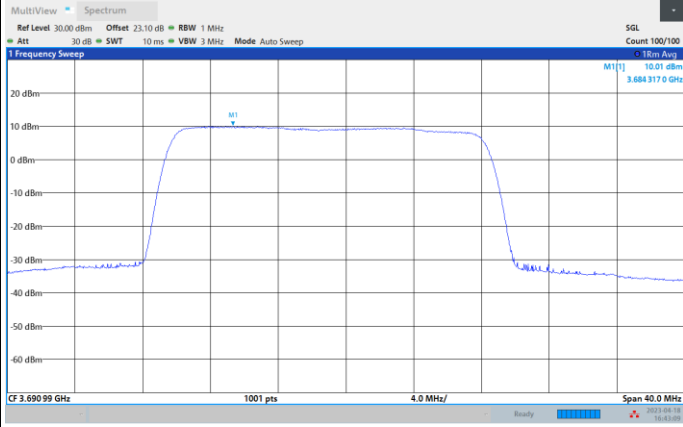

N/A

64QAM

256QAM

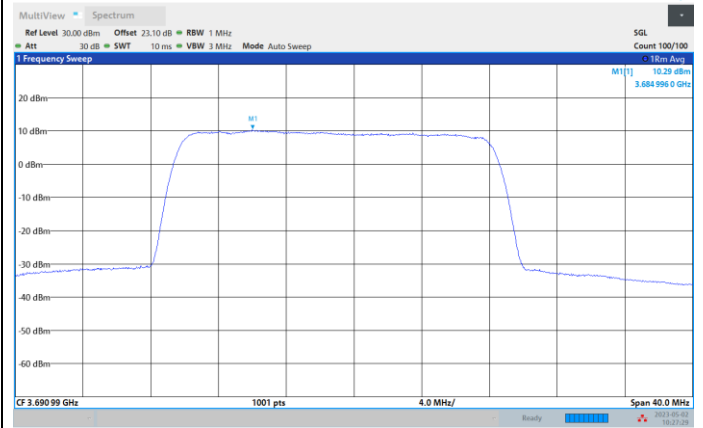
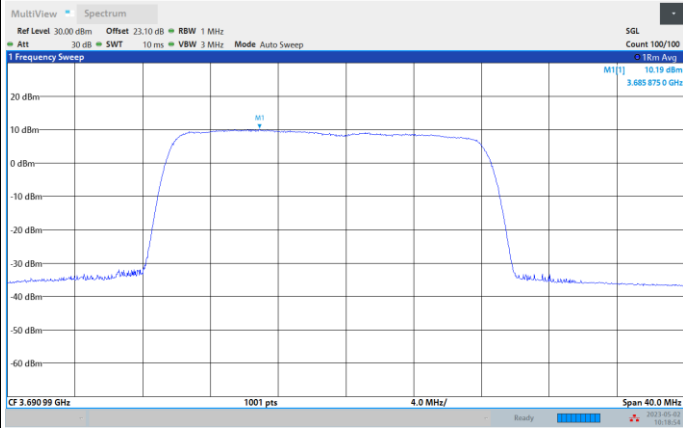



FR1 n48 / 40MHz / Lowest Channel / PSD

QPSK

16QAM

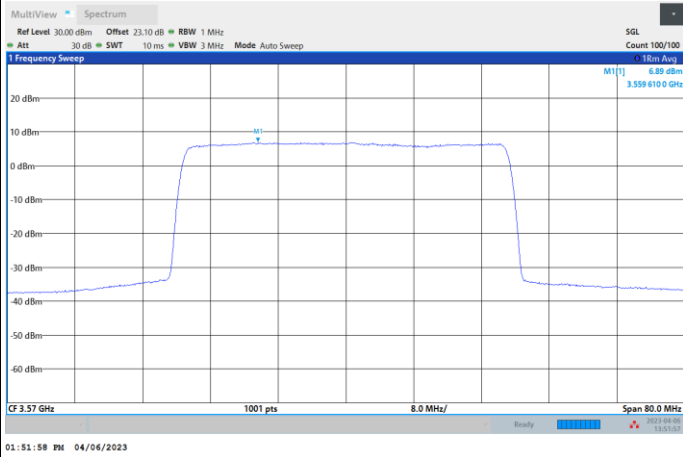

N/A

64QAM

256QAM

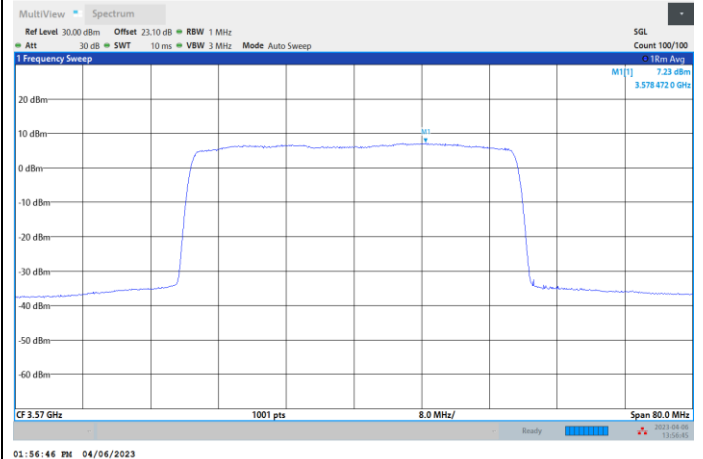
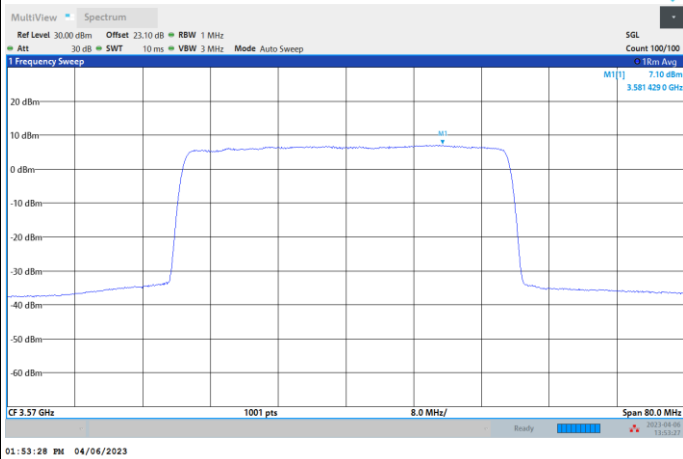



FR1 n48 / 40MHz / Middle Channel / PSD

QPSK

16QAM

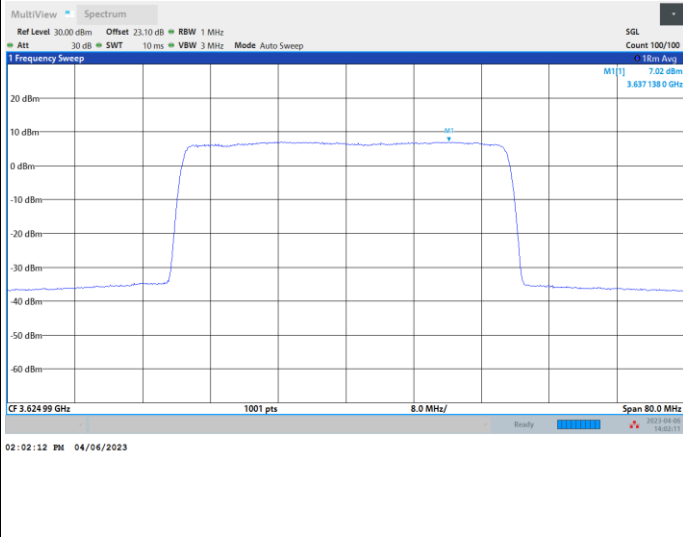

N/A

64QAM

256QAM

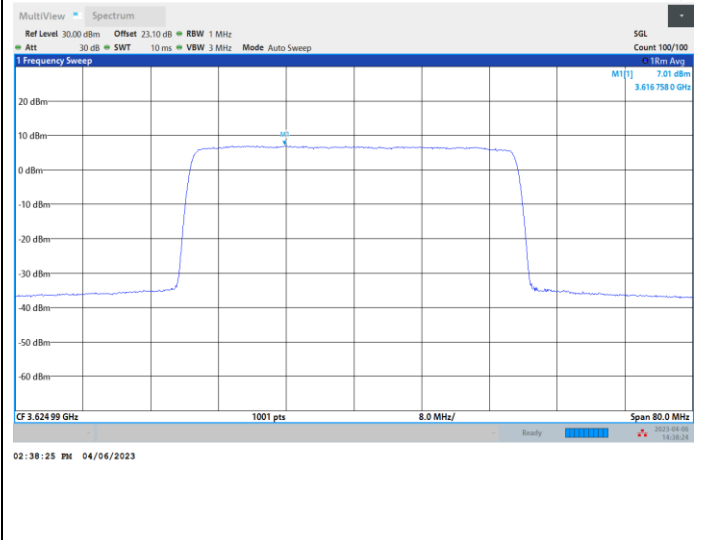
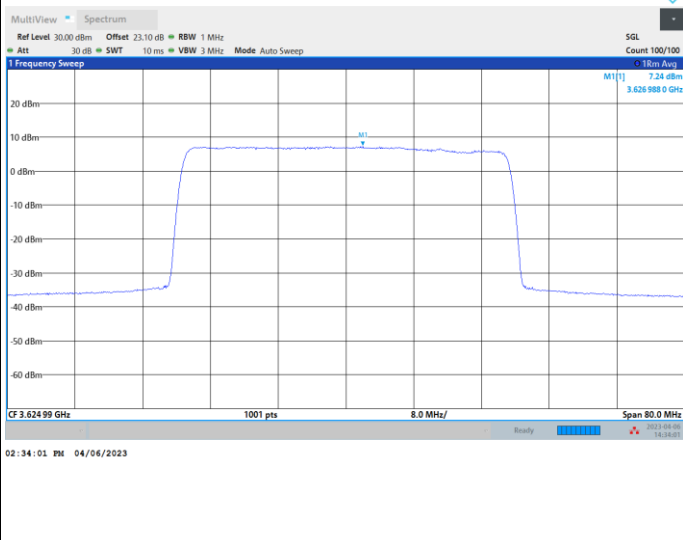



FR1 n48 / 40MHz / Highest Channel / PSD

QPSK

16QAM

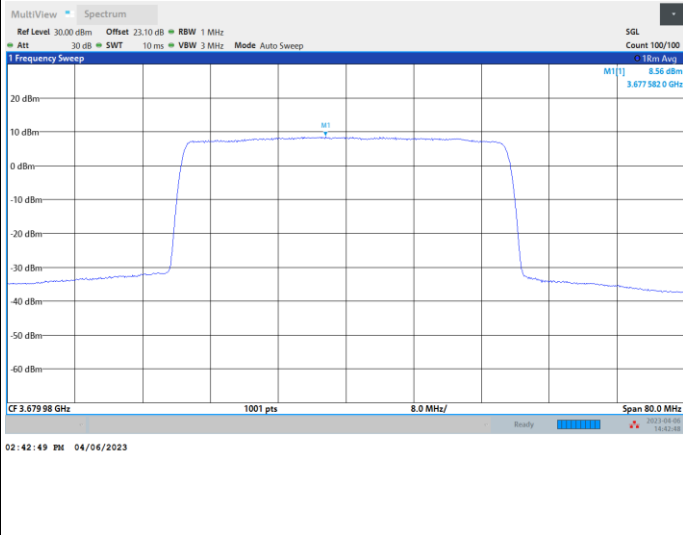

N/A

64QAM

256QAM

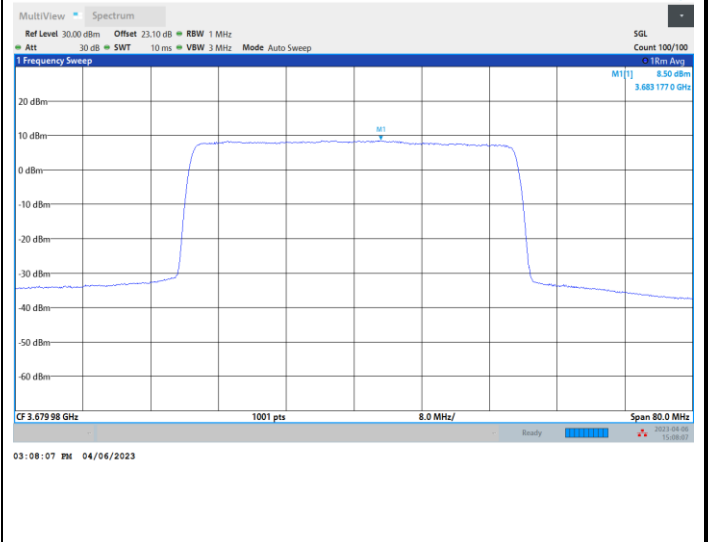
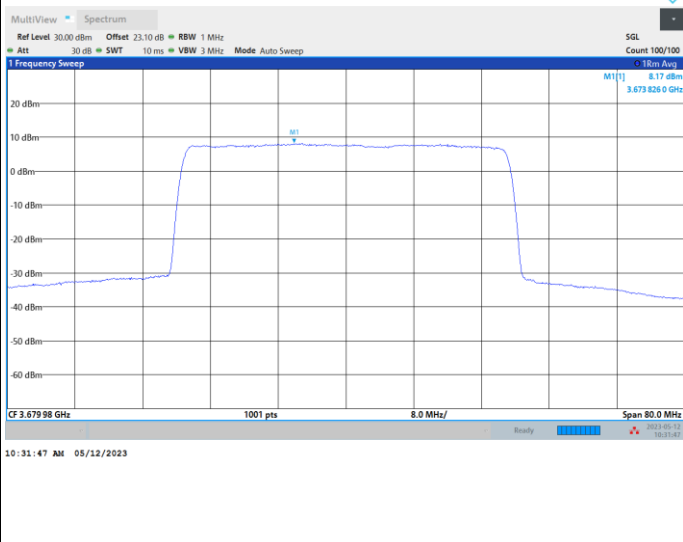



Peak-to-Average Ratio

Mode	FR1 n48 / 20MHz / PAR (dB)				Limit: 13dB
Mod.	QPSK	16QAM	64QAM	256QAM	Result
Middle CH	8.72	-	8.56	8.56	PASS

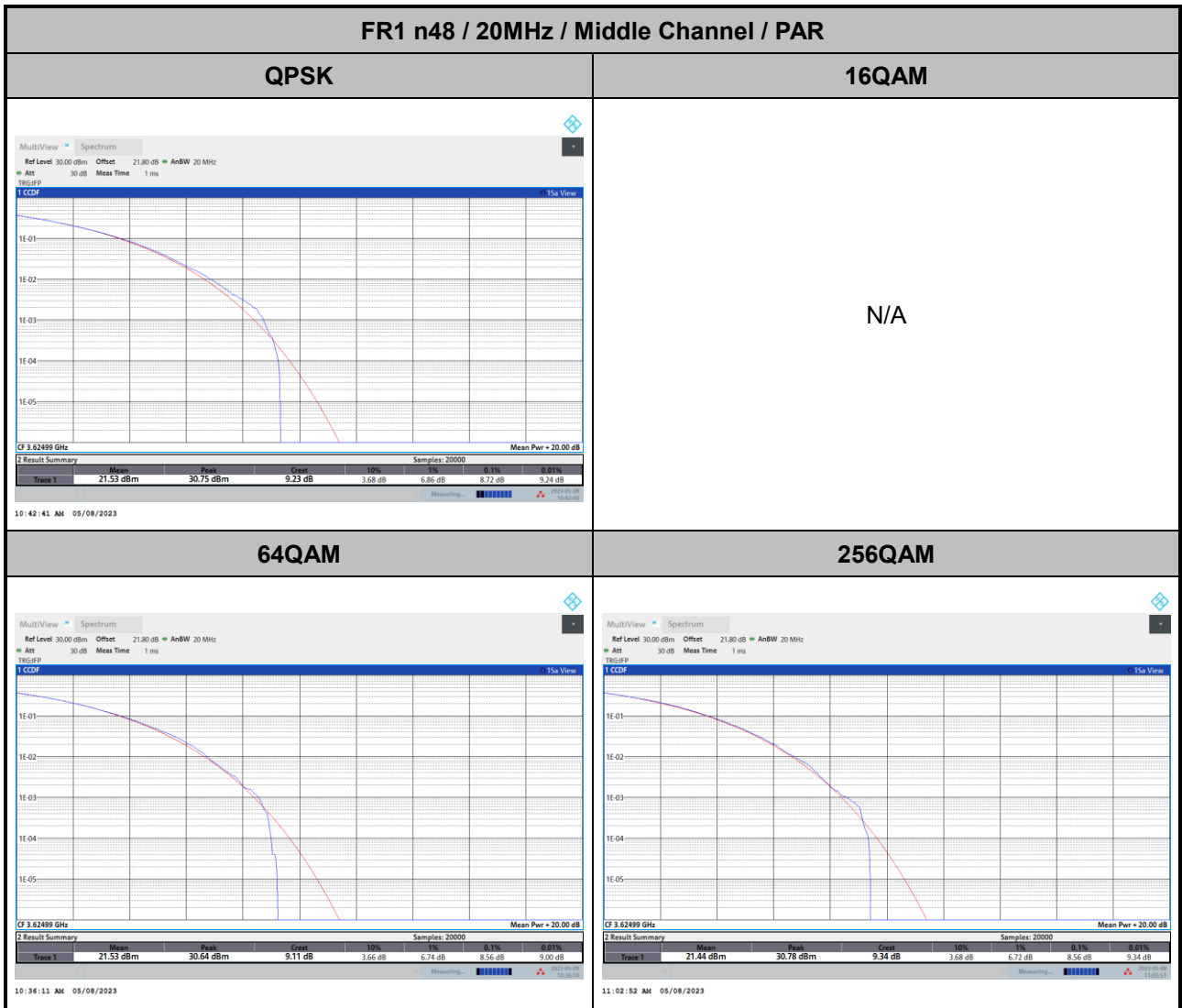



26dB Bandwidth

Mode	FR1 n48 : 26dB BW(MHz)							
BW	10MHz		20MHz		40MHz		50MHz	
Mod.	QPSK	16QAM	QPSK	16QAM	QPSK	16QAM	QPSK	16QAM
Middle CH	-	-	20.14	-	40.84	-	-	-
Mod.	64QAM	256QAM	64QAM	256QAM	64QAM	256QAM	64QAM	256QAM
Middle CH	-	-	19.86	19.70	41.08	42.04	-	-



FR1 n48 / 20MHz / Middle Channel / 26dB BW

QPSK

16QAM

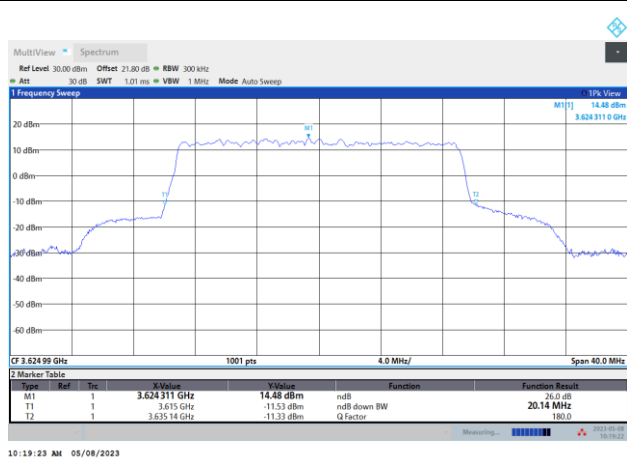

N/A

64QAM

256QAM

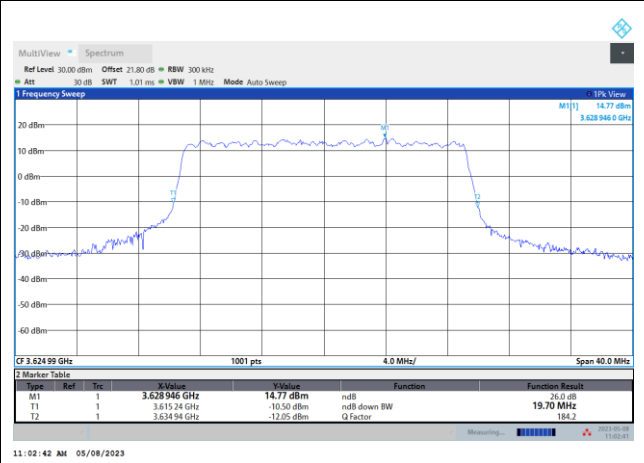
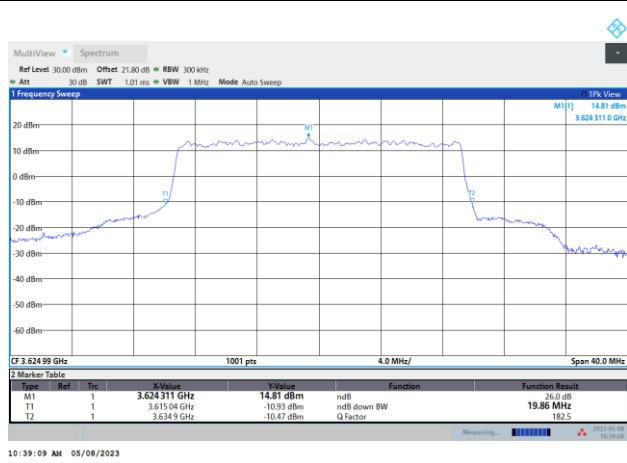



FR1 n48 / 40MHz / Middle Channel / 26dB BW

QPSK

16QAM

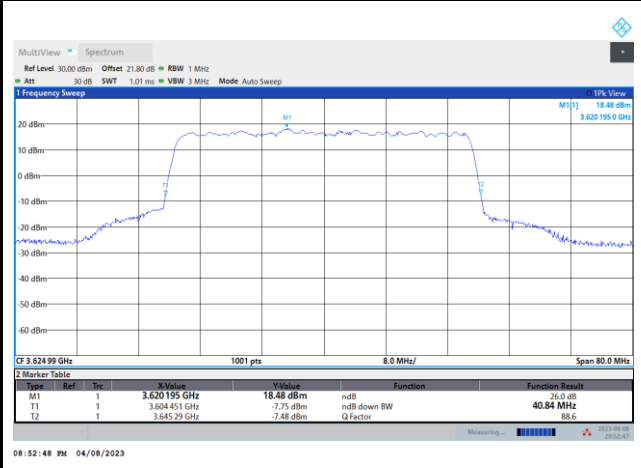

N/A

64QAM

256QAM

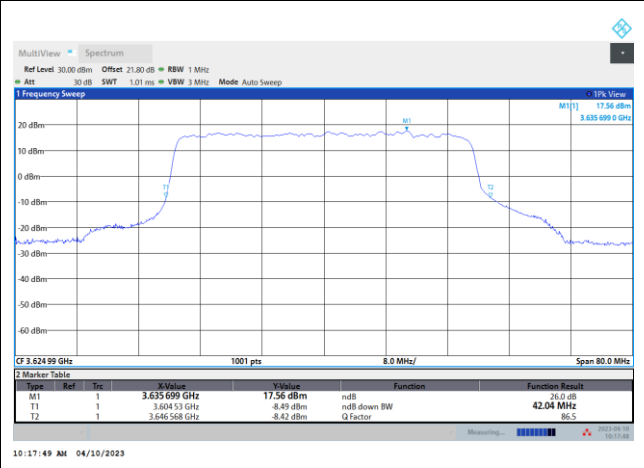
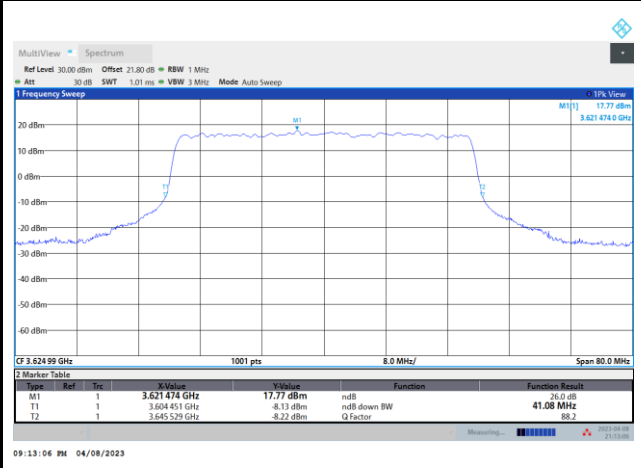



Occupied Bandwidth

Mode	FR1 n48 : 99%OBW (MHz)							
BW	10MHz		20MHz		40MHz		50MHz	
Mod.	QPSK	16QAM	QPSK	16QAM	QPSK	16QAM	QPSK	16QAM
Middle CH	-	-	18.23	-	37.96	-	-	-
Mod.	64QAM	256QAM	64QAM	256QAM	64QAM	256QAM	64QAM	256QAM
Middle CH	-	-	18.27	18.18	38.04	37.98	-	-



FR1 n48 / 20MHz / Middle Channel / 99%OBW

QPSK

16QAM

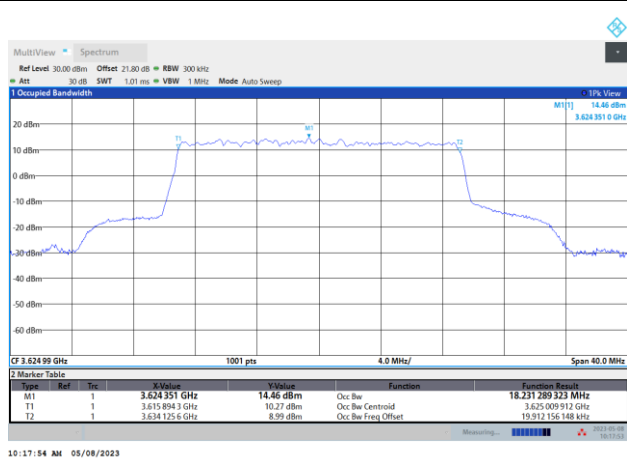

N/A

64QAM

256QAM

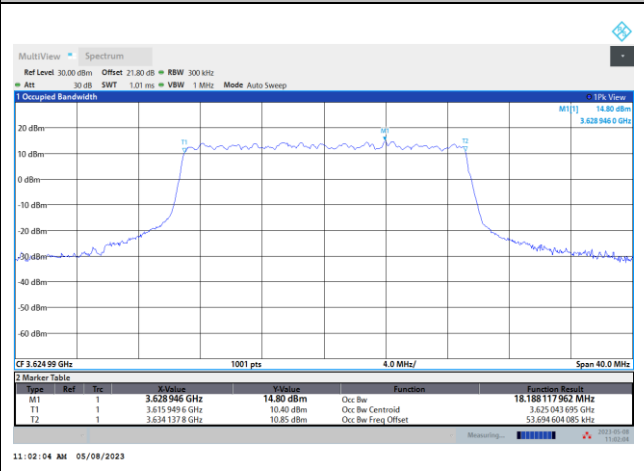
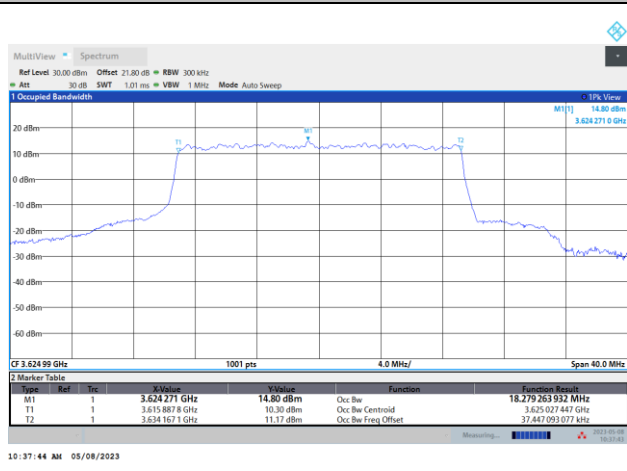



FR1 n48 / 40MHz / Middle Channel / 99%OBW

QPSK

16QAM

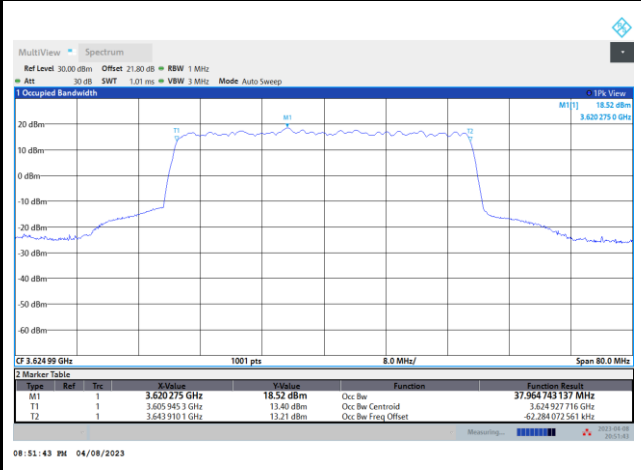

N/A

64QAM

256QAM

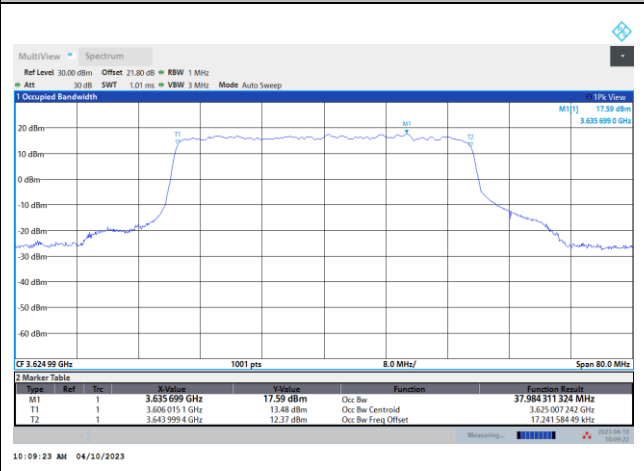
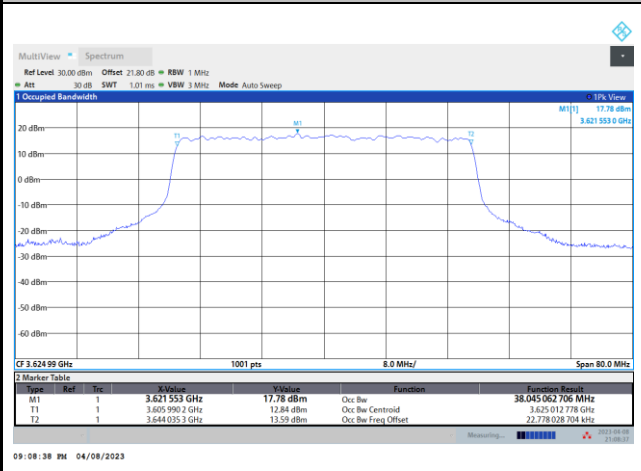



Unwanted Emission (MASK)

FR1 n48 / 20MHz / Lowest Channel / MASK

QPSK

16QAM

N/A

64QAM

256QAM

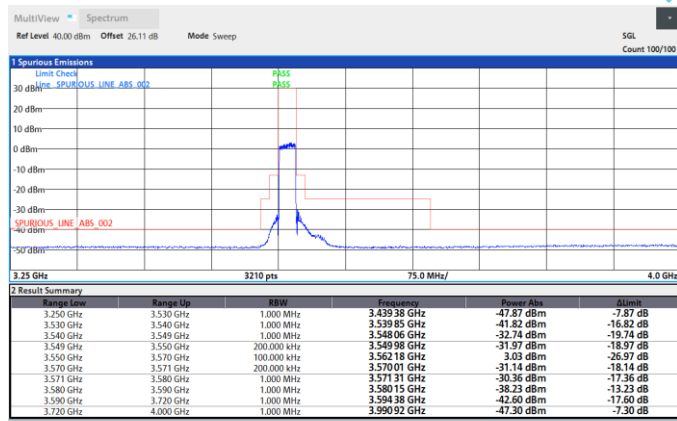

09:52:56 AM 05/08/2023



09:59:54 AM 05/08/2023

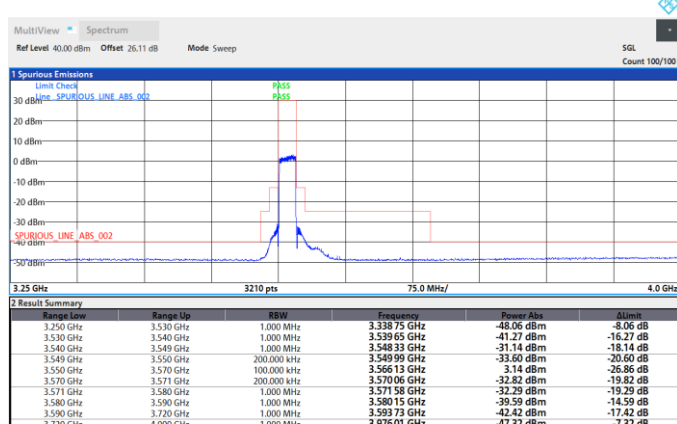

09:56:49 AM 05/08/2023

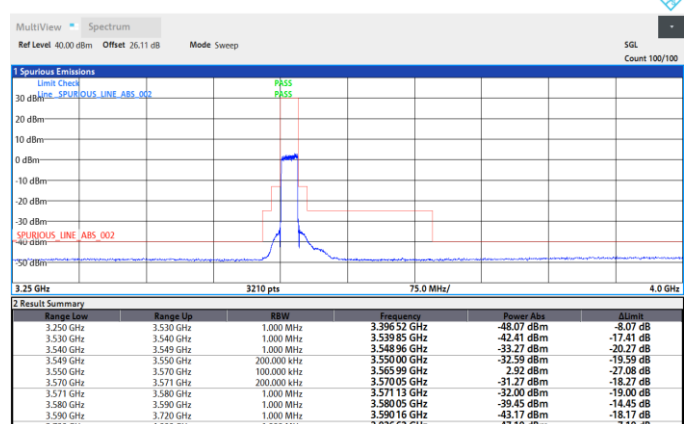

09:59:54 AM 05/08/2023



FR1 n48 / 20MHz / Middle Channel / MASK

QPSK

16QAM

N/A

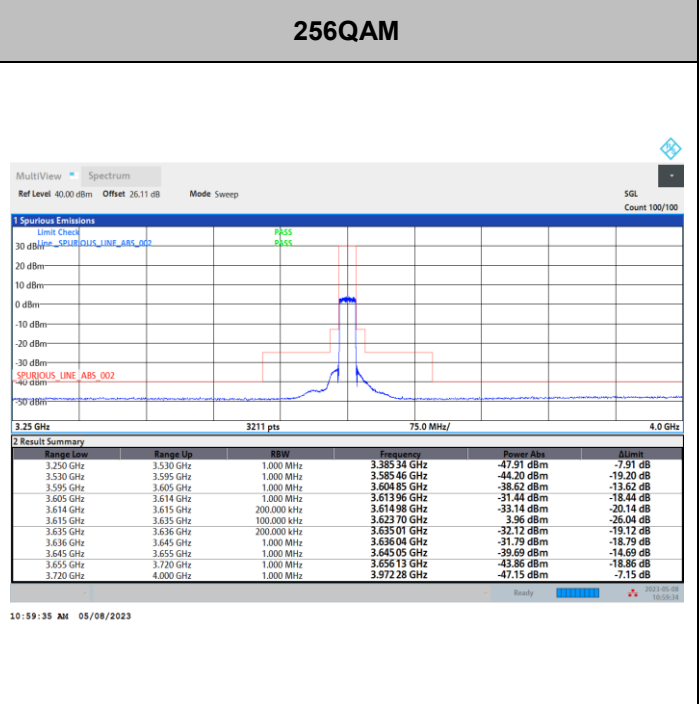
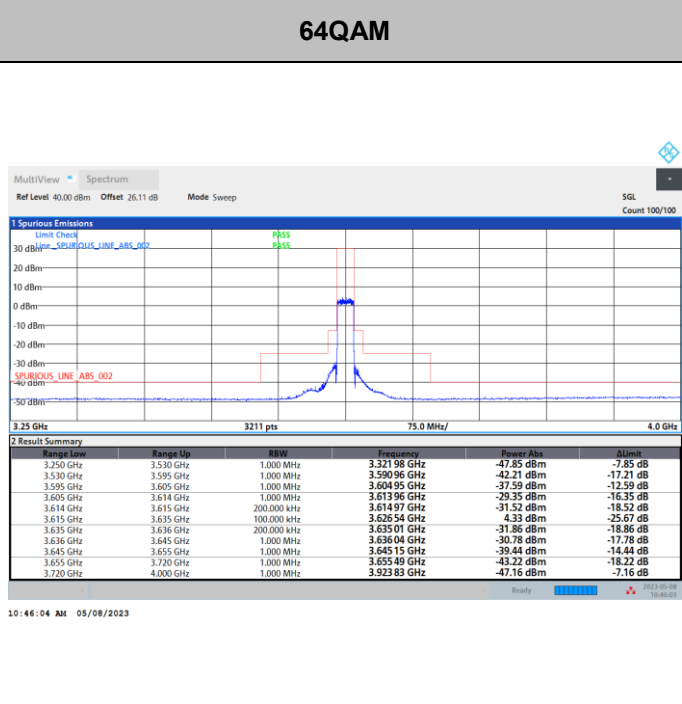
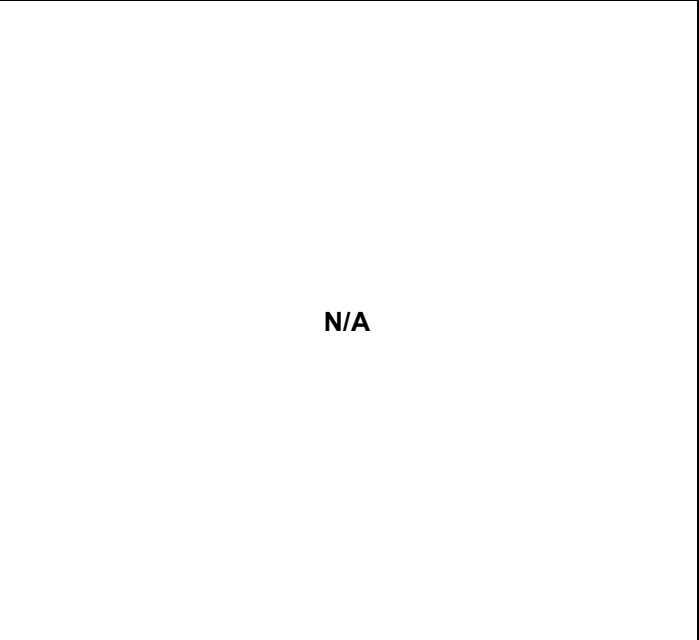
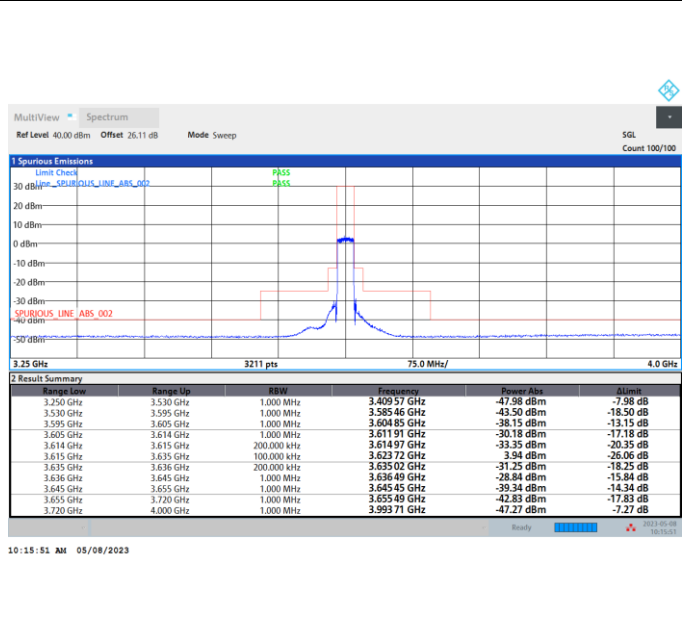



FR1 n48 / 20MHz / Highest Channel / MASK

QPSK

16QAM

N/A

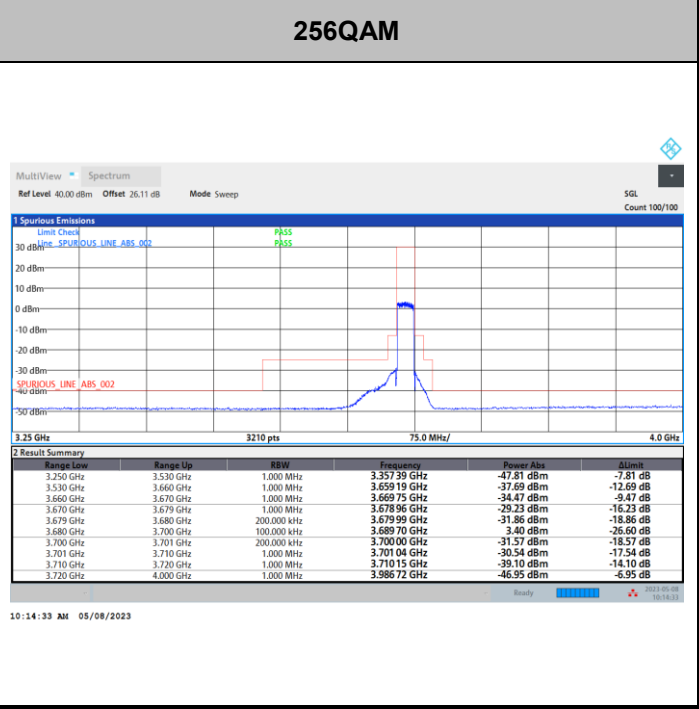
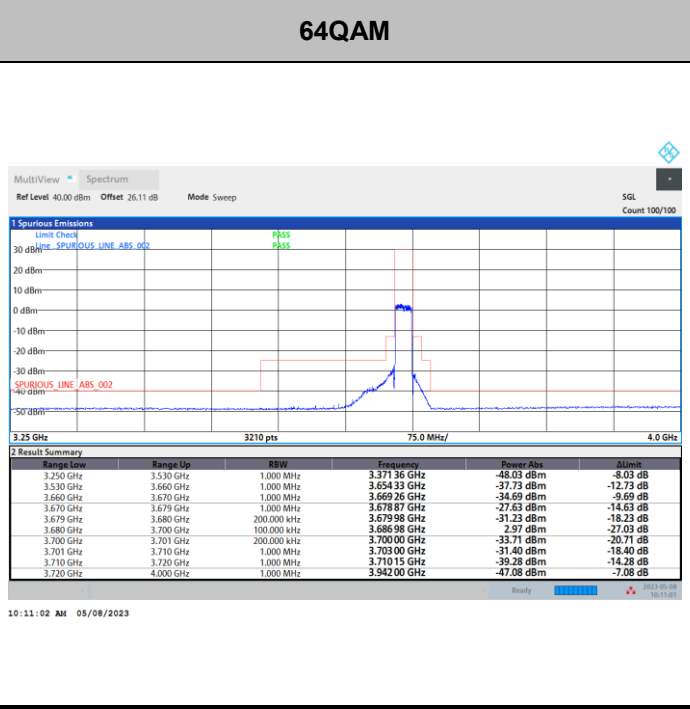
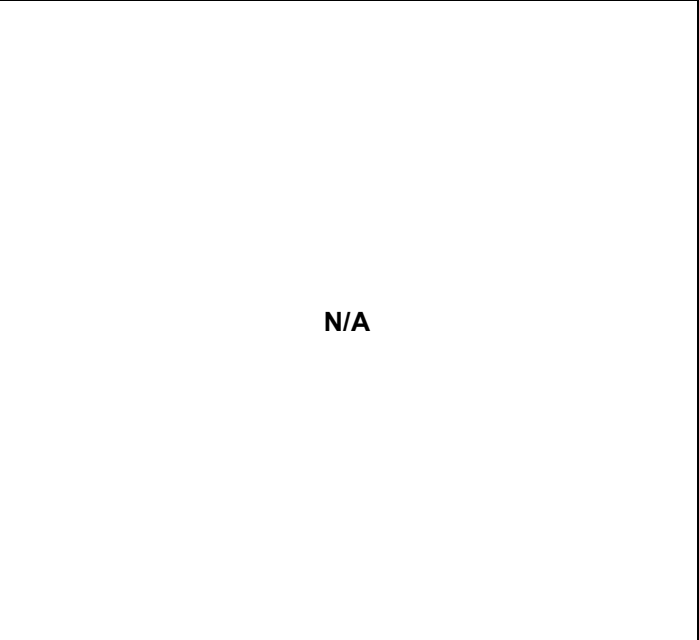
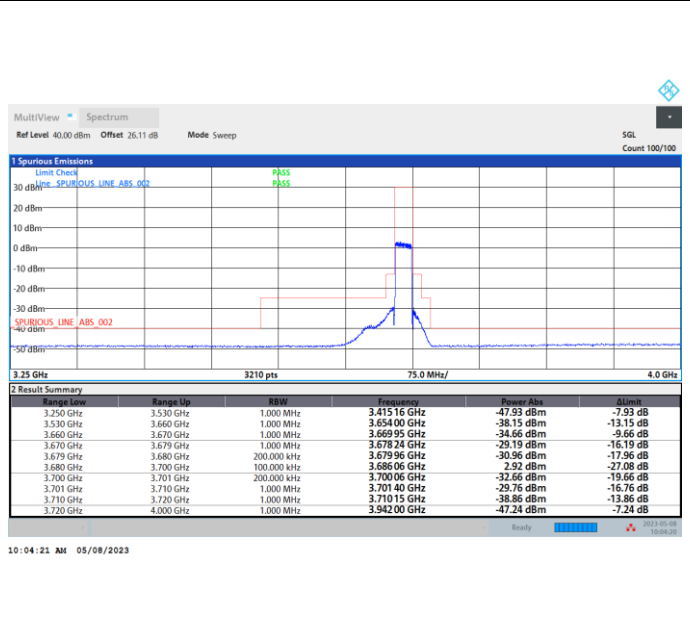



FR1 n48 / 40MHz / Lowest Channel / MASK

QPSK

16QAM

N/A

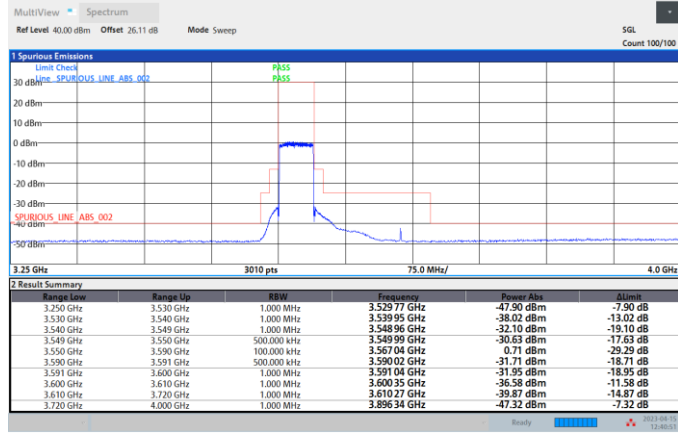

12:40:52 PM 04/15/2023

64QAM

256QAM

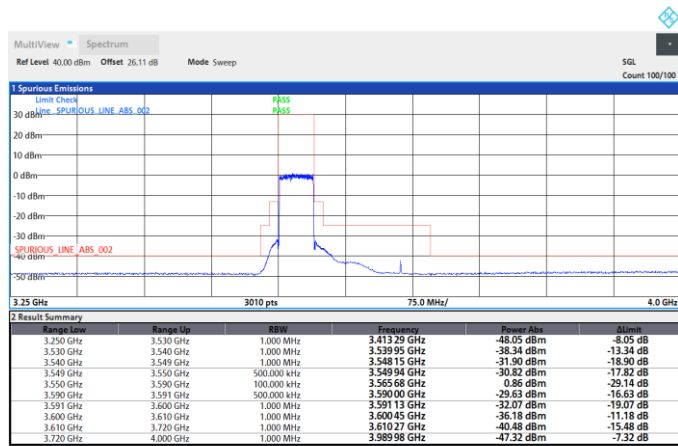

12:42:16 PM 04/15/2023

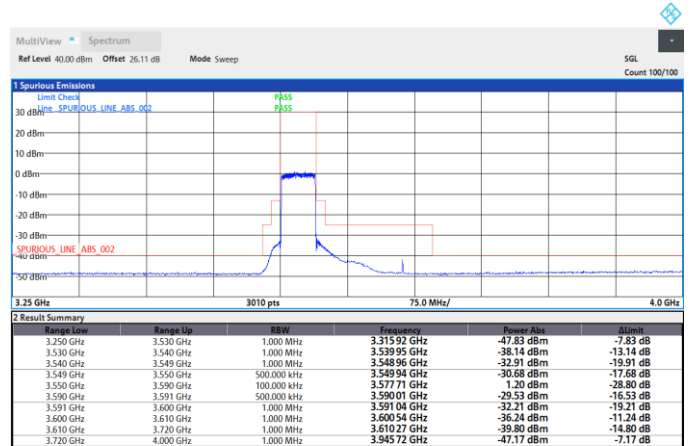

12:42:55 PM 04/15/2023



FR1 n48 / 40MHz / Middle Channel / MASK

QPSK

16QAM

N/A

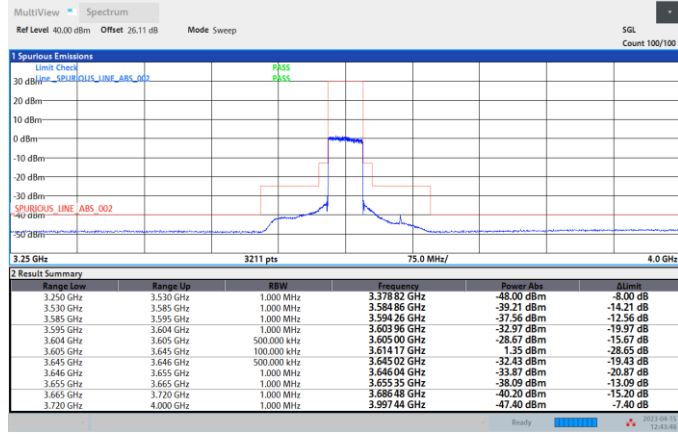

12:43:47 PM 04/15/2023

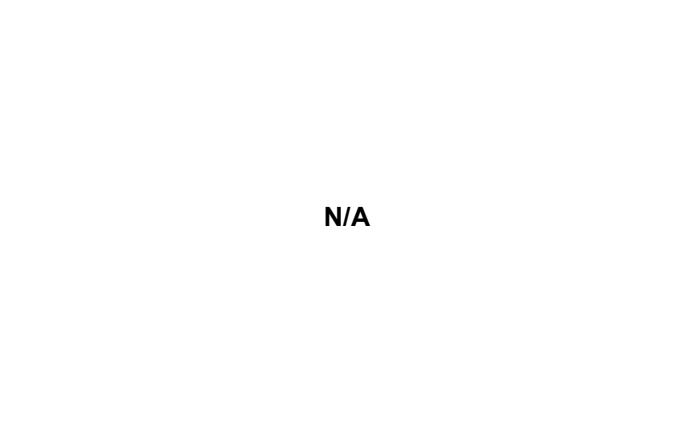

12:45:43 PM 04/15/2023

64QAM

256QAM

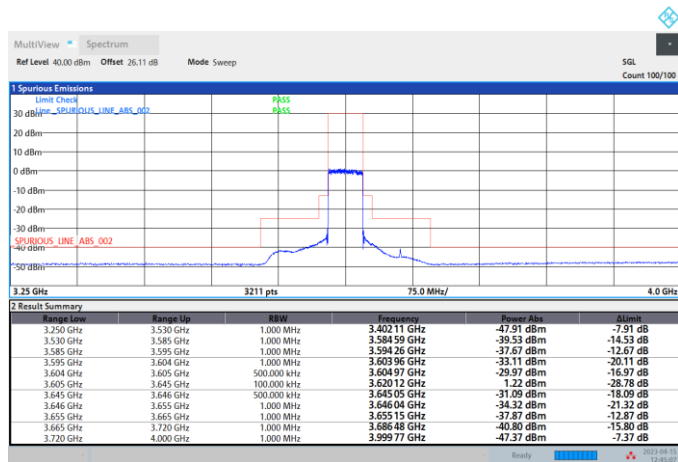

12:45:08 PM 04/15/2023

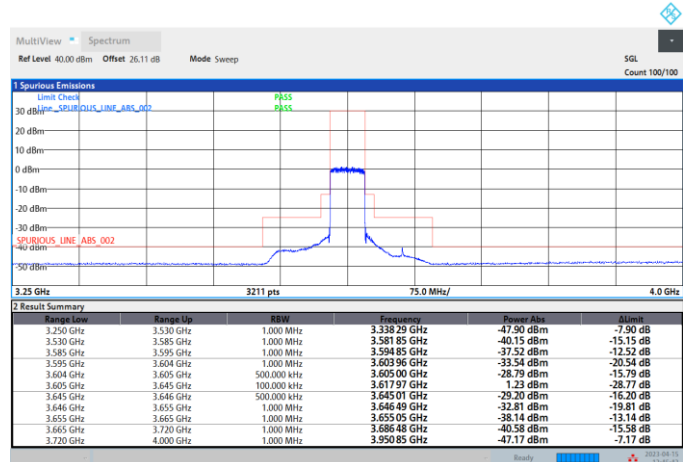

12:45:43 PM 04/15/2023



FR1 n48 / 40MHz / Highest Channel / MASK

QPSK

16QAM

N/A

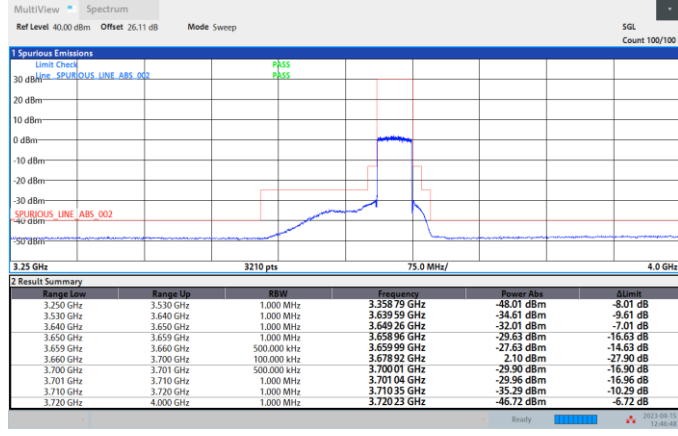

12:46:49 PM 04/15/2023

64QAM

256QAM

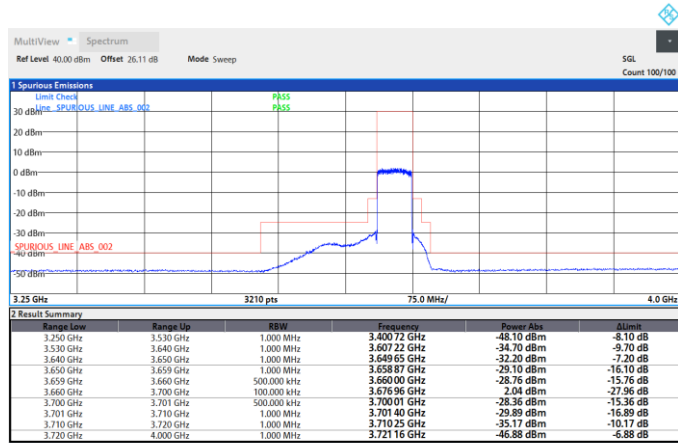

12:47:29 PM 04/15/2023

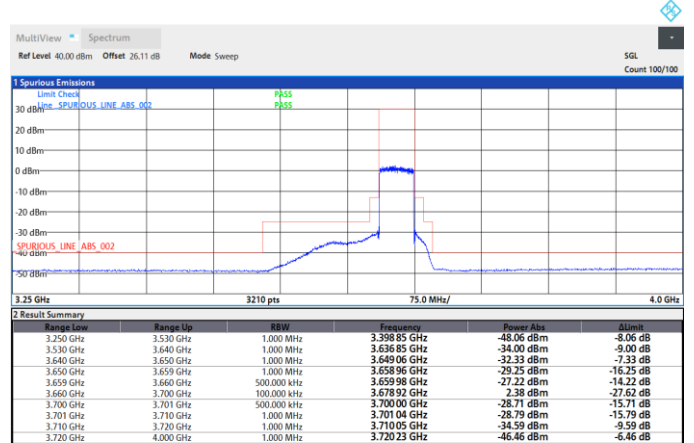

12:48:18 PM 04/15/2023



Conducted Spurious Emission

FR1 n48 / 20MHz / QPSK / CSE

Lowest Channel

Middle Channel

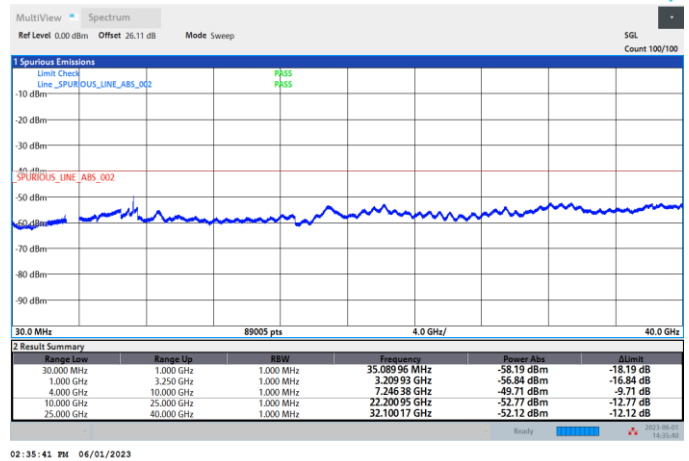
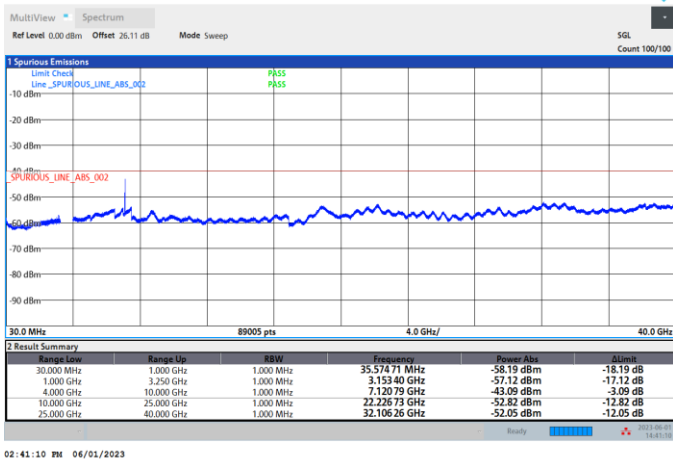

Highest Channel

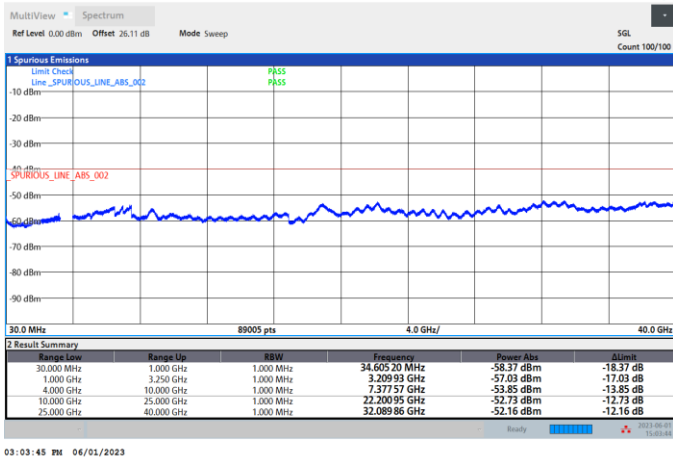



FR1 n48 / 20MHz / 64QAM / CSE

Lowest Channel

Middle Channel

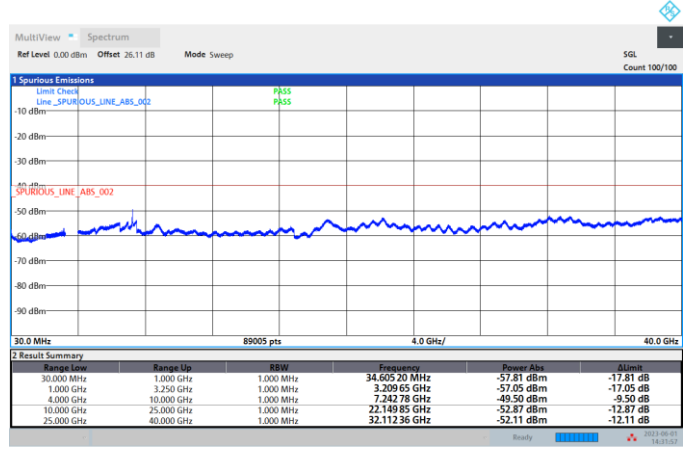
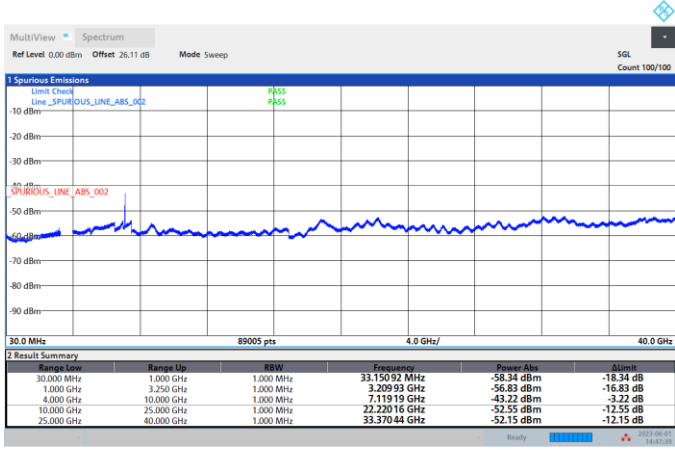

Highest Channel

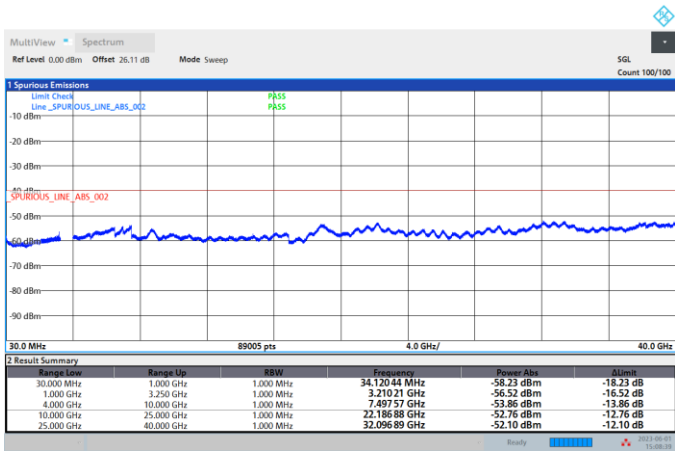



FR1 n48 / 20MHz / 256QAM / CSE

Lowest Channel

Middle Channel

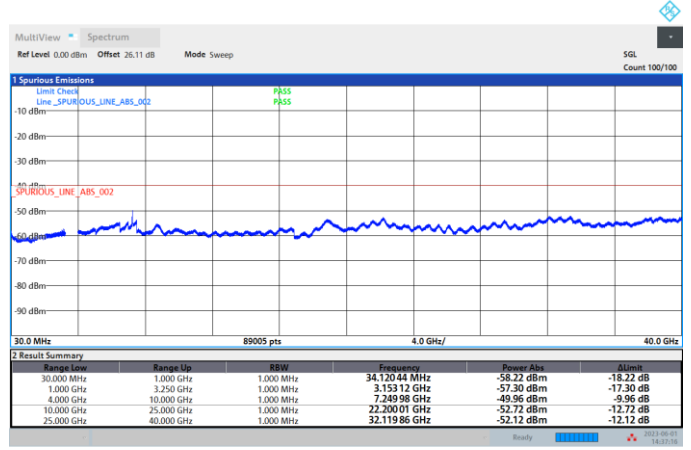
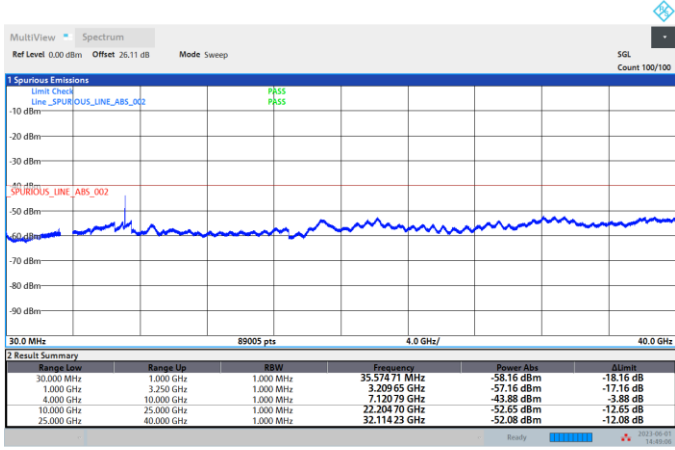

Highest Channel

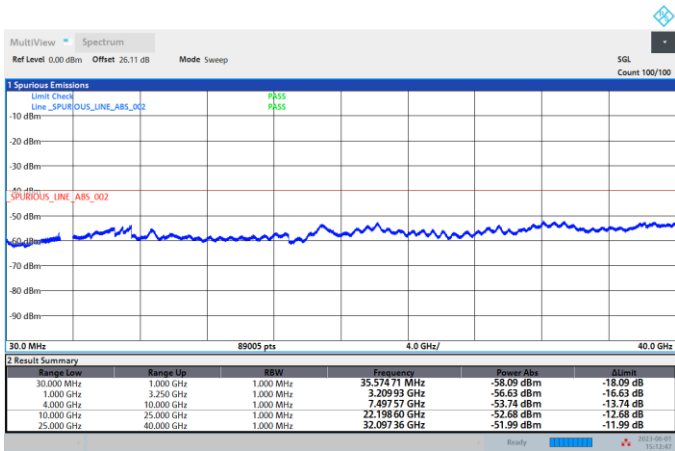



FR1 n48 / 40MHz / QPSK / CSE

Lowest Channel

Middle Channel

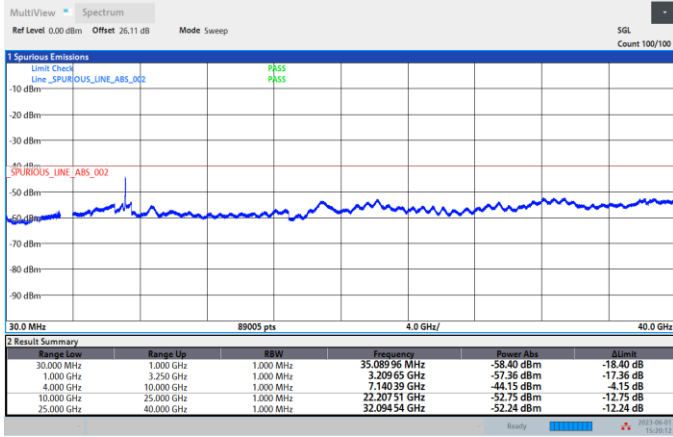

03:20:13 PM 06/01/2023

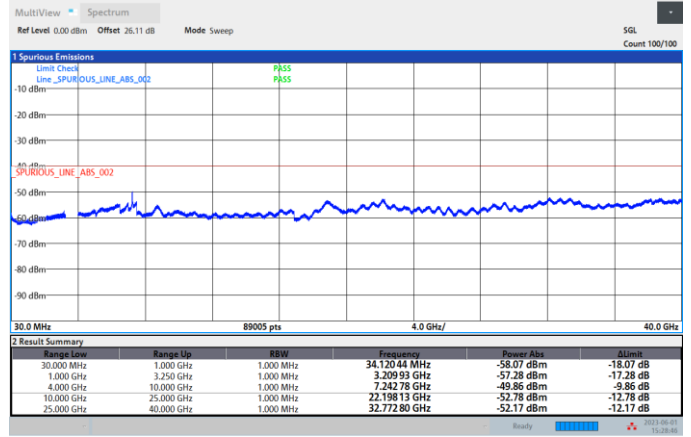

03:28:46 PM 06/01/2023

Highest Channel

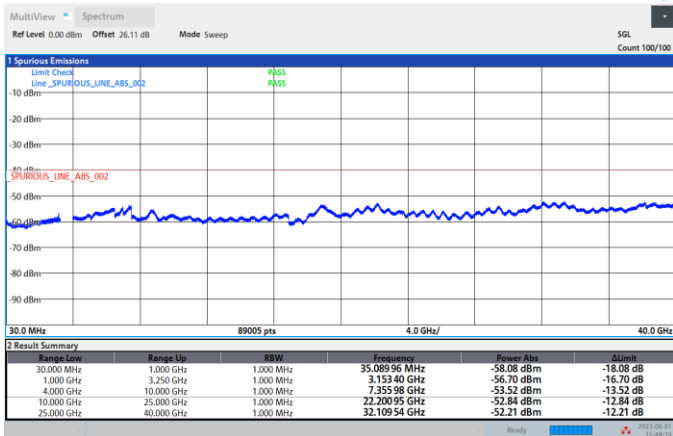

03:48:20 PM 06/01/2023



FR1 n48 / 40MHz / 64QAM / CSE

Lowest Channel

Middle Channel

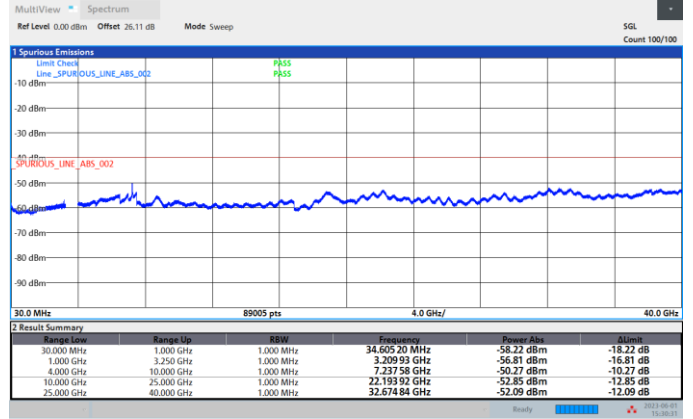
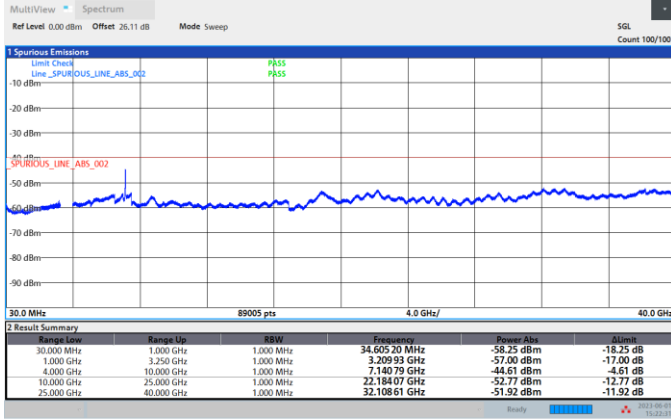

Highest Channel

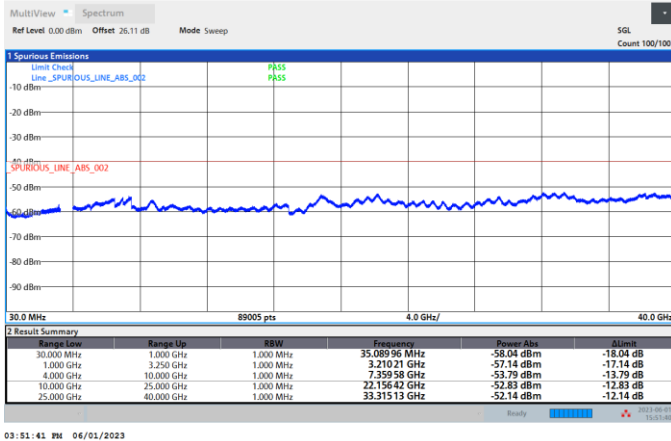



FR1 n48 / 40MHz / 256QAM / CSE

Lowest Channel

Middle Channel

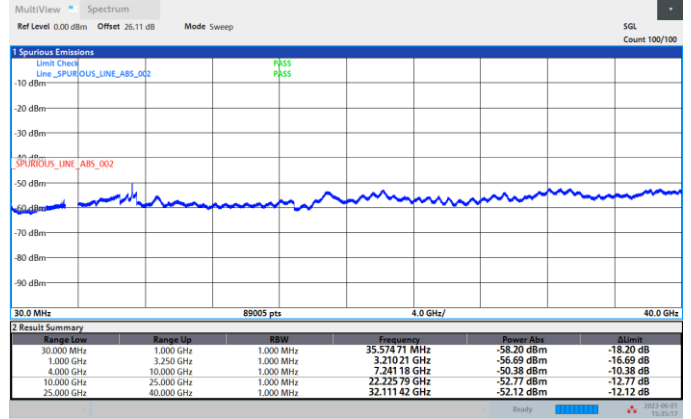
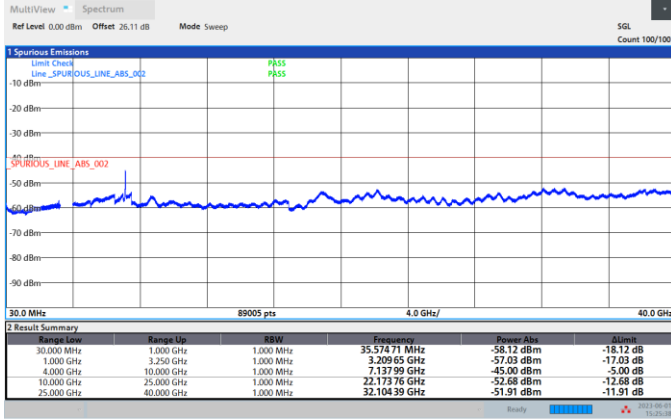

Highest Channel

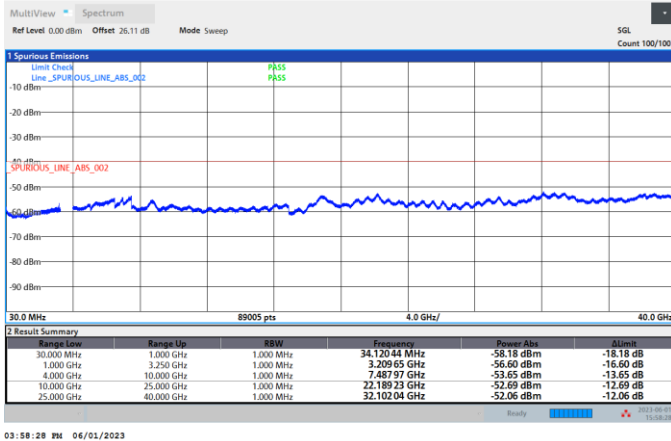



Frequency Stability

Test Conditions		FR1 n48 (QPSK) / Middle Channel	Limit
Temperature (°C)	Voltage (Volt)	BW 20MHz	Note 2.
		Frequency offset (ppm)	Result
50	Normal Voltage	1.1586	PASS
40	Normal Voltage	0.5517	
30	Normal Voltage	0.4966	
20(Ref.)	Normal Voltage	0.0000	
10	Normal Voltage	0.8276	
0	Normal Voltage	0.2207	
-10	Normal Voltage	2.3724	
-20	Normal Voltage	1.9310	
-30	Normal Voltage	2.4276	
20	Maximum Voltage	1.5448	
20	Normal Voltage	1.1586	
20	Minimum Voltage	0.6621	

Note:

1. Normal Voltage = 48 V. ; Minimum Voltage = 43.2 V. ; Maximum Voltage = 57 V.
2. The frequency fundamental emissions stay within the authorized frequency block.