

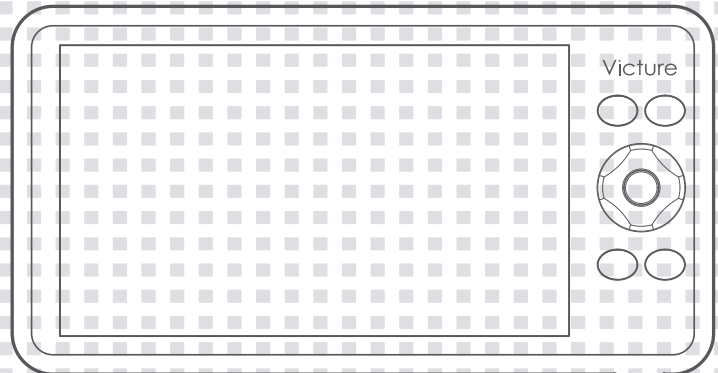

Victure

User Manual

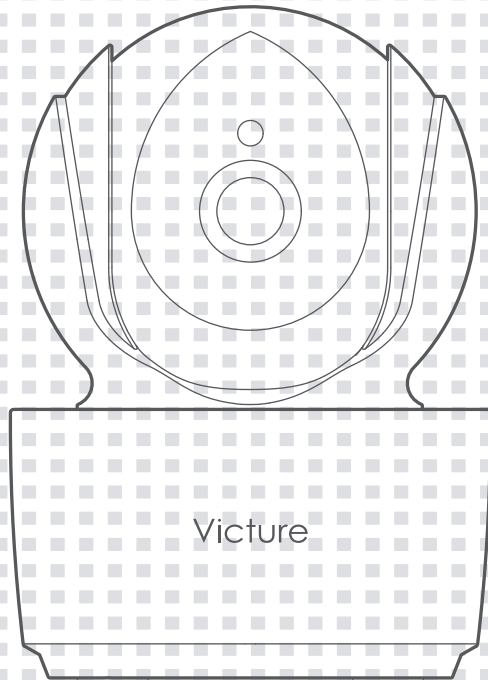

BM50

Video Baby Monitor

Menu

English	1 - 14
Deutsch	15 - 28
Français	29 - 42
Italiano	43 - 56
Español	57 - 70
日本語	71 - 84

Contents

1. Attention/Package Content	2
2. Overview of Your Baby Monitor	3
3. Setting up Your Baby Monitor	5
- Baby Unit Power Supply	
- Parent Unit Power Supply	
4. Monitoring Screen Icons	6
5. Menu Function (Parent Unit)	9
6. System Setting	10
7. Technical Features	11
8. Troubleshooting	12
9. Warranty	14

EN

⚠ Attention

EN

Thank you for purchasing Victure Video Baby Monitor BM50. Now you can see and hear your baby sleeping in the other room or you can monitor your elder kids in their playroom. Before you use the device, please read this User Manual carefully.

- This product should be assembled by adults.
- Keep small parts away from children when assembling.
- This product is not a toy, do not allow children to play with it as a toy.
- This baby monitor is not a substitute for responsible adult supervision
- Do not place the baby monitor cables in the cot or with the baby arm's reach (at least 1 meter away)
- Keep the cords out of reach of children.
- Do not use the baby monitor near water or a heat source.
- Only use the power adapters provided.
- Do not touch the power plug with sharp or metal objects.

Package Content



1x Parent Unit

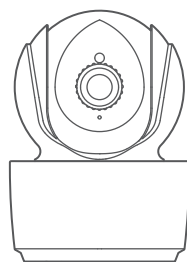

1x Baby Unit

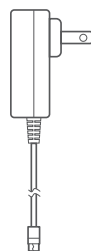

2x Power Adapter

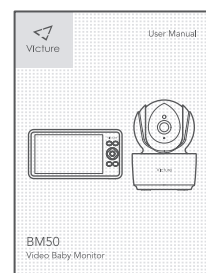

1x User Manual

Overview of Your Baby Monitor

EN

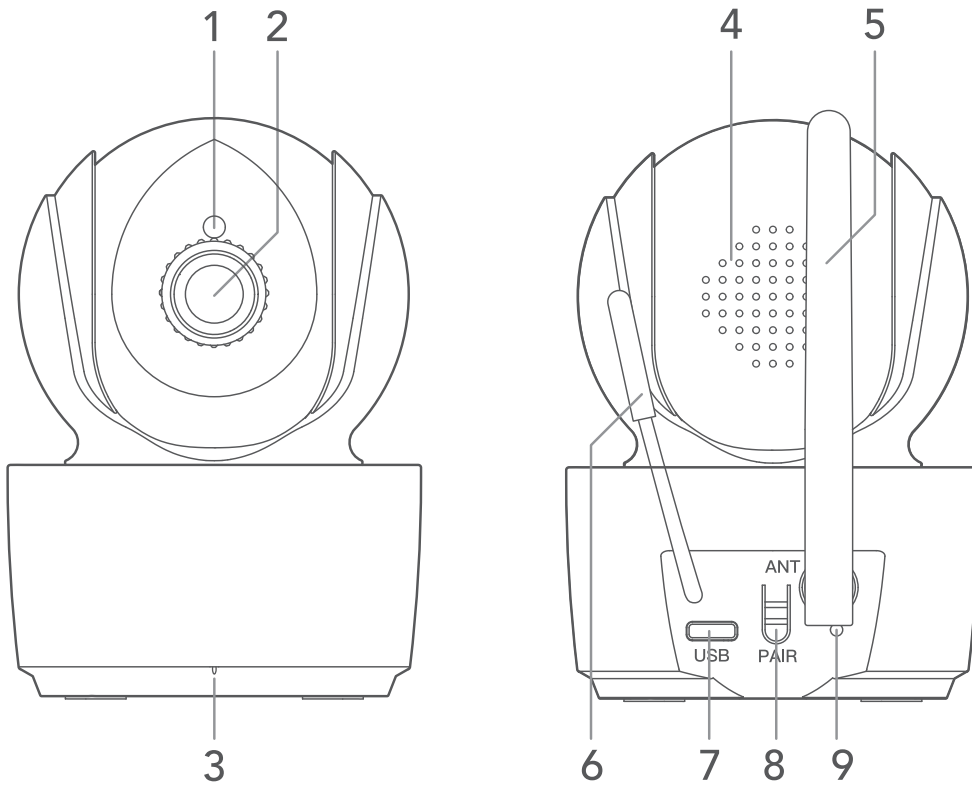

Controls(Baby Unit)

1. Light sensor
2. Lens
3. Microphone
4. Speaker
5. Network Antenna
6. Temperature sensor
7. Power Interface
8. Pair Button
9. Power Indicator

Receiver (Parent Unit)

- 1. TFT Screen
- 2. Volume/ Brightness Adjust
- 3. Power Button
- 4. Menu Setting
- 5. Navigation Key
- 6. OK/Zoom Button
- 7. Talk Button
- 8. Split Screen Button
- 9. Network Antenna
- 10. Charging Interface
- 11. Charging Indicator
- 12. Microphone
- 13. Bracket
- 14. Speaker

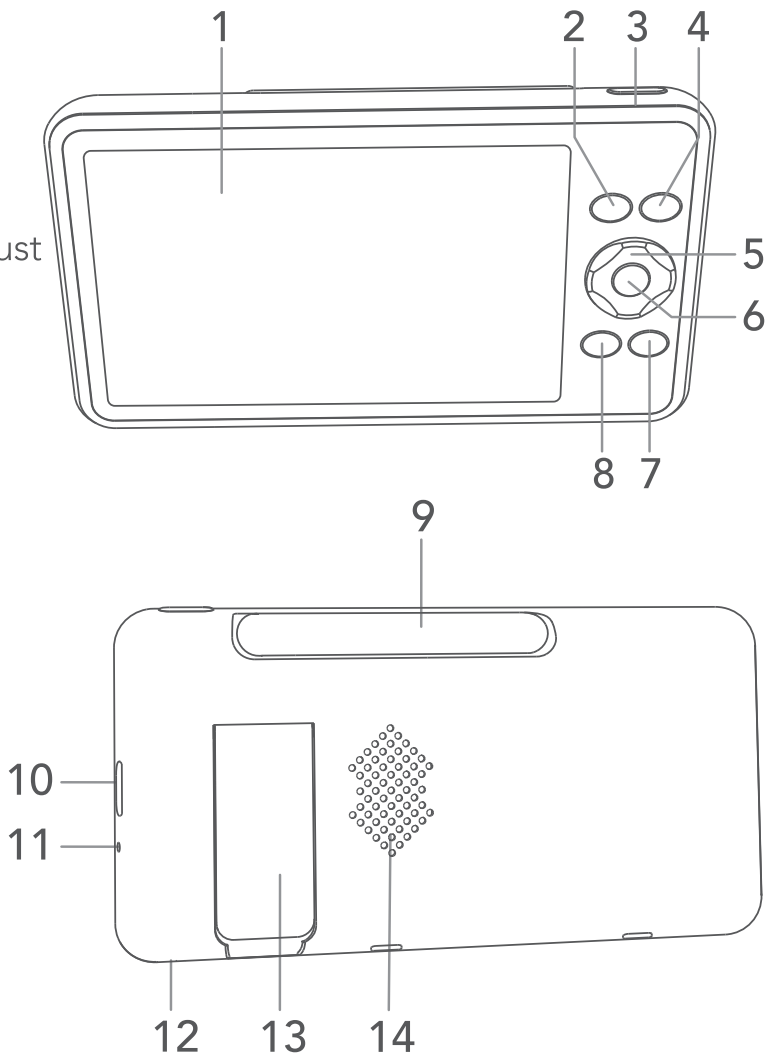

Setting up Your Baby Monitor

Baby Unit power Supply

- Connecting the power adapter for the baby unit.
- Connect the small plug of the adapter to the Baby Unit and the other end to the power socket
- Only use the enclosed adapter (USB Type-C 5V/1A)

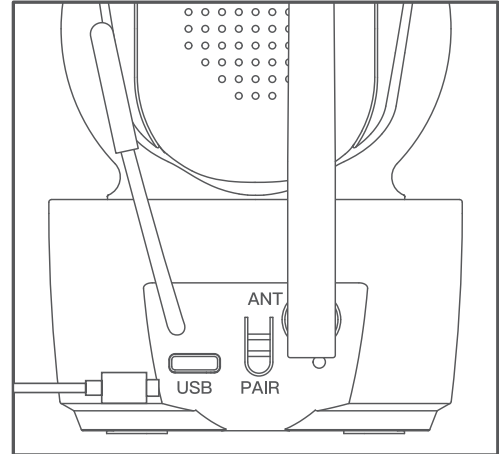

EN

WARNING

Strangulation Hazard: Children will STRANGLERED in cords. Keep this cord out of the reach of children(more than 1 meter away)

Baby Unit power Supply

- Connecting the power adapter for the Parent Unit if it in low battery status.
- Connect the small plug of the adapter to the Parent Unit and the other end to the power socket
- Only use the enclosed adapter (USB Type-C 5V/2A)
- Press and hold the Power Button on the Parent Unit to turn it ON.

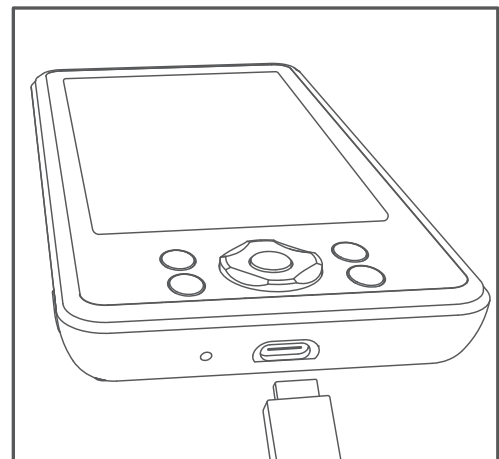









Main Screen Icons (Parent Unit)

EN



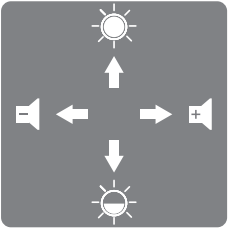





Icons	Descriptions
	Camera and monitor connection signal strength
	Monitor sound level
	Lullaby is on
	The VOX function is turned on, the white icon is displayed when it is turned on, and a beep will sound when triggered Sound prompt, after red and white alternate switching flashing for 10 seconds, it will turn back to white"
	Infrared Night Vision is on

Icons	Descriptions
	<p>The Motion Detect function is turned on, and the white icon is displayed when it is triggered. "Didi" sound prompt, display a red icon, and then change back to white after 10 seconds.</p>
	<p>Screen magnification prompt</p>
	<p>The Temperature function is turned on, if the temperature exceeds the set range, a beep will sound.</p>
	<p>The Feeding Timer function is turned on. After the function is turned on, a "di di" will be emitted in the last 1 minute. The sound prompt also displays a red icon and countdown on the screen</p>
	<p>Battery power</p>
	<p>Long press the Talk button to display</p>
	<p>Under the single large monitoring screen, press the navigation button to go to the camera PTZ Rotate up and down.</p>
	<p>Under the single large monitoring screen, press the Submenu button to use the up and down navigation Navigation key to adjust the brightness, left and right navigation keys to adjust the sound level.</p>

Icons	Descriptions
	<p>After entering Dual mode/Quad mode, a check box will be displayed on the monitoring screen, select Set the frame at the top left of the monitoring screen, which represents the currently selected camera, monitoring The sound that the viewer hears at this time is that of the current camera, press the Menu button to set the menu Single is also to set the parameters of the current camera, press up/down/left/right to change the selected frame Switch between each camera, if you press the OK button, you can directly switch to the current selection Single mode screen of the camera where the frame is located.</p>

Main Menu Function (Parent Unit)

EN

Menu Options	Descriptions
 Music	Choose to play cradle tracks, sound size and close settings
 Vox	Sound detection sensitivity setting
 Temperature	Temperature detection setting
 Feeding Timer	Set the timer to remind you of feeding your baby or other things.
 Sleep Mode	Screen sleep function setting
 Motion Detection	The Alarm "beep" will be triggered when image movement is detected

System Setting (Parent Unit)

EN

Setting Options	Descriptions
Date Time	Setting the date/ time
Pairing	Pair the camera you want(Max Support 2 Cameras)
Frequency	Change to the suitable Anti-screen Flicker mode
Alert Volume	Adjust the desired volume of Alert.
Language	Choose the language you want.
Default	Restore the monitor to its default setting
Firmware Info	Know the firmware version information

Technical Features

EN

Signal Connection: 2.4GHz
Operating Temperature: -10°C ~ + 45°C (14 °F ~ 113 °F)
Operating Humidity: <85%

Parent Unit (Monitor)

LCD: 5.0 inch TFT
Resolution: 854*480
Battery: Li-Polymer 4000mAh
Power Input: USB Type-C 5V/2A

Baby Unit (Camera)

Image Sensor: 1/2.7", CMOS
Camera Resolution: 1080P
Power Input: USB Type-C 5V/1A
PTZ Angel: Pan: 310°; Tilt:50°
IR LED: 8pcs 940nm Infrared Fill Light

Troubleshooting

EN

Possible Problems	Solutions
How to turn on/off the baby monitor and turn on/off the screen?	Power on/off: long press the Power button for 5 seconds; On/off screen: short press the Power button once;
What is the battery capacity? How long will it last? How long does it take to fully charge?	The standard battery capacity is 4000mAh; after a normal battery is fully charged, it can be used for about 9 hours if it is in sleep mode. It can be used for about 4.5 hours in the normal bright screen working state; the battery starts to be charged from a completely empty condition, and it can be fully charged in about 9 hours; the power indicator light is red during charging, and the power indicator light is green when fully charged;
Why does the monitoring screen keep flashing?	The flickering of the monitoring screen is because the frequency set by the camera does not match the actual area. You can set the frequency of the camera. To solve the problem, first press the Menu button to enter the main menu, then press the up and down buttons to select System Setting -->-->Select<Frequency>50Hz/60Hz-->Press the OK button to confirm completion;

<p>Why does no one pass by and record video?</p>	<p>The camera has no PIR detection function, only image comparison, so as long as the image has a certain degree of change, it will record</p>
<p>Why does no one pass by and record video?</p>	<p>After the screen is off, as long as there is an alarm trigger (vox, motion, temp, feed time) or short press the Power button, the screen will turn on;</p>
<p>Why is there a trigger but no alarm after the VOX function is turned on?</p>	<p>It is possible that the sound level does not meet the requirements. You can set the VOX sensitivity to high. In addition, if the lullaby playback function is turned on, VOX function is invalid, you must turn off the lullaby to play VOX function to be effective.</p>

FCC Statement

This device complies with Part 15 of the FCC rules. Operation is subject to the following two conditions: 1) this device may not cause harmful interference, and 2) this device must accept any interference received, including interference that may cause undesired operation.

Note: This equipment has been tested and found to comply with the limits for a Class B digital device, pursuant to part 15 of the FCC Rules. These limits are designed to provide reasonable protection against harmful interference in a residential installation.

This equipment generates uses and can radiate radio frequency energy and, if not installed and used in accordance with the instructions, may cause harmful interference to radio communications. However, there is no guarantee that interference will not occur in particular installation. If this equipment does cause harmful interference to radio or television reception, which can be determined by turning the equipment off and on, the user is encouraged to try to correct the interference by one or more of the following measures:

--Reorient or relocate the receiving antenna.

--Increase the separation between the equipment and receiver.

--Connect the equipment into an outlet on a circuit different from that to which the receiver is connected.

--Consult the dealer or an experienced radio/TV technician for help.

Changes or modifications not expressly approved by the party responsible for compliance could void the user's authority to operate the equipment.

Radiation Exposure Statement

For Monitor: To comply with FCC RF exposure compliance requirements, this grant is applicable to only mobile configurations. The antennas used for this transmitter must be installed to provide a separation distance of at least 20 cm from all persons and must not be co-located or operating in conjunction with any other antenna or transmitter.

For Receiver: The device has been evaluated to meet general RF exposure requirement. The device can be used in portable exposure condition without restriction.

Warranty

All Victure products come with a limited warranty of 12 months from the date of purchase. And we have a professional customer service team for your support as soon as we can.

If you have any questions or confusion about our product or warranty, please feel free to contact us. We will do our best to help you solve the problem until you are satisfied.

Victure Customer Care Service Mailbox: bm.support@govicture.com

Victure Official Facebook: **Search "Victure Video Baby Monitor"**

Complaint Mailbox: support@govicture.com

WELCOME TO REGISTER YOUR WARRANTY AT FB ONLINE:

"Victure Baby Monitor VIPs" TO EXTEND YOUR LIFETIME WARRANTY!