



FCC RADIO TEST REPORT

FCC ID : 2AWNEKDE20105
Equipment : Home Entertainment Hub
Brand Name : E1 by Ericsson
Model Name : KDE20105
Applicant : Ericsson AB
21-23 Torshamnsgatan Stockholm, 16480 Sweden
Manufacturer : CyberTAN Technology Inc.
No. 99, Park Avenue III Science-based Industrial
Park Hsinchu Taiwan 308
Standard : 47 CFR FCC Part 15.247

The product was received on Jan. 14, 2021, and testing was started from Jan. 14, 2021 and completed on Feb. 18, 2021. We, SPORTON INTERNATIONAL INC. EMC & Wireless Communications Laboratory, would like to declare that the tested sample has been evaluated in accordance with the procedures given in ANSI C63.10-2013 and shown compliance with the applicable technical standards.

The test results in this report apply exclusively to the tested model / sample. Without written approval of SPORTON INTERNATIONAL INC. EMC & Wireless Communications Laboratory, the test report shall not be reproduced except in full.

Approved by: Sam Chen

SPORTON INTERNATIONAL INC. EMC & Wireless Communications Laboratory
No. 52, Huaya 1st Rd., Guishan Dist., Taoyuan City, Taiwan (R.O.C.)



Table of Contents

History of this test report.....3

Summary of Test Result.....4

1 General Description5

1.1 Information.....5

1.2 Applicable Standards8

1.3 Testing Location Information.....8

1.4 Measurement Uncertainty8

2 Test Configuration of EUT9

2.1 Test Channel Mode9

2.2 The Worst Case Measurement Configuration.....10

2.3 EUT Operation during Test11

2.4 Accessories12

2.5 Support Equipment.....12

2.6 Test Setup Diagram14

3 Transmitter Test Result17

3.1 AC Power-line Conducted Emissions17

3.2 DTS Bandwidth19

3.3 Maximum Conducted Output Power20

3.4 Power Spectral Density23

3.5 Emissions in Non-restricted Frequency Bands25

3.6 Emissions in Restricted Frequency Bands.....26

4 Test Equipment and Calibration Data30

Appendix A. Test Results of AC Power-line Conducted Emissions

Appendix B. Test Results of DTS Bandwidth

Appendix C. Test Results of Maximum Conducted Output Power

Appendix D. Test Results of Power Spectral Density

Appendix E. Test Results of Emissions in Non-restricted Frequency Bands

Appendix F. Test Results of Emissions in Restricted Frequency Bands

Appendix G. Test Results of Radiated Emission Co-location

Appendix H. Test Photos

Photographs of EUT v01



Summary of Test Result

Report Clause	Ref Std. Clause	Test Items	Result (PASS/FAIL)	Remark
1.1.2	15.203	Antenna Requirement	PASS	-
3.1	15.207	AC Power-line Conducted Emissions	PASS	-
3.2	15.247(a)	DTS Bandwidth	PASS	-
3.3	15.247(b)	Maximum Conducted Output Power	PASS	-
3.4	15.247(e)	Power Spectral Density	PASS	-
3.5	15.247(d)	Emissions in Non-restricted Frequency Bands	PASS	-
3.6	15.247(d)	Emissions in Restricted Frequency Bands	PASS	-

Declaration of Conformity:

The test results with all measurement uncertainty excluded are presented in accordance with the regulation limits or requirements declared by manufacturers.

Comments and Explanations:

The declared of product specification for EUT presented in the report are provided by the manufacturer, and the manufacturer takes all the responsibilities for the accuracy of product specification.

Reviewed by: **Sam Chen**

Report Producer: **Vicky Huang**



1 General Description

1.1 Information

1.1.1 RF General Information

Frequency Range (MHz)	Bluetooth Mode	Ch. Frequency (MHz)	Channel Number
2400-2483.5	LE	2402-2480	0-39 [40]

Band	Mode	BWch (MHz)	Nant
2.4-2.4835GHz	BT-LE(1Mbps)	1.0	1TX

Note:

- ♦ Bluetooth LE uses a GFSK modulation.
- ♦ BWch is the nominal channel bandwidth.

1.1.2 Antenna Information

For WLAN 2.4GHz / WLAN 5GHz / Bluetooth / Zigbee function:

Ant.	Port		Brand	Model Name	Type	Connector	Gain (dBi)		
	WLAN 2.4GHz	WLAN 5GHz B1,B2					WLAN 2.4GHz	WLAN 5GHz B1	WLAN 5GHz B2
1	1	1	Airgain	N2420DSRP	PCB	I-PEX	1.7	3.5	3.4
2	2	2	Airgain	N2420DSRL	PCB	I-PEX	2.0	3.6	3.7
Ant.	Port		Brand	Model Name	Type	Connector	Gain (dBi)		
	WLAN 5GHz B3,B4	Zigbee					WLAN 5GHz B3	WLAN 5GHz B4	Zigbee
3	1	1	Airgain	N2420DSRK	PCB	I-PEX	4.1	4.1	1.8
Ant.	Port		Brand	Model Name	Type	Connector	Gain (dBi)		
	WLAN 5GHz B3,B4	BT					WLAN 5GHz B3	WLAN 5GHz B4	BT
4	2	1	Airgain	N2420DSRK	PCB	I-PEX	4.7	3.9	1.5

Note1: B1 means band 1, B2 means band 2, B3 means band 3, B4 means band 4 and BT means Bluetooth.

Note2: The above information was declared by manufacturer.

Note3: For WLAN 2.4GHz function (2TX/2RX):

The WLAN 2.4GHz supports the b, g, n, VHT.

Port 1 and Port 2 could transmit/receive simultaneously.

Note4: For WLAN 5GHz Band 1, Band 2 function (2TX/2RX):

The WLAN 5GHz Band 1, Band 2 supports the a, n, ac.

Port 1 and Port 2 could transmit/receive simultaneously.

Note5: For WLAN 5GHz Band 3, Band 4 function (2TX/2RX):

The WLAN 5GHz Band 3, Band 4 supports the a, n, ac.

Port 1 and Port 2 could transmit/receive simultaneously.



Note6: For Zigbee function (1TX/1RX):
Only Port 1 can be used as transmitting/receiving.

Note7: For Bluetooth function (1TX/1RX):
Only Port 1 can be used as transmitting/receiving.

1.1.3 Mode Test Duty Cycle

Mode	DC	DCF(dB)	T(s)	VBW(Hz) ≥ 1/T
BT-LE(1Mbps)	0.631	2	402.75u	3k

Note:

- ◆ DC is Duty Cycle.
- ◆ DCF is Duty Cycle Factor.

1.1.4 EUT Operational Condition

EUT Power Type	From power adapter		
Function	<input checked="" type="checkbox"/> Point-to-multipoint	<input type="checkbox"/> Point-to-point	
Test Software Version	CSR BlueSuite 2.6.9 (Version 2.6.9.1584)		
Support Mode	<input checked="" type="checkbox"/> LE 1M PHY: 1 Mb/s		
	<input type="checkbox"/> LE Coded PHY (S=2): 500 Kb/s		
	<input type="checkbox"/> LE Coded PHY (S=8): 125 Kb/s		
	<input type="checkbox"/> LE 2M PHY: 2 Mb/s		

Note: The above information was declared by manufacturer.

1.1.5 Table for WWAN Module Information

The EUT was installed certified WWAN module, the WWAN module information and its correspond model name as below table:

WWAN Module	Brand Name	Model Name	FCC ID	Bands
1	Sierra	EM9190	N7NEM91	4G Band (LTE): 2,4,5,7,12,13,14,17,25,26,30,38,41,42,48,66,71 5G Band (NR): n2,n5,n41,n66,n71
2	Sierra	EM9191	N7NEM91	5G Band (EN-DC): EN-DC_5A_n2A,EN-DC_12A_n2A,EN-DC_2A_n5A,EN-DC_7A_n5A,EN-DC_30A_n5A,EN-DC_66A_n5A,EN-DC_2A_n41A,EN-DC_66A_n41A,EN-DC_5A_n66A,EN-DC_12A_n66A,EN-DC_13A_n66A,EN-DC_2A_n71A,EN-DC_7A_n71A,EN-DC_66A_n71A

Note: The above information was declared by manufacturer.



1.1.6 Table for EUT Supports Functions

Function	Support Type
AP	Master
Mesh	Master

Note: After evaluating, the "AP Mode" have been selected to test and recorded in the test report.



1.2 Applicable Standards

According to the specifications of the manufacturer, the EUT must comply with the requirements of the following standards:

- ♦ 47 CFR FCC Part 15
- ♦ ANSI C63.10-2013

The following reference test guidance is not within the scope of accreditation of TAF.

- ♦ FCC KDB 558074 D01 v05r02
- ♦ FCC KDB 414788 D01 v01r01

1.3 Testing Location Information

Testing Location		
<input type="checkbox"/>	HWA YA	ADD : No. 52, Huaya 1st Rd., Guishan Dist., Taoyuan City, Taiwan (R.O.C.) TEL : 886-3-327-3456 FAX : 886-3-327-0973
<input checked="" type="checkbox"/>	JHUBEI	ADD : No.8, Ln. 724, Bo'ai St., Zhubei City, Hsinchu County 302, Taiwan (R.O.C.) TEL : 886-3-656-9065 FAX : 886-3-656-9085

Test Condition	Test Site No.	Test Engineer	Test Environment (°C / %)	Test Date
RF Conducted	TH01-CB	Serway Li	21.2-23.2 / 54-57	Jan. 27, 2021~ Feb. 04, 2021
Radiated (Co-Location)	03CH05-CB	Kevin Huang	22.6-23.6 / 54-57	Feb. 03, 2021
Radiated (Below 1GHz)	03CH03-CB	Kevin Huang	21.5-22.9 / 55-57	Feb. 06, 2021
Radiated (Above 1GHz)	03CH03-CB	Kevin Huang	21.8-22.8 / 55-58	Jan. 14, 2021~ Feb. 03, 2021
AC Conduction	CO01-CB	Ryo Fan	18~19 / 61~62	Jan. 21, 2021~ Feb. 18, 2021

Test site Designation No. TW0006 with FCC.
Test site registered number IC 4086D with Industry Canada.

1.4 Measurement Uncertainty

ISO/IEC 17025 requires that an estimate of the measurement uncertainties associated with the emissions test results be included in the report. The measurement uncertainties given below are based on a 95% confidence level (based on a coverage factor (k=2))

Test Items	Uncertainty	Remark
Conducted Emission (150kHz ~ 30MHz)	2.0 dB	Confidence levels of 95%
Radiated Emission (9kHz ~ 30MHz)	3.8 dB	Confidence levels of 95%
Radiated Emission (30MHz ~ 1,000MHz)	5.6 dB	Confidence levels of 95%
Radiated Emission (1GHz ~ 18GHz)	5.0 dB	Confidence levels of 95%
Radiated Emission (18GHz ~ 40GHz)	4.9 dB	Confidence levels of 95%
Conducted Emission	2.8 dB	Confidence levels of 95%
Output Power Measurement	1.4 dB	Confidence levels of 95%
Power Density Measurement	2.8 dB	Confidence levels of 95%
Bandwidth Measurement	0.4%	Confidence levels of 95%



2 Test Configuration of EUT

2.1 Test Channel Mode

Mode	Power Setting
BT-LE(1Mbps)	-
2402MHz	10
2440MHz	10
2480MHz	10



2.2 The Worst Case Measurement Configuration

The Worst Case Mode for Following Conformance Tests	
Tests Item	AC power-line conducted emissions
Condition	AC power-line conducted measurement for line and neutral
Operating Mode	Normal Link
1	Normal link-EUT with WWAN module 1-LTE link Band 2 + Adapter with US cable
2	Normal link-EUT with WWAN module 1-5G EN-DC_2A_n41A + Adapter with US cable
Mode 1 has been evaluated to be the worst case between Mode 1~2, thus measurement for Mode 3 will follow this same test mode.	
3	Normal link-EUT with WWAN module 2-LTE link Band 2 + Adapter with US cable
For operating mode 1 is the worst case and it was record in this test report.	

The Worst Case Mode for Following Conformance Tests	
Tests Item	DTS Bandwidth Maximum Conducted Output Power Power Spectral Density Emissions in Non-restricted Frequency Bands
Test Condition	Conducted measurement at transmit chains

The Worst Case Mode for Following Conformance Tests	
Tests Item	Emissions in Restricted Frequency Bands
Test Condition	Radiated measurement If EUT consist of multiple antenna assembly (multiple antenna are used in EUT regardless of spatial multiplexing MIMO configuration), the radiated test should be performed with highest antenna gain of each antenna type.
Operating Mode < 1GHz	CTX
1	WLAN 2.4GHz + Adapter with US cable
2	WLAN 5GHz Band 1, 2 + Adapter with US cable
3	WLAN 5GHz Band 3, 4 + Adapter with US cable
4	Bluetooth + Adapter with US cable
5	Zigbee + Adapter with US cable
For operating mode 3 is the worst case and it was record in this test report.	
Operating Mode > 1GHz	CTX



The Worst Case Mode for Following Conformance Tests	
Tests Item	Simultaneous Transmission Analysis - Radiated Emission Co-location
Test Condition	Radiated measurement
Operating Mode	Normal Link
The Operating Mode of Radiated Emission Co-location as below: 1. WLAN 2.4GHz + WLAN 5GHz Band 1, 2 2. WLAN 5GHz Band 3, 4 + Bluetooth + Zigbee After evaluating, the full function generated the worst case, thus the measurement will follow this same test configuration.	
1	WLAN 2.4GHz + WLAN 5GHz Band 1, 2 + WLAN 5GHz Band 3, 4 + Bluetooth + Zigbee
Refer to Appendix G for Radiated Emission Co-location.	

The Worst Case Mode for Following Conformance Tests	
Tests Item	Simultaneous Transmission Analysis - Co-location RF Exposure Evaluation
Operating Mode	
1	WLAN 2.4GHz + WLAN 5GHz Band 1, 2 + WLAN 5GHz Band 3, 4 + Bluetooth + Zigbee + 4G LTE
2	WLAN 2.4GHz + WLAN 5GHz Band 1, 2 + WLAN 5GHz Band 3, 4 + Bluetooth + Zigbee + 5G NR
Refer to Sporton Test Report No.: FA031609-03 for Co-location RF Exposure Evaluation.	

Note: The EUT can only be used Z axis.

2.3 EUT Operation during Test

For CTX Mode:

The EUT was programmed to be in continuously transmitting mode.

For Normal Link:

During the test, the EUT operation to normal function.



2.4 Accessories

Accessories				
Equipment Name	Brand Name	Model Name	Rating	DC Power cable length
Adapter	FSP	FSP100-A1AR3	INPUT: 100-240V~50-60Hz, 1.4A OUTPUT: 5V, 3A / 9V, 3A 12V, 3A / 15V, 3A 20V, 5.0A 100W MAX.	Non-Shielded 1.6m
Others				
HDMI cable*1: Shielded, 1.5m				
USB-C to USB-A cable*1: Shielded, 0.1m				
Power cable*1: Non-shielded, 1m				

2.5 Support Equipment

For AC Conduction:

Support Equipment				
No.	Equipment	Brand Name	Model Name	FCC ID
A	TV	ASUS	VP28U	N/A
B	Micro SD Card	Transcend	TS16GUSDHC10	N/A
C	SIM Card	N/A	N/A	N/A
D	LAN NB	DELL	E6430	N/A
E	WAN NB	DELL	E6430	N/A
F	2.4G NB	DELL	E6430	N/A
G	5G-1 NB	DELL	E6430	N/A
H	5G-2 NB	DELL	E6430	N/A
I	Bluetooth Speaker	MARUS	MSK06C-RD	N/A
J	Zigbee Device	N/A	N/A	N/A
K	LTE+5G NR Base station	Anritsu	MT8821C	N/A
L	Air Mouse	HENGCHUANGYU	HCY-57B	2A0BUHCY-57B

For Radiated (below 1GHz):

Support Equipment				
No.	Equipment	Brand Name	Model Name	FCC ID
H	NB	DELL	E4300	N/A



For Radiated (above 1GHz):

Support Equipment				
No.	Equipment	Brand Name	Model Name	FCC ID
A	LCD Monitor	DELL	1704FPTt	N/A
B	USB Hub	IOTNPCI	HB-16	N/A
C	Keyboard	iCooky	SK068	N/A
D	Mouse	Logitech	M-U0026	N/A

For RF Conducted:

Support Equipment				
No.	Equipment	Brand Name	Model Name	FCC ID
B	USB Hub	IOTNPCI	HB-16	N/A
C	LCD Monitor	DELL	1704FPTt	N/A
D	Keyboard	iCooky	SK068	N/A
E	Mouse	Logitech	M-U0026	N/A

2.6 Test Setup Diagram

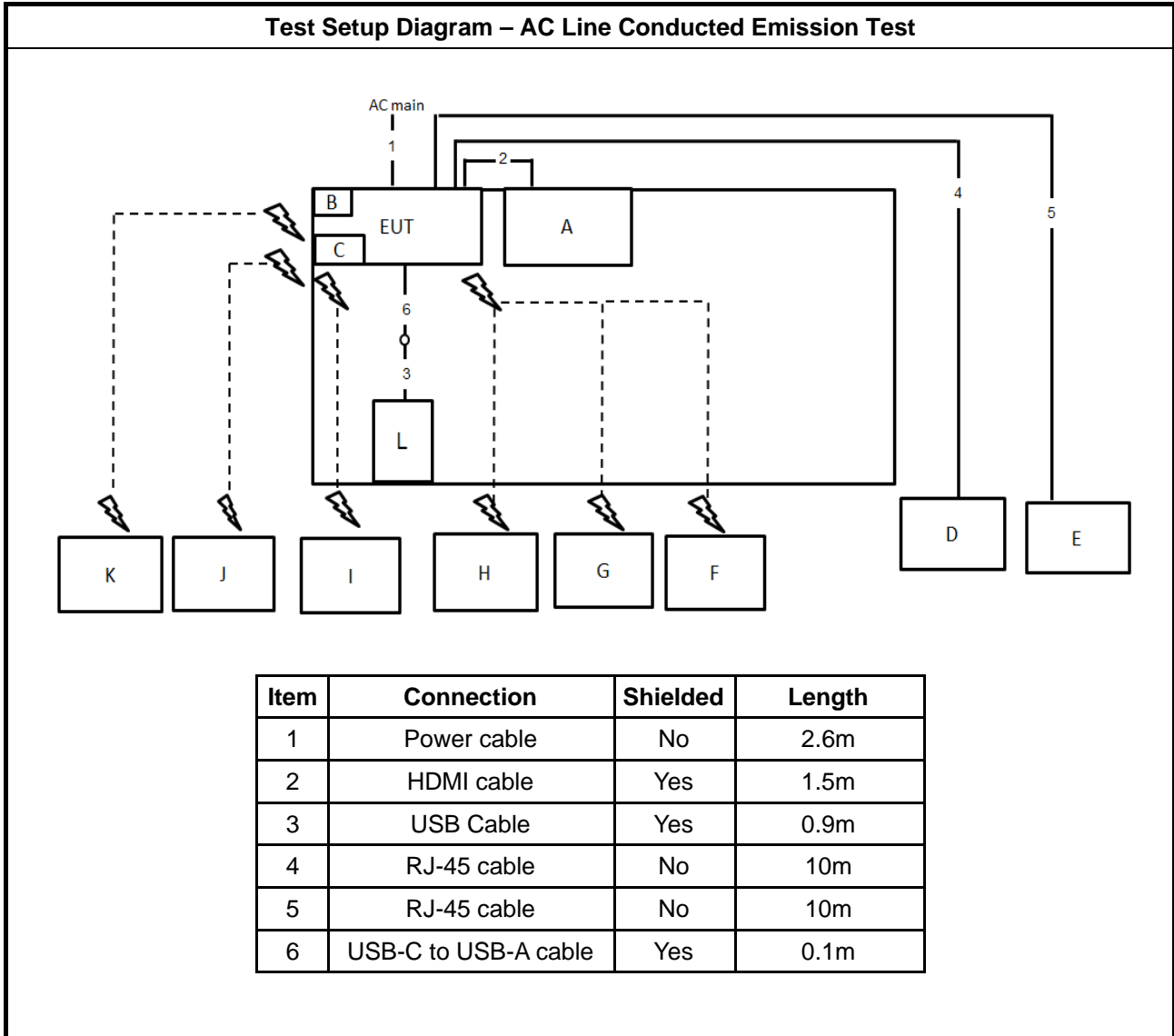



Test Setup Diagram - Radiated Test < 1GHz

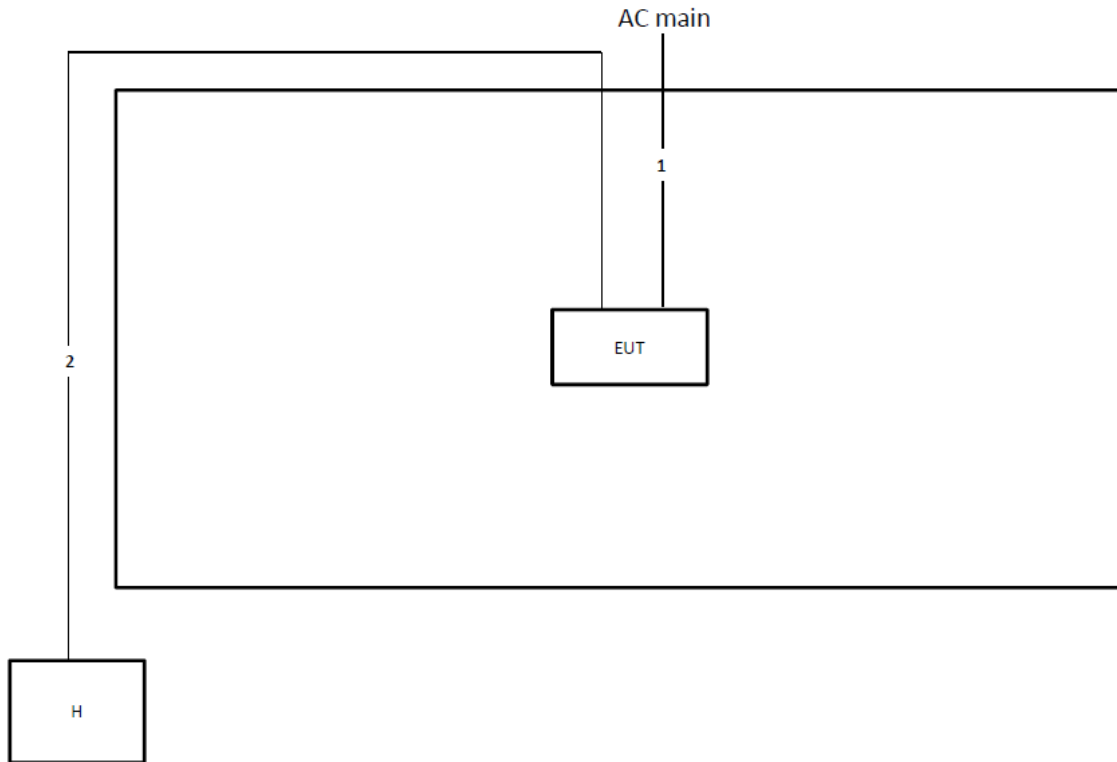

Item	Connection	Shielded	Length
1	Power cable	No	2.6m
2	RJ-45 cable	No	10m

Test Setup Diagram - Radiated Test > 1GHz

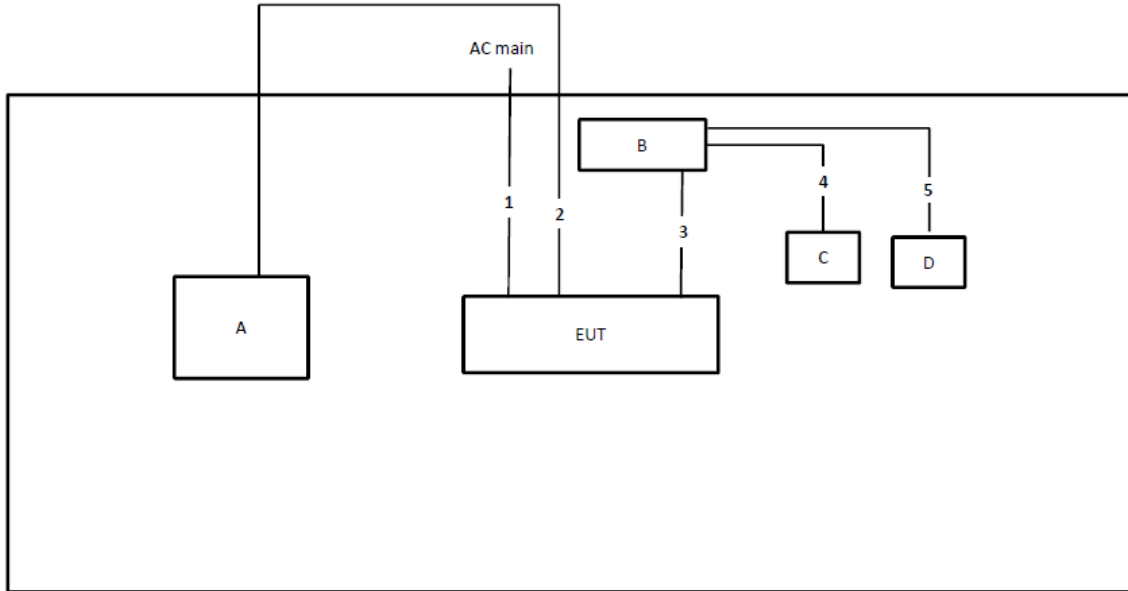

Item	Connection	Shielded	Length
1	Power cable	No	2.6m
2	HDMI cable	Yes	1m
3	USB-C to USB-A cable	Yes	0.1m
4	USB cable	Yes	1.8m
5	USB cable	Yes	1.8m



3 Transmitter Test Result

3.1 AC Power-line Conducted Emissions

3.1.1 AC Power-line Conducted Emissions Limit

AC Power-line Conducted Emissions Limit		
Frequency Emission (MHz)	Quasi-Peak	Average
0.15-0.5	66 - 56 *	56 - 46 *
0.5-5	56	46
5-30	60	50

Note 1: * Decreases with the logarithm of the frequency.

3.1.2 Measuring Instruments

Refer a test equipment and calibration data table in this test report.

3.1.3 Test Procedures

Test Method
▪ Refer as ANSI C63.10-2013, clause 6.2 for AC power-line conducted emissions.

3.1.4 Test Setup

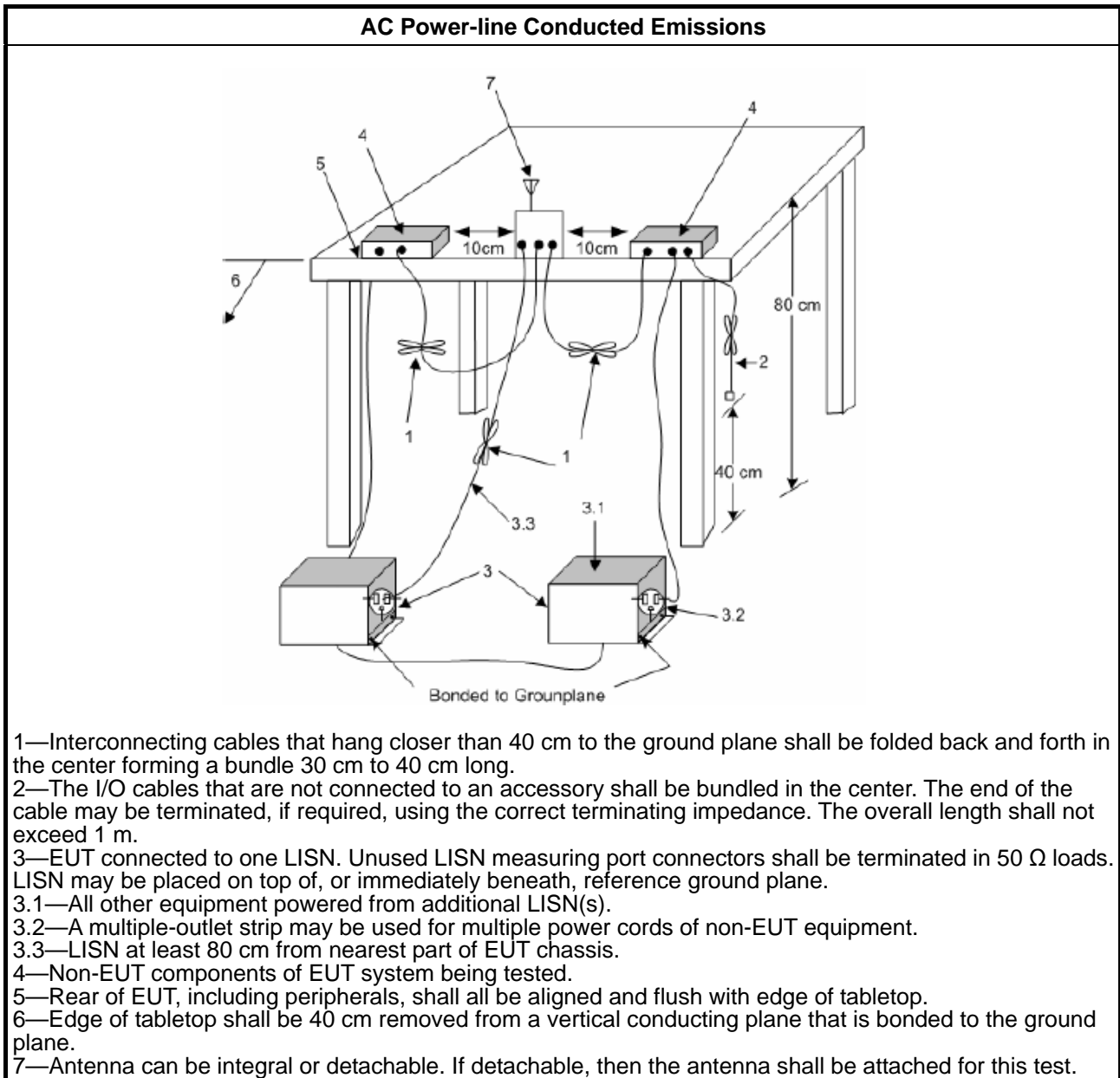

1.1.1. Measurement Results Calculation

The measured Level is calculated using:

- a. Corrected Reading: LISN Factor (LISN) + Attenuator (AT/AUX) + Cable Loss (CL) + Read Level (Raw) = Level
- b. Margin = -Limit + Level

3.1.5 Test Result of AC Power-line Conducted Emissions

Refer as Appendix A

3.2 DTS Bandwidth

3.2.1 6dB Bandwidth Limit

6dB Bandwidth Limit
Systems using digital modulation techniques:
<ul style="list-style-type: none"> ▪ 6 dB bandwidth \geq 500 kHz.

3.2.2 Measuring Instruments

Refer a test equipment and calibration data table in this test report.

3.2.3 Test Procedures

Test Method
<ul style="list-style-type: none"> ▪ For the emission bandwidth shall be measured using one of the options below:
<input checked="" type="checkbox"/> Refer as FCC KDB 558074, clause 8.2 & C63.10 clause 11.8.1 Option 1 for 6 dB bandwidth measurement.
<input type="checkbox"/> Refer as FCC KDB 558074, clause 8.2 & C63.10 clause 11.8.2 Option 2 for 6 dB bandwidth measurement.
<input type="checkbox"/> Refer as ANSI C63.10, clause 6.9.1 for occupied bandwidth testing.

3.2.4 Test Setup

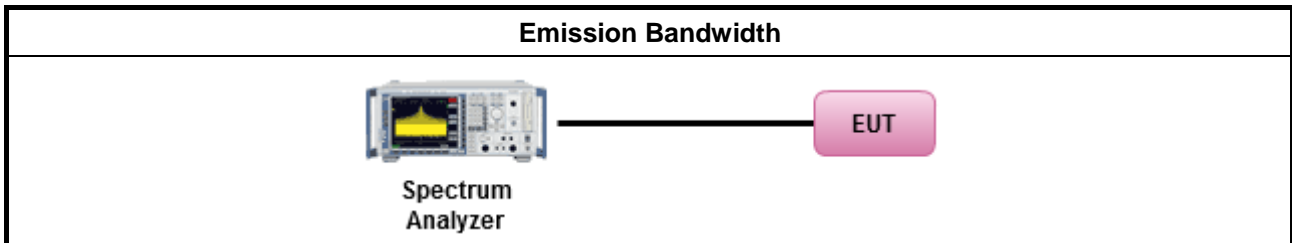

3.2.5 Test Result of Emission Bandwidth

Refer as Appendix B



3.3 Maximum Conducted Output Power

3.3.1 Maximum Conducted Output Power Limit

Maximum Conducted Output Power Limit	
	<ul style="list-style-type: none"> ▪ If $G_{TX} \leq 6$ dBi, then $P_{Out} \leq 30$ dBm (1 W)
	<ul style="list-style-type: none"> ▪ Point-to-multipoint systems (P2M): If $G_{TX} > 6$ dBi, then $P_{Out} = 30 - (G_{TX} - 6)$ dBm
	<ul style="list-style-type: none"> ▪ Point-to-point systems (P2P): If $G_{TX} > 6$ dBi, then $P_{Out} = 30 - (G_{TX} - 6)/3$ dBm
	<ul style="list-style-type: none"> ▪ Smart antenna system (SAS):
	<ul style="list-style-type: none"> - Single beam: If $G_{TX} > 6$ dBi, then $P_{Out} = 30 - (G_{TX} - 6)/3$ dBm
	<ul style="list-style-type: none"> - Overlap beam: If $G_{TX} > 6$ dBi, then $P_{Out} = 30 - (G_{TX} - 6)/3$ dBm
	<ul style="list-style-type: none"> - Aggregate power on all beams: If $G_{TX} > 6$ dBi, then $P_{Out} = 30 - (G_{TX} - 6)/3 + 8$ dB dBm
<p>P_{Out} = maximum peak conducted output power or maximum conducted output power in dBm, G_{TX} = the maximum transmitting antenna directional gain in dBi.</p>	

3.3.2 Measuring Instruments

Refer a test equipment and calibration data table in this test report.

3.3.3 Test Procedures

Test Method	
<ul style="list-style-type: none"> ▪ Maximum Peak Conducted Output Power 	
	<input type="checkbox"/> Refer as FCC KDB 558074, clause 8.3.1.1 & C63.10 clause 11.9.1.1 (RBW ≥ EBW method).
	<input type="checkbox"/> Refer as FCC KDB 558074, clause 8.3.1.3 & C63.10 clause 11.9.1.3 (peak power meter).
<ul style="list-style-type: none"> ▪ Maximum Conducted Output Power 	
[duty cycle ≥ 98% or external video / power trigger]	
	<input type="checkbox"/> Refer as FCC KDB 558074, clause 8.3.2.2 & C63.10 clause 11.9.2.2.2 Method AVGSA-1.
	<input type="checkbox"/> Refer as FCC KDB 558074, clause 8.3.2.2 & C63.10 clause 11.9.2.2.3 Method AVGSA-1A. (alternative)
duty cycle < 98% and average over on/off periods with duty factor	
	<input type="checkbox"/> Refer as FCC KDB 558074, clause 8.3.2.2 & C63.10 clause 11.9.2.2.4 Method AVGSA-2.
	<input type="checkbox"/> Refer as FCC KDB 558074, clause 8.3.2.2 & C63.10 clause 11.9.2.2.5 Method AVGSA-2A (alternative)
	<input type="checkbox"/> Refer as FCC KDB 558074, clause 8.3.2.2 & C63.10 clause 11.9.2.2.6 Method AVGSA-3
	<input type="checkbox"/> Refer as FCC KDB 558074, clause 8.3.2.2 & C63.10 clause 11.9.2.2.7 Method AVGSA-3A (alternative)
Measurement using a power meter (PM)	
	<input type="checkbox"/> Refer as FCC KDB 558074, clause 8.3.2.3 & C63.10 clause 11.9.2.3.1 Method AVGPM (using an RF average power meter).
	<input checked="" type="checkbox"/> Refer as FCC KDB 558074, clause 8.3.2.3 & C63.10 clause 11.9.2.3.2 Method AVGPM-G (using an gate RF average power meter).
<ul style="list-style-type: none"> ▪ For conducted measurement. 	
<ul style="list-style-type: none"> ▪ If the EUT supports multiple transmit chains using options given below: Refer as FCC KDB 662911, In-band power measurements. Using the measure-and-sum approach, measured all transmit ports individually. Sum the power (in linear power units e.g., mW) of all ports for each individual sample and save them. 	
<ul style="list-style-type: none"> ▪ If multiple transmit chains, EIRP calculation could be following as methods: $P_{total} = P_1 + P_2 + \dots + P_n$ (calculated in linear unit [mW] and transfer to log unit [dBm]) $EIRP_{total} = P_{total} + DG$ 	

3.3.4 Test Setup

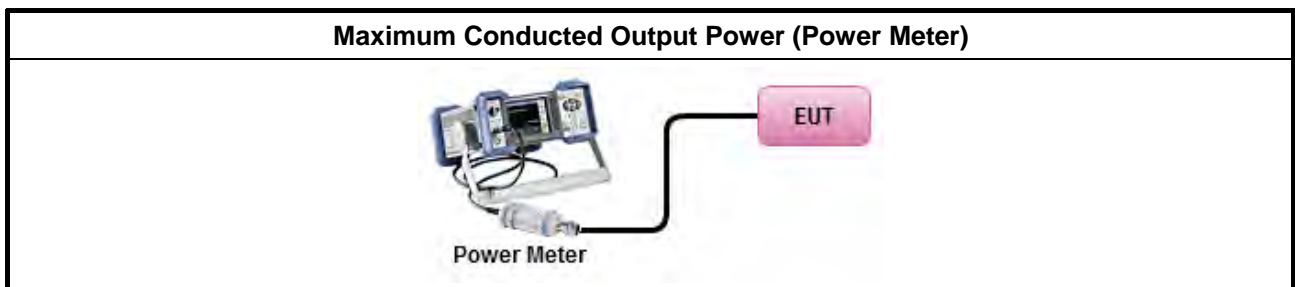



3.3.5 Test Result of Maximum Conducted Output Power

Refer as Appendix C



3.4 Power Spectral Density

3.4.1 Power Spectral Density Limit

Power Spectral Density Limit
<ul style="list-style-type: none"> Power Spectral Density (PSD) ≤ 8 dBm/3kHz

3.4.2 Measuring Instruments

Refer a test equipment and calibration data table in this test report.

3.4.3 Test Procedures

Test Method
<ul style="list-style-type: none"> Peak power spectral density procedures that the same method as used to determine the conducted output power. If maximum peak conducted output power was measured to demonstrate compliance to the output power limit, then the peak PSD procedure below (Method PKPSD) shall be used. If maximum conducted output power was measured to demonstrate compliance to the output power limit, then one of the average PSD procedures shall be used, as applicable based on the following criteria (the peak PSD procedure is also an acceptable option).
<input checked="" type="checkbox"/> Refer as FCC KDB 558074, clause 8.4 & C63.10 clause 11.10 Method Max. PSD. [duty cycle ≥ 98% or external video / power trigger]
<ul style="list-style-type: none"> For conducted measurement.
<ul style="list-style-type: none"> If The EUT supports multiple transmit chains using options given below: <ul style="list-style-type: none"> <input type="checkbox"/> Option 1: Measure and sum the spectra across the outputs. Refer as FCC KDB 662911, In-band power spectral density (PSD). Sample all transmit ports simultaneously using a spectrum analyzer for each transmit port. Where the trace bin-by-bin of each transmit port summing can be performed. (i.e., in the first spectral bin of output 1 is summed with that in the first spectral bin of output 2 and that from the first spectral bin of output 3, and so on up to the NTX output to obtain the value for the first frequency bin of the summed spectrum.). Add up the amplitude (power) values for the different transmit chains and use this as the new data trace. <input type="checkbox"/> Option 2: Measure and sum spectral maxima across the outputs. With this technique, spectra are measured at each output of the device at the required resolution bandwidth. The maximum value (peak) of each spectrum is determined. These maximum values are then summed mathematically in linear power units across the outputs. These operations shall be performed separately over frequency spans that have different out-of-band or spurious emission limits, <input type="checkbox"/> Option 3: Measure and add 10 log(N) dB, where N is the number of transmit chains. Refer as FCC KDB 662911, In-band power spectral density (PSD). Performed at each transmit chains and each transmit chains shall be compared with the limit have been reduced with 10 log(N). Or each transmit chains shall be add 10 log(N) to compared with the limit.

3.4.4 Test Setup

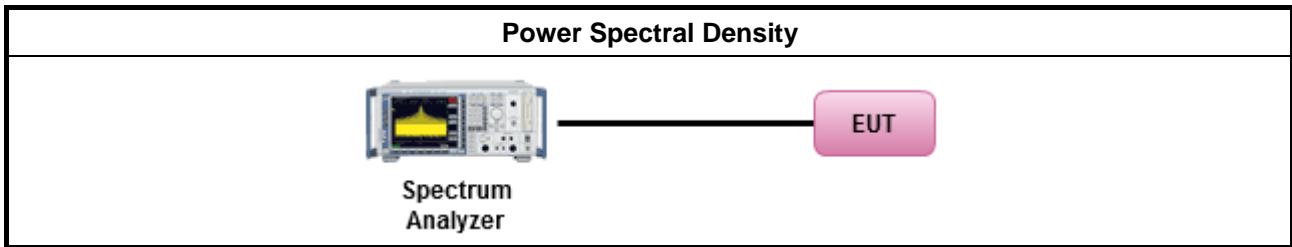

3.4.5 Test Result of Power Spectral Density

Refer as Appendix D

3.5 Emissions in Non-restricted Frequency Bands

3.5.1 Emissions in Non-restricted Frequency Bands Limit

Un-restricted Band Emissions Limit	
RF output power procedure	Limit (dBc)
Peak output power procedure	20
Average output power procedure	30

Note 1: If the peak output power procedure is used to measure the fundamental emission power to demonstrate compliance to requirements, then the peak conducted output power measured within any 100 kHz outside the authorized frequency band shall be attenuated by at least 20 dB relative to the maximum measured in-band peak PSD level.

Note 2: If the average output power procedure is used to measure the fundamental emission power to demonstrate compliance to requirements, then the power in any 100 kHz outside of the authorized frequency band shall be attenuated by at least 30 dB relative to the maximum measured in-band average PSD level.

3.5.2 Measuring Instruments

Refer a test equipment and calibration data table in this test report.

3.5.3 Test Procedures

Test Method
<ul style="list-style-type: none"> Refer as FCC KDB 558074, clause 8.5 for unwanted emissions into non-restricted bands.

3.5.4 Test Setup

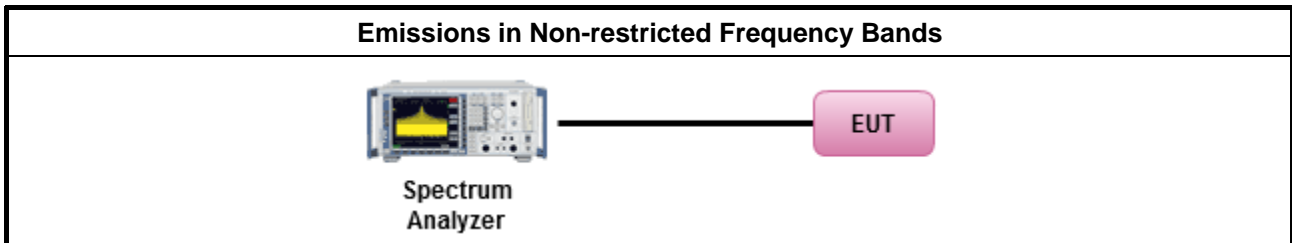

3.5.5 Test Result of Emissions in Non-restricted Frequency Bands

Refer as Appendix E



3.6 Emissions in Restricted Frequency Bands

3.6.1 Emissions in Restricted Frequency Bands Limit

Restricted Band Emissions Limit			
Frequency Range (MHz)	Field Strength (uV/m)	Field Strength (dBuV/m)	Measure Distance (m)
0.009~0.490	2400/F(kHz)	48.5 - 13.8	300
0.490~1.705	24000/F(kHz)	33.8 - 23	30
1.705~30.0	30	29	30
30~88	100	40	3
88~216	150	43.5	3
216~960	200	46	3
Above 960	500	54	3

Note 1: Test distance for frequencies at or above 30 MHz, measurements may be performed at a distance other than the limit distance provided they are not performed in the near field and the emissions to be measured can be detected by the measurement equipment. When performing measurements at a distance other than that specified, the results shall be extrapolated to the specified distance using an extrapolation factor of 20 dB/decade (inverse of linear distance for field-strength measurements, inverse of linear distance-squared for power-density measurements).

Note 2: Test distance for frequencies at below 30 MHz, measurements may be performed at a distance closer than the EUT limit distance; however, an attempt should be made to avoid making measurements in the near field. When performing measurements below 30 MHz at a closer distance than the limit distance, the results shall be extrapolated to the specified distance by either making measurements at a minimum of two or more distances on at least one radial to determine the proper extrapolation factor or by using the square of an inverse linear distance extrapolation factor (40 dB / decade). The test report shall specify the extrapolation method used to determine compliance of the EUT.

Note 3: Using the distance of 1m during the test for above 18 GHz, and the test value to correct for the distance factor at 3m.

3.6.2 Measuring Instruments

Refer a test equipment and calibration data table in this test report.



3.6.3 Test Procedures

Test Method	
<ul style="list-style-type: none"> ▪ The average emission levels shall be measured in [duty cycle \geq 98 or duty factor]. 	
<ul style="list-style-type: none"> ▪ Refer as ANSI C63.10, clause 6.10.3 band-edge testing shall be performed at the lowest frequency channel and highest frequency channel within the allowed operating band. 	
<ul style="list-style-type: none"> ▪ For the transmitter unwanted emissions shall be measured using following options below: 	
	<ul style="list-style-type: none"> ▪ Refer as FCC KDB 558074, clause 8.6 for unwanted emissions into restricted bands.
	<input type="checkbox"/> Refer as FCC KDB 558074, clause 8.6 & C63.10 clause 11.12.2.5.1(trace averaging for duty cycle \geq 98%).
	<input type="checkbox"/> Refer as FCC KDB 558074, clause 8.6 & C63.10 clause 11.12.2.5.2(trace averaging + duty factor).
	<input checked="" type="checkbox"/> Refer as FCC KDB 558074, clause 8.6 & C63.10 clause 11.12.2.5.3(Reduced VBW \geq 1/T).
	<input type="checkbox"/> Refer as ANSI C63.10, clause 11.12.2.5.3 (Reduced VBW). VBW \geq 1/T, where T is pulse time.
	<input type="checkbox"/> Refer as ANSI C63.10, clause 7.5 average value of pulsed emissions.
	<input checked="" type="checkbox"/> Refer as FCC KDB 558074, clause 8.6 & C63.10 clause 11.12.2.4 measurement procedure peak limit.
<ul style="list-style-type: none"> ▪ For the transmitter band-edge emissions shall be measured using following options below: 	
	<ul style="list-style-type: none"> ▪ Refer as FCC KDB 558074 clause 8.7 & c63.10 clause 11.13.1, When the performing peak or average radiated measurements, emissions within 2 MHz of the authorized band edge may be measured using the marker-delta method described below.
	<ul style="list-style-type: none"> ▪ Refer as FCC KDB 558074, clause 8.7 (ANSI C63.10, clause 6.10.6) for marker-delta method for band-edge measurements.
	<ul style="list-style-type: none"> ▪ Refer as FCC KDB 558074, clause 8.7 for narrower resolution bandwidth (100kHz) using the band power and summing the spectral levels (i.e., 1 MHz).
	<ul style="list-style-type: none"> ▪ For conducted unwanted emissions into restricted bands (absolute emission limits). Devices with multiple transmit chains using options given below: (1) Measure and sum the spectra across the outputs or (2) Measure and add 10 log(N) dB
	<ul style="list-style-type: none"> ▪ For FCC KDB 662911 The methodology described here may overestimate array gain, thereby resulting in apparent failures to satisfy the out-of-band limits even if the device is actually compliant. In such cases, compliance may be demonstrated by performing radiated tests around the frequencies at which the apparent failures occurred.

3.6.4 Test Setup

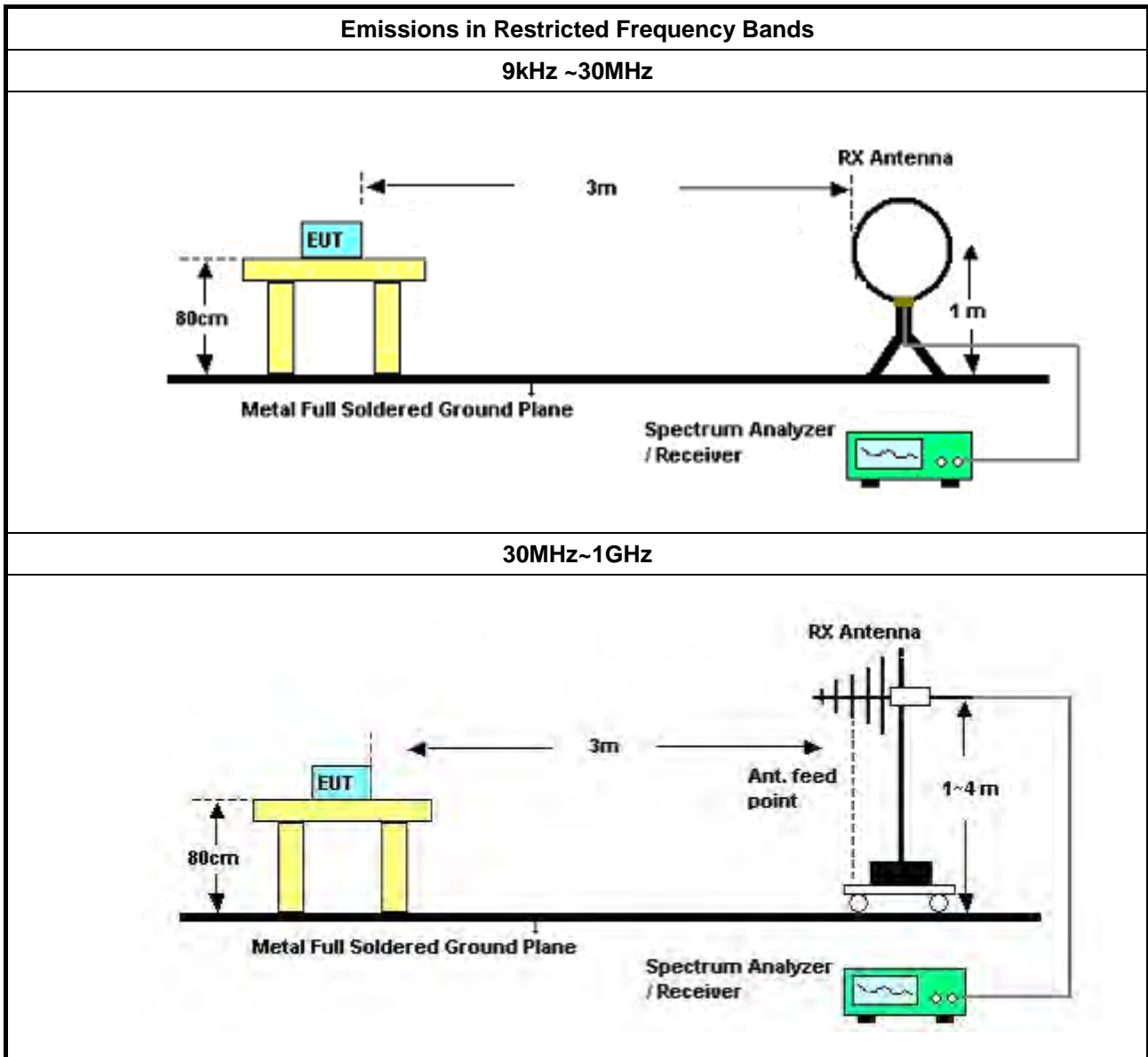

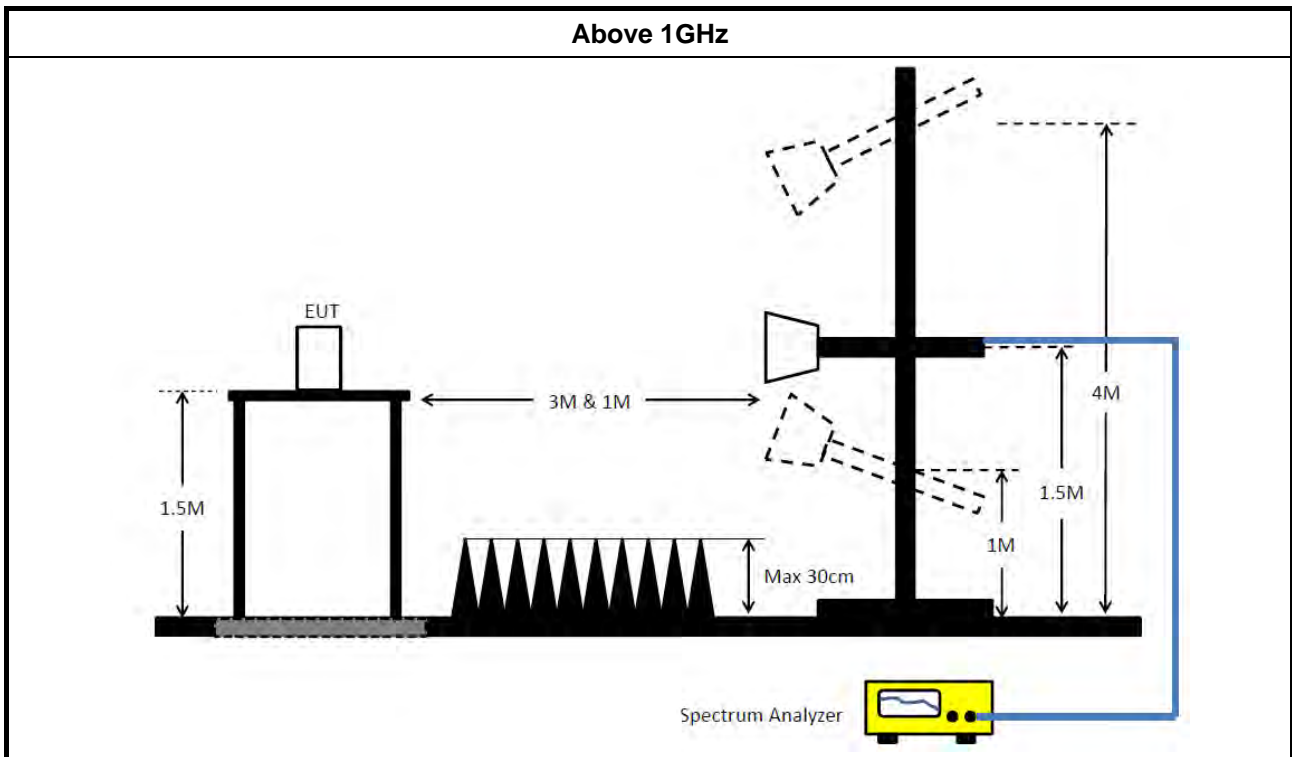

3.6.5 Measurement Results Calculation

The measured Level is calculated using:

Corrected Reading: Antenna factor (AF) + Cable loss (CL) + Read level (Raw) - Preamp factor (PA)(if applicable) = Level.

3.6.6 Emissions in Restricted Frequency Bands (Below 30MHz)

There is a comparison data of both open-field test site and alternative test site - semi-Anechoic chamber according to KDB414788 Radiated Test Site, and the result came out very similar.

All amplitude of spurious emissions that are attenuated by more than 20 dB below the permissible value has no need to be reported.

The radiated emissions were investigated from 9 kHz or the lowest frequency generated within the device, up to the 10th harmonic or 40 GHz, whichever is appropriate.

3.6.7 Test Result of Emissions in Restricted Frequency Bands

Refer as Appendix F



4 Test Equipment and Calibration Data

Instrument	Brand	Model No.	Serial No.	Characteristics	Calibration Date	Calibration Due Date	Remark
EMI Receiver	Agilent	N9038A	My52260123	9kHz ~ 8.4GHz	Feb. 26, 2020	Feb. 25, 2021	Conduction (CO01-CB)
LISN	F.C.C.	FCC-LISN-50-16-2	04083	150kHz ~ 100MHz	Jan. 06, 2021	Jan. 05, 2022	Conduction (CO01-CB)
LISN	Schwarzbeck	NSLK 8127	8127647	9kHz ~ 30MHz	Feb. 25, 2020	Feb. 24, 2021	Conduction (CO01-CB)
Pulse Limiter	Rohde & Schwarz	ESH3-Z2	100430	9kHz ~ 30MHz	Jan. 31, 2020	Jan. 30, 2021	Conduction (CO01-CB)
Pulse Limiter	Rohde & Schwarz	ESH3-Z2	100430	9kHz ~ 30MHz	Jan. 30, 2021	Jan. 29, 2022	Conduction (CO01-CB)
COND Cable	Woken	Cable	Low cable-CO01	9kHz ~ 30MHz	May 20, 2020	May 19, 2021	Conduction (CO01-CB)
Software	SPORTON	SENSE	V5.10	-	N.C.R.	N.C.R.	Conduction (CO01-CB)
3m Semi Anechoic Chamber NSA	TDK	SAC-3M	03CH03-CB	30 MHz ~ 1 GHz	Jan. 27, 2021	Jan. 26, 2022	Radiation (03CH03-CB)
Bilog Antenna with 6 dB attenuator	Schaffner & EMCI	CBL6112B & N-6-06	2928 & AT-N0608	20MHz ~ 2GHz	Feb. 28, 2020	Feb. 27, 2021	Radiation (03CH03-CB)
Pre-Amplifier	Agilent	8447D	2944A10259	9kHz ~ 1.3GHz	Jan. 11, 2021	Jan. 10, 2022	Radiation (03CH03-CB)
Spectrum Analyzer	R&S	FSP40	100019	9kHz ~ 40GHz	Jun. 09, 2020	Jun. 08, 2021	Radiation (03CH03-CB)
EMI Test Receiver	R&S	ESCS	826547/017	9kHz ~ 2.75GHz	May 13, 2020	May 12, 2021	Radiation (03CH03-CB)
RF Cable-low	Woken	RG402	Low Cable-02+29	30MHz ~ 1GHz	Oct. 05, 2020	Oct. 04, 2021	Radiation (03CH03-CB)
Loop Antenna	Teseq	HLA 6120	24155	9kHz - 30 MHz	Apr. 13, 2020	Apr. 12, 2021	Radiation (03CH03-CB)
3m Semi Anechoic Chamber VSWR	TDK	SAC-3M	03CH03-CB	1GHz ~18GHz 3m	May 28, 2020	May 27, 2021	Radiation (03CH03-CB)
Horn Antenna	COM-POWER	AH-118	071028	1GHz ~ 18GHz	Jun. 09, 2020	Jun. 08, 2021	Radiation (03CH03-CB)
Horn Antenna	Schwarzbeck	BBHA 9170	BBHA9170252	15GHz ~ 40GHz	Jul. 21, 2020	Jul. 20, 2021	Radiation (03CH03-CB)



Instrument	Brand	Model No.	Serial No.	Characteristics	Calibration Date	Calibration Due Date	Remark
Pre-Amplifier	Agilent	8449B	3008A02097	1GHz ~ 26.5GHz	Jul. 03, 2020	Jun. 02, 2021	Radiation (03CH03-CB)
Pre-Amplifier	MITEQ	TTA1840-35-H G	1864479	18GHz ~ 40GHz	Jul. 08, 2020	Jul. 07, 2021	Radiation (03CH03-CB)
RF Cable-high	Woken	RG402	High Cable-20+29	1GHz ~ 18GHz	Oct. 05, 2020	Oct. 04, 2021	Radiation (03CH03-CB)
RF Cable-high	Woken	RG402	High Cable-29	1GHz ~ 18GHz	Oct. 05, 2020	Oct. 04, 2021	Radiation (03CH03-CB)
RF Cable-high	Woken	RG402	High Cable-40G#1	18GHz ~ 40 GHz	Jul. 16, 2020	Jul. 15, 2021	Radiation (03CH03-CB)
RF Cable-high	Woken	RG402	High Cable-40G#2	18GHz ~ 40 GHz	Jul. 16, 2020	Jul. 15, 2021	Radiation (03CH03-CB)
Test Software	SPORTON	SENSE	V5.10	-	N.C.R.	N.C.R.	Radiation (03CH03-CB)
3m Semi Anechoic Chamber VSWR	TDK	SAC-3M	03CH05-CB	1GHz ~18GHz 3m	Nov. 08, 2020	Nov. 07, 2021	Radiation (03CH05-CB)
Horn Antenna	SCHWARZBE CK	BBHA9120D	BBHA 9120 D-1291	1GHz~18GHz	Sep. 05, 2020	Sep. 04, 2021	Radiation (03CH05-CB)
Horn Antenna	Schwarzbeck	BBHA 9170	BBHA9170252	15GHz ~ 40GHz	Jul. 21, 2020	Jul. 20, 2021	Radiation (03CH05-CB)
Pre-Amplifier	EMCI	EMC12630SE	980287	1GHz – 26.5GHz	Jul. 03, 2020	Jul. 02, 2021	Radiation (03CH05-CB)
Pre-Amplifier	MITEQ	TTA1840-35-H G	1864479	18GHz ~ 40GHz	Jul. 08, 2020	Jul. 07, 2021	Radiation (03CH05-CB)
Spectrum Analyzer	R&S	FSP40	100304	9kHz ~ 40GHz	Nov. 10, 2020	Nov. 09, 2021	Radiation (03CH05-CB)
RF Cable-high	Woken	RG402	High Cable-28	1GHz~18GHz	Oct. 05, 2020	Oct. 04, 2021	Radiation (03CH05-CB)
RF Cable-high	Woken	RG402	High Cable-04+28	1GHz~18GHz	Oct. 05, 2020	Oct. 04, 2021	Radiation (03CH05-CB)
RF Cable-high	Woken	RG402	High Cable-40G#1	18GHz ~ 40 GHz	Jul. 16, 2020	Jul. 15, 2021	Radiation (03CH05-CB)
RF Cable-high	Woken	RG402	High Cable-40G#2	18GHz ~ 40 GHz	Jul. 16, 2020	Jul. 15, 2021	Radiation (03CH05-CB)
Test Software	SPORTON	SENSE	V5.10	-	N.C.R.	N.C.R.	Radiation (03CH05-CB)
Spectrum analyzer	R&S	FSV40	100979	9kHz~40GHz	May 05, 2020	May 04, 2021	Conducted (TH01-CB)



Instrument	Brand	Model No.	Serial No.	Characteristics	Calibration Date	Calibration Due Date	Remark
RF Cable-high	Woken	RG402	High Cable-06	1 GHz – 26.5 GHz	Oct. 05, 2020	Oct. 04, 2021	Conducted (TH01-CB)
RF Cable-high	Woken	RG402	High Cable-07	1 GHz –26.5 GHz	Oct. 05, 2020	Oct. 04, 2021	Conducted (TH01-CB)
RF Cable-high	Woken	RG402	High Cable-08	1 GHz –26.5 GHz	Oct. 05, 2020	Oct. 04, 2021	Conducted (TH01-CB)
RF Cable-high	Woken	RG402	High Cable-09	1 GHz –26.5 GHz	Oct. 05, 2020	Oct. 04, 2021	Conducted (TH01-CB)
RF Cable-high	Woken	RG402	High Cable-10	1 GHz –26.5 GHz	Oct. 05, 2020	Oct. 04, 2021	Conducted (TH01-CB)
RF Cable-high	Woken	RG402	High Cable-30	1 GHz –26.5 GHz	Oct. 05, 2020	Oct. 04, 2021	Conducted (TH01-CB)
Power Sensor	Agilent	E9327A	US40442088	50MHz~18GHz	Feb. 07, 2020	Feb. 06, 2021	Conducted (TH01-CB)
Power Meter	Agilent	E4416A	GB41291199	50MHz~18GHz	Feb. 07, 2020	Feb. 06, 2021	Conducted (TH01-CB)
Test Software	SPORTON	SENSE	V5.10	-	N.C.R.	N.C.R.	Conducted (TH01-CB)

Note: Calibration Interval of instruments listed above is one year.
NCR means Non-Calibration required.



AC Power Port Conducted Emission Result

Appendix A

Summary

Mode	Result	Type	Freq (Hz)	Level (dBuV)	Limit (dBuV)	Margin (dB)	Condition
Mode 1	Pass	AV	532.5k	28.85	46.00	-17.15	Neutral

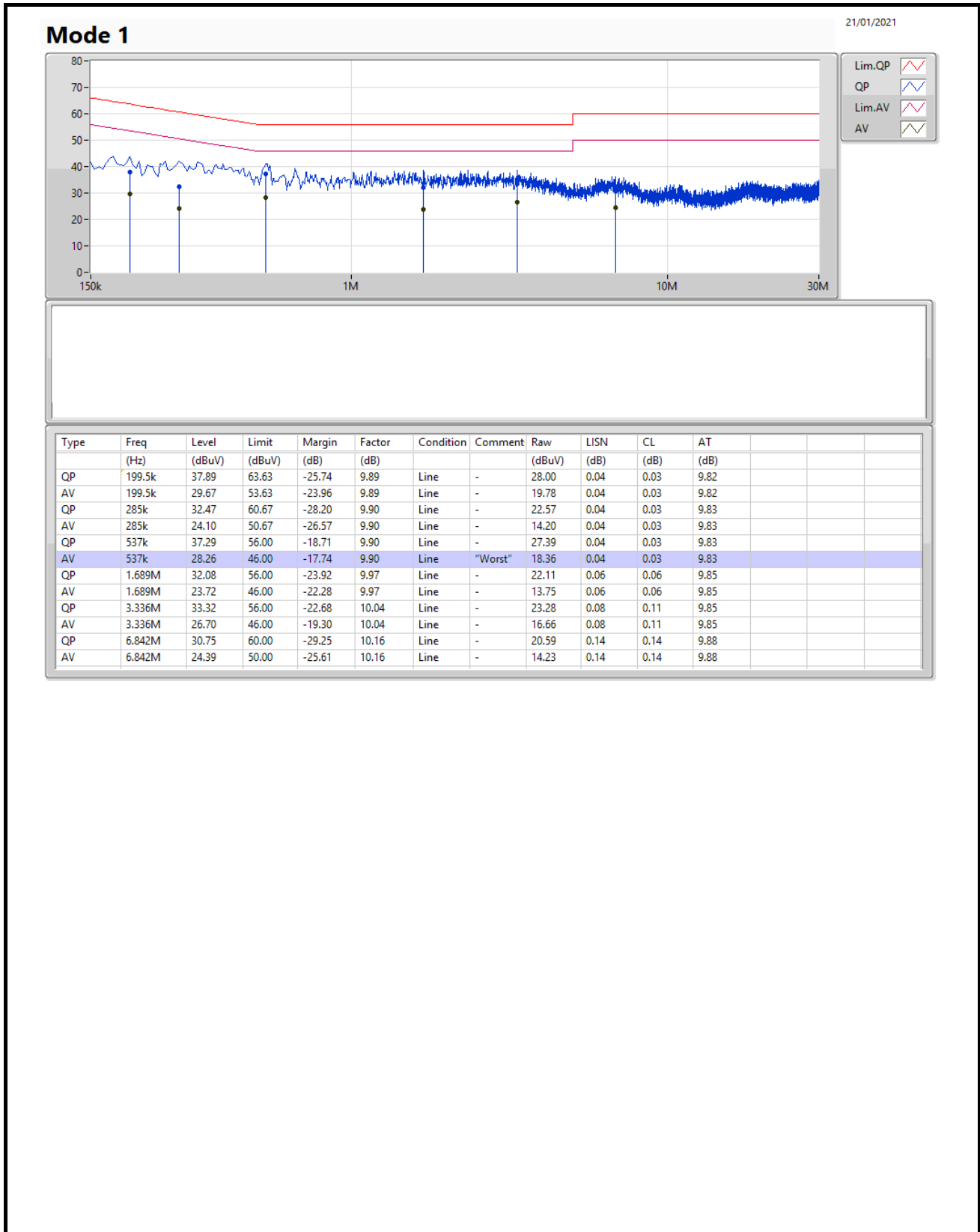

Mode 1

21/01/2021

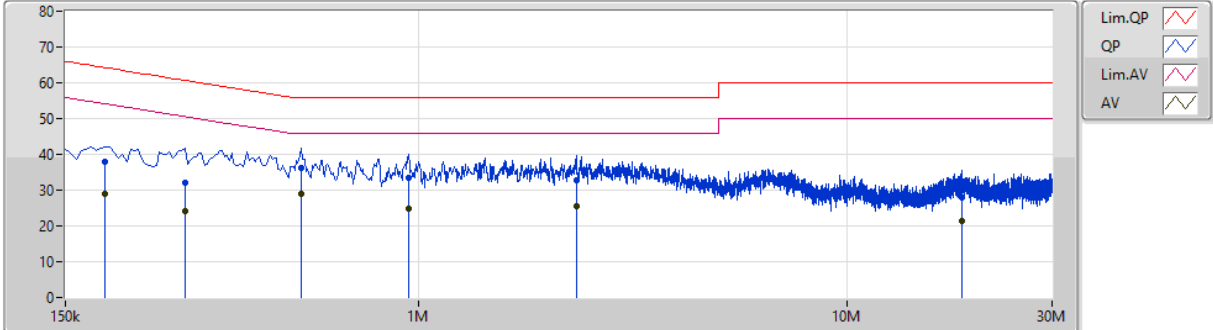

Type	Freq (Hz)	Level (dBuV)	Limit (dBuV)	Margin (dB)	Factor (dB)	Condition	Comment	Raw (dBuV)	LISN (dB)	CL (dB)	AT (dB)
QP	186k	37.94	64.20	-26.26	9.89	Neutral	-	28.05	0.04	0.03	9.82
AV	186k	29.03	54.20	-25.17	9.89	Neutral	-	19.14	0.04	0.03	9.82
QP	285k	32.23	60.67	-28.44	9.90	Neutral	-	22.33	0.04	0.03	9.83
AV	285k	23.98	50.67	-26.69	9.90	Neutral	-	14.08	0.04	0.03	9.83
QP	532.5k	36.09	56.00	-19.91	9.91	Neutral	-	26.18	0.05	0.03	9.83
AV	532.5k	28.85	46.00	-17.15	9.91	Neutral	"Worst"	18.94	0.05	0.03	9.83
QP	946.5k	33.47	56.00	-22.53	9.93	Neutral	-	23.54	0.06	0.04	9.83
AV	946.5k	24.97	46.00	-21.03	9.93	Neutral	-	15.04	0.06	0.04	9.83
QP	2.328M	32.85	56.00	-23.15	10.01	Neutral	-	22.84	0.07	0.08	9.86
AV	2.328M	25.39	46.00	-20.61	10.01	Neutral	-	15.38	0.07	0.08	9.86
QP	18.434M	27.94	60.00	-32.06	10.48	Neutral	-	17.46	0.21	0.30	9.97
AV	18.434M	21.28	50.00	-28.72	10.48	Neutral	-	10.80	0.21	0.30	9.97



Summary

Mode	Max-N dB (Hz)	Max-OBW (Hz)	ITU-Code	Min-N dB (Hz)	Min-OBW (Hz)
2.4-2.4835GHz	-	-	-	-	-
BT-LE(1Mbps)	701.25k	1.027M	1M03F1D	692.5k	1.023M

Max-N dB = Maximum 6dB down bandwidth; **Max-OBW** = Maximum 99% occupied bandwidth;
Min-N dB = Minimum 6dB down bandwidth; **Min-OBW** = Minimum 99% occupied bandwidth;



Result

Mode	Result	Limit (Hz)	Port 1-N dB (Hz)	Port 1-OBW (Hz)
BT-LE(1Mbps)	-	-	-	-
2402MHz	Pass	500k	701.25k	1.027M
2440MHz	Pass	500k	692.5k	1.023M
2480MHz	Pass	500k	692.5k	1.023M

Port X-N dB = Port X 6dB down bandwidth; Port X-OBW = Port X 99% occupied bandwidth;

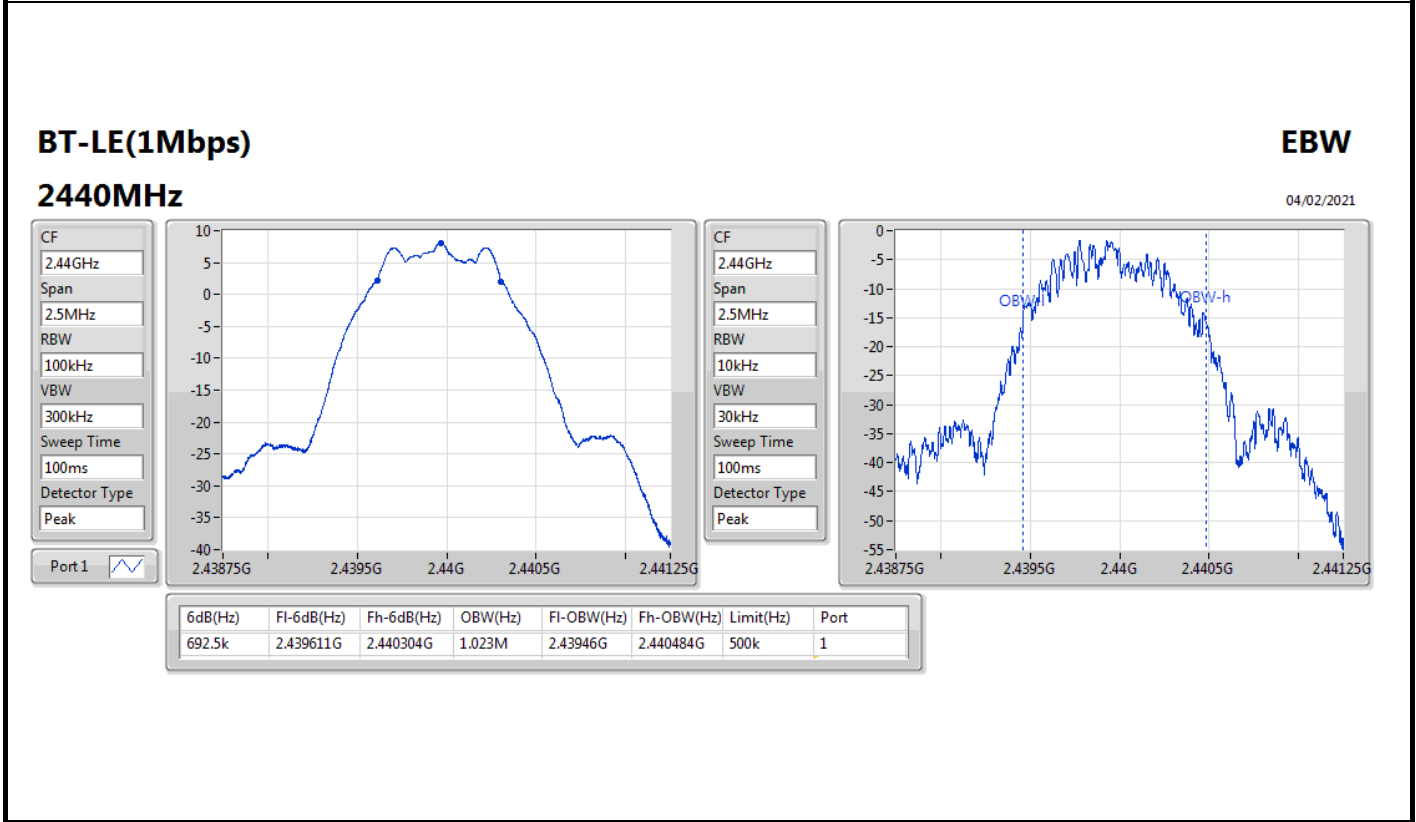
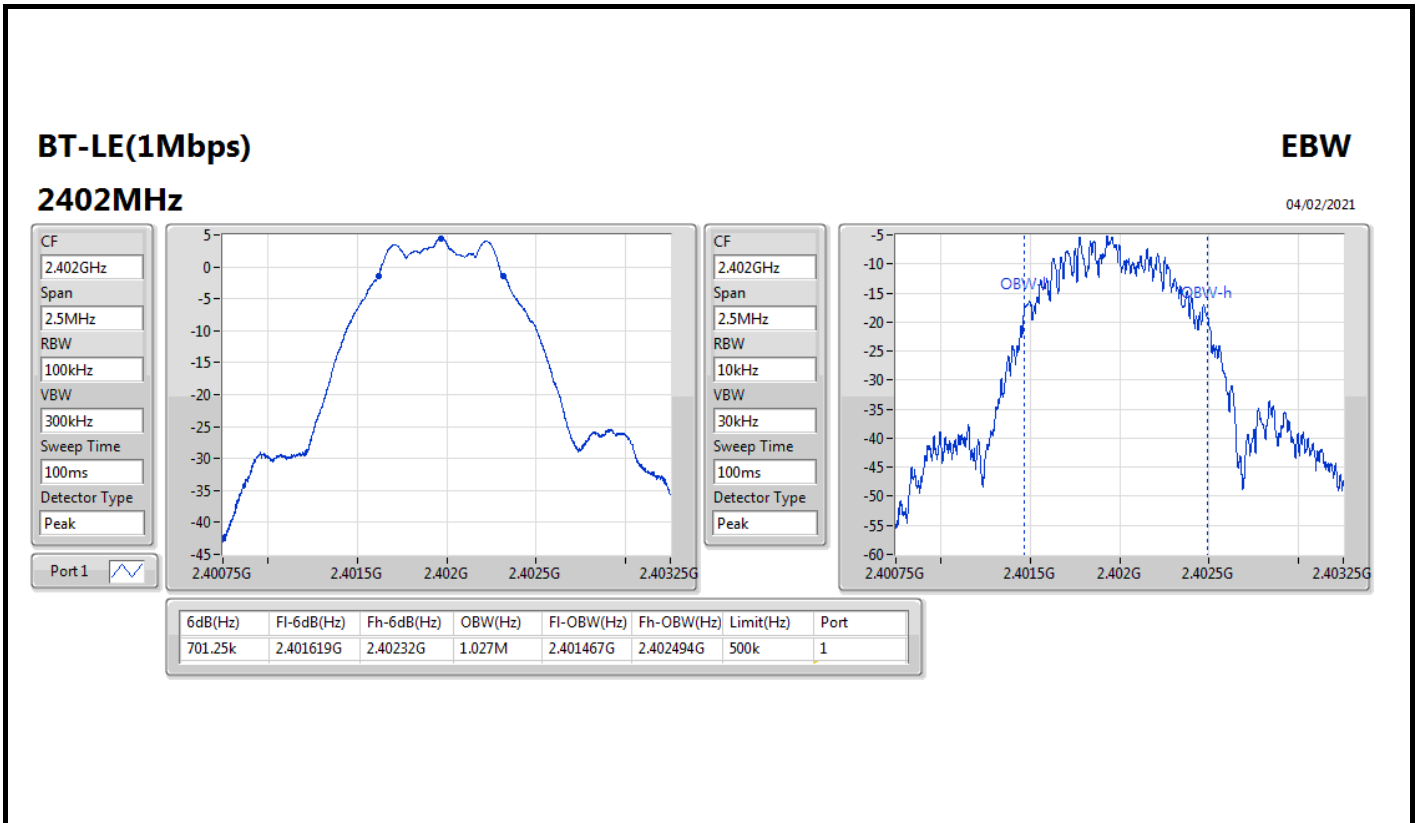

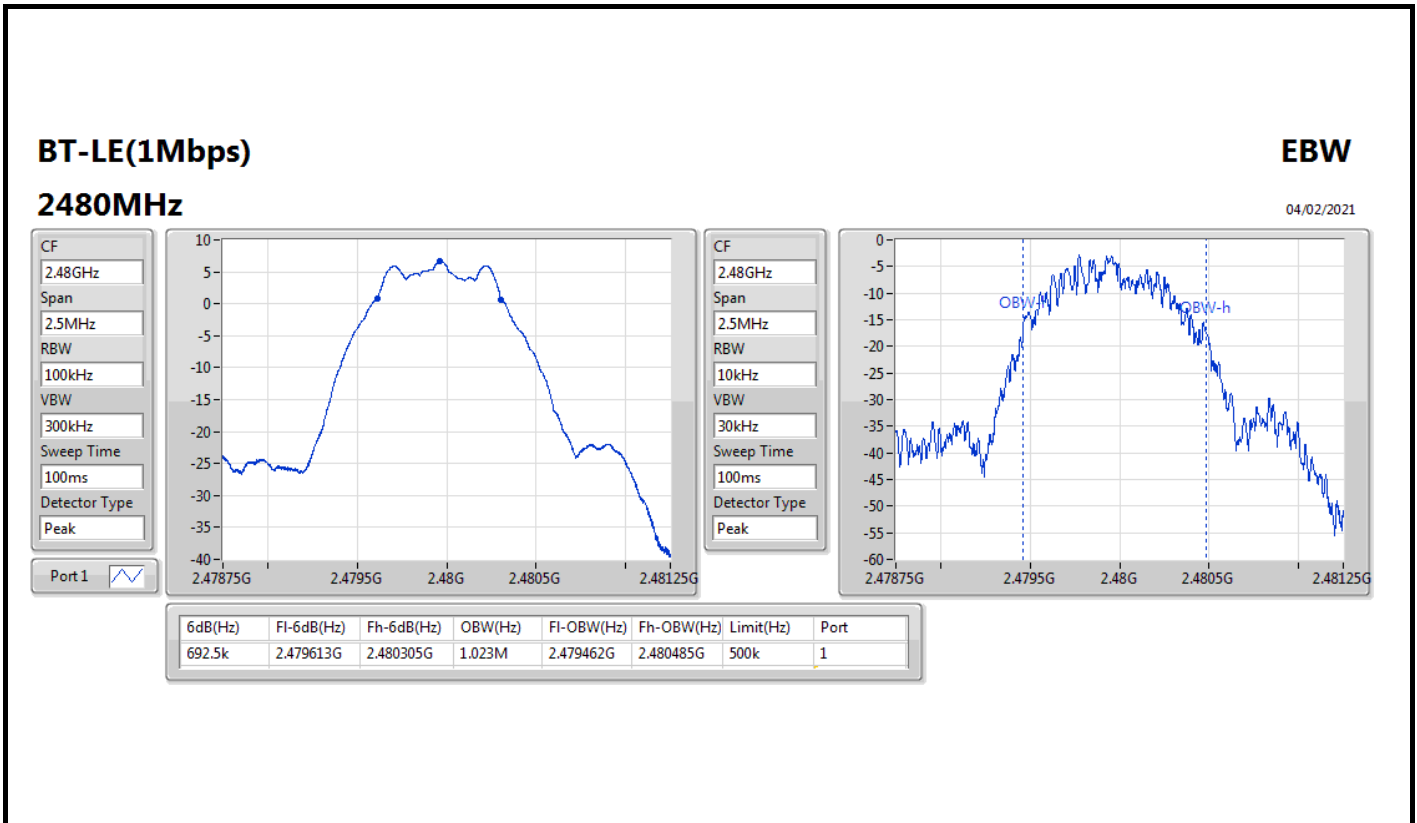



Summary

Mode	Power (dBm)	Power (W)
2.4-2.4835GHz	-	-
BT-LE(1Mbps)	8.34	0.00682



Result

Mode	Result	Gain (dBi)	Power (dBm)	Power Limit (dBm)
BT-LE(1Mbps)	-	-	-	-
2402MHz	Pass	1.50	4.79	30.00
2440MHz	Pass	1.50	8.34	30.00
2480MHz	Pass	1.50	6.94	30.00

DG = Directional Gain; **Port X** = Port X output power



Summary

Mode	PD (dBm/RBW)
2.4-2.4835GHz	-
BT-LE(1Mbps)	-7.52

RBW=3 kHz.



Result

Mode	Result	Gain (dBi)	PD (dBm/RBW)	PD Limit (dBm/RBW)
BT-LE(1Mbps)	-	-	-	-
2402MHz	Pass	1.50	-11.18	8.00
2440MHz	Pass	1.50	-7.52	8.00
2480MHz	Pass	1.50	-9.37	8.00

DG = Directional Gain; RBW=3 kHz;

PD = trace bin-by-bin of each transmits port summing can be performed maximum power density; Port X = Port X power density;

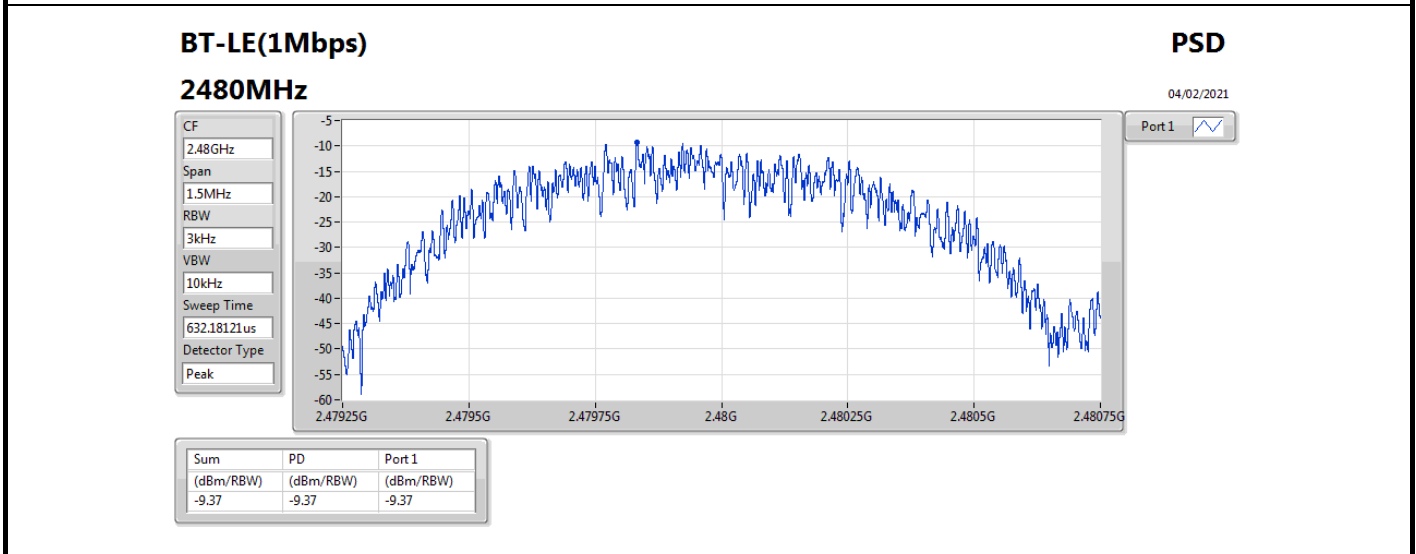
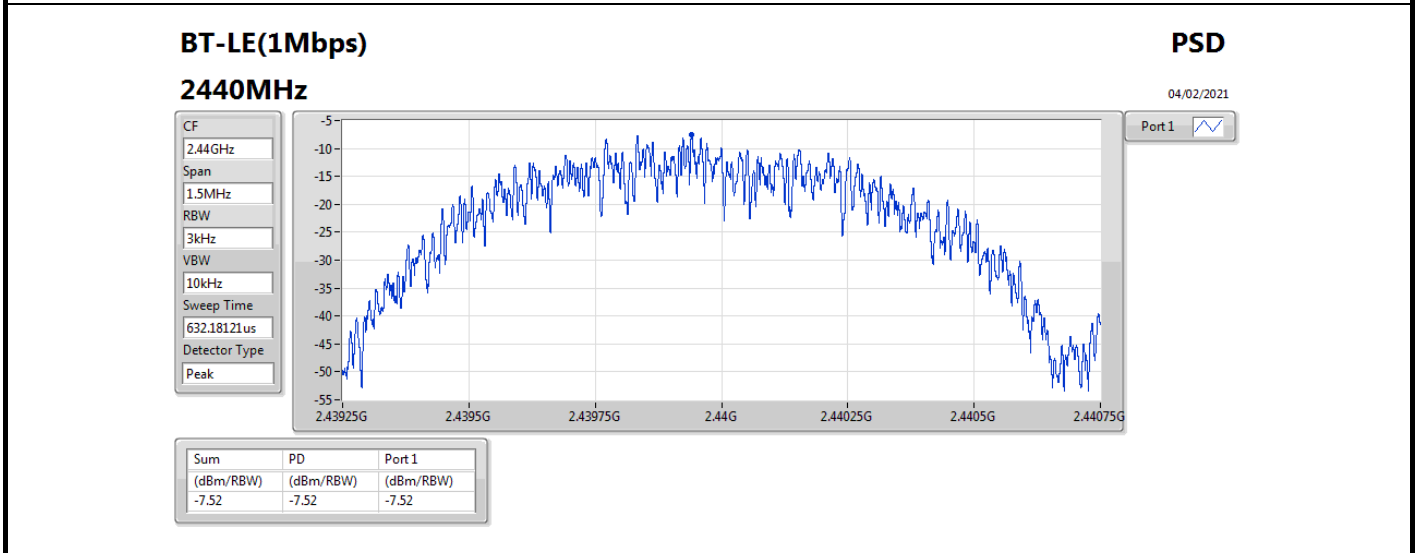
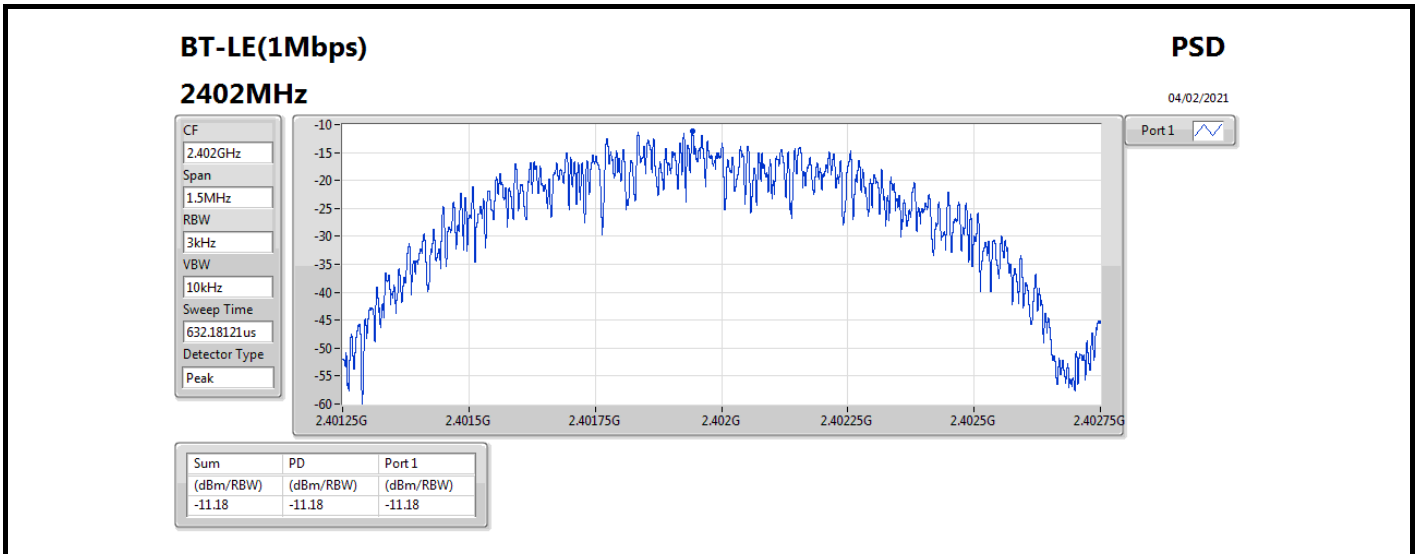



Summary

Mode	Result	Ref (Hz)	Ref (dBm)	Limit (dBm)	Freq (Hz)	Level (dBm)	Freq (Hz)	Level (dBm)	Freq (Hz)	Level (dBm)	Freq (Hz)	Level (dBm)	Freq (Hz)	Level (dBm)	Port
2.4-2.4835GHz	-	-	-	-	-	-	-	-	-	-	-	-	-	-	-
BT-LE(1Mbps)	Pass	2.43995G	7.85	-22.15	2.30509G	-53.76	2.39999G	-43.41	2.4G	-44.81	2.49918G	-52.41	16.52163G	-46.32	1



Result

Mode	Result	Ref (Hz)	Ref (dBm)	Limit (dBm)	Freq (Hz)	Level (dBm)	Freq (Hz)	Level (dBm)	Freq (Hz)	Level (dBm)	Freq (Hz)	Level (dBm)	Freq (Hz)	Level (dBm)	Port
BT-LE(1Mbps)	-	-	-	-	-	-	-	-	-	-	-	-	-	-	-
2402MHz	Pass	2.43995G	7.85	-22.15	2.30509G	-53.76	2.39999G	-43.41	2.4G	-44.81	2.49918G	-52.41	16.52163G	-46.32	1
2440MHz	Pass	2.43995G	7.85	-22.15	849.56M	-53.92	2.39929G	-52.75	2.4835G	-53.91	2.49479G	-51.97	16.49632G	-46.77	1
2480MHz	Pass	2.43995G	7.85	-22.15	924.18M	-53.83	2.39211G	-52.63	2.4835G	-47.31	2.48351G	-47.83	16.34728G	-46.51	1

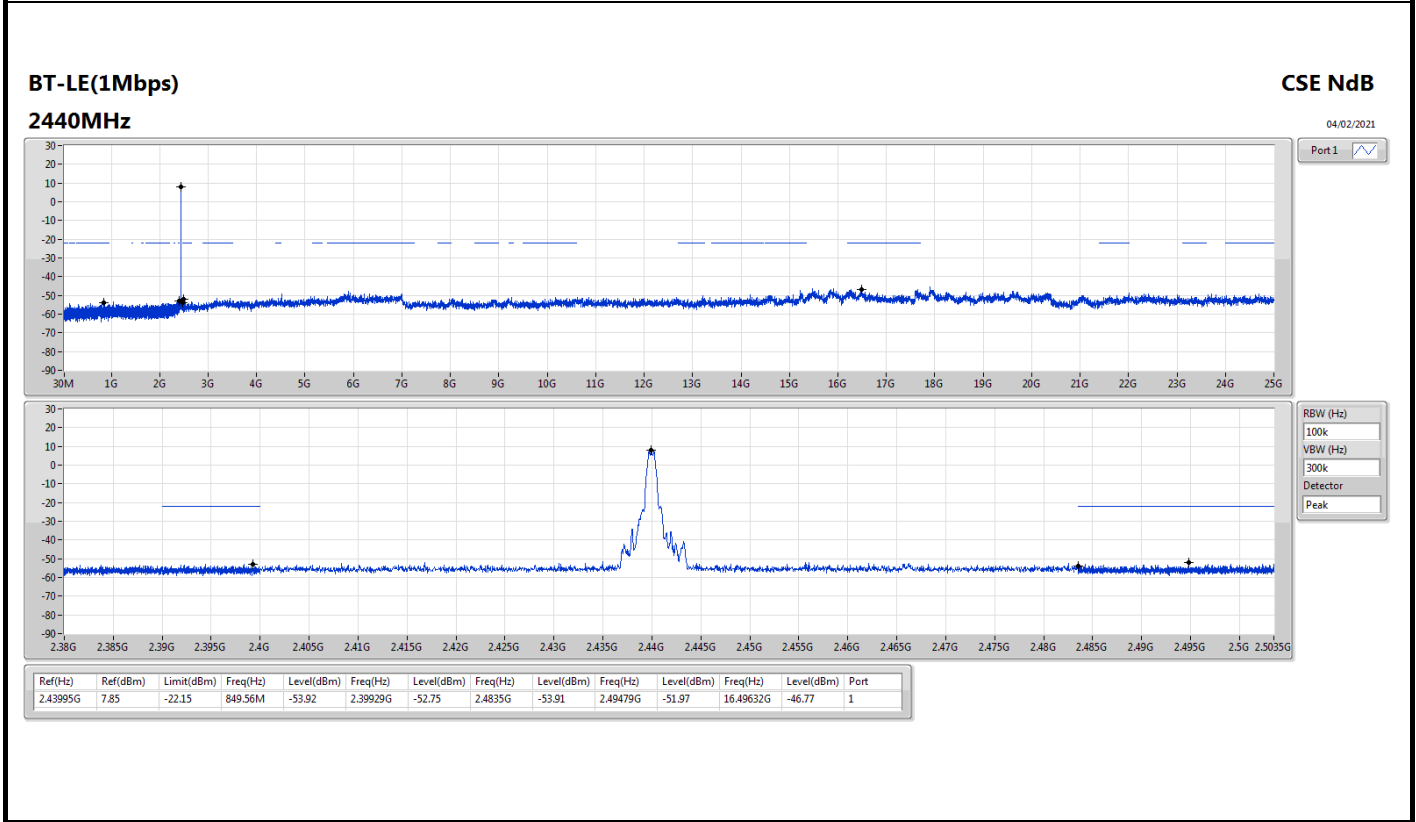
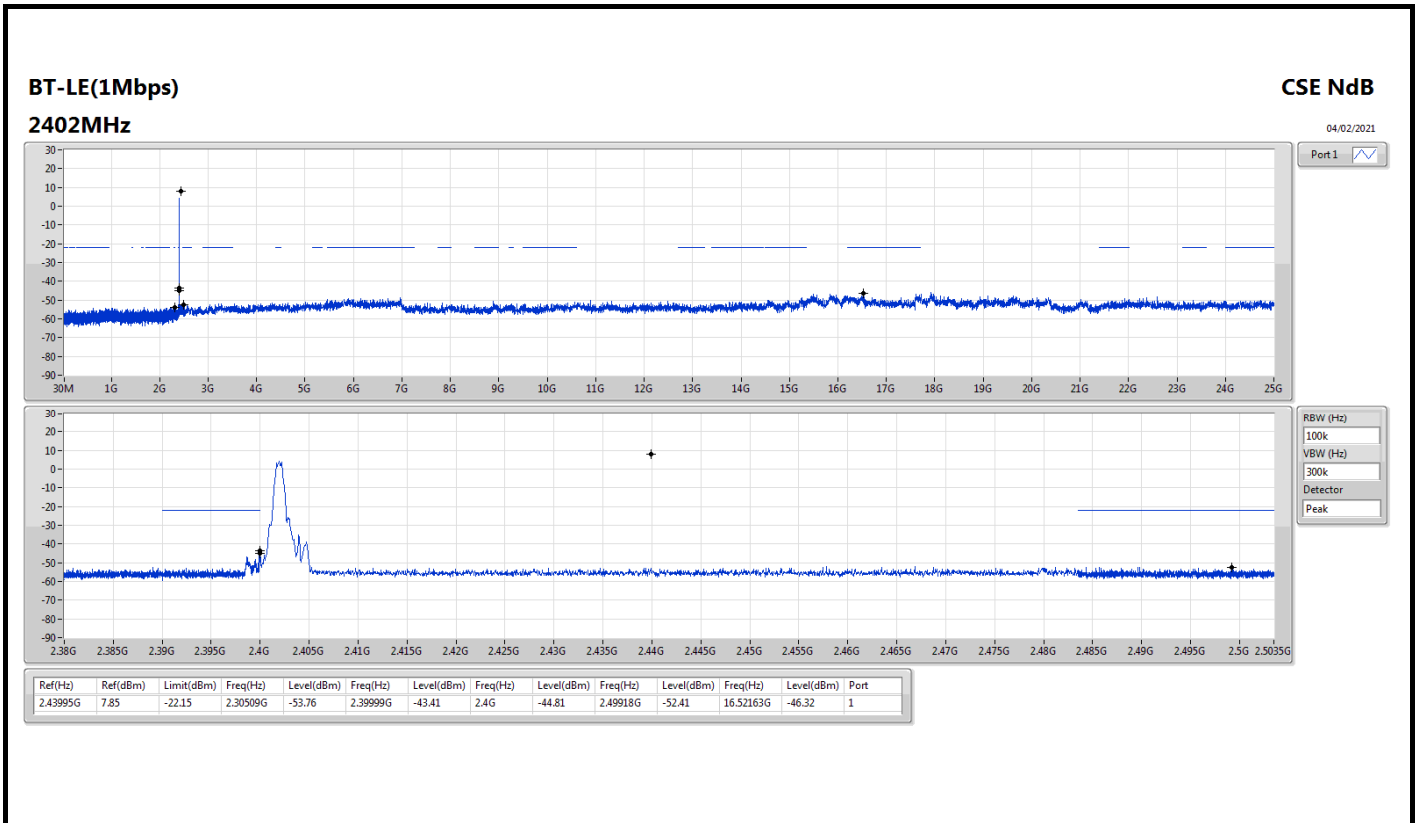

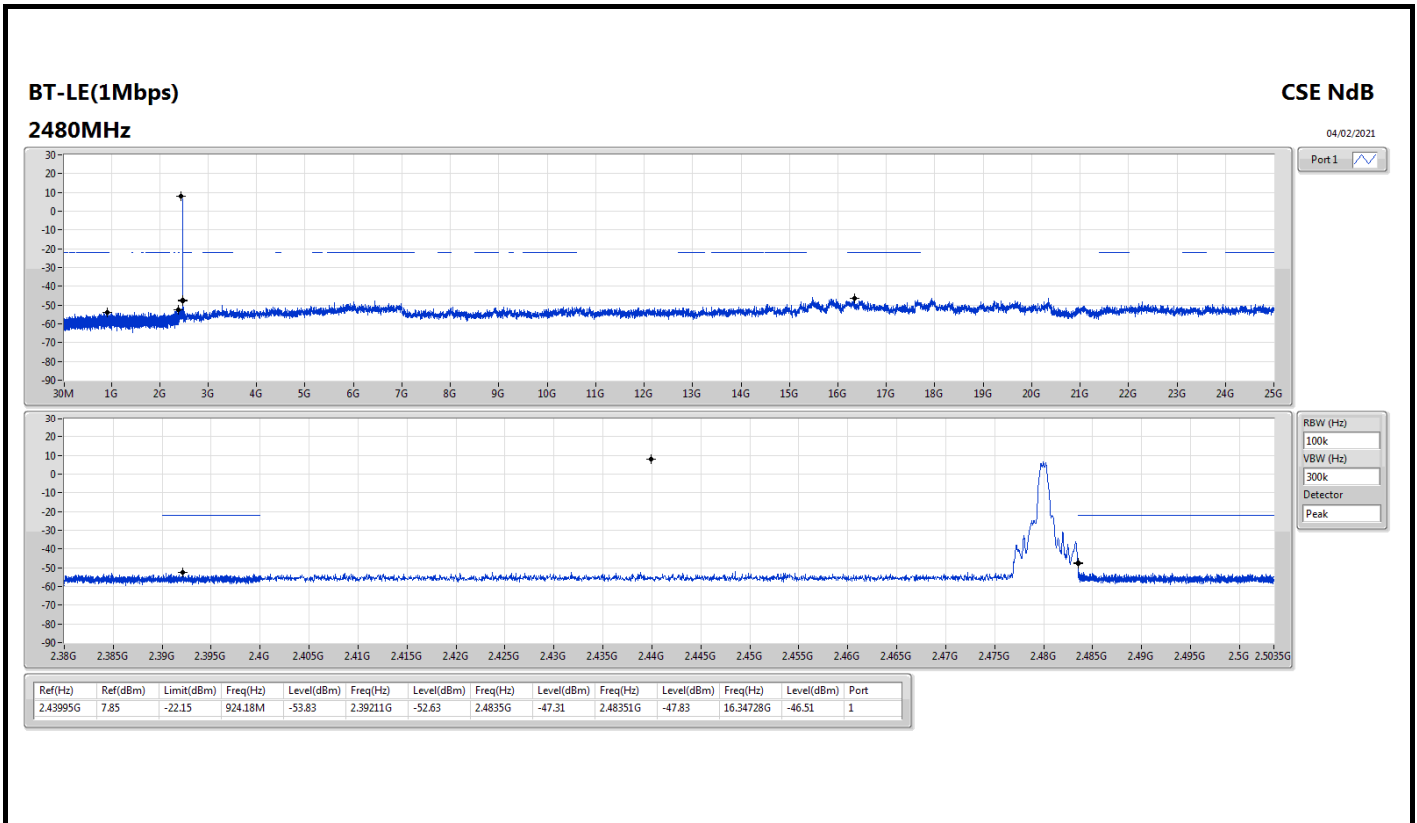



Summary

Mode	Result	Type	Freq (Hz)	Level (dBuV/m)	Limit (dBuV/m)	Margin (dB)	Condition
Mode 3	Pass	PK	35.82M	33.54	40.00	-6.46	Vertical

Mode 3

06/02/2021

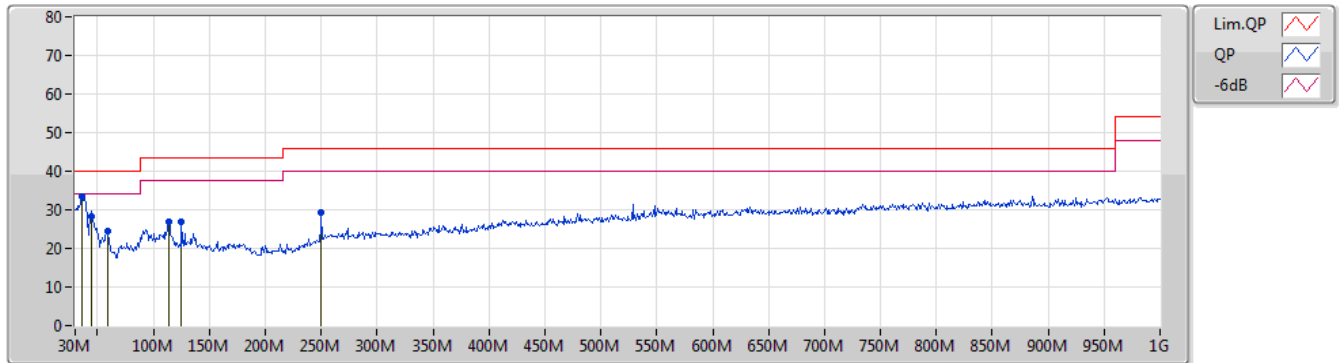

Type	Freq (Hz)	Level (dBuV/m)	Limit (dBuV/m)	Margin (dB)	Factor (dB)	Dist (m)	Condition	Azimuth (°)	Height (m)	Comment	Raw (dBuV/m)	AF (dB/m)	CL (dB)	PA (dB)
PK	35.82M	33.54	40.00	-6.46	-6.92	3	Vertical	360	1.25	"Worst"	40.46	21.34	0.22	28.48
PK	44.55M	28.30	40.00	-11.70	-11.12	3	Vertical	360	1.25	-	39.42	16.97	0.39	28.48
PK	59.1M	24.57	40.00	-15.43	-15.33	3	Vertical	278	1.00	-	39.90	12.67	0.48	28.48
PK	113.42M	26.91	43.50	-16.59	-9.77	3	Vertical	210	1.00	-	36.68	17.78	0.83	28.38
PK	125.06M	26.86	43.50	-16.64	-9.48	3	Vertical	154	1.00	-	36.34	17.91	0.95	28.34
PK	250.19M	29.40	46.00	-16.60	-7.83	3	Vertical	167	2.00	-	37.23	18.46	1.50	27.79

06/02/2021

Mode 3

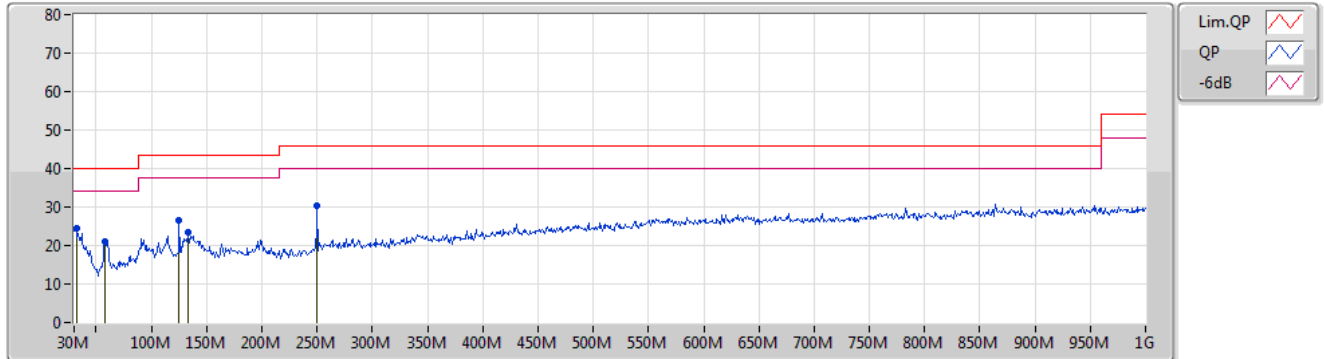

Type	Freq (Hz)	Level (dBuV/m)	Limit (dBuV/m)	Margin (dB)	Factor (dB)	Dist (m)	Condition	Azimuth (°)	Height (m)	Comment	Raw (dBuV/m)	AF (dB/m)	CL (dB)	PA (dB)
PK	31.94M	24.61	40.00	-15.39	-4.86	3	Horizontal	352	2.00	"Worst"	29.47	23.43	0.20	28.49
PK	58.13M	21.20	40.00	-18.80	-15.37	3	Horizontal	292	2.00	-	36.57	12.65	0.46	28.48
PK	125.06M	26.44	43.50	-17.06	-9.48	3	Horizontal	112	2.00	-	35.92	17.91	0.95	28.34
PK	133.79M	23.47	43.50	-20.03	-9.72	3	Horizontal	272	2.00	-	33.19	17.55	1.04	28.31
PK	250.19M	30.22	46.00	-15.78	-7.83	3	Horizontal	109	1.00	-	38.05	18.46	1.50	27.79
PK	250.19M	30.22	46.00	-15.78	-7.83	3	Horizontal	109	1.00	-	38.05	18.46	1.50	27.79



Summary

Mode	Result	Type	Freq (Hz)	Level (dBuV/m)	Limit (dBuV/m)	Margin (dB)	Dist (m)	Condition	Azimuth (°)	Height (m)	Comments
2.4-2.4835GHz	-	-	-	-	-	-	-	-	-	-	-
BT-LE(1Mbps)	Pass	AV	2.4835G	47.24	54.00	-6.76	3	Horizontal	240	2.58	-

BT-LE(1Mbps)

03/02/2021

2402MHz_TX

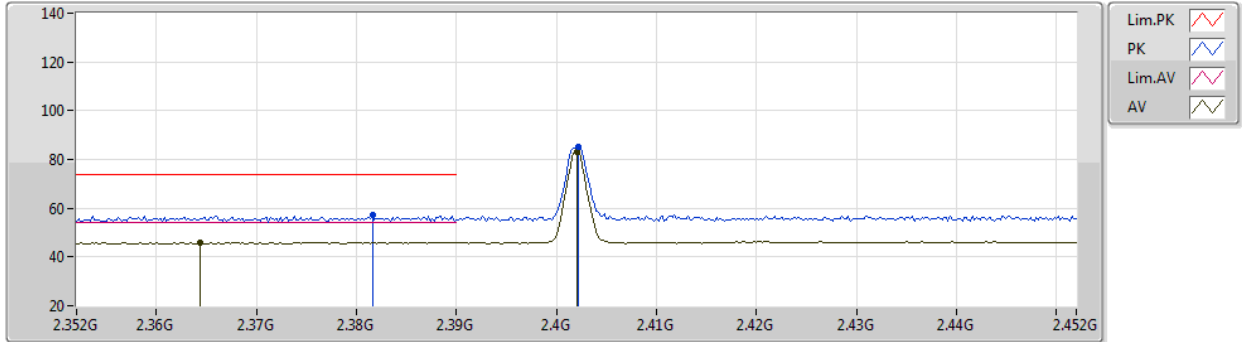

EUT Z_1TX
Setting 10
03-F-K-4

Type	Freq (Hz)	Level (dBuV/m)	Limit (dBuV/m)	Margin (dB)	Raw (dBuV)	Dist (m)	Condition	Azimuth (°)	Height (m)	Comment	AF (dB)	CL (dB)	PA (dB)
PK	2.3816G	57.07	74.00	-16.93	24.26	3	Vertical	341	2.94	-	29.33	3.48	-
AV	2.3644G	45.94	54.00	-8.06	13.22	3	Vertical	341	2.94	-	29.26	3.46	-
PK	2.4022G	85.20	Inf	-Inf	52.30	3	Vertical	341	2.94	-	29.40	3.50	-
AV	2.402G	83.35	Inf	-Inf	50.45	3	Vertical	341	2.94	-	29.40	3.50	-

BT-LE(1Mbps)

03/02/2021

2402MHz_TX

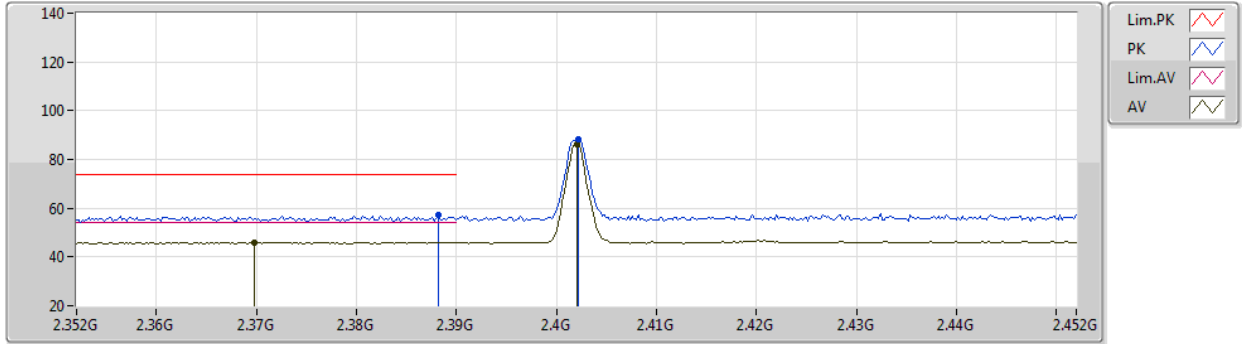

EUT Z_1TX
Setting 10
03-F-K-4

Type	Freq (Hz)	Level (dBuV/m)	Limit (dBuV/m)	Margin (dB)	Raw (dBuV)	Dist (m)	Condition	Azimuth (°)	Height (m)	Comment	AF (dB)	CL (dB)	PA (dB)
PK	2.3882G	57.03	74.00	-16.97	24.19	3	Horizontal	233	2.73	-	29.35	3.49	-
AV	2.3698G	46.01	54.00	-7.99	13.26	3	Horizontal	233	2.73	-	29.28	3.47	-
PK	2.4022G	88.19	Inf	-Inf	55.29	3	Horizontal	233	2.73	-	29.40	3.50	-
AV	2.402G	86.25	Inf	-Inf	53.35	3	Horizontal	233	2.73	-	29.40	3.50	-



BT-LE(1Mbps)

03/02/2021

2402MHz_TX

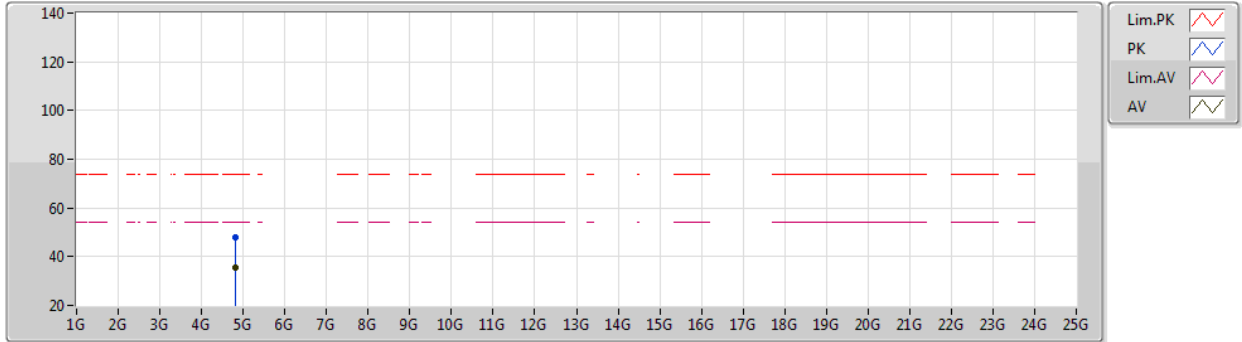

EUT Z_1TX
 Setting 10
 03-F-K-4

Type	Freq (Hz)	Level (dBuV/m)	Limit (dBuV/m)	Margin (dB)	Raw (dBuV)	Dist (m)	Condition	Azimuth (°)	Height (m)	Comment	AF (dB)	CL (dB)	PA (dB)
PK	4.80166G	47.77	74.00	-26.23	43.44	3	Vertical	133	1.00	-	33.41	6.20	35.28
AV	4.80384G	35.67	54.00	-18.33	31.32	3	Vertical	133	1.00	-	33.42	6.21	35.28



BT-LE(1Mbps)

03/02/2021

2402MHz_TX

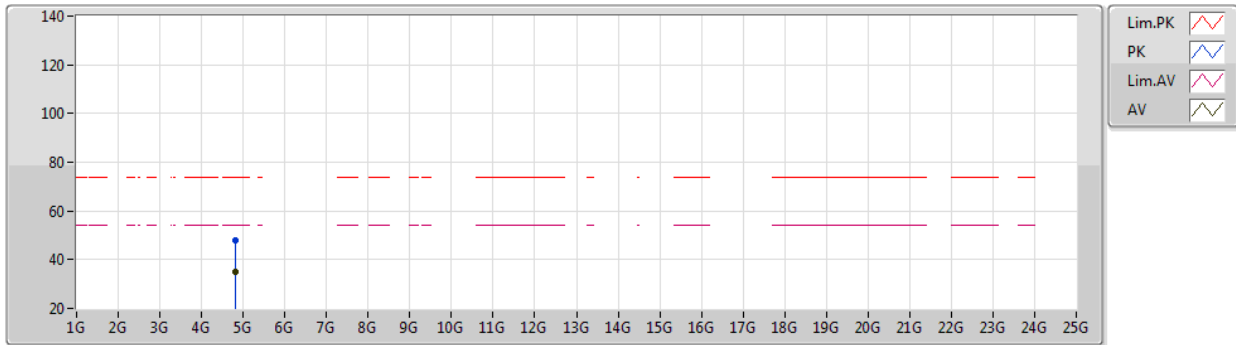

EUT Z_1TX
Setting 10
03-F-K-4

Type	Freq (Hz)	Level (dBuV/m)	Limit (dBuV/m)	Margin (dB)	Raw (dBuV)	Dist (m)	Condition	Azimuth (°)	Height (m)	Comment	AF (dB)	CL (dB)	PA (dB)
PK	4.80323G	47.74	74.00	-26.26	43.40	3	Horizontal	17	1.27	-	33.42	6.20	35.28
AV	4.80202G	35.25	54.00	-18.75	30.92	3	Horizontal	17	1.27	-	33.41	6.20	35.28

BT-LE(1Mbps)

03/02/2021

2440MHz_TX

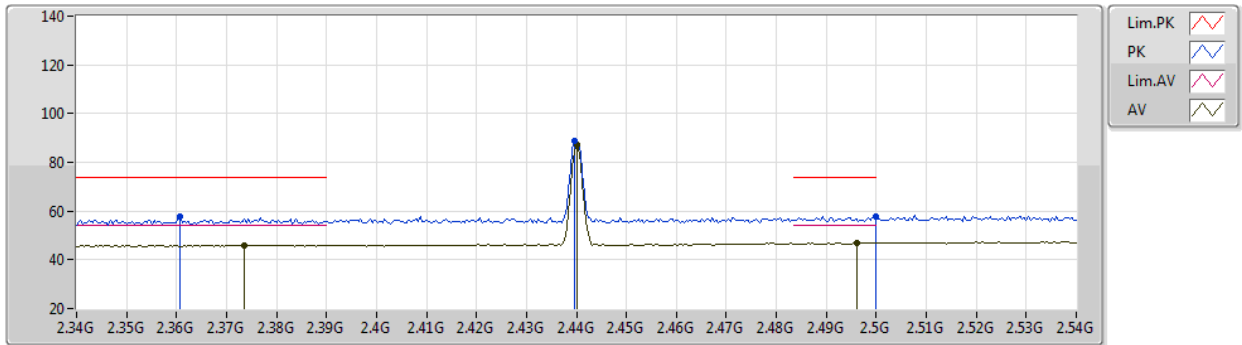

EUT Z_1TX
Setting 10
03-F-K-4

Type	Freq (Hz)	Level (dBuV/m)	Limit (dBuV/m)	Margin (dB)	Raw (dBuV)	Dist (m)	Condition	Azimuth (°)	Height (m)	Comment	AF (dB)	CL (dB)	PA (dB)
PK	2.3608G	57.76	74.00	-16.24	25.06	3	Vertical	137	2.92	-	29.24	3.46	-
AV	2.3736G	46.09	54.00	-7.91	13.33	3	Vertical	137	2.92	-	29.29	3.47	-
PK	2.4396G	88.67	Inf	-Inf	55.65	3	Vertical	137	2.92	-	29.48	3.54	-
AV	2.44G	87.12	Inf	-Inf	54.10	3	Vertical	137	2.92	-	29.48	3.54	-
PK	2.5G	57.98	74.00	-16.02	24.18	3	Vertical	137	2.92	-	30.20	3.60	-
AV	2.496G	47.05	54.00	-6.95	13.31	3	Vertical	137	2.92	-	30.14	3.60	-

BT-LE(1Mbps)

03/02/2021

2440MHz_TX

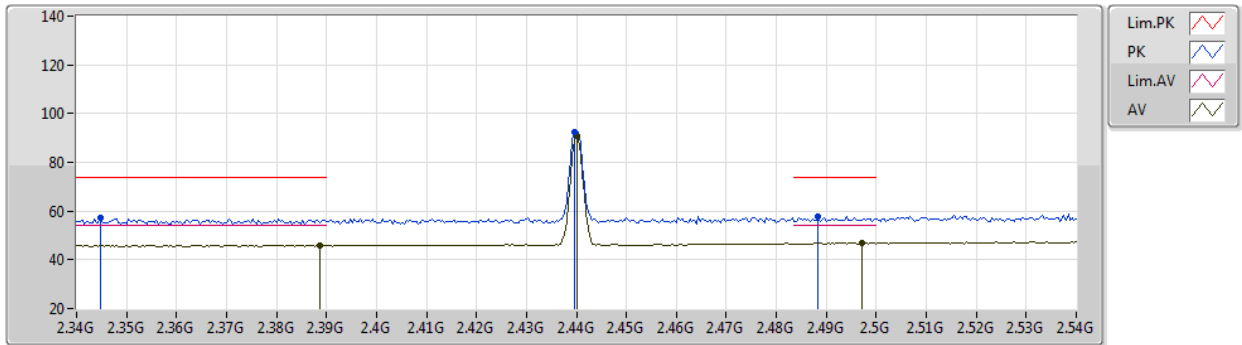

EUT Z_1TX
Setting 10
03-F-K-4

Type	Freq (Hz)	Level (dBuV/m)	Limit (dBuV/m)	Margin (dB)	Raw (dBuV)	Dist (m)	Condition	Azimuth (°)	Height (m)	Comment	AF (dB)	CL (dB)	PA (dB)
PK	2.3448G	56.99	74.00	-17.01	24.34	3	Horizontal	215	3.00	-	29.21	3.44	-
AV	2.3888G	46.09	54.00	-7.91	13.24	3	Horizontal	215	3.00	-	29.36	3.49	-
PK	2.4396G	92.39	Inf	-Inf	59.37	3	Horizontal	215	3.00	-	29.48	3.54	-
AV	2.44G	90.82	Inf	-Inf	57.80	3	Horizontal	215	3.00	-	29.48	3.54	-
PK	2.4884G	57.81	74.00	-16.19	24.18	3	Horizontal	215	3.00	-	30.04	3.59	-
AV	2.4972G	47.15	54.00	-6.85	13.39	3	Horizontal	215	3.00	-	30.16	3.60	-



BT-LE(1Mbps)

03/02/2021

2440MHz_TX

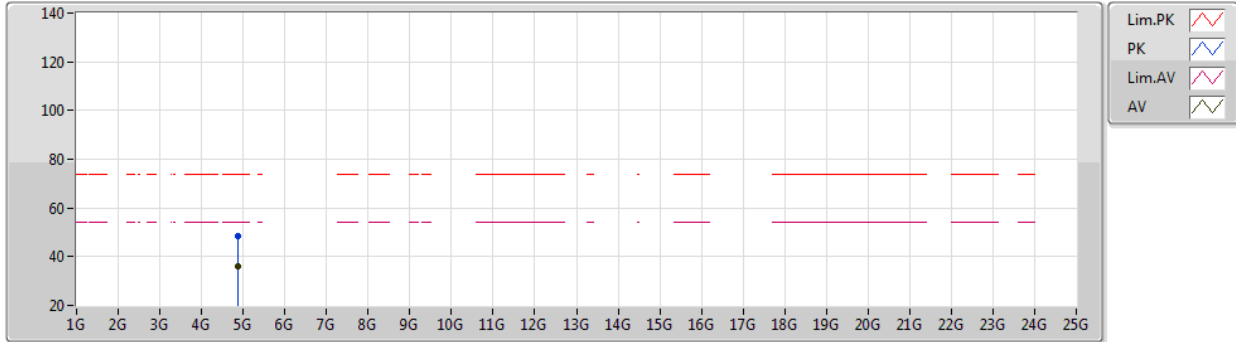

EUT Z_1TX
Setting 10
03-F-K-4

Type	Freq (Hz)	Level (dBuV/m)	Limit (dBuV/m)	Margin (dB)	Raw (dBuV)	Dist (m)	Condition	Azimuth (°)	Height (m)	Comment	AF (dB)	CL (dB)	PA (dB)
PK	4.88047G	48.34	74.00	-25.66	43.56	3	Vertical	131	1.20	-	33.82	6.32	35.36
AV	4.87958G	36.20	54.00	-17.80	31.42	3	Vertical	131	1.20	-	33.82	6.32	35.36

BT-LE(1Mbps)

03/02/2021

2440MHz_TX

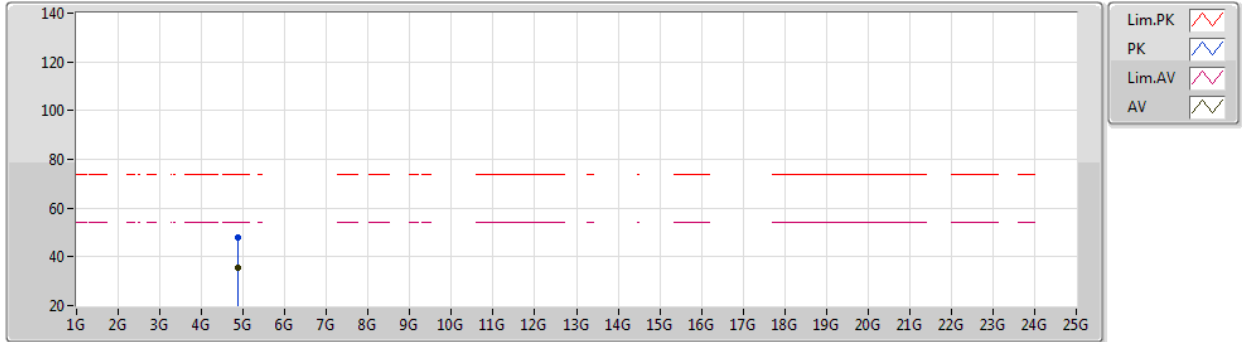

EUT Z_1TX
Setting 10
03-F-K-4

Type	Freq (Hz)	Level (dBuV/m)	Limit (dBuV/m)	Margin (dB)	Raw (dBuV)	Dist (m)	Condition	Azimuth (°)	Height (m)	Comment	AF (dB)	CL (dB)	PA (dB)
PK	4.87899G	47.93	74.00	-26.07	43.15	3	Horizontal	6	1.01	-	33.82	6.32	35.36
AV	4.87943G	35.67	54.00	-18.33	30.89	3	Horizontal	6	1.01	-	33.82	6.32	35.36

BT-LE(1Mbps)

03/02/2021

2480MHz_TX

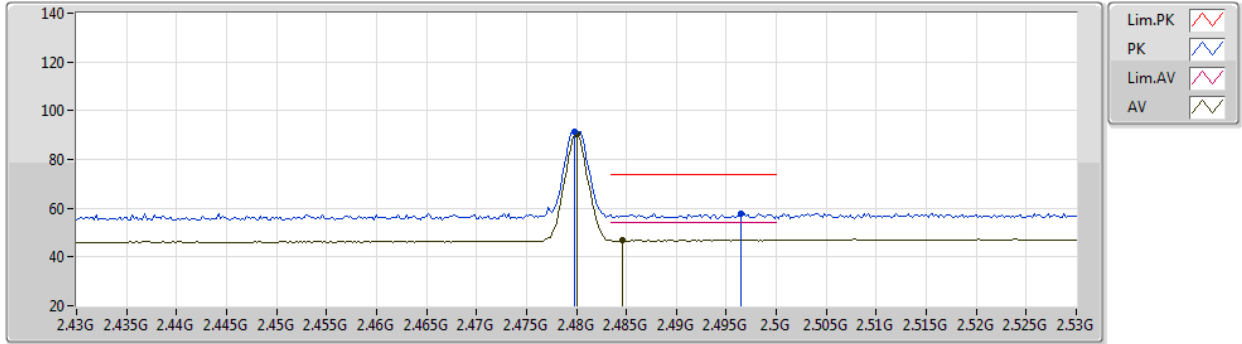

EUT Z_1TX
Setting 10
03-F-K-4

Type	Freq (Hz)	Level (dBuV/m)	Limit (dBuV/m)	Margin (dB)	Raw (dBuV)	Dist (m)	Condition	Azimuth (°)	Height (m)	Comment	AF (dB)	CL (dB)	PA (dB)
PK	2.4798G	91.56	Inf	-Inf	58.06	3	Vertical	255	2.22	-	29.92	3.58	-
AV	2.48G	90.12	Inf	-Inf	56.62	3	Vertical	255	2.22	-	29.92	3.58	-
PK	2.4964G	57.76	74.00	-16.24	24.01	3	Vertical	255	2.22	-	30.15	3.60	-
AV	2.4846G	47.08	54.00	-6.92	13.52	3	Vertical	255	2.22	-	29.98	3.58	-

BT-LE(1Mbps)

03/02/2021

2480MHz_TX

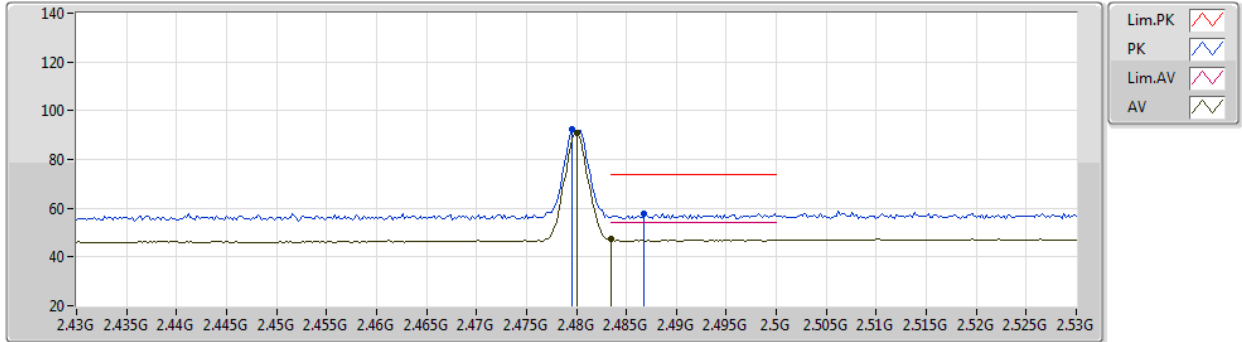

EUT Z_1TX
Setting 10
03-F-K-4

Type	Freq (Hz)	Level (dBuV/m)	Limit (dBuV/m)	Margin (dB)	Raw (dBuV)	Dist (m)	Condition	Azimuth (°)	Height (m)	Comment	AF (dB)	CL (dB)	PA (dB)
PK	2.4796G	92.16	Inf	-Inf	58.67	3	Horizontal	240	2.58	-	29.91	3.58	-
AV	2.48G	90.70	Inf	-Inf	57.20	3	Horizontal	240	2.58	-	29.92	3.58	-
PK	2.4868G	57.76	74.00	-16.24	24.15	3	Horizontal	240	2.58	-	30.02	3.59	-
AV	2.4835G	47.24	54.00	-6.76	13.69	3	Horizontal	240	2.58	-	29.97	3.58	-

BT-LE(1Mbps)

03/02/2021

2480MHz_TX

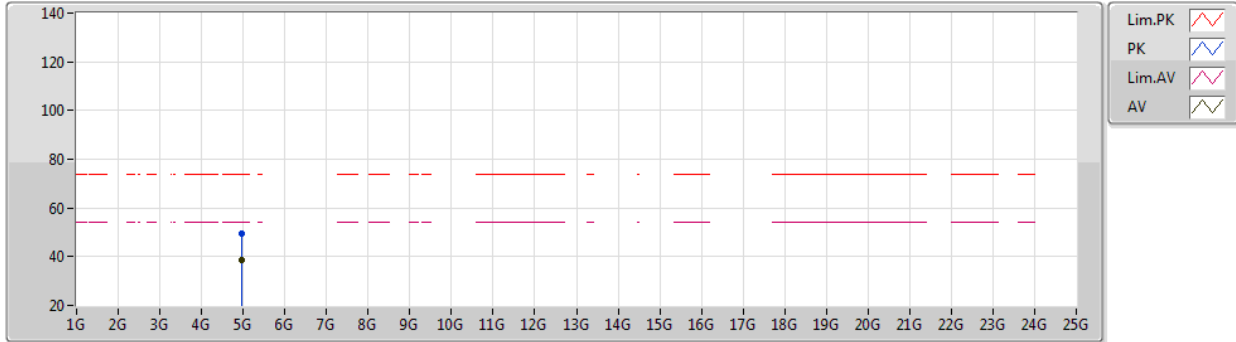

EUT Z_1TX
Setting 10
03-F-K-4

Type	Freq (Hz)	Level (dBuV/m)	Limit (dBuV/m)	Margin (dB)	Raw (dBuV)	Dist (m)	Condition	Azimuth (°)	Height (m)	Comment	AF (dB)	CL (dB)	PA (dB)
PK	4.9596G	49.36	74.00	-24.64	44.37	3	Vertical	132	1.02	-	34.00	6.44	35.45
AV	4.95948G	38.80	54.00	-15.20	33.81	3	Vertical	132	1.02	-	34.00	6.44	35.45

BT-LE(1Mbps)

03/02/2021

2480MHz_TX

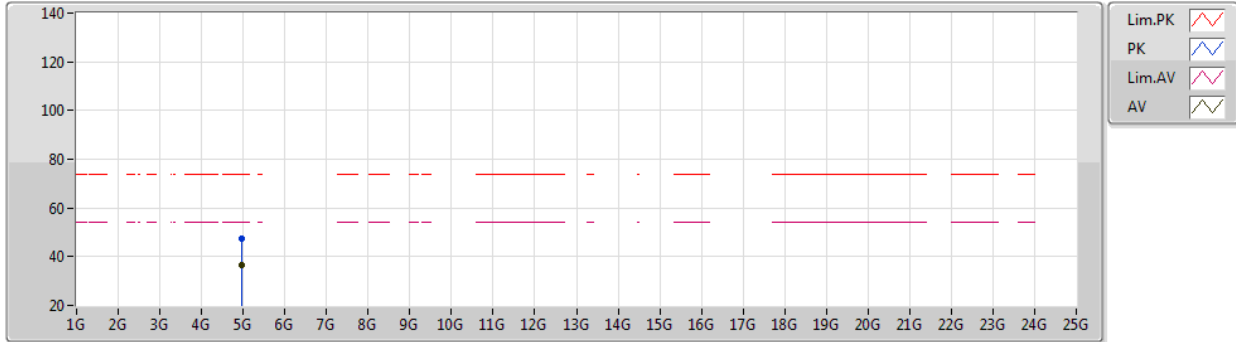

EUT Z_1TX
Setting 10
03-F-K-4

Type	Freq (Hz)	Level (dBuV/m)	Limit (dBuV/m)	Margin (dB)	Raw (dBuV)	Dist (m)	Condition	Azimuth (°)	Height (m)	Comment	AF (dB)	CL (dB)	PA (dB)
PK	4.95968G	47.63	74.00	-26.37	42.64	3	Horizontal	285	2.49	-	34.00	6.44	35.45
AV	4.95938G	36.53	54.00	-17.47	31.54	3	Horizontal	285	2.49	-	34.00	6.44	35.45



Summary

Mode	Result	Type	Freq (Hz)	Level (dBuV/m)	Limit (dBuV/m)	Margin (dB)	Condition
Mode 1	Pass	AV	3.68737G	37.12	54.00	-16.88	Vertical

03/02/2021

Mode 1

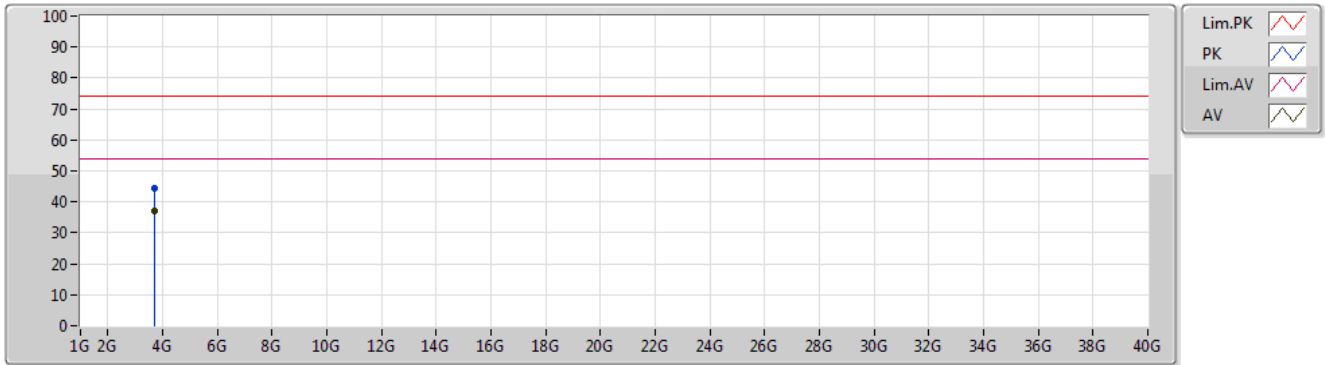



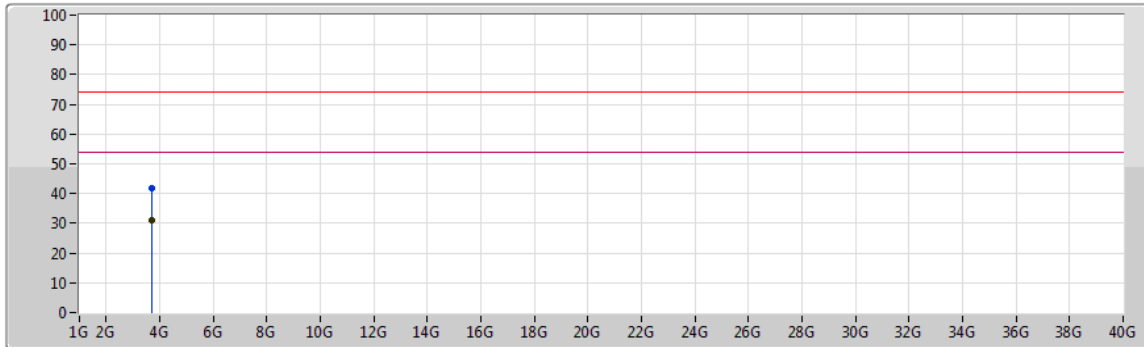

Type	Freq	Level	Limit	Margin	Factor	Dist	Condition	Azimuth	Height	Comment	Raw	AF	CL	PA
	(Hz)	(dBuV/m)	(dBuV/m)	(dB)	(dB)	(m)		(°)	(m)		(dBuV)	(dB)	(dB)	(dB)
PK	3.6875G	44.33	74.00	-29.67	-1.68	3	Vertical	337	2.88	-	46.01	29.20	5.13	36.01
AV	3.68737G	37.12	54.00	-16.88	-1.68	3	Vertical	337	2.88	"Worst"	38.80	29.20	5.13	36.01

03/02/2021

Mode 1



- Lim.PK 
- PK 
- Lim.AV 
- AV 

Type	Freq (Hz)	Level (dBuV/m)	Limit (dBuV/m)	Margin (dB)	Factor (dB)	Dist (m)	Condition	Azimuth (°)	Height (m)	Comment	Raw (dBuV)	AF (dB)	CL (dB)	PA (dB)
PK	3.68779G	41.80	74.00	-32.20	-1.68	3	Horizontal	166	2.72	-	43.48	29.20	5.13	36.01
AV	3.68743G	30.89	54.00	-23.11	-1.68	3	Horizontal	166	2.72	"Worst"	32.57	29.20	5.13	36.01