

TEST REPORT

Product : Artificial Intelligence Terminal Computer
Trade mark : N/A
Model/Type reference : PP23TQA
Serial Number : N/A
Report Number : EED32M00211506
FCC ID : 2AWMI-PP23TQA
Date of Issue : Sep. 14, 2020
Test Standards : 47 CFR Part 15 Subpart E
Test result : PASS

Prepared for:

Beijing Puppy Robotics Co., Ltd.
Room 103, building 1, Yard 33, Yanqi Road,
Huairou District, Beijing, China

Prepared by:

Centre Testing International Group Co., Ltd.
Hongwei Industrial Zone, Bao'an 70 District,
Shenzhen, Guangdong, China
TEL: +86-755-3368 3668
FAX: +86-755-3368 3385

Compiled by:

Sunlight Sun

Sunlight Sun

Reviewed by:

Jok Yang

Jok Yang

Approved by:

Sam Chuang

Sam Chuang

Date:

Sep. 14, 2020



Check No.:3915617794

2 Version

Version No.	Date	Description
00	Sep. 14, 2020	Original

3 Test Summary

Test Item	Test Requirement	Test method	Result
DFS Detection Threshold	47 CFR Part 15 Subpart E Section 15.407 (h)(2)	KDB 905462 D02	PASS
U-NII Detection Bandwidth	47 CFR Part 15 Subpart E Section 15.407 (h)(2)	KDB 905462 D02	N/A
Channel Availability Check Time	47 CFR Part 15 Subpart E Section 15.407 (h)(2)(ii)	KDB 905462 D02	N/A
Channel Move Time	47 CFR Part 15 Subpart E Section 15.407 (h)(2)(iii)	KDB 905462 D02	PASS
Channel Closing Transmission Time	47 CFR Part 15 Subpart E Section 15.407 (h)(2)(iii)	KDB 905462 D02	PASS
Non-Occupancy Period	47 CFR Part 15 Subpart E Section 15.407 (h)(2)(iv)	KDB 905462 D02	PASS
Statistical Performance Check	47 CFR Part 15 Subpart E Section 15.407 (h)(2)	KDB 905462 D02	N/A

Remark:

The tested sample(s) and the sample information are provided by the client.

- Tx: In this whole report Tx (or tx) means Transmitter.
 Rx: In this whole report Rx (or rx) means Receiver.
 RF: In this whole report RF means Radiated Frequency.
 CH: In this whole report CH means channel.
 Volt: In this whole report Volt means Voltage.
 Temp: In this whole report Temp means Temperature.
 Humid: In this whole report Humid means humidity.
 Press: In this whole report Press means Pressure.
 N/A: In this whole report not application

4 Content

1 COVER PAGE	1
2 VERSION	2
3 TEST SUMMARY	3
4 CONTENT	4
5 GENERAL INFORMATION	5
5.1 CLIENT INFORMATION.....	5
5.2 GENERAL DESCRIPTION OF EUT.....	5
5.3 DESCRIPTION OF SUPPORT UNITS.....	7
5.4 TEST LOCATION.....	7
5.5 APPLIED STANDARDS.....	7
6 EQUIPMENT LIST	8
7 DFS TECHNICAL REQUIREMENTS AND RADAR TEST WAVEFORMS	11
7.1 DFS OVERVIEW.....	11
7.2 DFS DETECTION THRESHOLDS.....	12
7.3 RADAR TEST WAVEFORMS.....	13
7.3.1 Short Pulse Radar Test Waveforms.....	13
7.3.2 Long Pulse Radar Test Waveforms.....	15
8 TEST REQUIREMENT TEST SETUP	16
9 TEST CASE RESULTS	17
9.1 DFS DETECTION THRESHOLDS.....	17
9.2 IN-SERVICE MONITORING FOR CHANNEL MOVE TIME, CHANNEL CLOSING TRANSMISSION TIME AND NON-OCCUPANCY PERIOD.....	20
DFS TEST SETUP	26
PHOTOGRAPHS OF EUT CONSTRUCTIONAL DETAILS	29

5 General Information

5.1 Client Information

Applicant:	Beijing Puppy Robotics Co., Ltd.
Address of Applicant:	Room 103, building 1, Yard 33, Yanqi Road, Huairou District, Beijing, China
Manufacturer:	Beijing Puppy Robotics Co., Ltd.
Address of Manufacturer:	Room 103, building 1, Yard 33, Yanqi Road, Huairou District, Beijing, China
Factory:	Zhangzhou Wanlida Technology Co., Ltd.
Address of Factory:	Wanlida Industrial Zone, Jingcheng Town, Nanjing, Zhangzhou, Fujian, China

5.2 General Description of EUT

Product Name:	Artificial Intelligence Terminal Computer	
Model No. (EUT):	PP23TQA	
Trade Mark:	N/A	
Type of Modulation:	IEEE 802.11a: OFDM (BPSK, QPSK, 16QAM, 64QAM) IEEE 802.11n(HT20/HT40): OFDM (BPSK, QPSK, 16QAM, 64QAM) IEEE 802.11ac(VHT20/VHT40/VHT80): OFDM (BPSK, QPSK, 16QAM, 64QAM, 256QAM)	
Operating Frequency	U-NII-1 & U-NII-2A: 5180-5320MHz U-NII-2C:5500-5720MHz U-NII-3:5745-5825MHz	
Test Power Grade:	Default	
Test Software of EUT:	QRCT	
Antenna Type:	PIFA antenna	
Antenna Gain:	BT/2.4GWIFI:4.1dBi 5G WIFI:4.1dBi	
Function	<input checked="" type="checkbox"/> SISO <input checked="" type="checkbox"/> 2x2 MIMO	
Sample Received Date:	Jul. 16, 2020	
Sample tested Date:	Jul. 16, 2020 to Sep. 04, 2020	
Power Supply:	AC Adapter	MODEL:AP065G-19300 INPUT:100-240V~50/60Hz 1.5A Max OUTPUT:19V---3A
Test voltage:	AC120V/60Hz	
Sample Received Date:	Jul. 16, 2020	
Sample tested Date:	Jul. 16, 2020 to Sep. 04, 2020	

Operation Frequency each of channel

802.11a/802.11n/802.11ac(20MHz) Frequency/Channel Operations:

U-NII-1		U-NII-2A		U-NII-2C	
Channel	Frequency(MHz)	Channel	Frequency(MHz)	Channel	Frequency(MHz)
36	5180	52	5260	100	5500
40	5200	56	5280	104	5520
44	5220	60	5300	108	5540
48	5240	64	5320	112	5560
-	-	-	-	116	5580
-	-	-	-	120	5600
-	-	-	-	124	5620
-	-	-	-	128	5640
-	-	-	-	132	5660
-	-	-	-	136	5680
-	-	-	-	140	5700

802.11n/802.11ac(40MHz) Frequency/Channel Operations:

U-NII-1		U-NII-2A		U-NII-2C	
Channel	Frequency(MHz)	Channel	Frequency(MHz)	Channel	Frequency(MHz)
38	5190	54	5270	102	5510
46	5230	62	5310	110	5550
-	-	-	-	118	5590
-	-	-	-	126	5630
-	-	-	-	134	5670
-	-	-	-	142	5710

802.11ac(80MHz) Frequency/Channel Operations:

U-NII-1		U-NII-2A		U-NII-2C	
Channel	Frequency(MHz)	Channel	Frequency(MHz)	Channel	Frequency(MHz)
42	5210	58	5290	106	5530
-	-	-	-	122	5610
-	-	-	-	138	5690

5.3 Description of Support Units

The EUT has been tested with associated equipment below.

Associated equipment name		Manufacture	model	S/N serial number	Supplied by	Certification
AE1	Notebook	DELL	DELL 3490	D245DX2	DELL	CE&FCC

5.4 Test Location

All tests were performed at:

Centre Testing International Group Co., Ltd

Building C, Hongwei Industrial Park Block 70, Bao'an District, Shenzhen, China

Telephone: +86 (0) 755 33683668 Fax: +86 (0) 755 33683385

No tests were sub-contracted.

FCC Designation No.: CN1164

5.5 Applied Standards

According to the specifications of the manufacturer, it must comply with the requirements of the following standards:

FCC CFR47 Part 15E (2018) Unlicensed National Information Infrastructure Devices

FCC KDB 905462 D02UNII DFS Compliance Procedures New Rules v02

FCC KDB 905462 D03 Client Without DFS New Rules v01r02.

6 Equipment List

RF test system					
Equipment	Manufacturer	Mode No.	Serial Number	Cal. Date (mm-dd-yyyy)	Cal. Due date (mm-dd-yyyy)
Spectrum Analyzer	Keysight	N9010A	MY54510339	02-17-2020	02-16-2021
Signal Generator	Keysight	N5182B	MY53051549	02-17-2020	02-16-2021
Temperature/ Humidity Indicator	biaozhi	HM10	1804186	07-26-2019 06-29-2020	07-25-2020 06-28-2021
High-pass filter	Sinoscite	FL3CX03WG18N M12-0398-002	---	---	---
High-pass filter	MICRO-TRONICS	SPA-F-63029-4	---	---	---
DC Power	Keysight	E3642A	MY56376072	02-17-2020	02-16-2021
PC-1	Lenovo	R4960d	---	---	---
BT&WI-FI Automatic control	R&S	OSP120	101374	02-17-2020	02-16-2021
RF control unit	JS Tonscend	JS0806-2	158060006	02-17-2020	02-16-2021
BT&WI-FI Automatic test software	JS Tonscend	JS1120-3	---	---	---

Conducted disturbance Test					
Equipment	Manufacturer	Model No.	Serial Number	Cal. date (mm-dd-yyyy)	Cal. Due date (mm-dd-yyyy)
Receiver	R&S	ESCI	100435	04-28-2020	04-27-2021
Temperature/ Humidity Indicator	Defu	TH128	/	---	---
LISN	R&S	ENV216	100098	03-05-2020	03-04-2021
Barometer	changchun	DYM3	1188	---	---

3M Semi/full-anechoic Chamber					
Equipment	Manufacturer	Model No.	Serial Number	Cal. date (mm-dd-yyyy)	Cal. Due date (mm-dd-yyyy)
3M Chamber & Accessory Equipment	TDK	SAC-3	---	05-24-2019	05-23-2022
TRILOG Broadband Antenna	Schwarzbeck	VULB9163	9163-618	07-26-2019 05-16-2020	07-25-2020 05-15-2021
Loop Antenna	Schwarzbeck	FMZB 1519B	1519B-076	04-25-2018	04-24-2021
Receiver	R&S	ESCI7	100938-003	10-21-2019	10-20-2020
Multi device Controller	matur	NCD/070/107 11112	---	---	---
Temperature/Humidity Indicator	Shanghai qixiang	HM10	1804298	07-26-2019 06-29-2020	07-25-2020 06-28-2021
Cable line	Fulai(7M)	SF106	5219/6A	---	---
Cable line	Fulai(6M)	SF106	5220/6A	---	---
Cable line	Fulai(3M)	SF106	5216/6A	---	---
Cable line	Fulai(3M)	SF106	5217/6A	---	---

3M full-anechoic Chamber					
Equipment	Manufacturer	Model No.	Serial Number	Cal. date (mm-dd-yyyy)	Cal. Due date (mm-dd-yyyy)
RSE Automatic test software	JS Tonscend	JS36-RSE	10166	---	---
Receiver	Keysight	N9038A	MY57290136	03-05-2020	03-04-2021
Spectrum Analyzer	Keysight	N9020B	MY57111112	03-05-2020	03-04-2021
Spectrum Analyzer	Keysight	N9030B	MY57140871	03-05-2020	03-04-2021
TRILOG Broadband Antenna	Schwarzbeck	VULB 9163	9163-1148	04-25-2018	04-24-2021
Horn Antenna	Schwarzbeck	BBHA 9170	9170-832	04-25-2018	04-24-2021
Horn Antenna	ETS-LINDGREN	3117	00057407	07-10-2018	07-09-2021
Preamplifier	EMCI	EMC184055SE	980596	05-20-2020	05-19-2021
Preamplifier	EMCI	EMC001330	980563	04-22-2020	04-21-2021
Preamplifier	JS Tonscend	980380	EMC051845 SE	01-09-2020	01-08-2021
Temperature/ Humidity Indicator	biaozhi	GM1360	EE1186631	04-27-2020	04-26-2021
Fully Anechoic Chamber	TDK	FAC-3	---	01-17-2018	01-16-2021
Filter bank	JS Tonscend	JS0806-F	188060094	04-10-2018	04-09-2021
Cable line	Times	SFT205-NMSM-2.50M	394812-0001	---	---
Cable line	Times	SFT205-NMSM-2.50M	394812-0002	---	---
Cable line	Times	SFT205-NMSM-2.50M	394812-0003	---	---
Cable line	Times	SFT205-NMSM-2.50M	393495-0001	---	---
Cable line	Times	EMC104-NMNM-1000	SN160710	---	---
Cable line	Times	SFT205-NMSM-3.00M	394813-0001	---	---
Cable line	Times	SFT205-NMNM-1.50M	381964-0001	---	---
Cable line	Times	SFT205-NMSM-7.00M	394815-0001	---	---
Cable line	Times	HF160-KMKM-3.00M	393493-0001	---	---

7 DFS Technical Requirements and Radar Test Waveforms

7.1 DFS Overview

Table 1 Applicability of DFS Requirements Prior to Use of a Channel

Requirement	Operational Mode		
	Master	Client without Radar Detection	Client with Radar Detection
Non-Occupancy Period	Yes	Not required	Yes
DFS Detection Threshold	Yes	Not required	Yes
Channel Availability Check Time	Yes	Not required	Not required
U-NII Detection Bandwidth	Yes	Not required	Yes

Table 2 Applicability of DFS requirements during normal operation

Requirement	Operational Mode	
	Master Device or Client with Radar Detection	Client without Radar Detection
DFS Detection Threshold	Yes	Not required
Channel Closing Transmission Time	Yes	Yes
Channel Move Time	Yes	Yes
U-NII Detection Bandwidth	Yes	Not required

Additional requirements for devices with multiple bandwidth modes	Master Device or Client with Radar Detection	Client without Radar Detection
U-NII Detection Bandwidth and Statistical Performance Check	All BW modes must be tested	Not required
Channel Move Time and Channel Closing Transmission Time	Test using widest BW mode available	Test using the widest BW mode available for the link
All other tests	Any single BW mode	Not required

Note: Frequencies selected for statistical performance check should include several frequencies within the radar detection bandwidth and frequencies near the edge of the radar detection bandwidth. For 802.11 devices it is suggested to select frequencies in each of the bonded 20 MHz channels and the channel center frequency.

7.2 DFS Detection Thresholds

Table 3 DFS Detection Thresholds for Master Devices and Client Devices With Radar Detection

Maximum Transmit Power	Value(See Notes 1, 2 and 3)
≥ 200 milliwatt	-64 dBm
< 200 milliwatt and power spectral density < 10 dBm/MHz	-62 dBm
EIRP < 200 milliwatt that do not meet the power spectral density requirement	-64 dBm
<p>Note 1: This is the level at the input of the receiver assuming a 0 dBi receive antenna. Note 2: Throughout these test procedures an additional 1 dB has been added to the amplitude of the test transmission waveforms to account for variations in measurement equipment. This will ensure that the test signal is at or above the detection threshold level to trigger a DFS response. Note3: EIRP is based on the highest antenna gain. For MIMO devices refer to KDB Publication 662911 D01.</p>	

Table 4 DFS Response Requirement Values

Parameter	Value
Non- occupancy period	Minimum 30 minutes
Channel Availability Check Time	60 seconds
Channel Move Time	10 seconds See Note 1
Channel Closing Transmission Time	200 milliseconds + an aggregate of 60milliseconds over remaining 10 second period. See Notes 1 and 2
U-NII Detection Bandwidth	Minimum 100% of the UNII99% transmission power bandwidth See Note 3
<p>Note 1: Channel Move Time and the Channel Closing Transmission Time should be performed with Radar Type 0. The measurement timing begins at the end of the Radar Type 0 burst. Note 2: The Channel Closing Transmission Time is comprised of 200 milliseconds starting at the beginning of the Channel Move Time plus any additional intermittent control signals required to facilitate a Channel move (an aggregate of 60 milliseconds) during the remainder of the 10 second period. The aggregate duration of control signals will not count quiet periods in between transmissions. Note 3: During the U-NII Detection Bandwidth detection test, radar type 0 should be used. For each frequency step the minimum percentage of detection is 90 percent. Measurements are performed with no data traffic.</p>	

7.3 Radar Test Waveforms

7.3.1 Short Pulse Radar Test Waveforms

Table 5 – Short Pulse Radar Test Waveforms

Radar Type	Pulse Width (μsec)	PRI (μsec)	Number of Pulses	Minimum Percentage of Successful Detection	Minimum Number of Trials
0	1	1428	18	See Note 1	See Note 1
1	1	Test A: 15 unique PRI values randomly selected from the list of 23 PRI values in Table 5a	Roundup $\left\{ \left(\frac{1}{360} \right) \cdot \left(\frac{19 \cdot 10^6}{\text{PRI}_{\mu\text{sec}}} \right) \right\}$	60%	30
		Test B: 15 unique PRI values randomly selected within the range of 518-3066 μsec, with a minimum increment of 1 μsec, excluding PRI values selected in Test A			
2	1-5	150-230	23-29	60%	30
3	6-10	200-500	16-18	60%	30
4	11-20	200-500	12-16	60%	30
Aggregate (Radar Types 1-4)				80%	120
Note 1: Short Pulse Radar Type 0 should be used for the detection bandwidth test, channel move time, and channel closing time tests.					

A minimum of 30 unique waveforms are required for each of the Short Pulse Radar Types 2 through 4. If more than 30 waveforms are used for Short Pulse Radar Types 2 through 4, then each additional waveform must also be unique and not repeated from the previous waveforms. If more than 30 waveforms are used for Short Pulse Radar Type 1, then each additional waveform is generated with Test B and must also be unique and not repeated from the previous waveforms in Tests A or B.

For example if in Short Pulse Radar Type 1 Test B a PRI of 3066 μsec is selected, the number of pulses

would be $\text{Roundup} \left\{ \left(\frac{1}{360} \right) \cdot \left(\frac{19 \cdot 10^6}{3066} \right) \right\} = \text{Round up } \{17.2\} = 18.$

Table 5a - Pulse Repetition Intervals Values for Test A

Pulse Repetition Frequency Number	Pulse Repetition Frequency (Pulses Per Second)	Pulse Repetition Interval (Microseconds)
1	1930.5	518
2	1858.7	538
3	1792.1	558
4	1730.1	578
5	1672.2	598
6	1618.1	618
7	1567.4	638
8	1519.8	658
9	1474.9	678
10	1432.7	698
11	1392.8	718
12	1355	738
13	1319.3	758
14	1285.3	778
15	1253.1	798
16	1222.5	818
17	1193.3	838
18	1165.6	858
19	1139	878
20	1113.6	898
21	1089.3	918
22	1066.1	938
23	326.2	3066

The aggregate is the average of the percentage of successful detections of Short Pulse Radar Types 1-4. For example, the following table indicates how to compute the aggregate of percentage of successful detections.

Radar Type	Number of Trials	Number of Successful Detections	Minimum Percentage of Successful Detection
1	35	29	82.9%
2	30	18	60%
3	30	27	90%
4	50	44	88%
Aggregate $(82.9\% + 60\% + 90\% + 88\%)/4 = 80.2\%$			

7.3.2 Long Pulse Radar Test Waveforms

Table 6 – Long Pulse Radar Test Waveform

Radar Type	Pulse Width (μsec)	Chirp Width (MHz)	PRI (μsec)	Number of Pulses per Burst	Number of Bursts	Minimum Percentage of Successful Detection	Minimum Number of Trials
5	50-100	5-20	1000-2000	1-3	8-20	80%	30

The parameters for this waveform are randomly chosen. Thirty unique waveforms are required for the Long Pulse Radar Type waveforms. If more than 30 waveforms are used for the Long Pulse Radar Type waveforms, then each additional waveform must also be unique and not repeated from the previous waveforms.

Table 7 – Frequency Hopping Radar Test Waveform

Radar Type	Pulse Width (μsec)	PRI (μsec)	Pulses per Hop	Hopping Rate (kHz)	Hopping Sequence Length (msec)	Minimum Percentage of Successful Detection	Minimum Number of Trials
6	1	333	9	0.333	300	70%	30

For the Frequency Hopping Radar Type, the same Burst parameters are used for each waveform. The hopping sequence is different for each waveform and a 100-length segment is selected from the hopping sequence defined by the following algorithm: The first frequency in a hopping sequence is selected randomly from the group of 475 integer frequencies from 5250 – 5724 MHz. Next, the frequency that was just chosen is removed from the group and a frequency is randomly selected from the remaining 474 frequencies in the group. This process continues until all 475 frequencies are chosen for the set. For selection of a random frequency, the frequencies remaining within the group are always treated as equally likely.

8 Test Requirement Test setup

Setup for Master with injection at the Master

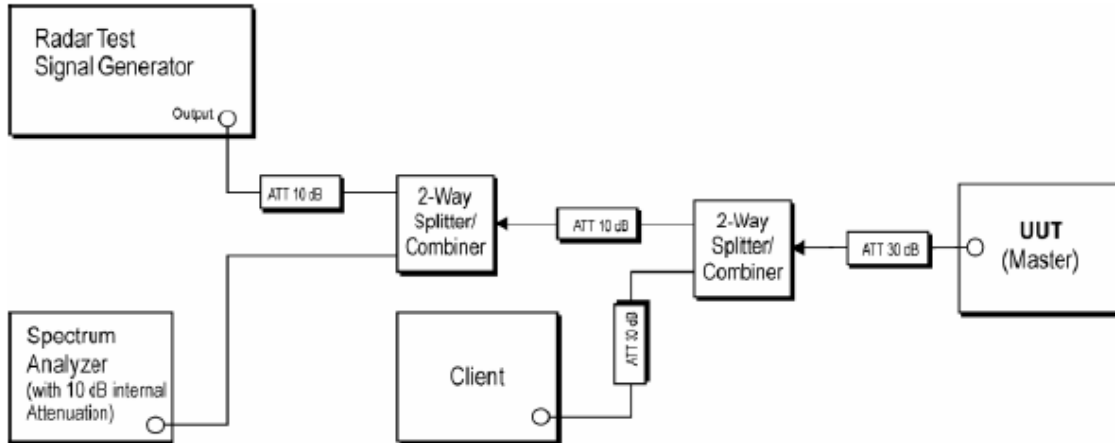

Example Conducted Setup where UUT is a Master and Radar Test Waveforms are injected into the Master.

Setup for Client with injection at the Master

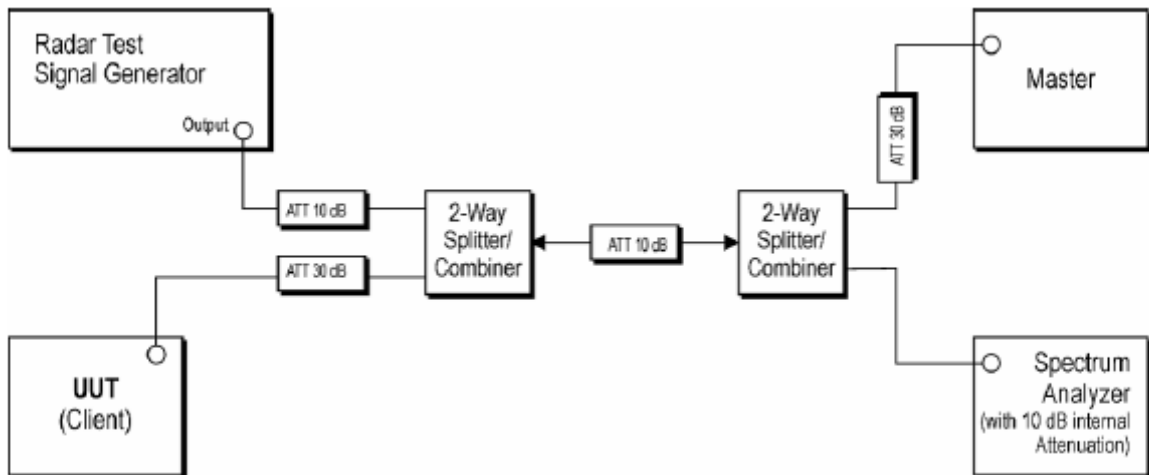

Example Conducted Setup where UUT is a Client and Radar Test Waveforms are injected into the Master

Setup for Client with injection at the Client

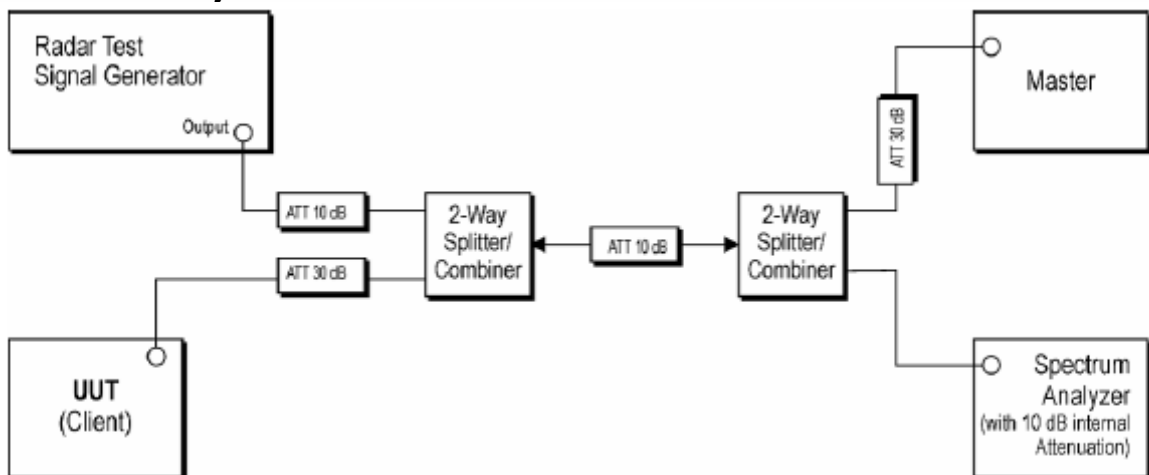

Example Conducted Setup where UUT is a Client and Radar Test Waveforms are injected into the Client.

9 Test Case Results

9.1 DFS Detection Thresholds

Ambient condition

Temperature	Relative humidity	Pressure
23°C ~25°C	45%~50%	101.5kPa

Methods of Measurement

Client with injection at the Master.

For a detection threshold level of -64dBm, the required signal strength at EUT antenna location is -64dBm, the tested level is lower than required level hence it provides margin to the limit.

Frequency of Calibration	
Bandwidth	Central Frequency
20MHz	5300MHz
	5500MHz
80MHz	5290MHz
	5610MHz

Test Result

Test Mode	Channel	Radar Type	Result	Limit[dbm]	Verdict
11AC20SISO	5320	Type0	-64.10	-57.00	PASS
	5500	Type0	-64.49	-57.00	PASS
11AC80SISO	5290	Type0	-64.64	-57.00	PASS
	5530	Type0	-64.59	-57.00	PASS

Test Graphs

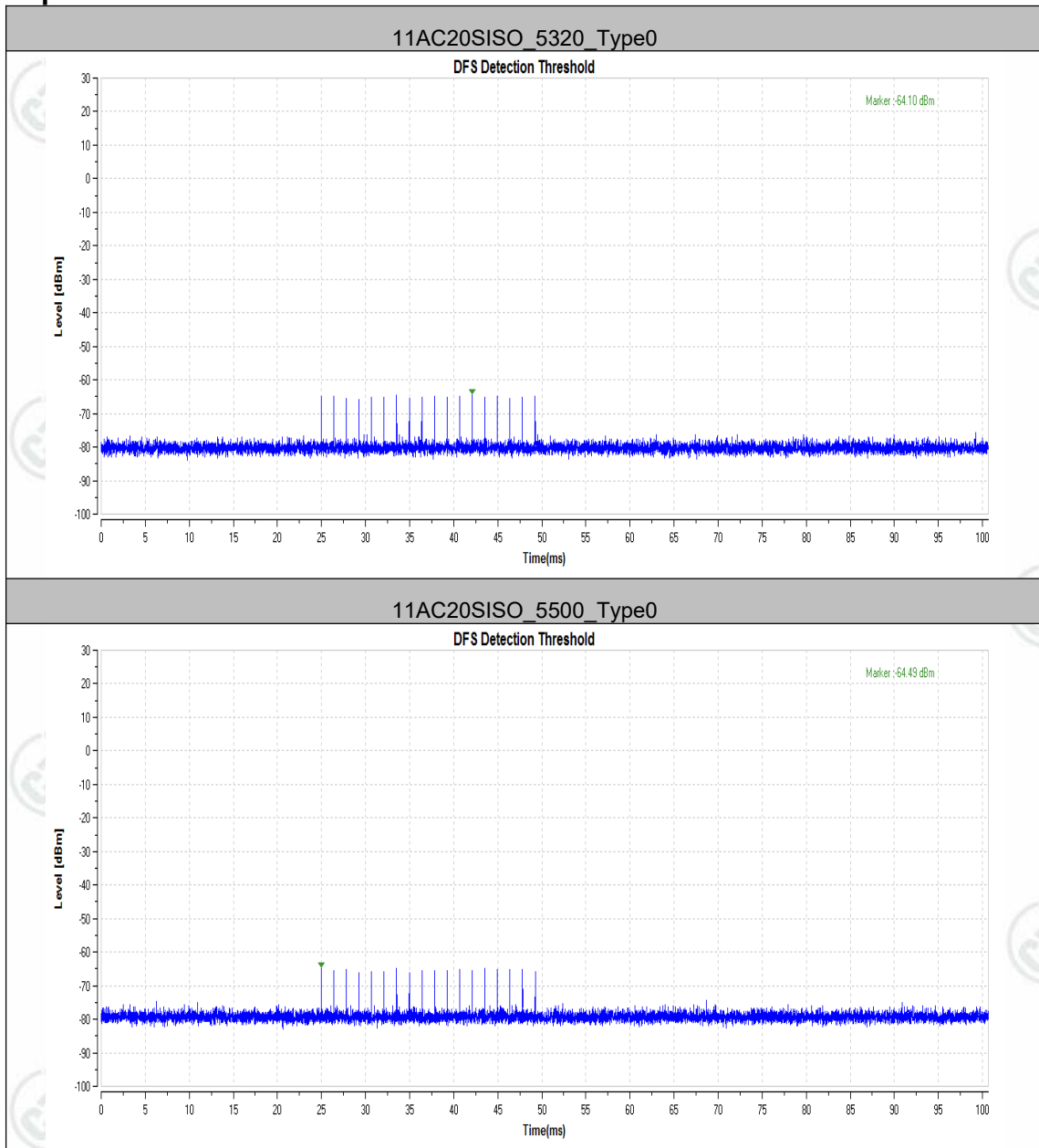

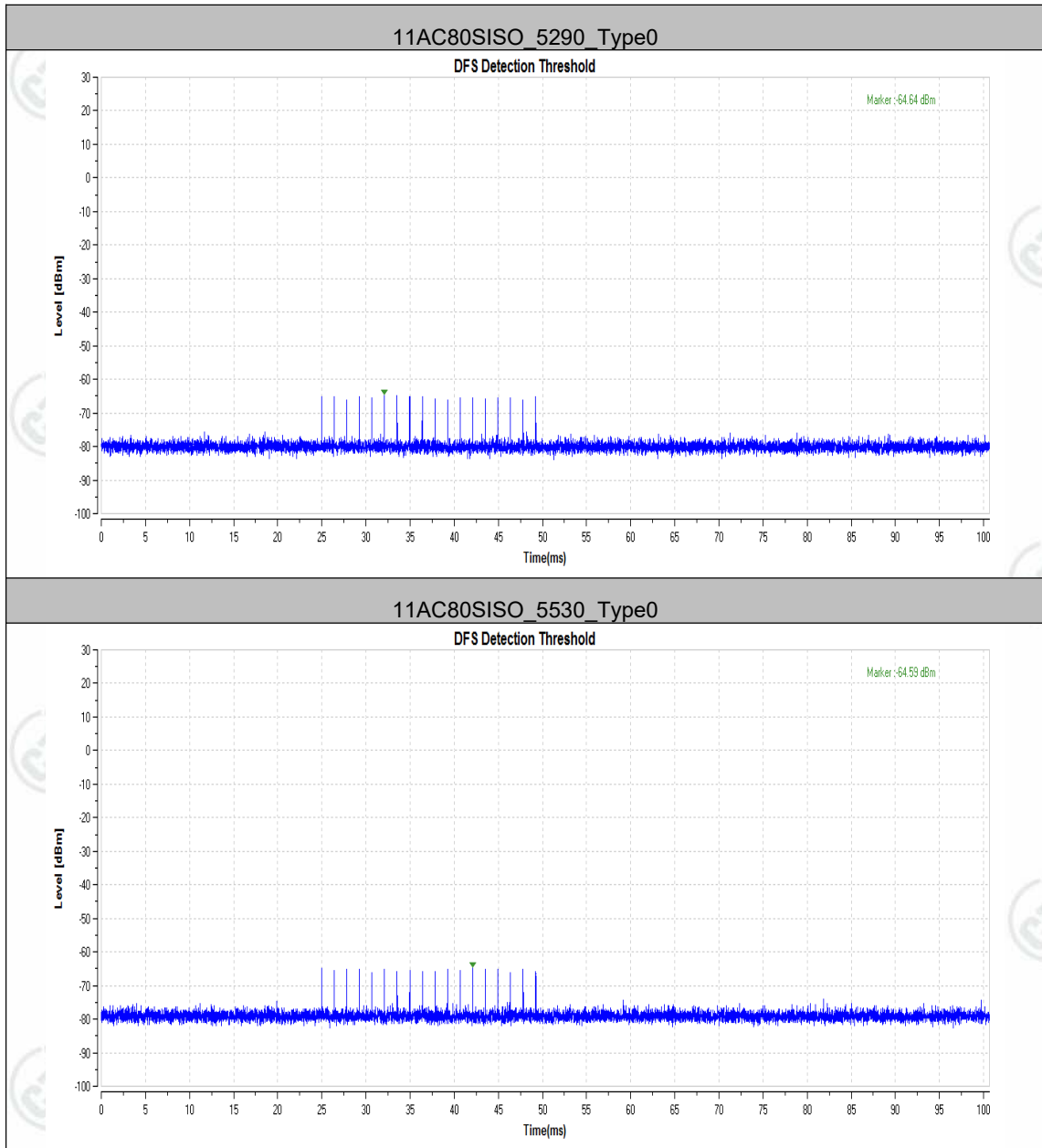

9.2 In-Service Monitoring for Channel Move Time, Channel Closing Transmission Time and Non-Occupancy Period

Ambient condition

Temperature	Relative humidity	Pressure
23°C ~25°C	45%~50%	101.5kPa

Methods of Measurement

These tests define how the following DFS parameters are verified during In-Service Monitoring;

- Channel Closing Transmission Time
- Channel Move Time
- Non-Occupancy Period

The steps below define the procedure to determine the above mentioned parameters when a radar Burst with a level equal to the DFS Detection Threshold + 1dB is generated on the Operating Channel of the U-NII device (In- Service Monitoring).

1. One frequency will be chosen from the Operating Channels of the EUT within the 5250-5350 MHz or 5470-5725 MHz bands. For 802.11 devices, the test frequency must contain control signals. This can be verified by disabling channel loading and monitoring the spectrum analyzer. If no control signals are detected, another frequency must be selected within the emission bandwidth where control signals are detected.
2. In case the EUT is a U-NII device operating as a Client Device (with or without DFS), a U-NII device operating as a Master Device will be used to allow the EUT (Client device) to Associate with the Master Device. In case the EUT is a Master Device, a U-NII device operating as a Client Device will be used and it is assumed that the Client will Associate with the EUT (Master). In both cases for conducted tests, the Radar Waveform generator will be connected to the Master Device. For radiated tests, the emissions of the Radar Waveform generator will be directed towards the Master Device. If the Master Device has antenna gain, the main beam of the antenna will be directed toward the radar emitter. Vertical polarization is used for testing.
3. Stream the channel loading test file from the Master Device to the Client Device on the test Channel for the entire period of the test.
4. At time T0 the Radar Waveform generator sends a Burst of pulses for one of the Radar Type 0 in Table 5 at levels defined in Table 3, on the Operating Channel. An additional 1 dB is added to the radar test signal to ensure it is at or above the DFS Detection Threshold, accounting for equipment variations/errors.
5. Observe the transmissions of the EUT at the end of the radar Burst on the Operating Channel for duration greater than 10 seconds. Measure and record the transmissions from the EUT during the observation time (Channel Move Time). Measure and record the Channel Move Time and Channel Closing Transmission Time if radar detection occurs. Figure 17 illustrates Channel Closing Transmission Time.
6. When operating as a Master Device, monitor the EUT for more than 30 minutes following instant T2 to verify that the EUT does not resume any transmissions on this Channel. Perform this test once and

record the measurement result.

7. In case the EUT is a U-NII device operating as a Client Device with In-Service Monitoring, perform steps 1 to 6.

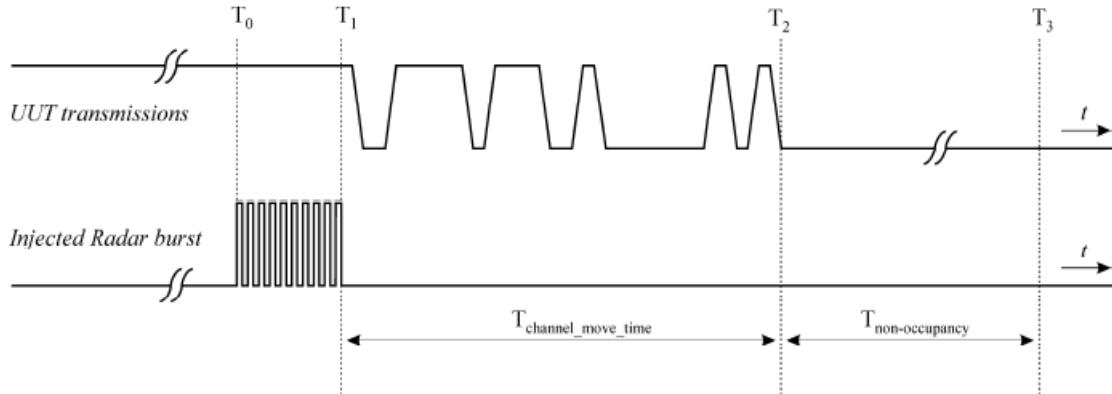

Example of Channel Closing Transmission Time & Channel Closing Time

Limit

Channel Move Time	$\leq 10s$
Channel Closing Transmission Time	$\leq 200ms + 60ms$ (over remaining 10s period)
Non-Occupancy Period	$\geq 30min$

Note 1: Channel Move Time and the Channel Closing Transmission Time should be performed with Radar Type 0. The measurement timing begins at the end of the Radar Type 0 burst.

Note 2: The Channel Closing Transmission Time is comprised of 200 milliseconds starting at the beginning of the Channel Move Time plus any additional intermittent control signals required to facilitate a Channel move (an aggregate of 60 milliseconds) during the remainder of the 10 second period. The aggregate duration of control signals will not count quiet periods in between transmissions.

Test Result

Test Mode	Channel	CCT[ms]	Limit[ms]	CMT[ms]	Limit[ms]	Verdict
11AC20SISO	5320	49.4	60	634.4	10000	PASS
	5500	49.4	60	594.1	10000	PASS
11AC80SISO	5290	49.4	60	590.2	10000	PASS
	5530	36.4	60	634.4	10000	PASS

Test Graphs

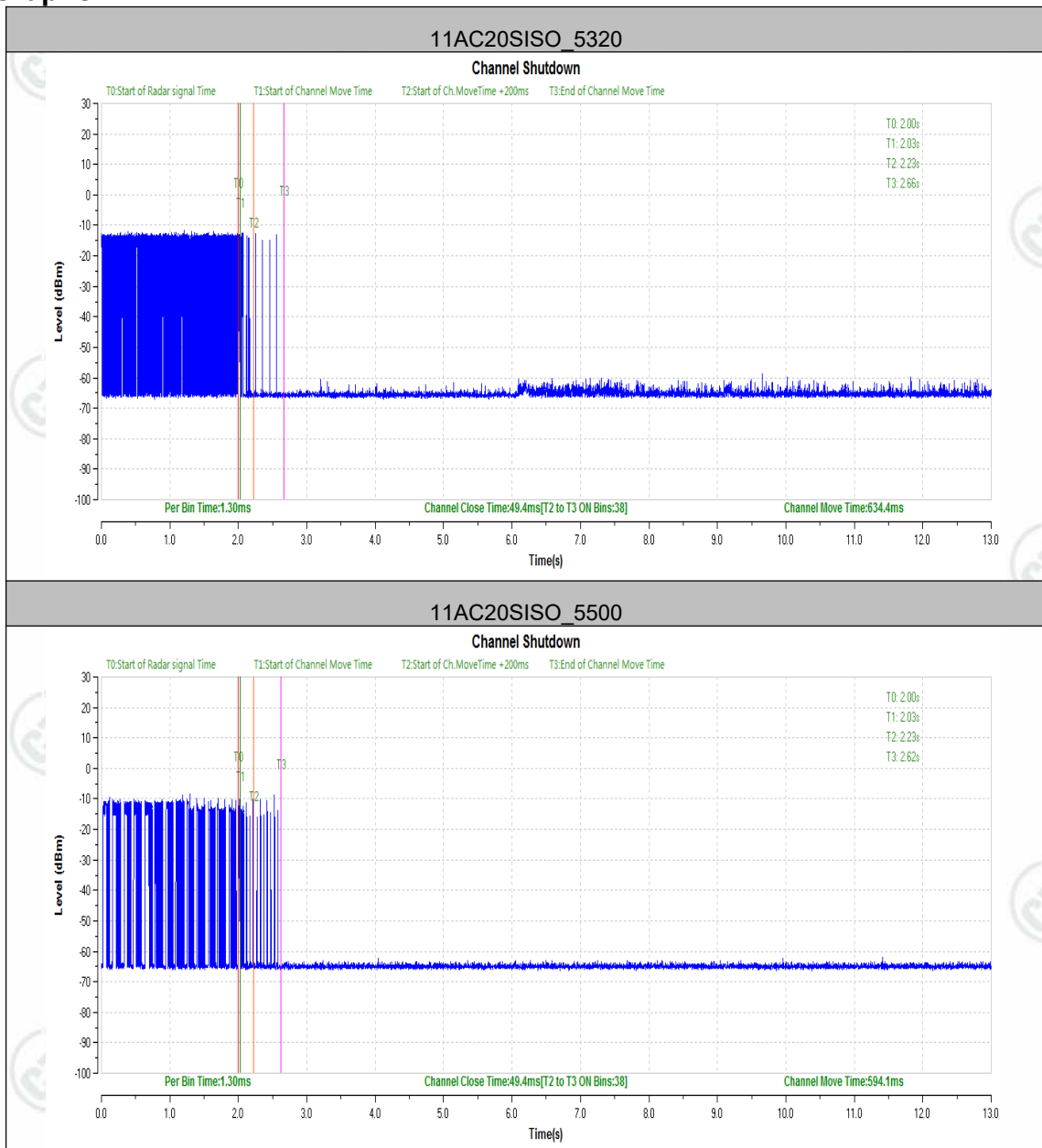

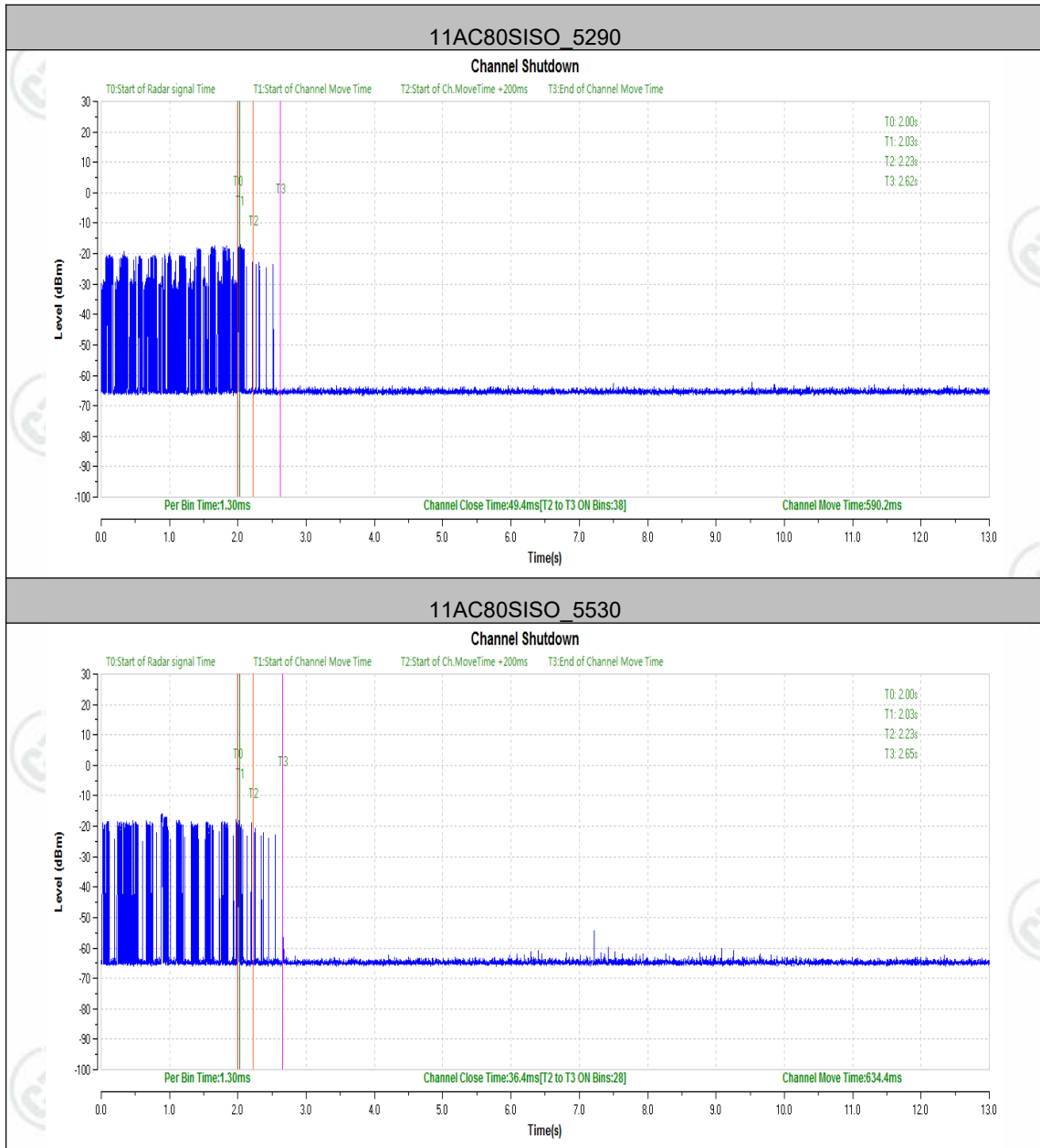

Test Result

Test Mode	Channel	Result	Limit[s]	Verdict
11AC20SISO	5320	see test graph	>=1800	PASS
	5500	see test graph	>=1800	PASS
11AC80SISO	5290	see test graph	>=1800	PASS
	5530	see test graph	>=1800	PASS

Test Graphs

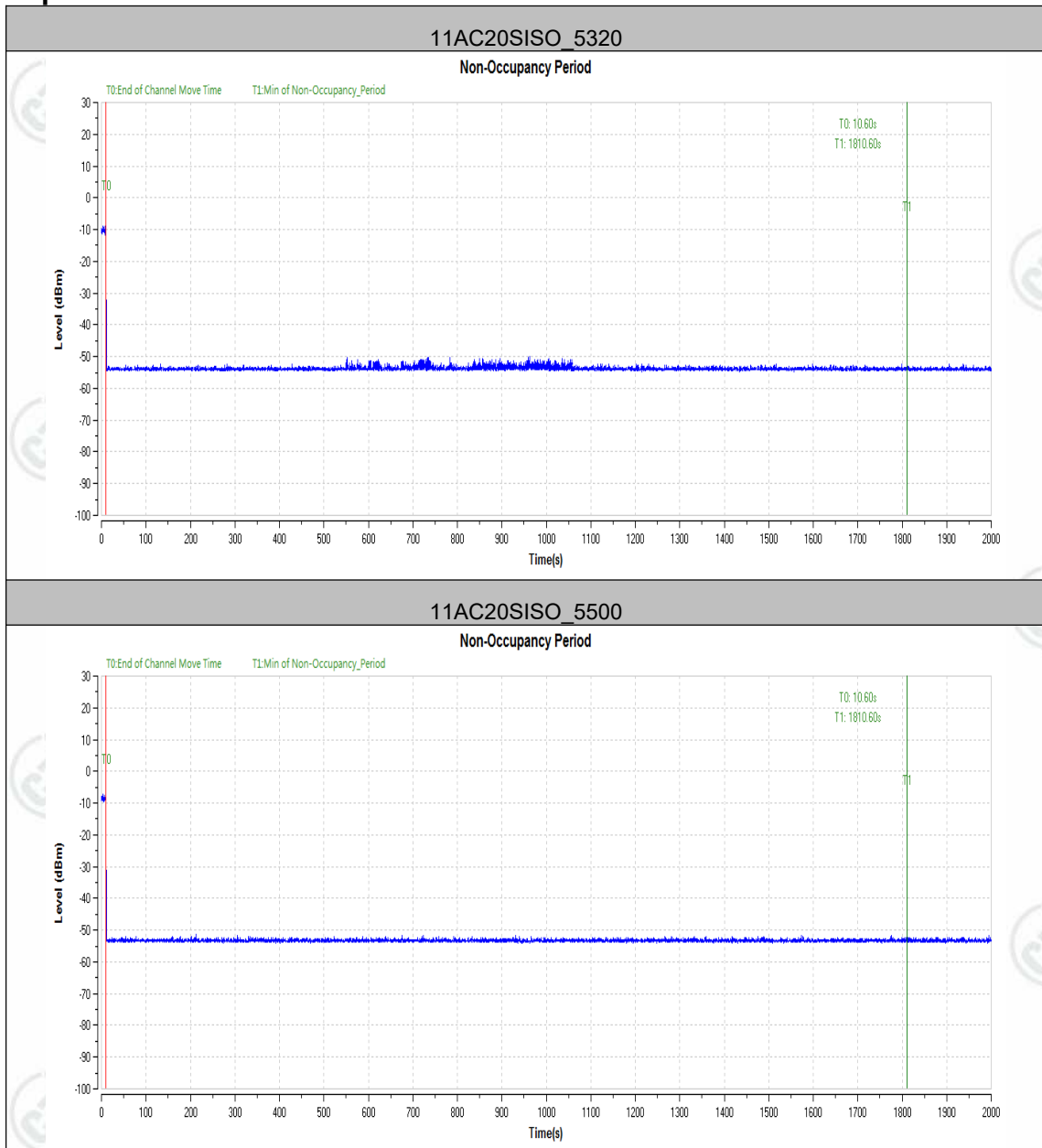

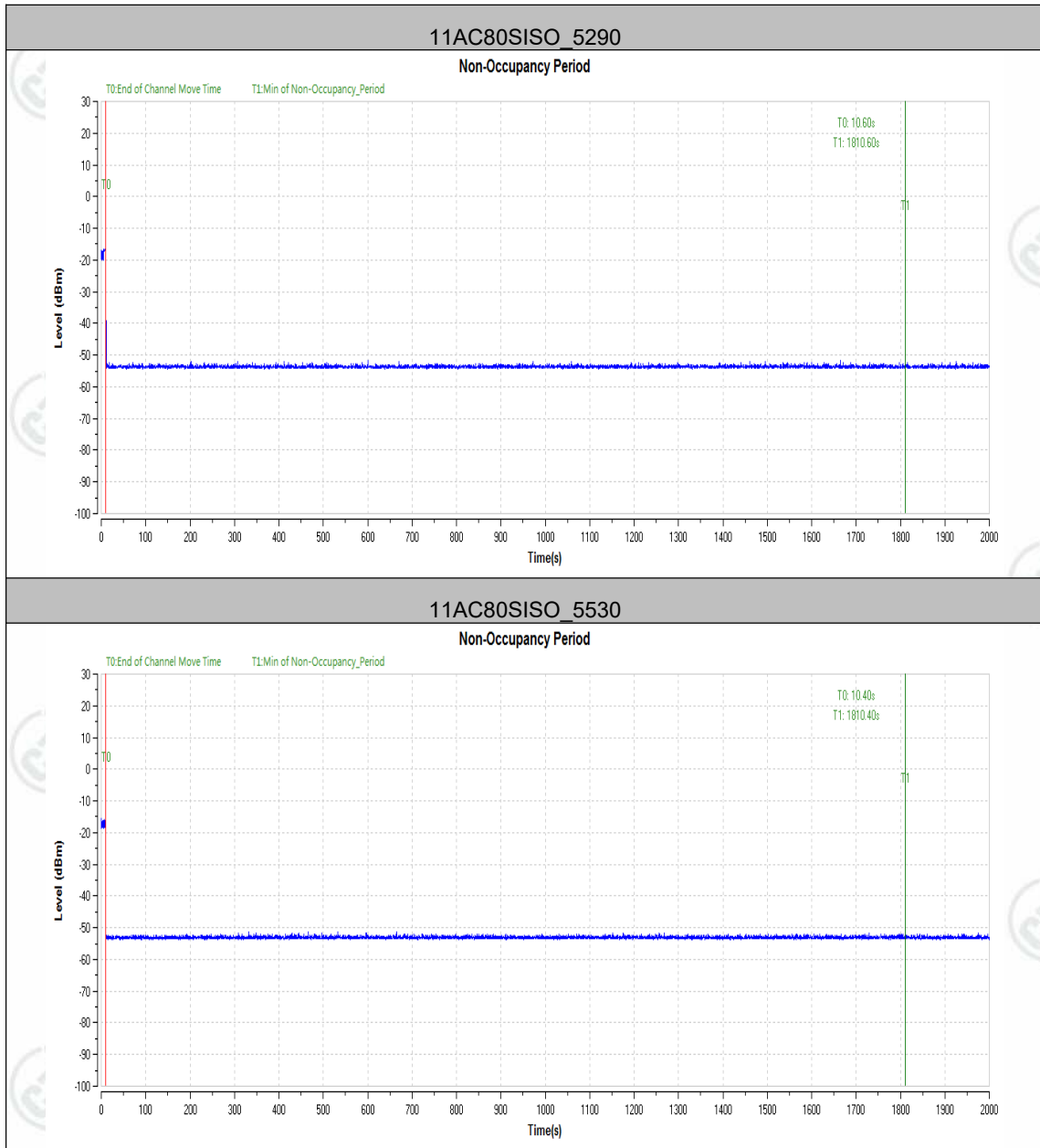

PHOTOGRAPHS OF EUT Constructional Details

Refer to Report No.EED32M00211501 for EUT external and internal photos.

The test report is effective only with both signature and specialized stamp, The result(s) shown in this report refer only to the sample(s) tested. Without written approval of CTI, this report can't be reproduced except in full.

*** End of Report ***