

TEST REPORT

FCC ID: 2AWLP-LPD10-11

Product: LUME PAD

Model No.: LPD-10W

Additional Model No.: LPD-11W

Trade Mark: N/A

Report No.: TCT200917E905

Issued Date: Sep. 28, 2020

Issued for:

Leia, Inc

2440 Sand Hill Road, STE 100, Menlo Park, California 94025, United States

Issued By:

Shenzhen Tongce Testing Lab.

**1B/F., Building 1, Yibaolai Industrial Park, Qiaotou, Fuyong, Baoan District,
Shenzhen, Guangdong, China**

TEL: +86-755-27673339

FAX: +86-755-27673332

Note: This report shall not be reproduced except in full, without the written approval of Shenzhen Tongce Testing Lab.

This document may be altered or revised by Shenzhen Tongce Testing Lab. personnel only, and shall be noted in the revision section of the document. The test results in the report only apply to the tested sample.

TABLE OF CONTENTS

1. Test Certification	3
2. Test Result Summary	4
3. EUT Description.....	5
4. General Information.....	7
4.1. Test environment and mode.....	7
4.2. Description of Support Units.....	8
5. Facilities and Accreditations	9
5.1. Facilities	9
5.2. Location	9
5.3. Measurement Uncertainty.....	9
6. Test Results and Measurement Data	10
6.1. Antenna requirement	10
6.2. Conducted Emission.....	11
6.3. Maximum Conducted (Average) Output Power	15
6.4. Emission Bandwidth	17
6.5. Power Spectral Density.....	18
6.6. Conducted Band Edge and Spurious Emission Measurement	20
6.7. Radiated Spurious Emission Measurement.....	22
Appendix A: Test Result of Conducted Test	
Appendix B: Photographs of Test Setup	
Appendix C: Photographs of EUT	

1. Test Certification

Product:	LUME PAD
Model No.:	LPD-10W
Additional Model No.:	LPD-11W
Trade Mark:	N/A
Applicant:	Leia, Inc
Address:	2440 Sand Hill Road, STE 100, Menlo Park, California 94025, United States
Manufacturer:	Leia, Inc
Address:	2440 Sand Hill Road, STE 100, Menlo Park, California 94025, United States
Date of Test:	May 28, 2020 – Sep. 27, 2020
Applicable Standards:	FCC CFR Title 47 Part 15 Subpart C Section 15.247 FCC KDB 558074 D01 15.247 Meas Guidance v05r02 FCC KDB 662911 D01 Multiple Transmitter Output v02r01 ANSI C63.10:2013

The above equipment has been tested by Shenzhen Tongce Testing Lab. and found compliance with the requirements set forth in the technical standards mentioned above. The results of testing in this report apply only to the product/system, which was tested. Other similar equipment will not necessarily produce the same results due to production tolerance and measurement uncertainties.

Tested By: Brews Xu **Date:** Sep. 27, 2020
Brews Xu

Reviewed By: Beryl Zhao **Date:** Sep. 28, 2020
Beryl Zhao

Approved By: Tomsin **Date:** Sep. 28, 2020
Tomsin

2. Test Result Summary

Requirement	CFR 47 Section	Result
Antenna requirement	§15.203/§15.247 (c)	PASS
AC Power Line Conducted Emission	§15.207	PASS
Conducted Peak Output Power	§15.247 (b)(3)	PASS
6dB Emission Bandwidth	§15.247 (a)(2)	PASS
Power Spectral Density	§15.247 (e)	PASS
Band Edge	§15.247(d)	PASS
Spurious Emission	§15.205/§15.209	PASS

Note:

1. PASS: Test item meets the requirement.
2. Fail: Test item does not meet the requirement.
3. N/A: Test case does not apply to the test object.
4. The test result judgment is decided by the limit of test standard.

3. EUT Description

Product:	LUME PAD
Model No.:	LPD-10W
Additional Model No.:	LPD-11W
Trade Mark:	N/A
Operation Frequency:	2412MHz~2462MHz (802.11b/802.11g/802.11n(HT20)) 2422MHz~2452MHz (802.11n(HT40))
Channel Separation:	5MHz
Number of Channel:	11 for 802.11b/802.11g/802.11n(HT20) 7 for 802.11n(HT40)
Modulation Technology: (IEEE 802.11b)	Direct Sequence Spread Spectrum (DSSS)
Modulation Technology: (IEEE 802.11g/802.11n)	Orthogonal Frequency Division Multiplexing(OFDM)
Data speed (IEEE 802.11b):	1Mbps, 2Mbps, 5.5Mbps, 11Mbps
Data speed (IEEE 802.11g):	6Mbps, 9Mbps, 12Mbps, 18Mbps, 24Mbps, 36Mbps, 48Mbps, 54Mbps
Data speed (IEEE 802.11n):	Up to 300Mbps
Antenna Type:	Internal Antenna
Antenna Gain:	Antenna0: 1.96dBi Antenna1: 1.82dBi
Power Supply:	Rechargeable Li-ion Battery DC 3.85V
AC adapter:	Adapter Information: Model: A138A-120150U-US4 Input: AC 100-240V, 50/60Hz, 0.5A Output: DC 5V, 3A/DC 9V, 2A/DC 12V, 1.5A
Remark:	All models above are identical in interior structure, electrical circuits and components, and just LPD-10W with rear camera, LPD-11W without rear camera.

Note: The antenna gain listed in this report is provided by applicant, and the test laboratory is not responsible for this parameter.

Operation Frequency each of channel For 802.11b/g/n(HT20)

Channel	Frequency	Channel	Frequency	Channel	Frequency	Channel	Frequency
1	2412MHz	4	2427MHz	7	2442MHz	10	2457MHz
2	2417MHz	5	2432MHz	8	2447MHz	11	2462MHz
3	2422MHz	6	2437MHz	9	2452MHz		

Operation Frequency each of channel For 802.11n (HT40)

Channel	Frequency	Channel	Frequency	Channel	Frequency	Channel	Frequency
--	--	4	2427MHz	7	2442MHz	--	--
--	--	5	2432MHz	8	2447MHz	--	--
3	2422MHz	6	2437MHz	9	2452MHz		

Note:

In section 15.31(m), regards to the operating frequency range over 10 MHz, the Lowest frequency, the middle frequency, and the highest frequency of channel were selected to perform the test, and the selected channel see below:

802.11b/802.11g/802.11n (HT20)

Channel	Frequency
The lowest channel	2412MHz
The middle channel	2437MHz
The Highest channel	2462MHz

802.11n (HT40)

Channel	Frequency
The lowest channel	2422MHz
The middle channel	2437MHz
The Highest channel	2452MHz

4. General Information

4.1. Test environment and mode

Operating Environment:		
Condition	Conducted Emission	Radiated Emission
Temperature:	25.0 °C	25.0 °C
Humidity:	55 % RH	55 % RH
Atmospheric Pressure:	1010 mbar	1010 mbar
Test Mode:		
Engineering mode:	Keep the EUT in continuous transmitting by select channel and modulations with Fully-charged battery	
<p>The sample was placed 0.8m & 1.5m for the measurement below & above 1GHz above the ground plane of 3m chamber. Measurements in both horizontal and vertical polarities were performed. During the test, each emission was maximized by: having the EUT continuously working, investigated all operating modes, rotated about all 3 axis (X, Y & Z) and considered typical configuration to obtain worst position, manipulating interconnecting cables, rotating the turntable, varying antenna height from 1m to 4m in both horizontal and vertical polarizations. The emissions worst-case (Z axis) are shown in Test Results of the following pages.</p>		

We have verified the construction and function in typical operation. All the test modes were carried out with the EUT in transmitting operation, which was shown in this test report and defined as follows:

Per-scan all kind of data rate in lowest channel, and found the follow list which it was worst case.

Mode	Data rate
802.11b (SISO)	1Mbps
802.11g (SISO)	6Mbps
802.11n(H20) (MIMO)	6.5Mbps
802.11n(H40) (MIMO)	13.5Mbps

Final Test Mode:

Operation mode:	Keep the EUT in continuous transmitting with modulation
<p>1. For WIFI function, the engineering test program was provided and enabled to make EUT continuous transmit/receive.</p> <p>2. According to ANSI C63.10 standards, the test results are both the “worst case” and “worst setup” 1Mbps for 802.11b, 6Mbps for 802.11g, 6.5Mbps for 802.11n(H20), 13.5Mbps for 802.11(H40). Duty cycle setting during the transmission is 98.46% with maximum power setting for all modulations.</p>	

4.2. Description of Support Units

The EUT has been tested as an independent unit together with other necessary accessories or support units. The following support units or accessories were used to form a representative test configuration during the tests.

Equipment	Model No.	Serial No.	FCC ID	Trade Name
/	/	/	/	/

Note:

1. All the equipment/cables were placed in the worst-case configuration to maximize the emission during the test.
2. Grounding was established in accordance with the manufacturer's requirements and conditions for the intended use.
3. For conducted measurements (Output Power, 6dB Emission Bandwidth, Power Spectral Density, Spurious Emissions), the antenna of EUT is connected to the test equipment via temporary antenna connector, the antenna connector is soldered on the antenna port of EUT, and the temporary antenna connector is listed in the Test Instruments.

5. Facilities and Accreditations

5.1. Facilities

The test facility is recognized, certified, or accredited by the following organizations:

- FCC - Registration No.: 645098

Shenzhen Tongce Testing Lab

The 3m Semi-anechoic chamber has been registered and fully described in a report with the (FCC) Federal Communications Commission. The acceptance letter from the FCC is maintained in our files.

- IC - Registration No.: 10668A-1

The 3m Semi-anechoic chamber of Shenzhen TCT Testing Technology Co., Ltd. has been registered by Certification and Engineering Bureau of Industry Canada for radio equipment testing

5.2. Location

Shenzhen Tongce Testing Lab.

Address: 1B/F., Building 1, Yibaolai Industrial Park, Qiaotou, Fuyong, Baoan District, Shenzhen, Guangdong, China

TEL: +86-755-27673339

5.3. Measurement Uncertainty

The reported uncertainty of measurement $y \pm U$, where expanded uncertainty U is based on a standard uncertainty multiplied by a coverage factor of $k=2$, providing a level of confidence of approximately 95 %.

No.	Item	MU
1	Conducted Emission	$\pm 2.56\text{dB}$
2	RF power, conducted	$\pm 0.12\text{dB}$
3	Spurious emissions, conducted	$\pm 0.11\text{dB}$
4	All emissions, radiated(<1G)	$\pm 3.92\text{dB}$
5	All emissions, radiated(>1G)	$\pm 4.28\text{dB}$
6	Temperature	$\pm 0.1^\circ\text{C}$
7	Humidity	$\pm 1.0\%$

6. Test Results and Measurement Data

6.1. Antenna requirement

Standard requirement:

FCC Part15 C Section 15.203 /247(c)

15.203 requirement:

An intentional radiator shall be designed to ensure that no antenna other than that furnished by the responsible party shall be used with the device. The use of a permanently attached antenna or of an antenna that uses a unique coupling to the intentional radiator, the manufacturer may design the unit so that a broken antenna can be replaced by the user, but the use of a standard antenna jack or electrical connector is prohibited.

15.247(c) (1)(i) requirement:

(i) Systems operating in the 2400-2483.5 MHz band that is used exclusively for fixed. Point-to-point operations may employ transmitting antennas with directional gain greater than 6dBi provided the maximum conducted output power of the intentional radiator is reduced by 1 dB for every 3 dB that the directional gain of the antenna exceeds 6dBi.

E.U.T Antenna:

The WIFI antennas are internal antennas, there are permanently attached and unique coupling to the intentional radiator.

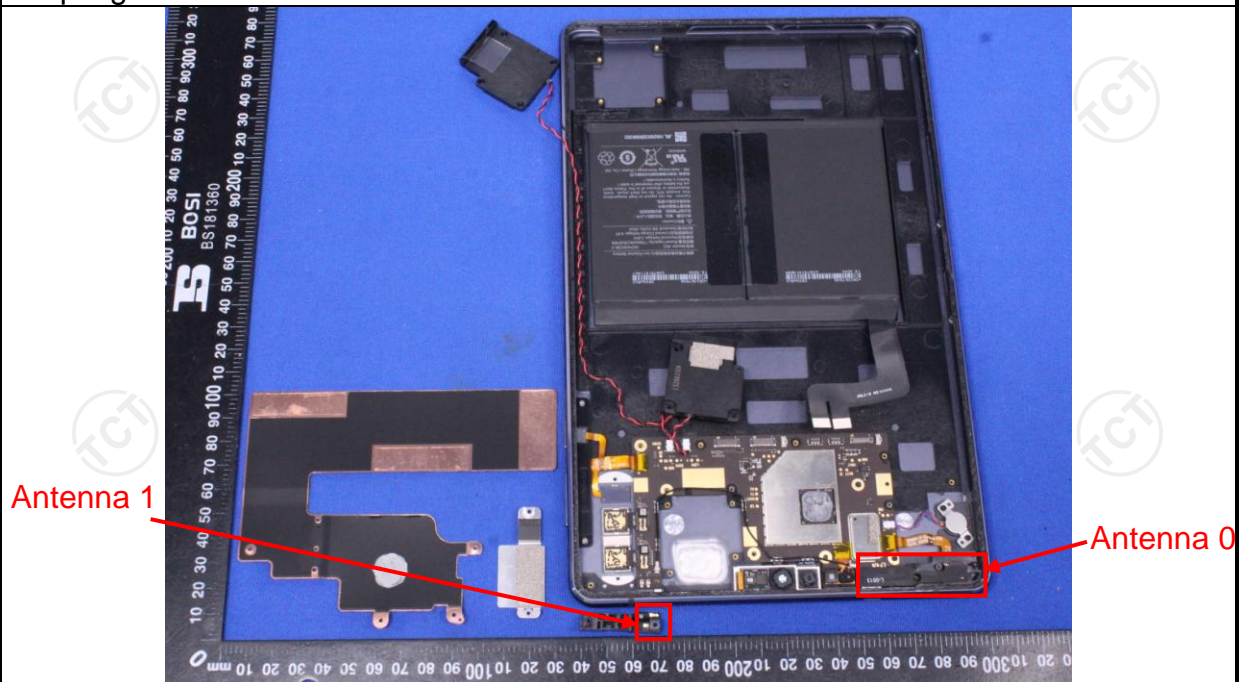

Refer to KDB 662911 D01 Multiple Transmitter Output v02r01:

Unequal antenna gains, with equal transmit powers, if transmit signals are correlated, then Directional gain = $10\log\left[\frac{(10^{1.96/20} + 10^{1.82/20})^2}{2}\right] = 4.9 \text{ dBi}$

6.2. Conducted Emission

6.2.1. Test Specification

Test Requirement:	FCC Part15 C Section 15.207														
Test Method:	ANSI C63.10:2013														
Frequency Range:	150 kHz to 30 MHz														
Receiver setup:	RBW=9 kHz, VBW=30 kHz, Sweep time=auto														
Limits:	<table border="1"> <thead> <tr> <th rowspan="2">Frequency range (MHz)</th> <th colspan="2">Limit (dBuV)</th> </tr> <tr> <th>Quasi-peak</th> <th>Average</th> </tr> </thead> <tbody> <tr> <td>0.15-0.5</td> <td>66 to 56*</td> <td>56 to 46*</td> </tr> <tr> <td>0.5-5</td> <td>56</td> <td>46</td> </tr> <tr> <td>5-30</td> <td>60</td> <td>50</td> </tr> </tbody> </table>	Frequency range (MHz)	Limit (dBuV)		Quasi-peak	Average	0.15-0.5	66 to 56*	56 to 46*	0.5-5	56	46	5-30	60	50
Frequency range (MHz)	Limit (dBuV)														
	Quasi-peak	Average													
0.15-0.5	66 to 56*	56 to 46*													
0.5-5	56	46													
5-30	60	50													
Test Setup:	<p><i>Remark</i> E.U.T: Equipment Under Test LISN: Line Impedance Stabilization Network Test table height=0.8m</p>														
Test Mode:	Charging + transmitting with modulation														
Test Procedure:	<ol style="list-style-type: none"> 1. The E.U.T is connected to the main power through a line impedance stabilization network (L.I.S.N.). This provides a 50ohm/50uH coupling impedance for the measuring equipment. 2. The peripheral devices are also connected to the main power through a LISN that provides a 50ohm/50uH coupling impedance with 50ohm termination. (Please refer to the block diagram of the test setup and photographs). 3. Both sides of A.C. line are checked for maximum conducted interference. In order to find the maximum emission, the relative positions of equipment and all of the interface cables must be changed according to ANSI C63.10: 2013 on conducted measurement. 														
Test Result:	PASS														

6.2.2. Test Instruments

Conducted Emission Shielding Room Test Site (843)				
Equipment	Manufacturer	Model	Serial Number	Calibration Due
Test Receiver	R&S	ESPI	101402	Jul. 27, 2021
LISN	Schwarzbeck	NSLK 8126	8126453	Sep.11, 2021
Line-5	TCT	CE-05	N/A	Sep. 02, 2021
EMI Test Software	Shurple Technology	EZ-EMC	N/A	N/A

Note: The calibration interval of the above test instruments is 12 months and the calibrations are traceable to international system unit (SI).

6.2.3. Test data

Please refer to following diagram for individual

Conducted Emission on Line Terminal of the power line (150 kHz to 30MHz)

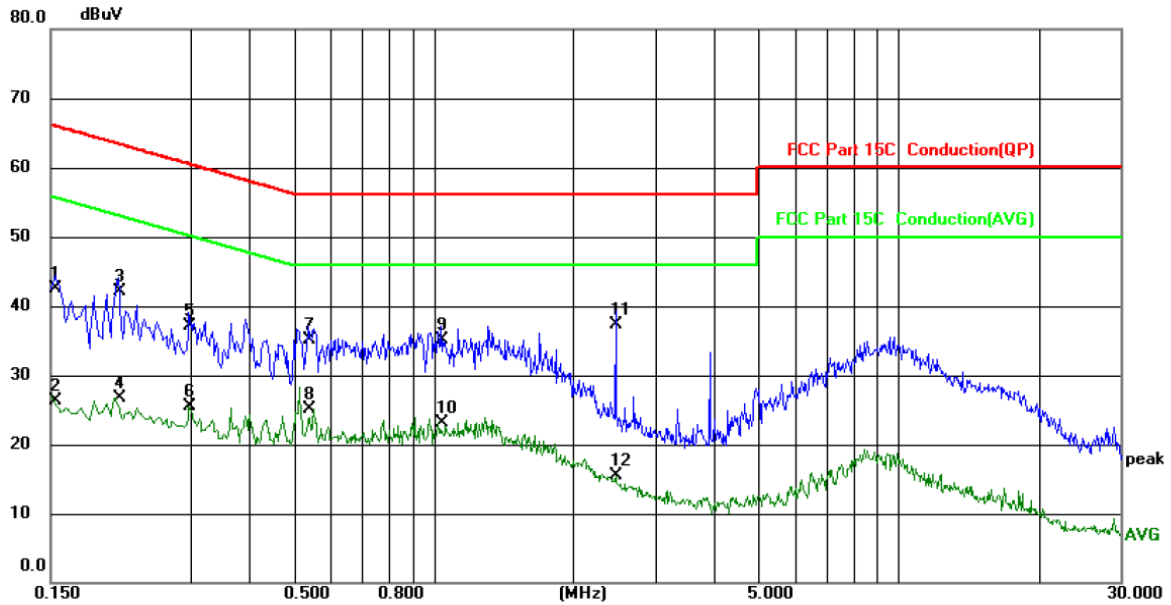

Site: Phase: **L1** Temperature: 25 (C)
Limit: FCC Part 15C Conduction(QP) Power: AC 120V/60Hz Humidity: 55 %RH

No.	Mk.	Freq. MHz	Reading Level dBuV	Correct Factor dB	Measure- ment dBuV	Limit dBuV	Over dB	Detector	Comment
1		0.1539	32.45	10.12	42.57	65.79	-23.22	QP	
2		0.1539	16.28	10.12	26.40	55.79	-29.39	AVG	
3		0.2100	31.91	10.13	42.04	63.21	-21.17	QP	
4		0.2100	16.63	10.13	26.76	53.21	-26.45	AVG	
5		0.2980	26.88	10.13	37.01	60.30	-23.29	QP	
6		0.2980	15.33	10.13	25.46	50.30	-24.84	AVG	
7		0.5380	24.99	10.13	35.12	56.00	-20.88	QP	
8		0.5380	15.05	10.13	25.18	46.00	-20.82	AVG	
9		1.0420	25.05	10.12	35.17	56.00	-20.83	QP	
10		1.0420	13.04	10.12	23.16	46.00	-22.84	AVG	
11	*	2.4620	27.20	10.12	37.32	56.00	-18.68	QP	
12		2.4620	5.44	10.12	15.56	46.00	-30.44	AVG	

Note:

- Freq. = Emission frequency in MHz
- Reading level (dBuV) = Receiver reading
- Corr. Factor (dB) = LISN factor + Cable loss
- Measurement (dBuV) = Reading level (dBuV) + Corr. Factor (dB)
- Limit (dBuV) = Limit stated in standard
- Margin (dB) = Measurement (dBuV) – Limits (dBuV)
- Q.P. =Quasi-Peak
- AVG =average
- * is meaning the worst frequency has been tested in the frequency range 150 kHz to 30MHz

Conducted Emission on Neutral Terminal of the power line (150 kHz to 30MHz)

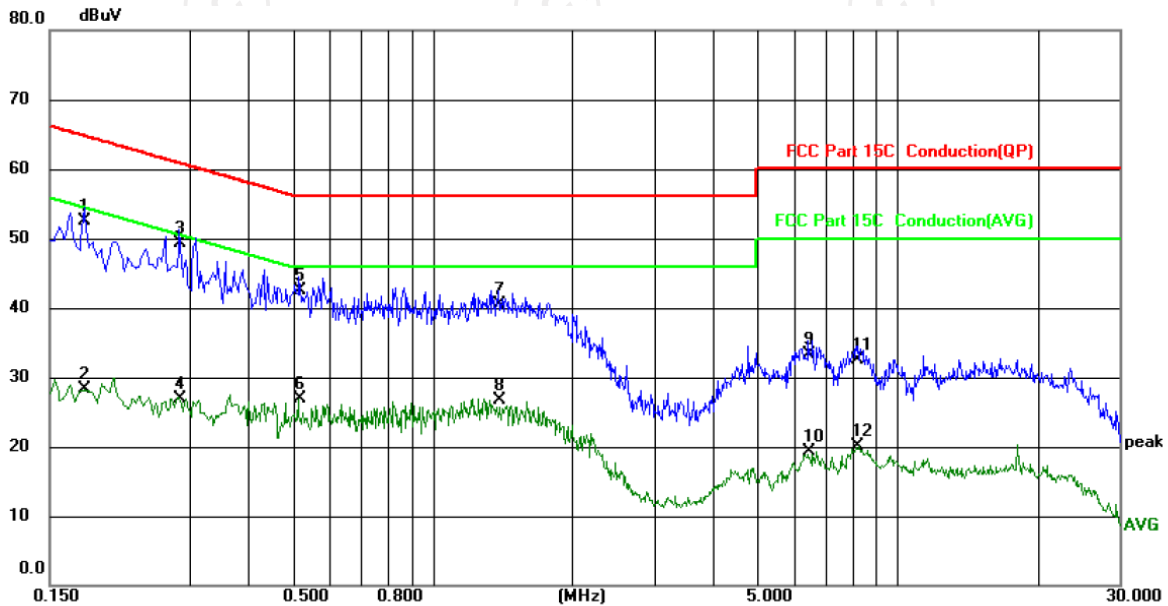

Site: Phase: **N** Temperature: 25 (C)
Limit: FCC Part 15C Conduction(QP) Power: AC 120V/60Hz Humidity: 55 %RH

No.	Mk.	Freq. MHz	Reading Level dBuV	Correct Factor dB	Measure- ment dBuV	Limit dBuV	Over dB	Detector	Comment
1		0.1780	42.25	10.22	52.47	64.58	-12.11	QP	
2		0.1780	17.99	10.22	28.21	54.58	-26.37	AVG	
3	*	0.2860	39.07	10.23	49.30	60.64	-11.34	QP	
4		0.2860	16.64	10.23	26.87	50.64	-23.77	AVG	
5		0.5180	32.22	10.22	42.44	56.00	-13.56	QP	
6		0.5180	16.59	10.22	26.81	46.00	-19.19	AVG	
7		1.3820	30.15	10.39	40.54	56.00	-15.46	QP	
8		1.3820	16.27	10.39	26.66	46.00	-19.34	AVG	
9		6.4220	22.85	10.50	33.35	60.00	-26.65	QP	
10		6.4220	8.72	10.50	19.22	50.00	-30.78	AVG	
11		8.1540	22.01	10.53	32.54	60.00	-27.46	QP	
12		8.1540	9.49	10.53	20.02	50.00	-29.98	AVG	

Note:

Freq. = Emission frequency in MHz
 Reading level (dBuV) = Receiver reading
 Corr. Factor (dB) = LISN factor + Cable loss
 Measurement (dBuV) = Reading level (dBuV) + Corr. Factor (dB)
 Limit (dBuV) = Limit stated in standard
 Margin (dB) = Measurement (dBuV) – Limits (dBuV)
 Q.P. =Quasi-Peak
 AVG =average
 * is meaning the worst frequency has been tested in the frequency range 150 kHz to 30MHz.

6.3. Maximum Conducted (Average) Output Power

6.3.1. Test Specification

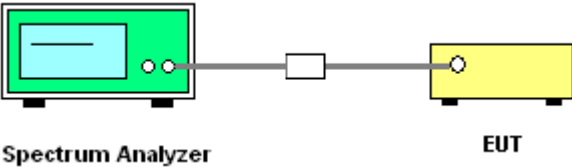
Test Requirement:	FCC Part15 C Section 15.247 (b)(3)
Test Method:	KDB 558074 D01 v05r02, KDB662911 D01 v02r01
Limit:	30dBm
Test Setup:	 <p style="text-align: center;">Spectrum Analyzer EUT</p>
Test Mode:	Transmitting mode with modulation
Test Procedure:	<ol style="list-style-type: none"> 1. The RF output of EUT was connected to the spectrum analyzer by RF cable and attenuator. The path loss was compensated to the results for each measurement. 2. Set to the maximum power setting and enable the EUT transmit continuously. 3. Measure the conducted output power and record the results in the test report.
Test Result:	PASS

6.3.2. Test Instruments

RF Test Room				
Equipment	Manufacturer	Model	Serial Number	Calibration Due
Spectrum Analyzer	Agilent	N9020A	MY49100619	Sep. 11, 2021
RF Cable (9KHz-26.5GHz)	TCT	RE-06	N/A	Sep. 11, 2021
Antenna Connector	TCT	RFC-01	N/A	Sep. 11, 2021

Note: The calibration interval of the above test instruments is 12 months and the calibrations are traceable to international system unit (SI).

6.3.3. Test Data

Configuration IEEE 802.11b/ Antenna 0+Antenna 1				
Test channel	Maximum Conducted (Average) Output Power (dBm)		Limit (dBm)	Result
	Antenna 0	Antenna 1		
Lowest	7.02	6.49	30	PASS
Middle	7.31	6.46	30	PASS
Highest	7.52	6.50	30	PASS

Configuration IEEE 802.11g/ Antenna 0+Antenna 1				
Test channel	Maximum Conducted (Average) Output Power (dBm)		Limit (dBm)	Result
	Antenna 0	Antenna 1		
Lowest	6.09	6.27	30	PASS
Middle	6.73	5.66	30	PASS
Highest	6.72	5.79	30	PASS

Configuration IEEE 802.11n(H20)/ Antenna 0+Antenna 1					
Test channel	Maximum Conducted (Average) Output Power (dBm)			Limit (dBm)	Result
	Antenna 0	Antenna 1	Total		
Lowest	6.10	5.62	8.88	30	PASS
Middle	6.54	5.45	9.04	30	PASS
Highest	6.80	5.31	9.13	30	PASS

Configuration IEEE 802.11n(H40)/ Antenna 0+Antenna 1					
Test channel	Maximum Conducted (Average) Output Power (dBm)			Limit (dBm)	Result
	Antenna 0	Antenna 1	Total		
Lowest	6.79	7.40	10.12	30	PASS
Middle	7.31	6.89	10.12	30	PASS
Highest	7.83	6.45	10.21	30	PASS

Note: The duty cycle of 802.11n(H40) is 94.8%(<98%), so a duty cycle factor (0.23) added to the test result.

6.4. Emission Bandwidth

6.4.1. Test Specification

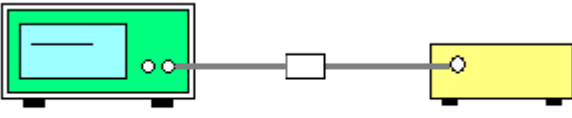
Test Requirement:	FCC Part15 C Section 15.247 (a)(2)
Test Method:	KDB 558074 D01 v05r02
Limit:	>500kHz
Test Setup:	 <p style="text-align: center;">Spectrum Analyzer EUT</p>
Test Mode:	Transmitting mode with modulation
Test Procedure:	<ol style="list-style-type: none"> 1. Set to the maximum power setting and enable the EUT transmit continuously. 2. Make the measurement with the spectrum analyzer's resolution bandwidth (RBW) = 100 kHz. Set the Video bandwidth (VBW) = 300 kHz. In order to make an accurate measurement. The 6dB bandwidth must be greater than 500 kHz. 3. Measure and record the results in the test report.
Test Result:	PASS

6.4.2. Test Instruments

RF Test Room				
Equipment	Manufacturer	Model	Serial Number	Calibration Due
Spectrum Analyzer	Agilent	N9020A	MY49100619	Sep. 11, 2021
RF Cable (9KHz-26.5GHz)	TCT	RE-06	N/A	Sep. 11, 2021
Antenna Connector	TCT	RFC-01	N/A	Sep. 11, 2021

Note: The calibration interval of the above test instruments is 12 months and the calibrations are traceable to international system unit (SI).

6.5. Power Spectral Density

6.5.1. Test Specification

Test Requirement:	FCC Part15 C Section 15.247 (e)
Test Method:	KDB 558074
Limit:	The average power spectral density shall not be greater than 8dBm in any 3kHz band at any time interval of continuous transmission.
Test Setup:	 <p style="text-align: center;">Spectrum Analyzer EUT</p>
Test Mode:	Transmitting mode with modulation
Test Procedure:	<ol style="list-style-type: none"> 1. The RF output of EUT was connected to the spectrum analyzer by RF cable and attenuator. The path loss was compensated to the results for each measurement. 2. Set to the maximum power setting and enable the EUT transmit continuously. 3. Make the measurement with the spectrum analyzer's resolution bandwidth (RBW): $3 \text{ kHz} \leq \text{RBW} \leq 100 \text{ kHz}$. Video bandwidth $\text{VBW} \geq 3 \times \text{RBW}$. Set the span to at least 1.5 times the OBW. 4. Detector = RMS, Sweep time = auto couple. 5. Employ trace averaging (RMS) mode over a minimum of 100 traces. Use the peak marker function to determine the maximum power level. 6. Measure and record the results in the test report.
Test Result:	PASS

6.5.2. Test Instruments

RF Test Room				
Equipment	Manufacturer	Model	Serial Number	Calibration Due
Spectrum Analyzer	Agilent	N9020A	MY49100619	Sep. 11, 2021
RF Cable (9KHz-26.5GHz)	TCT	RE-06	N/A	Sep. 11, 2021
Antenna Connector	TCT	RFC-01	N/A	Sep. 11, 2021

Note: The calibration interval of the above test instruments is 12 months and the calibrations are traceable to international system unit (SI)

6.5.3. Test data

Configuration IEEE 802.11b/ Antenna 0, Antenna 1				
Test channel	AVG Power Spectral Density (dBm/3kHz)		Limit (dBm/3kHz)	Result
	Antenna 0	Antenna 1		
Lowest	-24.63	-24.88	8	PASS
Middle	-24.04	-25.13	8	PASS
Highest	-24.16	-24.65	8	PASS

Configuration IEEE 802.11g/ Antenna 0, Antenna 1				
Test channel	AVG Power Spectral Density (dBm/3kHz)		Limit (dBm/3kHz)	Result
	Antenna 0	Antenna 1		
Lowest	-26.95	-27.33	8	PASS
Middle	-26.86	-27.69	8	PASS
Highest	-26.68	-27.84	8	PASS

Configuration IEEE 802.11n (HT20)/ Antenna 0, Antenna 1					
Test channel	AVG Power Spectral Density (dBm/3kHz)			Limit (dBm/3kHz)	Result
	Antenna 0	Antenna 1	Total		
Lowest	-27.63	-27.92	-24.76	8	PASS
Middle	-27.64	-27.98	-24.80	8	PASS
Highest	-26.71	-27.87	-24.24	8	PASS

Configuration IEEE 802.11n (HT40)/ Antenna 0, Antenna 1					
Test channel	AVG Power Spectral Density (dBm/3kHz)			Limit (dBm/3kHz)	Result
	Antenna 0	Antenna 1	Total		
Lowest	-29.87	-28.72	-26.25	8	PASS
Middle	-28.78	-29.31	-26.03	8	PASS
Highest	-27.64	-30.62	-25.87	8	PASS

Note: The duty cycle of 802.11n(H40) is 94.8%(<98%), so a duty cycle factor (0.23) added to the test result.

6.6. Conducted Band Edge and Spurious Emission Measurement

6.6.1. Test Specification

Test Requirement:	FCC Part15 C Section 15.247 (d)
Test Method:	KDB558074
Limit:	In any 100 kHz bandwidth outside of the authorized frequency band, the emissions which fall in the non-restricted bands shall be attenuated at least 20 dB / 30dB relative to the maximum PSD level in 100 kHz by RF conducted measurement and radiated emissions which fall in the restricted bands, as defined in Section 15.205(a), must also comply with the radiated emission limits specified in Section 15.209(a).
Test Setup:	 <p style="text-align: center;">Spectrum Analyzer EUT</p>
Test Mode:	Transmitting mode with modulation
Test Procedure:	<ol style="list-style-type: none"> 1. The RF output of EUT was connected to the spectrum analyzer by RF cable and attenuator. The path loss was compensated to the results for each measurement. 2. Set to the maximum power setting and enable the EUT transmit continuously. 3. Set RBW = 100 kHz, VBW=300 kHz, Peak Detector. Unwanted Emissions measured in any 100 kHz bandwidth outside of the authorized frequency band shall be attenuated by at least 20 dB relative to the maximum in-band peak PSD level in 100 kHz when maximum peak conducted output power procedure is used. If the transmitter complies with the conducted power limits based on the use of RMS averaging over a time interval, the attenuation required under this paragraph shall be 30 dB instead of 20 dB per 15.247(d). 4. Measure and record the results in the test report. 5. The RF fundamental frequency should be excluded against the limit line in the operating frequency band.
Test Result:	PASS

6.6.2. Test Instruments

RF Test Room				
Equipment	Manufacturer	Model	Serial Number	Calibration Due
Spectrum Analyzer	Agilent	N9020A	MY49100619	Sep. 11, 2021
RF Cable (9KHz-26.5GHz)	TCT	RE-06	N/A	Sep. 11, 2021
Antenna Connector	TCT	RFC-01	N/A	Sep. 11, 2021

Note: The calibration interval of the above test instruments is 12 months and the calibrations are traceable to international system unit (SI).

6.7. Radiated Spurious Emission Measurement

6.7.1. Test Specification

Test Requirement:	FCC Part15 C Section 15.209					
Test Method:	ANSI C63.10: 2013					
Frequency Range:	9 kHz to 25 GHz					
Measurement Distance:	3 m					
Antenna Polarization:	Horizontal & Vertical					
Operation mode:	Transmitting mode with modulation					
Receiver Setup:	Frequency	Detector	RBW	VBW	Remark	
	9kHz- 150kHz	Quasi-peak	200Hz	1kHz	Quasi-peak Value	
	150kHz- 30MHz	Quasi-peak	9kHz	30kHz	Quasi-peak Value	
	30MHz-1GHz	Quasi-peak	120KHz	300KHz	Quasi-peak Value	
	Above 1GHz	Peak	1MHz	3MHz	Peak Value	
		Peak	1MHz	10Hz	Average Value	
Limit:	Frequency	Field Strength (microvolts/meter)	Measurement Distance (meters)			
	0.009-0.490	2400/F(KHz)	300			
	0.490-1.705	24000/F(KHz)	30			
	1.705-30	30	30			
	30-88	100	3			
	88-216	150	3			
	216-960	200	3			
	Above 960	500	3			
	Frequency	Field Strength (microvolts/meter)	Measurement Distance (meters)	Detector		
	Above 1GHz	500	3	Average		
	5000	3	Peak			
Test setup:	For radiated emissions below 30MHz					
	<p>The diagram illustrates the test setup for radiated emissions below 30MHz. An Equipment Under Test (EUT) is placed on a turn table at a height of 0.8m. The turn table is positioned at a distance of 3m from a circular antenna mounted on a stand at a height of 1m. The antenna is connected to a receiver system consisting of a Pre-Amplifier, Receiver, and Computer, all connected to a common Ground Plane.</p>					
	30MHz to 1GHz					

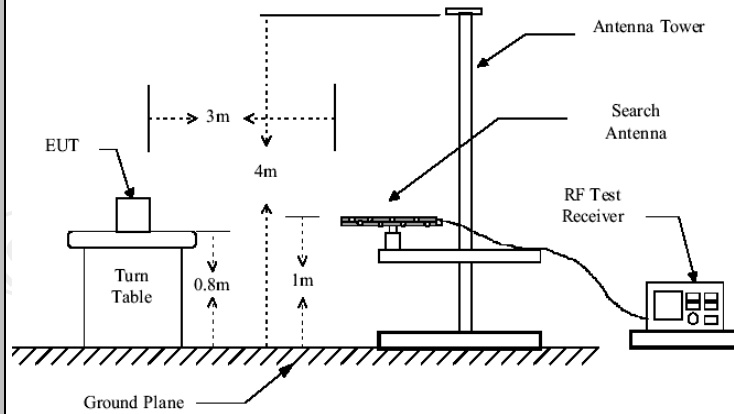

Above 1GHz

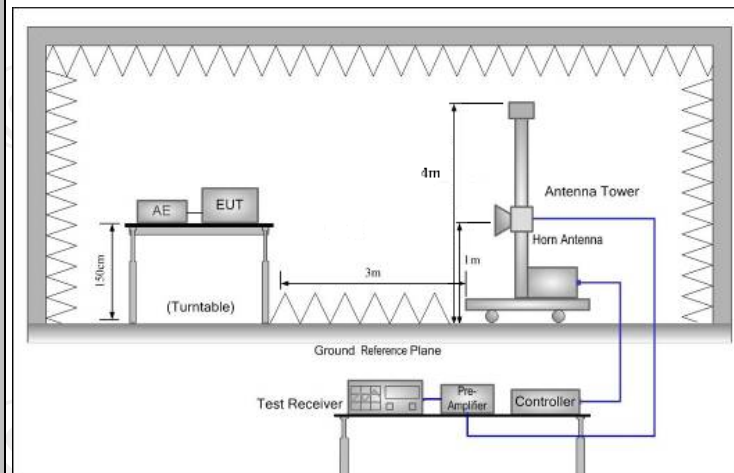

Test Procedure:

1. For the radiated emission test below 1GHz:
The EUT was placed on a turntable with 0.8 meter above ground. The EUT was set 3 meters from the interference receiving antenna, which was mounted on the top of a variable height antenna tower. The EUT was arranged to its worst case and then tune the antenna tower (from 1 m to 4 m) and turntable (from 0 degree to 360 degrees) to find the maximum reading. A pre-amp and a high PASS filter are used for the test in order to get better signal level.
For the radiated emission test above 1GHz:
Place the measurement antenna on a turntable with 1.5 meter above ground, which is away from each area of the EUT determined to be a source of emissions at the specified measurement distance, while keeping the measurement antenna aimed at the source of emissions at each frequency of significant emissions, with polarization oriented for maximum response. The measurement antenna may have to be higher or lower than the EUT, depending on the radiation pattern of the emission and staying aimed at the emission source for receiving the maximum signal. The final

	<p>measurement antenna elevation shall be that which maximizes the emissions. The measurement antenna elevation for maximum emissions shall be restricted to a range of heights of from 1 m to 4 m above the ground or reference ground plane.</p> <p>3. Corrected Reading: Antenna Factor + Cable Loss + Read Level - Preamp Factor = Level</p> <p>4. For measurement below 1GHz, If the emission level of the EUT measured by the peak detector is 3 dB lower than the applicable limit, the peak emission level will be reported. Otherwise, the emission measurement will be repeated using the quasi-peak detector and reported.</p> <p>5. Use the following spectrum analyzer settings:</p> <p>(1) Span shall wide enough to fully capture the emission being measured;</p> <p>(2) Set RBW=120 kHz for $f < 1$ GHz; VBW \geq RBW; Sweep = auto; Detector function = peak; Trace = max hold;</p> <p>(3) Set RBW = 1 MHz, VBW= 3MHz for $f > 1$ GHz for peak measurement.</p> <p>For average measurement: VBW = 10 Hz, when duty cycle is no less than 98 percent. VBW $\geq 1/T$, when duty cycle is less than 98 percent where T is the minimum transmission duration over which the transmitter is on and is transmitting at its maximum power control level for the tested mode of operation.</p>
Test results:	PASS

6.7.2. Test Instruments

Radiated Emission Test Site (966)				
Name of Equipment	Manufacturer	Model	Serial Number	Calibration Due
Test Receiver	ROHDE&SCHW ARZ	ESIB7	100197	Jul. 27, 2021
Spectrum Analyzer	ROHDE&SCHW ARZ	FSQ40	200061	Sep. 11, 2020
Pre-amplifier	EM Electronics Corporation CO.,LTD	EM30265	07032613	Sep. 02, 2021
Pre-amplifier	HP	8447D	2727A05017	Sep. 02, 2021
Loop antenna	ZHINAN	ZN30900A	12024	Oct. 27, 2020
Broadband Antenna	Schwarzbeck	VULB9163	340	Sep. 04, 2022
Horn Antenna	Schwarzbeck	BBHA 9120D	631	Sep. 04, 2022
Horn Antenna	A-INFO	LB-180400-KF	J211020657	Sep. 11, 2021
Antenna Mast	Keleto	RE-AM	N/A	N/A
Line-4	TCT	RE-high-04	N/A	Sep. 02, 2021
Line-8	TCT	RE-01	N/A	Jul. 27, 2021
EMI Test Software	Shurple Technology	EZ-EMC	N/A	N/A

Note: The calibration interval of the above test instruments is 12 months and the calibrations are traceable to international system unit (SI).

6.7.3. Test Data

Please refer to following diagram for individual
Below 1GHz

Horizontal:

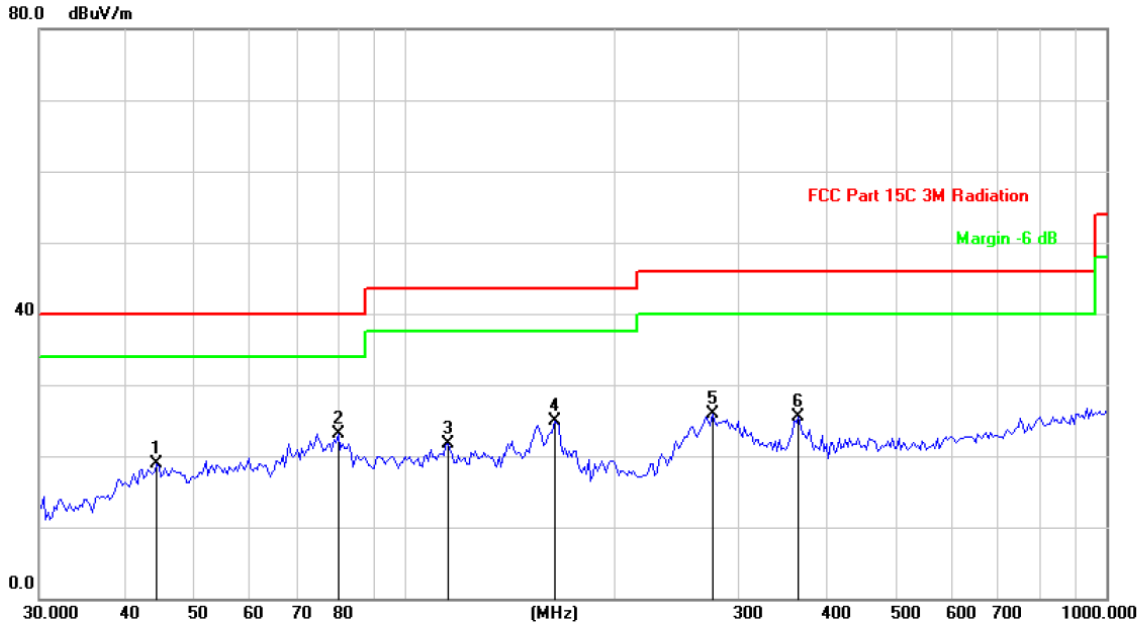

Site: Polarization: **Horizontal** Temperature: 25
Limit: FCC Part 15C 3M Radiation Power: AC 120V/60Hz Humidity: 55 %

No.	Mk.	Freq. MHz	Reading Level dBuV	Correct Factor dB	Measure- ment dBuV/m	Limit dB/m	Over dB	Detector
1		44.1544	29.57	-10.62	18.95	40.00	-21.05	peak
2	*	80.2382	39.56	-16.55	23.01	40.00	-16.99	peak
3		114.8224	31.78	-10.16	21.62	43.50	-21.88	peak
4		163.1622	40.47	-15.66	24.81	43.50	-18.69	peak
5		274.4463	37.63	-11.76	25.87	46.00	-20.13	peak
6		363.5230	34.97	-9.49	25.48	46.00	-20.52	peak

Vertical:

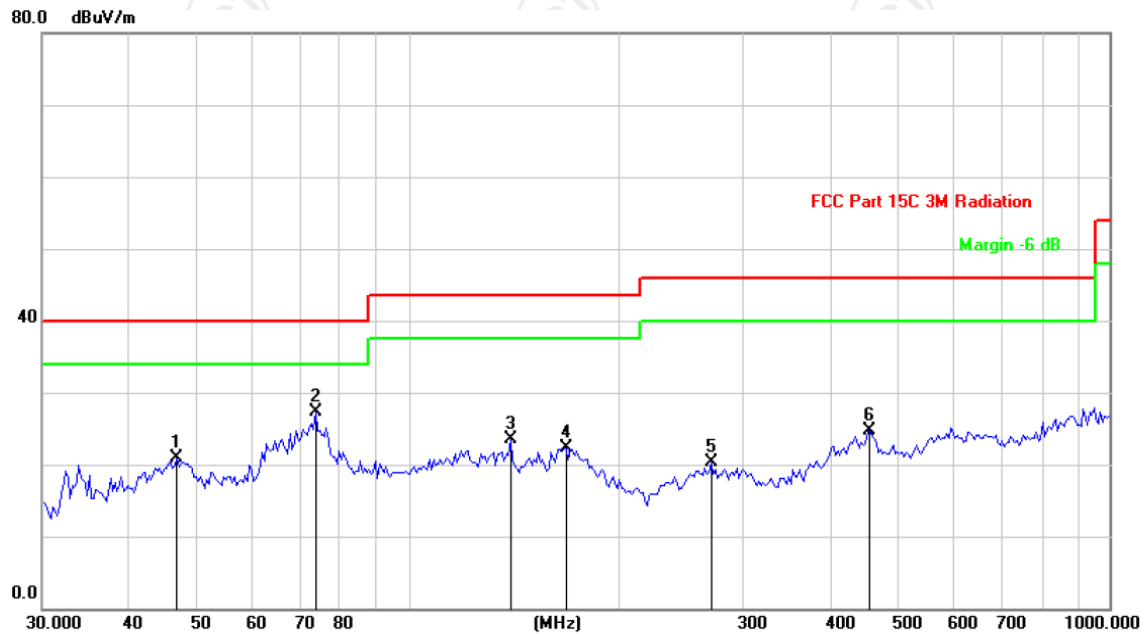

Site: Polarization: **Vertical** Temperature: 25
 Limit: FCC Part 15C 3M Radiation Power: AC 120V/60Hz Humidity: 55 %

No.	Mk.	Freq. MHz	Reading Level dBuV	Correct Factor dB	Measure- ment dBuV/m	Limit dB/m	Over dB	Detector
1		46.7077	31.29	-10.36	20.93	40.00	-19.07	peak
2	*	73.7496	43.40	-16.04	27.36	40.00	-12.64	peak
3		139.7906	39.50	-16.07	23.43	43.50	-20.07	peak
4		167.8136	37.73	-15.46	22.27	43.50	-21.23	peak
5		270.6161	32.16	-11.89	20.27	46.00	-25.73	peak
6		455.1888	32.89	-8.23	24.66	46.00	-21.34	peak

Note: 1. The low frequency, which started from 9KHz~30MHz, was pre-scanned and the result which was 20dB lower than the limit line per 15.31(o) was not reported

2. Measurements were conducted in all three channels (high, middle, low) and all modulation(802.11b, 802.11g, 802.11n(HT20), 802.11n(HT40)), and the worst case Mode (Highest channel and 802.11 n(HT40)) was submitted only.

3. Freq. = Emission frequency in MHz

Measurement (dBuV/m) = Reading level (dBuV) + Corr. Factor (dB)

Correction Factor= Antenna Factor + Cable loss – Pre-amplifier

Limit (dBuV/m) = Limit stated in standard

Margin (dB) = Measurement (dBuV/m) – Limits (dBuV/m)

Any value more than 10dB below limit have not been specifically reported

* is meaning the worst frequency has been tested in the test frequency range

Test Result of Radiated Spurious at Band edges

Lowest channel 2412:

Horizontal:

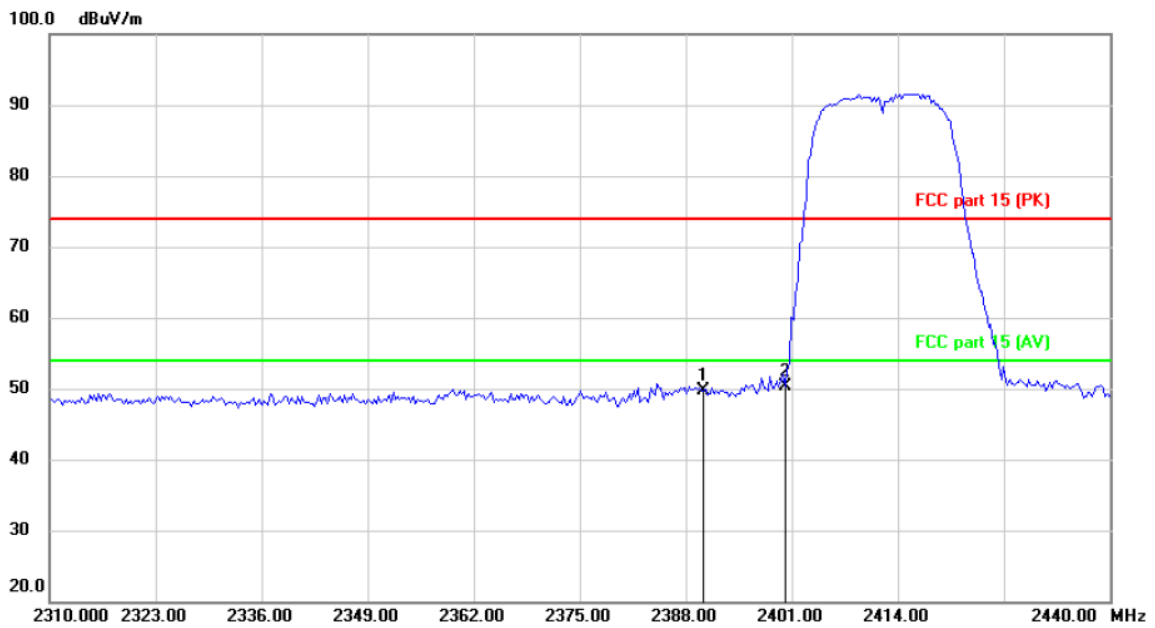

Site: Polarization: *Horizontal* Temperature: 25
Limit: FCC part 15 (PK) Power: DC 3.7V Humidity: 55 %

No.	Mk.	Freq.	Reading Level	Correct Factor	Measurement	Limit	Over	
		MHz	dBuV	dB	dBuV/m	dBuV/m	dB	Detector
1		2390.000	47.03	2.66	49.69	74.00	-24.31	peak
2	*	2400.000	47.58	2.66	50.24	74.00	-23.76	peak

Vertical:

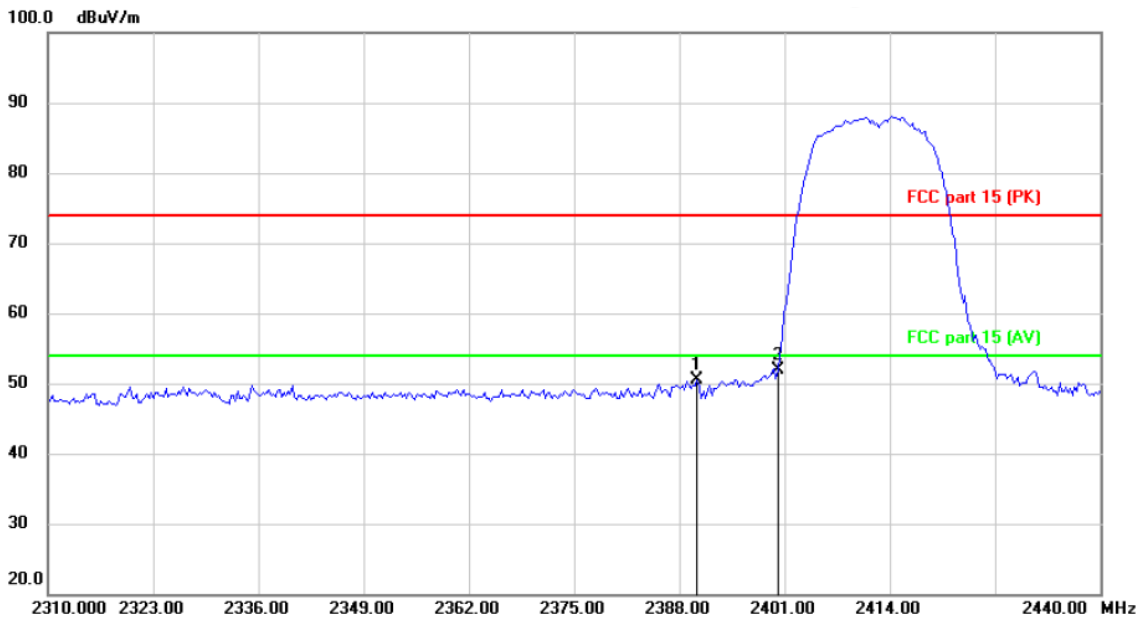

Site: Polarization: *Vertical* Temperature: 25
Limit: FCC part 15 (PK) Power: DC 3.7V Humidity: 55 %

No.	Mk.	Freq. MHz	Reading Level dBuV	Correct Factor dB	Measure- ment dBuV/m	Limit dBuV/m	Over dB	Detector
1		2390.000	47.83	2.66	50.49	74.00	-23.51	peak
2	*	2400.000	49.29	2.66	51.95	74.00	-22.05	peak

Highest channel 2462:

Horizontal:

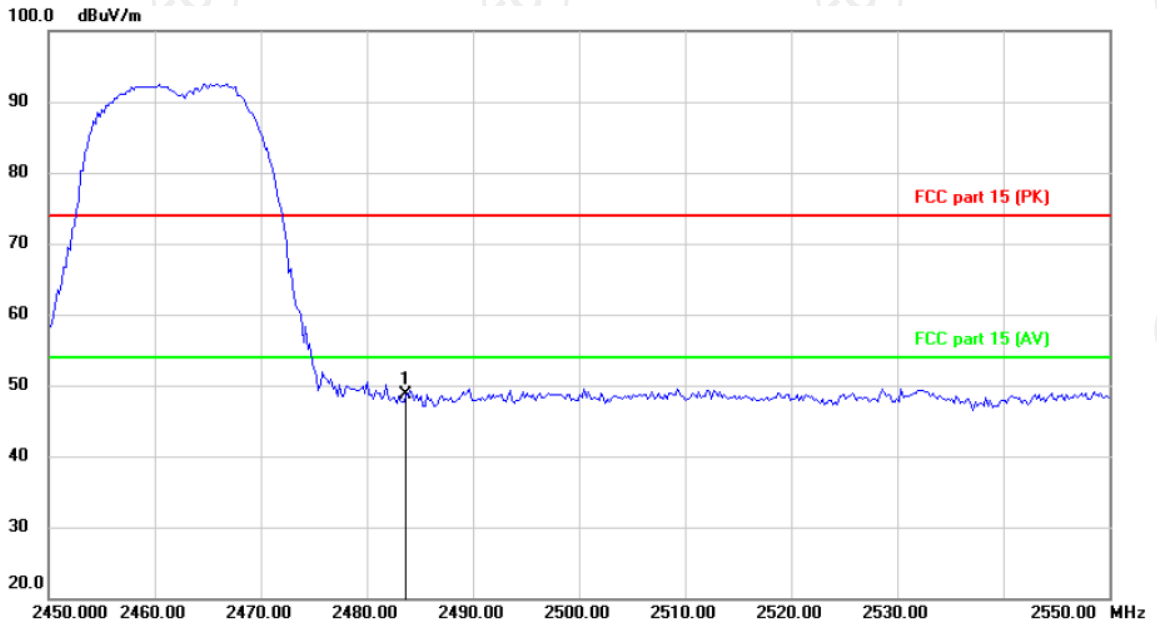

Site: Polarization: *Horizontal* Temperature: 25
Limit: FCC part 15 (PK) Power: DC 3.7V Humidity: 55 %

No.	Mk.	Freq. MHz	Reading Level dBuV	Correct Factor dB	Measure- ment dBuV/m	Limit dBuV/m	Over dB	Detector
1	*	2483.500	46.11	2.67	48.78	74.00	-25.22	peak

Vertical:

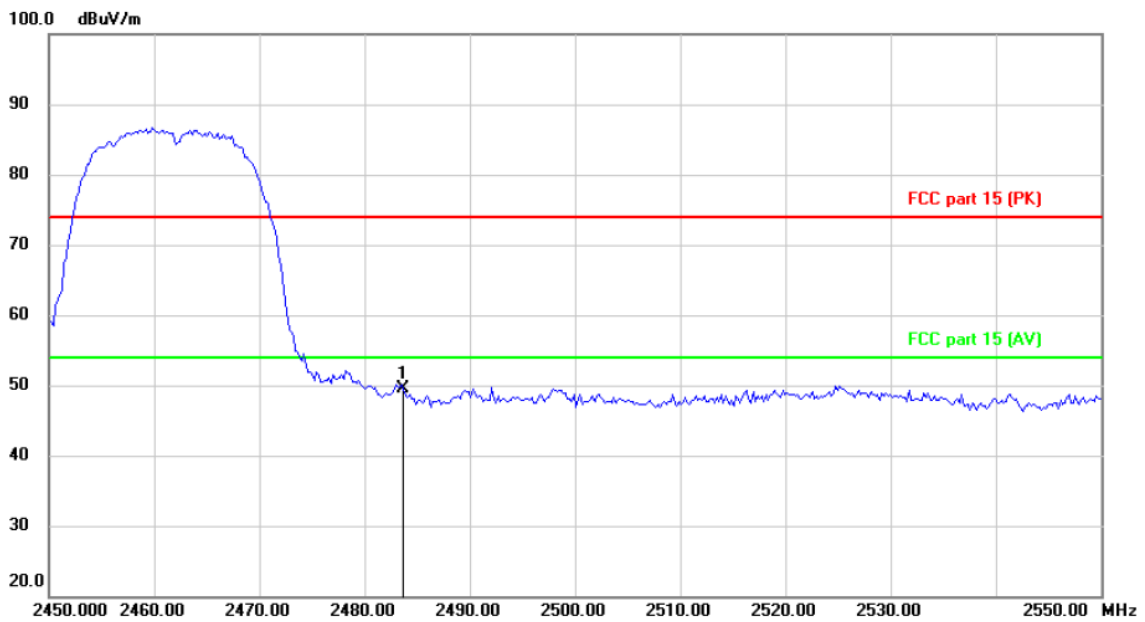

Site	Polarization: Vertical	Temperature: 25
Limit: FCC part 15 (PK)	Power: DC 3.7V	Humidity: 55 %

No.	Mk.	Freq. MHz	Reading Level dBuV	Correct Factor dB	Measure- ment dBuV/m	Limit dBuV/m	Over dB	Detector
1	*	2483.500	46.74	2.67	49.41	74.00	-24.59	peak

Note:

1. Peak Final Emission Level=Peak Reading + Correction Factor;
2. Correction Factor= Antenna Factor + Cable loss – Pre-amplifier
3. Measurements were conducted in all modulation(802.11b, 802.11g, 802.11n(HT20), 802.11n(HT40)), and the worst case (802.11n(HT20) in MIMO mode) was submitted only.

Test Result of Radiated Spurious at harmonic frequencies

Modulation Type: 802.11b

Low channel: 2412 MHz

Frequency (MHz)	Ant. Pol. H/V	Peak reading (dBμV)	AV reading (dBμV)	Correction Factor (dB/m)	Emission Level		Peak limit (dBμV/m)	AV limit (dBμV/m)	Margin (dB)
					Peak (dBμV/m)	AV (dBμV/m)			
4824	H	47.58	---	0.75	48.33	---	74	54	-5.67
7236	H	36.79	---	9.87	46.66	---	74	54	-7.34
---	H	---	---	---	---	---	---	---	---
4824	V	44.94	---	0.75	45.69	---	74	54	-8.31
7236	V	35.12	---	9.87	44.99	---	74	54	-9.01
---	V	---	---	---	---	---	---	---	---

Middle channel: 2437MHz

Frequency (MHz)	Ant. Pol. H/V	Peak reading (dBμV)	AV reading (dBμV)	Correction Factor (dB/m)	Emission Level		Peak limit (dBμV/m)	AV limit (dBμV/m)	Margin (dB)
					Peak (dBμV/m)	AV (dBμV/m)			
4874	H	46.14	---	0.97	47.11	---	74	54	-6.89
7311	H	34.87	---	9.83	44.70	---	74	54	-9.30
---	H	---	---	---	---	---	---	---	---
4874	V	48.66	---	0.97	49.63	---	74	54	-4.37
7311	V	37.23	---	9.83	47.06	---	74	54	-6.94
---	V	---	---	---	---	---	---	---	---

High channel: 2462 MHz

Frequency (MHz)	Ant. Pol. H/V	Peak reading (dBμV)	AV reading (dBμV)	Correction Factor (dB/m)	Emission Level		Peak limit (dBμV/m)	AV limit (dBμV/m)	Margin (dB)
					Peak (dBμV/m)	AV (dBμV/m)			
4924	H	45.52	---	1.18	46.70	---	74	54	-7.30
7386	H	34.43	---	10.07	44.50	---	74	54	-9.50
---	H	---	---	---	---	---	---	---	---
4924	V	47.88	---	1.18	49.06	---	74	54	-4.94
7386	V	38.71	---	10.07	48.78	---	74	54	-5.22
---	V	---	---	---	---	---	---	---	---

Note:

1. Emission Level=Peak Reading + Correction Factor; Correction Factor= Antenna Factor + Cable loss – Pre-amplifier
2. Margin (dB) = Emission Level (Peak) (dBμV/m)-Average limit (dBμV/m)
3. The emission levels of other frequencies are very lower than the limit and not show in test report.
4. Measurements were conducted from 1 GHz to the 10th harmonic of highest fundamental frequency. The highest test frequency is 25GHz.
5. Data of measurement shown "---" in the above table mean that the reading of emissions is attenuated more than 20 dB below the limits or the field strength is too small to be measured.
6. 802.11b is SISO mode and the worst case Antenna (ANT0) was submitted only.

Modulation Type: 802.11g

Low channel: 2412 MHz

Frequency (MHz)	Ant. Pol. H/V	Peak reading (dBμV)	AV reading (dBμV)	Correction Factor (dB/m)	Emission Level		Peak limit (dBμV/m)	AV limit (dBμV/m)	Margin (dB)
					Peak (dBμV/m)	AV (dBμV/m)			
4824	H	45.74	---	0.75	46.49	---	74	54	-7.51
7236	H	34.52	---	9.87	44.39	---	74	54	-9.61
---	H	---	---	---	---	---	---	---	---
4824	V	46.69	---	0.75	47.44	---	74	54	-6.56
7236	V	35.43	---	9.87	45.30	---	74	54	-8.70
---	V	---	---	---	---	---	---	---	---

Middle channel: 2437MHz

Frequency (MHz)	Ant. Pol. H/V	Peak reading (dBμV)	AV reading (dBμV)	Correction Factor (dB/m)	Emission Level		Peak limit (dBμV/m)	AV limit (dBμV/m)	Margin (dB)
					Peak (dBμV/m)	AV (dBμV/m)			
4874	H	44.95	---	0.97	45.92	---	74	54	-8.08
7311	H	35.37	---	9.83	45.20	---	74	54	-8.80
---	H	---	---	---	---	---	---	---	---
4874	V	47.22	---	0.97	48.19	---	74	54	-5.81
7311	V	38.36	---	9.83	48.19	---	74	54	-5.81
---	V	---	---	---	---	---	---	---	---

High channel: 2462 MHz

Frequency (MHz)	Ant. Pol. H/V	Peak reading (dBμV)	AV reading (dBμV)	Correction Factor (dB/m)	Emission Level		Peak limit (dBμV/m)	AV limit (dBμV/m)	Margin (dB)
					Peak (dBμV/m)	AV (dBμV/m)			
4924	H	43.59	---	1.18	44.77	---	74	54	-9.23
7386	H	34.23	---	10.07	44.30	---	74	54	-9.70
---	H	---	---	---	---	---	---	---	---
4924	V	47.38	---	1.18	48.56	---	74	54	-5.44
7386	V	36.92	---	10.07	46.99	---	74	54	-7.01
---	V	---	---	---	---	---	---	---	---

Note:

1. Emission Level=Peak Reading + Correction Factor; Correction Factor= Antenna Factor + Cable loss – Pre-amplifier
2. Margin (dB) = Emission Level (Peak) (dBμV/m)-Average limit (dBμV/m)
3. The emission levels of other frequencies are very lower than the limit and not show in test report.
4. Measurements were conducted from 1 GHz to the 10th harmonic of highest fundamental frequency. The highest test frequency is 25GHz.
5. Data of measurement shown "---" in the above table mean that the reading of emissions is attenuated more than 20 dB below the limits or the field strength is too small to be measured.
6. 802.11g is SISO mode and the worst case Antenna (ANT0) was submitted only.

Modulation Type: 802.11n (HT20)

Low channel: 2412 MHz

Frequency (MHz)	Ant. Pol. H/V	Peak reading (dB μ V)	AV reading (dB μ V)	Correction Factor (dB/m)	Emission Level		Peak limit (dB μ V/m)	AV limit (dB μ V/m)	Margin (dB)
					Peak (dB μ V/m)	AV (dB μ V/m)			
4824	H	44.11	---	0.75	44.86	---	74	54	-9.14
7236	H	35.34	---	9.87	45.21	---	74	54	-8.79
---	H	---	---	---	---	---	---	---	---
4824	V	44.83	---	0.75	45.58	---	74	54	-8.42
7236	V	34.28	---	9.87	44.15	---	74	54	-9.85
---	V	---	---	---	---	---	---	---	---

Middle channel: 2437MHz

Frequency (MHz)	Ant. Pol. H/V	Peak reading (dB μ V)	AV reading (dB μ V)	Correction Factor (dB/m)	Emission Level		Peak limit (dB μ V/m)	AV limit (dB μ V/m)	Margin (dB)
					Peak (dB μ V/m)	AV (dB μ V/m)			
4874	H	46.17	---	0.97	47.14	---	74	54	-6.86
7311	H	35.62	---	9.83	45.45	---	74	54	-8.55
---	H	---	---	---	---	---	---	---	---
4874	V	45.75	---	0.97	46.72	---	74	54	-7.28
7311	V	36.26	---	9.83	46.09	---	74	54	-7.91
---	V	---	---	---	---	---	---	---	---

High channel: 2462 MHz

Frequency (MHz)	Ant. Pol. H/V	Peak reading (dB μ V)	AV reading (dB μ V)	Correction Factor (dB/m)	Emission Level		Peak limit (dB μ V/m)	AV limit (dB μ V/m)	Margin (dB)
					Peak (dB μ V/m)	AV (dB μ V/m)			
4924	H	43.62	---	1.18	44.80	---	74	54	-9.20
7386	H	34.22	---	10.07	44.29	---	74	54	-9.71
---	H	---	---	---	---	---	---	---	---
4924	V	45.94	---	1.18	47.12	---	74	54	-6.88
7386	V	36.39	---	10.07	46.46	---	74	54	-7.54
---	V	---	---	---	---	---	---	---	---

Note:

1. Emission Level=Peak Reading + Correction Factor; Correction Factor= Antenna Factor + Cable loss – Pre-amplifier
2. Margin (dB) = Emission Level (Peak) (dB μ V/m)-Average limit (dB μ V/m)
3. The emission levels of other frequencies are very lower than the limit and not show in test report.
4. Measurements were conducted from 1 GHz to the 10th harmonic of highest fundamental frequency. The highest test frequency is 25GHz.
5. Data of measurement shown "---" in the above table mean that the reading of emissions is attenuated more than 20 dB below the limits or the field strength is too small to be measured.
6. 802.11n(HT20) is MIMO mode.

Modulation Type: 802.11n (HT40)

Low channel: 2422 MHz

Frequency (MHz)	Ant. Pol. H/V	Peak reading (dB μ V)	AV reading (dB μ V)	Correction Factor (dB/m)	Emission Level		Peak limit (dB μ V/m)	AV limit (dB μ V/m)	Margin (dB)
					Peak (dB μ V/m)	AV (dB μ V/m)			
4844	H	46.55	---	0.75	47.30	---	74	54	-6.70
7266	H	35.34	---	9.87	45.21	---	74	54	-8.79
---	H	---	---	---	---	---	---	---	---
4824	V	43.72	---	0.75	44.47	---	74	54	-9.53
7236	V	34.19	---	9.87	44.06	---	74	54	-9.94
---	V	---	---	---	---	---	---	---	---

Middle channel: 2437MHz

Frequency (MHz)	Ant. Pol. H/V	Peak reading (dB μ V)	AV reading (dB μ V)	Correction Factor (dB/m)	Emission Level		Peak limit (dB μ V/m)	AV limit (dB μ V/m)	Margin (dB)
					Peak (dB μ V/m)	AV (dB μ V/m)			
4874	H	45.44	---	0.97	46.41	---	74	54	-7.59
7311	H	35.58	---	9.83	45.41	---	74	54	-8.59
---	H	---	---	---	---	---	---	---	---
4874	V	44.62	---	0.97	45.59	---	74	54	-8.41
7311	V	35.11	---	9.83	44.94	---	74	54	-9.06
---	V	---	---	---	---	---	---	---	---

High channel: 2452 MHz

Frequency (MHz)	Ant. Pol. H/V	Peak reading (dB μ V)	AV reading (dB μ V)	Correction Factor (dB/m)	Emission Level		Peak limit (dB μ V/m)	AV limit (dB μ V/m)	Margin (dB)
					Peak (dB μ V/m)	AV (dB μ V/m)			
4904	H	43.96	---	1.18	45.14	---	74	54	-8.86
7356	H	33.43	---	10.07	43.5	---	74	54	-10.5
---	H	---	---	---	---	---	---	---	---
4904	V	45.68	---	1.18	46.86	---	74	54	-7.14
7356	V	36.21	---	10.07	46.28	---	74	54	-7.72
---	V	---	---	---	---	---	---	---	---

Note:

1. Emission Level=Peak Reading + Correction Factor; Correction Factor= Antenna Factor + Cable loss – Pre-amplifier
2. Margin (dB) = Emission Level (Peak) (dB μ V/m)-Average limit (dB μ V/m)
3. The emission levels of other frequencies are very lower than the limit and not show in test report.
4. Measurements were conducted from 1 GHz to the 10th harmonic of highest fundamental frequency. The highest test frequency is 25GHz.
5. Data of measurement shown “---“in the above table mean that the reading of emissions is attenuated more than 20 dB below the limits or the field strength is too small to be measured.
6. 802.11n(HT40) is MIMO mode.

Appendix A: Test Result of Conducted Test

DTS Bandwidth

Test Result

Test Mode	Antenna	Channel	DTS BW [MHz]	FL[MHz]	FH[MHz]	Limit[MHz]	Verdict
11B	Ant0	2412	8.160	2407.920	2416.080	0.5	PASS
	Ant1	2412	9.120	2407.440	2416.560	0.5	PASS
	Ant0	2437	8.160	2432.920	2441.080	0.5	PASS
	Ant1	2437	8.200	2432.400	2440.600	0.5	PASS
	Ant0	2462	8.200	2457.400	2465.600	0.5	PASS
	Ant1	2462	8.160	2457.920	2466.080	0.5	PASS
11G	Ant0	2412	15.400	2404.440	2419.840	0.5	PASS
	Ant1	2412	16.000	2404.200	2420.200	0.5	PASS
	Ant0	2437	16.160	2429.040	2445.200	0.5	PASS
	Ant1	2437	14.720	2429.160	2443.880	0.5	PASS
	Ant0	2462	15.800	2453.800	2469.600	0.5	PASS
	Ant1	2462	16.120	2453.800	2469.920	0.5	PASS
11N20SISO	Ant0	2412	16.600	2403.560	2420.160	0.5	PASS
	Ant1	2412	17.680	2403.160	2420.840	0.5	PASS
	Ant0	2437	17.600	2428.200	2445.800	0.5	PASS
	Ant1	2437	15.480	2429.080	2444.560	0.5	PASS
	Ant0	2462	16.400	2453.160	2469.560	0.5	PASS
	Ant1	2462	17.640	2453.160	2470.800	0.5	PASS
11N40SISO	Ant0	2422	35.280	2404.320	2439.600	0.5	PASS
	Ant1	2422	35.280	2404.320	2439.600	0.5	PASS
	Ant0	2437	35.520	2419.080	2454.600	0.5	PASS
	Ant1	2437	35.280	2419.320	2454.600	0.5	PASS
	Ant0	2452	35.200	2434.400	2469.600	0.5	PASS
	Ant1	2452	35.840	2433.760	2469.600	0.5	PASS

Test Graphs

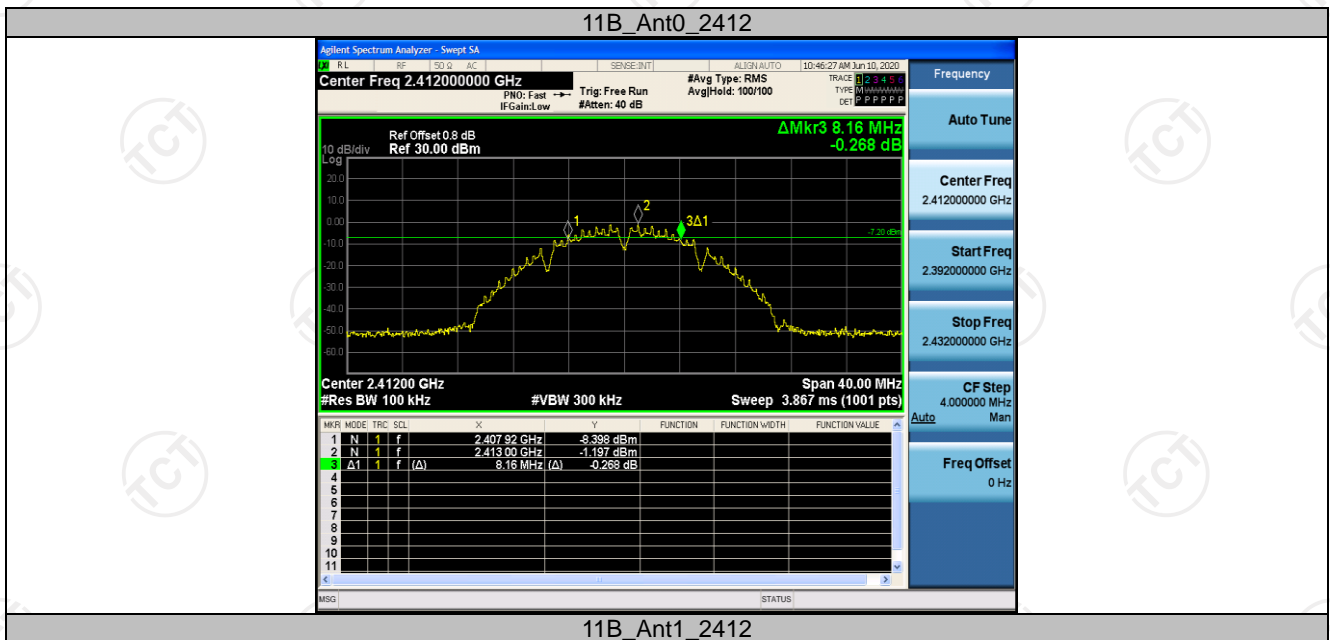

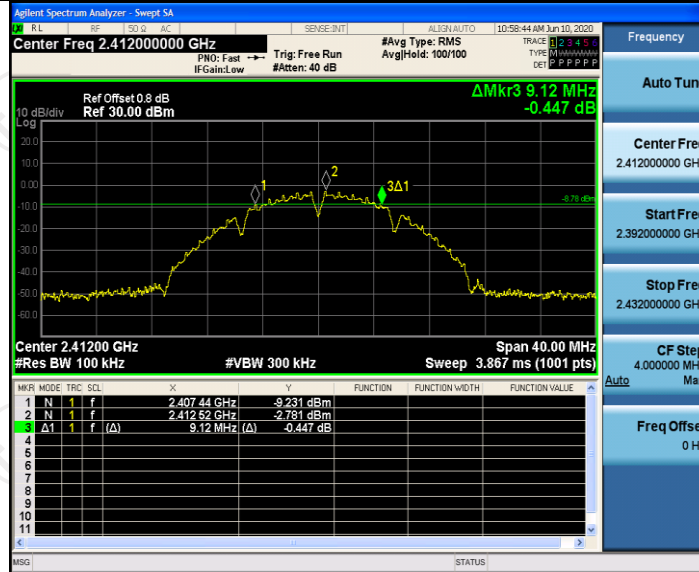

11B_Ant0_2437



11B_Ant1_2437

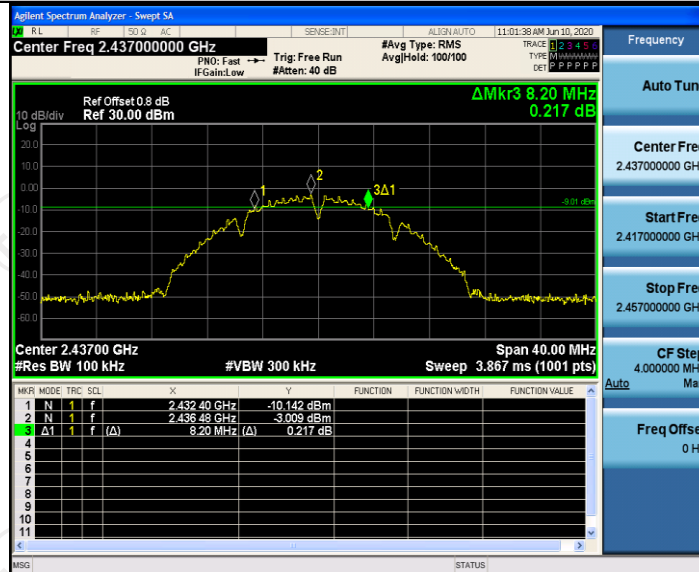

11B_Ant0_2462

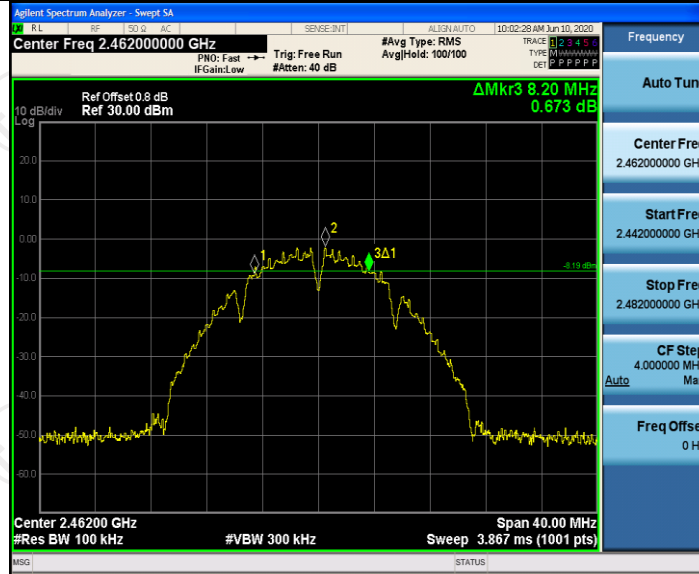

11B_Ant1_2462

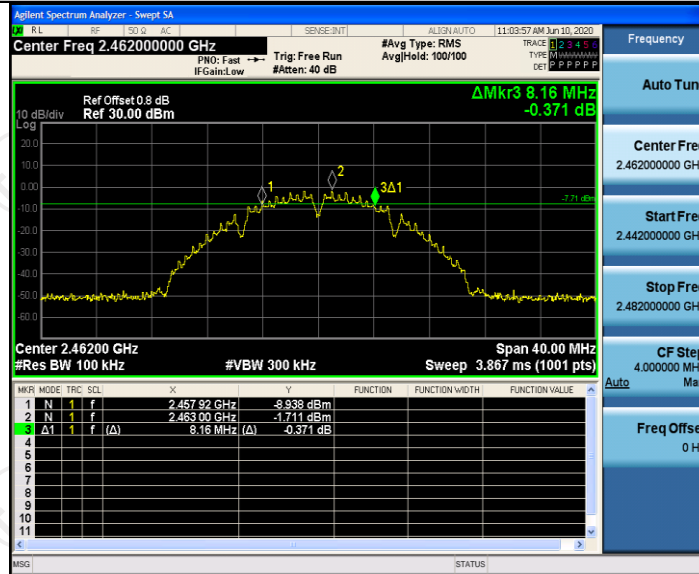

11G_Ant0_2412



11G_Ant1_2412



11G_Ant0_2437

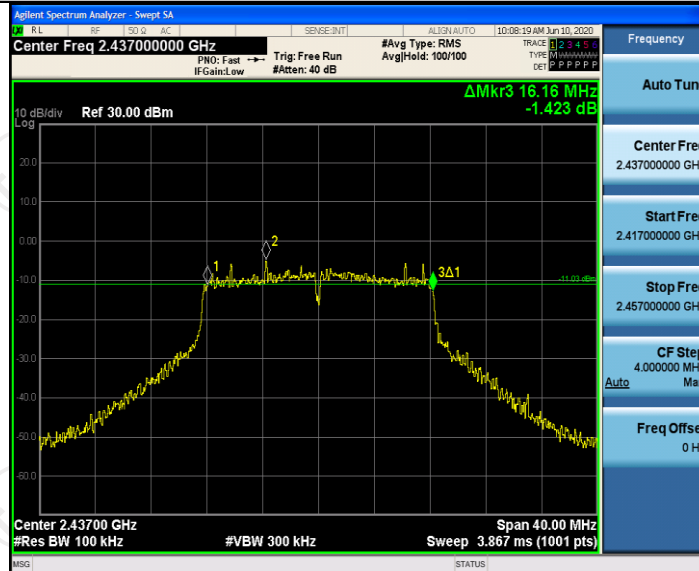

11G_Ant1_2437



11G_Ant0_2462



11G_Ant1_2462



11N20SISO_Ant0_2412

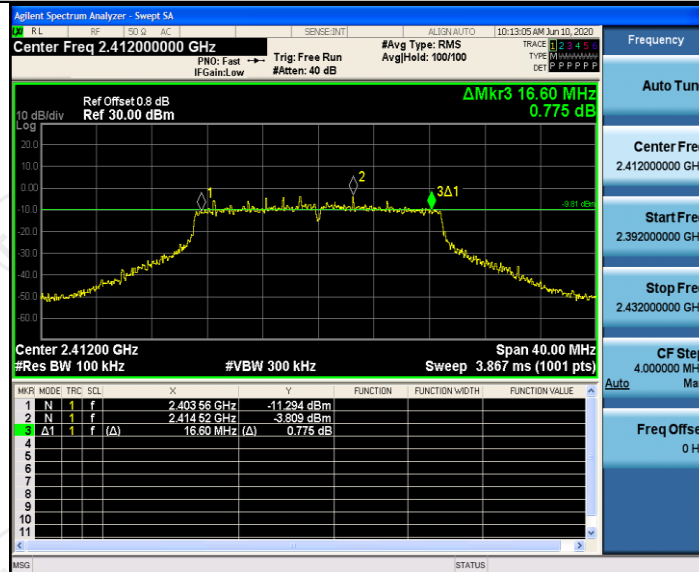

11N20SISO_Ant1_2412



11N20SISO_Ant0_2437

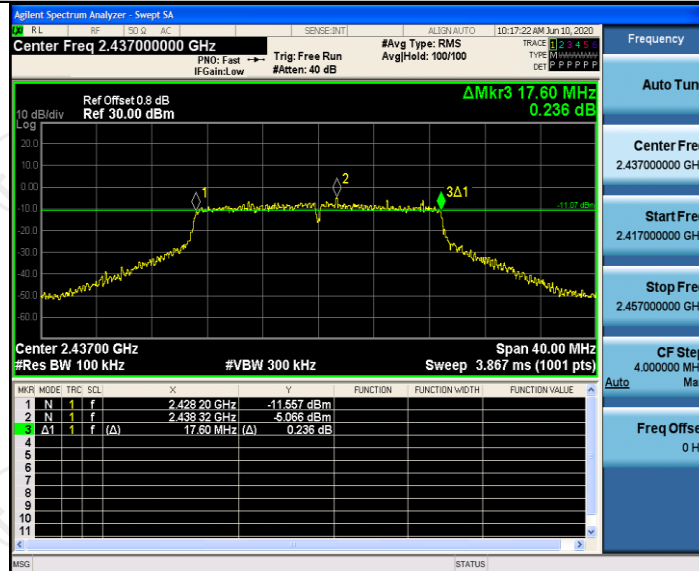

11N20SISO_Ant1_2437



11N20SISO_Ant0_2462



11N20SISO_Ant1_2462



11N40SISO_Ant0_2422

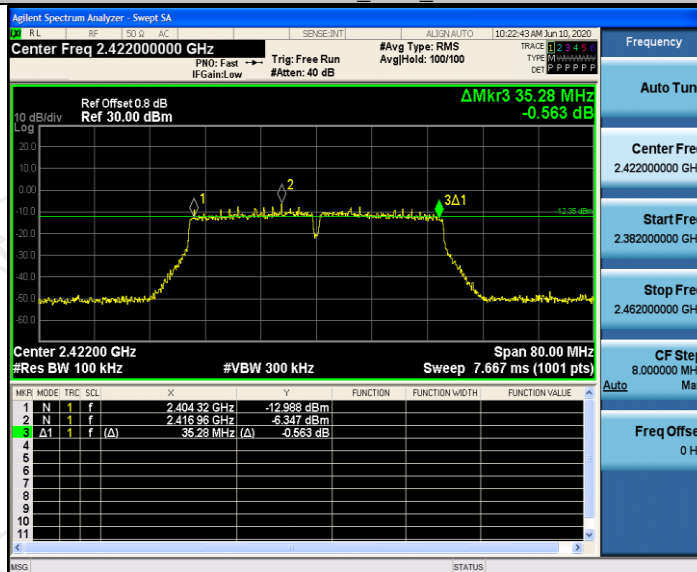

11N40SISO_Ant1_2422

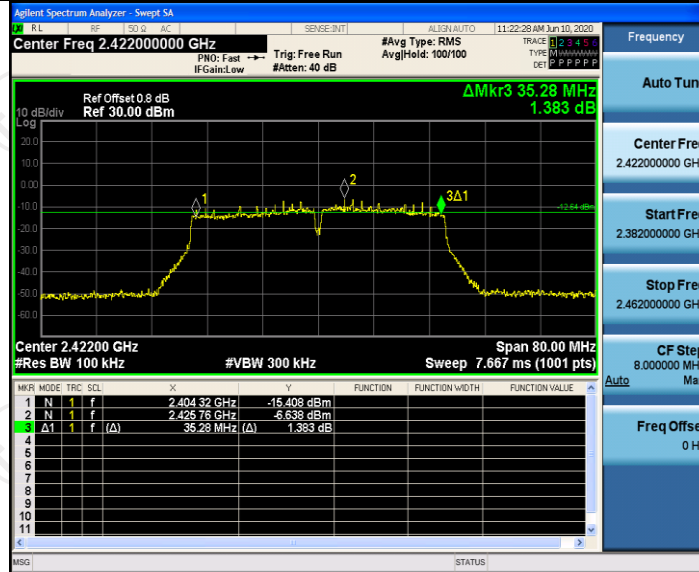

11N40SISO_Ant0_2437

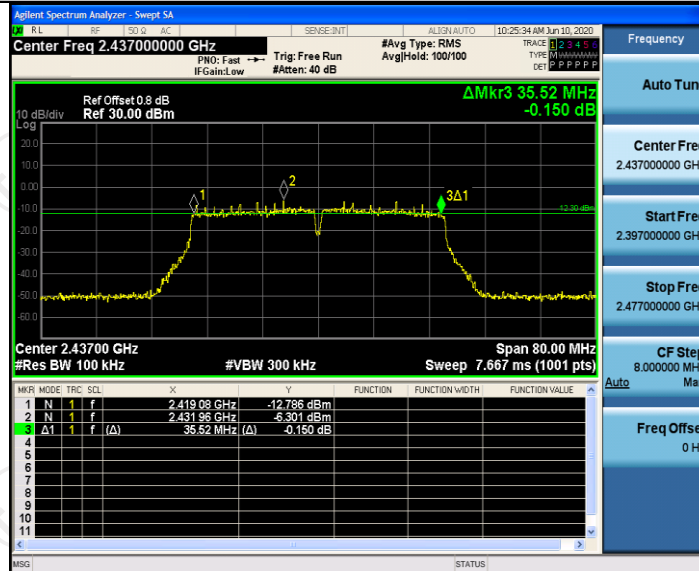

11N40SISO_Ant1_2437

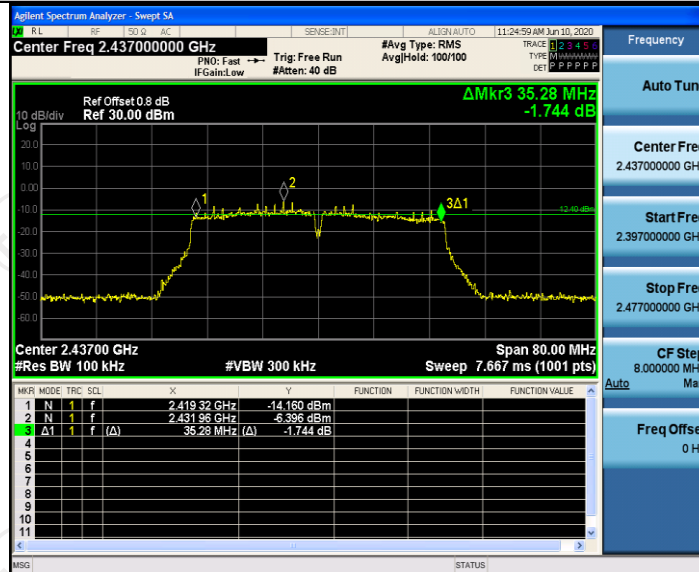

11N40SISO_Ant0_2452

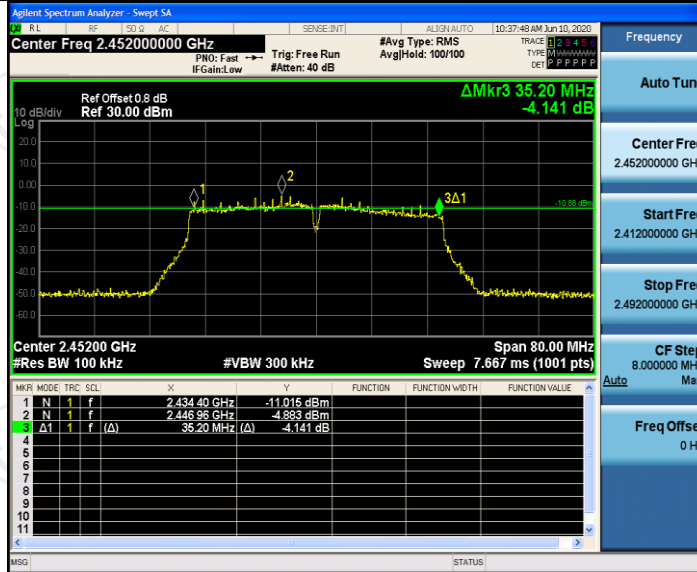

11N40SISO_Ant1_2452

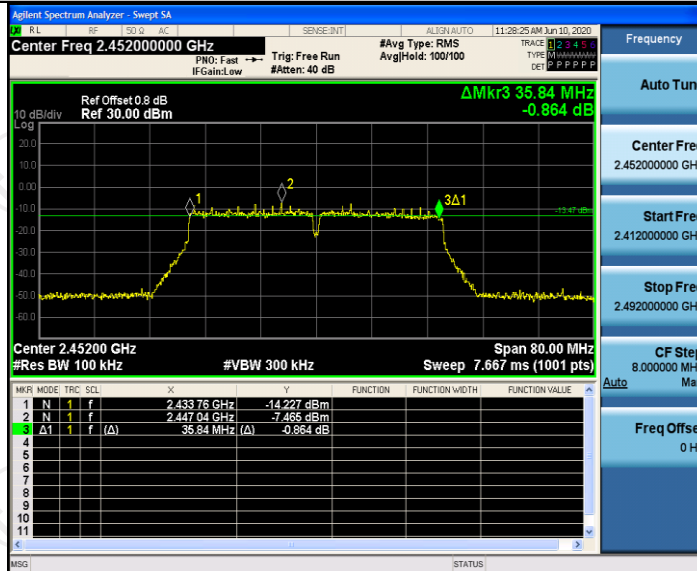

Occupied Channel Bandwidth

Test Result

Test Mode	Antenna	Channel	OCB[MHz]	FL[MHz]	FH[MHz]	Limit[MHz]	Verdict
11B	Ant0	2412	13.727	2405.189	2418.916	---	PASS
	Ant1	2412	14.027	2405.105	2419.132	---	PASS
	Ant0	2437	13.833	2430.099	2443.932	---	PASS
	Ant1	2437	13.731	2429.909	2443.640	---	PASS
	Ant0	2462	13.884	2454.854	2468.738	---	PASS
	Ant1	2462	13.742	2455.115	2468.857	---	PASS
11G	Ant0	2412	16.853	2403.601	2420.454	---	PASS
	Ant1	2412	16.978	2403.581	2420.559	---	PASS
	Ant0	2437	16.808	2428.612	2445.420	---	PASS
	Ant1	2437	16.799	2428.504	2445.303	---	PASS
	Ant0	2462	16.960	2453.373	2470.333	---	PASS
	Ant1	2462	16.814	2453.563	2470.377	---	PASS
11N20SISO	Ant0	2412	17.964	2403.041	2421.005	---	PASS
	Ant1	2412	18.169	2402.981	2421.150	---	PASS
	Ant0	2437	18.039	2428.023	2446.062	---	PASS
	Ant1	2437	17.957	2427.930	2445.887	---	PASS
	Ant0	2462	18.111	2452.824	2470.935	---	PASS
	Ant1	2462	17.981	2452.988	2470.969	---	PASS
11N40SISO	Ant0	2422	36.319	2403.894	2440.213	---	PASS
	Ant1	2422	36.267	2403.970	2440.237	---	PASS
	Ant0	2437	36.366	2418.804	2455.170	---	PASS
	Ant1	2437	36.241	2418.886	2455.127	---	PASS
	Ant0	2452	36.207	2433.786	2469.993	---	PASS
	Ant1	2452	36.444	2433.703	2470.147	---	PASS

Test Graphs

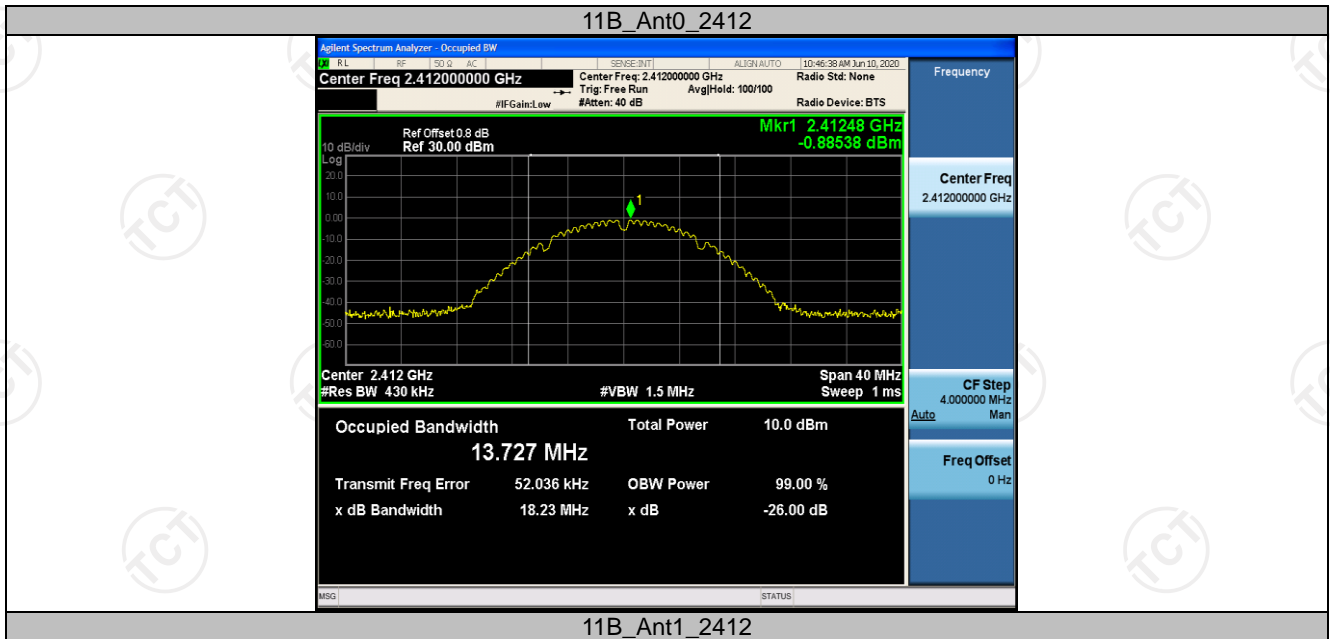



11B_Ant0_2437

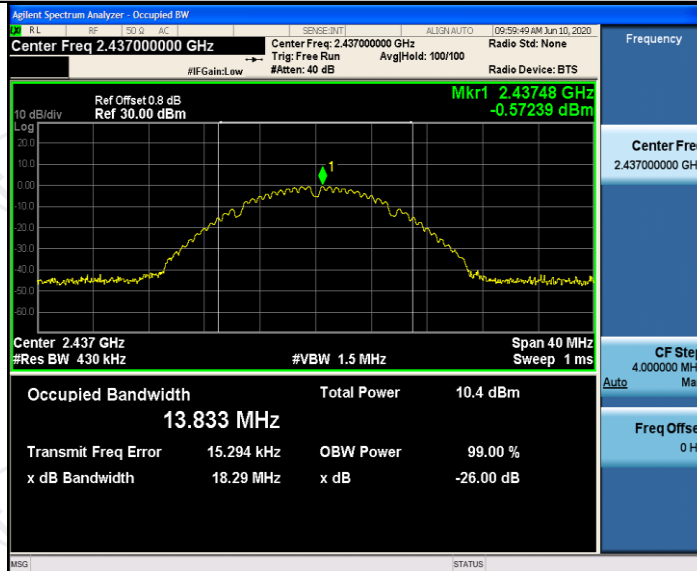

11B_Ant1_2437

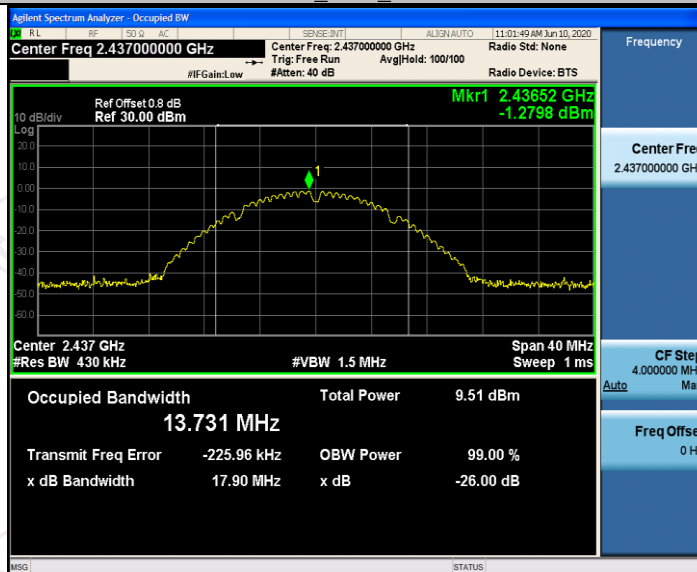

11B_Ant0_2462

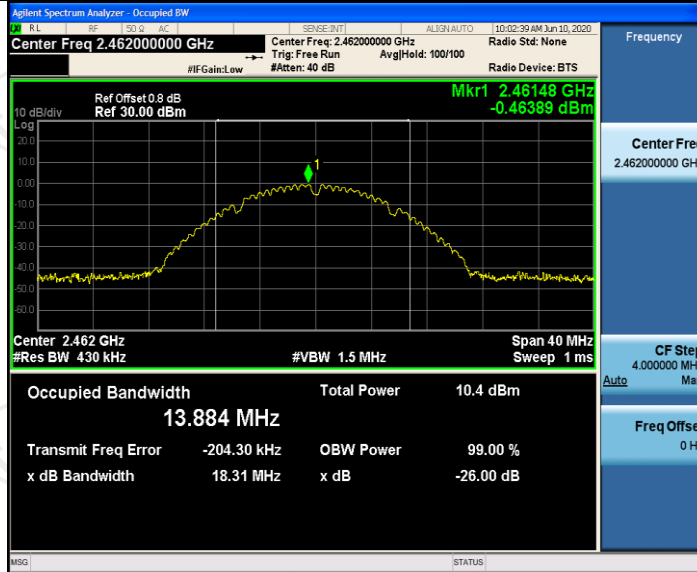

11B_Ant1_2462

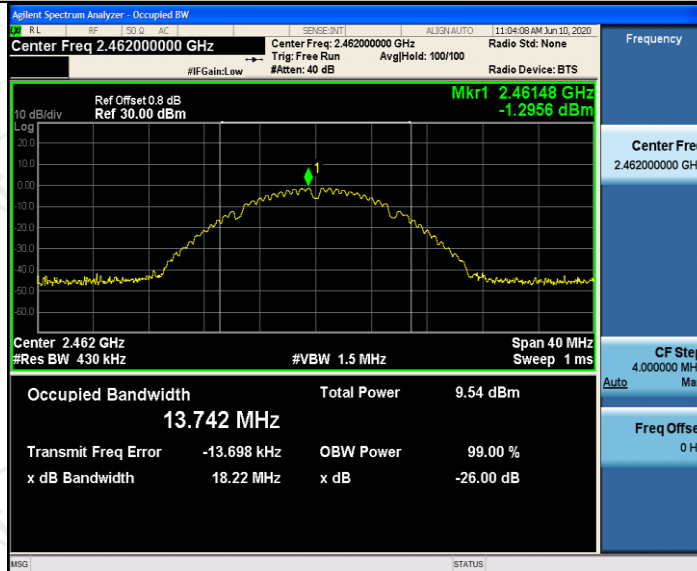

11G_Ant0_2412

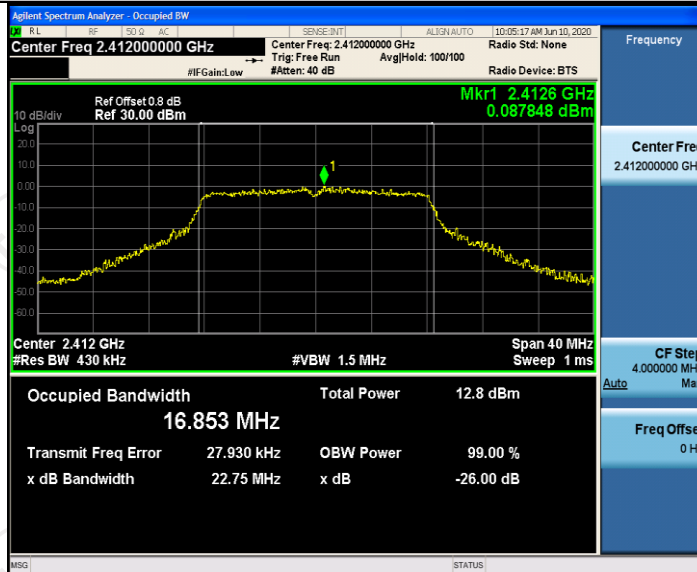

11G_Ant1_2412

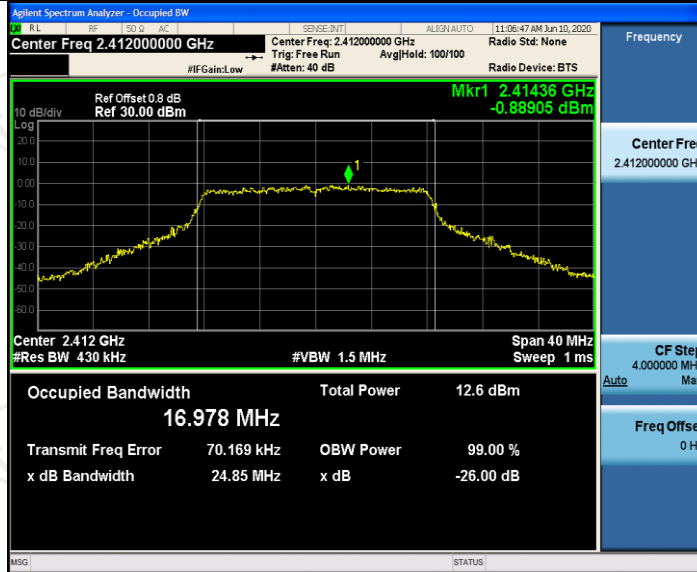

11G_Ant0_2437

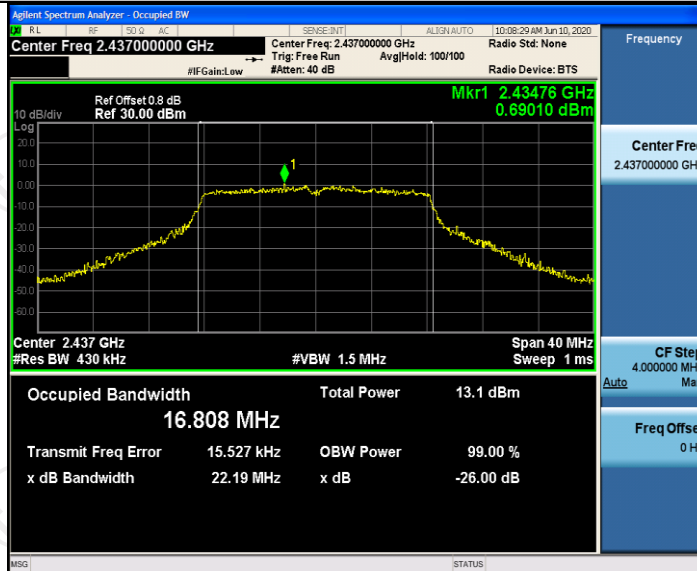

11G_Ant1_2437

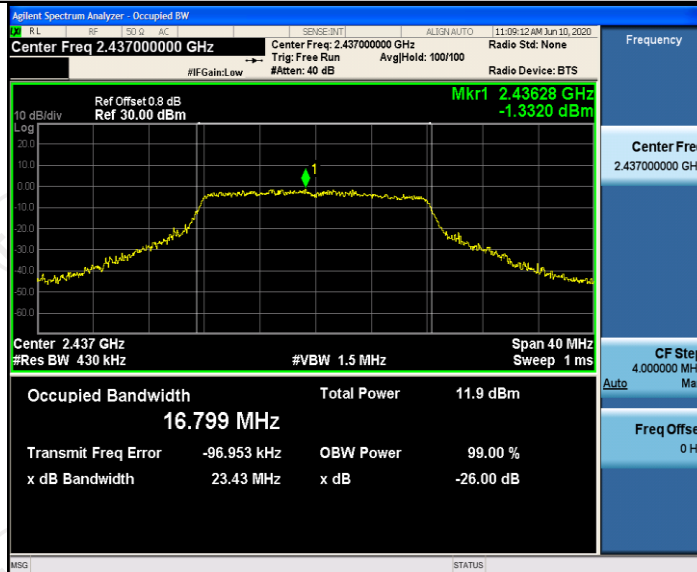

11G_Ant0_2462



11G_Ant1_2462

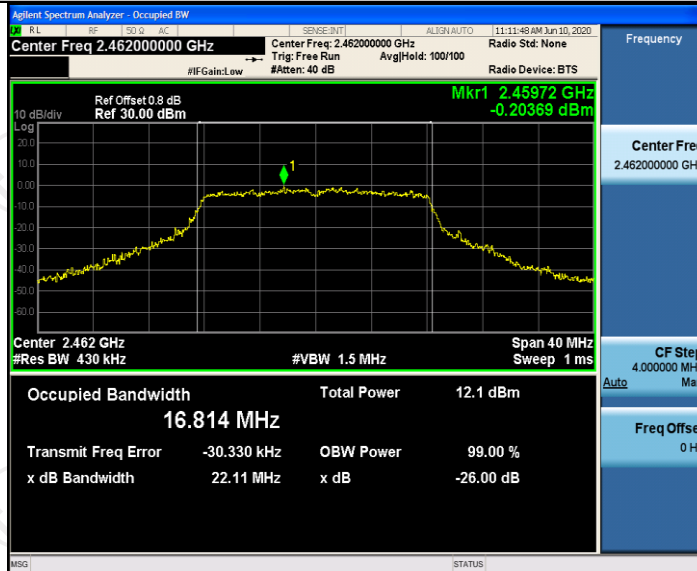

11N20SISO_Ant0_2412

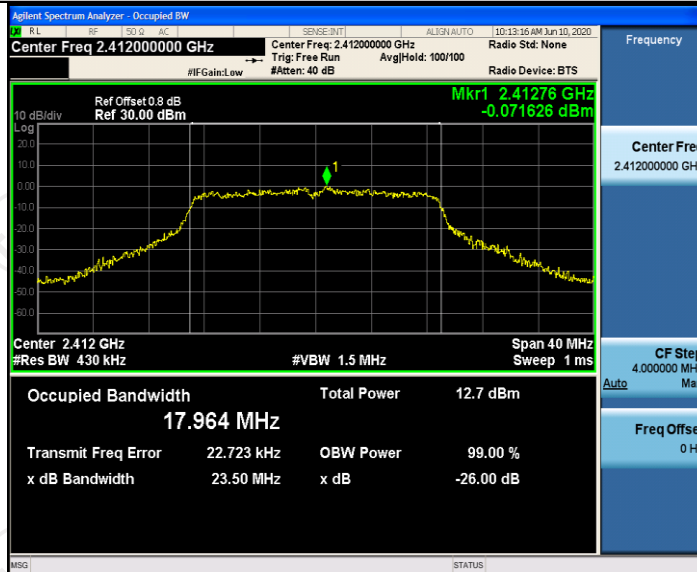

11N20SISO_Ant1_2412

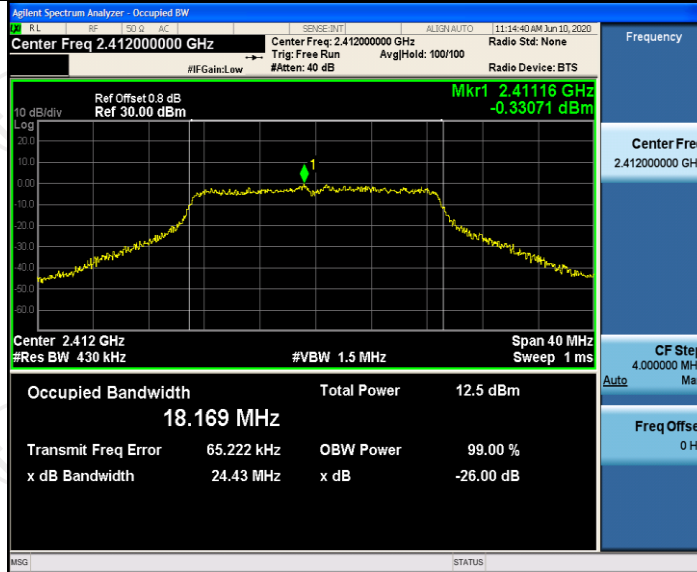

11N20SISO_Ant0_2437

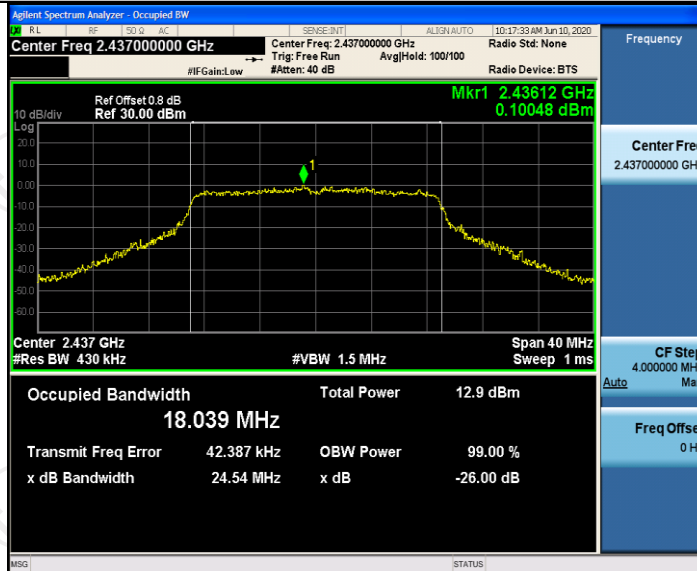

11N20SISO_Ant1_2437



11N20SISO_Ant0_2462