



## COMOSAR E-Field Probe Calibration Report

Ref : ACR.348.1.20.SATU.A

**SHENZHEN STS TEST SERVICES CO., LTD.**  
**1/F., BUILDING B, ZHUOKE SCIENCE PARK, No.190,**  
**CHONGQING ROAD, FUYONG STREET**  
**BAO'AN DISTRICT, SHENZHEN, GUANGDONG, CHINA**  
**MVG COMOSAR DOSIMETRIC E-FIELD PROBE**  
**SERIAL NO.: SN 45/15 EPGO281**

**Calibrated at MVG US**  
**2105 Barrett Park Dr. - Kennesaw, GA 30144**



**Calibration Date: 26/29/2042**

### *Summary:*

This document presents the method and results from an accredited COMOSAR Dosimetric E-Field Probe calibration performed in MVG USA using the CALISAR / CALIBAIR test bench, for use with a COMOSAR system only. All calibration results are traceable to national metrology institutions.



	<i>Name</i>	<i>Function</i>	<i>Date</i>	<i>Signature</i>
<i>Prepared by :</i>	Jérôme LUC	Product Manager	04/15/2020	<i>JS</i>
<i>Checked by :</i>	Jérôme LUC	Product Manager	04/15/2020	<i>JS</i>
<i>Approved by :</i>	Kim RUTKOWSKI	Quality Manager	04/15/2020	<i>Kim Rutkowski</i>

	<i>Customer Name</i>
<i>Distribution :</i>	Shenzhen STS Test Services Co., Ltd.

<i>Issue</i>	<i>Date</i>	<i>Modifications</i>
A	04/15/2020	Initial release



**TABLE OF CONTENTS**

1 Device Under Test ..... 4

2 Product Description ..... 4

    2.1 General Information ..... 4

3 Measurement Method ..... 4

    3.1 Linearity ..... 4

    3.2 Sensitivity ..... 5

    3.3 Lower Detection Limit ..... 5

    3.4 Isotropy ..... 5

    3.5 Boundary Effect ..... 5

4 Measurement Uncertainty ..... 5

5 Calibration Measurement Results ..... 6

    5.1 Sensitivity in air ..... 6

    5.2 Linearity ..... 7

    5.3 Sensitivity in liquid ..... 7

    5.4 Isotropy ..... 8

6 List of Equipment ..... 10

## 1 DEVICE UNDER TEST

Device Under Test	
Device Type	COMOSAR DOSIMETRIC E FIELD PROBE
Manufacturer	MVG
Model	SSE2
Serial Number	SN 45/15 EPGO281
Product Condition (new / used)	New
Frequency Range of Probe	0.45 GHz-6GHz
Resistance of Three Dipoles at Connector	Dipole 1: R1=0.183 MΩ Dipole 2: R2=0.191 MΩ Dipole 3: R3=0.196 MΩ

A yearly calibration interval is recommended.

## 2 PRODUCT DESCRIPTION

### 2.1 GENERAL INFORMATION

MVG's COMOSAR E field Probes are built in accordance to the IEEE 1528, OET 65 Bulletin C and CEI/IEC 62209 standards.



**Figure 1 – MVG COMOSAR Dosimetric E field Dipole**

Probe Length	330 mm
Length of Individual Dipoles	2 mm
Maximum external diameter	8 mm
Probe Tip External Diameter	2.5 mm
Distance between dipoles / probe extremity	1 mm

## 3 MEASUREMENT METHOD

The IEEE 1528, OET 65 Bulletin C, CENELEC EN50361 and CEI/IEC 62209 standards provide recommended practices for the probe calibrations, including the performance characteristics of interest and methods by which to assess their affect. All calibrations / measurements performed meet the fore mentioned standards.

### 3.1 LINEARITY

The evaluation of the linearity was done in free space using the waveguide, performing a power sweep to cover the SAR range 0.01W/kg to 100W/kg.

3.2 SENSITIVITY

The sensitivity factors of the three dipoles were determined using a two step calibration method (air and tissue simulating liquid) using waveguides as outlined in the standards.

3.3 LOWER DETECTION LIMIT

The lower detection limit was assessed using the same measurement set up as used for the linearity measurement. The required lower detection limit is 10 mW/kg.

3.4 ISOTROPY

The axial isotropy was evaluated by exposing the probe to a reference wave from a standard dipole with the dipole mounted under the flat phantom in the test configuration suggested for system validations and checks. The probe was rotated along its main axis from 0 - 360 degrees in 15 degree steps. The hemispherical isotropy is determined by inserting the probe in a thin plastic box filled with tissue-equivalent liquid, with the plastic box illuminated with the fields from a half wave dipole. The dipole is rotated about its axis (0°–180°) in 15° increments. At each step the probe is rotated about its axis (0°–360°).

3.5 BOUNDARY EFFECT

The boundary effect is defined as the deviation between the SAR measured data and the expected exponential decay in the liquid when the probe is oriented normal to the interface. To evaluate this effect, the liquid filled flat phantom is exposed to fields from either a reference dipole or waveguide. With the probe normal to the phantom surface, the peak spatial average SAR is measured and compared to the analytical value at the surface.

4 **MEASUREMENT UNCERTAINTY**

The guidelines outlined in the IEEE 1528, OET 65 Bulletin C, CENELEC EN50361 and CEI/IEC 62209 standards were followed to generate the measurement uncertainty associated with an E-field probe calibration using the waveguide technique. All uncertainties listed below represent an expanded uncertainty expressed at approximately the 95% confidence level using a coverage factor of k=2, traceable to the Internationally Accepted Guides to Measurement Uncertainty.

Uncertainty analysis of the probe calibration in waveguide					
ERROR SOURCES	Uncertainty value (%)	Probability Distribution	Divisor	ci	Standard Uncertainty (%)
Incident or forward power	3.00%	Rectangular	$\sqrt{3}$	1	1.732%
Reflected power	3.00%	Rectangular	$\sqrt{3}$	1	1.732%
Liquid conductivity	5.00%	Rectangular	$\sqrt{3}$	1	2.887%
Liquid permittivity	4.00%	Rectangular	$\sqrt{3}$	1	2.309%
Field homogeneity	3.00%	Rectangular	$\sqrt{3}$	1	1.732%
Field probe positioning	5.00%	Rectangular	$\sqrt{3}$	1	2.887%

Field probe linearity	3.00%	Rectangular	$\sqrt{3}$	1	1.732%
<b>Combined standard uncertainty</b>					5.831%
<b>Expanded uncertainty</b> 95 % confidence level k = 2					12.0%

## 5 CALIBRATION MEASUREMENT RESULTS

Calibration Parameters	
Liquid Temperature	21 °C
Lab Temperature	21 °C
Lab Humidity	45 %

### 5.1 SENSITIVITY IN AIR

Normx dipole 1 ( $\mu\text{V}/(\text{V}/\text{m})^2$ )	Normy dipole 2 ( $\mu\text{V}/(\text{V}/\text{m})^2$ )	Normz dipole 3 ( $\mu\text{V}/(\text{V}/\text{m})^2$ )
0.76	0.82	0.66

DCP dipole 1 (mV)	DCP dipole 2 (mV)	DCP dipole 3 (mV)
90	91	94

Calibration curves  $e_i=f(V)$  ( $i=1,2,3$ ) allow to obtain H-field value using the formula:

$$E = \sqrt{E_1^2 + E_2^2 + E_3^2}$$

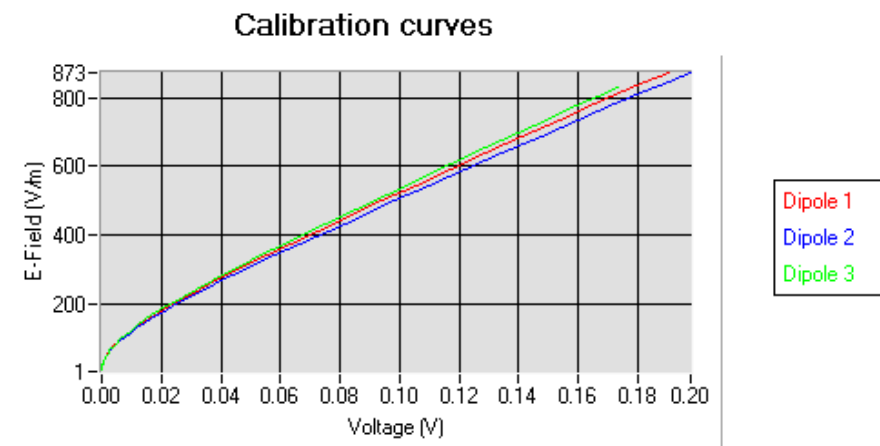

5.2 LINEARITY

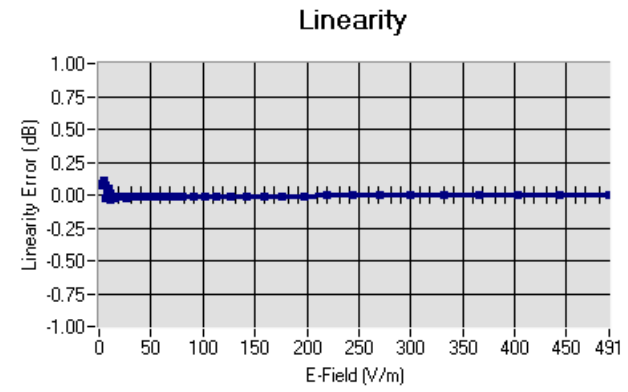

Linearity:  $\pm 2.60\%$  ( $\pm 0.11$  dB)

5.3 SENSITIVITY IN LIQUID

Liquid	Frequency (MHz +/- 100MHz)	Permittivity	Epsilon (S/m)	ConvF
HL450	450	44.12	0.88	1.76
BL450	450	58.92	1.00	1.81
HL750	750	42.24	0.90	1.53
BL750	750	56.85	0.99	1.59
HL850	835	43.02	0.90	1.78
BL850	835	53.72	0.98	1.85
HL900	900	42.47	0.99	1.62
BL900	900	56.97	1.09	1.67
HL1800	1800	42.24	1.40	1.83
BL1800	1800	53.53	1.53	1.87
HL1900	1900	40.79	1.42	2.10
BL1900	1900	54.47	1.57	2.16
HL2000	2000	40.52	1.44	2.01
BL2000	2000	54.18	1.56	2.09
HL2450	2450	38.73	1.81	2.21
BL2450	2450	53.23	1.96	2.28
HL2600	2600	38.54	1.95	2.32
BL2600	2600	52.07	2.23	2.38
HL5200	5200	36.80	4.84	2.46
BL5200	5200	51.21	5.16	2.52
HL5400	5400	36.35	4.96	2.70
BL5400	5400	50.51	5.70	2.79
HL5600	5600	35.57	5.23	2.74
BL5600	5600	49.83	5.91	2.83
HL5800	5800	35.30	5.47	2.53
BL5800	5800	49.03	6.28	2.60

LOWER DETECTION LIMIT: 9mW/kg

5.4 ISOTROPY

**HL900 MHz**

- Axial isotropy: 0.04 dB
- Hemispherical isotropy: 0.06 dB

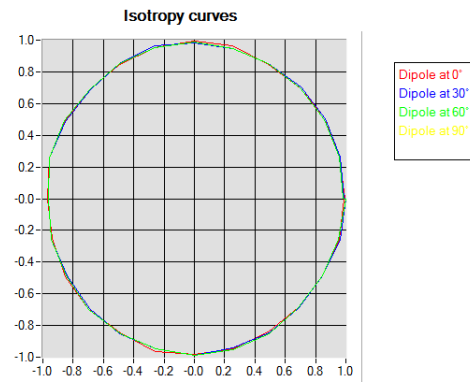

**HL1800 MHz**

- Axial isotropy: 0.04 dB
- Hemispherical isotropy: 0.08 dB

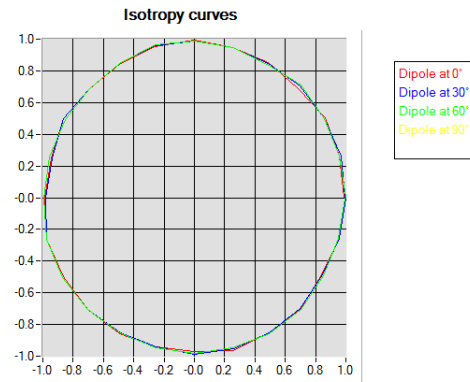



**HL5600 MHz**

- Axial isotropy: 0.06 dB
- Hemispherical isotropy: 0.08 dB

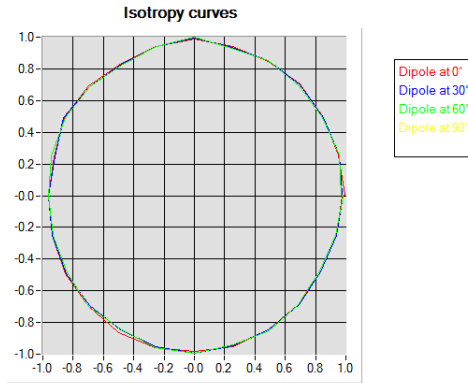



6 LIST OF EQUIPMENT

Equipment Summary Sheet				
Equipment Description	Manufacturer / Model	Identification No.	Current Calibration Date	Next Calibration Date
Flat Phantom	MVG	SN-20/09-SAM71	Validated. No cal required.	Validated. No cal required.
COMOSAR Test Bench	Version 3	NA	Validated. No cal required.	Validated. No cal required.
Network Analyzer	Rhode & Schwarz ZVA	SN100132	02/2019	02/2022
Reference Probe	MVG	EP 94 SN 37/08	10/2019	10/2020
Multimeter	Keithley 2000	1188656	01/2020	01/2023
Signal Generator	Agilent E4438C	MY49070581	01/2020	01/2023
Amplifier	Aethercomm	SN 046	Characterized prior to test. No cal required.	Characterized prior to test. No cal required.
Power Meter	HP E4418A	US38261498	01/2020	01/2023
Power Sensor	HP ECP-E26A	US37181460	01/2020	01/2023
Directional Coupler	Narda 4216-20	01386	Characterized prior to test. No cal required.	Characterized prior to test. No cal required.
Waveguide	Mega Industries	069Y7-158-13-712	Validated. No cal required.	Validated. No cal required.
Waveguide Transition	Mega Industries	069Y7-158-13-701	Validated. No cal required.	Validated. No cal required.
Waveguide Termination	Mega Industries	069Y7-158-13-701	Validated. No cal required.	Validated. No cal required.
Temperature / Humidity Sensor	Control Company	150798832	11/2017	11/2020



## **SAR Reference Waveguide Calibration Report**

Ref : ACR.262.12.17.SATU.A

**SHENZHEN STS TEST SERVICES CO., LTD.  
1/F., BUILDING B, ZHUOKE SCIENCE PARK, No.190,  
CHONGQINGROAD, FUYONG STREET,  
BAO' AN DISTRICT, SHENZHEN, GUANGDONG CHINA  
MVG COMOSAR REFERENCE WAVEGUIDE  
FREQUENCY: 5000-6000 MHZ  
SERIAL NO.: SN 13/14 WGA32**

**Calibrated at MVG US  
2105 Barrett Park Dr. - Kennesaw, GA 30144**



**08/15/2017**

### *Summary:*

This document presents the method and results from an accredited SAR reference waveguide calibration performed in MVG USA using the COMOSAR test bench. All calibration results are traceable to national metrology institutions.

	<i>Name</i>	<i>Function</i>	<i>Date</i>	<i>Signature</i>
<i>Prepared by :</i>	Jérôme LUC	Product Manager	8/25/2017	<i>JS</i>
<i>Checked by :</i>	Jérôme LUC	Product Manager	8/25/2017	<i>JS</i>
<i>Approved by :</i>	Kim RUTKOWSKI	Quality Manager	8/25/2017	<i>Kim Rutkowski</i>

	<i>Customer Name</i>
<i>Distribution :</i>	Shenzhen STS Test Services Co., Ltd.

<i>Issue</i>	<i>Date</i>	<i>Modifications</i>
A	8/25/2017	Initial release

**TABLE OF CONTENTS**

1 Introduction.....4

2 Device Under Test .....4

3 Product Description .....4

    3.1 General Information ..... 4

4 Measurement Method .....4

    4.1 Return Loss Requirements .....4

    4.2 Mechanical Requirements .....4

5 Measurement Uncertainty .....5

    5.1 Return Loss .....5

    5.2 Dimension Measurement .....5

    5.3 Validation Measurement .....5

6 Calibration Measurement Results .....5

    6.1 Return Loss .....5

    6.2 Mechanical Dimensions .....6

7 Validation measurement .....6

    7.1 Head Liquid Measurement .....7

    7.2 Measurement Result .....7

    7.3 Body Measurement Result .....10

8 List of Equipment .....13

## 1 INTRODUCTION

This document contains a summary of the requirements set forth by the IEEE 1528 and CEI/IEC 62209 standards for reference waveguides used for SAR measurement system validations and the measurements that were performed to verify that the product complies with the fore mentioned standards.

## 2 DEVICE UNDER TEST

<b>Device Under Test</b>	
Device Type	COMOSAR 5000-6000 MHz REFERENCE WAVEGUIDE
Manufacturer	MVG
Model	SWG5500
Serial Number	SN 13/14 WGA32
Product Condition (new / used)	New

A yearly calibration interval is recommended.

## 3 PRODUCT DESCRIPTION

### 3.1 GENERAL INFORMATION

MVG's COMOSAR Validation Waveguides are built in accordance to the IEEE 1528 and CEI/IEC 62209 standards.

## 4 MEASUREMENT METHOD

The IEEE 1528 and CEI/IEC 62209 standards provide requirements for reference waveguides used for system validation measurements. The following measurements were performed to verify that the product complies with the fore mentioned standards.

### 4.1 RETURN LOSS REQUIREMENTS

The waveguide used for SAR system validation measurements and checks must have a return loss of -8 dB or better. The return loss measurement shall be performed with matching layer placed in the open end of the waveguide, with the waveguide and matching layer in direct contact with the phantom shell as outlined in the fore mentioned standards.

### 4.2 MECHANICAL REQUIREMENTS

The IEEE 1528 and CEI/IEC 62209 standards specify the mechanical dimensions of the validation waveguide, the specified dimensions are as shown in Section 6.2. Figure 1 shows how the dimensions relate to the physical construction of the waveguide.

## 5 MEASUREMENT UNCERTAINTY

All uncertainties listed below represent an expanded uncertainty expressed at approximately the 95% confidence level using a coverage factor of k=2, traceable to the Internationally Accepted Guides to Measurement Uncertainty.

### 5.1 RETURN LOSS

The following uncertainties apply to the return loss measurement:

Frequency band	Expanded Uncertainty on Return Loss
400-6000MHz	0.1 dB

### 5.2 DIMENSION MEASUREMENT

The following uncertainties apply to the dimension measurements:

Length (mm)	Expanded Uncertainty on Length
3 - 300	0.05 mm

### 5.3 VALIDATION MEASUREMENT

The guidelines outlined in the IEEE 1528 and CEI/IEC 62209 standards were followed to generate the measurement uncertainty for validation measurements.

Scan Volume	Expanded Uncertainty
1 g	20.3 %
10 g	20.1 %

## 6 CALIBRATION MEASUREMENT RESULTS

### 6.1 RETURN LOSS IN HEAD LIQUID

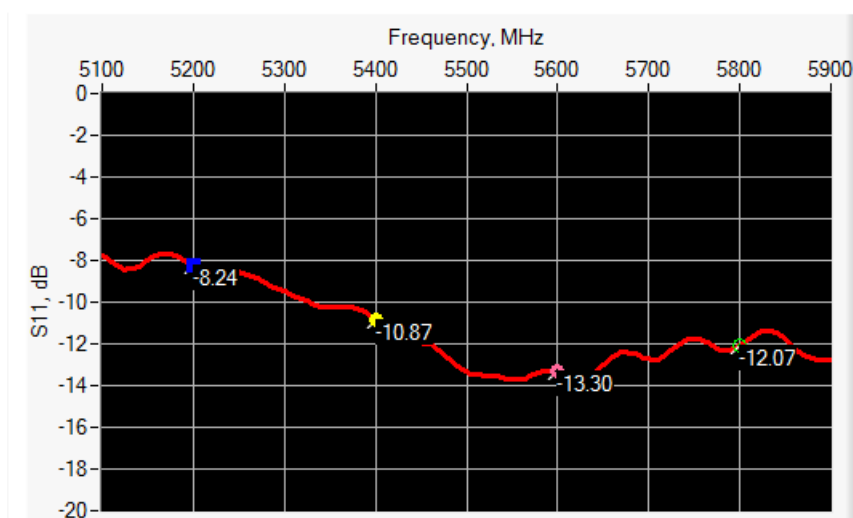

Frequency (MHz)	Return Loss (dB)	Requirement (dB)
5000-6000	< -8.24	-8

### 6.2 RETURN LOSS IN BODY LIQUID

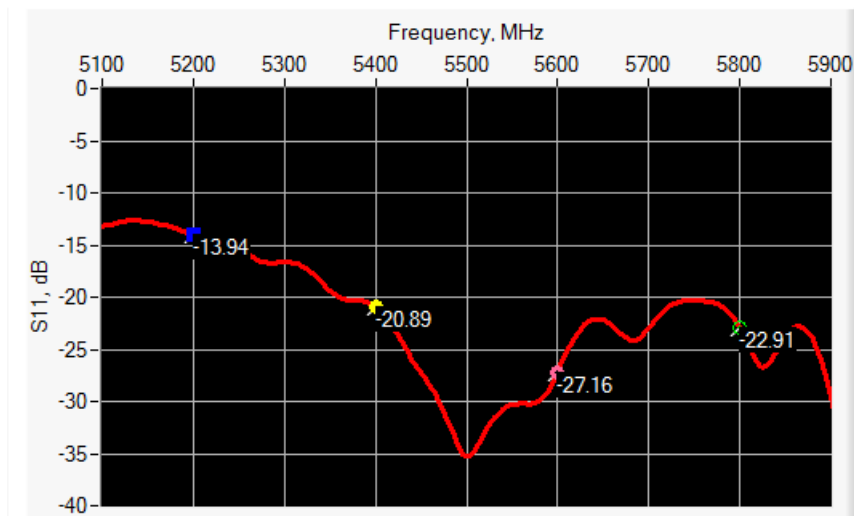

Frequency (MHz)	Return Loss (dB)	Requirement (dB)
5000-6000	< -13.94	-8

### 6.3 MECHANICAL DIMENSIONS

Frequency (MHz)	L (mm)		W (mm)		L <sub>r</sub> (mm)		W <sub>f</sub> (mm)		T (mm)	
	Required	Measured	Required	Measured	Required	Measured	Required	Measured	Required	Measured
5200	40.39 ± 0.13	PASS	20.19 ± 0.13	PASS	81.03 ± 0.13	PASS	61.98 ± 0.13	PASS	5.3*	PASS
5800	40.39 ± 0.13	PASS	20.19 ± 0.13	PASS	81.03 ± 0.13	PASS	61.98 ± 0.13	PASS	4.3*	PASS

\* The tolerance for the matching layer is included in the return loss measurement.

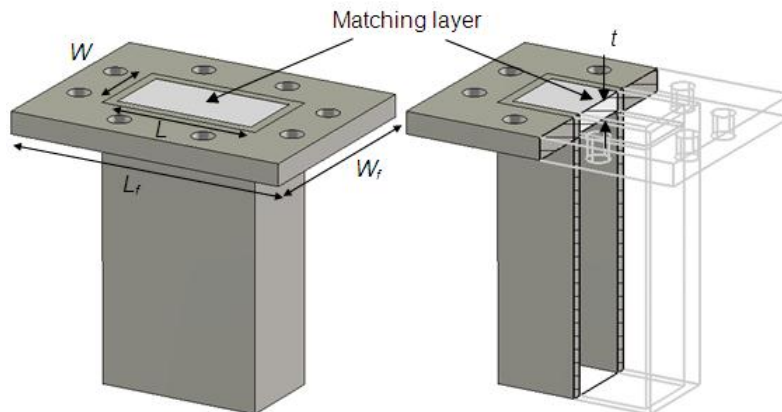

Figure 1: Validation Waveguide Dimensions

## 7 VALIDATION MEASUREMENT

The IEEE Std. 1528 and CEI/IEC 62209 standards state that the system validation measurements must be performed using a reference waveguide meeting the fore mentioned return loss and mechanical dimension requirements. The validation measurement must be performed with the matching layer placed in the open end of the waveguide, with the waveguide and matching layer in direct contact with the phantom shell.



7.1 HEAD LIQUID MEASUREMENT

Frequency MHz	Relative permittivity ( $\epsilon_r'$ )		Conductivity ( $\sigma$ ) S/m	
	required	measured	required	measured
5000	36.2 $\pm$ 10 %		4.45 $\pm$ 10 %	
5100	36.1 $\pm$ 10 %		4.56 $\pm$ 10 %	
5200	36.0 $\pm$ 10 %	PASS	4.66 $\pm$ 10 %	PASS
5300	35.9 $\pm$ 10 %		4.76 $\pm$ 10 %	
5400	35.8 $\pm$ 10 %	PASS	4.86 $\pm$ 10 %	PASS
5500	35.6 $\pm$ 10 %		4.97 $\pm$ 10 %	
5600	35.5 $\pm$ 10 %	PASS	5.07 $\pm$ 10 %	PASS
5700	35.4 $\pm$ 10 %		5.17 $\pm$ 10 %	
5800	35.3 $\pm$ 10 %	PASS	5.27 $\pm$ 10 %	PASS
5900	35.2 $\pm$ 10 %		5.38 $\pm$ 10 %	
6000	35.1 $\pm$ 10 %		5.48 $\pm$ 10 %	

7.2 SAR MEASUREMENT RESULT WITH HEAD LIQUID

At those frequencies, the target SAR value can not be generic. Hereunder is the target SAR value defined by MVG, within the uncertainty for the system validation. All SAR values are normalized to 1 W net power. In bracket, the measured SAR is given with the used input power.

Software	OPENSAR V4
Phantom	SN 20/09 SAM71
Probe	SN 18/11 EPG122
Liquid	Head Liquid Values 5200 MHz: $\epsilon_r'$ :36.62 sigma : 4.93 Head Liquid Values 5400 MHz: $\epsilon_r'$ :35.95 sigma : 5.18 Head Liquid Values 5600 MHz: $\epsilon_r'$ :36.08 sigma : 5.60 Head Liquid Values 5800 MHz: $\epsilon_r'$ :34.73 sigma : 5.74
Distance between dipole waveguide and liquid	0 mm
Area scan resolution	dx=8mm/dy=8mm
Zoon Scan Resolution	dx=4mm/dy=4m/dz=2mm
Frequency	5200 MHz 5400 MHz 5600 MHz 5800 MHz
Input power	20 dBm
Liquid Temperature	21 °C
Lab Temperature	21 °C
Lab Humidity	45 %

Frequency (MHz)	1 g SAR (W/kg)		10 g SAR (W/kg)	
	required	measured	required	measured
5200	159.00	163.88 (16.39)	56.90	57.29 (5.73)
5400	166.40	172.23 (17.22)	58.43	59.16 (5.92)
5600	173.80	181.28 (18.13)	59.97	61.57 (6.16)
5800	181.20	188.95 (18.90)	61.50	63.45 (6.35)

### SAR MEASUREMENT PLOTS @ 5200 MHz

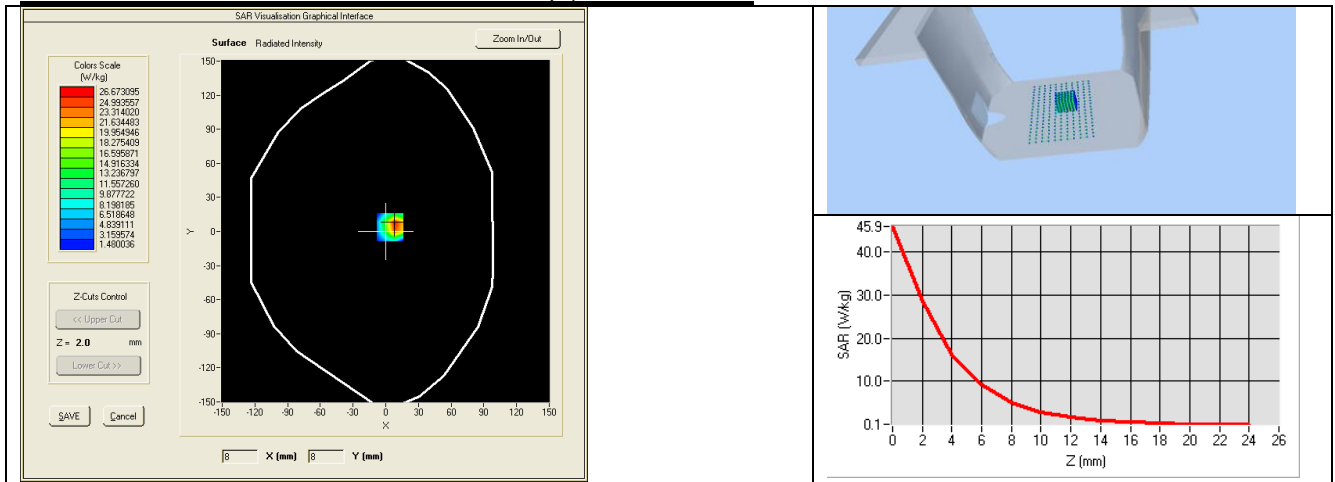

### SAR MEASUREMENT PLOTS @ 5400 MHz

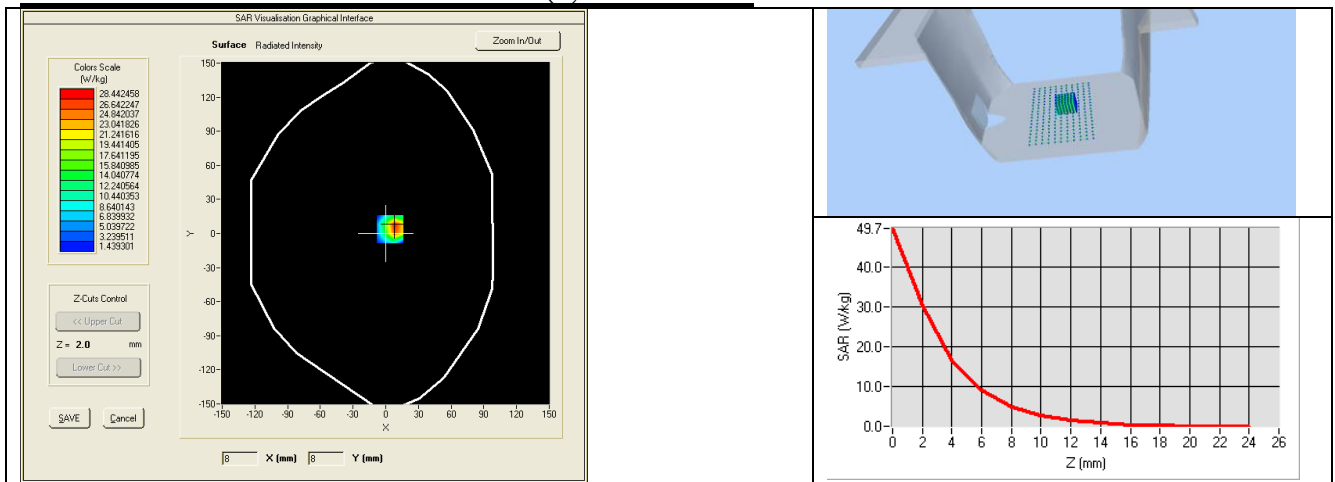

### SAR MEASUREMENT PLOTS @ 5600 MHz

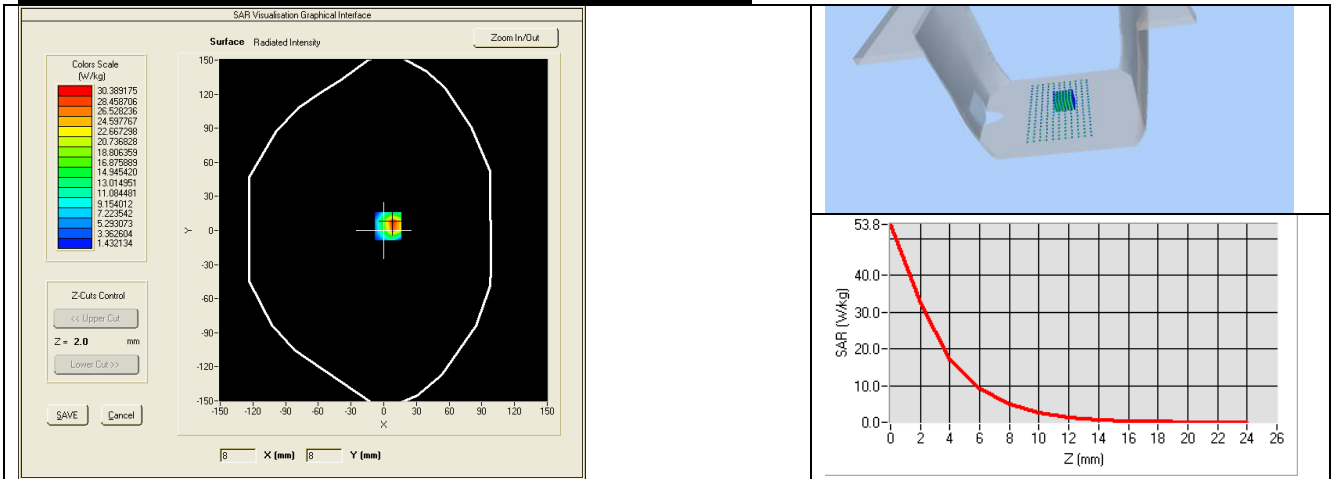

### SAR MEASUREMENT PLOTS @ 5800 MHz

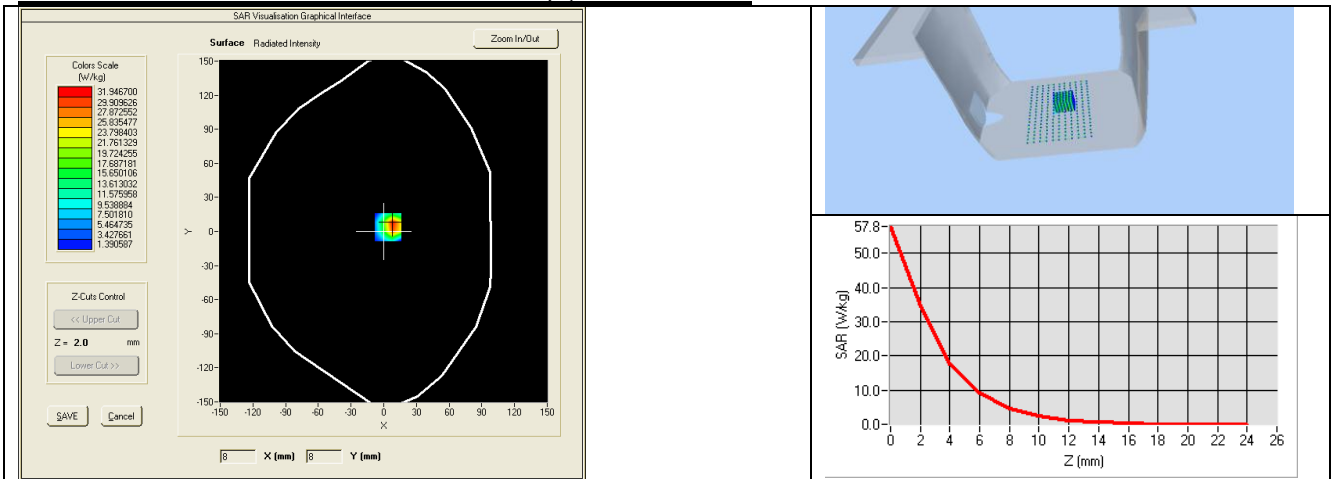

7.3 BODY LIQUID MEASUREMENT

Frequency MHz	Relative permittivity ( $\epsilon_r'$ )		Conductivity ( $\sigma$ ) S/m	
	required	measured	required	measured
5200	49.0 ±10 %	PASS	5.30 ±10 %	PASS
5300	48.9 ±10 %		5.42 ±10 %	
5400	48.7 ±10 %	PASS	5.53 ±10 %	PASS
5500	48.6 ±10 %		5.65 ±10 %	
5600	48.5 ±10 %	PASS	5.77 ±10 %	PASS
5800	48.2 ±10 %	PASS	6.00 ±10 %	PASS

7.4 SAR MEASUREMENT RESULT WITH BODY LIQUID

Software	OPENSAR V4
Phantom	SN 20/09 SAM71
Probe	SN 18/11 EPG122
Liquid	Body Liquid Values 5200 MHz: eps' :50.69 sigma : 4.98 Body Liquid Values 5400 MHz: eps' :48.45 sigma : 5.82 Body Liquid Values 5600 MHz: eps' :50.57 sigma : 6.37 Body Liquid Values 5800 MHz: eps' :48.19 sigma : 6.45
Distance between dipole waveguide and liquid	0 mm
Area scan resolution	dx=8mm/dy=8mm
Zoon Scan Resolution	dx=4mm/dy=4m/dz=2mm
Frequency	5200 MHz 5400 MHz 5600 MHz 5800 MHz
Input power	20 dBm
Liquid Temperature	21 °C
Lab Temperature	21 °C
Lab Humidity	45 %

Frequency (MHz)	1 g SAR (W/kg)	10 g SAR (W/kg)
	measured	measured
5200	158.49 (15.85)	55.40 (5.54)
5400	167.20 (16.72)	57.39 (5.74)
5600	175.65 (17.57)	59.48 (5.95)
5800	183.06 (18.31)	61.62 (6.16)

### BODY SAR MEASUREMENT PLOTS @ 5200 MHz

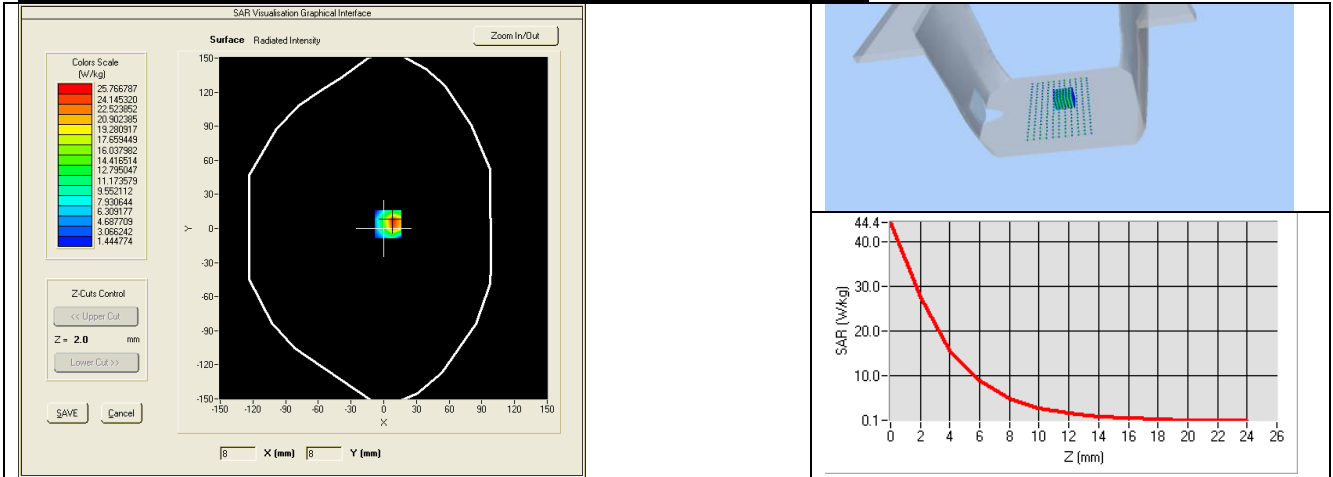

### BODY SAR MEASUREMENT PLOTS @ 5400 MHz

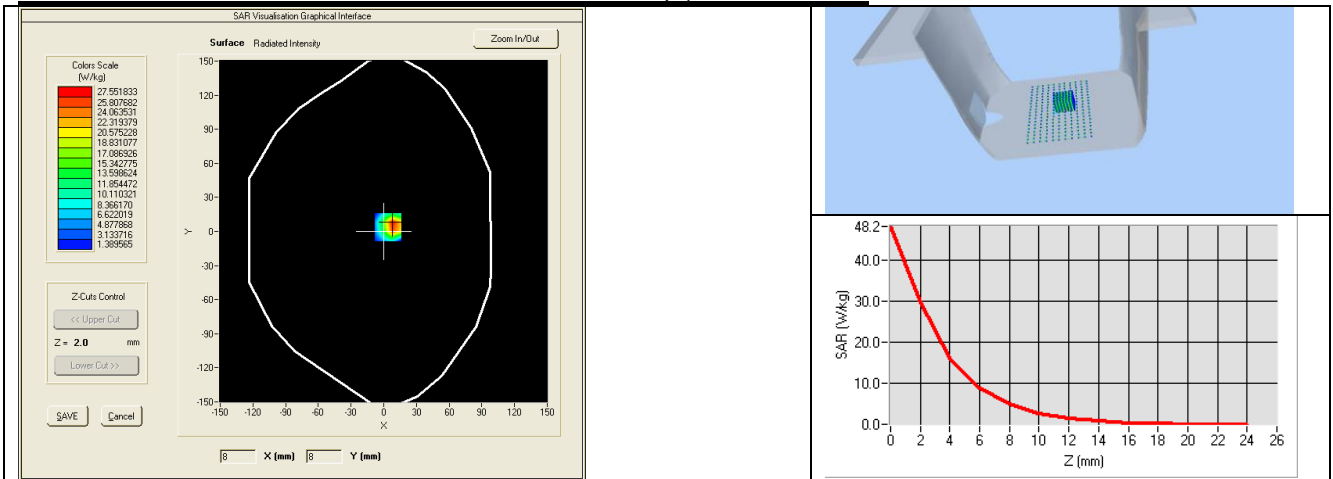

### BODY SAR MEASUREMENT PLOTS @ 5600 MHz

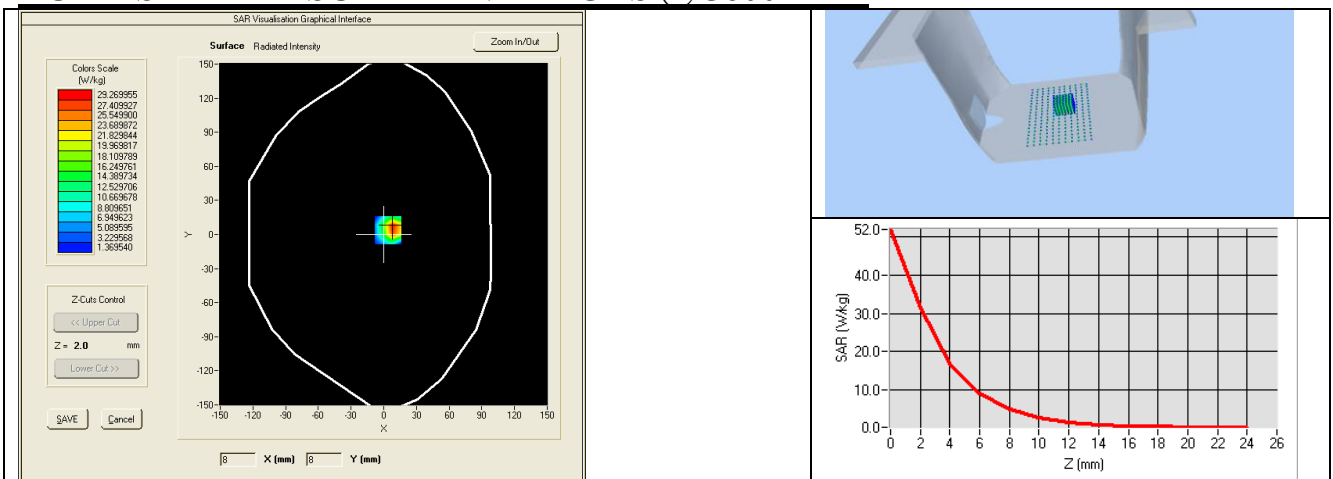

## BODY SAR MEASUREMENT PLOTS @ 5800 MHz

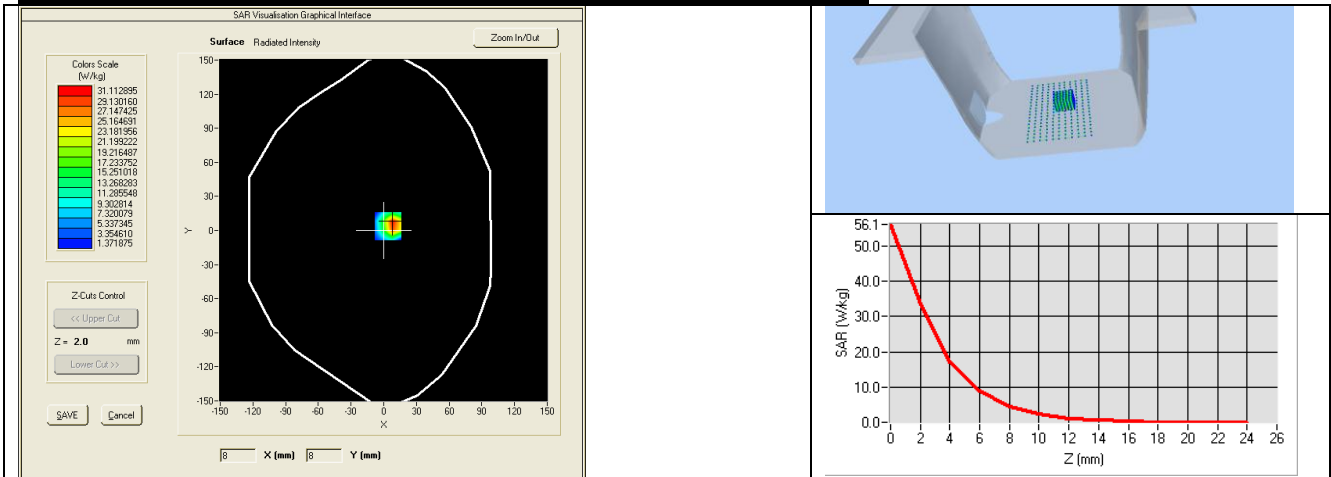

## 8 LIST OF EQUIPMENT

Equipment Summary Sheet				
Equipment Description	Manufacturer / Model	Identification No.	Current Calibration Date	Next Calibration Date
Flat Phantom	MVG	SN-20/09-SAM71	Validated. No cal required.	Validated. No cal required.
COMOSAR Test Bench	Version 3	NA	Validated. No cal required.	Validated. No cal required.
Network Analyzer	Rhode & Schwarz ZVA	SN100132	02/2016	02/2019
Calipers	Carrera	CALIPER-01	01/2017	01/2020
Reference Probe	MVG	EPG122 SN 18/11	10/2016	10/2017
Multimeter	Keithley 2000	1188656	01/2017	01/2020
Signal Generator	Agilent E4438C	MY49070581	01/2017	01/2020
Amplifier	Aethercomm	SN 046	Characterized prior to test. No cal required.	Characterized prior to test. No cal required.
Power Meter	HP E4418A	US38261498	01/2017	01/2020
Power Sensor	HP ECP-E26A	US37181460	01/2017	01/2020
Directional Coupler	Narda 4216-20	01386	Characterized prior to test. No cal required.	Characterized prior to test. No cal required.
Temperature and Humidity Sensor	Control Company	150798832	10/2015	10/2017