

FCC CERTIFICATION TEST REPORT

FOR

Applicant	:	SHENZHEN NITO POWER SOURCE TECHNOLOGY CO.,LTD.
Address	:	201, No.8 Building, Jinfanghua Electricity Industrial park, Bantian St., Longgang Dist., Shenzhen, China
Equipment under Test	:	2-in-1 15W Wireless Charger
Model No.	:	JR-A26, JR-A23, JR-A20, JR-A15, JR-A12, JR-A16, JR-A27, JR-A28, JR-A29, JR-A30, JR-A31, JR-A32, JR-A33, JR-A35, JR-A36, JR-A37, JR-A39
Trade Mark	:	JOYROOM
FCC ID	:	2AWL2-JR-A26
Manufacturer	:	SHENZHEN NITO POWER SOURCE TECHNOLOGY CO.,LTD.
Address	:	201, No.8 Building, Jinfanghua Electricity Industrial park, Bantian St., Longgang Dist., Shenzhen, China

Issued By: Dongguan Dongdian Testing Service Co., Ltd.

Add.: No. 17, Zongbu Road 2, Songshan Lake Sci&Tech, Industry Park,
Dongguan City, Guangdong Province, China, 523808

Tel.: +86-0769-38826678, **E-mail:** ddt@dgddt.com, <http://www.dgddt.com>

REPORT

Table of Contents

	Test report declares.....	3
1	Summary of Test Results.....	5
2	General Test Information	6
2.1.	Description of EUT	6
2.2.	Accessories of EUT.....	7
2.3.	Assistant equipment used for test.....	7
2.4.	Block diagram of EUT configuration for test.....	7
2.5.	Deviations of test standard.....	7
2.6.	Test environment conditions	7
2.7.	Test laboratory.....	7
2.8.	Measurement uncertainty.....	8
3	Equipment Used During Test.....	9
4	20 dB Bandwidth	11
4.1.	Block diagram of test setup.....	11
4.2.	Limits	11
4.3.	Test procedure	11
4.4.	Test result.....	11
4.5.	Original test data	12
5	Radiated Emission	13
5.1.	Block diagram of test setup.....	13
5.2.	Limit.....	14
5.3.	Test procedure	14
5.4.	Test result.....	15
6	Power Line Conducted Emission.....	24
6.1.	Block diagram of test setup.....	24
6.2.	Power line conducted emission limits.....	24
6.3.	Test procedure	24
6.4.	Test result.....	25
7	Antenna Requirements	28

Test Report Declare

Applicant	:	SHENZHEN NITO POWER SOURCE TECHNOLOGY CO.,LTD.
Address	:	201, No.8 Building, Jinfanghua Electricity Industrial park, Bantian St., Longgang Dist., Shenzhen, China
Equipment under Test	:	2-in-1 15W Wireless Charger
Model No.	:	JR-A26, JR-A23, JR-A20, JR-A15, JR-A12, JR-A16, JR-A27, JR-A28, JR-A29, JR-A30, JR-A31, JR-A32, JR-A33, JR-A35, JR-A36, JR-A37, JR-A39
Trade Mark	:	JOYROOM
Manufacturer	:	SHENZHEN NITO POWER SOURCE TECHNOLOGY CO.,LTD.
Address	:	201, No.8 Building, Jinfanghua Electricity Industrial park, Bantian St., Longgang Dist., Shenzhen, China

Test Standard Used:

FCC Rules and Regulations Part 15 Subpart C

Test procedure used:

ANSI C63.10:2013

We Declare:

The equipment described above is tested by Dongguan Dongdian Testing Service Co., Ltd and in the configuration tested the equipment complied with the standards specified above. The test results are contained in this test report and Dongguan Dongdian Testing Service Co., Ltd is assumed of full responsibility for the accuracy and completeness of these tests.

After test and evaluation, our opinion is that the equipment provided for test compliance with the requirement of the above FCC standards.

Report No:	DDT-R20081721-1E1		
Date of Receipt:	Aug. 19, 2020	Date of Test:	Aug. 19, 2020 ~ Nov. 04, 2020

Prepared By:

Sam Li

Sam Li/Engineer

Approved By:

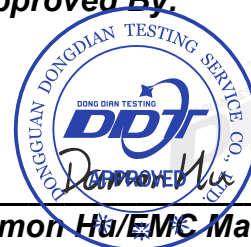

Damon Hu/EMC Manager

Note: This report applies to above tested sample only. This report shall not be reproduced in parts without written approval of Dongguan Dongdian Testing Service Co., Ltd.

Revision History

Rev.	Revisions	Issue Date	Revised By
---	Initial issue	Nov. 04, 2020	

1 Summary of Test Results

Description of Test Item	Standard	Results
20 dB Bandwidth	FCC Part 15: 15.215	PASS
Radiated Emission	FCC Part 15: 15.209	PASS
Power Line Conducted Emissions	FCC Part 15: 15.207	PASS
Antenna Requirement	FCC Part 15: 15.203	PASS

2 General Test Information

2.1. Description of EUT

EUT* Name	: 2-in-1 15W Wireless Charger
Model Number	: JR-A26, JR-A23, JR-A20, JR-A15, JR-A12, JR-A16, JR-A27, JR-A28, JR-A29, JR-A30, JR-A31, JR-A32, JR-A33, JR-A35, JR-A36, JR-A37, JR-A39
Difference of model number	: All models are identical except the colors and model number, therefore the test performed on the model JR-A26.
EUT function description	: Please reference user manual of this device
Power supply	: DC 5V/9V/12V from external adapter
Wireless charging Operation frequency	: 120 kHz - 205 kHz
Antenna Type	: Inductive loop coil antenna
Serial Number	: N/A

Note: EUT is the ab. of equipment under test.

Channel information							
Channel	Frequency (kHz)	Channel	Frequency (kHz)	Channel	Frequency (kHz)	Channel	Frequency (kHz)
1	120	23	142	45	164	67	186
2	121	24	143	46	165	68	187
3	122	25	144	47	166	69	188
4	123	26	145	48	167	70	189
5	124	27	146	49	168	71	190
6	125	28	147	50	169	72	191
7	126	29	148	51	170	73	192
8	127	30	149	52	171	74	193
9	128	31	150	53	172	75	194
10	129	32	151	54	173	76	195
11	130	33	152	55	174	77	196
12	131	34	153	56	175	78	197
13	132	35	154	57	176	79	198
14	133	36	155	58	177	80	199
15	134	37	156	59	178	81	200
16	135	38	157	60	179	82	201
17	136	39	158	61	180	83	202
18	137	40	159	62	181	84	203
19	138	41	160	63	182	85	204
20	139	42	161	64	183	86	205
21	140	43	162	65	184		
22	141	44	163	66	185		

Note:

In section 15.31(m), regards to the operating frequency range less than 1 MHz, only one of channel was selected to perform the test.

Channel	Frequency (kHz)
Testing channel	154

2.2. Accessories of EUT

Description of Accessories	Manufacturer	Model number	Serial No.	Other
/	/	/	/	/

2.3. Assistant equipment used for test

Assistant equipment	Manufacturer	Model number or Type	EMC Compliance	Other
Mobile phone	SAMSUNG	SM-G9600/DS	R28K331TTNF	N/A
Simulation load adapter	/	/	/	/

2.4. Block diagram of EUT configuration for test



2.5. Deviations of test standard

No deviation.

2.6. Test environment conditions

During the measurement the environmental conditions were within the listed ranges:

Temperature range:	21-25 °C
Humidity range:	40-75%
Pressure range:	86-106 kPa

2.7. Test laboratory

Dongguan Dongdian Testing Service Co., Ltd

Add.: No. 17, Zongbu Road 2, Songshan Lake Sci&Tech, Industry Park, Dongguan City, Guangdong Province, China, 523808

Tel.: +86-0769-38826678, <http://www.dgddt.com>, Email: ddt@dgddt.com

CNAS Accreditation No. L6451; A2LA Accreditation No. 3870.01

FCC Designation Number: CN1182; FCC Test Firm Registration Number: 540522

Industry Canada site registration number: 10288A-1

2.8. Measurement uncertainty

Test Item	Uncertainty
Uncertainty for Conduction emission test	3.32 dB (150 kHz - 30 MHz)
	3.72 dB (9 kHz - 150 kHz)
Uncertainty for Radiation Emission test (30 MHz - 1 GHz)	4.70 dB (Antenna Polarize: V)
	4.84 dB (Antenna Polarize: H)
Uncertainty for Radiation Emission test (1 GHz to 18 GHz)	4.10 dB (1-6 GHz)
	4.40 dB (6 GHz - 18 GHz)
Bandwidth	1.1%
<p>Note: This uncertainty represents an expanded uncertainty expressed at approximately the 95% confidence level using a coverage factor of k=2.</p>	

3 Equipment Used During Test

Equipment	Manufacturer	Model No.	Serial No.	Last Cal.	Cal. Interval
RF Connected Test (Tonscend RF Measurement System 1#)					
Spectrum analyzer	R&S	FSU26	101272	Jul. 01, 2020	1 Year
Spectrum analyzer	Agilent	N9020D	MY49100362	Sep. 28, 2020	1 Year
Wideband Radio Communication tester	R&S	CMW500	117491	Jul. 01, 2020	1 Year
Vector Signal Generator	Agilent	E8267D	US49060192	Sep. 24, 2020	1 Year
Vector Signal Generator	Agilent	N5182A	MY48180737	Jul. 01, 2020	1 Year
Power Sensor	Agilent	U2021XA	MY55150010	Jul. 01, 2020	1 Year
Power Sensor	Agilent	U2021XA	MY55150011	Jul. 01, 2020	1 Year
DC Power Source	MATRIS	MPS-3005L-3	D813058W	Apr. 25, 2020	1 Year
RF Cable	Micable	C10-01-01-1	100309	Sep. 28, 2020	1 Year
Temp&Humi Programmable	ZHIXIANG	ZXGDJS-150L	ZX170110-A	Jul. 01, 2020	1 Year
Test Software	JS Tonscend	JS1120-3	Ver.2.7	N/A	N/A
RF Connected Test (Tonscend RF Measurement System 2#)					
Spectrum analyzer	R&S	FSU26	200071	Sep. 25, 2020	1 Year
Spectrum analyzer	Agilent	N9020D	MY49100362	Sep. 28, 2020	1 Year
Wideband Radio Communication tester	R&S	CMW500	117491	Jul. 01, 2020	1 Year
Vector Signal Generator	Agilent	N5182A	MY19060405	Jul. 01, 2020	1 Year
Vector Signal Generator	Agilent	N5182A	MY48180912	Jul. 01, 2020	1 Year
RF Control Unit	Tonsend	JS0806-2	DDT-ZC01449	Jul. 01, 2020	1 Year
DC Power Source	MATRIS	MPS-3005L-3	D813058W	Apr. 25, 2020	1 Year
RF Cable	Micable	C10-01-01-1	100309	Sep. 28, 2020	1 Year
Temp&Humi Programmable	ZHIXIANG	ZXGDJS-150L	ZX170110-A	Jul. 01, 2020	1 Year
Test Software	JS Tonscend	JS1120-3	Ver.2.7	N/A	N/A
Radiation 1#chamber					
EMI Test Receiver	R&S	ESU8	100316	Sep. 24, 2020	1 Year
Spectrum analyzer	Agilent	E4447A	MY50180031	Jul. 01, 2020	1 Year
Trilog Broadband Antenna	Schwarzbeck	VULB9163	9163-462	Nov. 15, 2019	1 Year
Active Loop antenna	Schwarzbeck	FMZB-1519	1519-038	Nov. 15, 2019	1 Year
Double Ridged Horn Antenna	R&S	HF907	100276	Nov. 15, 2019	1 Year
Broad Band Horn Antenna	Schwarzbeck	BBHA 9170	790	Apr. 11, 2020	1 Year
Pre-amplifier	A.H.	PAM-0118	360	Sep. 28, 2020	1 Year
RF Cable	HUBSER	CP-X2+ CP-X1	W11.03+ W12.02	Sep. 24, 2020	1 Year

RF Cable	N/A	5m+6m+1m	06270619	Sep. 30, 2020	1 Year
MI Cable	HUBSER	C10-01-01-1 M	1091629	Sep. 30, 2020	1 Year
Test software	Audix	E3	V 6.11111b	N/A	N/A
Radiation 2#chamber					
EMI Test Receiver	R&S	ESCI	101364	Sep. 28, 2020	1 Year
Spectrum analyzer	Agilent	E4447A	MY50180031	Jul. 01, 2020	1 Year
Trilog Broadband Antenna	Schwarzbeck	VULB 9163	9163-994	Nov. 15, 2019	1 Year
Active Loop antenna	Schwarzbeck	FMZB-1519	1519-038	Nov. 15, 2019	1 Year
Double Ridged Horn Antenna	Schwarzbeck	BBHA9120	02108	Jul. 11, 2020	1 Year
Broad Band Horn Antenna	Schwarzbeck	BBHA 9170	790	Apr. 11, 2020	1 Year
Pre-amplifier	TERA-MW	TRLA-0040 G35	1013 03	Sep. 28, 2020	1 Year
RF Cable	N/A	14+1.5m	06270619	Sep. 28, 2020	1 Year
Test software	Audix	E3	V 6.11111b	N/A	N/A
Power Line Conducted Emissions Test 1#					
EMI Test Receiver	R&S	ESU8	100316	Sep. 24, 2020	1 Year
LISN 1	R&S	ENV216	101109	Sep. 28, 2020	1 Year
LISN 2	R&S	ESH2-Z5	100309	Sep. 28, 2020	1 Year
Pulse Limiter	R&S	ESH3-Z2	101242	Sep. 24, 2020	1 Year
CE Cable 1	HUBSER	N/A	W10.01	Sep. 24, 2020	1 Year
Test software	Audix	E3	V 6.11111b	N/A	N/A
Power Line Conducted Emissions Test 2#					
Test Receiver	R&S	ESPI	101761	Sep. 24, 2020	1 Year
LISN 1	R&S	ENV216	101170	Sep. 28, 2020	1 Year
LISN 2	R&S	ESH2-Z5	100309	Sep. 28, 2020	1 Year
Pulse Limiter	R&S	KH43101	43101180156 8-12#	Jul. 01, 2020	1 Year
CE Cable 2	HUBSER	N/A	W11.02	Sep. 24, 2020	1 Year
Test software	Audix	E3	V 6.11111b	N/A	N/A

4 20 dB Bandwidth

4.1. Block diagram of test setup

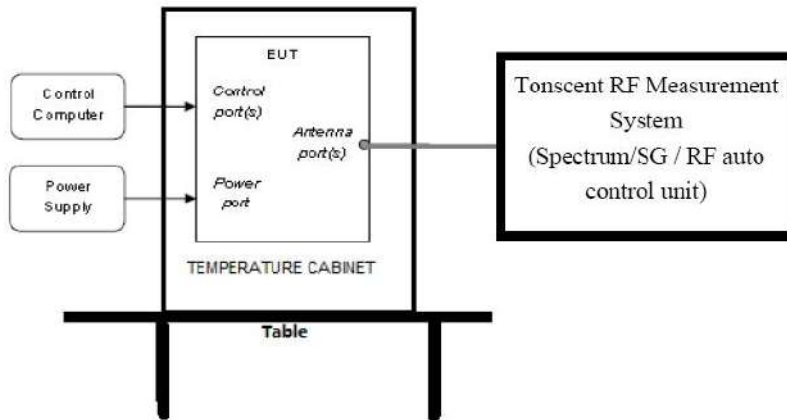

4.2. Limits

Intentional radiators operating under the alternative provisions to the general emission limits, as contained in § 15.217 through 15.257 and in Subpart E of this part, must be designed to ensure that the 20 dB bandwidth of the emission, or whatever bandwidth may otherwise be specified in the specific rule section under which the equipment operates, is contained within the frequency band designated in the rule section under which the equipment is operated.

4.3. Test procedure

- (1) Connect EUT's antenna output to spectrum analyzer by RF cable.
- (2) The bandwidth of the fundamental frequency was measured by spectrum analyzer with 300 Hz RBW and 1 kHz VBW. The 20 dB bandwidth is defined as the total spectrum the power of which is higher than peak power minus 20 dB.

4.4. Test result

Freq. (kHz)	20 dB bandwidth Result (kHz)	Conclusion
154	0.761	PASS

4.5. Original test data

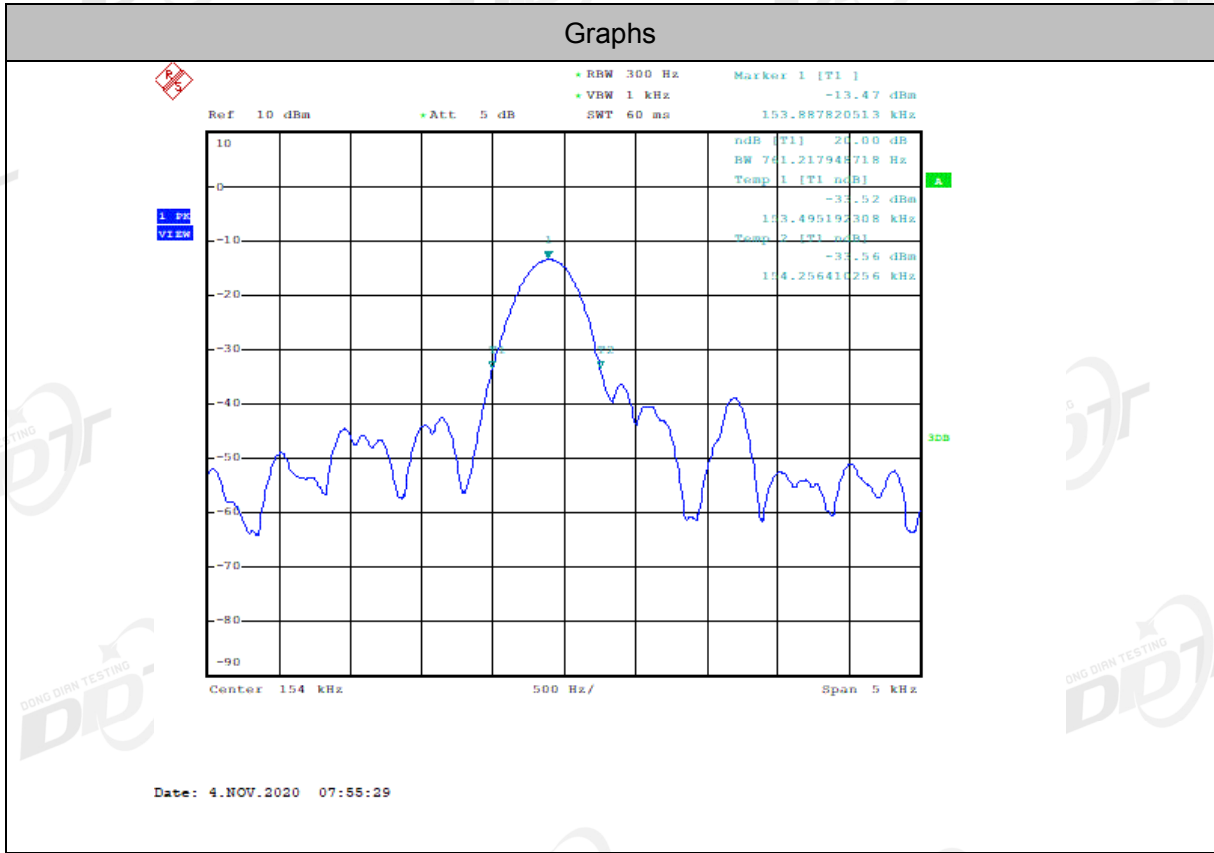

5 Radiated Emission

5.1. Block diagram of test setup

In 3 m Anechoic Chamber Test Setup Diagram for 9 kHz ~ 30 MHz

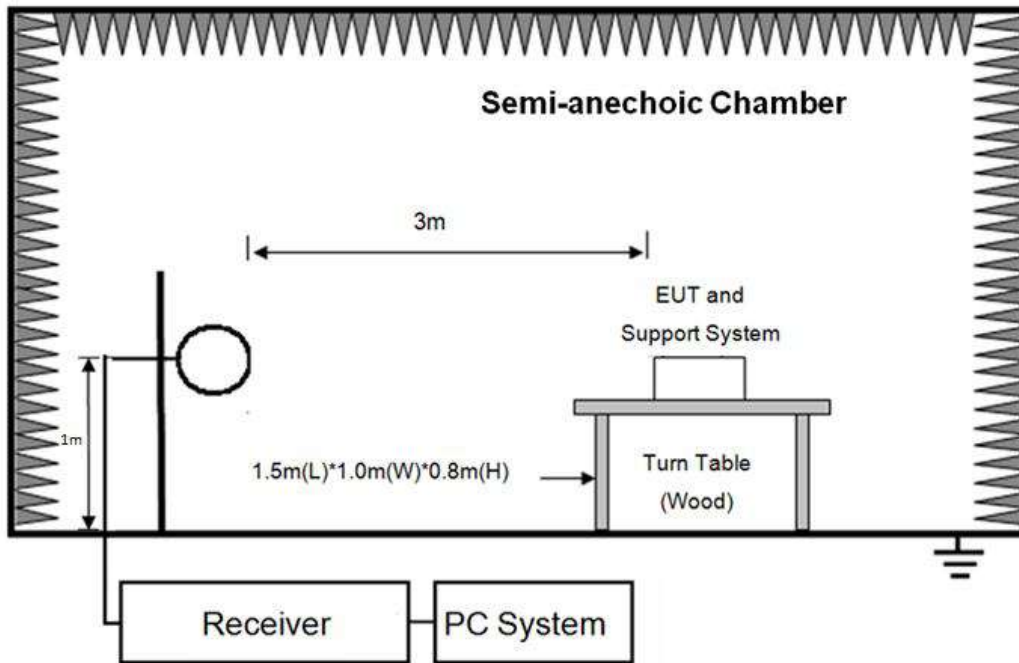

In 3 m Anechoic Chamber Test Setup Diagram for 30 MHz ~ 1 GHz

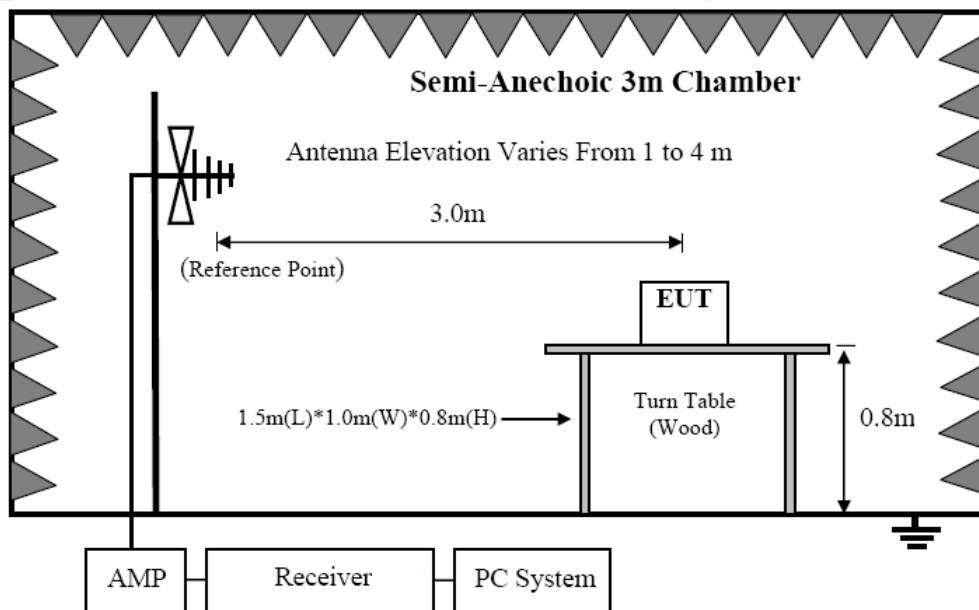

5.2. Limit

FREQUENCY MHz	DISTANCE Meters	FIELD STRENGTHS LIMIT	
		$\mu\text{V}/\text{m}$	$\text{dB}(\mu\text{V})/\text{m}$
0.009 ~ 0.490	300	2400/F(kHz)	67.6-20log(F)
0.490 ~ 1.705	30	24000/F(kHz)	87.6-20log(F)
1.705 ~ 30.0	30	30	29.54
30 ~ 88	3	100	40.0
88 ~ 216	3	150	43.5
216 ~ 960	3	200	46.0
960 ~ 1000	3	500	54.0

Note: (1) The emission limits shown in the above table are based on measurements employing a CISPR QP detector except for the frequency bands 9-90 kHz, 110-490 kHz and above 1000 MHz. Radiated emissions limits in these three bands are based on measurements employing an average detector.

(2) At frequencies below 30 MHz, measurement may be performed at a distance closer than that specified, and the limit at closer measurement distance can be extrapolated by below formula:

$$\text{Limit}_{3\text{m}}(\text{dBuV}/\text{m}) = \text{Limit}_{300\text{m}}(\text{dBuV}/\text{m}) + 40\text{Log}(300\text{m}/3\text{m}) = \text{Limit}_{300\text{m}}(\text{dBuV}/\text{m}) + 80$$

$$\text{Limit}_{3\text{m}}(\text{dBuV}/\text{m}) = \text{Limit}_{30\text{m}}(\text{dBuV}/\text{m}) + 40\text{Log}(30\text{m}/3\text{m}) = \text{Limit}_{30\text{m}}(\text{dBuV}/\text{m}) + 40$$

5.3. Test procedure

(1) EUT was placed on a non-metallic table, 150 cm above the ground plane inside a semi-anechoic chamber.

(2) Test antenna was located 3m from the EUT on an adjustable mast, and the antenna used as below table.

Test frequency range	Test antenna used	Test antenna distance
9 kHz - 30 MHz	Active Loop antenna	3 m
30 MHz - 1 GHz	Trilog Broadband Antenna	3 m

According ANSI C63.10:2013 clause 6.4.4.2 and 6.5.3, for measurements below 30 MHz, the loop antenna was positioned with its plane vertical from the EUT and rotated about its vertical axis for maximum response at each azimuth position around the EUT. And the loop antenna also is positioned with its plane horizontal at the specified distance from the EUT. The center of the loop is 1 m above the ground. For measurement above 30 MHz, the Trilog Broadband Antenna or Horn Antenna was located 3 m from EUT, Measurements were made with the antenna positioned in both the horizontal and vertical planes of Polarization, and the measurement antenna was varied from 1 m to 4 m. in height above the reference ground plane to obtain the maximum signal strength.

(3) Below pre-scan procedure was first performed in order to find prominent frequency spectrum radiated emissions from 9 kHz to 1 GHz:

(a) Scanning the peak frequency spectrum with the antenna specified in step (3), and the EUT

was rotated 360 degree, the antenna height was varied from 1 m to 4 m (Except loop antenna, it's fixed 1 m above ground.)

(b) Change work frequency or channel of device if practicable.

(c) Change modulation type of device if practicable.

(d) Rotated EUT though three orthogonal axes to determine the attitude of EUT arrangement produce highest emissions. Spectrum frequency from 9 kHz to 1 GHz (tenth harmonic of fundamental frequency) was investigated.

(4) For final emissions measurements at each frequency of interest, the EUT was rotated and the antenna height was varied between 1 m and 4 m in order to maximize the emission. Measurements in both horizontal and vertical polarities were made and the data was recorded. In order to find the maximum emission, the relative positions of equipments and all of the interface cables were changed according to ANSI C63.10:2013 on Radiated Emission test.

(5) The emissions from 9 kHz to 1 GHz were measured based on CISPR QP detector except for the frequency bands 9-90 kHz, 110-490 kHz, for emissions from 9 kHz - 90 kHz, 110 kHz - 490 kHz and above 1 GHz were measured based on average detector, for emissions above 1 GHz, peak emissions also be measured and need comply with Peak limit.

(6) The emissions from 9 kHz to 1 GHz, QP or average values were measured with EMI receiver with below RBW.

Frequency band	RBW
9 kHz - 150 kHz	200 Hz
150 kHz - 30 MHz	9 kHz
30 MHz - 1 GHz	120 kHz

5.4. Test result

PASS. (See below detailed test result)

Note: One device charging and two devices charging simultaneously both have been tested, and found two devices charging simultaneously was worse case and reported.

Below 30 MHz:

Frequency (MHz)	Result @3m (dBuV/m)	Limit @3m (dBuV/m)	Detector	Conclusion
0.07	40.80	130.70	Peak	PASS
0.07	35.42	110.70	Average	PASS
0.154	77.40	123.85	Peak	PASS
0.154	71.86	103.85	Average	PASS
0.33	62.48	117.23	Peak	PASS
0.33	57.05	97.23	Average	PASS
0.44	47.46	114.74	Peak	PASS
0.44	41.95	94.74	Peak	PASS
0.53	54.01	73.12	QP	PASS
0.78	47.84	69.76	QP	PASS

Above 30 MHz:

TR-4-E-009 Radiated Emission Test Result

Test Site	: DDT 3m Chamber 1#	Tested By	: Jacky
Test Date	: 2020-11-01	Model Number	: JR-A26
EUT	: 2-in-1 15W Wireless Charger	Test Mode	: Tx mode
Power Supply	: AC 120V/60Hz	Antenna/Distance	: 2019 VULB 9163 1#/3m/VERTICAL
Condition	: Temp:24.5°C,Humi:55%,Press:100.1kPa		
Memo	: 5 W		

Data: 1

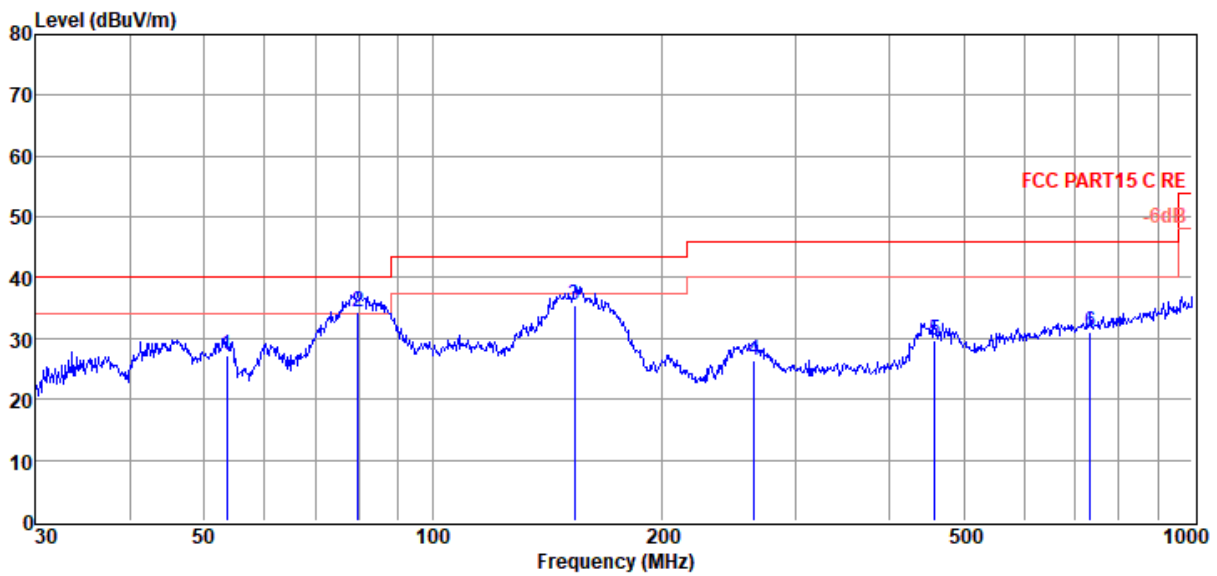

Item (Mark)	Freq. (MHz)	Read Level (dBμV)	Antenna Factor (dB/m)	Cable Loss (dB)	Result Level (dBμV/m)	Limit Line (dBμV/m)	Over Limit (dB)	Detector	Polarization
1	53.51	9.54	13.75	4.03	27.32	40.00	-12.68	QP	VERTICAL
2	79.80	21.03	9.11	4.25	34.39	40.00	-5.61	QP	VERTICAL
3	153.74	22.29	8.45	4.76	35.50	43.50	-8.00	QP	VERTICAL
4	264.75	7.86	13.27	5.36	26.49	46.00	-19.51	QP	VERTICAL
5	457.51	6.99	16.44	6.19	29.62	46.00	-16.38	QP	VERTICAL
6	734.49	3.79	20.19	7.18	31.16	46.00	-14.84	QP	VERTICAL

Note:

1. Result Level = Read Level + Antenna Factor + Cable loss.
2. If Peak Result complies with QP limit, QP Result is deemed to comply with QP limit.
3. Test setup: RBW: 120 kHz, VBW: 300 kHz, Sweep time: auto.

TR-4-E-009 Radiated Emission Test Result

Test Site : DDT 3m Chamber 1# D:\2020 RE 1# Report data\Q20081721-1E JR-A26\FCC BELOW1G.EM6
Test Date : 2020-11-01 **Tested By** : Jacky
EUT : 2-in-1 15W Wireless Charger **Model Number** : JR-A26
Power Supply : AC 120V/60Hz **Test Mode** : Tx mode
Condition : Temp:24.5°C,Humi:55%,Press:100.1k Pa **Antenna/Distance** : 2019 VULB 9163 1#/3m/HORIZONTAL
Memo : 5 W

Data: 2

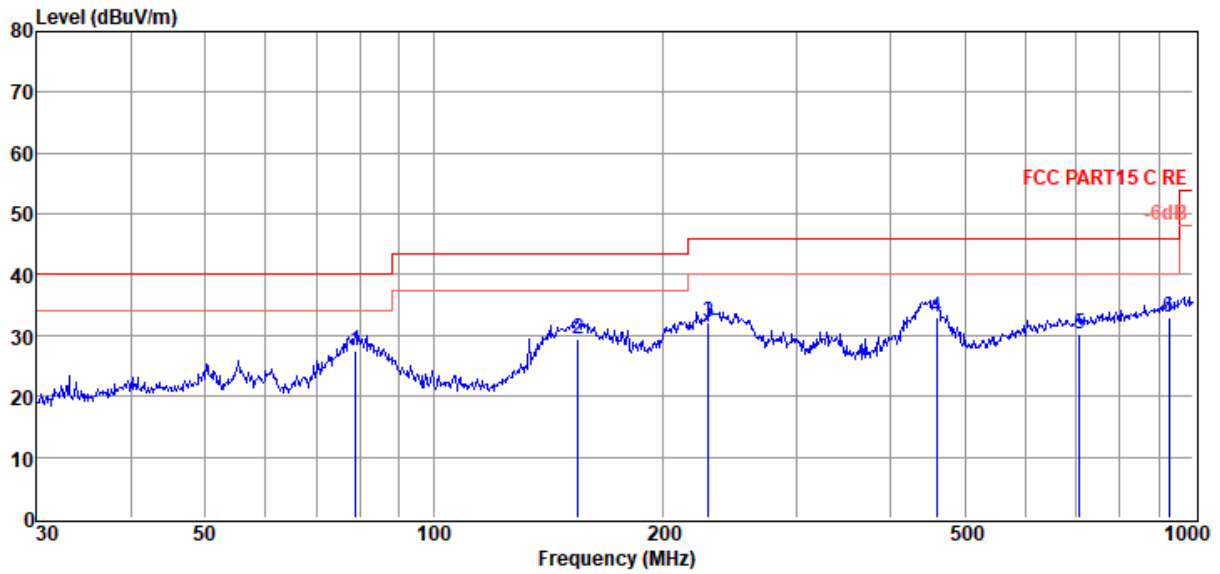

Item (Mark)	Freq. (MHz)	Read Level (dBμV)	Antenna Factor (dB/m)	Cable Loss (dB)	Result Level (dBμV/m)	Limit Line (dBμV/m)	Over Limit (dB)	Detector	Polarization
1	78.97	14.01	9.15	4.24	27.40	40.00	-12.60	QP	HORIZONTAL
2	154.82	16.14	8.50	4.77	29.41	43.50	-14.09	QP	HORIZONTAL
3	230.10	14.68	12.33	5.19	32.20	46.00	-13.80	QP	HORIZONTAL
4	459.11	10.20	16.47	6.19	32.86	46.00	-13.14	QP	HORIZONTAL
5	709.18	3.21	19.98	7.11	30.30	46.00	-15.70	QP	HORIZONTAL
6	929.01	3.17	22.10	7.77	33.04	46.00	-12.96	QP	HORIZONTAL

Note:

1. Result Level = Read Level + Antenna Factor + Cable loss.
2. If Peak Result complies with QP limit, QP Result is deemed to comply with QP limit.
3. Test setup: RBW: 120 kHz, VBW: 300 kHz, Sweep time: auto.

TR-4-E-009 Radiated Emission Test Result

Test Site : DDT 3m Chamber 1# D:\2020 RE 1# Report data\Q20081721-1E JR-A26\FCC BELOW1G.EM6
Test Date : 2020-11-01 **Tested By** : Jacky
EUT : 2-in-1 15W Wireless Charger **Model Number** : JR-A26
Power Supply : AC 120V/60Hz **Test Mode** : Tx mode
Condition : Temp:24.5°C,Humi:55%,Press:100.1kPa **Antenna/Distance** : 2019 VULB 9163 1#/3m/VERTICAL
Memo : 7.5 W

Data: 3

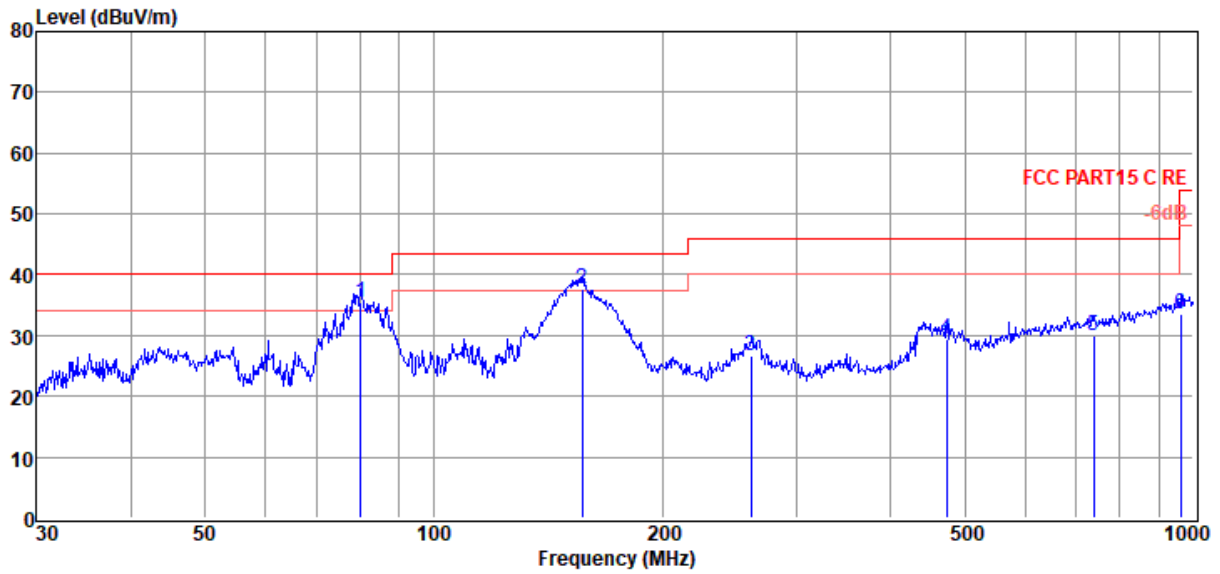

Item (Mark)	Freq. (MHz)	Read Level (dBμV)	Antenna Factor (dB/m)	Cable Loss (dB)	Result Level (dBμV/m)	Limit Line (dBμV/m)	Over Limit (dB)	Detector	Polarization
1	80.08	22.23	9.12	4.25	35.60	40.00	-4.40	QP	VERTICAL
2	157.01	24.33	8.58	4.79	37.70	43.50	-5.80	QP	VERTICAL
3	261.98	8.13	13.20	5.35	26.68	46.00	-19.32	QP	VERTICAL
4	473.84	6.38	16.74	6.25	29.37	46.00	-16.63	QP	VERTICAL
5	739.66	2.58	20.23	7.20	30.01	46.00	-15.99	QP	VERTICAL
6	962.16	3.35	22.43	7.87	33.65	54.00	-20.35	QP	VERTICAL

Note:

1. Result Level = Read Level + Antenna Factor + Cable loss.
2. If Peak Result complies with QP limit, QP Result is deemed to comply with QP limit.
3. Test setup: RBW: 120 kHz, VBW: 300 kHz, Sweep time: auto.

TR-4-E-009 Radiated Emission Test Result

Test Site : DDT 3m Chamber 1# D:\2020 RE 1# Report data\Q20081721-1E JR-A26\FCC BELOW1G.EM6
Test Date : 2020-11-01 **Tested By** : Jacky
EUT : 2-in-1 15W Wireless Charger **Model Number** : JR-A26
Power Supply : AC 120V/60Hz **Test Mode** : Tx mode
Condition : Temp:24.5°C,Humi:55%,Press:100.1kPa **Antenna/Distance** : 2019 VULB 9163 1#/3m/HORIZONTAL
Memo : 7.5 W

Data: 4

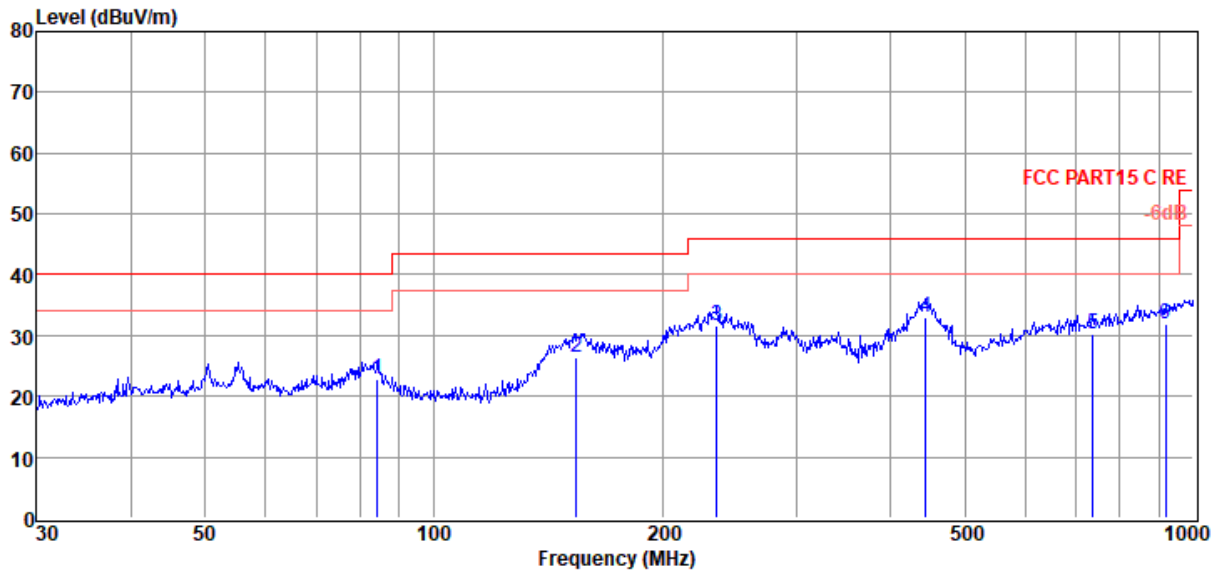

Item (Mark)	Freq. (MHz)	Read Level (dBμV)	Antenna Factor (dB/m)	Cable Loss (dB)	Result Level (dBμV/m)	Limit Line (dBμV/m)	Over Limit (dB)	Detector	Polarization
1	84.41	8.52	9.92	4.29	22.73	40.00	-17.27	QP	HORIZONTAL
2	154.28	13.11	8.47	4.77	26.35	43.50	-17.15	QP	HORIZONTAL
3	235.82	14.02	12.50	5.22	31.74	46.00	-14.26	QP	HORIZONTAL
4	444.85	10.58	16.20	6.14	32.92	46.00	-13.08	QP	HORIZONTAL
5	737.07	2.93	20.21	7.19	30.33	46.00	-15.67	QP	HORIZONTAL
6	919.29	2.27	22.00	7.74	32.01	46.00	-13.99	QP	HORIZONTAL

Note:

1. Result Level = Read Level + Antenna Factor + Cable loss.
2. If Peak Result complies with QP limit, QP Result is deemed to comply with QP limit.
3. Test setup: RBW: 120 kHz, VBW: 300 kHz, Sweep time: auto.

TR-4-E-009 Radiated Emission Test Result

Test Site : DDT 3m Chamber 1# D:\2020 RE 1# Report data\Q20081721-1E JR-A26\FCC BELOW1G.EM6
Test Date : 2020-11-01 **Tested By** : Jacky
EUT : 2-in-1 15W Wireless Charger **Model Number** : JR-A26
Power Supply : AC 120V/60Hz **Test Mode** : Tx mode
Condition : Temp:24.5°C,Humi:55%,Press:100.1kPa **Antenna/Distance** : 2019 VULB 9163 1#/3m/VERTICAL
Memo : 10 W

Data: 5

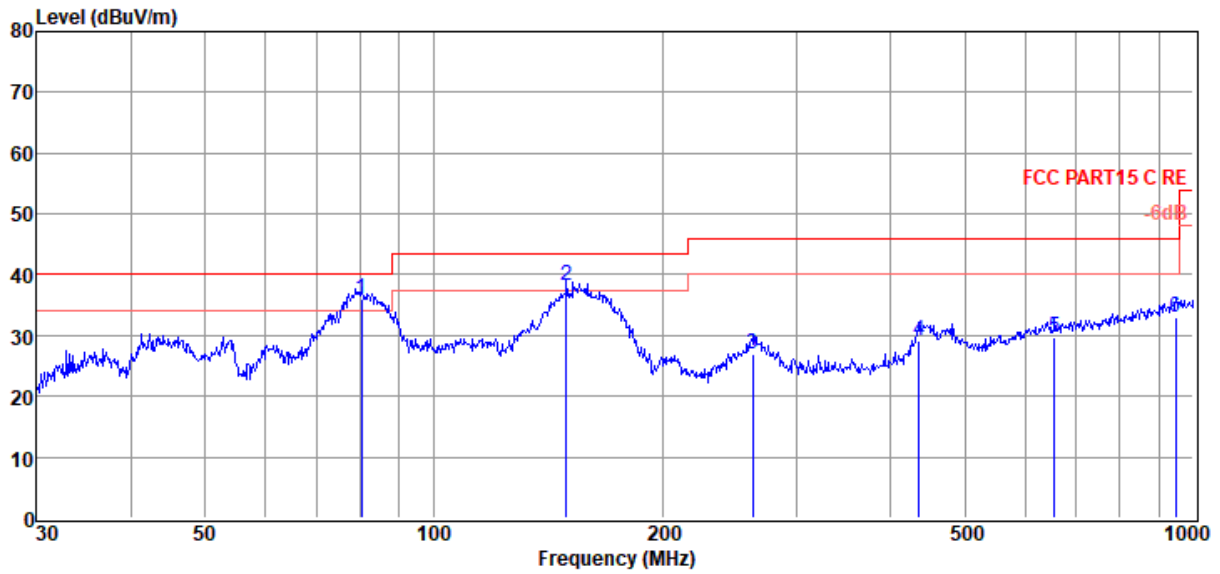

Item (Mark)	Freq. (MHz)	Read Level (dBμV)	Antenna Factor (dB/m)	Cable Loss (dB)	Result Level (dBμV/m)	Limit Line (dBμV/m)	Over Limit (dB)	Detector	Polarization
1	80.36	22.48	9.17	4.25	35.90	40.00	-4.10	QP	VERTICAL
2	149.49	25.03	8.31	4.74	38.08	43.50	-5.42	QP	VERTICAL
3	262.90	8.48	13.22	5.36	27.06	46.00	-18.94	QP	VERTICAL
4	435.59	7.10	16.03	6.11	29.24	46.00	-16.76	QP	VERTICAL
5	656.53	3.08	19.61	6.94	29.63	46.00	-16.37	QP	VERTICAL
6	948.76	2.93	22.30	7.83	33.06	46.00	-12.94	QP	VERTICAL

Note:

1. Result Level = Read Level + Antenna Factor + Cable loss.
2. If Peak Result complies with QP limit, QP Result is deemed to comply with QP limit.
3. Test setup: RBW: 120 kHz, VBW: 300 kHz, Sweep time: auto.

TR-4-E-009 Radiated Emission Test Result

Test Site : DDT 3m Chamber 1# D:\2020 RE 1# Report data\Q20081721-1E JR-A26\FCC BELOW1G.EM6
Test Date : 2020-11-01 **Tested By** : Jacky
EUT : 2-in-1 15W Wireless Charger **Model Number** : JR-A26
Power Supply : AC 120V/60Hz **Test Mode** : Tx mode
Condition : Temp:24.5°C,Humi:55%,Press:100.1kPa **Antenna/Distance** : 2019 VULB 9163 1#/3m/HORIZONTAL
Memo : 10 W

Data: 6

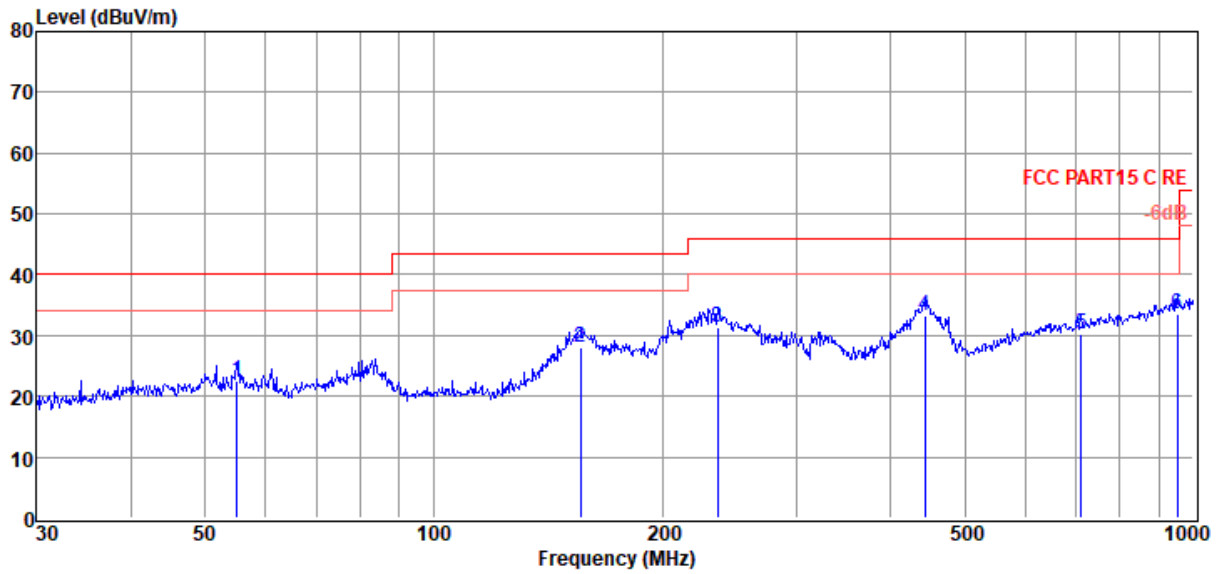

Item (Mark)	Freq. (MHz)	Read Level (dBμV)	Antenna Factor (dB/m)	Cable Loss (dB)	Result Level (dBμV/m)	Limit Line (dBμV/m)	Over Limit (dB)	Detector	Polarization
1	55.03	4.86	13.57	4.04	22.47	40.00	-17.53	QP	HORIZONTAL
2	155.91	14.74	8.54	4.78	28.06	43.50	-15.44	QP	HORIZONTAL
3	236.65	13.69	12.52	5.23	31.44	46.00	-14.56	QP	HORIZONTAL
4	443.29	10.88	16.18	6.14	33.20	46.00	-12.80	QP	HORIZONTAL
5	711.67	3.20	20.00	7.11	30.31	46.00	-15.69	QP	HORIZONTAL
6	952.09	3.26	22.33	7.84	33.43	46.00	-12.57	QP	HORIZONTAL

Note:

1. Result Level = Read Level + Antenna Factor + Cable loss.
2. If Peak Result complies with QP limit, QP Result is deemed to comply with QP limit.
3. Test setup: RBW: 120 kHz, VBW: 300 kHz, Sweep time: auto.

TR-4-E-009 Radiated Emission Test Result

Test Site : DDT 3m Chamber 1# D:\2020 RE 1# Report data\Q20081721-1E JR-A26\FCC BELOW1G.EM6
Test Date : 2020-11-01 **Tested By** : Jacky
EUT : 2-in-1 15W Wireless Charger **Model Number** : JR-A26
Power Supply : AC 120V/60Hz **Test Mode** : Tx mode
Condition : Temp:24.5°C,Humi:55%,Press:100.1kPa **Antenna/Distance** : 2019 VULB 9163 1#/3m/VERTICAL
Memo : 15 W

Data: 7

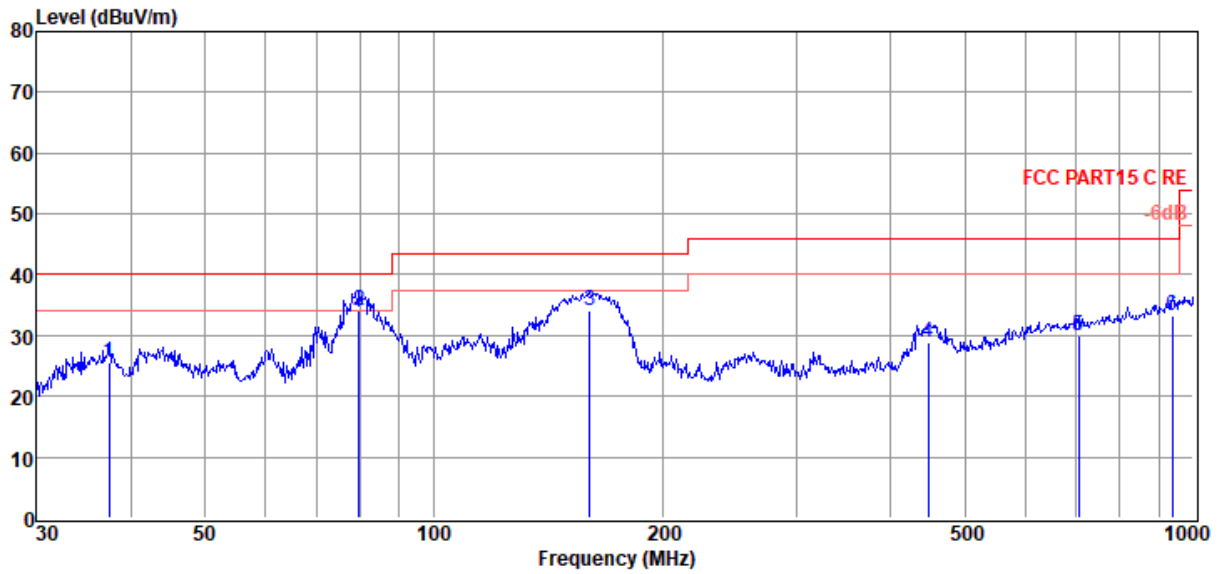

Item (Mark)	Freq. (MHz)	Read Level (dBμV)	Antenna Factor (dB/m)	Cable Loss (dB)	Result Level (dBμV/m)	Limit Line (dBμV/m)	Over Limit (dB)	Detector	Polarization
1	37.42	8.69	13.12	3.88	25.69	40.00	-14.31	QP	VERTICAL
2	79.80	20.74	9.11	4.25	34.10	40.00	-5.90	QP	VERTICAL
3	160.35	20.69	8.72	4.81	34.22	43.50	-9.28	QP	VERTICAL
4	447.98	6.39	16.26	6.15	28.80	46.00	-17.20	QP	VERTICAL
5	706.70	2.80	19.96	7.10	29.86	46.00	-16.14	QP	VERTICAL
6	938.83	3.17	22.20	7.80	33.17	46.00	-12.83	QP	VERTICAL

Note:

1. Result Level = Read Level + Antenna Factor + Cable loss.
2. If Peak Result complies with QP limit, QP Result is deemed to comply with QP limit.
3. Test setup: RBW: 120 kHz, VBW: 300 kHz, Sweep time: auto.

TR-4-E-009 Radiated Emission Test Result

Test Site : DDT 3m Chamber 1# D:\2020 RE 1# Report data\Q20081721-1E JR-A26\FCC BELOW1G.EM6
Test Date : 2020-11-01 **Tested By** : Jacky
EUT : 2-in-1 15W Wireless Charger **Model Number** : JR-A26
Power Supply : AC 120V/60Hz **Test Mode** : Tx mode
Condition : Temp:24.5°C,Humi:55%,Press:100.1kPa **Antenna/Distance** : 2019 VULB 9163 1#/3m/HORIZONTAL
Memo : 15 W

Data: 8

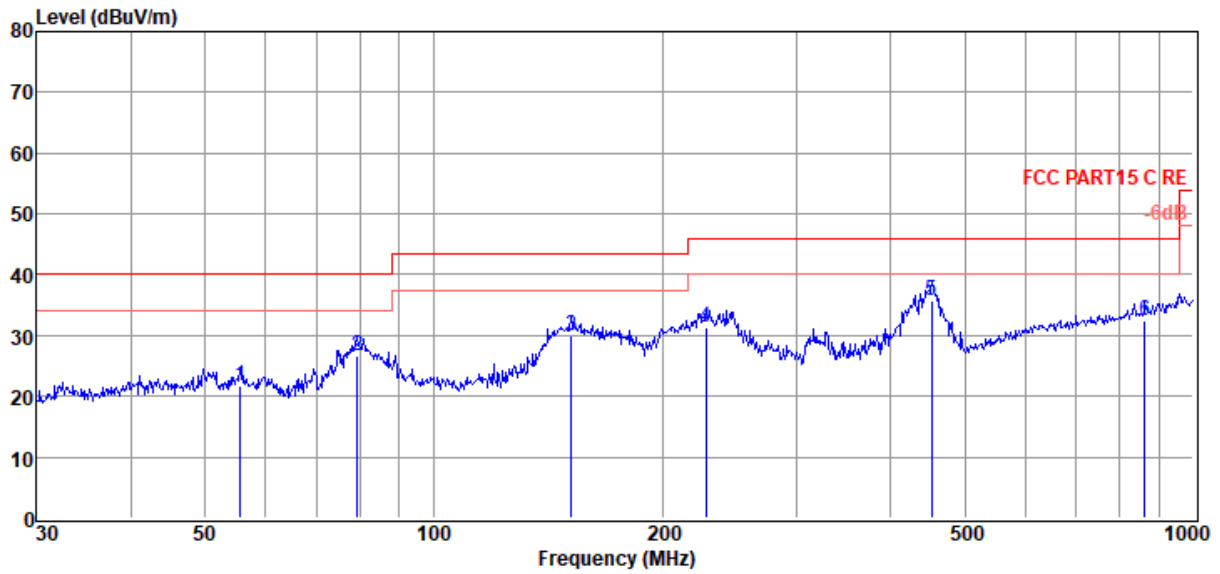

Item (Mark)	Freq. (MHz)	Read Level (dBμV)	Antenna Factor (dB/m)	Cable Loss (dB)	Result Level (dBμV/m)	Limit Line (dBμV/m)	Over Limit (dB)	Detector	Polarization
1	55.61	4.03	13.50	4.05	21.58	40.00	-18.42	QP	HORIZONTAL
2	79.24	13.26	9.14	4.24	26.64	40.00	-13.36	QP	HORIZONTAL
3	151.60	16.91	8.37	4.75	30.03	43.50	-13.47	QP	HORIZONTAL
4	228.49	13.85	12.29	5.18	31.32	46.00	-14.68	QP	HORIZONTAL
5	452.72	13.25	16.35	6.17	35.77	46.00	-10.23	QP	HORIZONTAL
6	863.06	3.35	21.41	7.57	32.33	46.00	-13.67	QP	HORIZONTAL

Note:

1. Result Level = Read Level + Antenna Factor + Cable loss.
2. If Peak Result complies with QP limit, QP Result is deemed to comply with QP limit.
3. Test setup: RBW: 120 kHz, VBW: 300 kHz, Sweep time: auto.

6 Power Line Conducted Emission

6.1. Block diagram of test setup

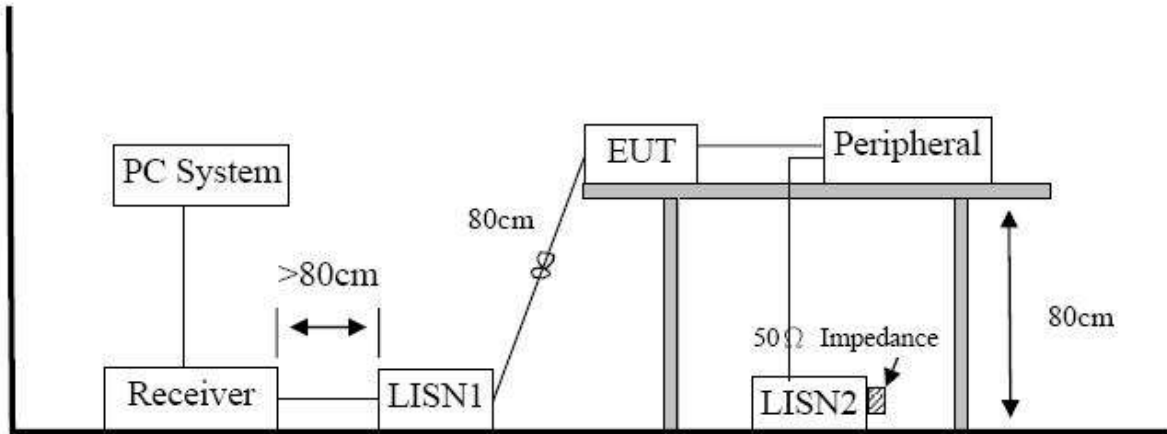

6.2. Power line conducted emission limits

Frequency	Quasi-Peak Level dB(μ V)	Average Level dB(μ V)
150 kHz ~ 500 kHz	66 ~ 56*	56 ~ 46*
500 kHz ~ 5 MHz	56	46
5 MHz ~ 30 MHz	60	50

Note 1: * Decreasing linearly with logarithm of frequency.

Note 2: The lower limit shall apply at the transition frequencies.

6.3. Test procedure

The EUT and Support equipment, if needed, were put placed on a non-metallic table, 80 cm above the ground plane.

Configuration EUT to simulate typical usage as described in clause 2.4 and test equipment as described in clause 10.2 of this report.

All I/O cables were positioned to simulate typical actual usage as per ANSI C63.10.

All support equipment power received from a second LISN.

Emissions were measured on each current carrying line of the EUT using an EMI Test Receiver connected to the LISN powering the EUT.

The Receiver scanned from 150 kHz to 30 MHz for emissions in each of the test modes.

During the above scans, the emissions were maximized by cable manipulation.

The test mode(s) described in clause 2.4 were scanned during the preliminary test.

After the preliminary scan, we found the test mode producing the highest emission level.

The EUT configuration and worst cable configuration of the above highest emission levels were recorded for reference of the final test.

EUT and support equipment were set up on the test bench as per the configuration with highest emission level in the preliminary test.

A scan was taken on both power lines, Neutral and Line, recording at least the six highest emissions.

Emission frequency and amplitude were recorded into a computer in which correction factors were used to calculate the emission level and compare reading to the applicable limit.

The test data of the worst-case condition(s) was recorded.

The bandwidth of test receiver is set at 9 kHz.

6.4. Test result

PASS. (See below detailed test result)

Note1: All emissions not reported below are too low against the prescribed limits.

Note2: “-----” means Peak detection; “-----” means Average detection.

Note3: Pre-test AC conducted emission at both voltage AC 120V/60Hz and AC 240V/60Hz, recorded worse case (AC 120V/60Hz).

Note4: One device charging and two devices charging simultaneously both have been tested, and found two devices charging simultaneously was worse case and reported.

TR-4-E-010 Conducted Emission Test Result

Test Site : DDT 1# Shield Room D:\2020 CE report data\Q20081721-1E\20201103 CE.EM6
Test Date : 2020-11-03 **Tested By** : Bote Huang
EUT : 2-in-1 15W Wireless Charger **Model Number** : JR-A26
Power Supply : AC 120V/60Hz **Test Mode** : Tx mode
Condition : TEMP:24.7°C, RH:52.%, BP:101.4kPa **LISN** : 2019 ENV216 1#/LINE
Memo :

Data: 2

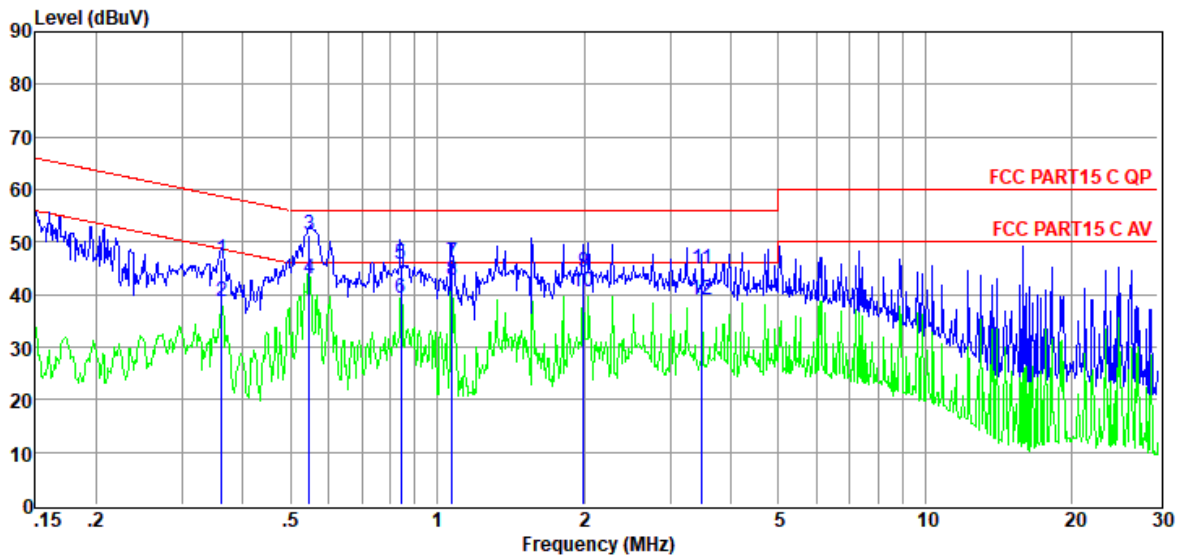

Item	Freq.	Read Level	LISN Factor	Cable Loss	Pulse Limiter Factor	Result Level	Limit Line	Over Limit	Detector	Phase
(Mark)	(MHz)	(dBμV)	(dB)	(dB)	(dB)	(dBμV)	(dBμV)	(dB)		
1	0.36	27.27	9.60	0.02	9.86	46.75	58.69	-11.94	QP	LINE
2	0.36	19.06	9.60	0.02	9.86	38.54	48.69	-10.15	Average	LINE
3	0.55	31.90	9.60	0.02	9.86	51.38	56.00	-4.62	QP	LINE
4	0.55	23.50	9.60	0.02	9.86	42.98	46.00	-3.02	Average	LINE
5	0.84	26.34	9.60	0.03	9.86	45.83	56.00	-10.17	QP	LINE
6	0.84	19.85	9.60	0.03	9.86	39.34	46.00	-6.66	Average	LINE
7	1.07	26.56	9.60	0.03	9.86	46.05	56.00	-9.95	QP	LINE
8	1.07	23.08	9.60	0.03	9.86	42.57	46.00	-3.43	Average	LINE
9	1.99	24.80	9.60	0.05	9.86	44.31	56.00	-11.69	QP	LINE
10	1.99	21.13	9.60	0.05	9.86	40.64	46.00	-5.36	Average	LINE
11	3.49	25.24	9.60	0.07	9.87	44.78	56.00	-11.22	QP	LINE
12	3.49	19.46	9.60	0.07	9.87	39.00	46.00	-7.00	Average	LINE

Note:

1. Result Level = Read Level + LISN Factor + Pulse Limiter Factor + Cable loss.
2. If QP Result complies with AV limit, AV Result is deemed to comply with AV limit.
3. Test setup: RBW: 200 Hz (9 kHz—150 kHz), 9 kHz (150 kHz—30 MHz).
4. Step size: 80Hz (0.009MHz-0.15MHz), 4 kHz (0.15MHz-30MHz), Scan time: auto.

TR-4-E-010 Conducted Emission Test Result

Test Site : DDT 1# Shield Room D:\2020 CE report data\Q20081721-1E\20201103 CE.EM6
Test Date : 2020-11-03 **Tested By** : Bote Huang
EUT : 2-in-1 15W Wireless Charger **Model Number** : JR-A26
Power Supply : AC 120V/60Hz **Test Mode** : Tx mode
Condition : TEMP:24.7°C, RH:52.%, BP:101.4kPa **LISN** : 2019 ENV216 1#/NEUTRAL
Memo :

Data: 4

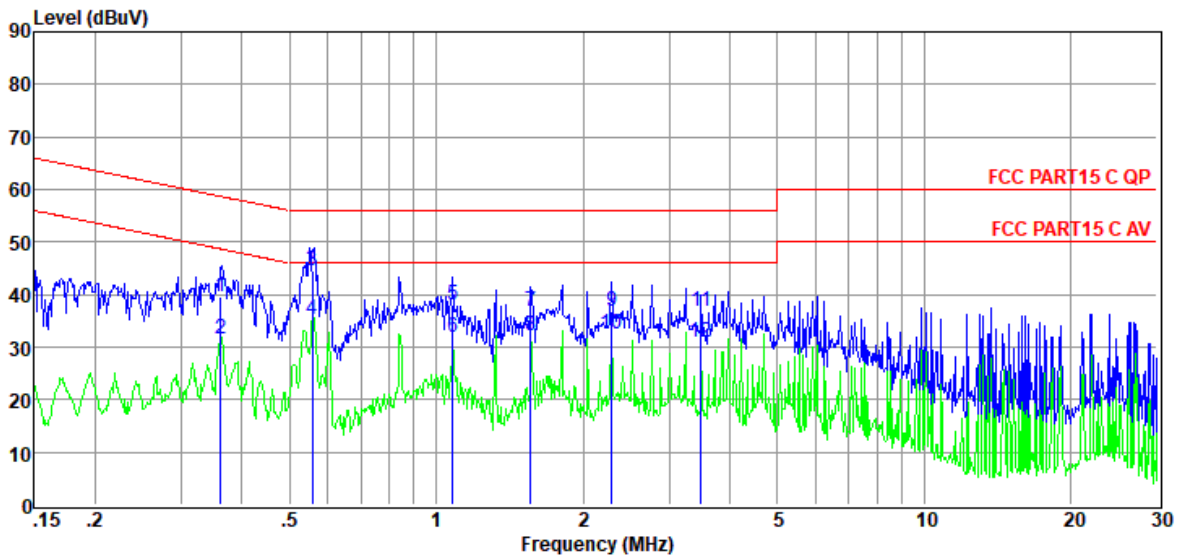

Item	Freq.	Read Level	LISN Factor	Cable Loss	Pulse Limiter Factor	Result Level	Limit Line	Over Limit	Detector	Phase
(Mark)	(MHz)	(dBμV)	(dB)	(dB)	(dB)	(dBμV)	(dBμV)	(dB)		
1	0.36	20.12	9.60	0.02	9.86	39.60	58.69	-19.09	QP	NEUTRAL
2	0.36	12.15	9.60	0.02	9.86	31.63	48.69	-17.06	Average	NEUTRAL
3	0.56	25.04	9.60	0.02	9.86	44.52	56.00	-11.48	QP	NEUTRAL
4	0.56	15.86	9.60	0.02	9.86	35.34	46.00	-10.66	Average	NEUTRAL
5	1.08	18.62	9.60	0.03	9.86	38.11	56.00	-17.89	QP	NEUTRAL
6	1.08	12.42	9.60	0.03	9.86	31.91	46.00	-14.09	Average	NEUTRAL
7	1.56	17.30	9.60	0.04	9.86	36.80	56.00	-19.20	QP	NEUTRAL
8	1.56	12.63	9.60	0.04	9.86	32.13	46.00	-13.87	Average	NEUTRAL
9	2.29	17.18	9.60	0.06	9.86	36.70	56.00	-19.30	QP	NEUTRAL
10	2.29	12.82	9.60	0.06	9.86	32.34	46.00	-13.66	Average	NEUTRAL
11	3.49	17.34	9.60	0.07	9.87	36.88	56.00	-19.12	QP	NEUTRAL
12	3.49	11.42	9.60	0.07	9.87	30.96	46.00	-15.04	Average	NEUTRAL

Note:

1. Result Level = Read Level + LISN Factor + Pulse Limiter Factor + Cable loss.
2. If QP Result complies with AV limit, AV Result is deemed to comply with AV limit.
3. Test setup: RBW: 200 Hz (9 kHz—150 kHz), 9 kHz (150 kHz—30 MHz).
4. Step size: 80Hz (0.009MHz-0.15MHz), 4 kHz (0.15MHz-30MHz), Scan time: auto.

7 Antenna Requirements

For intentional device, according to FCC 47 CFR Section 15.203, an intentional radiator shall be designed to ensure that no antenna other than that furnished by the responsible party shall be used with the device. The use of a permanently attached antenna or of an antenna that uses a unique coupling to the intentional radiator shall be considered sufficient to comply with the provisions of this section. The manufacturer may design the unit so that a broken antenna can be replaced by the user, but the use of a standard antenna jack or electrical connector is prohibited.

Conclusion: The antenna used for this product is inductive loop coil antenna and that no antenna other than that furnished by the responsible party shall be used with the device.

END OF REPORT