

# FCC RADIO TEST REPORT

**FCC ID: 2AWJ2-12S**

**Sample:** TWS true wireless headset

**Trade Name:** N/A

**Main Model:** 12S

**Additional Model:** T8A,S7,S12,TWS08,TWS09,Q7,YH03,YH09

**Report No.:** UNIA22022604ER-61

## Prepared for

Shenzhen Kangchen Electronic Co., Ltd.

8 / F, Building B, Ruixiangfa Industrial Park, No. 3, Shangxue Science Park,  
Bantian, Longgang District, Shenzhen, 518116, China

## Prepared by

Shenzhen United Testing Technology Co., Ltd.

2F, Annex Bldg, Jiahuangyuan Tech Park, #365 Baotian 1 Rd, Tiegang  
Community, Xixiang Str, Bao'an District, Shenzhen, China



## TEST RESULT CERTIFICATION

**Applicant**.....: Shenzhen Kangchen Electronic Co., Ltd.  
8 / F, Building B, Ruixiangfa Industrial Park, No. 3, Shangxue  
**Address**.....: Science Park, Bantian, Longgang District, Shenzhen, 518116,  
China

**Manufacturer**.....: Shenzhen Kangchen Electronic Co., Ltd.  
8 / F, Building B, Ruixiangfa Industrial Park, No. 3, Shangxue  
**Address**.....: Science Park, Bantian, Longgang District, Shenzhen, 518116,  
China

### Product description

**Product**.....: TWS true wireless headset  
**Trade Name**.....: N/A  
**Model Name**.....: 12S,T8A,S7,S12,TWS08,TWS09,Q7,YH03,YH09

**Test Methods**.....: FCC Rules and Regulations Part 15 Subpart C Section 15.249,  
ANSI C63.10: 2013

This device described above has been tested by Shenzhen United Testing Technology Co., Ltd., and the test results show that the equipment under test (EUT) is in compliance with the FCC requirements. And it is applicable only to the tested sample identified in the report.

This report shall not be reproduced except in full, without the written approval of UNI, this document may be altered or revised by Shenzhen United Testing Technology Co., Ltd., personnel only, and shall be noted in the revision of the document.

**Date of Test**.....: \_\_\_\_\_  
**Date (s) of performance of tests**.....: Feb. 26, 2022 ~ Mar. 15, 2022  
**Date of Issue**.....: Mar. 15, 2022  
**Test Result**.....: Pass

Prepared by:

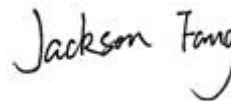

Jackson Fang/Editor

**kahn.yang**

Reviewer:

Kahn yang/Supervisor

Approved & Authorized Signer:



Liuze/Manager

Table of Contents

Page

<b>1 TEST SUMMARY</b>	4
<b>2 GENERAL INFORMATION</b>	6
2.1 GENERAL DESCRIPTION OF EUT	6
2.2 CARRIER FREQUENCY OF CHANNELS	7
2.3 TEST MODE	7
2.4 TEST SETUP	8
2.5 DESCRIPTION TEST PERIPHERAL AND EUT PERIPHERAL	8
2.6 MEASUREMENT INSTRUMENTS LIST	9
<b>3 CONDUCTED EMISSION</b>	10
3.1 TEST LIMIT	10
3.2 TEST SETUP	10
3.3 TEST PROCEDURE	11
3.4 TEST RESULT	11
<b>4 RADIATED EMISSION</b>	14
4.1 TEST LIMIT	14
4.2 TEST SETUP	15
4.3 TEST PROCEDURE	16
4.4 TEST RESULT	16
<b>5 BAND EDGE</b>	28
5.1 TEST LIMIT	28
5.2 TEST PROCEDURE	28
5.3 TEST RESULT	28
<b>6 OCCUPIED BANDWIDTH</b>	31
6.1 TEST SETUP	31
6.2 TEST PROCEDURE	31
6.4 TEST RESULT	31
<b>7 ANTENNA REQUIREMENT</b>	38
<b>8 PHOTO OF TEST</b>	39
8.1 RADIATED EMISSION	39
8.2 CONDUCTED EMISSION	40

## TEST SUMMARY

### TEST PROCEDURES AND RESULTS

ITEM	STANGARD	RESULT
CONDUCTED EMISSION	FCC Part 15.207	COMPLIANT
RADIATED EMISSION	FCC Part 15.209/15.249	COMPLIANT
BAND EDGE	FCC Part 15.249/15.205	COMPLIANT
OCCUPIED BANDWIDTH	FCC Part 15.215	COMPLIANT
ANTENNA REQUIREMENT	FCC Part 15.203	COMPLIANT

### TEST FACILITY

Test Firm : Shenzhen United Testing Technology Co., Ltd.  
Address : 2F, Annex Bldg, Jiahuangyuan Tech Park, #365 Baotian 1 Rd, Tiegang Community, Xixiang Str, Bao'an District, Shenzhen, China

The testing quality ability of our laboratory meet with "Quality Law of People's Republic of China" Clause 19. The testing quality system of our laboratory meets with ISO/IEC-17025 requirements. This approval result is accepted by MRA of APLAC.

Our test facility is recognized, certified, or accredited by the following organizations:

A2LA Certificate Number: 4747.01

The EMC Laboratory has been accredited by A2LA, and in compliance with ISO/IEC 17025:2017 General Requirements for testing Laboratories.

FCC Registration Number: 674885

The EMC Laboratory has been registered and fully described in a report filed with the (FCC) Federal Communications commission.

IC Registration Number: 21947

The EMC Laboratory has been registered and fully described in a report filed with the (IC) Industry Canada.

**MEASUREMENT UNCERTAINTY**

The reported uncertainty of measurement  $y \pm U$ , where expanded uncertainty  $U$  is based on a standard uncertainty multiplied by a coverage factor of  $k=2$ , providing a level of confidence of approximately 95 %.

**A. Conducted Measurement:**

Test Site	Method	Measurement Frequency Range	U, (dB)	NOTE
UNI	ANSI	9kHz ~ 150kHz	2.96	
		150kHz ~ 30MHz	2.44	

**B. Radiated Measurement:**

Test Site	Method	Measurement Frequency Range	U, (dB)	NOTE
UNI	ANSI	9kHz ~ 30MHz	2.50	
		30MHz ~ 1000MHz	4.80	
		Above 1000MHz	4.13	

GENERAL INFORMATION

GENERAL DESCRIPTION OF EUT

Product:	TWS true wireless headset
Trade Name:	N/A
Main Model:	12S
Additional Model:	T8A,S7,S12,TWS08,TWS09,Q7,YH03,YH09
Model Difference:	All model's the function, software and electric circuit are the same, only with a product color and model named different. Test sample model: 12S.
FCC ID:	2AWJ2-12S
Operation Frequency:	2402MHz~2480MHz
Number of Channels:	79CH
Modulation Type:	GFSK, $\pi/4$ DQPSK, 8DPSK
Antenna Type:	Chip Antenna
Antenna Gain:	3.35dBi
Battery:	DC 3.7V, 25mAh
Adapter:	N/A
Power Source:	DC 3.7V from Li-battery or DC 5.0V from adapter with AC 120(240)V/60Hz

CARRIER FREQUENCY OF CHANNELS

Channel List							
Channel	Frequency (MHz)	Channel	Frequency (MHz)	Channel	Frequency (MHz)	Channel	Frequency (MHz)
00	2402	21	2423	42	2444	63	2465
01	2403	22	2424	43	2445	64	2466
02	2404	23	2425	44	2446	65	2467
03	2405	24	2426	45	2447	66	2468
04	2406	25	2427	46	2448	67	2469
05	2407	26	2428	47	2449	68	2470
06	2408	27	2429	48	2450	69	2471
07	2409	28	2430	49	2451	70	2472
08	2410	29	2431	50	2452	71	2473
09	2411	30	2432	51	2453	72	2474
10	2412	31	2433	52	2454	73	2475
11	2413	32	2434	53	2455	74	2476
12	2414	33	2435	54	2456	75	2477
13	2415	34	2436	55	2457	76	2478
14	2416	35	2437	56	2458	77	2479
15	2417	36	2438	57	2459	78	2480
16	2418	37	2439	58	2460		
17	2419	38	2440	59	2461		
18	2420	39	2441	60	2462		
19	2421	40	2442	61	2463		
20	2422	41	2443	62	2464		

TEST MODE

The EUT was programmed to be in continuously transmitting mode.

Channel List		
Test Channel	EUT Channel	Test Frequency (MHz)
Low	CH00	2402
Middle	CH39	2441
High	CH78	2480

TEST SETUP

Operation of EUT during Conducted and Radiation testing:

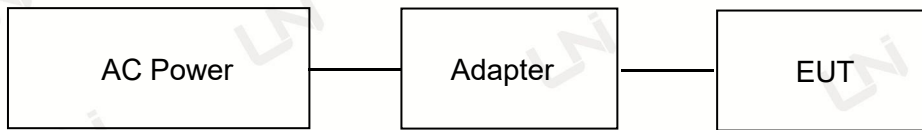

Operation of EUT during Above1GHz Radiation testing:



DESCRIPTION TEST PERIPHERAL AND EUT PERIPHERAL

The EUT has been tested as an independent unit together with other necessary accessories or support units. The following support units or accessories were used to form a representative test configuration during the tests.

Item	Equipment	Mfr/Brand	Model/Type No.	Note
E-1	TWS true wireless headset	N/A	12S	EUT
E-2	Adapter	XIAOMI	MDY-08-EF	AE

Item	Shielded Type	Ferrite Core	Length	Note

Note:

1. The support equipment was authorized by Declaration of Confirmation.
2. For detachable type I/O cable should be specified the length in cm in 『Length』 column.
3. “YES” is means “shielded” “with core”; “NO” is means “unshielded” “without core”.



MEASUREMENT INSTRUMENTS LIST

Item	Equipment	Manufacturer	Model No.	Serial No.	Calibrated until
Conduction Emissions Measurement					
1	Conducted Emission Test Software	EZ-EMC	Ver.CCS-3A1-CE	N/A	N/A
2	AMN	Schwarzbeck	NNLK8121	8121370	2022.09.22
3	AAN	TESEQ	T8-Cat6	38888	2022.09.22
4	Pulse Limiter	CYBRTEK	EM5010	E115010056	2022.05.17
5	EMI Test Receiver	Rohde&Schwarz	ESCI	101210	2022.09.22
Radiated Emissions Measurement					
1	Radiated Emission Test Software	EZ-EMC	Ver.CCS-03A1	N/A	N/A
2	Horn Antenna	Sunol	DRH-118	A101415	2022.09.27
3	Broadband Hybrid Antenna	Sunol	JB1	A090215	2024.02.26
4	PREAMP	HP	8449B	3008A00160	2022.09.22
5	PREAMP	HP	8447D	2944A07999	2022.05.17
6	EMI TEST RECEIVER	Rohde&Schwarz	ESR3	101891	2022.09.22
7	VECTOR Signal Generator	Rohde&Schwarz	SMU200A	101521	2022.09.22
8	Signal Generator	Agilent	E4421B	MY4335105	2022.09.22
9	MXA Signal Analyzer	Agilent	N9020A	MY50510140	2022.09.22
10	MXA Signal Analyzer	Keysight	N9020A	MY51110104	2022.09.22
11	RF Power sensor	DARE	RPR3006W	15I00041SNO88	2022.05.17
12	RF Power sensor	DARE	RPR3006W	15I00041SNO89	2022.05.17
13	RF power divider	Anritsu	K241B	992289	2022.09.22
14	Wideband radio communication tester	Rohde&Schwarz	CMW500	154987	2022.09.22
15	Active Loop Antenna	Com-Power	AL-130R	10160009	2022.07.25
16	Broadband Hybrid Antennas	Schwarzbeck	VULB9163	VULB9163#958	2022.09.22
17	Horn Antenna	Schwarzbeck	BBHA9120D	9120D-1680	2022.05.23
18	Horn Antenna	A-INFOMW	LB-180400-KF	J211060660	2022.09.27
19	Microwave Broadband Preamplifier	Schwarzbeck	BBV 9721	100472	2022.09.22
20	Signal Generator	Agilent	N5183A	MY47420153	2022.09.22
21	Spectrum Analyzer	Rohde&Schwarz	FSP 40	100501	2022.09.22
22	Power Meter	KEYSIGHT	N1911A	MY50520168	2022.09.22
23	Frequency Meter	VICTOR	VC2000	997406086	2022.09.22
24	DC Power Source	HYELEC	HY5020E	055161818	2022.09.22

## CONDUCTED EMISSION

### 3.1 TEST LIMIT

For unintentional device, according to § 15.207(a) Line Conducted Emission Limits is as following

Frequency (MHz)	Maximum RF Line Voltage (dB $\mu$ V)			
	CLASS A		CLASS B	
	Q.P.	Ave.	Q.P.	Ave.
0.15~0.50	79	66	66~56*	56~46*
0.50~5.00	73	60	56	46
5.00~30.0	73	60	60	50

\* Decreasing linearly with the logarithm of the frequency.

For intentional device, according to §15.207(a) Line Conducted Emission Limit is same as above table.

### 3.2 TEST SETUP

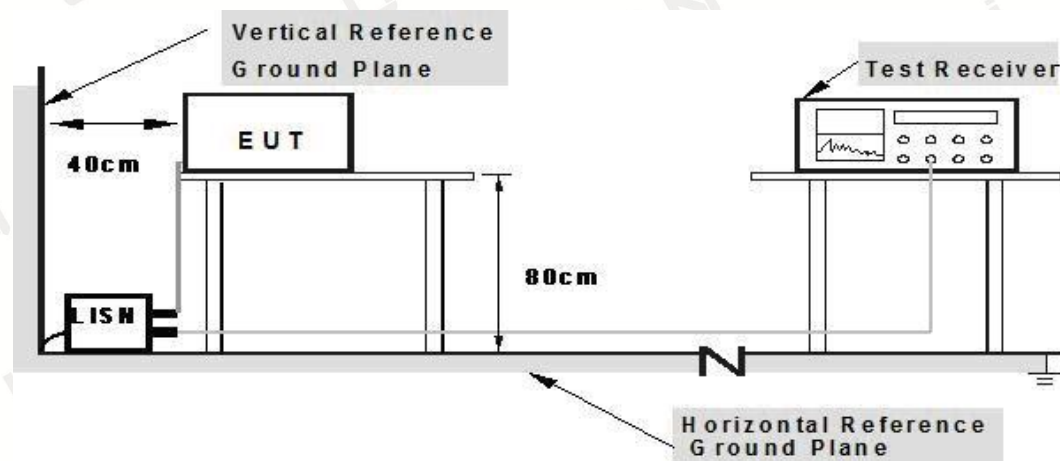

**Note: 1.Support units were connected to second LISN.**

**2.Both of LISNs (AMN) are 80 cm from EUT and at least 80 from other units and other metal planes**

### 3.3 TEST PROCEDURE

1. The equipment was set up as per the test configuration to simulate typical actual usage per the user's manual. The EUT is placed on a wooden table with a height of 0.8 meters is used and is placed on the ground plane as per ANSI C63.10.
2. Support equipment, if needed, was placed as per ANSI C63.10.
3. All I/O cables were positioned to simulate typical actual usage as per ANSI C63.10.
4. If a EUT received DC power from the USB Port of Notebook PC, the PC's adapter received AC120V/60Hz power through a Line Impedance Stabilization Network (LISN) which supplied power source and was grounded to the ground plane.
5. All support equipments received AC power from a second LISN, if any.
6. The EUT test program was started. Emissions were measured on each current carrying line of the EUT using a spectrum Analyzer / Receiver connected to the LISN powering the EUT. The LISN has two monitoring points: Line 1 (Hot Side) and Line 2 (Neutral Side). Two scans were taken: one with Line 1 connected to Analyzer / Receiver and Line 2 connected to a 50 ohm load; the second scan had Line 1 connected to a 50 ohm load and Line 2 connected to the Analyzer / Receiver.
7. Analyzer / Receiver scanned from 150 kHz to 30MHz for emissions in each of the test modes.

### 3.4 TEST RESULT

PASS

Remark:

1. All modes were tested at AC 120V and 240V, only the worst result of AC 120V was reported.
2. All modes were test at Low, Middle, and High channel, only the worst result of GFSK Low Channel was reported.

Temperature:	24°C	Relative Humidity:	48%
Test Date:	Mar. 01, 2022	Pressure:	1010hPa
Test Voltage:	AC 120V, 60Hz	Phase:	Line
Test Mode:	Transmitting mode of GFSK 2402MHz		

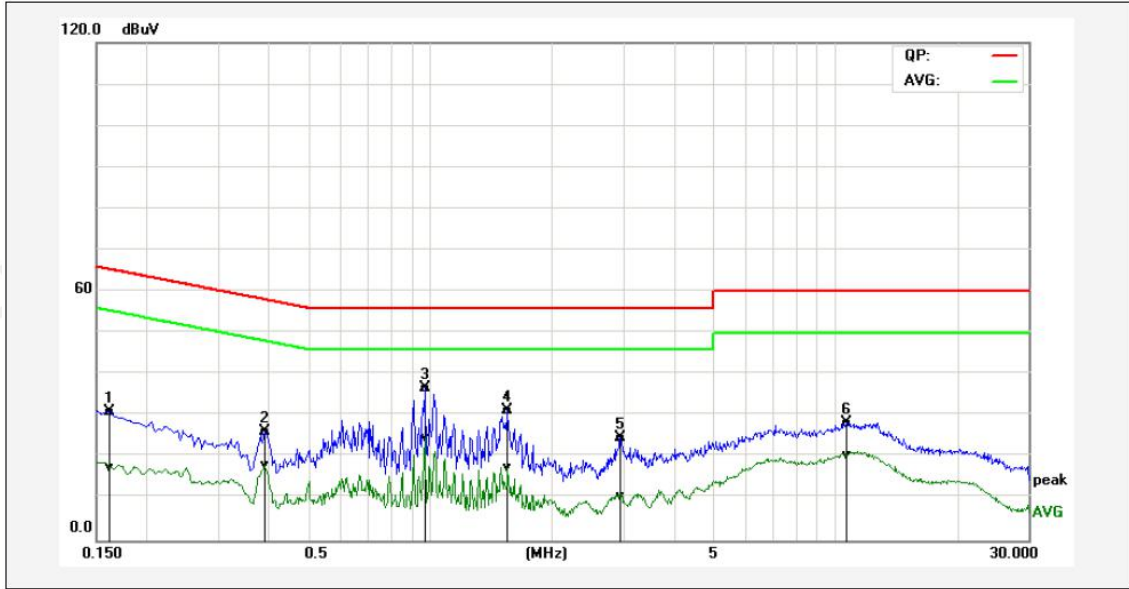

No.	Frequency (MHz)	QuasiPeak reading (dBuV)	Average reading (dBuV)	Correction factor (dB)	QuasiPeak result (dBuV)	Average result (dBuV)	QuasiPeak limit (dBuV)	Average limit (dBuV)	QuasiPeak margin (dB)	Average margin (dB)	Remark
1P	0.1620	20.98	7.47	10.13	31.11	17.60	65.36	55.36	-34.25	-37.76	Pass
2P	0.3900	16.00	8.07	10.11	26.11	18.18	58.06	48.06	-31.95	-29.88	Pass
3*	0.9700	26.75	14.61	10.12	36.87	24.73	56.00	46.00	-19.13	-21.27	Pass
4P	1.5580	21.13	7.49	10.11	31.24	17.60	56.00	46.00	-24.76	-28.40	Pass
5P	2.9580	14.72	0.51	10.17	24.89	10.68	56.00	46.00	-31.11	-35.32	Pass
6P	10.6780	18.23	10.52	10.15	28.38	20.67	60.00	50.00	-31.62	-29.33	Pass

Remark: Factor = Insertion Loss + Cable Loss, Result = Reading + Factor, Margin = Result – Limit.

Temperature:	24°C	Relative Humidity:	48%
Test Date:	Mar. 01, 2022	Pressure:	1010hPa
Test Voltage:	AC 120V, 60Hz	Phase:	Neutral
Test Mode:	Transmitting mode of GFSK 2402MHz		

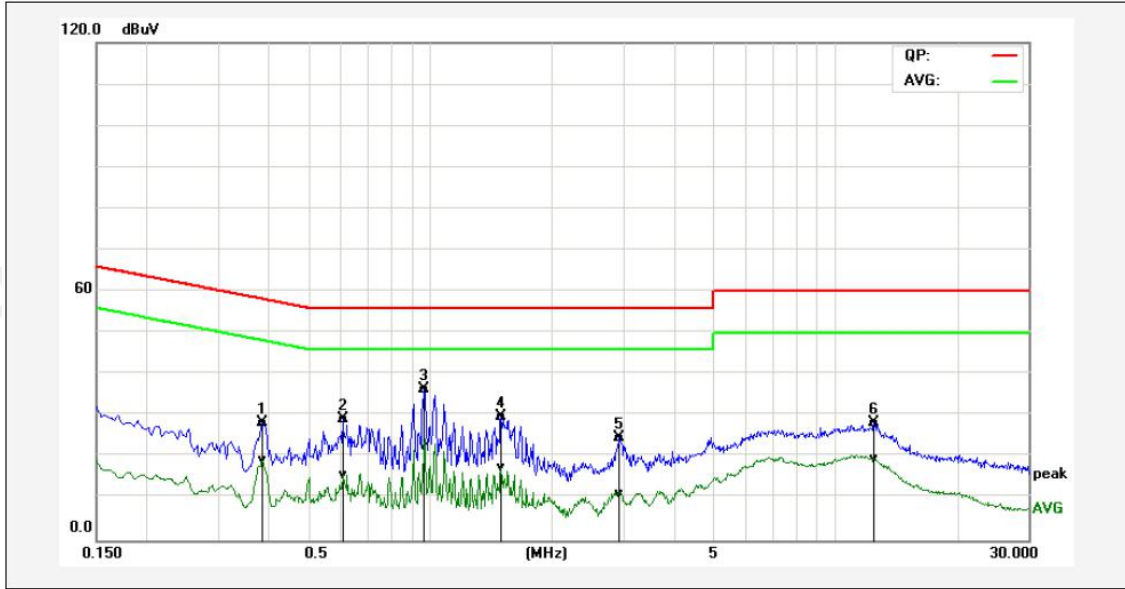

No.	Frequency (MHz)	QuasiPeak reading (dBuV)	Average reading (dBuV)	Correction factor (dB)	QuasiPeak result (dBuV)	Average result (dBuV)	QuasiPeak limit (dBuV)	Average limit (dBuV)	QuasiPeak margin (dB)	Average margin (dB)	Remark
1P	0.3860	18.29	9.23	10.11	28.40	19.34	58.15	48.15	-29.75	-28.81	Pass
2P	0.6100	19.10	5.72	10.08	29.18	15.80	56.00	46.00	-26.82	-30.20	Pass
3*	0.9660	26.21	12.49	10.12	36.33	22.61	56.00	46.00	-19.67	-23.39	Pass
4P	1.4980	19.85	7.43	10.10	29.95	17.53	56.00	46.00	-26.05	-28.47	Pass
5P	2.9460	14.68	1.06	10.17	24.85	11.23	56.00	46.00	-31.15	-34.77	Pass
6P	12.4540	18.06	9.48	10.19	28.25	19.67	60.00	50.00	-31.75	-30.33	Pass

Remark: Factor = Insertion Loss + Cable Loss, Result = Reading + Factor, Margin = Result – Limit.

## 4 RADIATED EMISSION

### 4.1 TEST LIMIT

For unintentional device, according to § 15.209(a), except for Class B digital devices, the field strength of radiated emissions from unintentional radiators at a distance of 3 meters shall not exceed the following values:

Frequency	Field strength (microvolt/meter)	Limit (dBuV/m )	Remark	Measurement distance (m)
0.009MHz-0.490MHz	2400/F (kHz)	-	Quasi-peak	300
0.490MHz-1.705MHz	24000/F (kHz)	-	Quasi-peak	30
1.705MHz-30MHz	30	-	Quasi-peak	30
30MHz-88MHz	100	40.0	Quasi-peak	3
88MHz-216MHz	150	43.5	Quasi-peak	3
216MHz-960MHz	200	46.0	Quasi-peak	3
960MHz-1GHz	500	54.0	Quasi-peak	3
Above 1GHz	500	54.0	Average	3
		74.0	Peak	3

For intentional device, according to § 15.209(a), the general requirement of field strength of radiated emissions from intentional radiators at a distance of 3 meters shall not exceed the above table.

Limit: (Field strength of the fundamental signal)

Frequency	Limit (dBuV/m @3m)	Remark
2400MHz-2483.5MHz	94.0	Average Value
	114.0	Peak Value

## 4.2 TEST SETUP

### 1. Radiated Emission Test-Up Frequency Below 30MHz

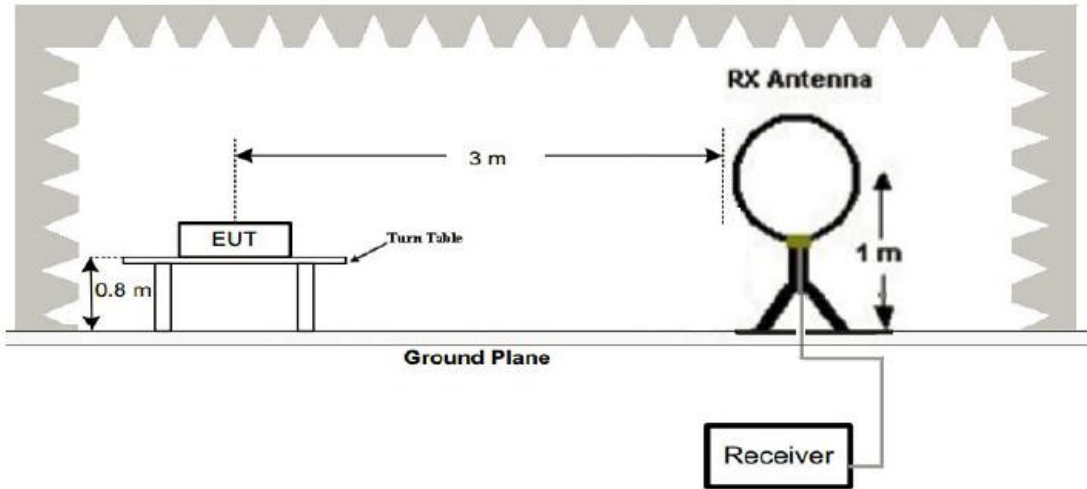

### 2. Radiated Emission Test-Up Frequency 30MHz~1GHz

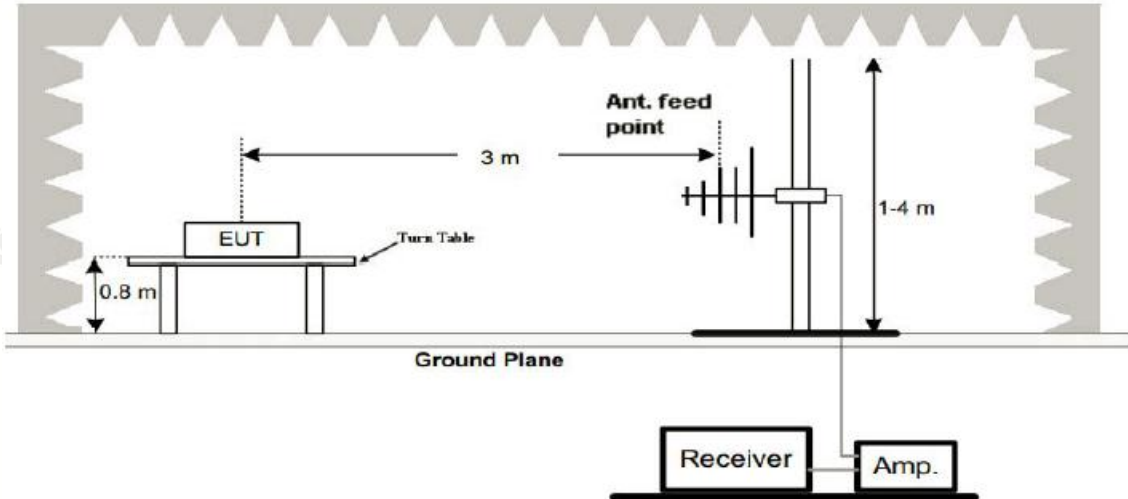

### 3. Radiated Emission Test-Up Frequency Above 1GHz

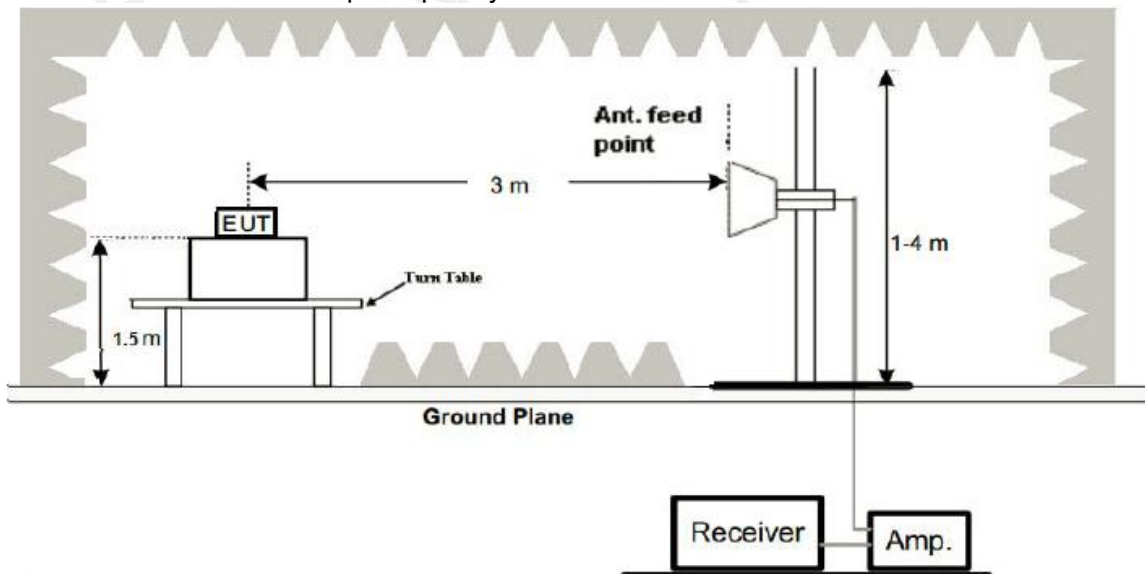

### 4.3 TEST PROCEDURE

1. Below 1GHz measurement the EUT is placed on turntable which is 0.8m above ground plane.  
And above 1GHz measurement EUT was placed on low permittivity and low tangent turn table which is 1.5m above ground plane.
2. The turntable shall be rotated for 360 degrees to determine the position of maximum emission level.
3. EUT is set 3m away from the receiving antenna, which is varied from 1m to 4m to find out the highest emissions.
4. Maximum procedure was performed on the six highest emissions to ensure EUT compliance.
5. And also, each emission was to be maximized by changing the polarization of receiving antenna both horizontal and vertical.
6. Repeat above procedures until the measurements for all frequencies are complete.
7. The test frequency range from 9kHz to 25GHz per FCC PART 15.33(a).

Note:

For battery operated equipment, the equipment tests shall be performed using a new battery.

### 4.4 TEST RESULT

#### PASS

Remark:

1. All modes were test at Low, Middle, and High channel, only the worst result of GFSK Low Channel was reported for below 1GHz test.
2. By preliminary testing and verifying three axis (X, Y and Z) position of EUT transmitted status, it was found that "X axis" position was the worst, and test data recorded in this report.
3. Radiated emission test from 9kHz to 10th harmonic of fundamental was verified, and no emission found except system noise floor in 9kHz to 30MHz and not recorded in this report.



Below 1GHz Test Results:

Temperature:	24°C	Relative Humidity:	48%
Test Date:	Mar. 02, 2022	Pressure:	1010hPa
Test Voltage:	AC 120V, 60Hz	Phase:	Horizontal
Test Mode:	Transmitting mode of GFSK 2402MHz		

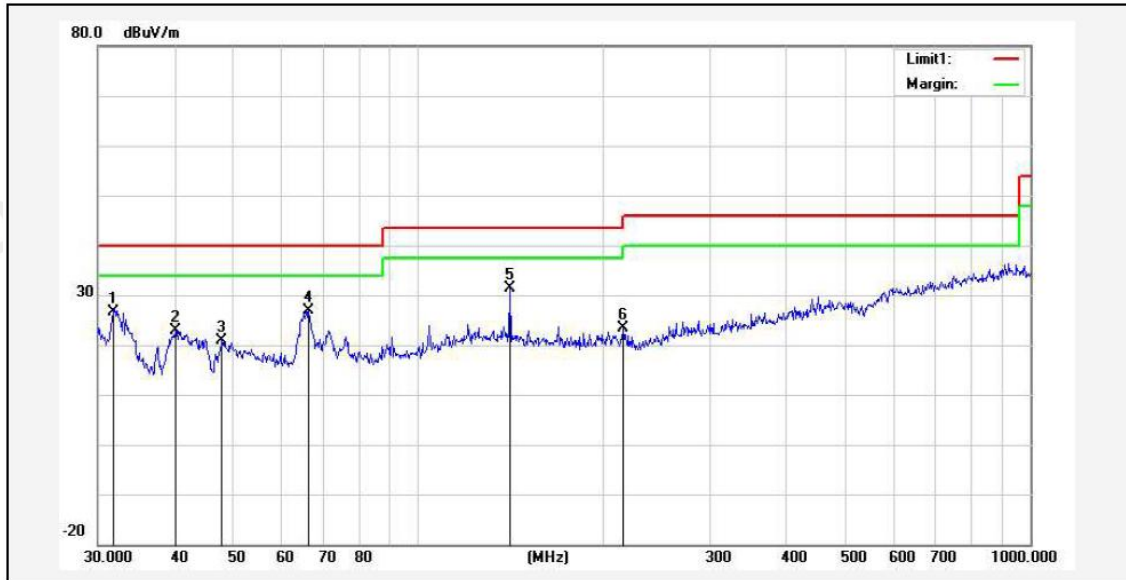

No.	Frequency (MHz)	Reading (dBuV)	Correction factor(dB/m)	Result (dBuV/m)	Limit (dBuV/m)	Margin (dB)	Degree (deg.)	Height (cm)	Remark
1	31.7313	35.07	-8.41	26.66	40.00	-13.34	50	100	peak
2	40.1347	38.06	-15.12	22.94	40.00	-17.06	80	100	peak
3	47.8260	40.23	-19.33	20.90	40.00	-19.10	100	100	peak
4	66.2662	47.90	-21.13	26.77	40.00	-13.23	120	100	peak
5*	141.3298	47.48	-16.15	31.33	43.50	-12.17	150	100	peak
6	216.0240	40.68	-17.28	23.40	46.00	-22.60	180	100	peak

Remark: Absolute Level = Reading Level + Factor, Margin = Absolute Level – Limit  
 Factor = Ant. Factor + Cable Loss – Pre-amplifier

Temperature:	24°C	Relative Humidity:	48%
Test Date:	Mar. 02, 2022	Pressure:	1010hPa
Test Voltage:	AC 120V, 60Hz	Phase:	Vertical
Test Mode:	Transmitting mode of GFSK 2402MHz		

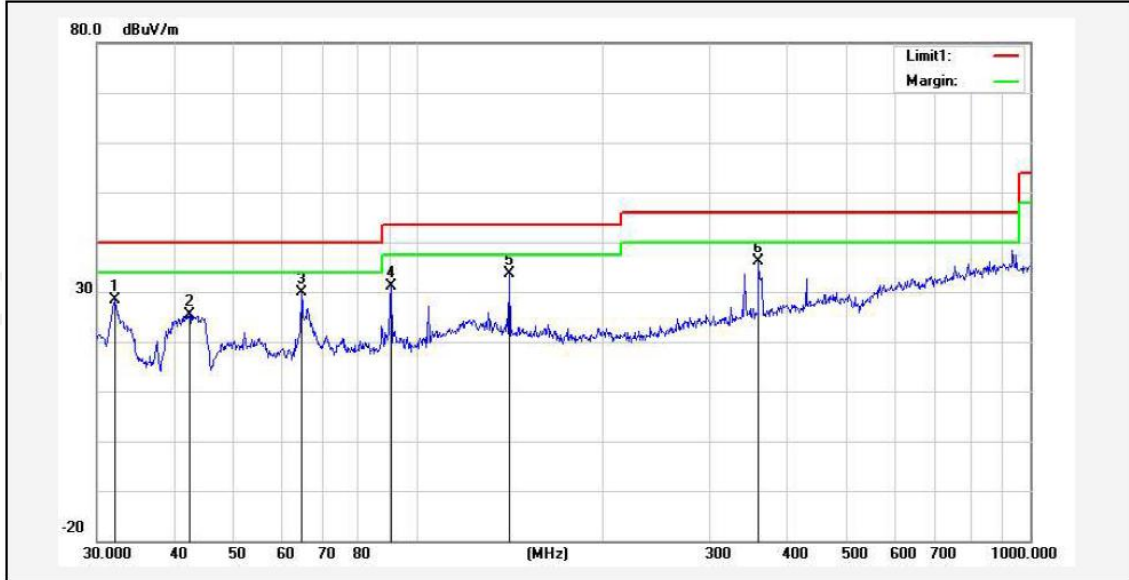

No.	Frequency (MHz)	Reading (dBuV)	Correction factor (dB/m)	Result (dBuV/m)	Limit (dBuV/m)	Margin (dB)	Degree (deg.)	Height (cm)	Remark
1	32.0667	37.09	-8.66	28.43	40.00	-11.57	80	100	peak
2	42.4508	41.97	-16.55	25.42	40.00	-14.58	120	100	peak
3	64.6594	51.27	-21.33	29.94	40.00	-10.06	150	100	peak
4	90.5374	51.91	-20.66	31.25	43.50	-12.25	160	100	peak
5	141.3298	49.84	-16.15	33.69	43.50	-9.81	180	100	peak
6*	360.4476	50.12	-13.92	36.20	46.00	-9.80	200	100	peak

Remark: Absolute Level = Reading Level + Factor, Margin = Absolute Level – Limit  
 Factor = Ant. Factor + Cable Loss – Pre-amplifier

Remark:

1. Measuring frequencies from 9 kHz to the 1 GHz, Radiated emission test from 9kHz to 30MHz was verified, and no any emission was found except system noise floor.
2. \* denotes emission frequency which appearing within the Restricted Bands specified in provision of 15.205, then the general radiated emission limits in 15.209 apply.
3. The IF bandwidth of EMI Test Receiver between 30MHz to 1GHz was 120kHz, 1 MHz for measuring above 1 GHz, below 30MHz was 10kHz.

Above 1 GHz Test Results:

GFSK Modulation:  
CH00 (2402MHz)

Horizontal:

Frequency (MHz)	Reading Result (dBμV)	Factor (dB)	Emission Level (dBμV/m)	Limits (dBμV/m)	Margin (dB)	Detector Type
2402	112.56	-5.84	106.72	114	-7.28	PK
2402	82.47	-5.84	76.63	94	-17.37	AV
4804	60.29	-3.64	56.65	74	-17.35	PK
4804	50.26	-3.64	46.62	54	-7.38	AV
7206	57.31	-0.95	56.36	74	-17.64	PK
7206	47.03	-0.95	46.08	54	-7.92	AV

Remark: Factor = Antenna Factor + Cable Loss – Pre-amplifier. Margin = Absolute Level – Limit

Vertical:

Frequency (MHz)	Reading Result (dBμV)	Factor (dB)	Emission Level (dBμV/m)	Limits (dBμV/m)	Margin (dB)	Detector Type
2402	112.64	-5.84	106.80	114	-7.20	PK
2402	82.51	-5.84	76.67	94	-17.33	AV
4804	60.36	-3.64	56.72	74	-17.28	PK
4804	50.27	-3.64	46.63	54	-7.37	AV
7206	57.26	-0.95	56.31	74	-17.69	PK
7206	47.10	-0.95	46.15	54	-7.85	AV

Remark: Factor = Antenna Factor + Cable Loss – Pre-amplifier. Margin = Absolute Level – Limit

CH39 (2441MHz)

Horizontal:

Frequency (MHz)	Reading Result (dBμV)	Factor (dB)	Emission Level (dBμV/m)	Limits (dBμV/m)	Margin (dB)	Detector Type
2441	112.35	-5.71	106.64	114	-7.36	PK
2441	82.33	-5.71	76.62	94	-17.38	AV
4882	60.07	-3.51	56.56	74	-17.44	PK
4882	50.20	-3.51	46.69	54	-7.31	AV
7323	57.22	-0.82	56.40	74	-17.60	PK
7323	46.85	-0.82	46.03	54	-7.97	AV

Remark: Factor = Antenna Factor + Cable Loss – Pre-amplifier. Margin = Absolute Level – Limit

Vertical:

Frequency (MHz)	Reading Result (dBμV)	Factor (dB)	Emission Level (dBμV/m)	Limits (dBμV/m)	Margin (dB)	Detector Type
2441	112.27	-5.71	106.56	114	-7.44	PK
2441	82.45	-5.71	76.74	94	-17.26	AV
4882	60.10	-3.51	56.59	74	-17.41	PK
4882	50.20	-3.51	46.69	54	-7.31	AV
7323	57.25	-0.82	56.43	74	-17.57	PK
7323	46.75	-0.82	45.93	54	-8.07	AV

Remark: Factor = Antenna Factor + Cable Loss – Pre-amplifier. Margin = Absolute Level – Limit

CH78 (2480MHz)

Horizontal:

Frequency (MHz)	Reading Result (dBμV)	Factor (dB)	Emission Level (dBμV/m)	Limits (dBμV/m)	Margin (dB)	Detector Type
2480	112.26	-5.65	106.61	114	-7.39	PK
2480	82.31	-5.65	76.66	94	-17.34	AV
4960	60.12	-3.43	56.69	74	-17.31	PK
4960	50.11	-3.43	46.68	54	-7.32	AV
7440	57.08	-0.75	56.33	74	-17.67	PK
7440	46.70	-0.75	45.95	54	-8.05	AV

Remark: Factor = Antenna Factor + Cable Loss – Pre-amplifier. Margin = Absolute Level – Limit

Vertical:

Frequency (MHz)	Reading Result (dBμV)	Factor (dB)	Emission Level (dBμV/m)	Limits (dBμV/m)	Margin (dB)	Detector Type
2480	112.32	-5.65	106.67	114	-7.33	PK
2480	82.25	-5.65	76.60	94	-17.40	AV
4960	60.07	-3.43	56.64	74	-17.36	PK
4960	50.09	-3.43	46.66	54	-7.34	AV
7440	57.15	-0.75	56.40	74	-17.60	PK
7440	46.69	-0.75	45.94	54	-8.06	AV

Remark: Factor = Antenna Factor + Cable Loss – Pre-amplifier. Margin = Absolute Level – Limit

$\pi/4$  DQPSK Modulation:  
CH00 (2402MHz)

Horizontal:

Frequency (MHz)	Reading Result (dB $\mu$ V)	Factor (dB)	Emission Level (dB $\mu$ V/m)	Limits (dB $\mu$ V/m)	Margin (dB)	Detector Type
2402	112.37	-5.84	106.53	114	-7.47	PK
2402	82.47	-5.84	76.63	94	-17.37	AV
4804	60.43	-3.64	56.79	74	-17.21	PK
4804	50.08	-3.64	46.44	54	-7.56	AV
7206	57.10	-0.95	56.15	74	-17.85	PK
7206	46.86	-0.95	45.91	54	-8.09	AV

Remark: Factor = Antenna Factor + Cable Loss – Pre-amplifier. Margin = Absolute Level – Limit

Vertical:

Frequency (MHz)	Reading Result (dB $\mu$ V)	Factor (dB)	Emission Level (dB $\mu$ V/m)	Limits (dB $\mu$ V/m)	Margin (dB)	Detector Type
2402	112.26	-5.84	106.42	114	-7.58	PK
2402	82.40	-5.84	76.56	94	-17.44	AV
4804	60.44	-3.64	56.80	74	-17.20	PK
4804	50.20	-3.64	46.56	54	-7.44	AV
7206	57.15	-0.95	56.20	74	-17.80	PK
7206	46.93	-0.95	45.98	54	-8.02	AV

Remark: Factor = Antenna Factor + Cable Loss – Pre-amplifier. Margin = Absolute Level – Limit

CH39 (2441MHz)

Horizontal:

Frequency (MHz)	Reading Result (dBμV)	Factor (dB)	Emission Level (dBμV/m)	Limits (dBμV/m)	Margin (dB)	Detector Type
2441	112.07	-5.71	106.36	114	-7.64	PK
2441	82.25	-5.71	76.54	94	-17.46	AV
4882	60.23	-3.51	56.72	74	-17.28	PK
4882	50.10	-3.51	46.59	54	-7.41	AV
7323	57.11	-0.82	56.29	74	-17.71	PK
7323	46.81	-0.82	45.99	54	-8.01	AV

Remark: Factor = Antenna Factor + Cable Loss – Pre-amplifier. Margin = Absolute Level – Limit

Vertical:

Frequency (MHz)	Reading Result (dBμV)	Factor (dB)	Emission Level (dBμV/m)	Limits (dBμV/m)	Margin (dB)	Detector Type
2441	112.25	-5.71	106.54	114	-7.46	PK
2441	82.26	-5.71	76.55	94	-17.45	AV
4882	60.31	-3.51	56.80	74	-17.20	PK
4882	50.06	-3.51	46.55	54	-7.45	AV
7323	57.06	-0.82	56.24	74	-17.76	PK
7323	46.73	-0.82	45.91	54	-8.09	AV

Remark: Factor = Antenna Factor + Cable Loss – Pre-amplifier. Margin = Absolute Level – Limit

CH78 (2480MHz)

Horizontal:

Frequency (MHz)	Reading Result (dBμV)	Factor (dB)	Emission Level (dBμV/m)	Limits (dBμV/m)	Margin (dB)	Detector Type
2480	112.21	-5.65	106.56	114	-7.44	PK
2480	82.23	-5.65	76.58	94	-17.42	AV
4960	60.15	-3.43	56.72	74	-17.28	PK
4960	50.07	-3.43	46.64	54	-7.36	AV
7440	57.05	-0.75	56.30	74	-17.70	PK
7440	46.75	-0.75	46.00	54	-8.00	AV

Remark: Factor = Antenna Factor + Cable Loss – Pre-amplifier. Margin = Absolute Level – Limit

Vertical:

Frequency (MHz)	Reading Result (dBμV)	Factor (dB)	Emission Level (dBμV/m)	Limits (dBμV/m)	Margin (dB)	Detector Type
2480	112.11	-5.65	106.46	114	-7.54	PK
2480	82.17	-5.65	76.52	94	-17.48	AV
4960	60.16	-3.43	56.73	74	-17.27	PK
4960	50.10	-3.43	46.67	54	-7.33	AV
7440	57.10	-0.75	56.35	74	-17.65	PK
7440	46.69	-0.75	45.94	54	-8.06	AV

Remark: Factor = Antenna Factor + Cable Loss – Pre-amplifier. Margin = Absolute Level – Limit



8DPSK Modulation:  
CH00 (2402MHz)

Horizontal:

Frequency (MHz)	Reading Result (dBμV)	Factor (dB)	Emission Level (dBμV/m)	Limits (dBμV/m)	Margin (dB)	Detector Type
2402	112.16	-5.84	106.32	114	-7.68	PK
2402	82.26	-5.84	76.42	94	-17.58	AV
4804	60.09	-3.64	56.45	74	-17.55	PK
4804	50.09	-3.64	46.45	54	-7.55	AV
7206	57.13	-0.95	56.18	74	-17.82	PK
7206	47.07	-0.95	46.12	54	-7.88	AV

Remark: Factor = Antenna Factor + Cable Loss – Pre-amplifier. Margin = Absolute Level – Limit

Vertical:

Frequency (MHz)	Reading Result (dBμV)	Factor (dB)	Emission Level (dBμV/m)	Limits (dBμV/m)	Margin (dB)	Detector Type
2402	112.12	-5.84	106.28	114	-7.72	PK
2402	82.30	-5.84	76.46	94	-17.54	AV
4804	60.16	-3.64	56.52	74	-17.48	PK
4804	50.04	-3.64	46.40	54	-7.60	AV
7206	57.17	-0.95	56.22	74	-17.78	PK
7206	46.90	-0.95	45.95	54	-8.05	AV

Remark: Factor = Antenna Factor + Cable Loss – Pre-amplifier. Margin = Absolute Level – Limit

CH39 (2441MHz)

Horizontal:

Frequency (MHz)	Reading Result (dBμV)	Factor (dB)	Emission Level (dBμV/m)	Limits (dBμV/m)	Margin (dB)	Detector Type
2441	112.05	-5.71	106.34	114	-7.66	PK
2441	82.16	-5.71	76.45	94	-17.55	AV
4882	59.93	-3.51	56.42	74	-17.58	PK
4882	49.95	-3.51	46.44	54	-7.56	AV
7323	57.12	-0.82	56.30	74	-17.70	PK
7323	46.84	-0.82	46.02	54	-7.98	AV

Remark: Factor = Antenna Factor + Cable Loss – Pre-amplifier. Margin = Absolute Level – Limit

Vertical:

Frequency (MHz)	Reading Result (dBμV)	Factor (dB)	Emission Level (dBμV/m)	Limits (dBμV/m)	Margin (dB)	Detector Type
2441	112.06	-5.71	106.35	114	-7.65	PK
2441	82.15	-5.71	76.44	94	-17.56	AV
4882	59.78	-3.51	56.27	74	-17.73	PK
4882	49.86	-3.51	46.35	54	-7.65	AV
7323	57.02	-0.82	56.20	74	-17.80	PK
7323	46.95	-0.82	46.13	54	-7.87	AV

Remark: Factor = Antenna Factor + Cable Loss – Pre-amplifier. Margin = Absolute Level – Limit

CH78 (2480MHz)

Horizontal:

Frequency (MHz)	Reading Result (dBμV)	Factor (dB)	Emission Level (dBμV/m)	Limits (dBμV/m)	Margin (dB)	Detector Type
2480	111.96	-5.65	106.31	114	-7.69	PK
2480	82.10	-5.65	76.45	94	-17.55	AV
4960	59.75	-3.43	56.32	74	-17.68	PK
4960	49.75	-3.43	46.32	54	-7.68	AV
7440	56.83	-0.75	56.08	74	-17.92	PK
7440	46.70	-0.75	45.95	54	-8.05	AV

Remark: Factor = Antenna Factor + Cable Loss – Pre-amplifier. Margin = Absolute Level – Limit

Vertical:

Frequency (MHz)	Reading Result (dBμV)	Factor (dB)	Emission Level (dBμV/m)	Limits (dBμV/m)	Margin (dB)	Detector Type
2480	112.07	-5.65	106.42	114	-7.58	PK
2480	82.07	-5.65	76.42	94	-17.58	AV
4960	59.62	-3.43	56.19	74	-17.81	PK
4960	49.66	-3.43	46.23	54	-7.77	AV
7440	56.85	-0.75	56.10	74	-17.90	PK
7440	46.75	-0.75	46.00	54	-8.00	AV

Remark: Factor = Antenna Factor + Cable Loss – Pre-amplifier. Margin = Absolute Level – Limit

Remark:

1. Measuring frequencies from 1 GHz to the 25 GHz.
2. "F" denotes fundamental frequency; "H" denotes spurious frequency. "E" denotes band edge frequency.
3. \* denotes emission frequency which appearing within the Restricted Bands specified in provision of 15.205, then the general radiated emission limits in 15.209 apply.
4. Data of measurement within this frequency range shown "---" in the table above means the reading of emissions are attenuated more than 20dB below the permissible limits or the field strength is too small to be measured.
5. The IF bandwidth of EMI Test Receiver between 30MHz to 1GHz was 120kHz, 1 MHz for measuring above 1 GHz, below 30MHz was 10kHz. The resolution bandwidth of test receiver/spectrum analyzer is 1MHz and video bandwidth is 3MHz for peak measurement with peak detector at frequency above 1GHz. The resolution bandwidth of test receiver/spectrum analyzer is 1MHz and video bandwidth is 10Hz for Average measurement with peak detection at frequency above 1GHz.
6. When the test results of Peak Detected below the limits of Average Detected, the Average Detected is not need completed. For example: Top Channel at Fundamental 73.16dBuV/m(PK Value) <93.98(AV Limit), at harmonic 53.20 dBuV/m(PK Value) <54 dBuV/m(AV Limit), the Average Detected not need to completed.
7. For fundamental frequency, RBW>20dB Bandwidth, VBW>=3\*RBW, Peak detector for PK value, RMS detector for AV value.

## 5 BAND EDGE

### 5.1 TEST LIMIT

FCC PART 15.249(d) Emissions radiated outside of the specified frequency bands, except for harmonics, shall be attenuated by at least 50 dB below the level of the fundamental or to the general radiated emission limits in §15.209, whichever is the lesser attenuation.

### 5.2 TEST PROCEDURE

The band edge compliance of RF radiated emission should be measured by following the guidance in ANSI C63.10 with respect to maximizing the emission by rotating the EUT, measuring the emission while the EUT is situated in three orthogonal planes (if appropriate), adjusting the measurement antenna height and polarization etc. Set RBW to 1MHz and VBM to 3MHz to measure the peak field strength and set RBW to 1MHz and VBW to 10Hz to measure the average radiated field strength. Peak detector is for both.

### 5.3 TEST RESULT

PASS

Remark: All modes of were tested, only the worst result of GFSK was reported.

Operation Mode: TX CH00 (2402MHz)

Horizontal:

Frequency (MHz)	Reading Result (dBμV)	Factor (dB)	Emission Level (dBμV/m)	Limits (dBμV/m)	Margin (dB)	Detector Type
2310	57.23	-5.81	51.42	74	-22.58	PK
2310	/	-5.81	/	54	/	AV
2390	57.09	-5.84	51.25	74	-22.75	PK
2390	/	-5.84	/	54	/	AV
2400	57.12	-5.84	51.28	74	-22.72	PK
2400	/	-5.84	/	54	/	AV

Remark: Factor = Antenna Factor + Cable Loss – Pre-amplifier.

Vertical:

Frequency (MHz)	Reading Result (dBμV)	Factor (dB)	Emission Level (dBμV/m)	Limits (dBμV/m)	Margin (dB)	Detector Type
2310	57.43	-5.81	51.62	74	-22.38	PK
2310	/	-5.81	/	54	/	AV
2390	57.59	-5.84	51.75	74	-22.25	PK
2390	/	-5.84	/	54	/	AV
2400	57.44	-5.84	51.60	74	-22.40	PK
2400	/	-5.84	/	54	/	AV

Remark: Factor = Antenna Factor + Cable Loss – Pre-amplifier.

Operation Mode: TX CH78 (2480MHz)

Horizontal:

Frequency (MHz)	Reading Result (dBμV)	Factor (dB)	Emission Level (dBμV/m)	Limits (dBμV/m)	Margin (dB)	Detector Type
2483.5	57.20	-5.65	51.55	74	-22.45	PK
2483.5	/	-5.65	/	54	/	AV
2500	57.39	-5.72	51.67	74	-22.33	PK
2500	/	-5.72	/	54	/	AV

Remark: Factor = Antenna Factor + Cable Loss – Pre-amplifier.

Vertical:

Frequency (MHz)	Reading Result (dBμV)	Factor (dB)	Emission Level (dBμV/m)	Limits (dBμV/m)	Margin (dB)	Detector Type
2483.5	57.10	-5.65	51.45	74	-22.55	PK
2483.5	/	-5.65	/	54	/	AV
2500	57.07	-5.72	51.35	74	-22.65	PK
2500	/	-5.72	/	54	/	AV

Remark: Factor = Antenna Factor + Cable Loss – Pre-amplifier.

## 6 OCCUPIED BANDWIDTH

### 6.1 TEST SETUP

Same as Radiated Emission Measurement.

### 6.2 TEST PROCEDURE

1. The EUT was placed on a turn table which is 0.8m above ground plane.
2. Set EUT as normal operation.
3. Based on ANSI C63.10 section 6.9.2: RBW=30kHz, VBW=100kHz, Span=3MHz.
4. The useful radiated emission from the EUT was detected by the spectrum analyzer with peak detector.

### 6.4 TEST RESULT

PASS

GFSK Modulation:

Channel	Frequency (MHz)	20dB Bandwidth (MHz)	Result
CH00	2402	1.045	PASS
CH39	2441	1.054	PASS
CH78	2480	1.047	PASS

CH00: 2402MHz

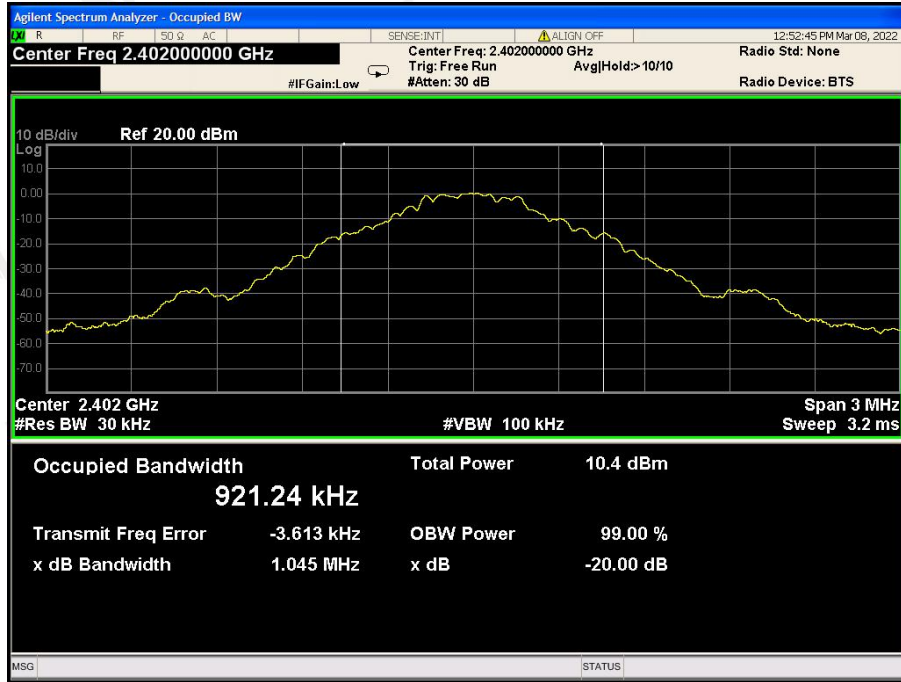



CH39: 2441MHz

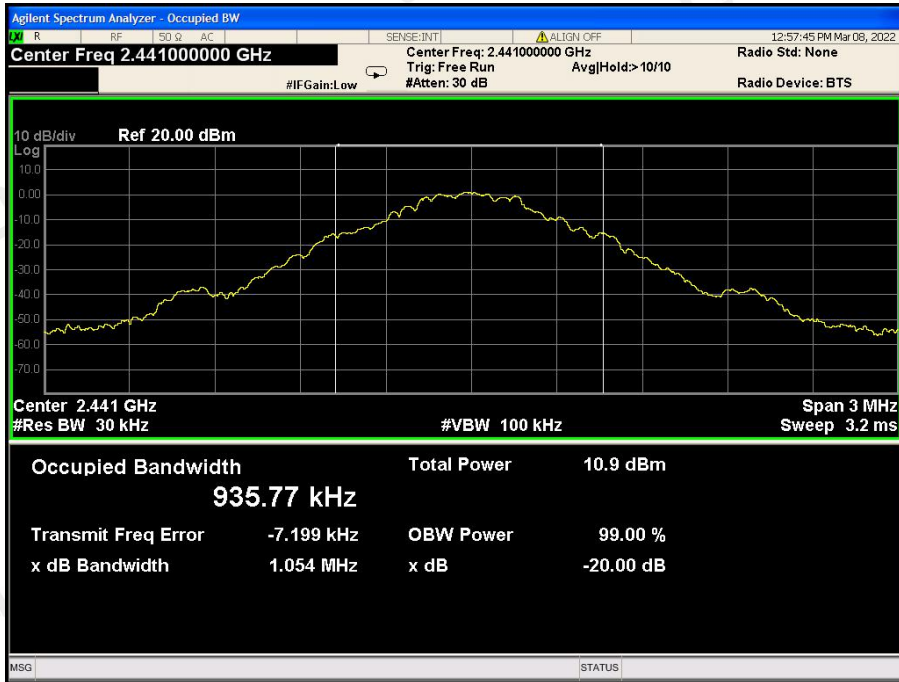

CH78: 2480MHz

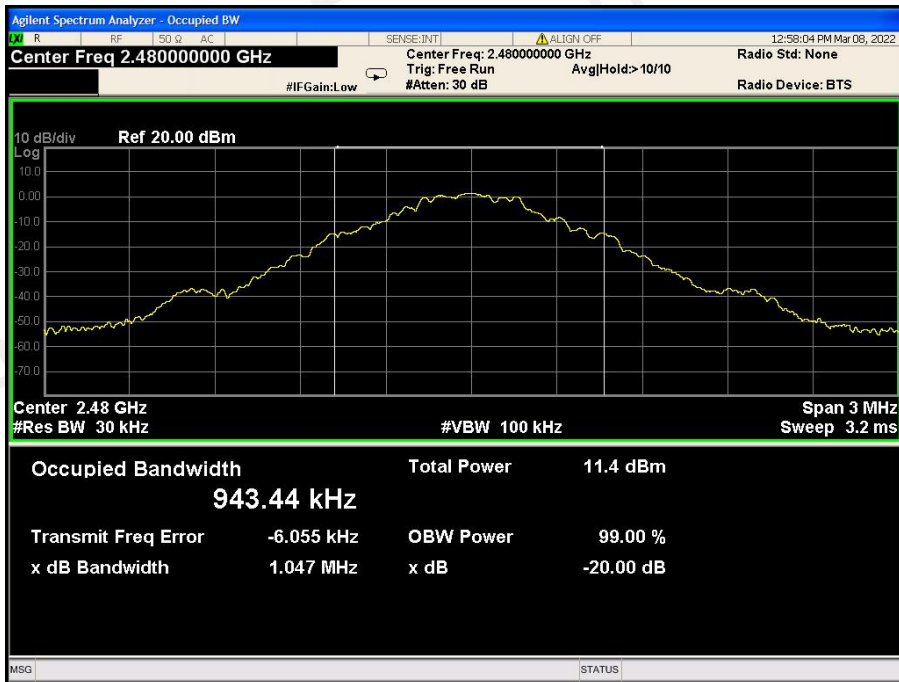

$\pi/4$  DQPSK Modulation:

Channel	Frequency (MHz)	20dB Bandwidth (MHz)	Result
CH00	2402	1.328	PASS
CH39	2441	1.332	PASS
CH78	2480	1.335	PASS

CH00: 2402MHz

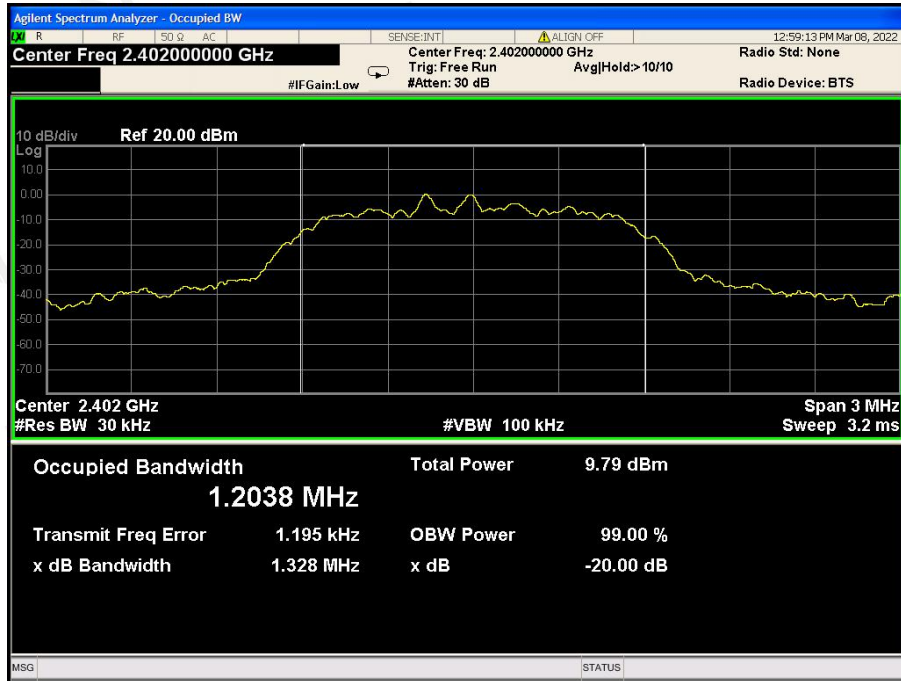

CH39: 2441MHz

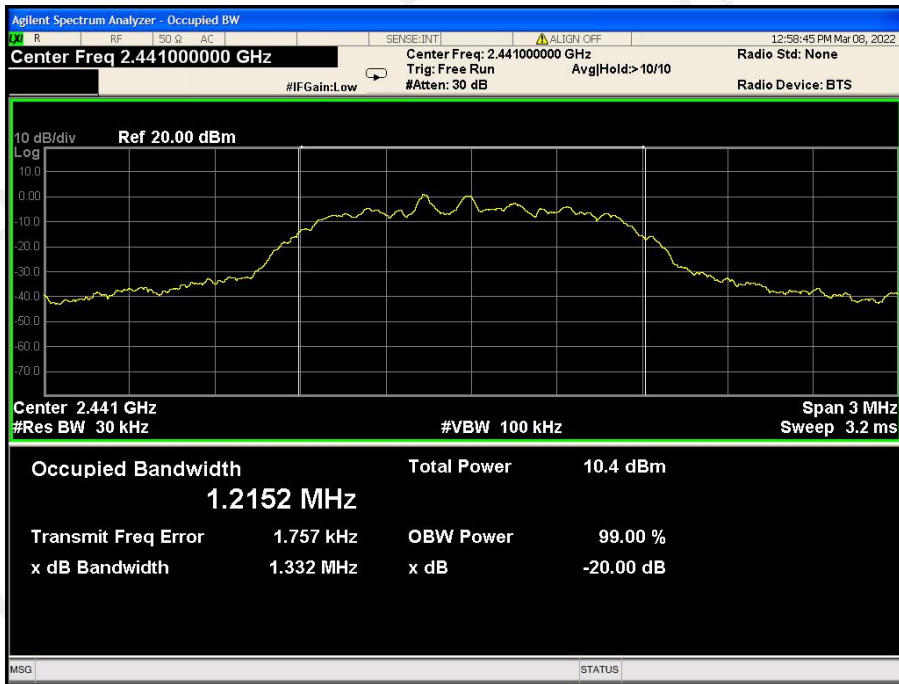

CH78: 2480MHz

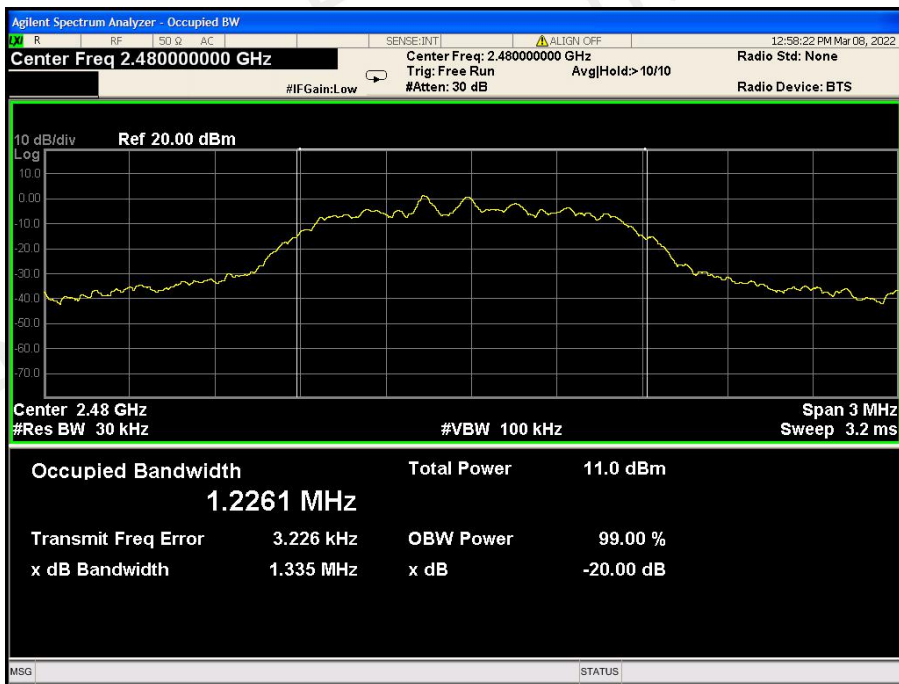

8DPSK Modulation:

Channel	Frequency (MHz)	20dB Bandwidth (MHz)	Result
CH00	2402	1.311	PASS
CH39	2441	1.302	PASS
CH78	2480	1.332	PASS

CH00: 2402MHz

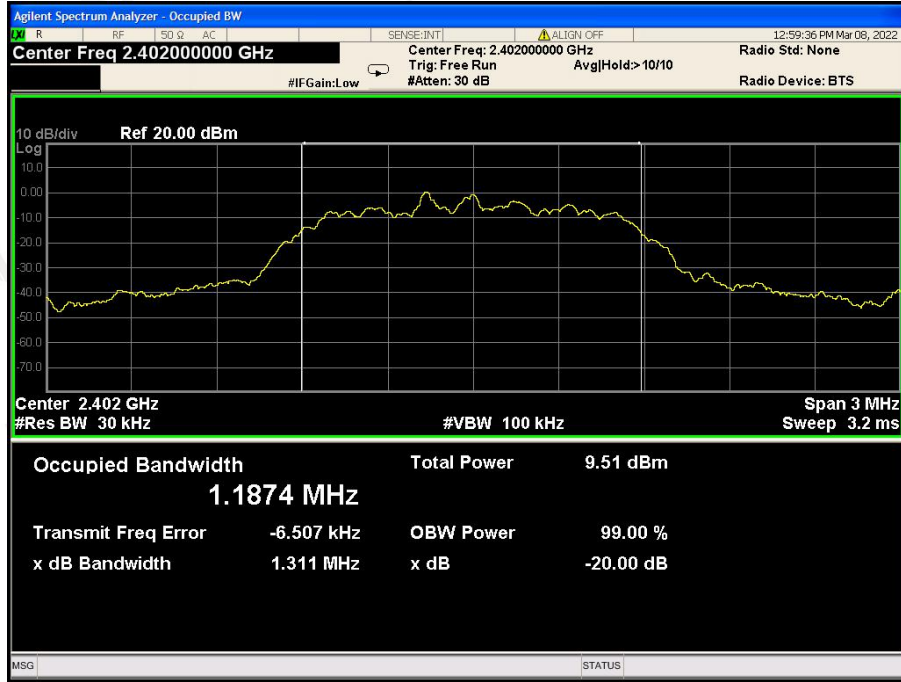

CH39: 2441MHz

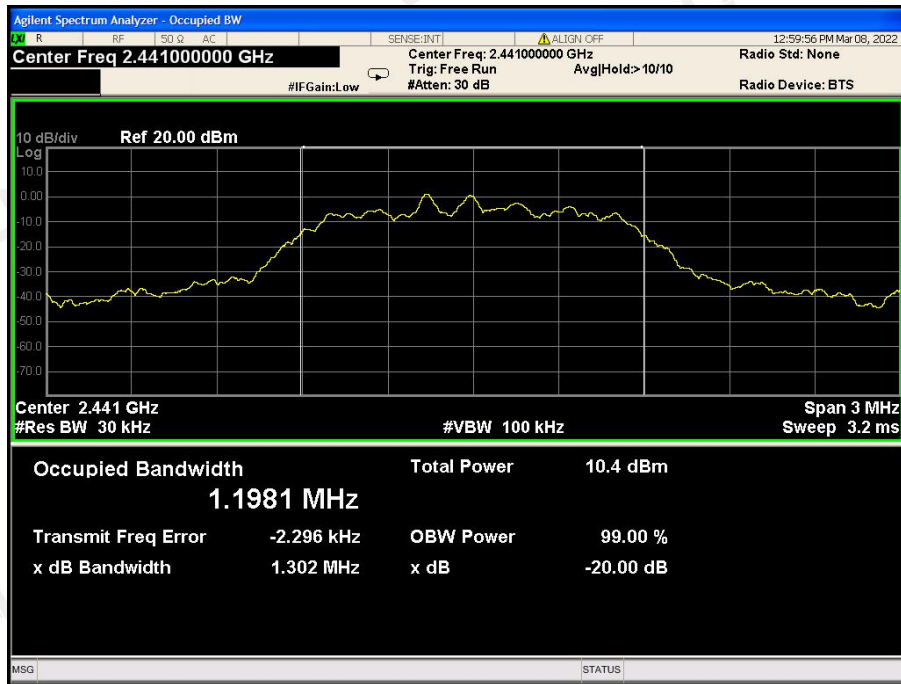

CH78: 2480MHz

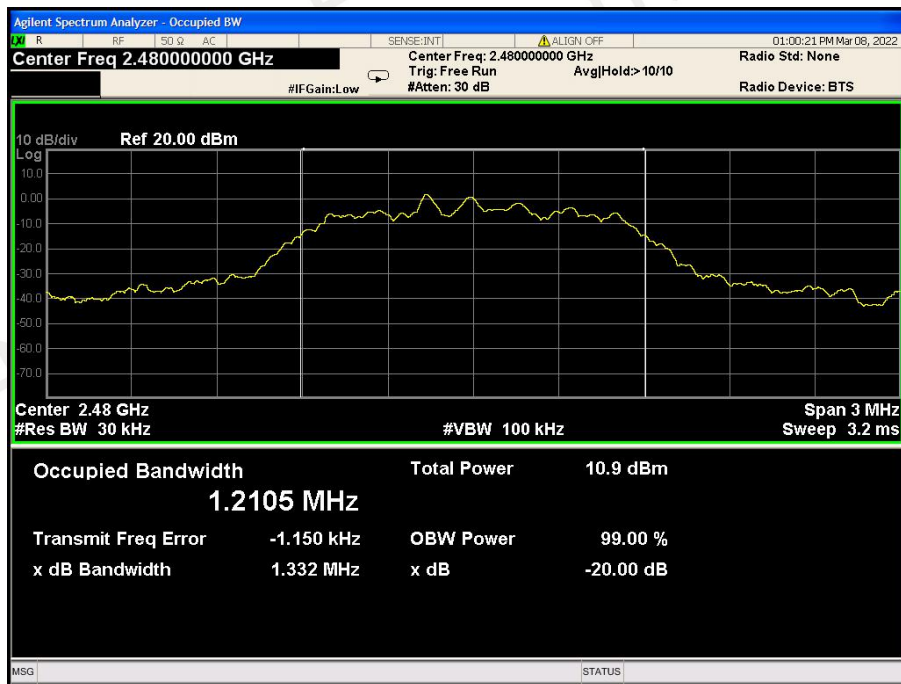

## 7 ANTENNA REQUIREMENT

### Standard Applicable:

For intentional device, according to FCC 47 CFR Section 15.203, an intentional radiator shall be designed to ensure that no antenna other than that furnished by the responsible party shall be used with the device.

### Antenna Connected Construction

The antenna used in this product is a Chip Antenna, The directional gains of antenna used for transmitting is 3.35dBi.

### ANTENNA:

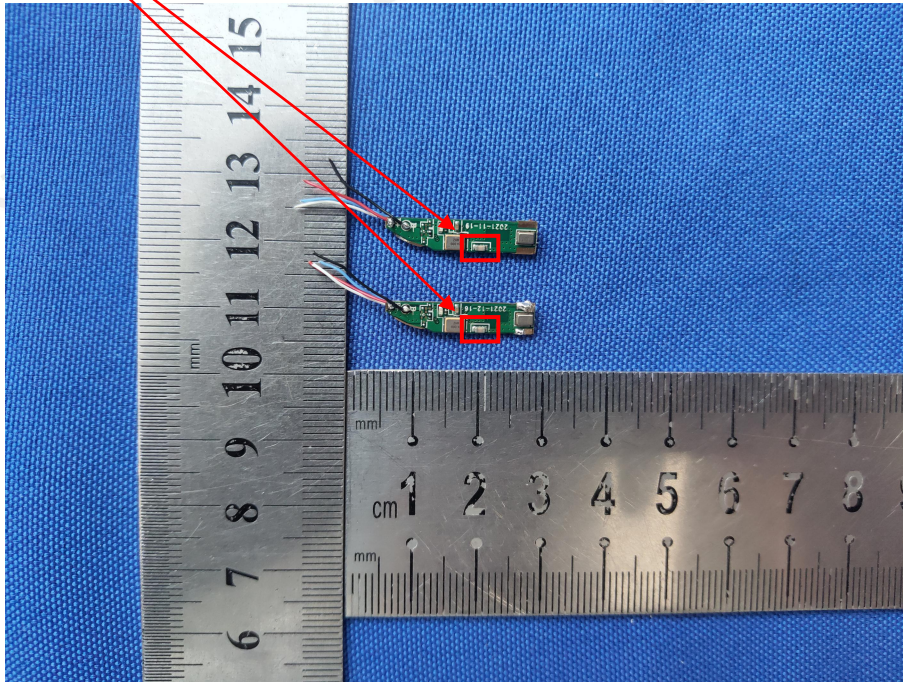

## 8 PHOTO OF TEST

### 8.1 RADIATED EMISSION

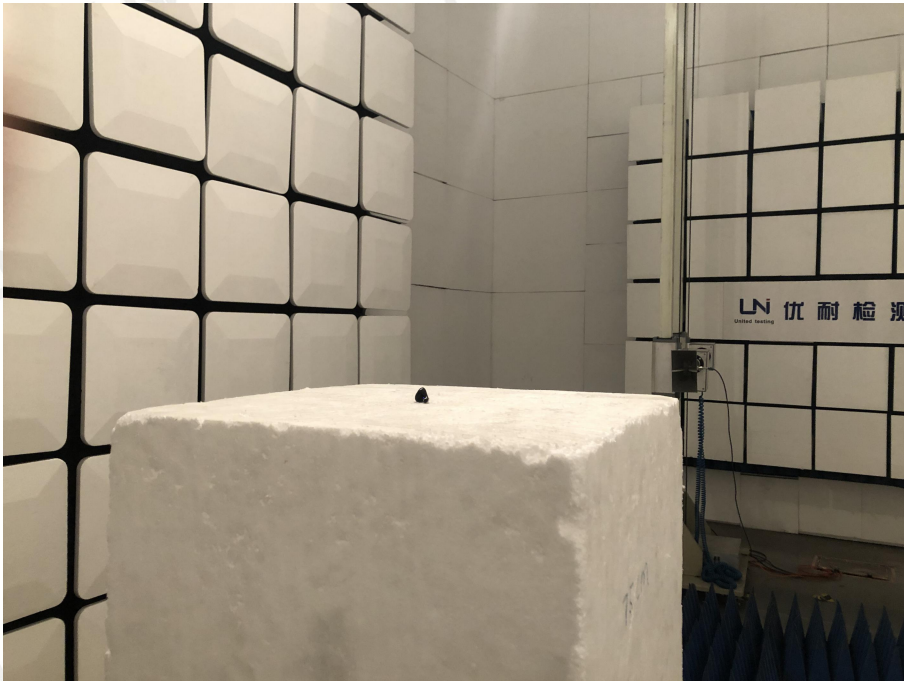

## 8.2 CONDUCTED EMISSION



\*\*\*End of Report\*\*\*