

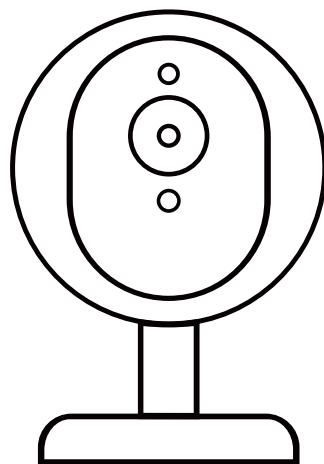

WUUK Wired Cam Pro (4MP)

User Guide



English	02
Deutsch	19
Español	33
Français	47
Italiano	61

TABLE OF CONTENTS

WHAT'S INCLUDED	03
PRODUCT OVERVIEW	04
SETTING UP THE SYSTEM	05
MOUNTING THE WIRED CAM PRO	06
POWER ON THE WUUK WIRED CAM	11
UNDERSTAND THE INDICATOR LIGHT	12
LOCAL STORAGE CARD REQUIREMENT	13
CUSTOMER SERVICE	15
SAFETY STATEMENT	16

WHAT'S INCLUDED

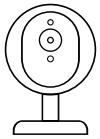

Wired
Cam Pro

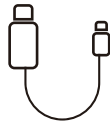

Type-C
USB Cable



USB
Power Adapter

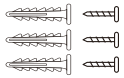

Mounting
Screw Pack



User
Manual

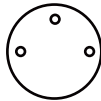

Mounting
Plate

**Please note: for all the WUUK Wired Cam products, no battery is included. Wires or power cords are required to power the device and need to be plugged in all time when in use.*

PRODUCT OVERVIEW

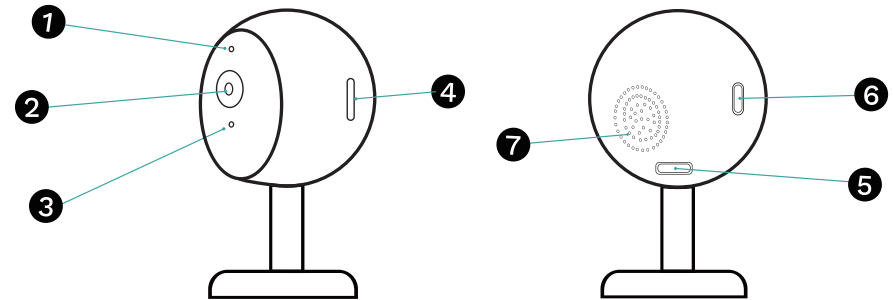

- 1 Indicator light
- 2 Camera lens
- 3 Microphone
- 4 SD card slot

- 5 Power port
- 6 SYNC button
- 7 Speaker

SETTING UP THE SYSTEM

Download the WUUK app from the App Store (iOS devices) or Google Play Store (Android devices).

Register an account if there is no existing account.

Go to the app homepage. Tap Add Device, and add the WUUK Wired Cam Pro to your WUUK app.

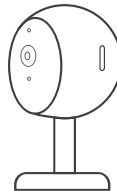

Follow the on-screen instructions to complete the setup.

MOUNTING THE WIRED CAM PRO

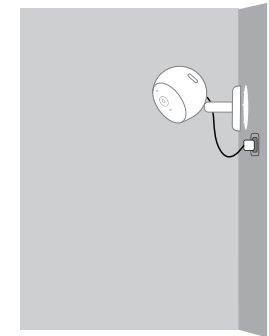
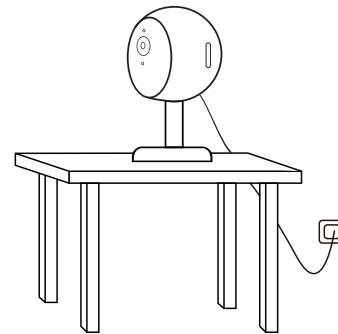

The camera can be placed on a table, shelf, or can be mounted on a wall or ceiling. Select a location and height where you can get the desired view via the WUUK app.

A 2-meter long power cord is included in the original package, so the desired location needs to be able to reach a power outlet within the reach of the power cord.

Find a Good Mounting Spot

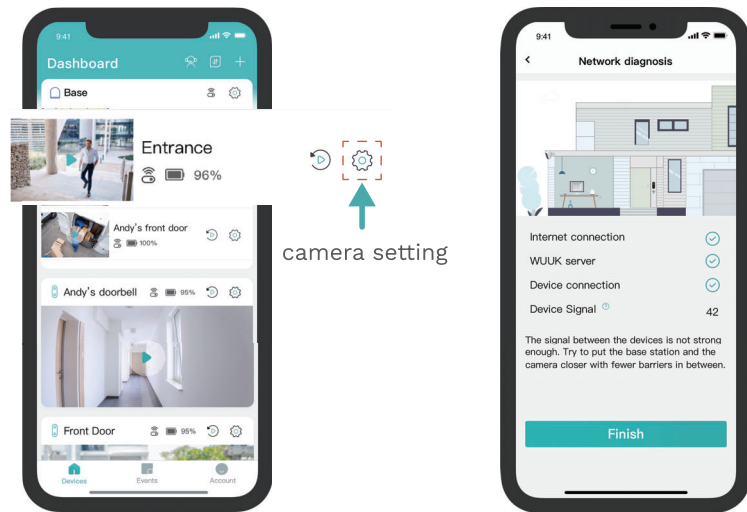

Use the “Network Diagnosis” function in the WUUK app to test the WiFi signal strength of the WUUK Wired Cam at the location you plan to place or mount the camera.

Understand the Network Diagnosis Result

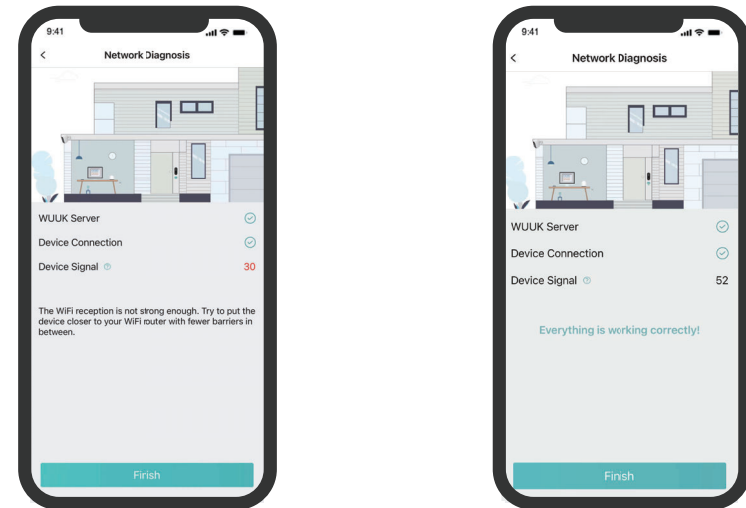

If the signal between the devices is not strong enough, please try to change the location of the camera until you find a spot that the camera has a good signal testing result in the app.

Mount the WUUK Wired Cam

If you need to mount your WUUK Wired Cam, after you mark the location using the locating sticker and find the desired view, please disconnect the WUUK Wired Cam from the power outlet before mounting.

Keep the WUUK Wired Cam at least 0.7 ft / 20 cm away from walls or anything that may obstruct the view.

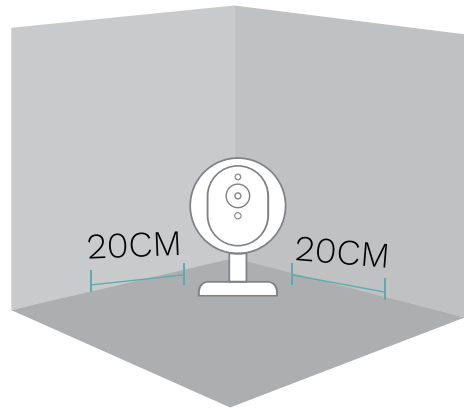

Avoid infrared reflection, which can have a negative impact on the camera's night vision performance.

To mount the WUUK Wired Cam on the ceiling, follow the steps below:

Place the locating sticker against the ceiling and then mark the screw position at which drilling will be required.

Drill holes with a 6mm drill bit.

Align the holes on the mounting plate with those in the ceiling. Insert the anchors into the holes; anchors are necessary for walls that are made out of hard materials such as concrete, brick, or stucco. Fix the screws to fasten the mounting plate to the ceiling.

Align the mounting slot with the mounting plate, and then push the camera down until it clicks into place.

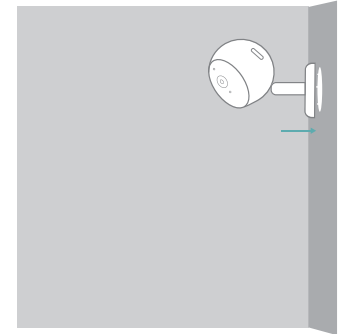

POWER ON THE WUUK WIRED CAM

Connect the WUUK Wired Cam to a power outlet using the provided USB cable and USB power adapter. If the power cable is connected correctly, the camera will be powered on without any further operations.





After being powered on, the WUUK Wired Cam will automatically connect to the system if the pairing process is done in the previous steps. If not, please refer to step: SETTING UP THE SYSTEM in the manual.

When it is successfully connected, the indicator light will turn SOLID BLUE ●.

Tap the Live View feature in the WUUK app to check if the view is desired, adjust the WUUK Wired Cam if needed.

You are now all set to use your WUUK Wired Cam.

UNDERSTAND THE INDICATOR LIGHT

	Solid Blue: Power on and working properly
	Solid Red: System is initializing or rebooting
	Flashing Blue: Disconnected from the Internet
	Flashing Red: Pairing Mode, Ready for setup
	Flashing blue and red alternately: Firmware upgrade in progress

LOCAL STORAGE CARD REQUIREMENT

You can choose between cloud storage or leverage the local storage option by installing a SD card in its SD slot. WUUK Wired Cam product series can take micro SD card to the maximum size of 256GB, FAT32 format, and it has to be Class 10. We recommend formatting the SD card before the first time of using on the WUUK Wired Cam.

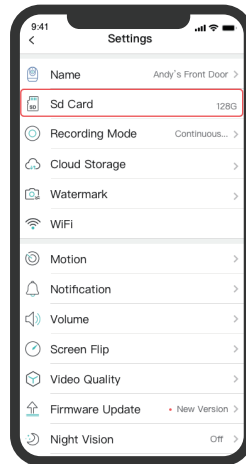

WUUK app users can access SD card formatting tool in the WUUK app after inserting a card of the right size and hearing a click sound.

Subscription for cloud storage is optional, and needs to be purchased separately on WUUK Labs' website. You can check your subscription plans in the WUUK app.

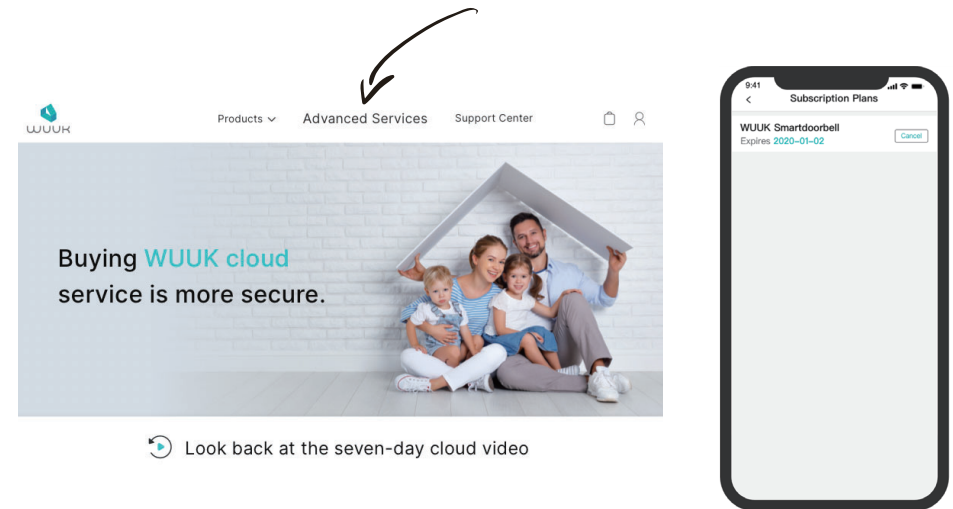

CUSTOMER SERVICE

For troubleshooting, check the WUUK app > Account > Help Center for more reference and live chat with Customer Support agents if needed.

Warranty: 12-month Limited Warranty

Call Us: United States +1 (415) 881-5715

Email Us: hello@wuuklabs.com

WUUK Labs Corp. All rights reserved.

WUUK and WUUK Logo are trademarks of WUUK Labs Corp., registered in the United States and other countries. All other trademarks are the property of their respective owners.

SAFETY STATEMENT

FCC Statement

This equipment has been tested and found to comply with the limits for a Class B digital device, to Part 15 of the FCC Rules. These limits are designed to provide reasonable protection against harmful interference in a residential installation. Operation is subject to the following two conditions:

<1> This device may not cause harmful interference, and

<2> This device must accept any interference received, including interference that may cause undesired operation.

Warning: Changes or modifications not expressly approved by the party responsible for compliance could void the user's authority to operate the equipment.

This equipment generates uses and can radiate radio frequency energy and, if not installed and used in accordance with the instructions, may cause harmful interference to radio

communications. However, there is no guarantee that interference will not occur in a particular installation. If this equipment does cause harmful interference to radio or television reception, which can be determined by turning the equipment off and on, the user is encouraged to try to correct the interference by one or more of the following measures:

- **Reorient or relocate the receiving antenna.**
- **Increase the separation between the equipment and receiver.**
- **Connect the equipment into an outlet on a circuit different from that to which the receiver is connected.**
- **Consult dealer or an experienced radio/TV technician for help.**

Declaration of Conformity

- **When charging, please place the device in an environment that has a normal room temperature and good ventilation.**
- **It is recommended to charge the device in an environment with a temperature that ranges from 5°C~25°C.**
- **Please ensure to use only the charger offered by the manufacturer. Using unauthorized charger may cause danger and violate the authorization of the device and the guarantee article.**
- **This charger is for indoor use only.**

RF Statement

When using the product, maintain a distance of 20cm from the body to ensure compliance with RF exposure requirements.

INHALTS- VERZEICHNIS

WAS IST INBEGRIFFEN	20
PRODUKTÜBERSICHT	21
EINRICHTEN DES SYSTEMS	22
MONTAGE DER WIRED CAM PRO	23
POWER ON THE WUUK WIRED CAM	28
VERSTEHEN SIE DIE KONTROLLLEUCHE	29
LOKALE SPEICHERKARTENANFORDERUNG	30
KUNDENDIENST	32

WAS IST INBEGRIFFEN

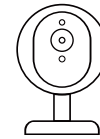

Wired
Cam Pro

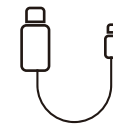

USB-Typ-
C-Kabel

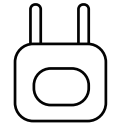

Adaptateur
Secteur USB

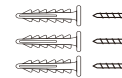

Befestigungsschraubenpaket



Benutzerhandbuch

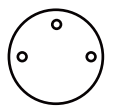

Montageplatte

**Bitte beachten Sie: für alle WUUK Wired Cam Produkte, keine Batterie ist enthalten. Kabel oder Netzkabel sind erforderlich, um das Gerät mit Strom zu versorgen, und müssen bei Gebrauch immer eingesteckt sein.*

PRODUKTÜBERSICHT

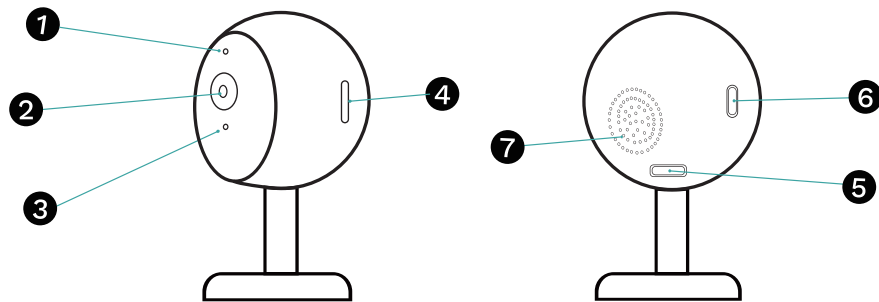

- ① Kontrollleuchte
- ② Kameraobjektiv
- ③ Mikrofon
- ④ SD-Kartensteckplatz

- ⑤ Stromanschluss
- ⑥ SYNC-Taste
- ⑦ Lautsprecher

EINRICHTEN DES SYSTEMS

Laden Sie die WUUK-App aus dem App Store (iOS-Geräte) oder Google Play Store (Android-Geräte) herunter.

Registrieren Sie ein Konto, falls noch kein Konto vorhanden ist.

Gehen Sie zur App-Homepage. Klopfen Gerät Hinzufügen und füge die hinzu WUUK Wired Cam Pro zu Ihrer WUUK-App.

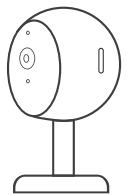

Befolgen Sie die Anweisungen auf dem Bildschirm, um die Einrichtung abzuschließen.

MONTAGE DER WIRED CAM PRO

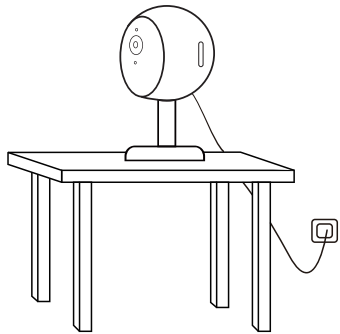

Die Kamera kann auf einen Tisch, ein Regal gestellt oder an einer Wand oder Decke montiert werden. Wählen Sie einen Ort und eine Höhe, wo Sie die gewünschte Ansicht über die WUUK-App erhalten können.

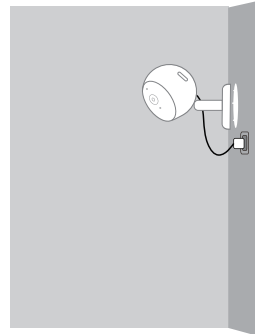

Ein 2 Meter langes Netzkabel ist in der Originalverpackung enthalten, daher muss der gewünschte Standort eine Steckdose in Reichweite des Netzkabels erreichen können.

Finden Sie einen Guten Montageort

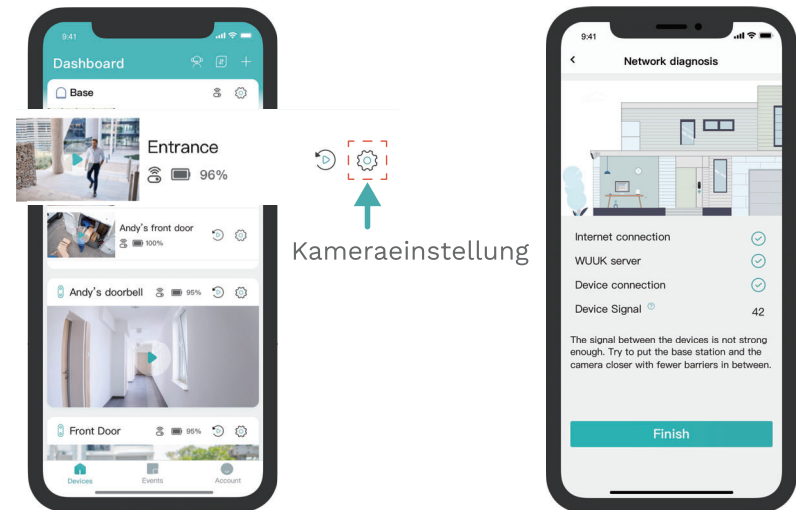

Verwenden Sie das "Netzwerkdiagnose" Funktion in der WUUK-App, um die WLAN-Signalstärke des zu testen WUUK Wired Cam an dem Ort, an dem Sie die Kamera platzieren oder montieren möchten.

Verstehen Sie das Ergebnis der Netzwerkdiagnose

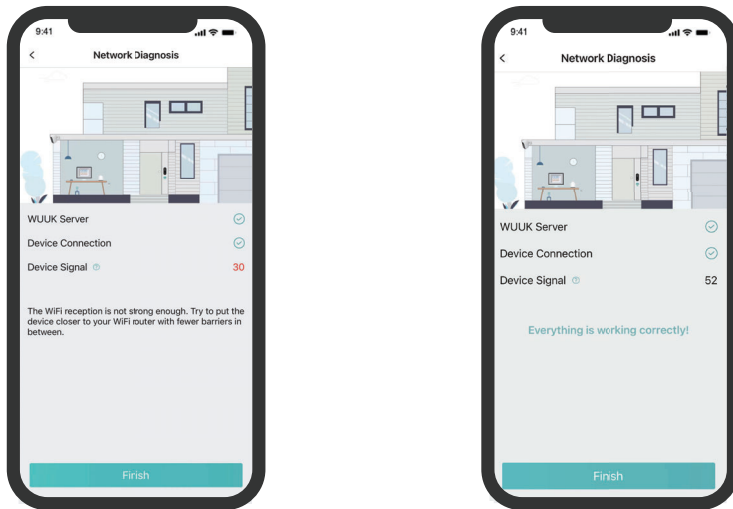

Wenn das Signal zwischen den Geräten nicht stark genug ist, versuchen Sie bitte, den Standort der Kamera zu ändern, bis Sie eine Stelle finden, an der die Kamera ein gutes Signaltestergebnis in der App hat.

Montieren Sie die WUUK Wired Cam

Wenn Sie Ihre WUUK Wired Cam montieren müssen, nachdem Sie die Stelle mit dem Ortungsaufkleber markiert und die gewünschte Ansicht gefunden haben, trennen Sie bitte die WUUK Wired Cam vor der Montage von der Steckdose.

Halten Sie die WUUK Wired Cam mindestens 20 cm von Wänden oder anderen Gegenständen entfernt, die die Sicht behindern könnten.

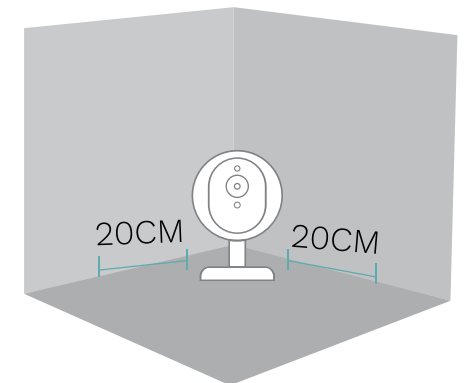

Vermeiden Sie Infrarotreflexionen, die sich negativ auf die Nachtsichtleistung der Kamera auswirken können.

Um die WUUK Wired Cam an der Decke zu montieren, gehen Sie wie folgt vor:

Bringen Sie den Positionierungsaufkleber an der Decke an und markieren Sie dann die Schraubenposition, an der gebohrt werden muss.

Löcher mit einem 6mm Bohrer bohren.

Richten Sie die Löcher auf der Montageplatte mit denen in der Decke aus. Setzen Sie die Anker in die Löcher ein; Dübel sind für Wände aus harten Materialien wie Beton, Ziegel oder Stuck erforderlich. Befestigen Sie die Schrauben, um die Montageplatte an der Decke zu befestigen.

Richten Sie den Montageschlitz an der Montageplatte aus und drücken Sie dann die Kamera nach unten, bis sie einrastet.

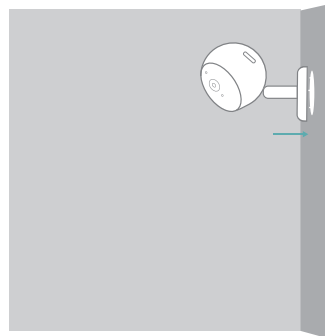

POWER ON THE WUUK WIRED CAM

Schließen Sie die WUUK Wired Cam mit dem mitgelieferten USB-Kabel und USB-Netzteil an eine Steckdose an. Wenn das Netzkabel richtig angeschlossen ist, wird die Kamera ohne weitere Vorgänge eingeschaltet.

Nach dem Einschalten verbindet sich die WUUK Wired Cam automatisch mit dem System, wenn der Pairing-Vorgang in den vorherigen Schritten durchgeführt wurde. Wenn nicht, siehe Schritt: EINRICHTEN DES SYSTEMS im Handbuch.

Wenn die Verbindung erfolgreich hergestellt wurde, leuchtet die Kontrollleuchte DAUERHAFT BLAU●.

Tippen Sie auf die Funktion Live View in der WUUK-App, um zu prüfen, ob die Ansicht gewünscht ist, und passen Sie die WUUK Wired Cam bei Bedarf an.

Sie können jetzt Ihre WUUK Wired Cam verwenden.

VERSTEHEN SIE DIE KONTROLLLEUCHE

●	Dauerhaft Blau: Eingeschaltet und funktioniert ordnungsgemäß
●	Dauerhaft Rot: Das System wird initialisiert oder neu gestartet
●	Blau Blinkend: Vom Internet getrennt
●	Rot Blinkend: Kopplungsmodus, bereit für die Einrichtung
● ●	Blinkt Abwechselnd blau und rot: Firmware-Aktualisierung läuft

LOKALE SPEICHERKARTENANFORDERUNG

Sie können zwischen Cloud-Speicher wählen oder die lokale Speicheroption nutzen, indem Sie eine SD-Karte in ihren SD-Steckplatz installieren. Die WUUK Wired Cam-Produktserie kann Micro-SD-Karten mit einer maximalen Größe von 256 GB im FAT32-Format aufnehmen und muss Klasse 10 sein. Wir empfehlen, die SD-Karte vor der ersten Verwendung mit der WUUK Wired Cam zu formatieren.

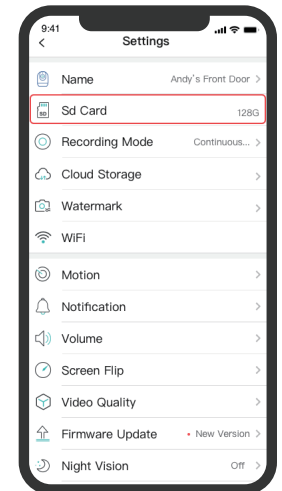

Benutzer der WUUK-App können auf das Formatierungstool für SD-Karten in der WUUK-App zugreifen, nachdem sie eine Karte in der richtigen Größe eingelegt und ein Klickgeräusch gehört haben.

Das Abonnement für Cloud-Speicher ist optional und muss separat auf der Website von WUUK Labs erworben werden. Sie können Ihre Abonnementpläne in der WUUK-App überprüfen.

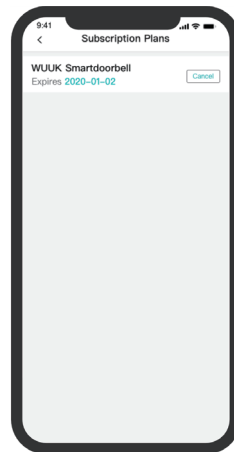
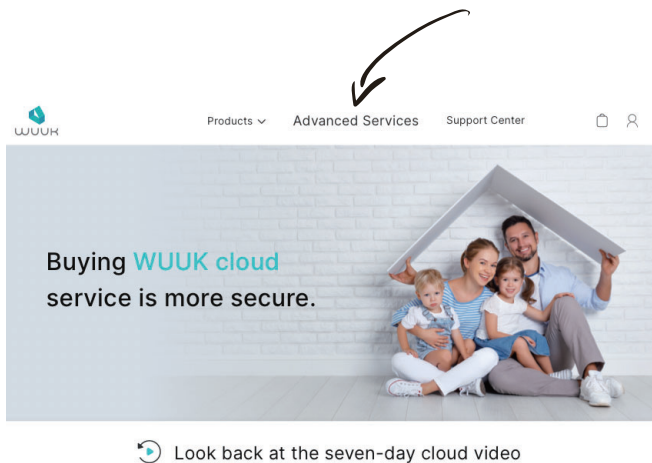

KUNDENDIENST

Weitere Informationen zur Fehlerbehebung finden Sie in der WUUK-App > Konto > Hilfezentrum und bei Bedarf im Live-Chat mit Kundendienstmitarbeitern.

Garantie: 12 Monate eingeschränkte Garantie

Senden Sie uns eine E-Mail: hello@wuuklabs.com

WUUK Labs Corp. Alle Rechte vorbehalten.

WUUK und das WUUK-Logo sind Marken von WUUK Labs Corp., eingetragen in den Vereinigten Staaten und anderen Ländern. Alle anderen Warenzeichen sind Eigentum ihrer jeweiligen Inhaber.

TABLA DE CONTENIDOS

QUÉ ESTÁ INCLUIDO	34
DESCRIPCIÓN DEL PRODUCTO	35
CONFIGURACIÓN DEL SISTEMA	36
INSTALACIÓN DE CAM PRO CABLEADO	37
POWER ON THE WUUK WIRED CAM	42
ENTIENDA LA LUZ INDICADORA	43
REQUISITO DE TARJETA DE ALMACENAMIENTO LOCAL	44
SERVICIO AL CLIENTE	46

QUÉ ESTÁ INCLUIDO

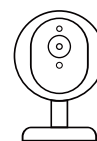

Cam
pro Wired

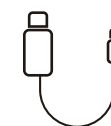

Cable USB
Tipo C



Adaptador de
Corriente USB

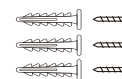

Paquete de
Tornillos de Montaje



Manual de
Usuario

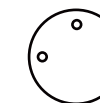

Placa de
Montaje

**Nota: Para todos los productos WUUK Wired Cam, la batería no está incluida. Se requieren cables o cables de alimentación para alimentar el dispositivo y siempre deben estar conectados durante el uso.*

DESCRIPCIÓN DEL PRODUCTO

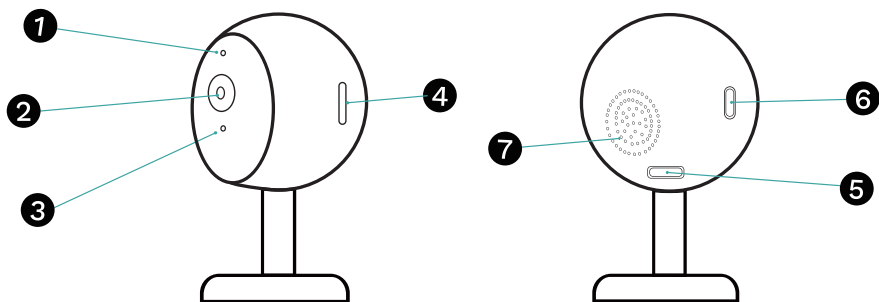

- 1 Luz indicadora
- 2 Lente de la cámara
- 3 Micrófono
- 4 Ranura por tarjeta SD

- 5 Puerto de alimentación
- 6 Botón SYNC
- 7 Altavoz

CONFIGURACIÓN DEL SISTEMA

Descargue la aplicación WUUK de App Store (dispositivos iOS) o Google Play Store (dispositivos Android).

Registre una cuenta si no hay una cuenta existente.

Vaya a la página de inicio de la aplicación. Tocar Añadir Dispositivo y agregue Wuk Wired Camera Pro a su aplicación WUUK.

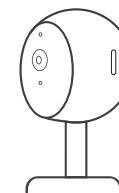

Siga las instrucciones en pantalla para completar la configuración

INSTALACIÓN DE CAM PRO CABLEADO

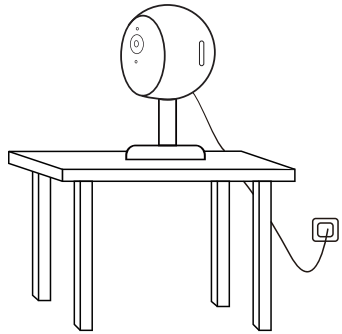

La cámara se puede colocar sobre una mesa, un estante o se puede montar en una pared o techo. Seleccione una ubicación y altura donde pueda obtener la vista deseada a través de la aplicación WUUK.

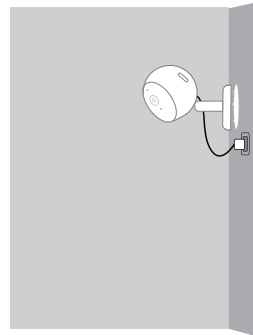

Se incluye un cable de alimentación de 2 metros de largo en el paquete original, por lo que la ubicación deseada debe poder alcanzar una toma de corriente al alcance del cable de alimentación.

Encuentre un Buen Lugar de Montaje

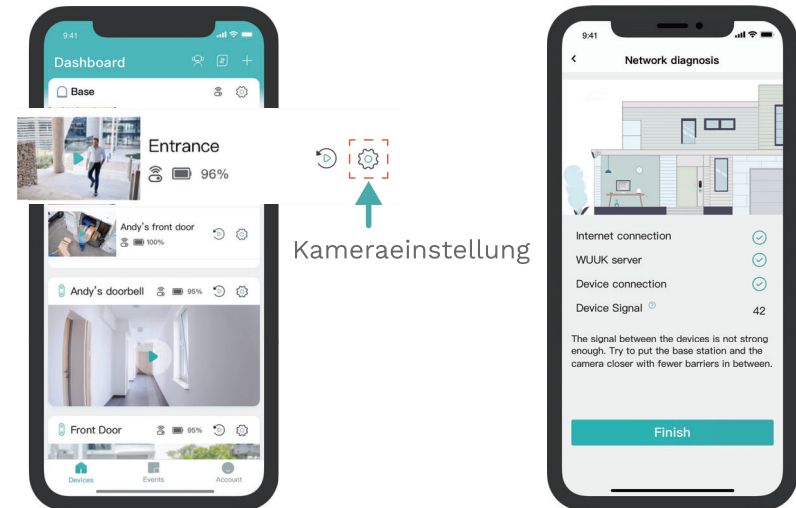

Use la función "Network Diagnosis" en la aplicación WUUK para probar la intensidad de la señal WiFi de la WUUK Wired Cam en la ubicación en la que planea colocar o montar la cámara.

Comprender el resultado del Diagnóstico de Red

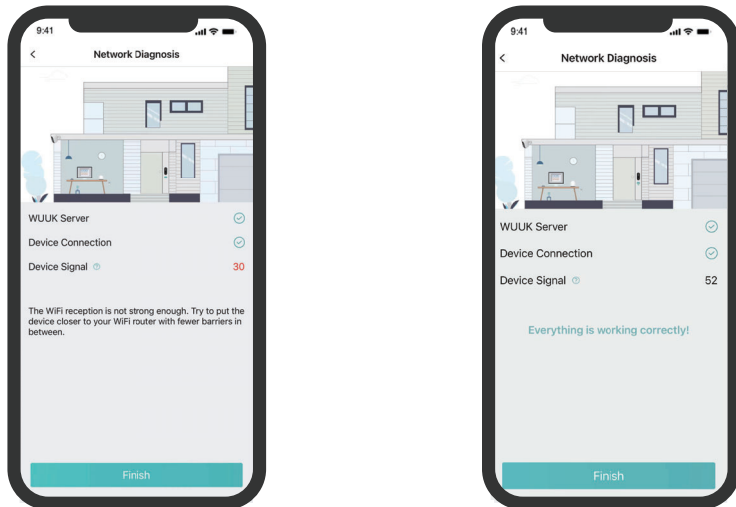

Si la señal entre los dispositivos no es lo suficientemente fuerte, intente cambiar la ubicación de la cámara hasta que encuentre un lugar en el que la cámara tenga un buen resultado de prueba de señal en la aplicación.

montar el WUUK Wired Cam

Si necesita montar su WUUK Wired Cam, después de marcar la ubicación con la etiqueta de ubicación y encontrar la vista deseada, desconecte la WUUK Wired Cam de la toma de corriente antes de montarla.

Mantenga la WUUK Wired Cam a una distancia mínima de 0,7 pies / 20 cm de las paredes o cualquier cosa que pueda obstruir la vista.

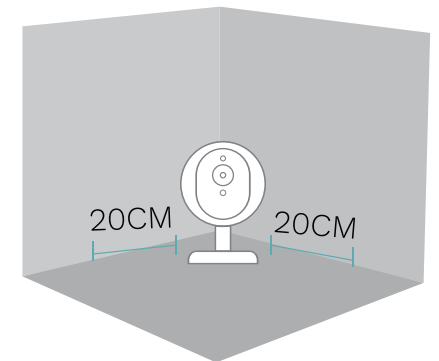

Evite el reflejo infrarrojo, que puede tener un impacto negativo en el rendimiento de la visión nocturna de la cámara.

Para montar la WUUK Wired Cam en el techo, siga los pasos a continuación:

Coloque la etiqueta adhesiva de ubicación contra el techo y luego marque la posición del tornillo en la que será necesario taladrar.

Taladre agujeros con una broca de 6mm.

Alinee los orificios de la placa de montaje con los del techo. Inserte los anclajes en los orificios; los anclajes son necesarios para paredes hechas de materiales duros como hormigón, ladrillo o estuco. Fije los tornillos para sujetar la placa de montaje al techo

Alinee la ranura de montaje con la placa de montaje y luego empuje la cámara hacia abajo hasta que encaje en su lugar.

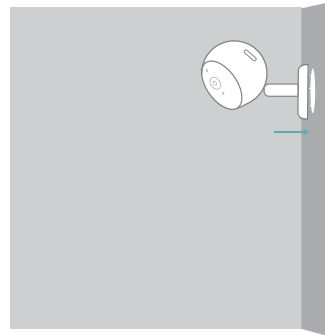

POWER ON THE WUUK WIRED CAM

Conecte la WUUK Wired Cam a una toma de corriente con el cable USB y el adaptador de corriente USB proporcionados. Si el cable de alimentación está conectado correctamente, la cámara se encenderá sin necesidad de realizar más operaciones.





Después de encenderse, la WUUK Wired Cam se conectará automáticamente al sistema si el proceso de emparejamiento se realizó en los pasos anteriores. De lo contrario, consulte el paso: CONFIGURACIÓN DEL SISTEMA en el manual

Cuando esté correctamente conectado, la luz indicadora se volverá AZUL SOLIDO ●.

Toque la función Live View en la aplicación WUUK para verificar si desea la vista, ajuste la WUUK Wired Cam si es necesario.

Ya está todo listo para usar su WUUK Wired Cam.

ENTIENDA LA LUZ INDICADORA

	Solid Blue: Power on and working properly
	Rojo Sólido: El sistema se está inicializando o reiniciando
	Azul Intermitente: Desconectado de Internet
	Rojo Intermitente: Modo de emparejamiento, listo para configurar
	Parpadeo en azul y rojo alternativamente: Actualización de firmware en curso

REQUISITO DE TARJETA DE ALMACENAMIENTO LOCAL

Puede elegir entre almacenamiento en la nube o aprovechar la opción de almacenamiento local instalando una tarjeta SD en su ranura SD. La serie de productos WUUK Wired Cam puede llevar una tarjeta micro SD al tamaño máximo de 256 GB, formato FAT32, y tiene que ser Clase 10 Recomendamos formatear la tarjeta SD antes de usarla por primera vez en la WUUK Wired Cam .

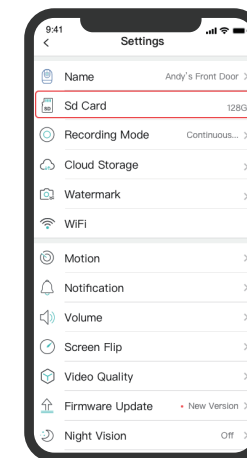

Los usuarios de la aplicación WUUK pueden acceder a la herramienta de formateo de tarjetas SD en la aplicación WUUK después de insertar una tarjeta del tamaño correcto y escuchar un clic.

La suscripción al almacenamiento en la nube es opcional y debe comprarse por separado en el sitio web de WUUK Labs. Puede consultar sus planes de suscripción en la aplicación WUUK.

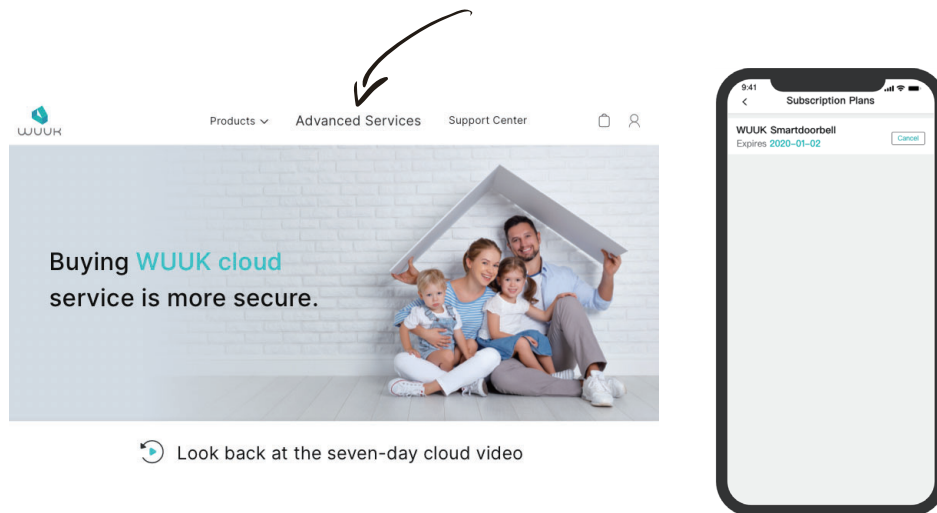

SERVICIO AL CLIENTE

Para solucionar problemas, consulte la aplicación WUUK > Cuenta > Centro de Ayuda para obtener más referencias y chatear en vivo con los agentes de atención al cliente si es necesario.

Garantía: Garantía limitada de 12 meses

Envíenos un correo electrónico: hello@wuuklabs.com

WUUK Labs Corp. Todos los derechos reservados.

WUUK y el logotipo de WUUK son marcas comerciales de WUUK Labs Corp., registradas en los Estados Unidos y otros países. Todas las demás marcas registradas son propiedad de sus respectivos dueños.

TABLE DES MATIÈRES

CE QUI EST INCLU	48
PRÉSENTATION DU PRODUIT	49
CONFIGURATION DU SYSTÈME	50
INSTALLATION DE CAM PRO CÂBLÉ	51
POWER ON THE WUUK WIRED CAM	56
COMPRENDRE L'INDICATEUR LUMINEUX	57
EXIGENCES RELATIVES À LA CARTE DE MÉMOIRE LOCALE	58
SERVICE CLIENTS	60

CE QUI EST INCLU

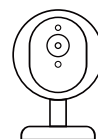

Câble
Cam Pro

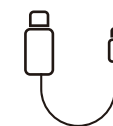

Câble USB
de Type C



Adaptateur
Secteur USB

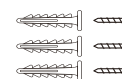

Pack de Vis
de Montage



Manuel de
l'Utilisateur

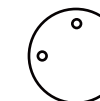

Plaque
de Montage

**Remarque : pour tous les produits WUUK Wired Cam, aucune batterie n'est incluse. Des fils ou des cordons d'alimentation sont nécessaires pour alimenter l'appareil et doivent être branchés à tout moment lors de l'utilisation.*

PRÉSENTATION DU PRODUIT

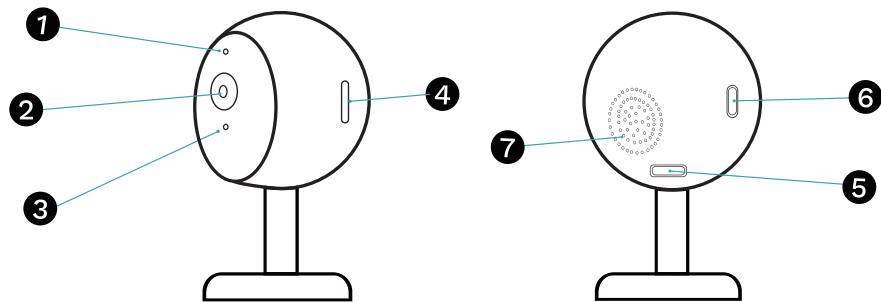

- ❶ Indicateur lumineux
- ❷ Objectif de la caméra
- ❸ Microphone
- ❹ Fente pour carte SD
- ❺ Port d'alimentation
- ❻ Bouton SYNC
- ❼ Haut-parleur

CONFIGURATION DU SYSTÈME

Téléchargez l'application WUUK depuis l'App Store (appareils iOS) ou Google Play Store (appareils Android).

Enregistrez un compte s'il n'y a pas de compte existant.

Accédez à la page d'accueil de l'application. Cliquez sur Ajouter Appareil, et ajoutez le Wuk Cable camera Professional à votre application WUUK.

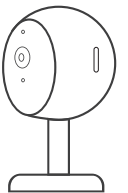

Suivez les instructions à l'écran pour terminer la configuration.

INSTALLATION DE CAM PRO CÂBLÉ

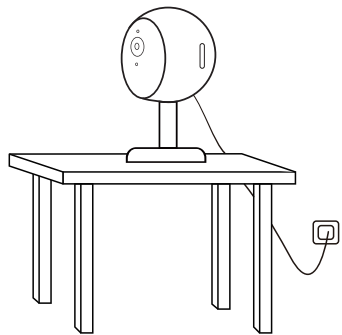

La caméra peut être placée sur une table, une étagère ou peut être montée sur un mur ou un plafond. Sélectionnez un emplacement et une hauteur où vous pouvez obtenir la vue souhaitée via l'application WUUK.

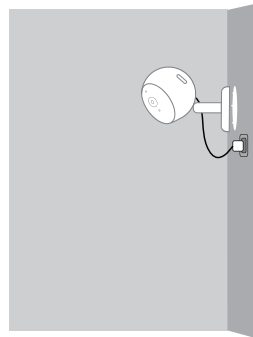

Un cordon d'alimentation de 2 mètres de long est inclus dans l'emballage d'origine, de sorte que l'emplacement souhaité doit pouvoir atteindre une prise de courant à portée du cordon d'alimentation.

Trouver un Bon Emplacement de Montage



Utilisez le “Diagnostic de Signal” fonction dans l'application WUUK pour tester la force du signal WiFi de la WUUK Wired Cam à l'endroit où vous prévoyez de placer ou de monter la caméra.

Comprendre le résultat du Diagnostic de Signal

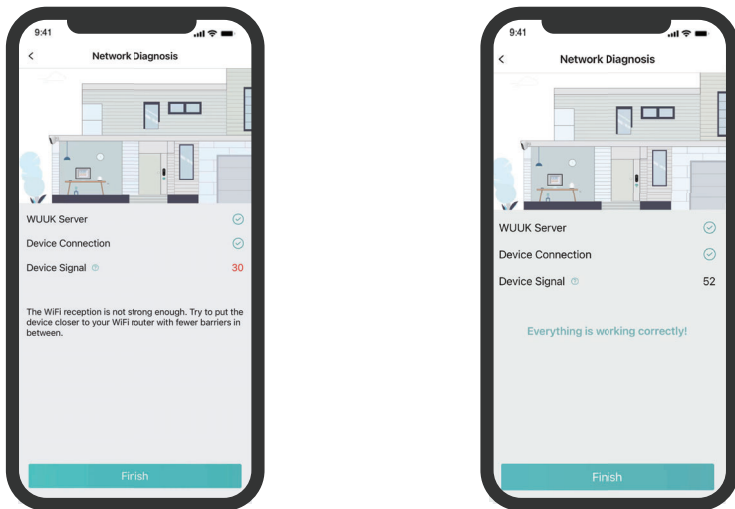

Si le signal entre les appareils n'est pas assez fort, veuillez essayer de changer l'emplacement de la caméra jusqu'à ce que vous trouviez un endroit où la caméra a un bon résultat de test de signal dans l'application.

Montez le WUUK Wired Cam

Si vous devez monter votre WUUK Wired Cam, après avoir marqué l'emplacement à l'aide de l'autocollant de localisation et trouvé la vue souhaitée, veuillez débrancher la WUUK Wired Cam de la prise de courant avant le montage.

Gardez la WUUK Wired Cam à au moins 0,7 pieds / 20 cm des murs ou de tout ce qui pourrait obstruer la vue.

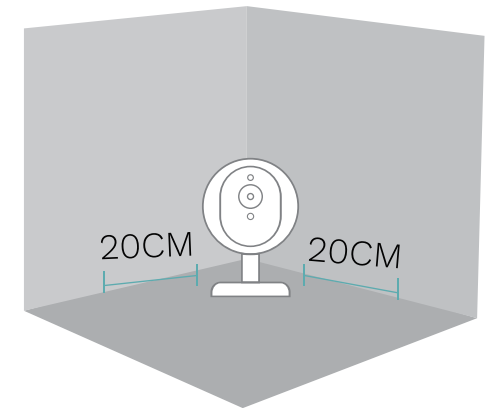

Évitez la réflexion infrarouge, qui peut avoir un impact négatif sur les performances de vision nocturne de la caméra.

Pour monter la WUUK Wired Cam au plafond, suivez les étapes ci-dessous :

Placez l'autocollant de positionnement contre le plafond, puis marquez la position de la vis à laquelle le perçage sera nécessaire.

Percez des trous avec un foret de 6mm.

Align the holes on the mounting plate with those in the ceiling. Insert the anchors into the holes; anchors are necessary for walls that are made out of hard materials such as concrete, brick, or stucco. Fix the screws to fasten the mounting plate to the ceiling.

Alignez la fente de montage avec la plaque de montage, puis poussez la caméra vers le bas jusqu'à ce qu'elle s'enclenche.

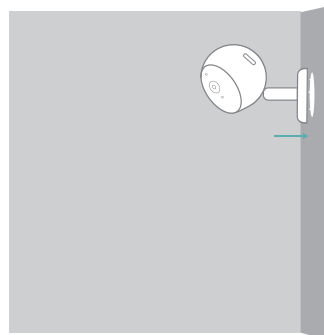

POWER ON THE WUUK WIRED CAM

Connectez la WUUK Wired Cam à une prise de courant à l'aide du câble USB et de l'adaptateur d'alimentation USB fournis. Si le câble d'alimentation est correctement connecté, la caméra s'allumera sans aucune autre opération.





Après avoir été allumée, la WUUK Wired Cam se connectera automatiquement au système si le processus de couplage est effectué dans les étapes précédentes. Si ce n'est pas le cas, veuillez vous reporter à l'étape : CONFIGURATION DU SYSTÈME dans le manuel.

Lorsqu'il est connecté avec succès, l'indicateur lumineux s'allume en BLEU SOLIDE ●.

Appuyez sur la fonction Live View dans l'application WUUK pour vérifier si la vue est souhaitée, ajustez la WUUK Wired Cam si nécessaire.

Vous êtes maintenant prêt à utiliser votre WUUK Wired Cam.

COMPRENDRE L'INDICATEUR LUMINEUX

	Bleu Solide : S'allume et fonctionne correctement
	Rouge Solide : Le système est en cours d'initialisation ou de redémarrage
	Bleu Blinkend : Vom Internet getrennt
	Rouge Clignotant : Mode de couplage, prêt pour la configuration
	Bleu et rouge clignotant alternativement : Mise à jour du micrologiciel en cours

EXIGENCES RELATIVES À LA CARTE DE MÉMOIRE LOCALE

Vous pouvez choisir entre le stockage en nuage ou tirer parti de l'option de stockage local en installant une carte SD dans son emplacement SD. WUUK Wired Cam La série de produits peut prendre la carte micro SD à la taille maximale de 256 Go, au format FAT32, et elle doit être de classe 10. Nous vous recommandons de formater la carte SD avant la première utilisation sur le WUUK Wired Cam.

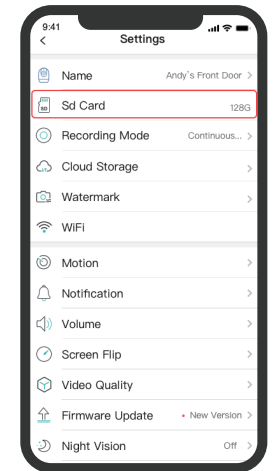

Les utilisateurs de l'application WUUK peuvent accéder à l'outil de formatage de carte SD dans l'application WUUK après avoir inséré une carte de la bonne taille et entendu un clic.

L'abonnement au stockage en nuage est facultatif et doit être acheté séparément sur le site Web de WUUK Labs. Vous pouvez vérifier vos plans d'abonnement dans l'application WUUK.

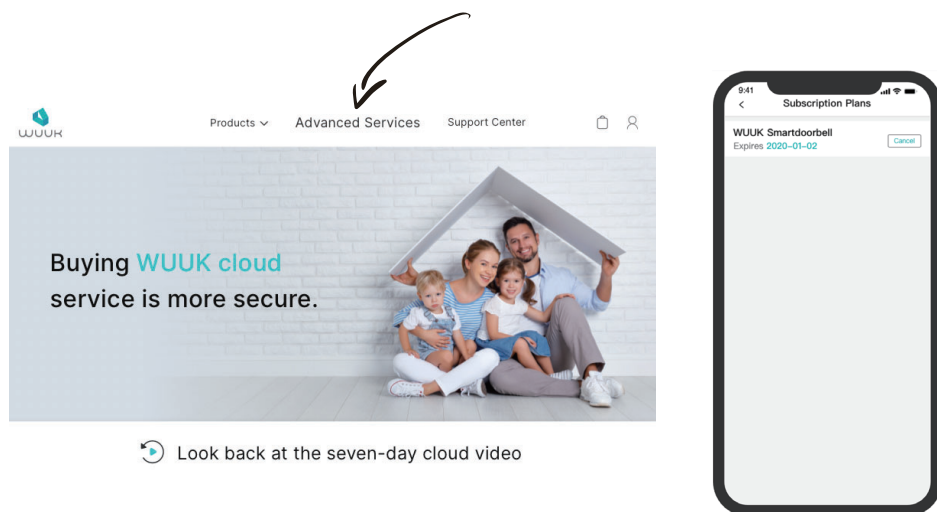

SERVICE CLIENTS

Pour le dépannage, consultez l'application WUUK > Compte > Centre d'Aide pour plus de références et discutez en direct avec les agents du service client si nécessaire.

Garantie : Garantie limitée de 12 mois

Envoyez-nous un e-mail : hello@wuuklabs.com

WUUK Labs Corp. Tous droits réservés.

WUUK et le logo WUUK sont des marques commerciales de WUUK Labs Corp., déposées aux États-Unis et dans d'autres pays. Toutes les autres marques déposées sont la propriété de leurs propriétaires respectifs.

INDICE

COSA È INCLUSO	62
PANORAMICA DEL PRODOTTO	63
PREPARAZIONE DEL SISTEMA	64
MONTARE IL CAMPRO WIRED	65
POWER ON THE WUUK WIRED CAM	70
COMPRENDERE L'INDICATORE LUMINOSO	71
REQUISITO DELLA CARTA DI CONSERVAZIONE LOCALE	72
ASSISTENZA CLIENTI	74

COSA È INCLUSO

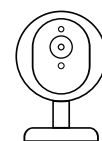

Wired
Cam Pro

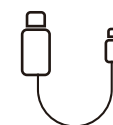

Cavo USB
di Tipo C

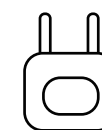

Adattatore di
Alimentazione
USB

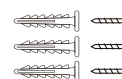

Pacchetto Viti
di Montaggio



Manuale
d'Uso

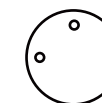

Piastra di
Montaggio

**Nota: per tutti i prodotti WUUK Wired Cam, la batteria non è inclusa. I cavi o i cavi di alimentazione sono necessari per alimentare il dispositivo e devono essere sempre collegati durante l'uso.*

PANORAMICA DEL PRODOTTO

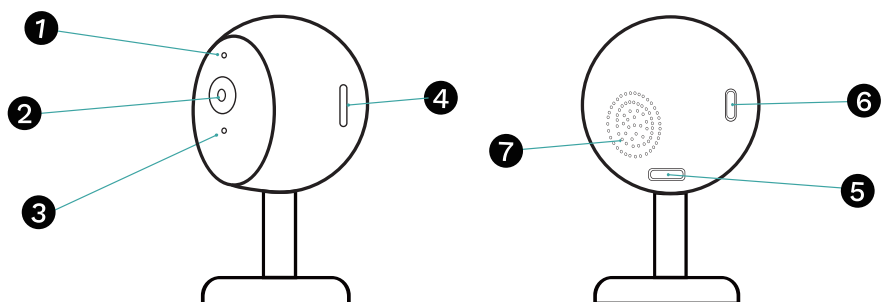

- ❶ Indicatore luminoso
- ❷ Obiettivo della fotocamera
- ❸ Microfono
- ❹ Slot per scheda SD
- ❺ Porta di alimentazione
- ❻ Pulsante SYNC
- ❼ Altoparlante

PREPARAZIONE DEL SISTEMA

Scarica l'app WUUK da App Store (dispositivi iOS) o Google Play Store (dispositivi Android).

Registra un account se non esiste un account esistente.

Vai alla home page dell'app. Tocca Aggiungi Dispositivo e aggiungi WUUK Wired Cam Pro alla tua app WUUK.

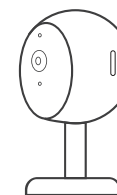

Segui le istruzioni sullo schermo per completare la configurazione.

MONTARE IL CAMPRO WIRED

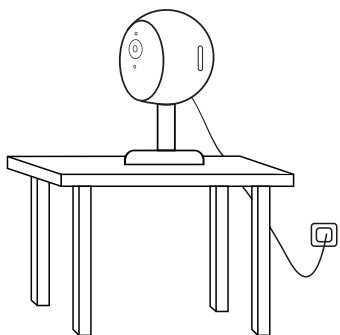

La telecamera può essere posizionata su un tavolo, una mensola o può essere montata su una parete o un soffitto. Selezionare una posizione e un'altezza in cui è possibile ottenere la vista desiderata tramite l'app WUUK.

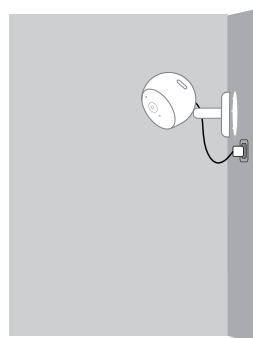

Nella confezione originale è incluso un cavo di alimentazione lungo 2 metri, quindi la posizione desiderata deve poter raggiungere una presa di corrente alla portata del cavo di alimentazione.

Trova un Buon Punto di Montaggio



impostazione
della fotocamera

Utilizzare la funzione "Network Diagnosis" nell'app WUUK per testare la potenza del segnale Wi-Fi della WUUK Wired Cam nella posizione in cui si prevede di posizionare o montare la telecamera.

Comprendere il risultato di Diagnosi di Rete

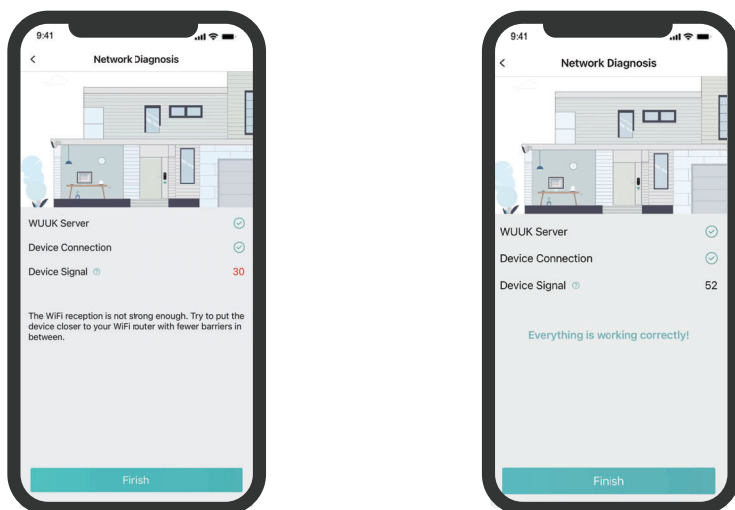

Se il segnale tra i dispositivi non è abbastanza forte, prova a cambiare la posizione della videocamera finché non trovi un punto in cui la videocamera ha un buon risultato di test del segnale nell'app.

Montare il WUUK Wired Cam

Se è necessario montare la WUUK Wired Cam, dopo aver contrassegnato la posizione utilizzando l'adesivo di localizzazione e aver trovato la vista desiderata, scollegare la WUUK Wired Cam dalla presa di corrente prima del montaggio.

Tenere la WUUK Wired Cam ad almeno 20 cm di distanza dalle pareti o da qualsiasi cosa che possa ostruire la visuale.

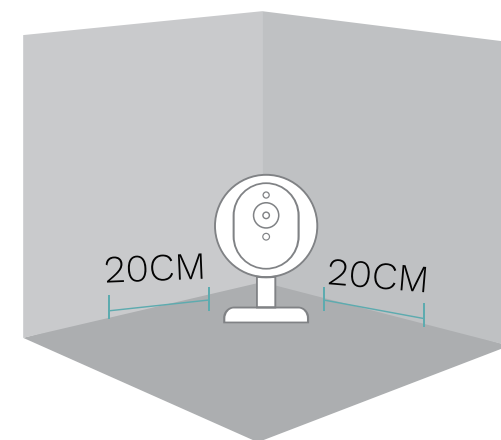

Evita la riflessione a infrarossi, che può avere un impatto negativo sulle prestazioni di visione notturna della fotocamera.

Per montare la WUUK Wired Cam sul soffitto, attenersi alla seguente procedura:

Posizionare l'adesivo di posizionamento contro il soffitto e quindi contrassegnare la posizione della vite in cui sarà necessaria la perforazione.

Praticare dei fori con una punta da 6mm.

Allineare i fori sulla piastra di montaggio con quelli nel soffitto. Inserire gli ancoraggi nei fori; gli ancoraggi sono necessari per pareti realizzate con materiali duri come cemento, mattoni o stucco. Fissare le viti per fissare la piastra di montaggio al soffitto.

Allineare lo slot di montaggio con la piastra di montaggio, quindi spingere la telecamera verso il basso finché non scatta in posizione.

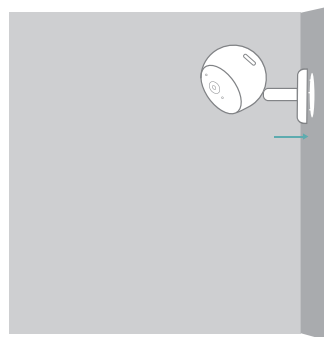

POWER ON THE WUUK WIRED CAM

Collegare la WUUK Wired Cam a una presa di corrente utilizzando il cavo USB e l'adattatore di alimentazione USB forniti. Se il cavo di alimentazione è collegato correttamente, la fotocamera si accenderà senza ulteriori operazioni.

Dopo essere stata accesa, la WUUK Wired Cam si collegherà automaticamente al sistema se il processo di associazione viene eseguito nei passaggi precedenti. In caso contrario, fare riferimento al passaggio: PREPARAZIONE DEL SISTEMA nel manuale.

Quando è collegato correttamente, l'indicatore luminoso si accende di BLU FISSO●.

Tocca la funzione Live View nell'app WUUK per verificare se la visualizzazione è desiderata, regola la WUUK Wired Cam se necessario.

Ora sei pronto per utilizzare la tua WUUK Wired Cam.

COMPRENDERE L'INDICATORE LUMINOSO

●	Blu Fisso: Acceso e funzionante correttamente
●	Rosso Fisso: Il sistema si sta inizializzando o si sta riavviando
●	Blu Lampeggiante: Disconnesso da Internet
●	Rosso Lampeggiante: Modalità di associazione, pronto per la configurazione
● ●	Blu e rosso lampeggianti alternativamente: Aggiornamento del firmware in corso"

REQUISITO DELLA CARTA DI CONSERVAZIONE LOCALE

Puoi scegliere tra l'archiviazione su cloud o sfruttare l'opzione di archiviazione locale installando una scheda SD nel suo slot SD. La serie di prodotti WUUK Wired Cam può portare la scheda micro SD alla dimensione massima di 256 GB, formato FAT32 e deve essere di Classe 10 Si consiglia di formattare la scheda SD prima del primo utilizzo sulla WUUK Wired Cam.

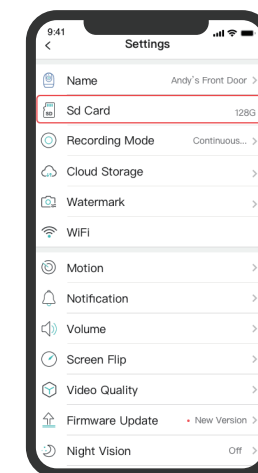

Gli utenti dell'app WUUK possono accedere allo strumento di formattazione della scheda SD nell'app WUUK dopo aver inserito una scheda della giusta dimensione e aver sentito un clic.

L'abbonamento per l'archiviazione su cloud è facoltativo e deve essere acquistato separatamente sul sito Web di WUUK Labs. Puoi controllare i tuoi piani di abbonamento nell'app WUUK.

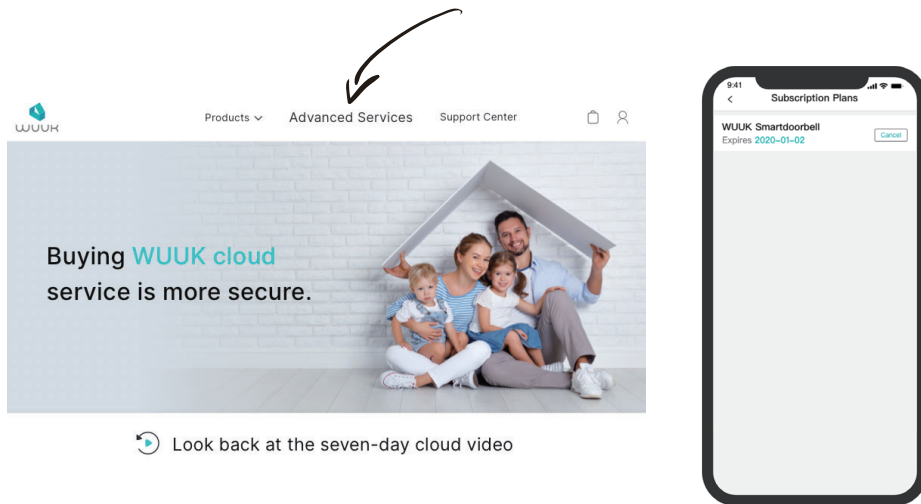

ASSISTENZA CLIENTI

Per la risoluzione dei problemi, controlla l'app WUUK > Account > Centro Assistenza per ulteriori riferimenti e chat dal vivo con gli agenti dell'assistenza clienti, se necessario.

Garanzia: 12 mesi di garanzia limitata

Inviaci un'e-mail: hello@wuuklabs.com

WUUK Labs Corp. Tutti i diritti riservati.

WUUK e il logo WUUK sono marchi di WUUK Labs Corp., registrati negli Stati Uniti e in altri paesi. Tutti gli altri marchi sono di proprietà dei rispettivi proprietari.

Product Model: Y0310 PMN: WUUK Wired Cam Pro

ISED Statement:

-English: This device complies with Industry Canada license-exempt RSS standard(s).

Operation is subject to the following two conditions: (1) This device may not cause interference, and (2) This device must accept any interference, including interference that may cause undesired operation of the device.

The digital apparatus complies with Canadian CAN ICES-3 (B)/NMB-3(B).

- French: Le présent appareil est conforme aux CNR d'Industrie Canada applicables aux appareils radio exempts de licence. L'exploitation est autorisée aux deux conditions suivantes: (1) l'appareil ne doit pas produire de brouillage, et (2) l'utilisateur de l'appareil doit accepter tout brouillage radioélectrique subi, même si le brouillage est susceptible d'en compromettre le fonctionnement.

L'appareil numérique du ciem conforme canadien peut - 3 (b) / nmb - 3 (b).

This device meets the exemption from the routine evaluation limits in section 2.5 of RSS 102 and compliance with RSS 102 RF exposure, users can obtain Canadian information on RF exposure and compliance.

cet appareil est conforme à l'exemption des limites d'évaluation courante dans la section 2.5 du cnr - 102 et conformité avec rss 102 de l'exposition aux rf, les utilisateurs peuvent obtenir des données canadiennes sur l'exposition aux champs rf et la conformité.

This equipment complies with Canada radiation exposure limits set forth for an uncontrolled environment.

Cet équipement est conforme aux limites d'exposition au rayonnement établies par le Canada pour un environnement non contrôlé.

This equipment should be installed and operated with minimum distance 20cm between the radiator & your body.

Cet équipement est conforme Canada limites d'exposition aux radiations dans un environnement non contrôlé.

Cet équipement doit être installé et utilisé avec une distance minimale de 20 cm entre le radiateur et votre corps.