

TEST REPORT

CERTIFICATE OF CONFORMITY

Standard: 47 CFR FCC Part 15, Subpart C (Section 15.247)

Report No.: RFBCKS-WTW-P23090477

FCC ID: 2AWHPR232

Product: Starlink Router

Brand: SPACEX



Model No.: UTR-232

Received Date: 2023/8/30

Test Date: 2023/8/30 ~ 2023/10/13

Issued Date: 2023/11/3

Applicant: Space Exploration Technologies Corp. (SPACEX)

Address: 1 Rocket Rd., Hawthorne, CA 90250 USA

Issued By: Bureau Veritas Consumer Products Services (H.K.) Ltd., Taoyuan Branch
Hsin Chu Laboratory

Lab Address: E-2, No.1, Li Hsin 1st Road, Hsinchu Science Park, Hsinchu City 300, Taiwan

Test Location: E-2, No.1, Li Hsin 1st Road, Hsinchu Science Park, Hsinchu City 300, Taiwan

FCC Registration / 723255 / TW2022

Designation Number:

Approved by: _____

May Chen / Manager

Date: _____

2023/11/3

This test report consists of 86 pages in total. It may be duplicated completely for legal use with the approval of the applicant. It should not be reproduced except in full, without the written approval of our laboratory. The test results in the report only apply to the tested sample. The test results in this report are traceable to the national or international standards.



Prepared by : Phoenix Huang / Specialist

This report is governed by, and incorporates by reference, the Conditions of Testing as posted at the date of issuance of this report at <http://www.bureauveritas.com/home/about-us/our-business/cps/about-us/terms-conditions/> and is intended for your exclusive use. Any copying or replication of this report to or for any other person or entity, or use of our name or trademark, is permitted only with our prior written permission. This report sets forth our findings solely with respect to the test samples identified herein. The results set forth in this report are not indicative or representative of the quality or characteristics of the lot from which a test sample was taken or any similar or identical product unless specifically and expressly noted. Our report includes all of the tests requested by you and the results thereof based upon the information that you provided to us. Measurement uncertainty is only provided upon request for accredited tests. Statements of conformity are based on simple acceptance criteria without taking measurement uncertainty into account, unless otherwise requested in writing. You have 60 days from date of issuance of this report to notify us of any material error or omission caused by our negligence or if you require measurement uncertainty; provided, however, that such notice shall be in writing and shall specifically address the issue you wish to raise. A failure to raise such issue within the prescribed time shall constitute your unqualified acceptance of the completeness of this report, the tests conducted and the correctness of the report contents.

Table of Contents

Release Control Record	4
1 Certificate	5
2 Summary of Test Results	6
2.1 Measurement Uncertainty	6
2.2 Supplementary Information	6
3 General Information	7
3.1 General Description	7
3.2 Antenna Description of EUT	8
3.3 Channel List	10
3.4 Test Mode Applicability and Tested Channel Detail	11
3.5 Duty Cycle of Test Signal	12
3.6 Test Program Used and Operation Descriptions	14
3.7 Connection Diagram of EUT and Peripheral Devices	14
3.8 Configuration of Peripheral Devices and Cable Connections	14
4 Test Instruments	15
4.1 RF Output Power	15
4.2 Power Spectral Density	15
4.3 6 dB Bandwidth	15
4.4 Conducted Out of Band Emissions	15
4.5 AC Power Conducted Emissions	16
4.6 Unwanted Emissions below 1 GHz	16
4.7 Unwanted Emissions above 1 GHz	17
5 Limits of Test Items	18
5.1 RF Output Power	18
5.2 Power Spectral Density	18
5.3 6 dB Bandwidth	18
5.4 Conducted Out of Band Emissions	18
5.5 AC Power Conducted Emissions	18
5.6 Unwanted Emissions below 1 GHz	19
5.7 Unwanted Emissions above 1 GHz	19
6 Test Arrangements	20
6.1 RF Output Power	20
6.1.1 Test Setup	20
6.1.2 Test Procedure	20
6.2 Power Spectral Density	20
6.2.1 Test Setup	20
6.2.2 Test Procedure	20
6.3 6 dB Bandwidth	21
6.3.1 Test Setup	21
6.3.2 Test Procedure	21
6.4 Conducted Out of Band Emissions	21
6.4.1 Test Setup	21
6.4.2 Test Procedure	21
6.5 AC Power Conducted Emissions	22
6.5.1 Test Setup	22
6.5.2 Test Procedure	22
6.6 Unwanted Emissions below 1 GHz	23
6.6.1 Test Setup	23
6.6.2 Test Procedure	24
6.7 Unwanted Emissions above 1 GHz	25
6.7.1 Test Setup	25
6.7.2 Test Procedure	25
7 Test Results of Test Item	26



7.1	RF Output Power.....	26
7.2	Power Spectral Density.....	29
7.3	6 dB Bandwidth.....	31
7.4	Conducted Out of Band Emissions.....	33
7.5	AC Power Conducted Emissions.....	49
7.6	Unwanted Emissions below 1 GHz.....	51
7.7	Unwanted Emissions above 1 GHz.....	53
8	Pictures of Test Arrangements.....	85
9	Information of the Testing Laboratories.....	86

Release Control Record

Issue No.	Description	Date Issued
RFBCKS-WTW-P23090477	Original release.	2023/11/3

1 Certificate

Product: Starlink Router

Brand: SPACEX



Test Model: UTR-232

Sample Status: Engineering sample

Applicant: Space Exploration Technologies Corp. (SPACEX)

Test Date: 2023/8/30 ~ 2023/10/13

Standard: 47 CFR FCC Part 15, Subpart C (Section 15.247)

Measurement ANSI C63.10-2013

procedure: KDB 558074 D01 15.247 Meas Guidance v05r02

KDB 662911 D01 Multiple Transmitter Output v02r01

The above equipment has been tested by **Bureau Veritas Consumer Products Services (H.K.) Ltd., Taoyuan Branch**, and found compliance with the requirement of the above standards. The test record, data evaluation & Equipment Under Test (EUT) configurations represented herein are true and accurate accounts of the measurements of the sample's RF characteristics under the conditions specified in this report.

2 Summary of Test Results

47 CFR FCC Part 15, Subpart C (Section 15.247)			
Standard / Clause	Test Item	Result	Remark
15.247(b)	RF Output Power	Pass	Meet the requirement of limit.
15.247(e)	Power Spectral Density	Pass	Meet the requirement of limit.
15.247(a)(2)	6 dB Bandwidth	Pass	Meet the requirement of limit.
15.247(d)	Conducted Out of Band Emissions	Pass	Meet the requirement of limit.
15.207	AC Power Conducted Emissions	Pass	Minimum passing margin is -9.97 dB at 0.50156 MHz
15.205 / 15.209 / 15.247(d)	Unwanted Emissions below 1 GHz	Pass	Minimum passing margin is -12.1 dB at 557.78 MHz
15.205 / 15.209 / 15.247(d)	Unwanted Emissions above 1 GHz	Pass	Minimum passing margin is -0.1 dB at 2390.00 MHz
15.203	Antenna Requirement	Pass	Antenna connector is ipex(MHF) not a standard connector.

Note: Determining compliance based on the results of the compliance measurement, not taking into account measurement instrumentation uncertainty.

2.1 Measurement Uncertainty

Where relevant, the following measurement uncertainty levels have been estimated for tests performed on the EUT as specified in CISPR 16-4-2:

Measurement	Specification	Expanded Uncertainty (k=2) (±)
RF Output Power	-	1.1 dB
Power Spectral Density	-	1.3 dB
6 dB Bandwidth	-	1050.00 Hz
Conducted Out of Band Emissions	9 kHz ~ 40 GHz	2.6 dB
AC Power Conducted Emissions	150 kHz ~ 30 MHz	1.9 dB
Unwanted Emissions below 1 GHz	9 kHz ~ 30 MHz	3.1 dB
	30 MHz ~ 1 GHz	5.5 dB
Unwanted Emissions above 1 GHz	1 GHz ~ 18 GHz	5.1 dB
	18 GHz ~ 40 GHz	5.3 dB

The other instruments specified are routine verified to remain within the calibrated levels, no measurement uncertainty is required to be calculated.

2.2 Supplementary Information

There is not any deviation from the test standards for the test method, and no modifications required for compliance.

3 General Information

3.1 General Description

Product	Starlink Router
Brand	SPACEEX 
Test Model	UTR-232
Status of EUT	Engineering sample
Power Supply Rating	30 Vdc or 57 Vdc from power adapter
Modulation Type	CCK, DQPSK, DBPSK for DSSS 64QAM, 16QAM, QPSK, BPSK for OFDM 256QAM for OFDM in VHT mode 1024QAM for OFDMA in 11ax mode
Modulation Technology	DSSS, OFDM, OFDMA
Transfer Rate	802.11b: up to 11 Mbps 802.11g: up to 54 Mbps 802.11n: up to 600 Mbps VHT: up to 800 Mbps 802.11ax: up to 1147.1 Mbps
Operating Frequency	2.412 GHz ~ 2.462 GHz
Number of Channel	802.11b, 802.11g, 802.11n (HT20), VHT20, 802.11ax (HE20): 11 802.11n (HT40), VHT40, 802.11ax (HE40): 7
Output Power	CDD Mode: 995.111 mW (29.98 dBm) Beamforming Mode: 753.608 mW (28.77 dBm)

Note:

1. The EUT uses following accessories.

AC Adapter 1		
Brand	Model	Specification
STARLINK	UTP-231L	AC Input : 100-240 V~1.6 A 50/60 Hz DC Output : 30 V-2.0 A (Total Max 60 W) LPS DC Output Cable : 1.5 m, unshielded without core Plug : FCC
AC Adapter 2		
Brand	Model	Specification
STARLINK	UTP-232C	AC Input : 100 V-240 V, 2.5 A, 50/60 Hz AC Input Cable : 1.55 m, shielded without core DC Output : 57 V, 3.42 A DC Output Cable : 1.55 m, unshielded without core Plug : FCC

2. The EUT has below radios as following table:

Radio 1	Radio 2	Radio 3
WLAN 2.4GHz	WLAN 5GHz (Low)	WLAN 5GHz (High)

3. Simultaneously transmission condition.

Condition	Technology		
1	WLAN 2.4GHz	WLAN 5GHz (Low)	WLAN 5GHz (High)

Note: The emission of the simultaneous operation has been evaluated and no non-compliance was found.

4. The above EUT information is declared by manufacturer and for more detailed features description, please refer to the manufacturer's specifications or user's manual.

3.2 Antenna Description of EUT

1. The antenna information is listed as below.

Antenna No.	RF Chain No.	Antenna Net Gain (dBi)	Frequency Range (GHz)	Antenna Type	Connector Type
2G1	Ant1	4.49	2.4~2.4835	PIFA	ipex(MHF)
2G2	Ant2	4.89	2.4~2.4835	PIFA	ipex(MHF)
2G3	Ant3	2.63	2.4~2.4835	PIFA	ipex(MHF)
2G4	Ant4	4.88	2.4~2.4835	PIFA	ipex(MHF)
5L1	Ant1	4.35	5.15~5.25	PIFA	ipex(MHF)
		3.70	5.25~5.35		
5L2	Ant2	3.27	5.15~5.25	PIFA	ipex(MHF)
		3.09	5.25~5.35		
5L3	Ant3	4.22	5.15~5.25	PIFA	ipex(MHF)
		4.22	5.25~5.35		
5L4	Ant4	2.82	5.15~5.25	PIFA	ipex(MHF)
		2.56	5.25~5.35		
5H1	Ant1	5.14	5.47~5.725	PIFA	ipex(MHF)
		5.65	5.725~5.85		
5H2	Ant2	4.87	5.47~5.725	PIFA	ipex(MHF)
		4.26	5.725~5.85		
5H3	Ant3	5.46	5.47~5.725	PIFA	ipex(MHF)
		5.48	5.725~5.85		
5H4	Ant4	4.76	5.47~5.725	PIFA	ipex(MHF)
		4.33	5.725~5.85		

2. The directional gain table:

Frequency Range (GHz)	Directional Antenna Gain (dBi)	Antenna Type	Connector Type
2.4~2.4835	7.17	PIFA	ipex(MHF)
5.15 ~ 5.25	7.09	PIFA	ipex(MHF)
5.25 ~ 5.35	7.01	PIFA	ipex(MHF)
5.47 ~ 5.725	6.57	PIFA	ipex(MHF)
5.725 ~ 5.85	7.21	PIFA	ipex(MHF)

3. Detail antenna specification please refer to antenna datasheet and/or antenna measurement report.

4. The EUT incorporates a MIMO function:

2.4 GHz Band		
Modulation Mode	TX & RX Configuration	
802.11b	4TX	4RX
802.11g	4TX	4RX
802.11n (HT20)	4TX	4RX
802.11n (HT40)	4TX	4RX
VHT20	4TX	4RX
VHT40	4TX	4RX
802.11ax (HE20)	4TX	4RX
802.11ax (HE40)	4TX	4RX

Note:

1. All of modulation mode support beamforming function except 802.11b/g modulation mode.
2. The EUT support Beamforming and CDD mode, therefore both mode were investigated and the worst case scenario was identified. The worst case data were presented in test report.
3. The modulation and bandwidth are similar for 802.11n mode for 20 MHz (40 MHz), VHT mode for 20 MHz (40 MHz) and 802.11ax mode for 20 MHz (40 MHz) therefore the manufacturer will control the power for 802.11n/VHT mode is same as the 802.11ax mode or more lower than it and investigated worst case to representative mode in test report.

3.3 Channel List

11 channels are provided for 802.11b, 802.11g, 802.11n (HT20), VHT20, 802.11ax (HE20):

Channel	Frequency	Channel	Frequency
1	2412 MHz	7	2442 MHz
2	2417 MHz	8	2447 MHz
3	2422 MHz	9	2452 MHz
4	2427 MHz	10	2457 MHz
5	2432 MHz	11	2462 MHz
6	2437 MHz		

7 channels are provided for 802.11n (HT40), VHT40, 802.11ax (HE40):

Channel	Frequency	Channel	Frequency
3	2422 MHz	7	2442 MHz
4	2427 MHz	8	2447 MHz
5	2432 MHz	9	2452 MHz
6	2437 MHz		

3.4 Test Mode Applicability and Tested Channel Detail

Pre-Scan:	<ol style="list-style-type: none"> 1. EUT can be used in the following ways: X-axis/ Y-axis/ Z-axis. Pre-scan these ways and find the worst case as a representative test condition. 2. The AC Adapter has the following models: UTP-231L/UTP-232C. Pre-scan these models of AC Adapters and find the worst case as a representative test condition. 3. Pre-Scan has been conducted to determine the worst-case mode from all possible combinations between available modulations, data rates and antenna ports (if EUT with antenna diversity architecture).
Worst Case:	<ol style="list-style-type: none"> 1. X-axis/ Y-axis/ Z-axis Worst Condition: Z-axis 2. AC Adapter Worst Condition: UTP-231L

Following channel(s) was (were) selected for the final test as listed below:

Test Item	Mode	Signal Mode	Tested Channel	Modulation	Data Rate Parameter
RF Output Power	802.11b	CDD	1, 6, 11	DBPSK	1Mb/s
	802.11g	CDD	1, 6, 11	BPSK	6Mb/s
	VHT20	CDD & Beamforming	1, 6, 11	BPSK	MCS0
	VHT40	CDD & Beamforming	3, 6, 9	BPSK	MCS0
	802.11ax (HE20)	CDD & Beamforming	1, 6, 11	BPSK	MCS0
	802.11ax (HE40)	CDD & Beamforming	3, 6, 9	BPSK	MCS0
Power Spectral Density / 6 dB Bandwidth / Conducted Out of Band Emissions	802.11b	CDD	1, 6, 11	DBPSK	1Mb/s
	802.11g	CDD	1, 6, 11	BPSK	6Mb/s
	802.11ax (HE20)	CDD	1, 6, 11	BPSK	MCS0
	802.11ax (HE40)	CDD	3, 6, 9	BPSK	MCS0
AC Power Conducted Emissions	802.11ax (HE40)	CDD	6	BPSK	MCS0
Unwanted Emissions below 1 GHz	802.11ax (HE40)	CDD	6	BPSK	MCS0
Unwanted Emissions above 1 GHz	802.11b	CDD	1, 6, 11	DBPSK	1Mb/s
	802.11g	CDD	1, 6, 11	BPSK	6Mb/s
	802.11ax (HE20)	CDD	1, 6, 11	BPSK	MCS0
	802.11ax (HE40)	CDD	3, 6, 9	BPSK	MCS0

Note: Partial RU (resource unit) mechanism is not supported.

3.5 Duty Cycle of Test Signal

802.11b: Duty cycle = 8.418 ms / 8.47 ms x 100% = 99.4%

802.11g: Duty cycle = 1.397 ms / 1.453 ms x 100% = 96.1%, duty factor = 10 * log (1/Duty cycle) = 0.17 dB

802.11ax (HE20): Duty cycle = 2.868 ms / 2.924 ms x 100% = 98.1%

802.11ax (HE40): Duty cycle = 2.859 ms / 2.915 ms x 100% = 98.1%

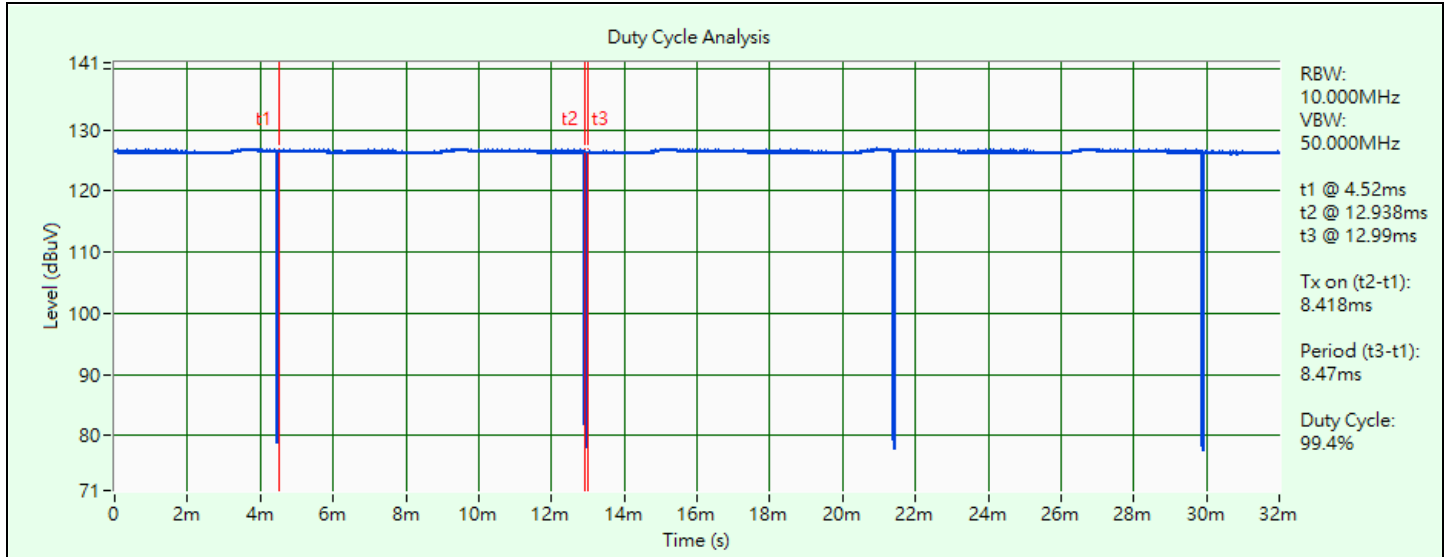

802.11b

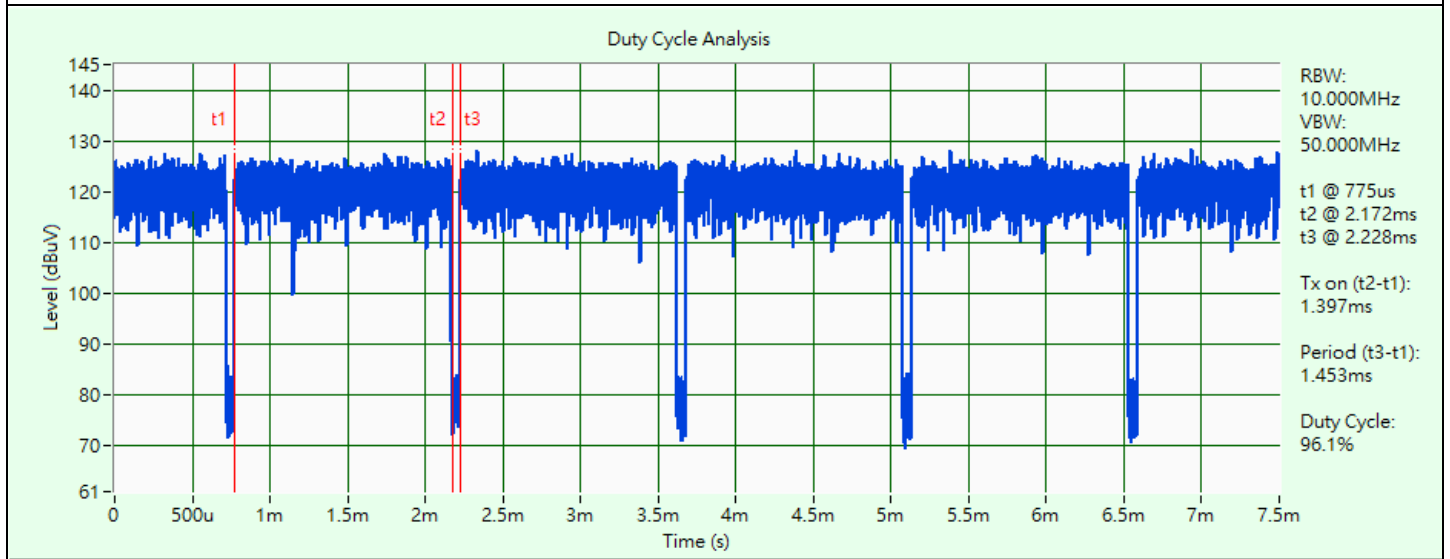

802.11g

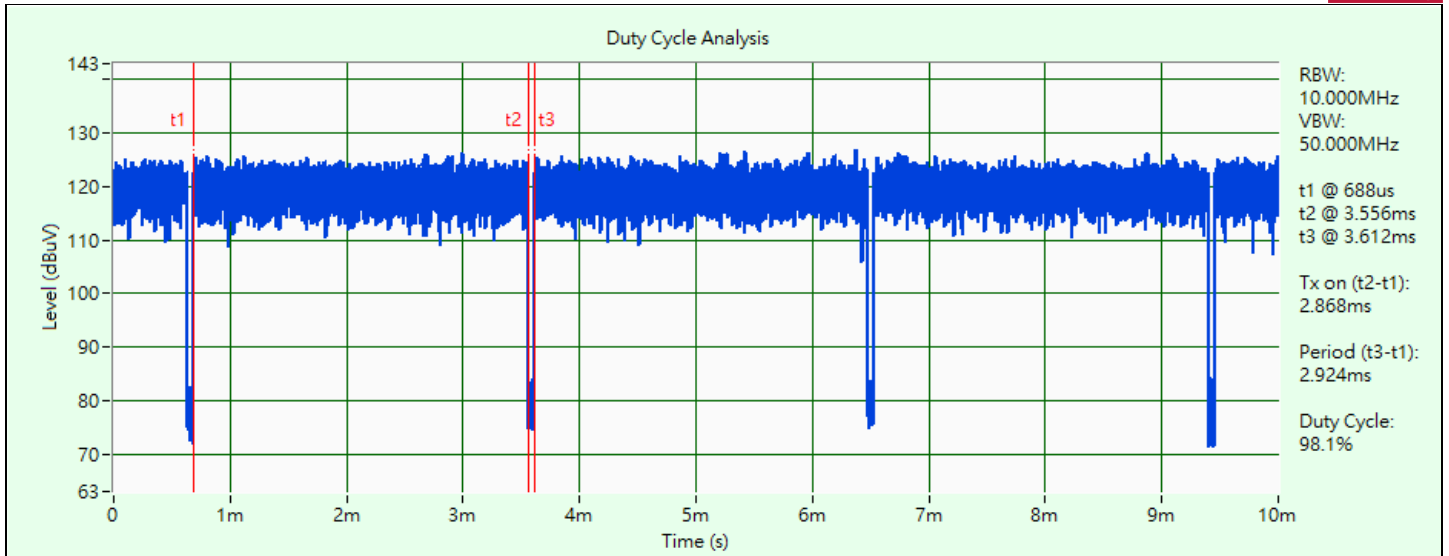

802.11ax (HE20)

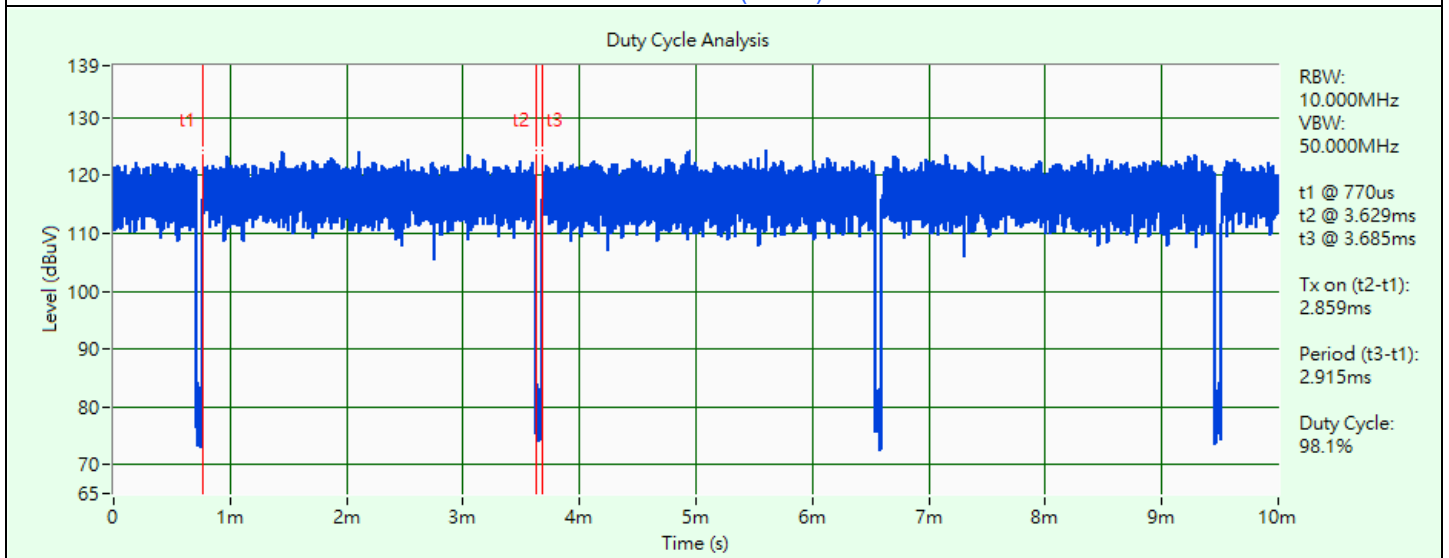

802.11ax (HE40)

3.6 Test Program Used and Operation Descriptions

Controlling software (QATool_Ulv2.88_DLLv6.93_ap_2022.01.04(V14)c) has been activated to set the EUT under transmission condition continuously at specific channel frequency.

3.7 Connection Diagram of EUT and Peripheral Devices

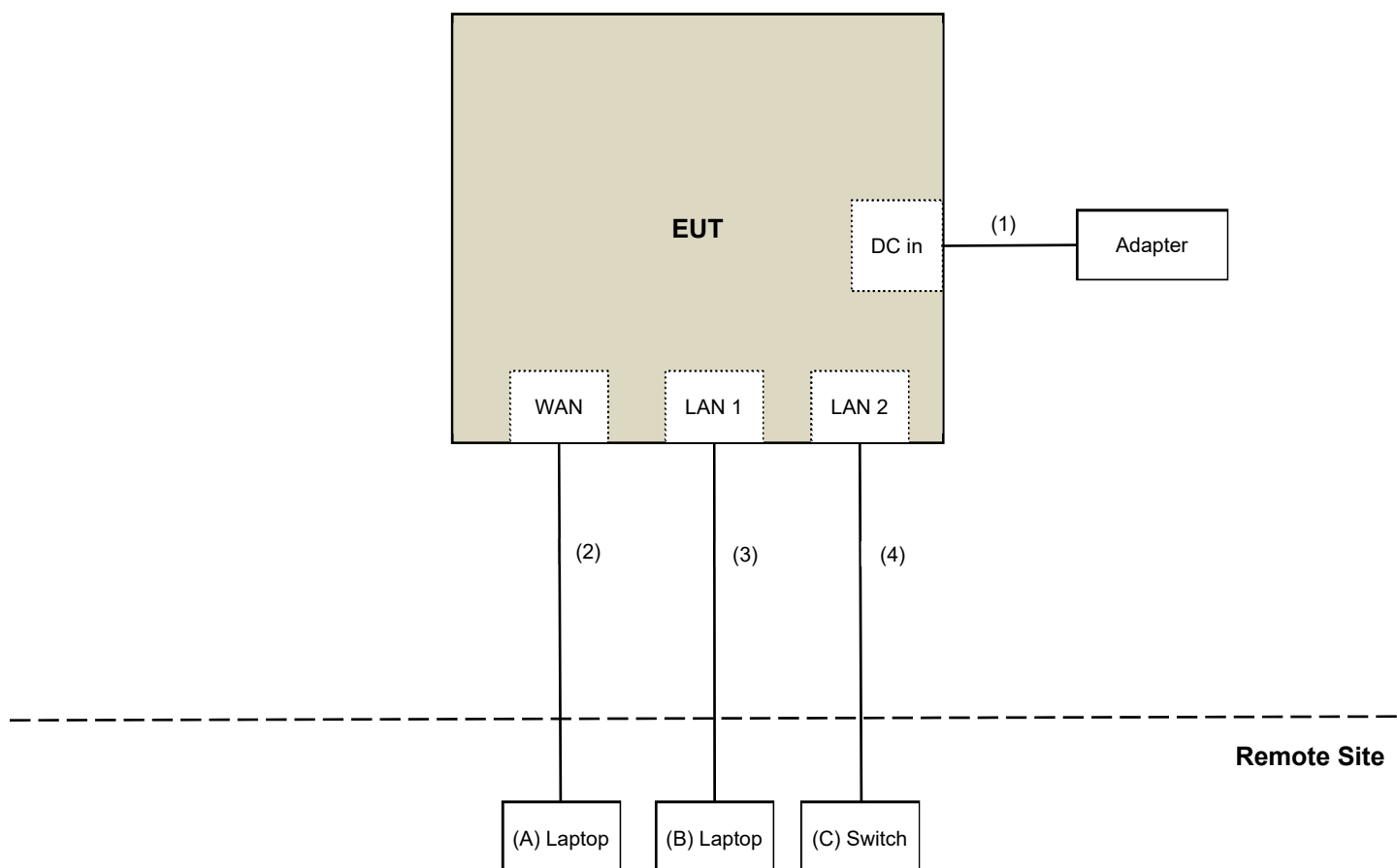

3.8 Configuration of Peripheral Devices and Cable Connections

ID	Product	Brand	Model No.	Serial No.	FCC ID	Remarks
A	Laptop	Lenovo	20U5S01X00 L14	PF-1ANPYA	N/A	Provided by Lab
B	Laptop	Lenovo	20U5S01X00 L14	PF-28LKK7	N/A	Provided by Lab
C	Switch	D-Link	DGS-1005D	DR8WC92000523	N/A	Provided by Lab

ID	Cable Descriptions	Qty.	Length (m)	Shielding (Yes/No)	Cores (Qty.)	Remarks
1	DC Cable	1	1.5	No	0	Supplied by applicant
2	*RJ-45 Cable	1	10	Yes	0	Provided by Lab
3	RJ-45 Cable	1	10	No	0	Provided by Lab
4	RJ-45 Cable	1	10	No	0	Provided by Lab

Note: * The test configurations are defined by the applicant requirement.

4 Test Instruments

The calibration interval of the all test instruments are 12 months and the calibrations are traceable to NML/ROC and NIST/USA.

4.1 RF Output Power

Description Manufacturer	Model No.	Serial No.	Calibrated Date	Calibrated Until
Power Meter Anritsu	ML2495A	1529002	2023/6/17	2024/6/16
Pulse Power Sensor Anritsu	MA2411B	1726434	2023/6/19	2024/6/18

Notes:

1. The test was performed in Oven room 2.
2. Tested Date: 2023/9/19

4.2 Power Spectral Density

Description Manufacturer	Model No.	Serial No.	Calibrated Date	Calibrated Until
MXA Signal Analyzer Keysight	N9020B	MY60112409	2023/2/18	2024/2/17
Software	ADT_RF Test Software V7.6.5.4	N/A	N/A	N/A

Notes:

1. The test was performed in Oven room 2.
2. Tested Date: 2023/9/19

4.3 6 dB Bandwidth

Refer to section 4.2 to get information of the instruments.

4.4 Conducted Out of Band Emissions

Refer to section 4.2 to get information of the instruments.

4.5 AC Power Conducted Emissions

Description Manufacturer	Model No.	Serial No.	Calibrated Date	Calibrated Until
50 ohm terminal resistance	N/A	EMC-04	2022/10/25	2023/10/24
EMI Test Receiver R&S	ESCS 30	100375	2023/5/17	2024/5/16
Fixed Attenuator STI	STI02-2200-10	005	2023/7/1	2024/6/30
LISN R&S	ENV216	100071	2022/10/26	2023/10/25
RF Coaxial Cable JYEBAO	5D-FB	COCCAB-001	2023/7/1	2024/6/30
Software BVADT	BVADT_Cond_V7.3.7.4	N/A	N/A	N/A

Notes:

1. The test was performed in Conduction 1
2. Tested Date: 2023/10/6

4.6 Unwanted Emissions below 1 GHz

Description Manufacturer	Model No.	Serial No.	Calibrated Date	Calibrated Until
Bi_Log Antenna Schwarzbeck	VULB 9168	9168-406	2023/10/13	2024/10/12
Boresight Antenna Tower & Turn Table Max-Full	MF-7802BS	MF780208530	N/A	N/A
Fixed Attenuator Mini-Circuits	UNAT-5+	PAD-ATT5-03	2022/12/28	2023/12/27
Loop Antenna Electro-Metrics	EM-6879	264	2023/2/21	2024/2/20
MXA Signal Analyzer Keysight	N9020B	MY60112408	2023/3/6	2024/3/5
MXE EMI Receiver Keysight	N9038A	MY59050100	2023/6/13	2024/6/12
Preamplifier EMCI	EMC330N	980701	2023/2/18	2024/2/17
	EMC001340	980142	2023/5/8	2024/5/7
RF Coaxial Cable JYEBAO	5D-FB	LOOPCAB-001	2022/12/19	2023/12/18
		LOOPCAB-002	2022/12/19	2023/12/18
RF Coaxial Cable PEWC	8D	966-4-1	2023/2/18	2024/2/17
		966-4-2	2023/2/18	2024/2/17
		966-4-3	2023/2/18	2024/2/17
Software	ADT_Radiated_V8.7.08	N/A	N/A	N/A

Notes:

1. The test was performed in 966 Chamber No. 4.
2. Tested Date: 2023/10/13

4.7 Unwanted Emissions above 1 GHz

Description Manufacturer	Model No.	Serial No.	Calibrated Date	Calibrated Until
Boresight Antenna Tower & Turn Table Max-Full	MF-7802BS	MF780208530	N/A	N/A
Horn Antenna Schwarzbeck	BBHA 9120D	9120D-783	2022/11/13	2023/11/12
	BBHA 9170	9170-739	2022/11/13	2023/11/12
MXA Signal Analyzer Keysight	N9020B	MY60112408	2023/3/6	2024/3/5
Preamplifier EMCI	EMC12630SE	980688	2022/10/4	2023/10/3
	EMC184045SE	980387	2023/8/9	2024/8/8
RF Coaxial Cable EMCI	EMC-KM-KM-4000	200214	2023/2/20	2024/2/19
	EMC102-KM-KM-1200	160924	2023/8/9	2024/8/8
	EMC104-SM-SM-1200	160922	2023/8/9	2024/8/8
	EMC104-SM-SM-2000	180502	2023/3/27	2024/3/26
	EMC104-SM-SM-6000	210704	2022/11/4	2023/11/3
Software	ADT_Radiated_V8.7.08	N/A	N/A	N/A

Notes:

1. The test was performed in 966 Chamber No. 4.
2. Tested Date: 2023/8/30 ~ 2023/9/29

5 Limits of Test Items

5.1 RF Output Power

For systems using digital modulation in the 2400–2483.5 MHz bands: 1 Watt (30 dBm)

Per KDB 662911 D01 Multiple Transmitter Output Method of conducted output power measurement on IEEE 802.11 devices,

Array Gain = 0 dB (i.e., no array gain) for $N_{ANT} \leq 4$;

Array Gain = 0 dB (i.e., no array gain) for channel widths ≥ 40 MHz for any N_{ANT} ;

Array Gain = $5 \log(N_{ANT}/N_{SS})$ dB or 3 dB, whichever is less, for 20-MHz channel widths with $N_{ANT} \geq 5$.

For power measurements on all other devices: Array Gain = $10 \log(N_{ANT}/N_{SS})$ dB.

5.2 Power Spectral Density

The Maximum of Power Spectral Density Measurement is 8 dBm in any 3 kHz.

5.3 6 dB Bandwidth

The minimum of 6 dB Bandwidth Measurement is 0.5 MHz.

5.4 Conducted Out of Band Emissions

Below 30 dB of the highest emission level of operating band (in 100 kHz Resolution Bandwidth).

5.5 AC Power Conducted Emissions

Frequency (MHz)	Conducted Limit (dBuV)	
	Quasi-peak	Average
0.15 - 0.5	66 - 56	56 - 46
0.50 - 5.0	56	46
5.0 - 30.0	60	50

Notes:

1. The lower limit shall apply at the transition frequencies.
2. The limit decreases in line with the logarithm of the frequency in the range of 0.15 to 0.50 MHz.

5.6 Unwanted Emissions below 1 GHz

Radiated emissions up to 1 GHz which fall in the restricted bands must comply with the radiated emission limits specified as below table. Other emissions shall be at least 30 dB below the highest level of the desired power:

Frequencies (MHz)	Field Strength (microvolts/meter)	Measurement Distance (meters)
0.009 ~ 0.490	2400/F(kHz)	300
0.490 ~ 1.705	24000/F(kHz)	30
1.705 ~ 30.0	30	30
30 ~ 88	100	3
88 ~ 216	150	3
216 ~ 960	200	3
Above 960	500	3

Notes:

1. The lower limit shall apply at the transition frequencies.
2. Emission level (dBuV/m) = 20 log Emission level (uV/m).

5.7 Unwanted Emissions above 1 GHz

Radiated emissions above 1 GHz which fall in the restricted bands must comply with the radiated emission limits specified as below table. Other emissions shall be at least 30 dB below the highest level of the desired power:

Frequencies (MHz)	Field Strength (microvolts/meter)	Measurement Distance (meters)
Above 960	500	3

Notes:

1. The lower limit shall apply at the transition frequencies.
2. Emission level (dBuV/m) = 20 log Emission level (uV/m).
3. For frequencies above 1000 MHz, the field strength limits are based on average detector, however, the peak field strength of any emission shall not exceed the maximum permitted average limits, specified above by more than 20 dB under any condition of modulation.

6 Test Arrangements

6.1 RF Output Power

6.1.1 Test Setup

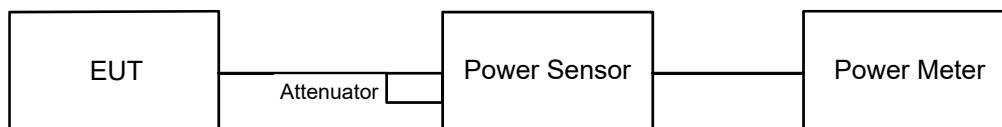

6.1.2 Test Procedure

Average Power:

Average power sensor was used to perform output power measurement, trigger and gating function of wide band power meter is enabled to measure max output power of TX on burst. Duty factor is not added to measured value.

6.2 Power Spectral Density

6.2.1 Test Setup

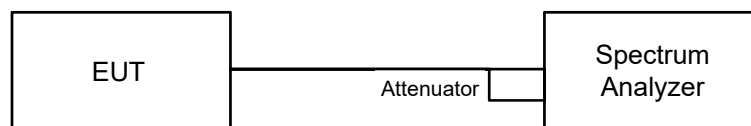

6.2.2 Test Procedure

- a. Measure the duty cycle (x).
- b. Set instrument center frequency to DTS channel center frequency.
- c. Set span to at least 1.5 times the OBW.
- d. Set RBW to: 3 kHz.
- e. Set VBW $\geq 3 \times$ RBW.
- f. Detector = power averaging (RMS) or sample detector (when RMS not available).
- g. Ensure that the number of measurement points in the sweep $\geq 2 \times$ span/RBW.
- h. Sweep time = auto couple.
- i. Do not use sweep triggering. Allow sweep to "free run".
- j. Employ trace averaging (RMS) mode over a minimum of 100 traces.
- k. Use the peak marker function to determine the maximum amplitude level.

Note: If Duty cycle < 98%, Add $10 \log (1/x)$, where x is the duty cycle measured in step (a), to the measured PSD to compute the average PSD during the actual transmission time.

6.3 6 dB Bandwidth

6.3.1 Test Setup

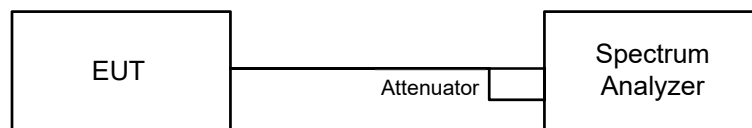

6.3.2 Test Procedure

- Set resolution bandwidth (RBW) = 100 kHz.
- Set the video bandwidth (VBW) $\geq 3 \times$ RBW, Detector = Peak.
- Trace mode = max hold.
- Sweep = auto couple.
- Measure the maximum width of the emission that is constrained by the frequencies associated with the two amplitude points (upper and lower) that are attenuated by 6 dB relative to the maximum level measured in the fundamental emission.

6.4 Conducted Out of Band Emissions

6.4.1 Test Setup

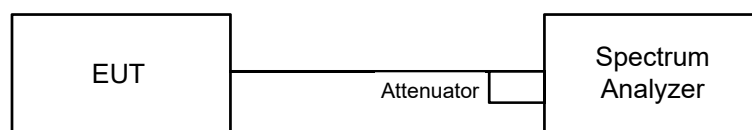

6.4.2 Test Procedure

MEASUREMENT PROCEDURE REF

- Set the RBW = 100 kHz.
- Set the VBW ≥ 300 kHz.
- Detector = peak.
- Sweep time = auto couple.
- Trace mode = max hold.
- Allow trace to fully stabilize.
- Use the peak marker function to determine the maximum power level in any 100 kHz band segment within the fundamental EBW.

MEASUREMENT PROCEDURE OOB

- Set RBW = 100 kHz.
- Set VBW ≥ 300 kHz.
- Detector = peak.
- Sweep = auto couple.
- Trace Mode = max hold.
- Allow trace to fully stabilize.
- Use the peak marker function to determine the maximum amplitude level.

6.5 AC Power Conducted Emissions

6.5.1 Test Setup

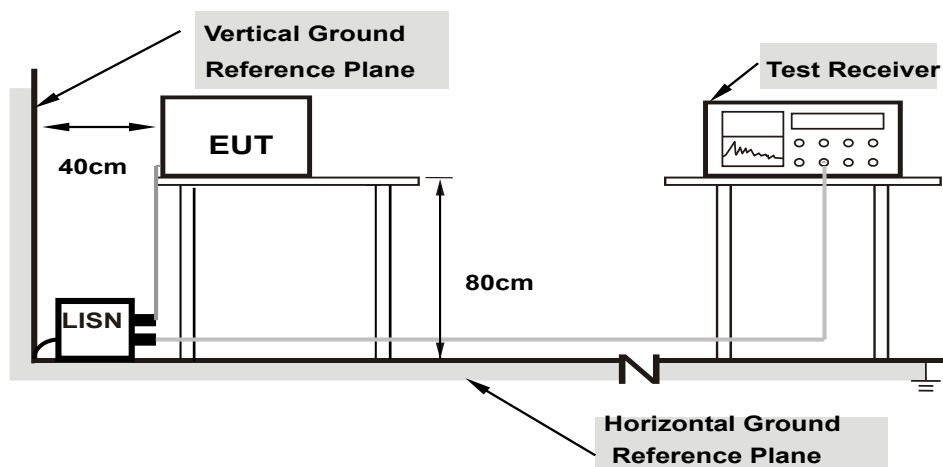

Note: 1.Support units were connected to second LISN.

For the actual test configuration, please refer to the attached file (Test Setup Photo).

6.5.2 Test Procedure

- The EUT was placed on a 0.8 meter to the top of table and placed 0.4 meters from the conducting wall of the shielded room with EUT being connected to the power mains through a line impedance stabilization network (LISN). Other support units were connected to the power mains through another LISN. The two LISNs provide 50 ohm/ 50 uH of coupling impedance for the measuring instrument.
- Both lines of the power mains connected to the EUT were checked for maximum conducted interference.
- The frequency range from 150 kHz to 30 MHz was searched. Emission levels under (Limit – 20 dB) was not recorded.

Note: The resolution bandwidth and video bandwidth of test receiver is 9 kHz for quasi-peak detection (QP) and average detection (AV) at frequency 0.15 MHz-30 MHz.

6.6 Unwanted Emissions below 1 GHz

6.6.1 Test Setup

For Radiated emission below 30 MHz

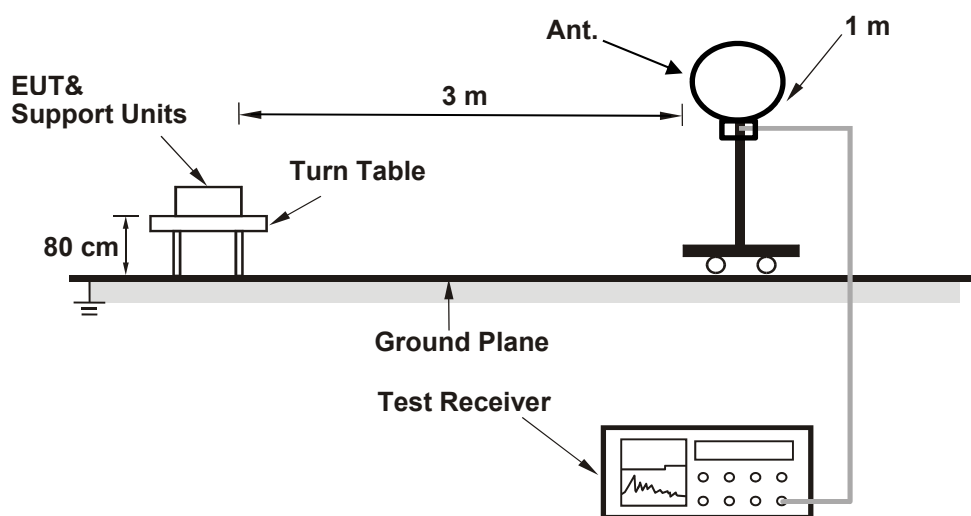

For Radiated emission above 30 MHz

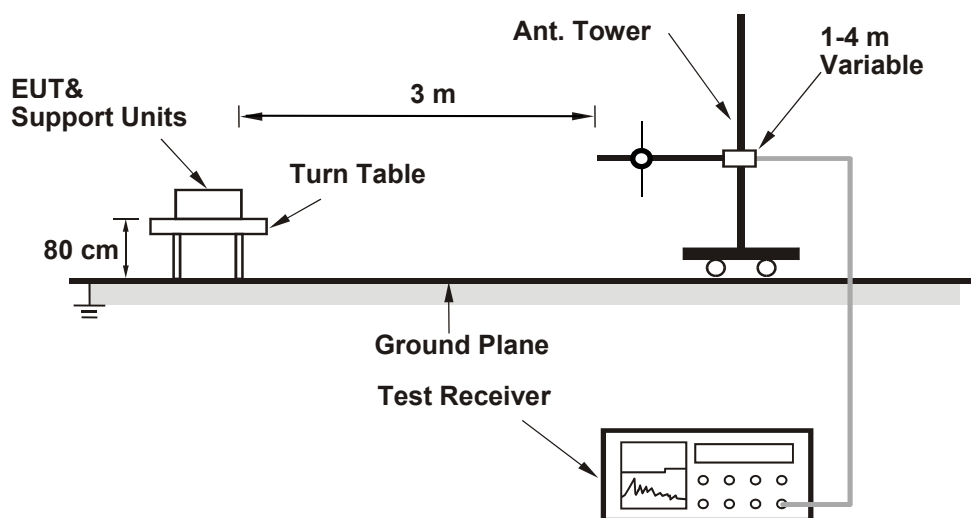

For the actual test configuration, please refer to the attached file (Test Setup Photo).

6.6.2 Test Procedure

For Radiated emission below 30 MHz

- a. The EUT was placed on the top of a rotating table 0.8 meters above the ground at 3 meter chamber room for test. The table was rotated 360 degrees to determine the position of the highest radiation.
- b. The EUT was set 3 meters away from the interference-receiving antenna, which was mounted on the top of a variable-height antenna tower.
- c. Parallel, perpendicular, and ground-parallel orientations of the antenna are set to make the measurement.
- d. For each suspected emission, the EUT was arranged to its worst case and the rotatable table was turned from 0 degrees to 360 degrees to find the maximum reading.
- e. The test-receiver system was set to Quasi-Peak Detect Function and Specified Bandwidth with Maximum Hold Mode, except for the frequency band (9 kHz to 90 kHz and 110 kHz to 490 kHz) set to average detect function and peak detect function.

Notes:

1. The resolution bandwidth and video bandwidth of test receiver/spectrum analyzer is 200 Hz at frequency below 150 kHz.
2. The resolution bandwidth and video bandwidth of test receiver/spectrum analyzer is 9 kHz or 10 kHz at frequency (150 kHz to 30 MHz).
3. All modes of operation were investigated and the worst-case emissions are reported.

For Radiated emission above 30 MHz

- a. The EUT was placed on the top of a rotating table 0.8 meters above the ground at 3 meter chamber room for test. The table was rotated 360 degrees to determine the position of the highest radiation.
- b. The EUT was set 3 meters away from the interference-receiving antenna, which was mounted on the top of a variable-height antenna tower.
- c. The height of antenna is varied from one meter to four meters above the ground to determine the maximum value of the field strength. Both horizontal and vertical polarizations of the antenna are set to make the measurement.
- d. For each suspected emission, the EUT was arranged to its worst case and then the antenna was tuned to heights from 1 meter to 4 meters and the rotatable table was turned from 0 degrees to 360 degrees to find the maximum reading.
- e. The test-receiver system was set to quasi-peak detect function and specified bandwidth with maximum hold mode when the test frequency is below 1 GHz.

Notes:

1. The resolution bandwidth and video bandwidth of test receiver/spectrum analyzer is 120 kHz for Quasi-peak detection (QP) at frequency below 1 GHz.
2. All modes of operation were investigated and the worst-case emissions are reported.

6.7 Unwanted Emissions above 1 GHz

6.7.1 Test Setup

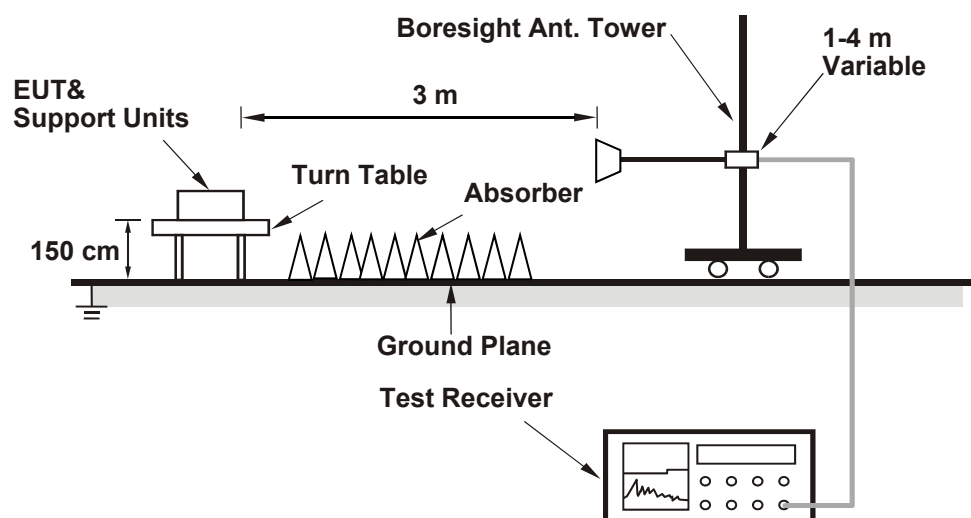

For the actual test configuration, please refer to the attached file (Test Setup Photo).

6.7.2 Test Procedure

- The EUT was placed on the top of a rotating table 1.5 meters above the ground at 3 meter chamber room for test. The table was rotated 360 degrees to determine the position of the highest radiation.
- The EUT was set 3 meters away from the interference-receiving antenna, which was mounted on the top of a variable-height antenna tower.
- The height of antenna is varied from one meter to four meters above the ground to determine the maximum value of the field strength. Both horizontal and vertical polarizations of the antenna are set to make the measurement.
- For each suspected emission, the EUT was arranged to its worst case and then the antenna was tuned to heights from 1 meter to 4 meters and the rotatable table was turned from 0 degrees to 360 degrees to find the maximum reading.
- The test-receiver system was set to peak and average detects function and specified bandwidth with maximum hold mode when the test frequency is above 1 GHz. If the peak reading value also meets average limit, measurement with the average detector is unnecessary.

Notes:

- The resolution bandwidth of test receiver/spectrum analyzer is 1 MHz and the video bandwidth is 3 MHz for Peak detection (PK) and Average detection (AV) at frequency above 1 GHz.
- For fundamental and harmonic signal measurement, the resolution bandwidth of test receiver/spectrum analyzer is 1 MHz and the video bandwidth is $\geq 1/T$ (Duty cycle $< 98\%$) or 10 Hz (Duty cycle $\geq 98\%$) for Average detection (AV) at frequency above 1 GHz.
- All modes of operation were investigated and the worst-case emissions are reported.

7 Test Results of Test Item

7.1 RF Output Power

Input Power:	120 Vac, 60 Hz	Environmental Conditions:	25°C, 60% RH	Tested By:	Kevin Ko
--------------	----------------	---------------------------	--------------	------------	----------

802.11b CDD

Chan.	Chan. Freq. (MHz)	Average Power (dBm)				Total Power (mW)	Total Power (dBm)	Power Limit (dBm)	Test Result
		Chain 0	Chain 1	Chain 2	Chain 3				
1	2412	24.01	24.07	23.90	23.64	983.715	29.93	30	Pass
6	2437	24.07	23.88	23.80	24.05	993.594	29.97	30	Pass
11	2462	22.52	22.76	22.31	22.17	702.48	28.47	30	Pass

Notes:

1. Directional gain is the maximum gain of antennas.
2. The maximum gain is 4.89 dBi < 6 dBi, so the output power limit shall not be reduced.

802.11g CDD

Chan.	Chan. Freq. (MHz)	Average Power (dBm)				Total Power (mW)	Total Power (dBm)	Power Limit (dBm)	Test Result
		Chain 0	Chain 1	Chain 2	Chain 3				
1	2412	23.74	23.24	23.51	23.72	907.348	29.58	30	Pass
6	2437	24.50	23.50	24.04	23.52	984.129	29.93	30	Pass
11	2462	23.75	23.35	23.83	23.76	932.639	29.70	30	Pass

Notes:

1. Directional gain is the maximum gain of antennas.
2. The maximum gain is 4.89 dBi < 6 dBi, so the output power limit shall not be reduced.

VHT20 CDD

Chan.	Chan. Freq. (MHz)	Average Power (dBm)				Total Power (mW)	Total Power (dBm)	Power Limit (dBm)	Test Result
		Chain 0	Chain 1	Chain 2	Chain 3				
1	2412	23.65	23.00	23.44	23.46	873.886	29.41	30	Pass
6	2437	24.38	23.21	23.85	23.24	937.092	29.72	30	Pass
11	2462	23.49	22.95	23.41	23.48	862.724	29.36	30	Pass

Notes:

1. Directional gain is the maximum gain of antennas.
2. The maximum gain is 4.89 dBi < 6 dBi, so the output power limit shall not be reduced.

VHT40 CDD

Chan.	Chan. Freq. (MHz)	Average Power (dBm)				Total Power (mW)	Total Power (dBm)	Power Limit (dBm)	Test Result
		Chain 0	Chain 1	Chain 2	Chain 3				
3	2422	23.22	22.39	22.86	22.55	756.358	28.79	30	Pass
6	2437	24.15	23.33	23.86	23.48	941.358	29.74	30	Pass
9	2452	22.54	21.97	22.37	22.10	671.636	28.27	30	Pass

Notes:

1. Directional gain is the maximum gain of antennas.
2. The maximum gain is 4.89 dBi < 6 dBi, so the output power limit shall not be reduced.

802.11ax (HE20) CDD

Chan.	Chan. Freq. (MHz)	Average Power (dBm)				Total Power (mW)	Total Power (dBm)	Power Limit (dBm)	Test Result
		Chain 0	Chain 1	Chain 2	Chain 3				
1	2412	23.92	23.28	23.65	23.68	924.503	29.66	30	Pass
6	2437	24.63	23.42	24.06	23.45	986.181	29.94	30	Pass
11	2462	23.78	23.21	23.70	23.74	919.207	29.63	30	Pass

Notes:

1. Directional gain is the maximum gain of antennas.
2. The maximum gain is 4.89 dBi < 6 dBi, so the output power limit shall not be reduced.

802.11ax (HE40) CDD

Chan.	Chan. Freq. (MHz)	Average Power (dBm)				Total Power (mW)	Total Power (dBm)	Power Limit (dBm)	Test Result
		Chain 0	Chain 1	Chain 2	Chain 3				
3	2422	23.50	22.69	23.10	22.79	803.934	29.05	30	Pass
6	2437	24.44	23.58	24.06	23.70	995.111	29.98	30	Pass
9	2452	22.76	22.23	22.60	22.35	709.669	28.51	30	Pass

Notes:

1. Directional gain is the maximum gain of antennas.
2. The maximum gain is 4.89 dBi < 6 dBi, so the output power limit shall not be reduced.

VHT20 Beamforming

Chan.	Chan. Freq. (MHz)	Average Power (dBm)				Total Power (mW)	Total Power (dBm)	Power Limit (dBm)	Test Result
		Chain 0	Chain 1	Chain 2	Chain 3				
1	2412	22.77	22.09	22.35	22.35	694.624	28.42	28.83	Pass
6	2437	23.15	21.98	22.72	22.07	712.432	28.53	28.83	Pass
11	2462	22.57	21.98	22.39	22.41	686.04	28.36	28.83	Pass

Notes:

1. Directional gain is the measured value according to KDB 662911 D03 Method of MIMO Antenna Gain Measurement.
2. The directional gain is 7.17 dBi > 6 dBi, so the output power limit shall be reduced to $30 - (7.17 - 6) = 28.83$ dBm.

VHT40 Beamforming

Chan.	Chan. Freq. (MHz)	Average Power (dBm)				Total Power (mW)	Total Power (dBm)	Power Limit (dBm)	Test Result
		Chain 0	Chain 1	Chain 2	Chain 3				
3	2422	22.71	21.83	22.39	22.14	676.105	28.30	28.83	Pass
6	2437	22.70	21.78	22.33	21.89	662.396	28.21	28.83	Pass
9	2452	22.54	21.97	22.37	22.10	671.636	28.27	28.83	Pass

Notes:

1. Directional gain is the measured value according to KDB 662911 D03 Method of MIMO Antenna Gain Measurement.
2. The directional gain is 7.17 dBi > 6 dBi, so the output power limit shall be reduced to $30-(7.17-6) = 28.83$ dBm.

802.11ax (HE20) Beamforming

Chan.	Chan. Freq. (MHz)	Average Power (dBm)				Total Power (mW)	Total Power (dBm)	Power Limit (dBm)	Test Result
		Chain 0	Chain 1	Chain 2	Chain 3				
1	2412	23.01	22.32	22.64	22.63	737.48	28.68	28.83	Pass
6	2437	23.40	22.24	22.93	22.33	753.608	28.77	28.83	Pass
11	2462	22.83	22.22	22.64	22.65	726.323	28.61	28.83	Pass

Notes:

1. Directional gain is the measured value according to KDB 662911 D03 Method of MIMO Antenna Gain Measurement.
2. The directional gain is 7.17 dBi > 6 dBi, so the output power limit shall be reduced to $30-(7.17-6) = 28.83$ dBm.

802.11ax (HE40) Beamforming

Chan.	Chan. Freq. (MHz)	Average Power (dBm)				Total Power (mW)	Total Power (dBm)	Power Limit (dBm)	Test Result
		Chain 0	Chain 1	Chain 2	Chain 3				
3	2422	22.98	22.11	22.60	22.35	714.925	28.54	28.83	Pass
6	2437	22.90	22.07	22.58	22.15	701.242	28.46	28.83	Pass
9	2452	22.76	22.23	22.60	22.35	709.669	28.51	28.83	Pass

Notes:

1. Directional gain is the measured value according to KDB 662911 D03 Method of MIMO Antenna Gain Measurement.
2. The directional gain is 7.17 dBi > 6 dBi, so the output power limit shall be reduced to $30-(7.17-6) = 28.83$ dBm.

7.2 Power Spectral Density

Input Power:	120 Vac, 60 Hz	Environmental Conditions:	25°C, 60% RH	Tested By:	Kevin Ko
--------------	----------------	---------------------------	--------------	------------	----------

802.11b

Chan.	Chan. Freq. (MHz)	PSD (dBm/3kHz)				Total PSD (dBm/3kHz)	PSD Limit (dBm/3kHz)	Test Result
		Chain 0	Chain 1	Chain 2	Chain 3			
1	2412	-6.88	-7.66	-7.18	-7.23	-1.21	6.83	Pass
6	2437	-6.94	-8.37	-7.94	-7.61	-1.66	6.83	Pass
11	2462	-9.50	-10.02	-9.34	-9.19	-3.48	6.83	Pass

Notes:

1. Method E) 2) b) Measure and sum spectral maxima across the outputs of KDB 662911 is using for calculating total power density.
2. Directional gain is the measured value according to KDB 662911 D03 Method of MIMO Antenna Gain Measurement.
3. The directional gain is 7.17 dBi > 6 dBi, so the power density limit shall be reduced to $8-(7.17-6) = 6.83$ dBm/3kHz.

802.11g

Chan.	Chan. Freq. (MHz)	PSD w/o Duty Factor (dBm/3kHz)				Duty Factor (dB)	Total PSD (dBm/3kHz)	PSD Limit (dBm/3kHz)	Test Result
		Chain 0	Chain 1	Chain 2	Chain 3				
1	2412	-10.80	-10.58	-10.39	-10.42	0.17	-4.35	6.83	Pass
6	2437	-9.45	-10.80	-10.77	-10.02	0.17	-4.03	6.83	Pass
11	2462	-9.73	-10.27	-9.91	-9.91	0.17	-3.76	6.83	Pass

Notes:

1. Method E) 2) b) Measure and sum spectral maxima across the outputs of KDB 662911 is using for calculating total power density.
2. Directional gain is the measured value according to KDB 662911 D03 Method of MIMO Antenna Gain Measurement.
3. The directional gain is 7.17 dBi > 6 dBi, so the power density limit shall be reduced to $8-(7.17-6) = 6.83$ dBm/3kHz.

802.11ax (HE20)

Chan.	Chan. Freq. (MHz)	PSD (dBm/3kHz)				Total PSD (dBm/3kHz)	PSD Limit (dBm/3kHz)	Test Result
		Chain 0	Chain 1	Chain 2	Chain 3			
1	2412	-11.13	-11.46	-11.15	-11.52	-5.29	6.83	Pass
6	2437	-10.49	-11.13	-11.68	-10.91	-5.01	6.83	Pass
11	2462	-11.23	-11.39	-11.25	-11.29	-5.27	6.83	Pass

Notes:

1. Method E) 2) b) Measure and sum spectral maxima across the outputs of KDB 662911 is using for calculating total power density.
2. Directional gain is the measured value according to KDB 662911 D03 Method of MIMO Antenna Gain Measurement.
3. The directional gain is 7.17 dBi > 6 dBi, so the power density limit shall be reduced to $8-(7.17-6) = 6.83$ dBm/3kHz.

802.11ax (HE40)

Chan.	Chan. Freq. (MHz)	PSD (dBm/3kHz)				Total PSD (dBm/3kHz)	PSD Limit (dBm/3kHz)	Test Result
		Chain 0	Chain 1	Chain 2	Chain 3			
3	2422	-14.31	-15.22	-15.15	-14.79	-8.83	6.83	Pass
6	2437	-13.79	-14.50	-14.57	-14.59	-8.33	6.83	Pass
9	2452	-15.64	-15.75	-15.77	-15.57	-9.66	6.83	Pass

Notes:

1. Method E) 2) b) Measure and sum spectral maxima across the outputs of KDB 662911 is using for calculating total power density.
2. Directional gain is the measured value according to KDB 662911 D03 Method of MIMO Antenna Gain Measurement.
3. The directional gain is 7.17 dBi > 6 dBi, so the power density limit shall be reduced to $8 - (7.17 - 6) = 6.83$ dBm/3kHz.

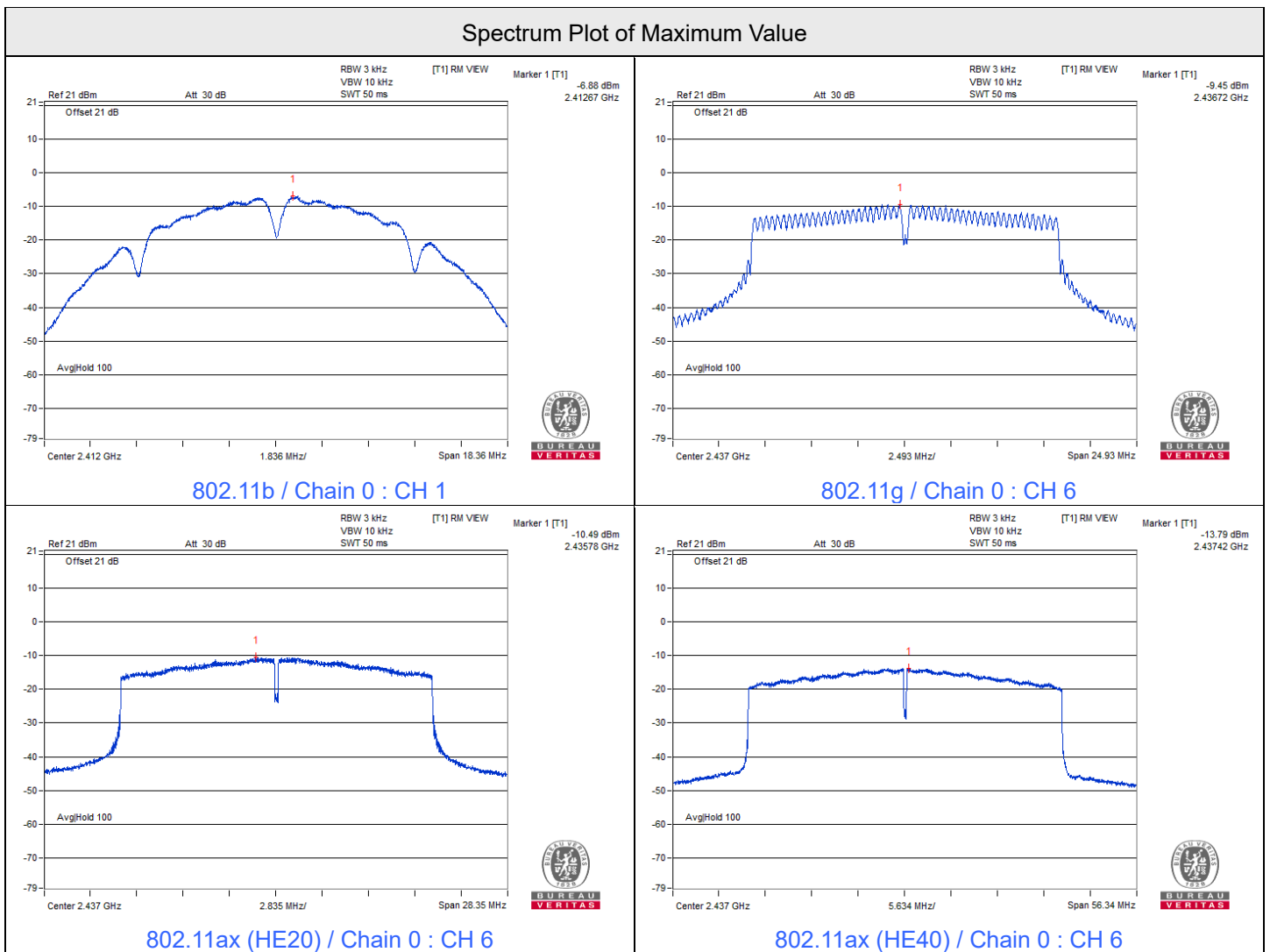

7.3 6 dB Bandwidth

Input Power:	120 Vac, 60 Hz	Environmental Conditions:	25°C, 60% RH	Tested By:	Kevin Ko
--------------	----------------	---------------------------	--------------	------------	----------

802.11b

Channel	Frequency (MHz)	6 dB Bandwidth (MHz)				Minimum Limit (MHz)	Test Result
		Chain 0	Chain 1	Chain 2	Chain 3		
1	2412	7.58	7.59	7.59	7.58	0.5	Pass
6	2437	8.06	8.08	8.06	8.05	0.5	Pass
11	2462	8.07	7.59	8.03	8.06	0.5	Pass

802.11g

Channel	Frequency (MHz)	6 dB Bandwidth (MHz)				Minimum Limit (MHz)	Test Result
		Chain 0	Chain 1	Chain 2	Chain 3		
1	2412	15.48	15.18	15.70	15.44	0.5	Pass
6	2437	15.36	15.52	15.47	15.46	0.5	Pass
11	2462	15.14	15.11	15.14	15.46	0.5	Pass

802.11ax (HE20)

Channel	Frequency (MHz)	6 dB Bandwidth (MHz)				Minimum Limit (MHz)	Test Result
		Chain 0	Chain 1	Chain 2	Chain 3		
1	2412	17.64	15.35	16.12	16.72	0.5	Pass
6	2437	17.00	15.56	16.58	15.74	0.5	Pass
11	2462	16.56	16.42	16.36	16.05	0.5	Pass

802.11ax (HE40)

Channel	Frequency (MHz)	6 dB Bandwidth (MHz)				Minimum Limit (MHz)	Test Result
		Chain 0	Chain 1	Chain 2	Chain 3		
3	2422	35.30	35.17	35.09	35.09	0.5	Pass
6	2437	35.09	35.10	36.41	35.31	0.5	Pass
9	2452	35.95	35.06	35.06	35.12	0.5	Pass



Spectrum Plot of Minimum Value

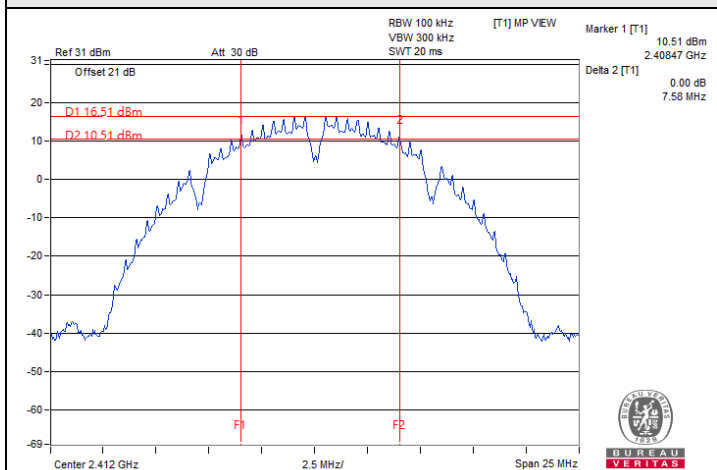

802.11b / Chain 0 : CH 1

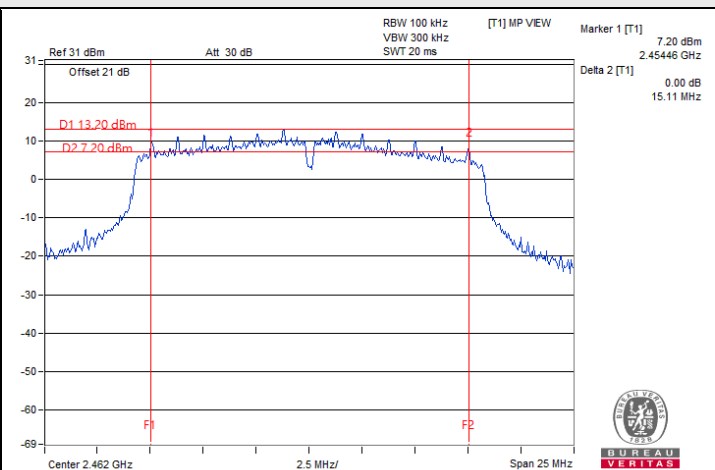

802.11g / Chain 1 : CH 11

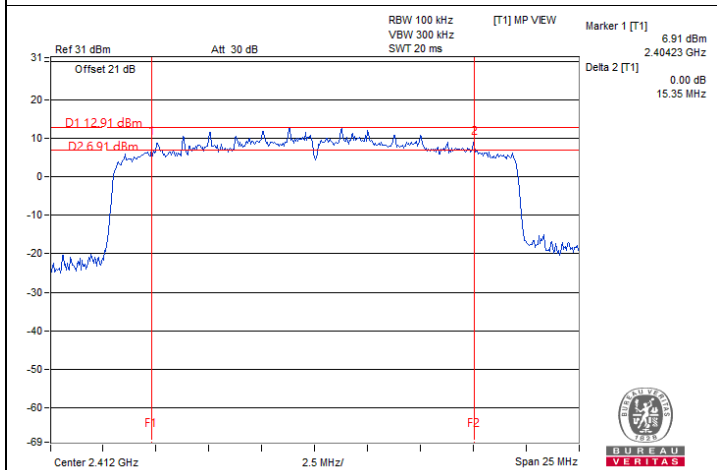

802.11ax (HE20) / Chain 1 : CH 1

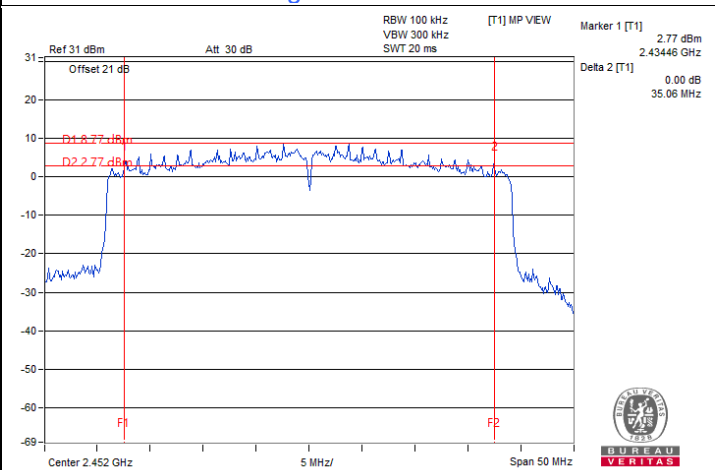

802.11ax (HE40) / Chain 1 : CH 9



7.4 Conducted Out of Band Emissions

Input Power:	120 Vac, 60 Hz	Environmental Conditions:	25°C, 60% RH	Tested By:	Kevin Ko
--------------	----------------	---------------------------	--------------	------------	----------

802.11b

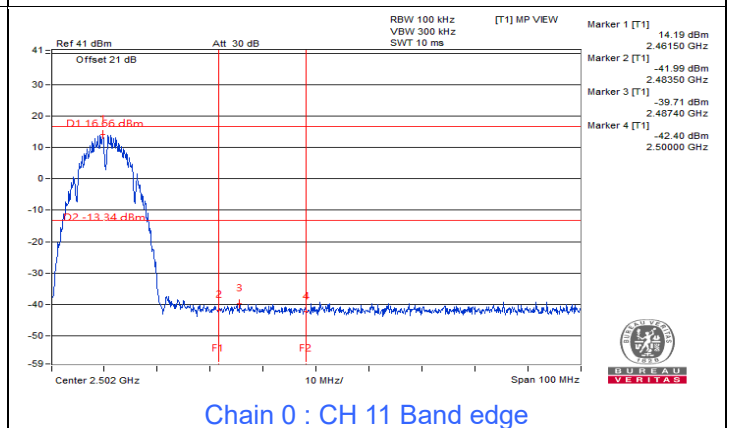
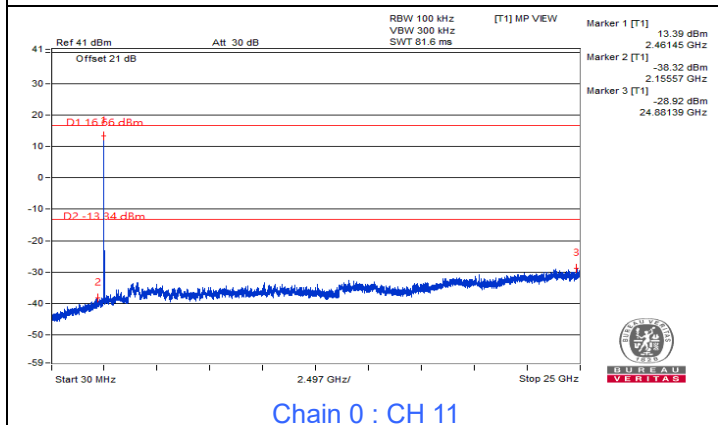
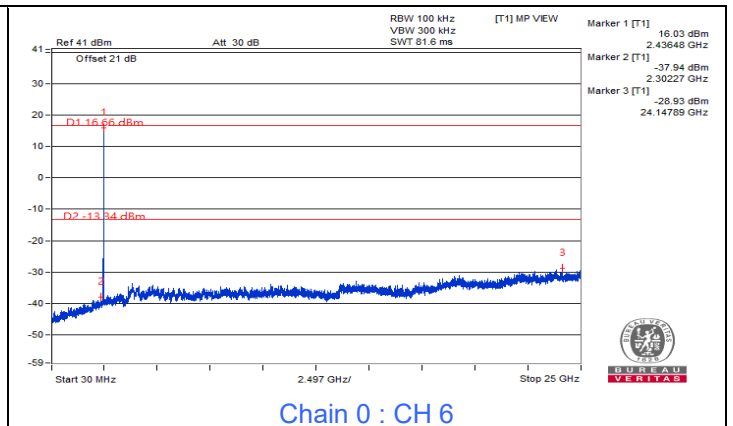
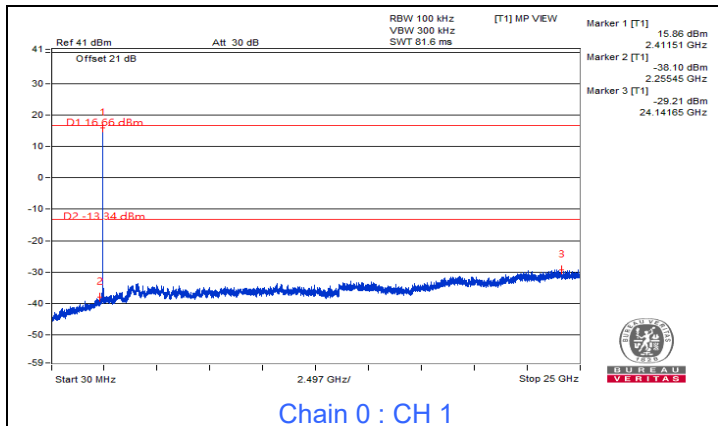
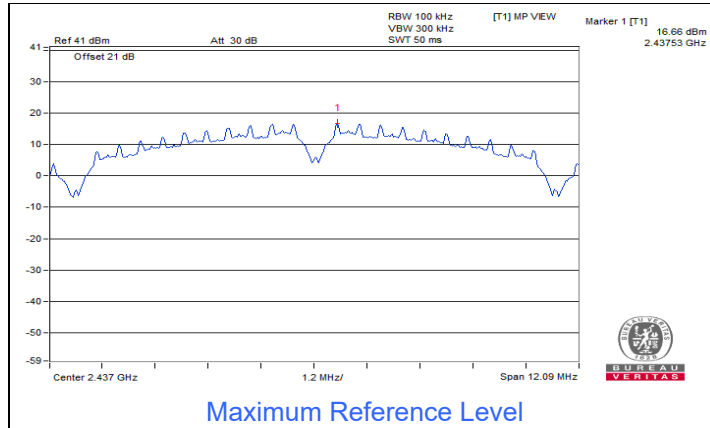

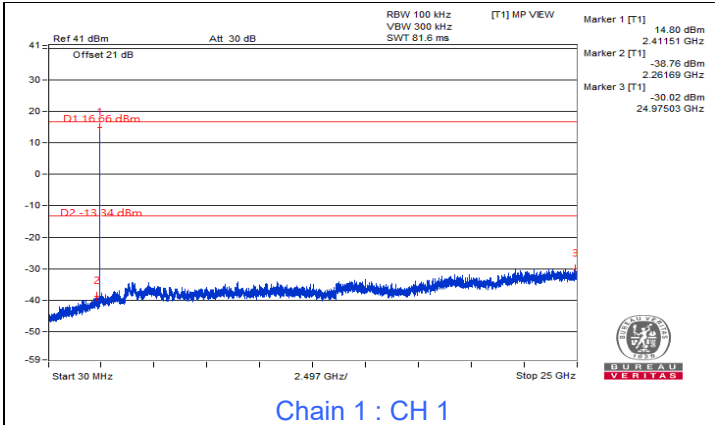

Chain 1 : CH 1

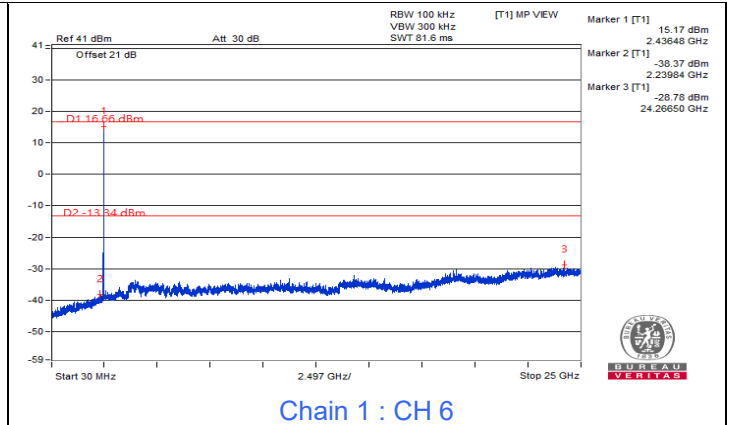

Chain 1 : CH 6

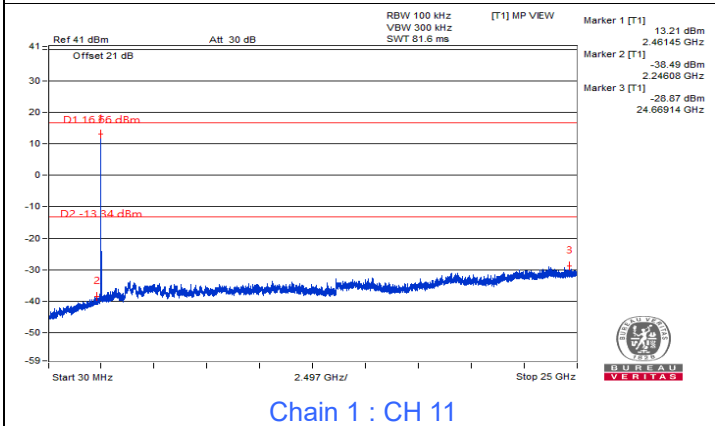

Chain 1 : CH 11

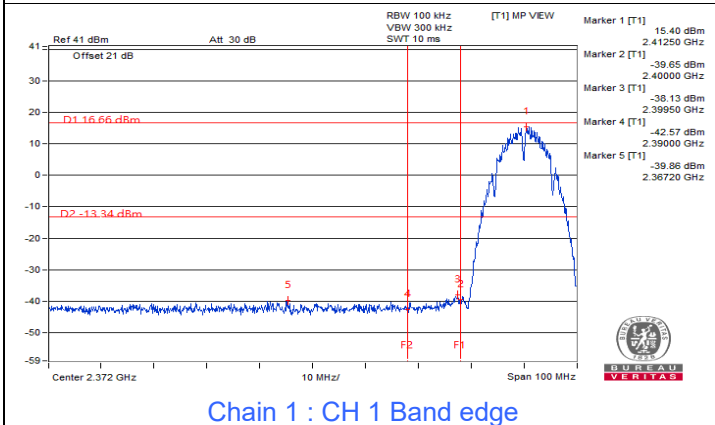

Chain 1 : CH 1 Band edge

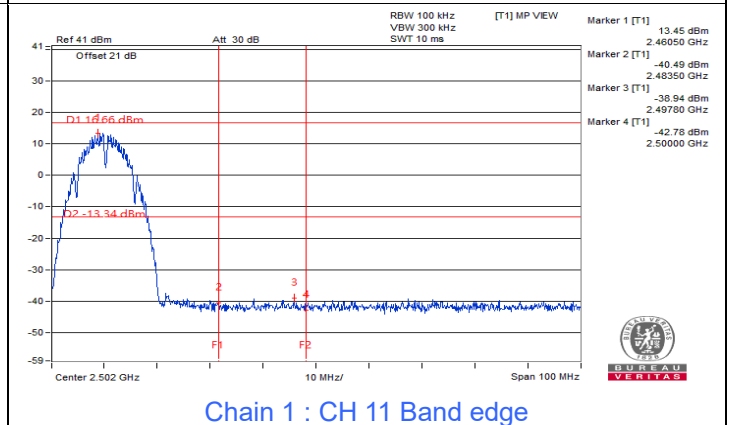

Chain 1 : CH 11 Band edge

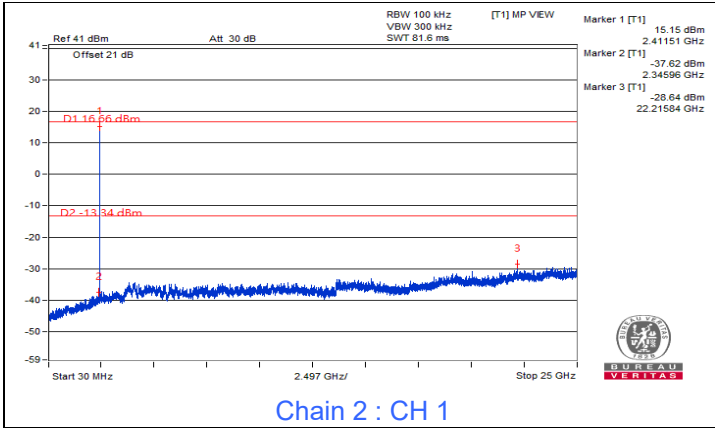

Chain 2 : CH 1

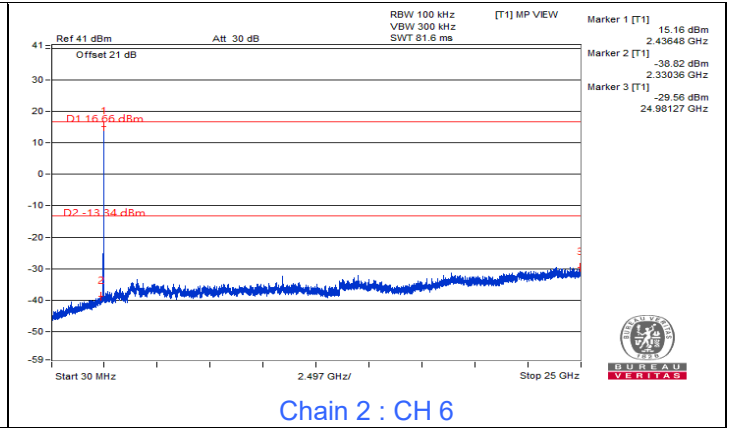

Chain 2 : CH 6

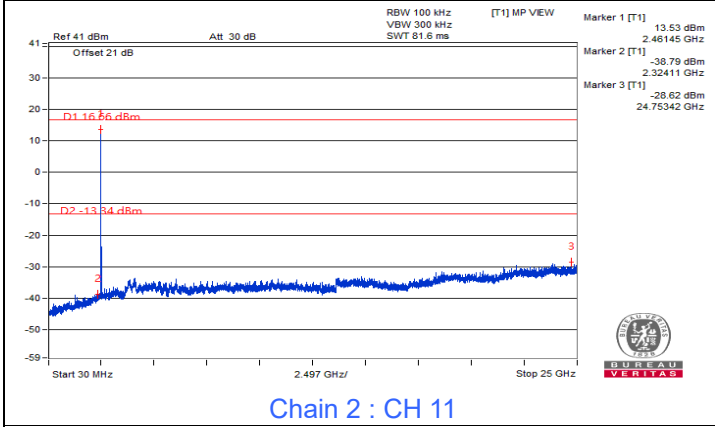

Chain 2 : CH 11



Chain 2 : CH 1 Band edge

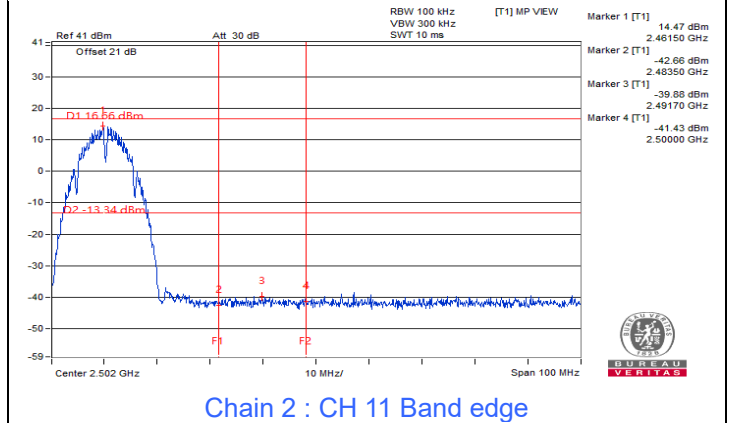

Chain 2 : CH 11 Band edge

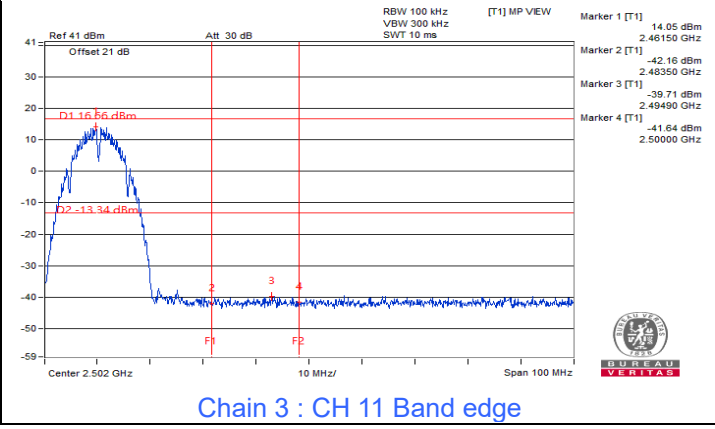
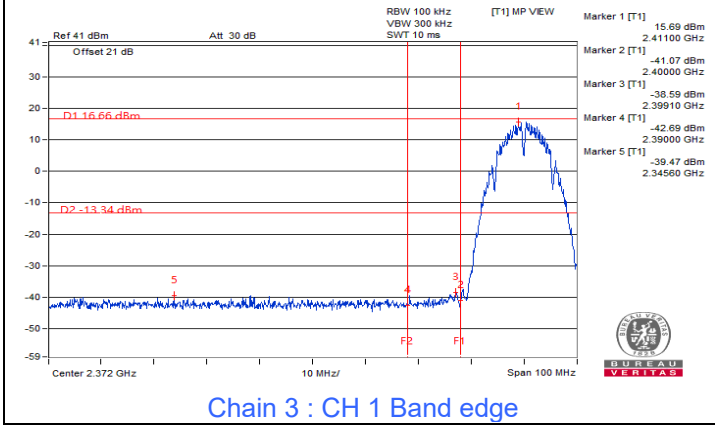
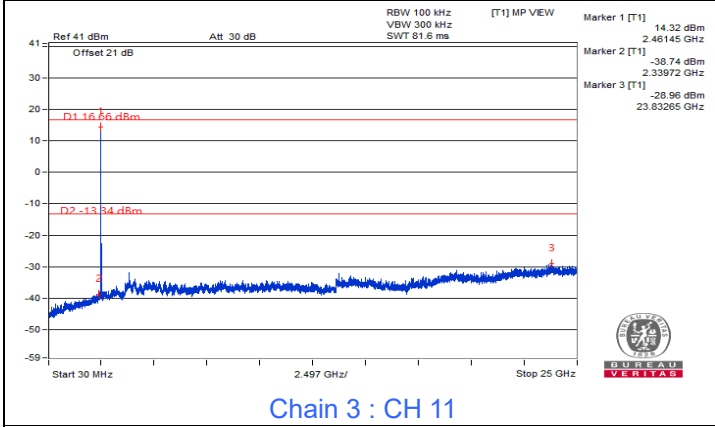
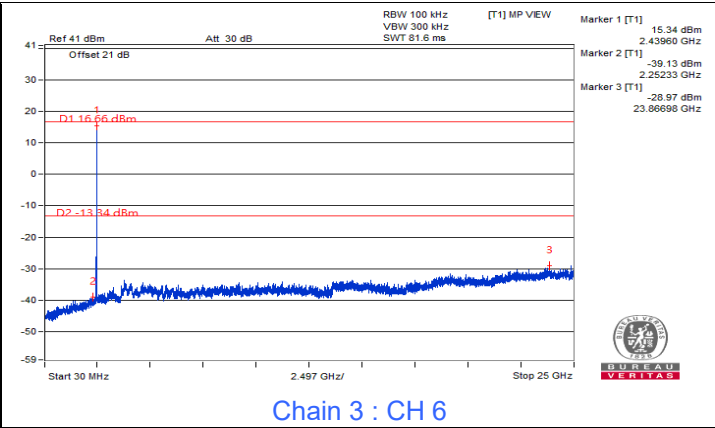
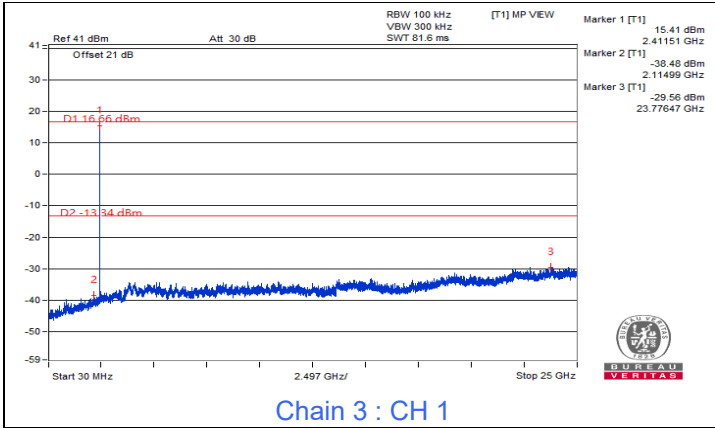

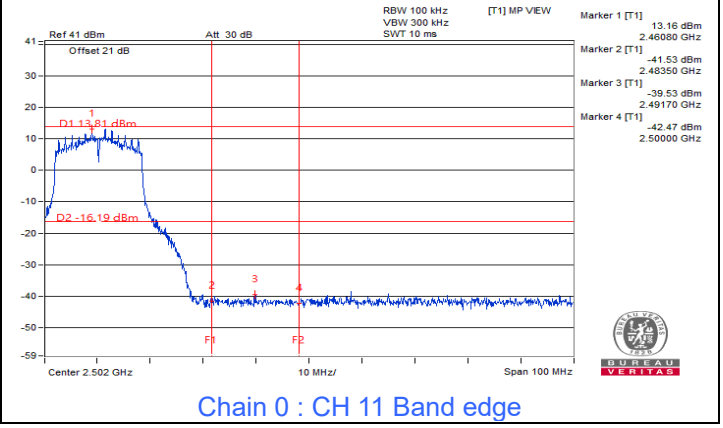
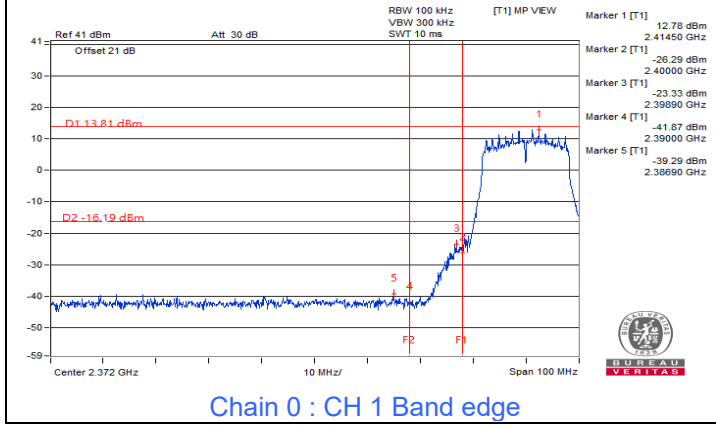
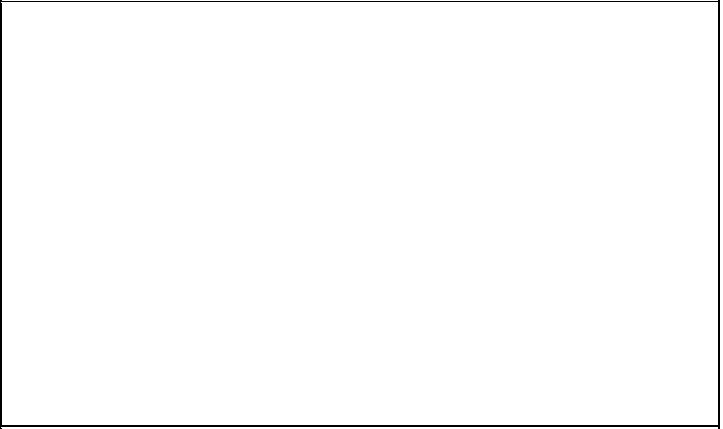
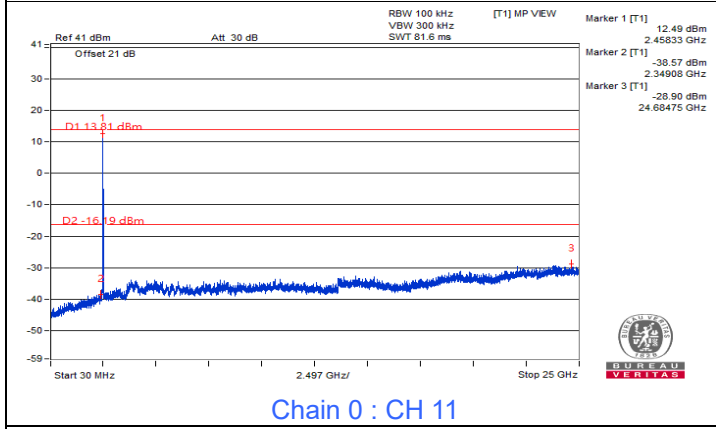
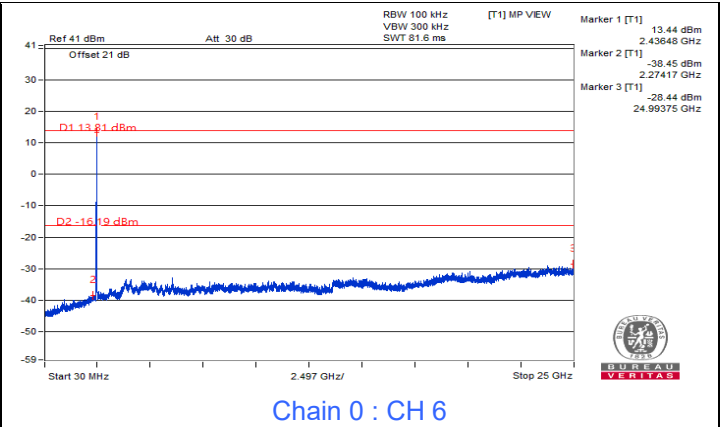
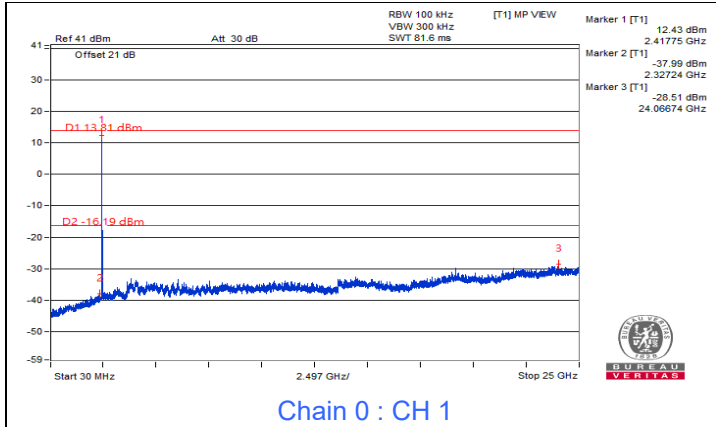
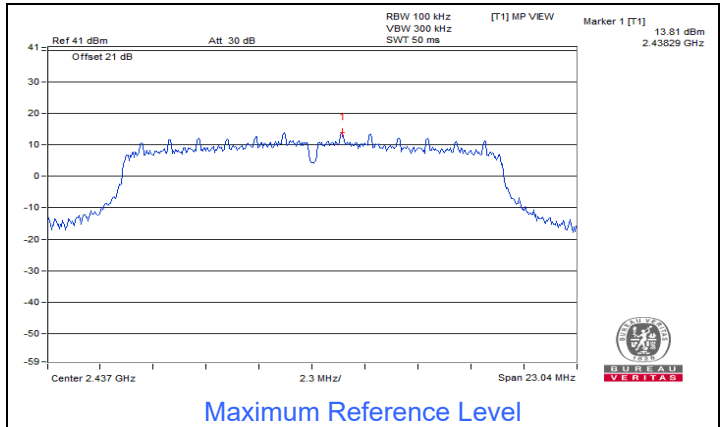

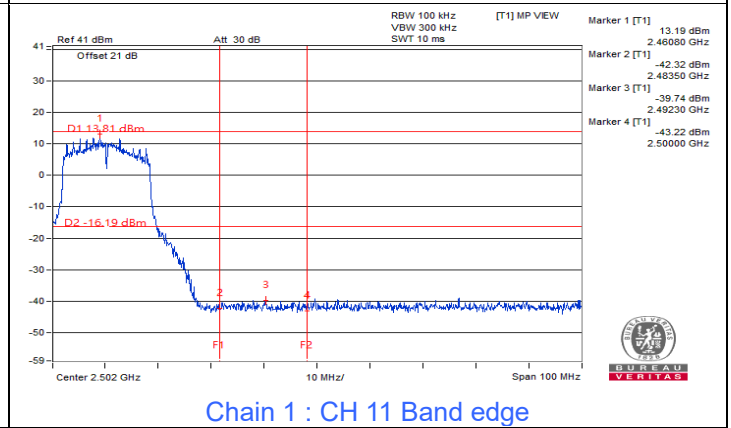
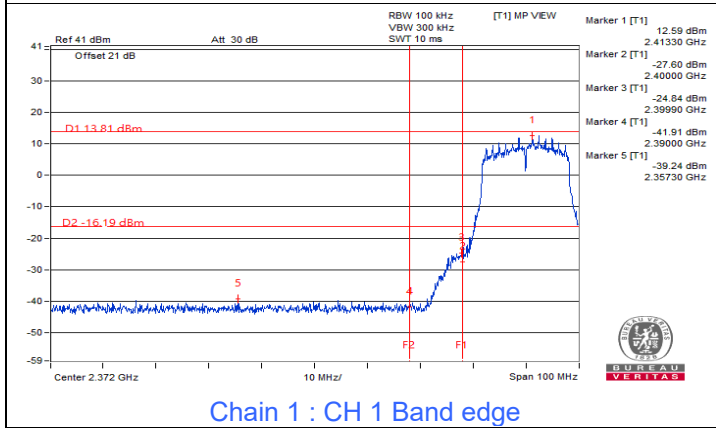
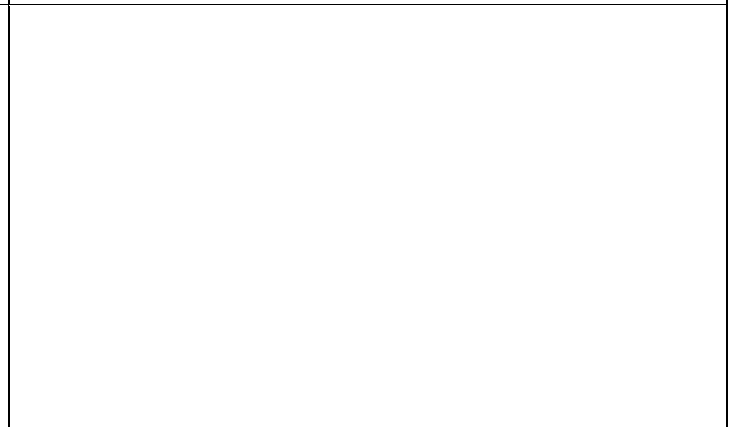
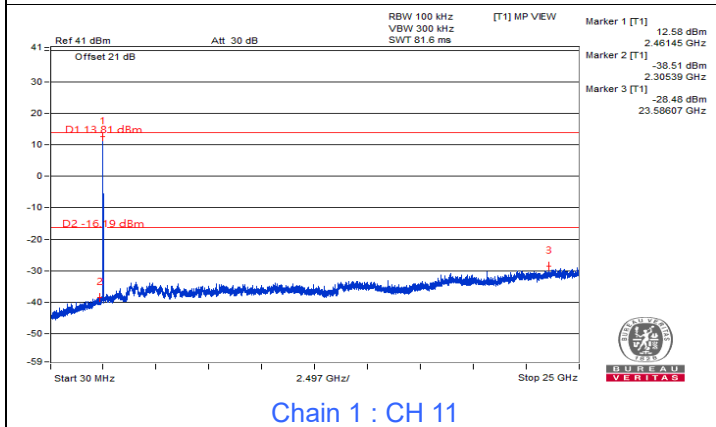
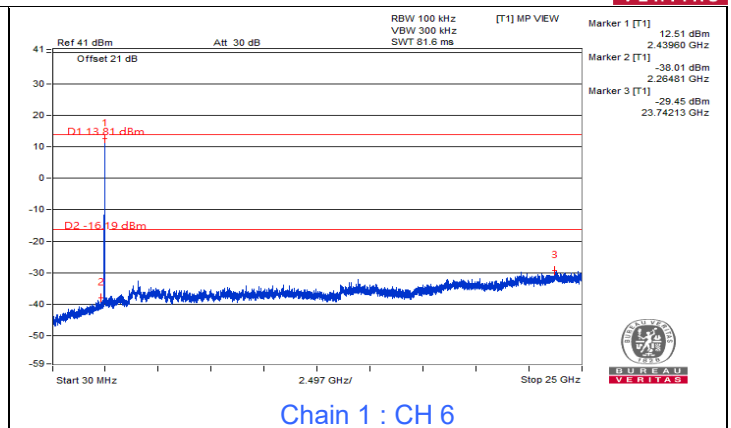
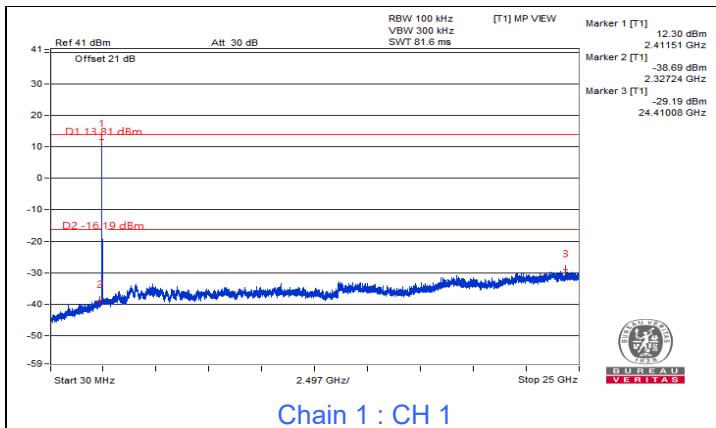

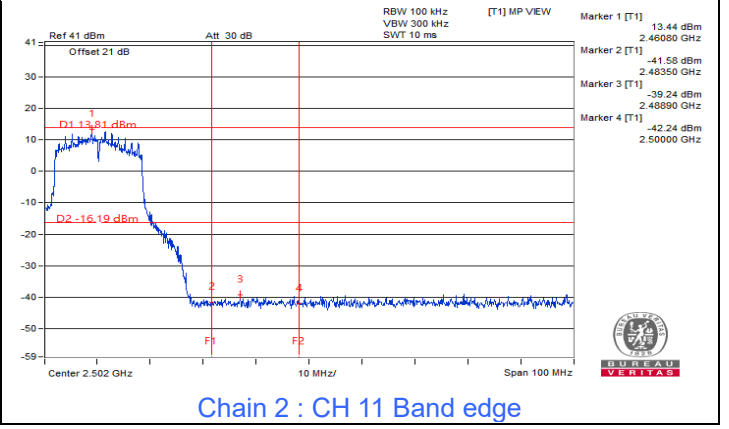
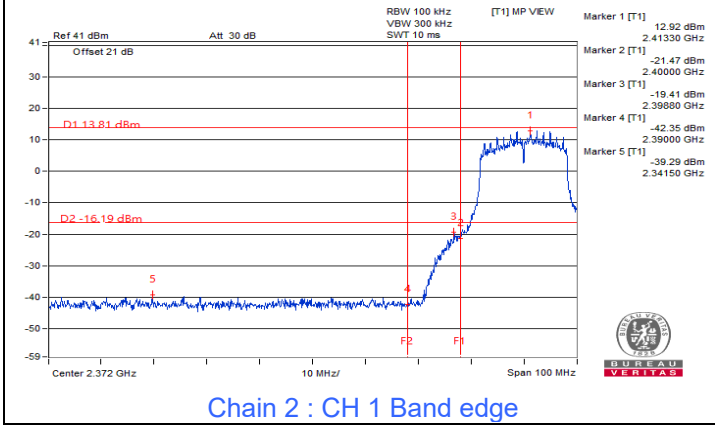
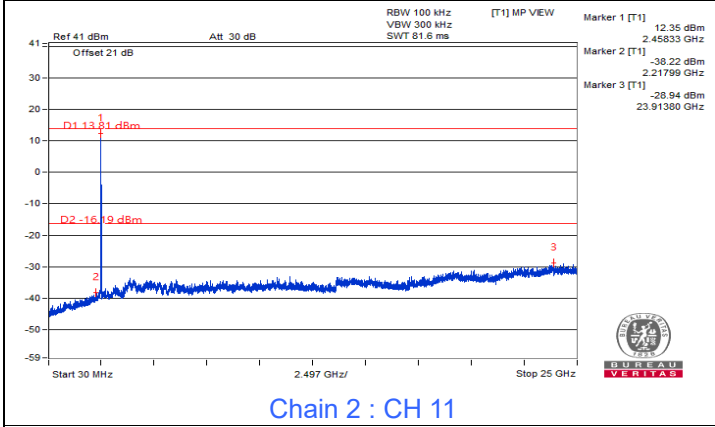
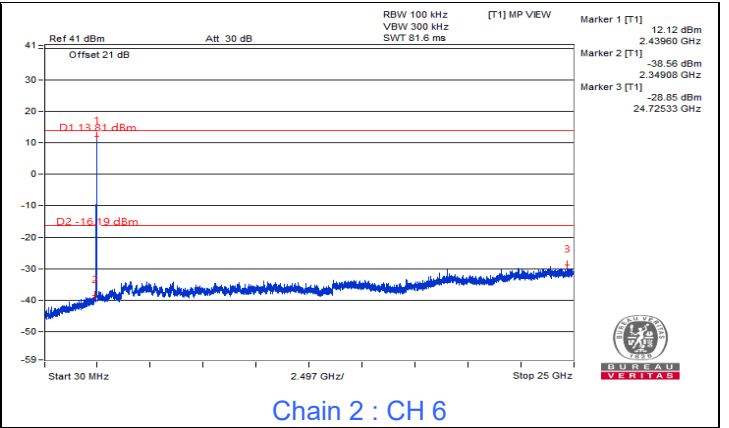
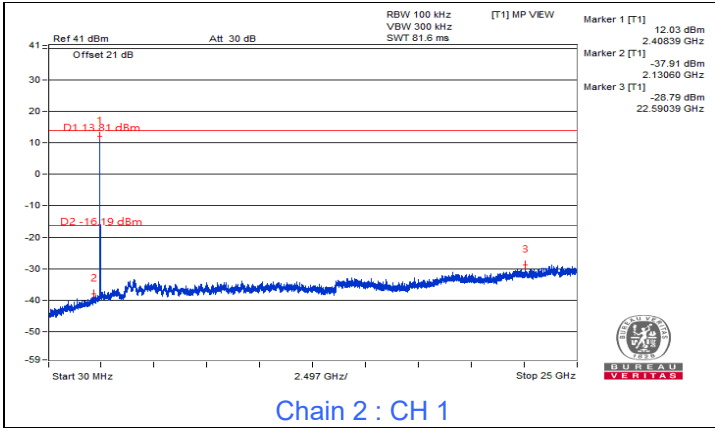

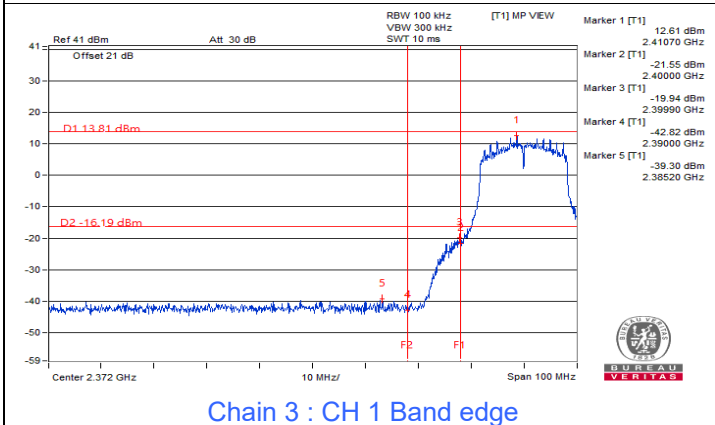
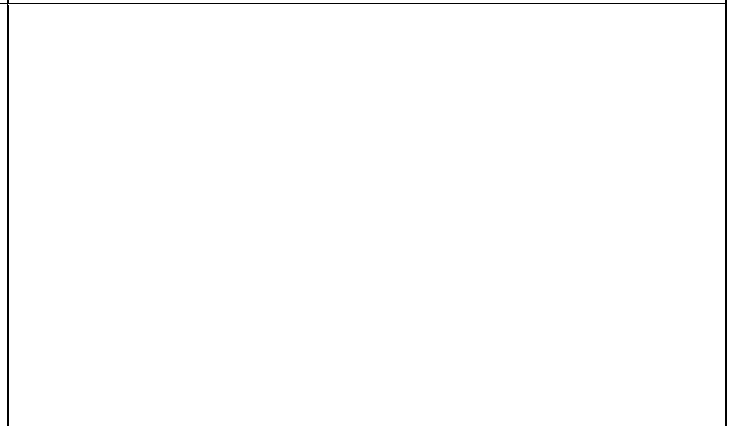
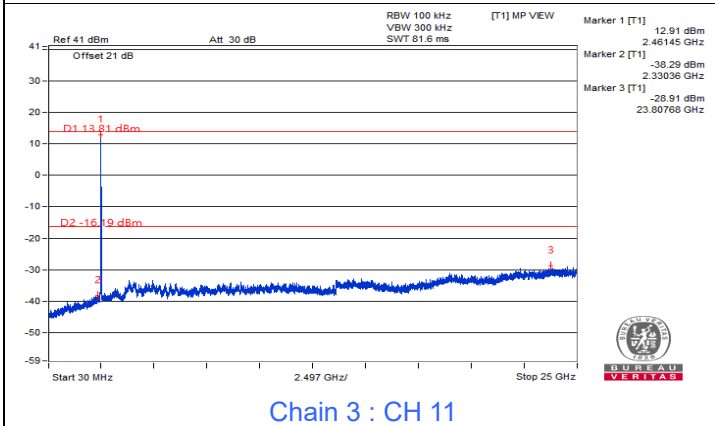
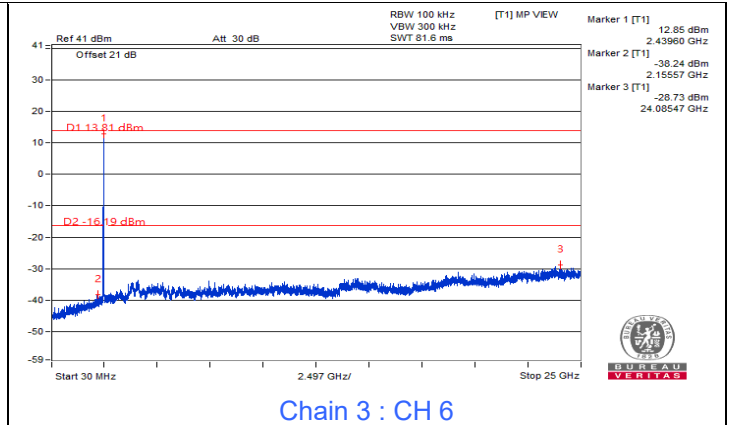
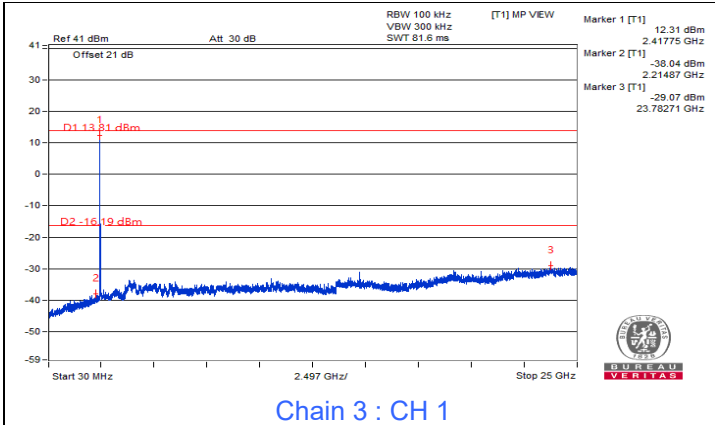

802.11ax (HE20)

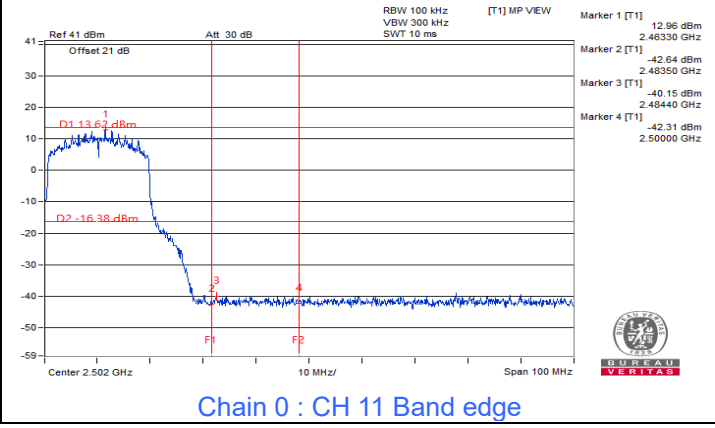
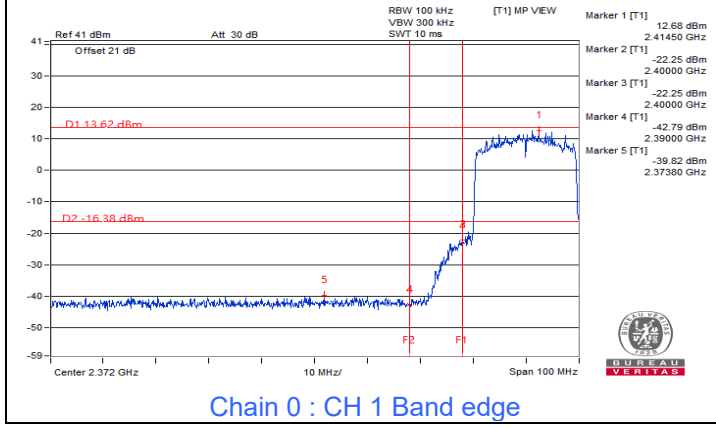
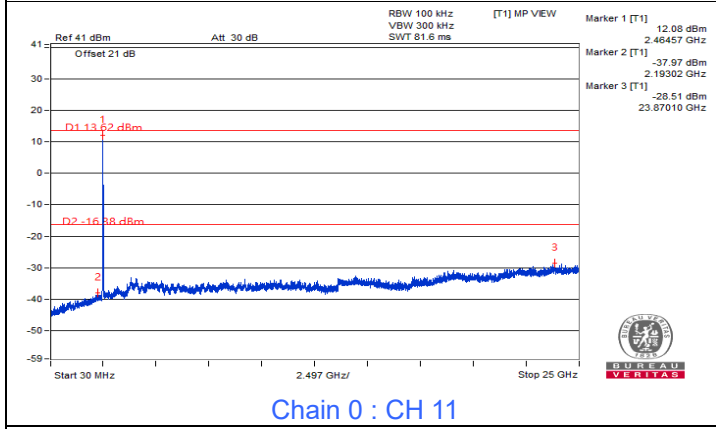
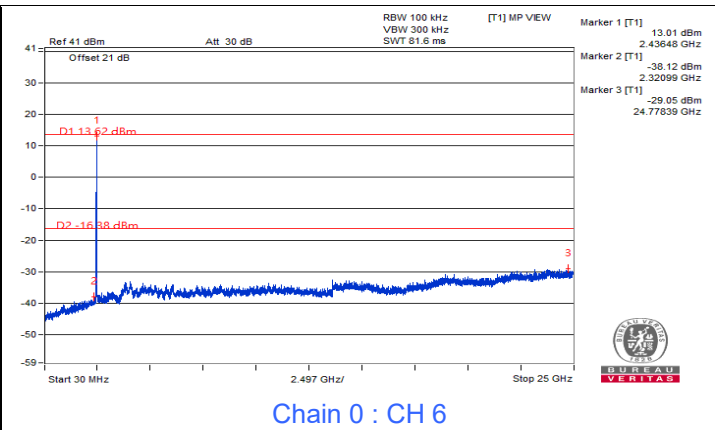
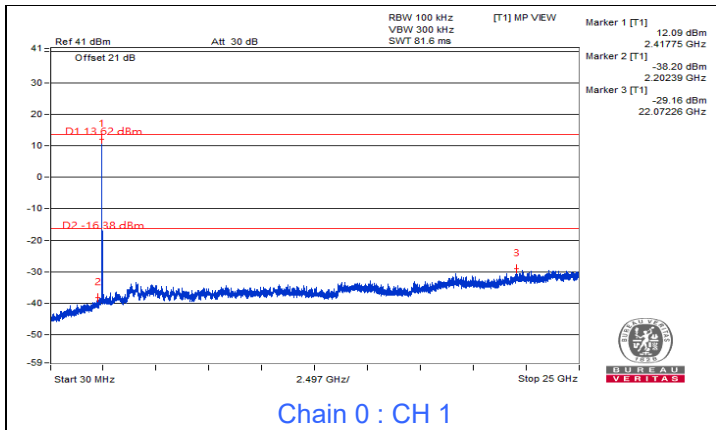
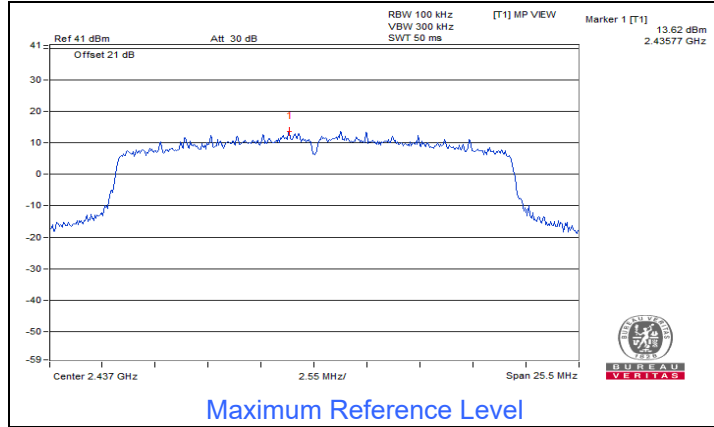

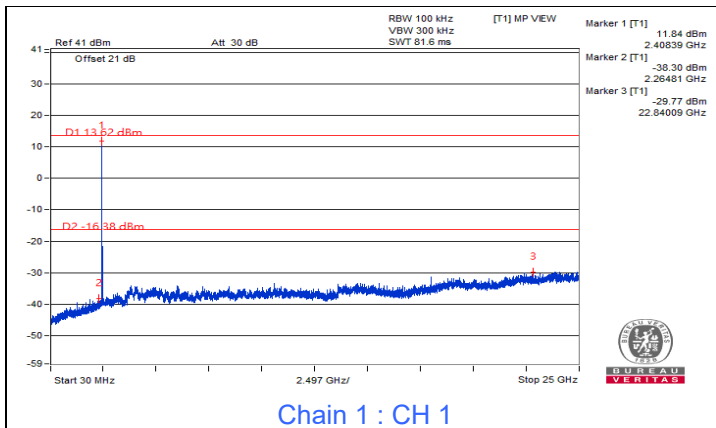

Chain 1 : CH 1

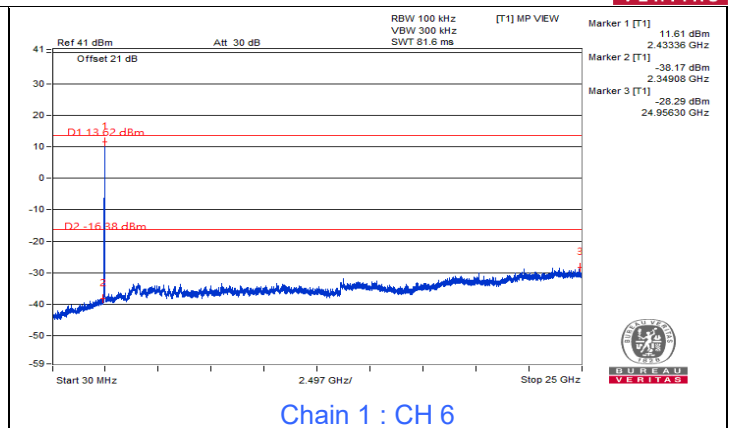

Chain 1 : CH 6

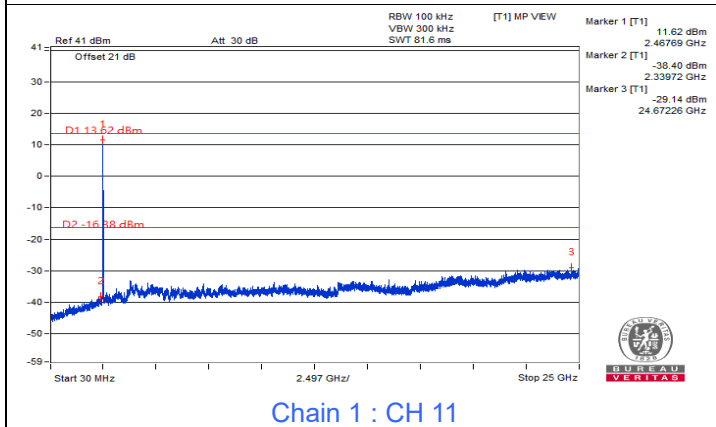

Chain 1 : CH 11

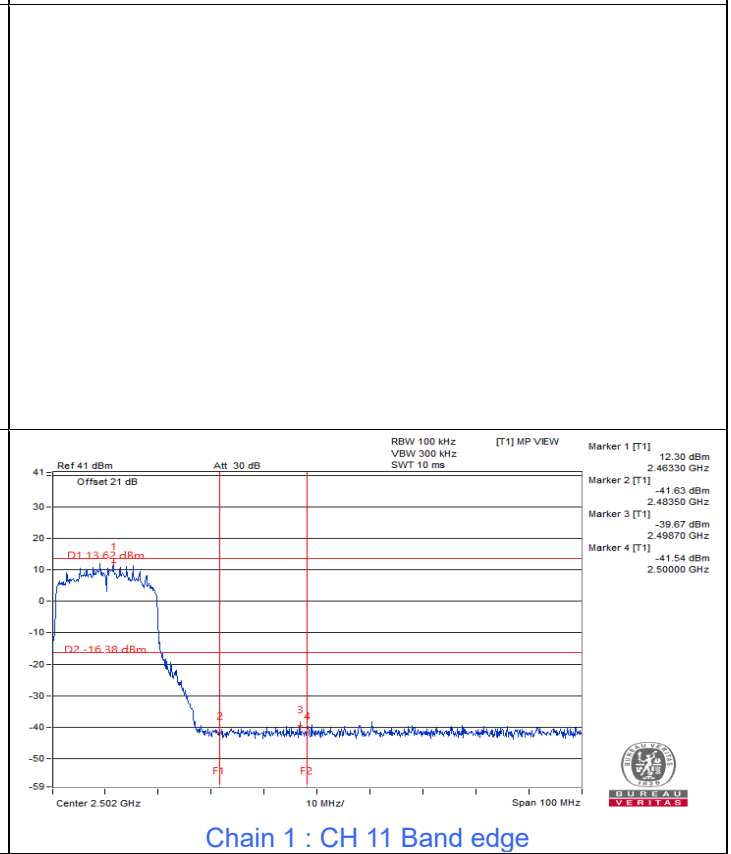

Chain 1 : CH 1 Band edge

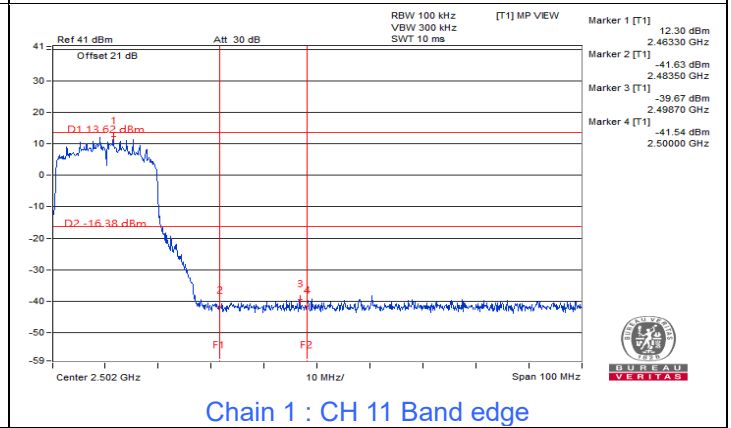

Chain 1 : CH 11 Band edge

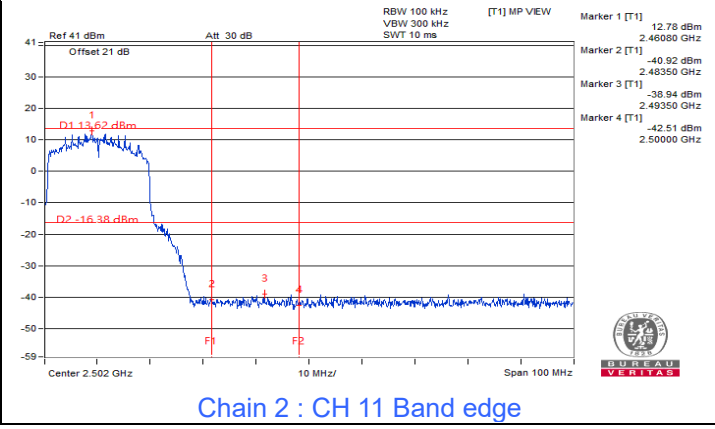
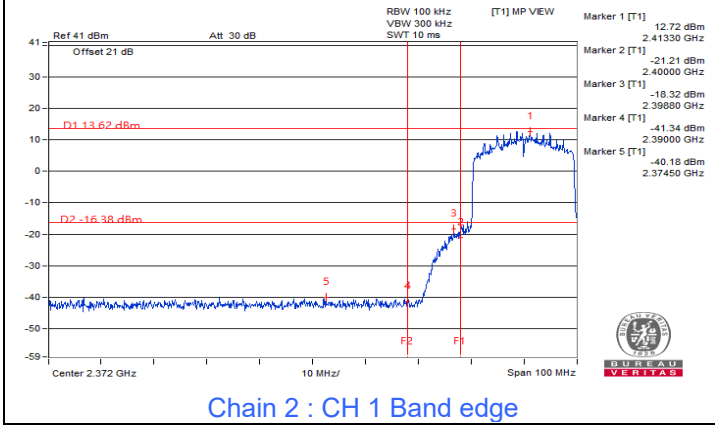
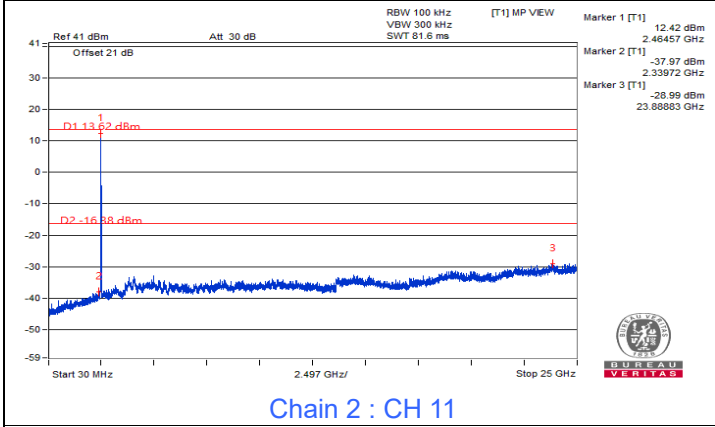
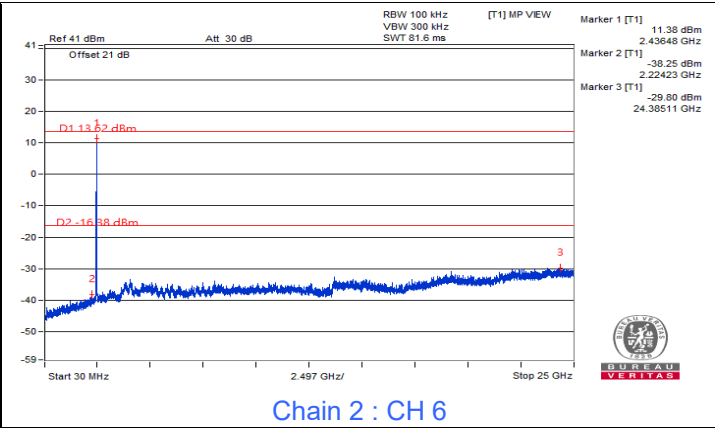
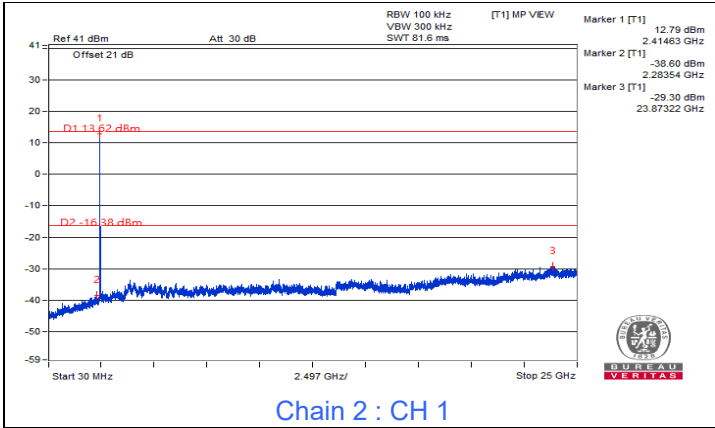

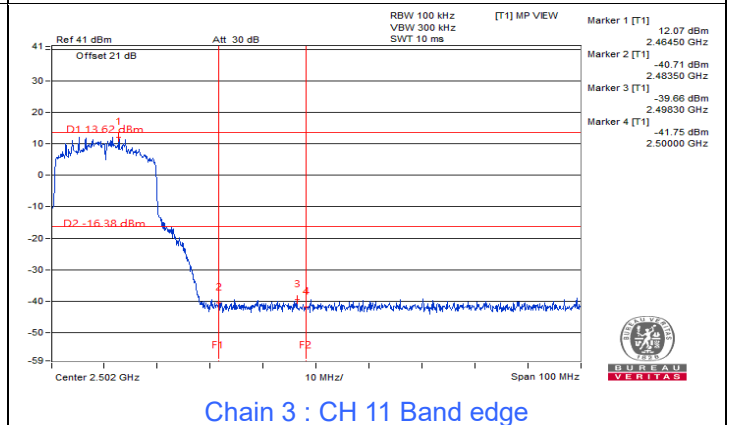
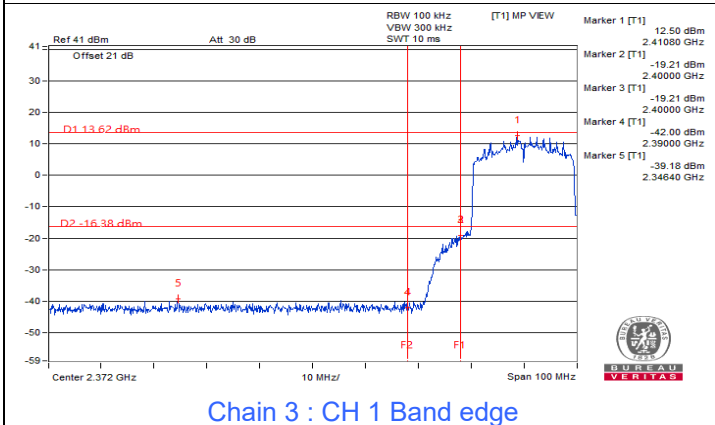
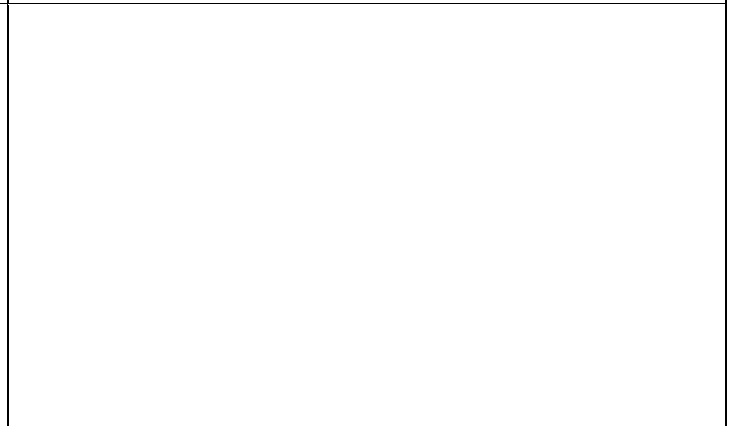
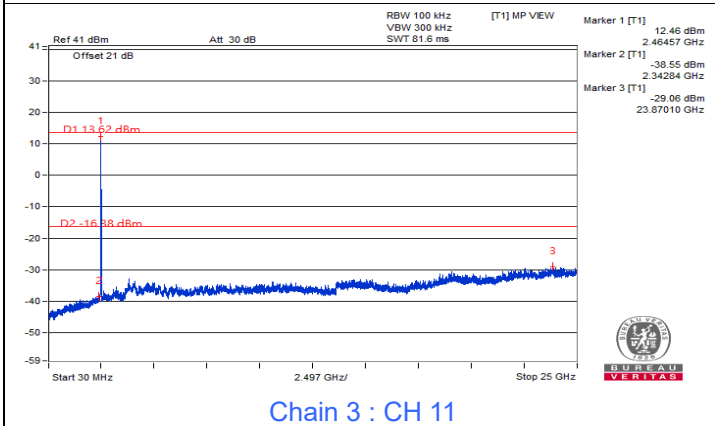
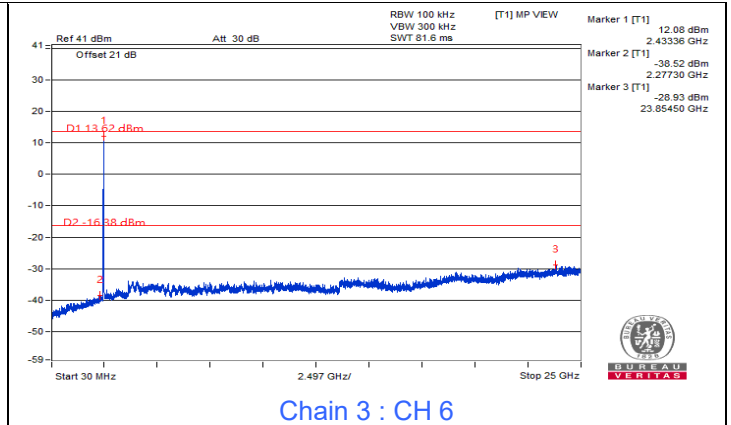
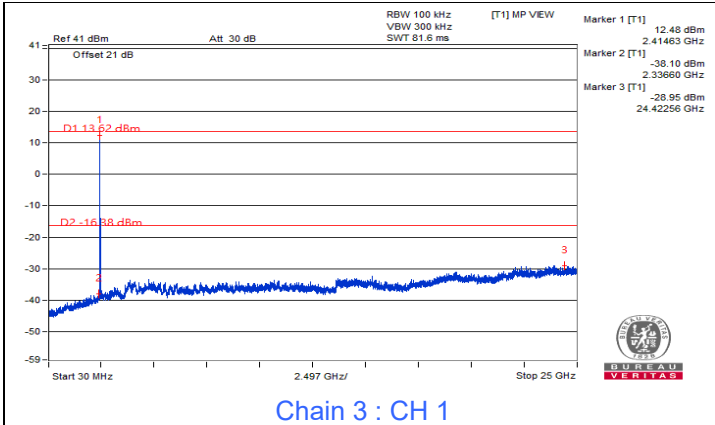

802.11ax (HE40)

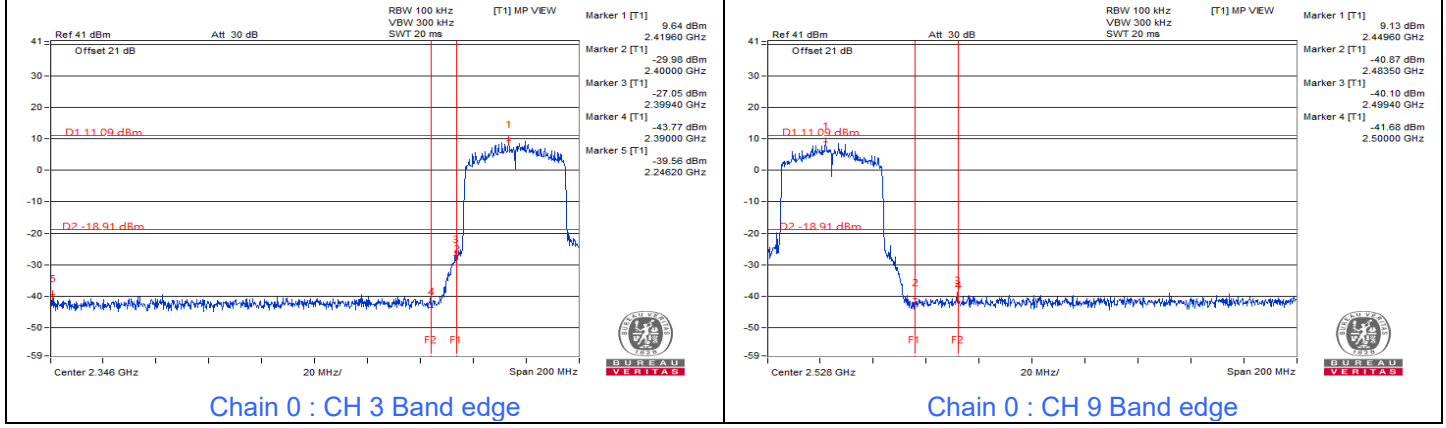
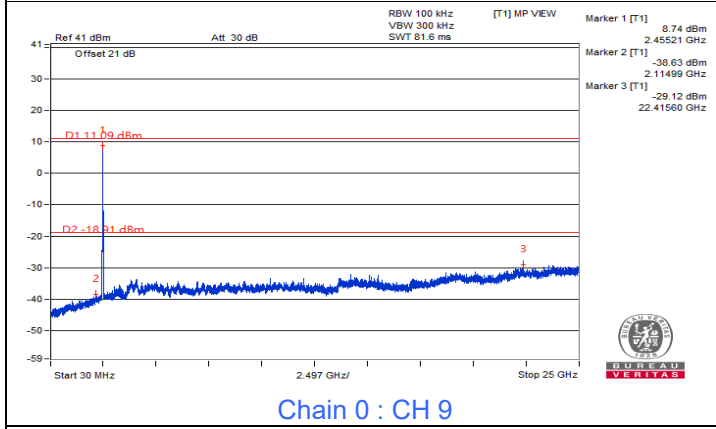
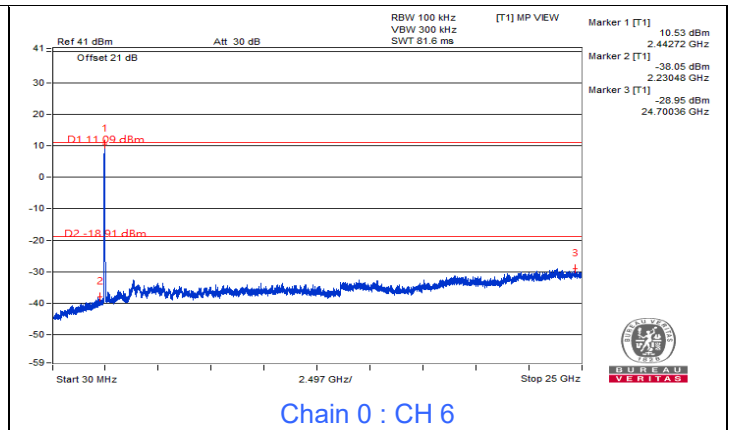
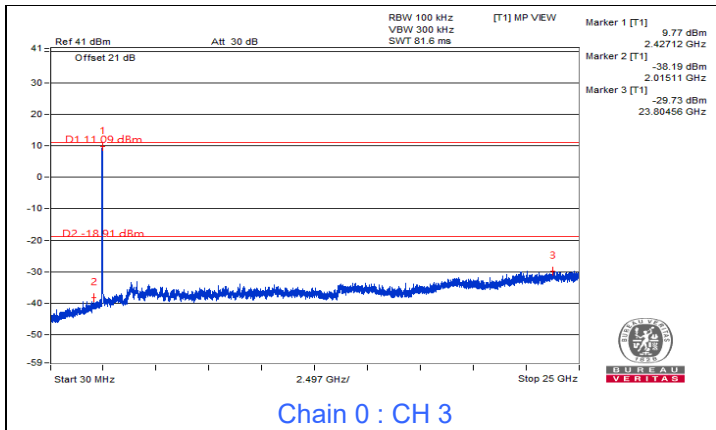
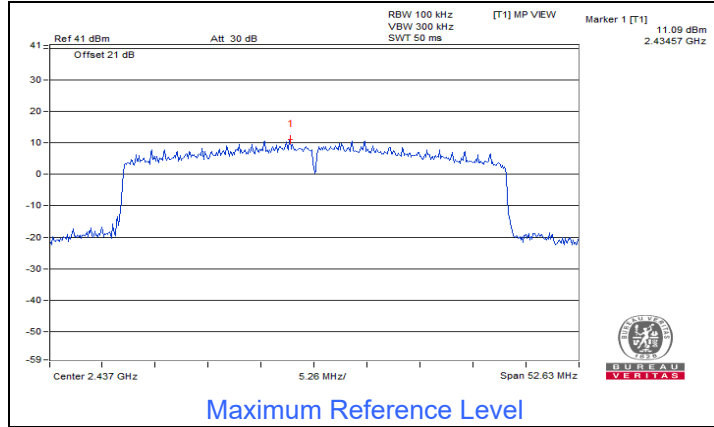

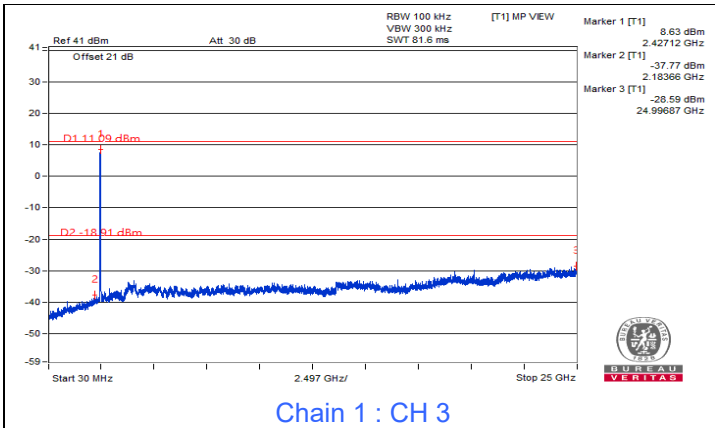

Chain 1 : CH 3

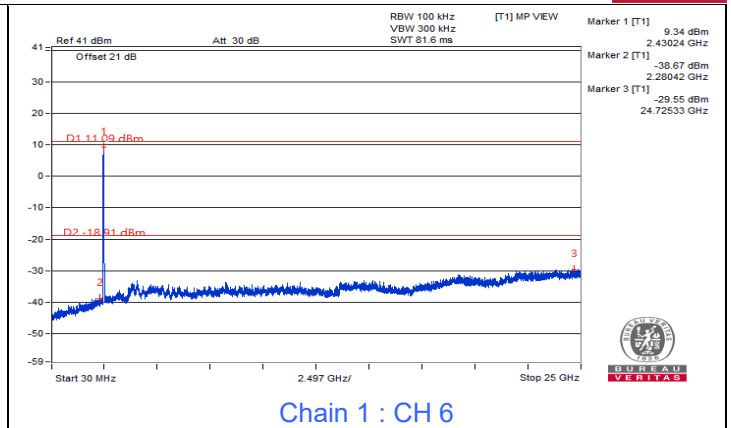

Chain 1 : CH 6

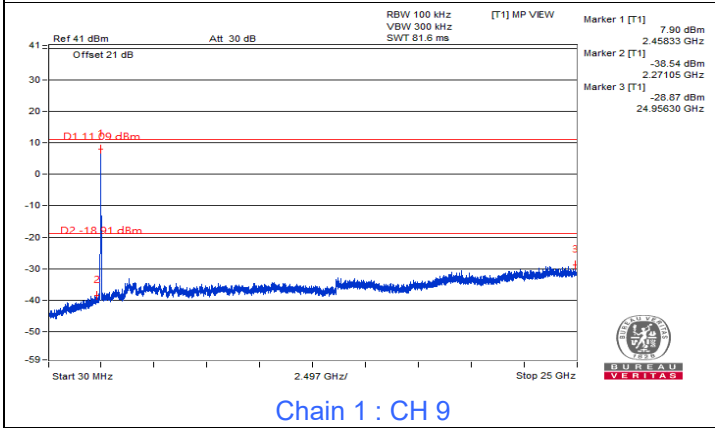

Chain 1 : CH 9

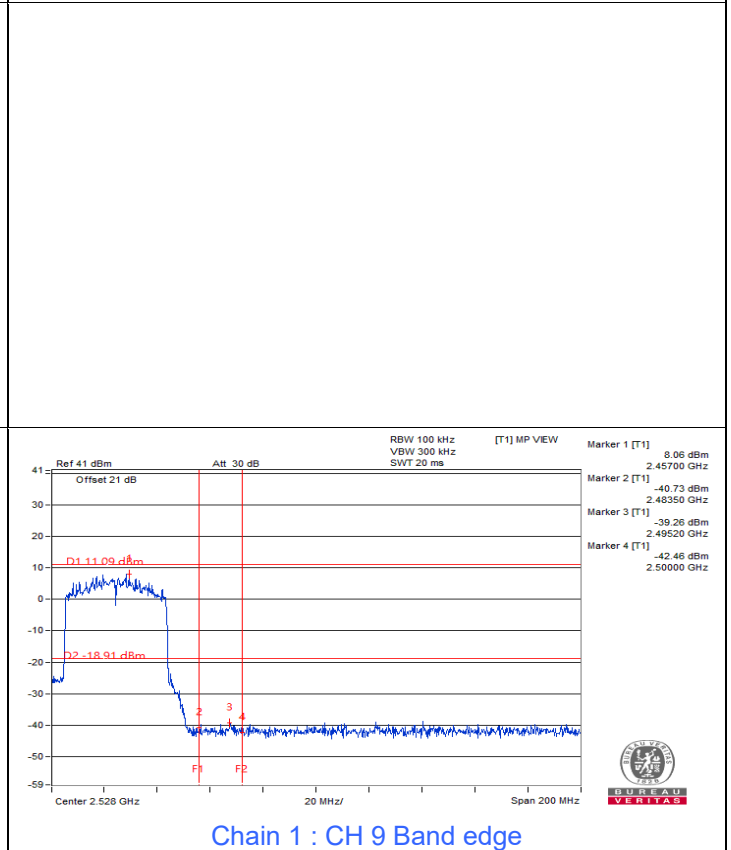

Chain 1 : CH 3 Band edge

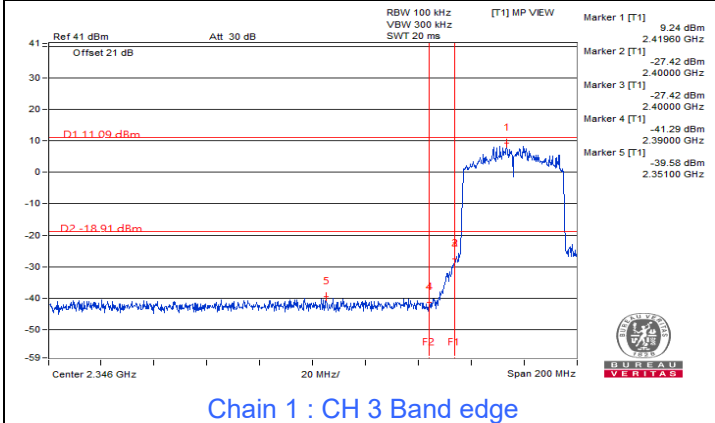

Chain 1 : CH 9 Band edge

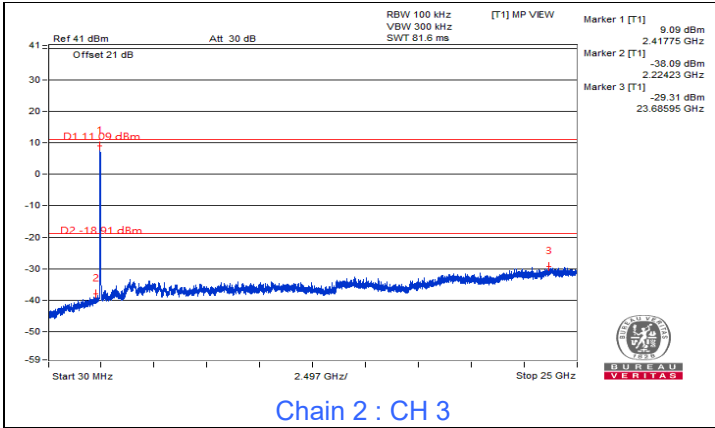

Chain 2 : CH 3

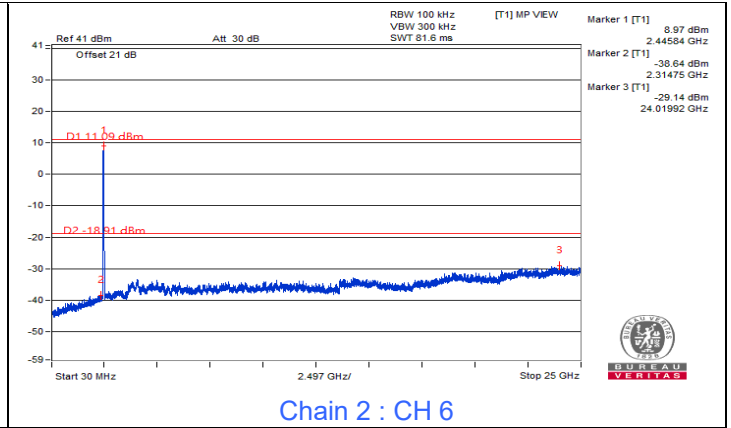

Chain 2 : CH 6

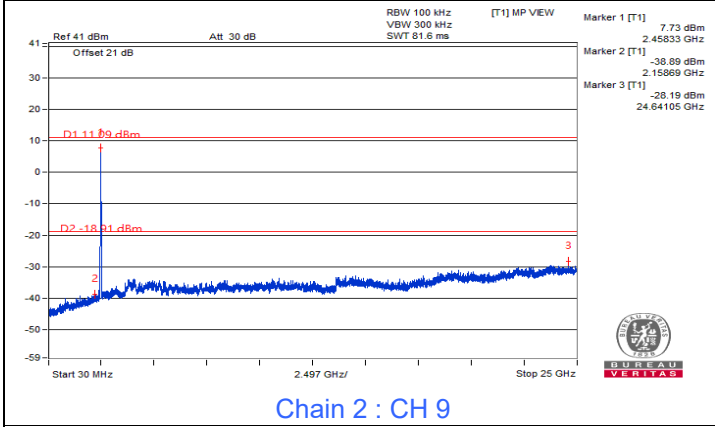

Chain 2 : CH 9

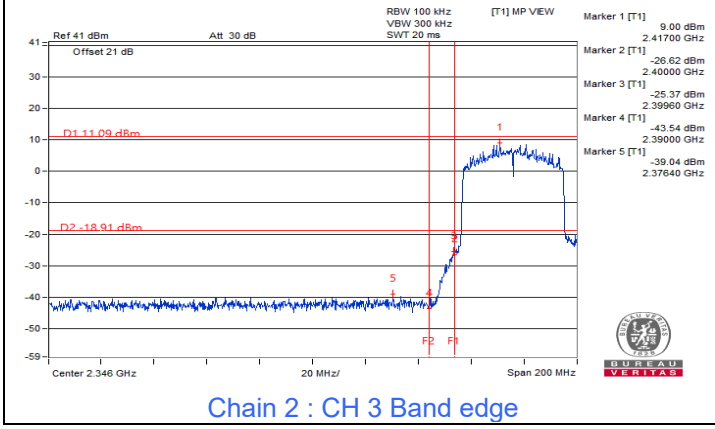

Chain 2 : CH 3 Band edge

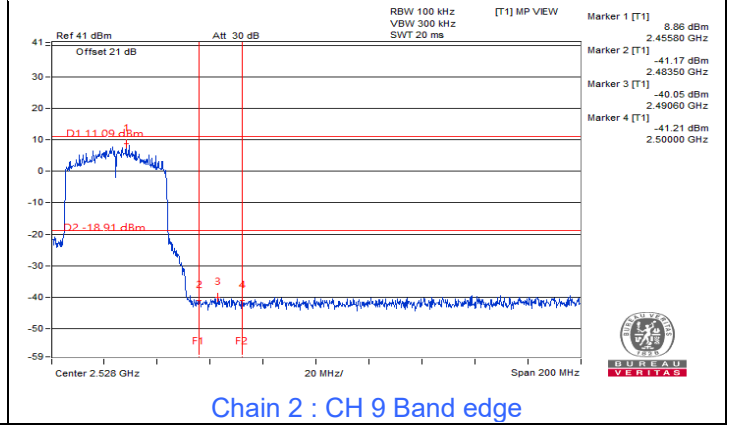

Chain 2 : CH 9 Band edge

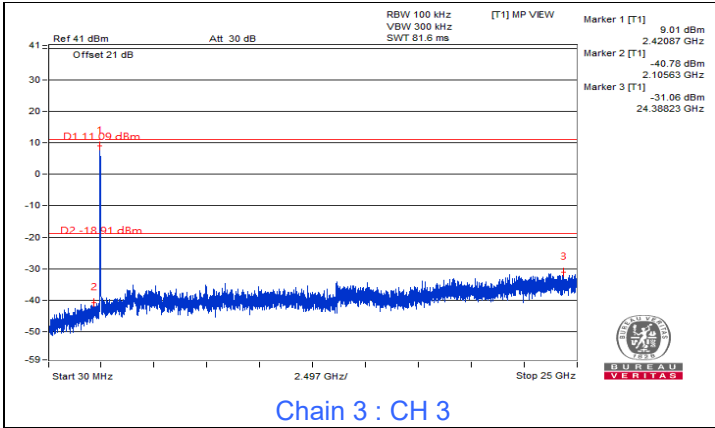

Chain 3 : CH 3

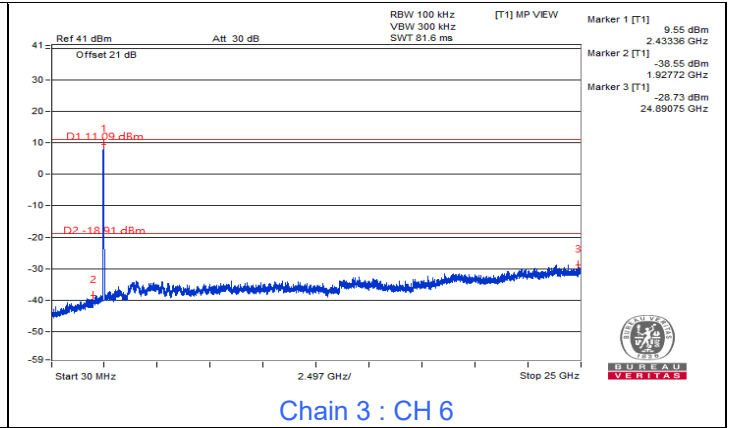

Chain 3 : CH 6

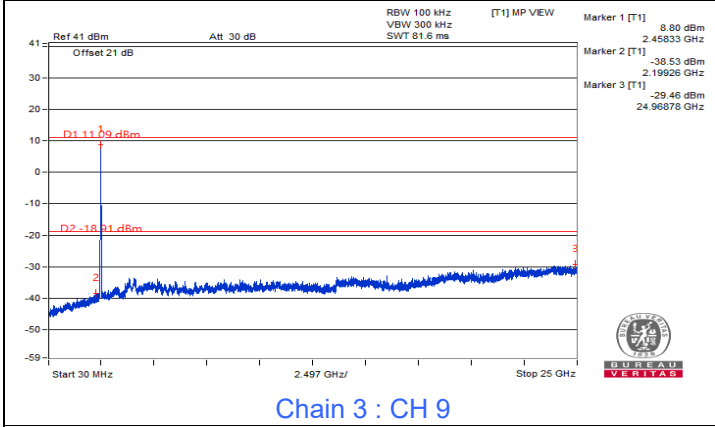

Chain 3 : CH 9

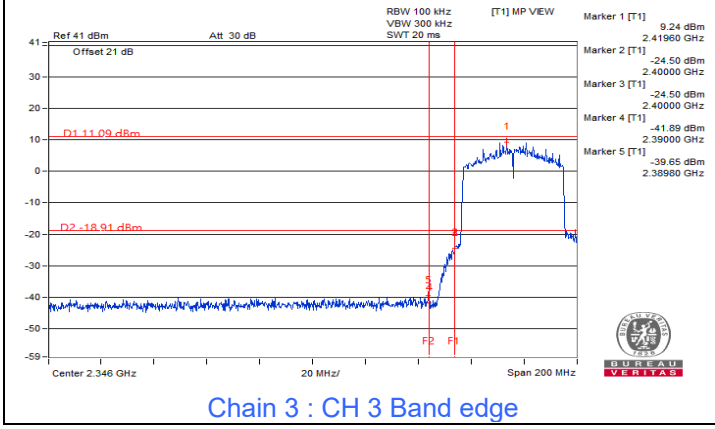

Chain 3 : CH 3 Band edge

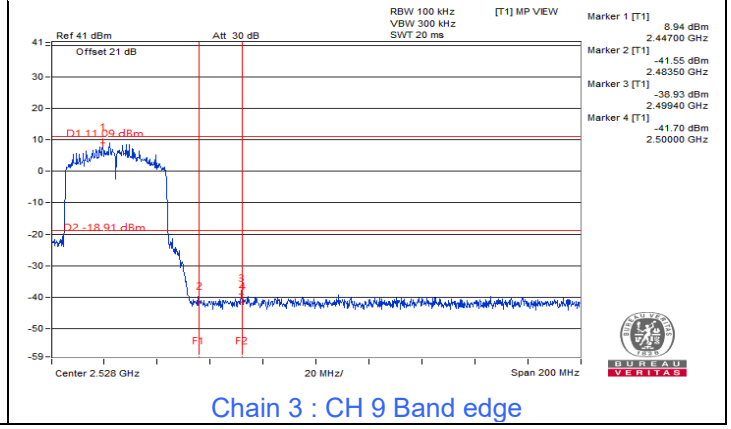

Chain 3 : CH 9 Band edge

7.5 AC Power Conducted Emissions

RF Mode	802.11ax (HE40)	Channel	CH 6 : 2437 MHz
Frequency Range	150 kHz ~ 30 MHz	Detector Function & Resolution Bandwidth	Quasi-Peak (QP) / Average (AV), 9 kHz
Input Power	120 Vac, 60 Hz	Environmental Conditions	23°C, 74% RH
Tested By	Sampson Chen		

Phase Of Power : Line (L)										
No	Frequency (MHz)	Correction Factor (dB)	Reading Value (dBuV)		Emission Level (dBuV)		Limit (dBuV)		Margin (dB)	
			Q.P.	AV.	Q.P.	AV.	Q.P.	AV.	Q.P.	AV.
1	0.15391	9.95	36.30	21.22	46.25	31.17	65.79	55.79	-19.54	-24.62
2	0.18906	9.95	30.99	16.38	40.94	26.33	64.08	54.08	-23.14	-27.75
3	0.25547	9.95	21.63	8.52	31.58	18.47	61.58	51.58	-30.00	-33.11
4	0.50156	9.97	24.14	15.52	34.11	25.49	56.00	46.00	-21.89	-20.51
5	6.90234	10.43	18.70	12.52	29.13	22.95	60.00	50.00	-30.87	-27.05
6	12.12109	10.77	19.69	14.01	30.46	24.78	60.00	50.00	-29.54	-25.22

Remarks:

1. Q.P. and AV. are abbreviations of quasi-peak and average individually.
2. The emission levels of other frequencies were very low against the limit.
3. Margin value = Emission level – Limit value
4. Correction factor = Insertion loss + Cable loss
5. Emission Level = Correction Factor + Reading Value

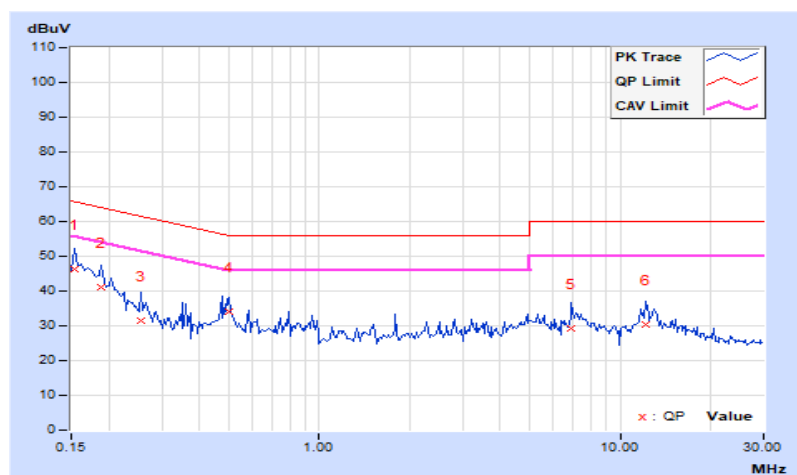

RF Mode	802.11ax (HE40)	Channel	CH 6 : 2437 MHz
Frequency Range	150 kHz ~ 30 MHz	Detector Function & Resolution Bandwidth	Quasi-Peak (QP) / Average (AV), 9 kHz
Input Power	120 Vac, 60 Hz	Environmental Conditions	23°C, 74% RH
Tested By	Sampson Chen		

Phase Of Power : Neutral (N)										
No	Frequency (MHz)	Correction Factor (dB)	Reading Value (dBuV)		Emission Level (dBuV)		Limit (dBuV)		Margin (dB)	
			Q.P.	AV.	Q.P.	AV.	Q.P.	AV.	Q.P.	AV.
1	0.15000	10.00	36.81	23.95	46.81	33.95	66.00	56.00	-19.19	-22.05
2	0.15781	10.00	35.88	24.03	45.88	34.03	65.58	55.58	-19.70	-21.55
3	0.47813	10.02	26.97	19.70	36.99	29.72	56.37	46.37	-19.38	-16.65
4	0.50156	10.02	32.32	26.01	42.34	36.03	56.00	46.00	-13.66	-9.97
5	2.50781	10.14	6.64	-3.74	16.78	6.40	56.00	46.00	-39.22	-39.60
6	6.86328	10.45	16.02	10.07	26.47	20.52	60.00	50.00	-33.53	-29.48

Remarks:

1. Q.P. and AV. are abbreviations of quasi-peak and average individually.
2. The emission levels of other frequencies were very low against the limit.
3. Margin value = Emission level – Limit value
4. Correction factor = Insertion loss + Cable loss
5. Emission Level = Correction Factor + Reading Value

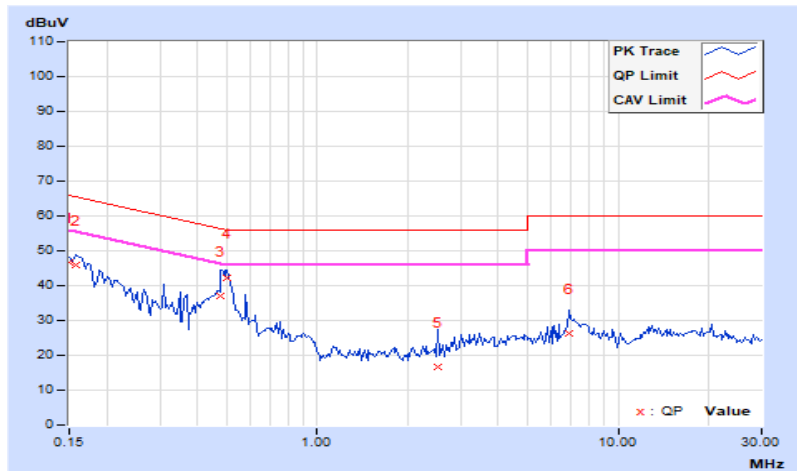

7.6 Unwanted Emissions below 1 GHz

RF Mode	802.11ax (HE40)	Channel	CH 6 : 2437 MHz
Frequency Range	30 MHz ~ 1 GHz	Detector Function & Bandwidth	QP: RB=120kHz, DET=Quasi-Peak
Input Power	120 Vac, 60 Hz	Environmental Conditions	23°C, 72% RH
Tested By	Sampson Chen		

Antenna Polarity & Test Distance : Horizontal at 3 m								
No	Frequency (MHz)	Emission Level (dBuV/m)	Limit (dBuV/m)	Margin (dB)	Antenna Height (m)	Table Angle (Degree)	Raw Value (dBuV)	Correction Factor (dB/m)
1	65.70	23.8 QP	40.0	-16.2	3.50 H	234	38.2	-14.4
2	118.12	22.4 QP	43.5	-21.1	3.00 H	268	37.9	-15.5
3	150.01	22.3 QP	43.5	-21.2	1.00 H	96	35.4	-13.1
4	250.00	25.3 QP	46.0	-20.7	1.00 H	66	39.6	-14.3
5	520.55	30.6 QP	46.0	-15.4	2.00 H	176	38.0	-7.4
6	557.78	33.9 QP	46.0	-12.1	1.50 H	330	40.7	-6.8

Remarks:

1. Emission Level(dBuV/m) = Raw Value(dBuV) + Correction Factor(dB/m)
2. Correction Factor(dB/m) = Antenna Factor(dB/m) + Cable Factor(dB) – Pre-Amplifier Factor(dB)
3. Margin value = Emission Level – Limit value
4. The other emission levels were very low against the limit of frequency range 30 MHz ~ 1 GHz.
5. The frequency range 9 kHz ~ 30 MHz: all emissions are more than 20 dB below the limit, therefore do not be recorded in this report.

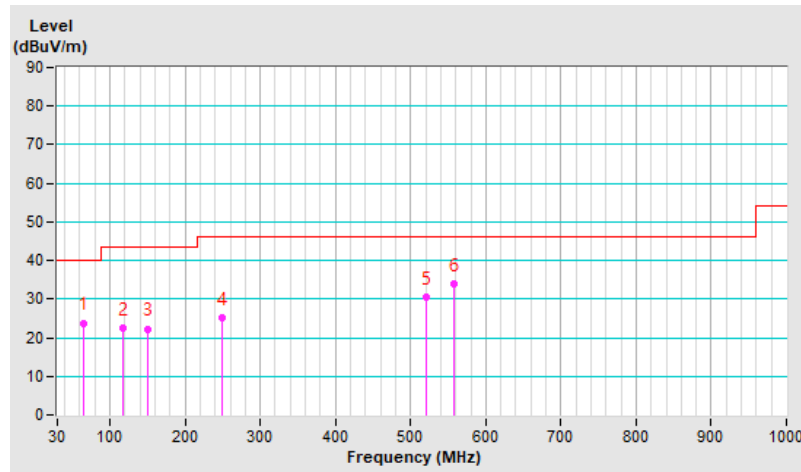

RF Mode	802.11ax (HE40)	Channel	CH 6 : 2437 MHz
Frequency Range	30 MHz ~ 1 GHz	Detector Function & Bandwidth	QP: RB=120kHz, DET=Quasi-Peak
Input Power	120 Vac, 60 Hz	Environmental Conditions	23°C, 72% RH
Tested By	Sampson Chen		

Antenna Polarity & Test Distance : Vertical at 3 m								
No	Frequency (MHz)	Emission Level (dBuV/m)	Limit (dBuV/m)	Margin (dB)	Antenna Height (m)	Table Angle (Degree)	Raw Value (dBuV)	Correction Factor (dB/m)
1	66.33	22.8 QP	40.0	-17.2	2.00 V	262	37.3	-14.5
2	110.80	22.0 QP	43.5	-21.5	1.00 V	334	38.4	-16.4
3	151.54	23.1 QP	43.5	-20.4	1.00 V	123	36.3	-13.2
4	454.11	27.0 QP	46.0	-19.0	1.00 V	341	35.5	-8.5
5	567.31	33.6 QP	46.0	-12.4	1.00 V	3	40.3	-6.7
6	605.36	30.6 QP	46.0	-15.4	1.00 V	360	35.8	-5.2

Remarks:

1. Emission Level(dBuV/m) = Raw Value(dBuV) + Correction Factor(dB/m)
2. Correction Factor(dB/m) = Antenna Factor(dB/m) + Cable Factor(dB) – Pre-Amplifier Factor(dB)
3. Margin value = Emission Level – Limit value
4. The other emission levels were very low against the limit of frequency range 30 MHz ~ 1 GHz.
5. The frequency range 9 kHz ~ 30 MHz: all emissions are more than 20 dB below the limit, therefore do not be recorded in this report.

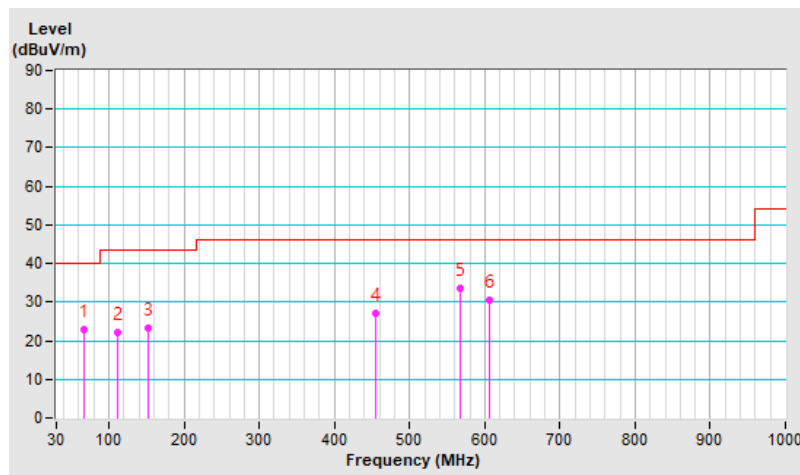

7.7 Unwanted Emissions above 1 GHz

RF Mode	802.11b	Channel	CH 1 : 2412 MHz
Frequency Range	1 GHz ~ 25 GHz	Detector Function & Bandwidth	PK: RB=1 MHz, VB=3 MHz, DET=Peak AV: RB=1 MHz, VB=10 Hz, DET=Peak
Input Power	120 Vac, 60 Hz	Environmental Conditions	22°C, 69% RH
Tested By	Sampson Chen		

Antenna Polarity & Test Distance : Horizontal at 3 m								
No	Frequency (MHz)	Emission Level (dBuV/m)	Limit (dBuV/m)	Margin (dB)	Antenna Height (m)	Table Angle (Degree)	Raw Value (dBuV)	Correction Factor (dB/m)
1	2390.00	55.9 PK	74.0	-18.1	2.25 H	358	56.3	-0.4
2	2390.00	45.3 AV	54.0	-8.7	2.25 H	358	45.7	-0.4
3	*2412.00	123.9 PK			2.25 H	358	124.3	-0.4
4	*2412.00	121.9 AV			2.25 H	358	122.3	-0.4
5	4824.00	53.5 PK	74.0	-20.5	1.11 H	194	49.2	4.3
6	4824.00	51.9 AV	54.0	-2.1	1.11 H	194	47.6	4.3

Remarks:

1. Emission Level(dBuV/m) = Raw Value(dBuV) + Correction Factor(dB/m)
2. Correction Factor(dB/m) = Antenna Factor(dB/m) + Cable Factor(dB) – Pre-Amplifier Factor(dB)
3. Margin value = Emission Level – Limit value
4. The other emission levels were very low against the limit.
5. " * " : Fundamental frequency, the limit was restricted at the RF Output Power.

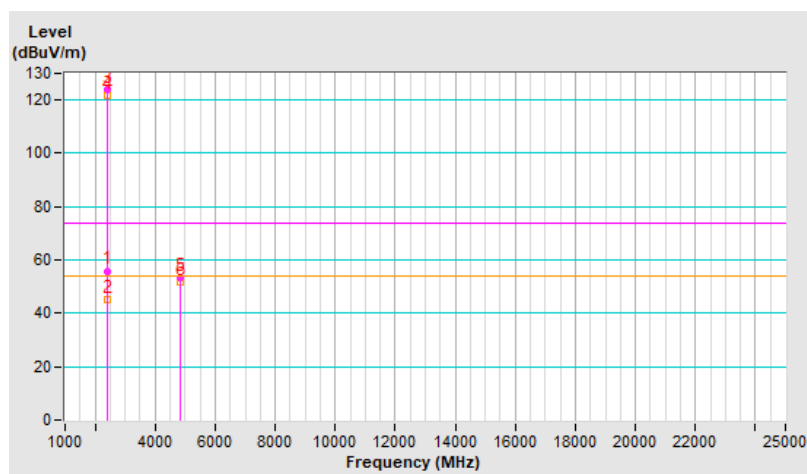

RF Mode	802.11b	Channel	CH 1 : 2412 MHz
Frequency Range	1 GHz ~ 25 GHz	Detector Function & Bandwidth	PK: RB=1 MHz, VB=3 MHz, DET=Peak AV: RB=1 MHz, VB=10 Hz, DET=Peak
Input Power	120 Vac, 60 Hz	Environmental Conditions	22°C, 69% RH
Tested By	Sampson Chen		

Antenna Polarity & Test Distance : Vertical at 3 m								
No	Frequency (MHz)	Emission Level (dBuV/m)	Limit (dBuV/m)	Margin (dB)	Antenna Height (m)	Table Angle (Degree)	Raw Value (dBuV)	Correction Factor (dB/m)
1	2390.00	56.7 PK	74.0	-17.3	1.52 V	340	57.1	-0.4
2	2390.00	44.0 AV	54.0	-10.0	1.52 V	340	44.4	-0.4
3	*2412.00	120.9 PK			1.52 V	340	121.3	-0.4
4	*2412.00	118.5 AV			1.52 V	340	118.9	-0.4
5	4824.00	53.0 PK	74.0	-21.0	1.03 V	74	48.7	4.3
6	4824.00	51.4 AV	54.0	-2.6	1.03 V	74	47.1	4.3

Remarks:

1. Emission Level(dBuV/m) = Raw Value(dBuV) + Correction Factor(dB/m)
2. Correction Factor(dB/m) = Antenna Factor(dB/m) + Cable Factor(dB) – Pre-Amplifier Factor(dB)
3. Margin value = Emission Level – Limit value
4. The other emission levels were very low against the limit.
5. " * " : Fundamental frequency, the limit was restricted at the RF Output Power.

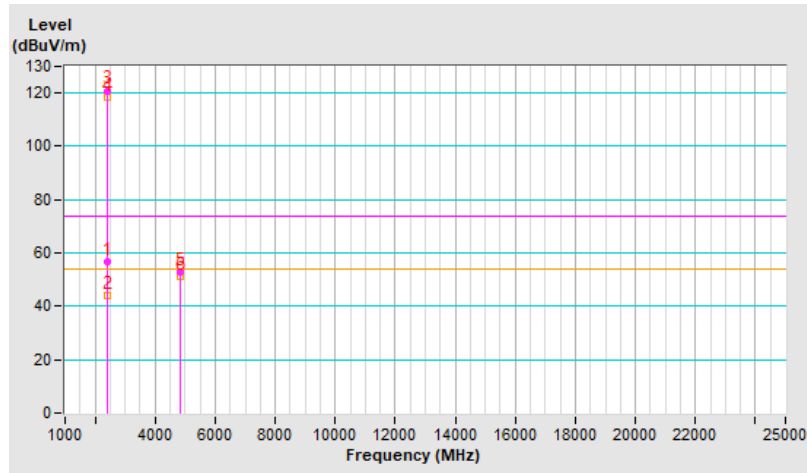

RF Mode	802.11b	Channel	CH 6 : 2437 MHz
Frequency Range	1 GHz ~ 25 GHz	Detector Function & Bandwidth	PK: RB=1 MHz, VB=3 MHz, DET=Peak AV: RB=1 MHz, VB=10 Hz, DET=Peak
Input Power	120 Vac, 60 Hz	Environmental Conditions	22°C, 69% RH
Tested By	Sampson Chen		

Antenna Polarity & Test Distance : Horizontal at 3 m								
No	Frequency (MHz)	Emission Level (dBuV/m)	Limit (dBuV/m)	Margin (dB)	Antenna Height (m)	Table Angle (Degree)	Raw Value (dBuV)	Correction Factor (dB/m)
1	2390.00	56.7 PK	74.0	-17.3	2.31 H	349	57.1	-0.4
2	2390.00	43.6 AV	54.0	-10.4	2.31 H	349	44.0	-0.4
3	*2437.00	123.1 PK			2.31 H	349	123.4	-0.3
4	*2437.00	121.4 AV			2.31 H	349	121.7	-0.3
5	2483.50	56.4 PK	74.0	-17.6	2.31 H	349	56.8	-0.4
6	2483.50	43.5 AV	54.0	-10.5	2.31 H	349	43.9	-0.4
7	4874.00	49.6 PK	74.0	-24.4	1.49 H	252	45.2	4.4
8	4874.00	47.5 AV	54.0	-6.5	1.49 H	252	43.1	4.4
9	7311.00	47.8 PK	74.0	-26.2	1.35 H	293	36.4	11.4
10	7311.00	38.5 AV	54.0	-15.5	1.35 H	293	27.1	11.4

Remarks:

1. Emission Level(dBuV/m) = Raw Value(dBuV) + Correction Factor(dB/m)
2. Correction Factor(dB/m) = Antenna Factor(dB/m) + Cable Factor(dB) – Pre-Amplifier Factor(dB)
3. Margin value = Emission Level – Limit value
4. The other emission levels were very low against the limit.
5. " * " : Fundamental frequency, the limit was restricted at the RF Output Power.

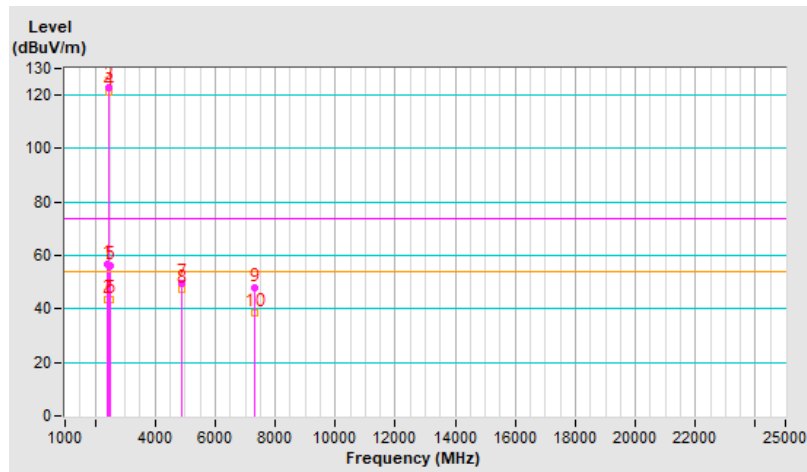

RF Mode	802.11b	Channel	CH 6 : 2437 MHz
Frequency Range	1 GHz ~ 25 GHz	Detector Function & Bandwidth	PK: RB=1 MHz, VB=3 MHz, DET=Peak AV: RB=1 MHz, VB=10 Hz, DET=Peak
Input Power	120 Vac, 60 Hz	Environmental Conditions	22°C, 69% RH
Tested By	Sampson Chen		

Antenna Polarity & Test Distance : Vertical at 3 m								
No	Frequency (MHz)	Emission Level (dBuV/m)	Limit (dBuV/m)	Margin (dB)	Antenna Height (m)	Table Angle (Degree)	Raw Value (dBuV)	Correction Factor (dB/m)
1	2390.00	57.3 PK	74.0	-16.7	1.47 V	336	57.7	-0.4
2	2390.00	43.7 AV	54.0	-10.3	1.47 V	336	44.1	-0.4
3	*2437.00	120.7 PK			1.47 V	336	121.0	-0.3
4	*2437.00	118.1 AV			1.47 V	336	118.4	-0.3
5	2483.50	57.5 PK	74.0	-16.5	1.47 V	336	57.9	-0.4
6	2483.50	44.2 AV	54.0	-9.8	1.47 V	336	44.6	-0.4
7	4874.00	49.8 PK	74.0	-24.2	1.10 V	134	45.4	4.4
8	4874.00	47.2 AV	54.0	-6.8	1.10 V	134	42.8	4.4
9	7311.00	49.3 PK	74.0	-24.7	2.01 V	345	37.9	11.4
10	7311.00	42.1 AV	54.0	-11.9	2.01 V	345	30.7	11.4

Remarks:

1. Emission Level(dBuV/m) = Raw Value(dBuV) + Correction Factor(dB/m)
2. Correction Factor(dB/m) = Antenna Factor(dB/m) + Cable Factor(dB) – Pre-Amplifier Factor(dB)
3. Margin value = Emission Level – Limit value
4. The other emission levels were very low against the limit.
5. " * " : Fundamental frequency, the limit was restricted at the RF Output Power.

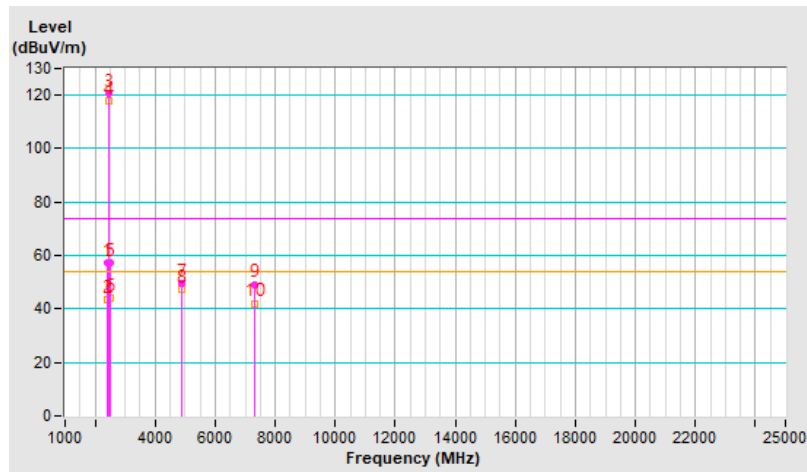

RF Mode	802.11b	Channel	CH 11 : 2462 MHz
Frequency Range	1 GHz ~ 25 GHz	Detector Function & Bandwidth	PK: RB=1 MHz, VB=3 MHz, DET=Peak AV: RB=1 MHz, VB=10 Hz, DET=Peak
Input Power	120 Vac, 60 Hz	Environmental Conditions	22°C, 69% RH
Tested By	Sampson Chen		

Antenna Polarity & Test Distance : Horizontal at 3 m								
No	Frequency (MHz)	Emission Level (dBuV/m)	Limit (dBuV/m)	Margin (dB)	Antenna Height (m)	Table Angle (Degree)	Raw Value (dBuV)	Correction Factor (dB/m)
1	*2462.00	120.2 PK			2.10 H	359	120.6	-0.4
2	*2462.00	118.1 AV			2.10 H	359	118.5	-0.4
3	2483.50	55.2 PK	74.0	-18.8	2.10 H	359	55.6	-0.4
4	2483.50	44.4 AV	54.0	-9.6	2.10 H	359	44.8	-0.4
5	4924.00	49.4 PK	74.0	-24.6	1.10 H	37	44.9	4.5
6	4924.00	46.8 AV	54.0	-7.2	1.10 H	37	42.3	4.5
7	7386.00	45.9 PK	74.0	-28.1	1.37 H	221	34.4	11.5
8	7386.00	35.8 AV	54.0	-18.2	1.37 H	221	24.3	11.5

Remarks:

1. Emission Level(dBuV/m) = Raw Value(dBuV) + Correction Factor(dB/m)
2. Correction Factor(dB/m) = Antenna Factor(dB/m) + Cable Factor(dB) – Pre-Amplifier Factor(dB)
3. Margin value = Emission Level – Limit value
4. The other emission levels were very low against the limit.
5. " * " : Fundamental frequency, the limit was restricted at the RF Output Power.

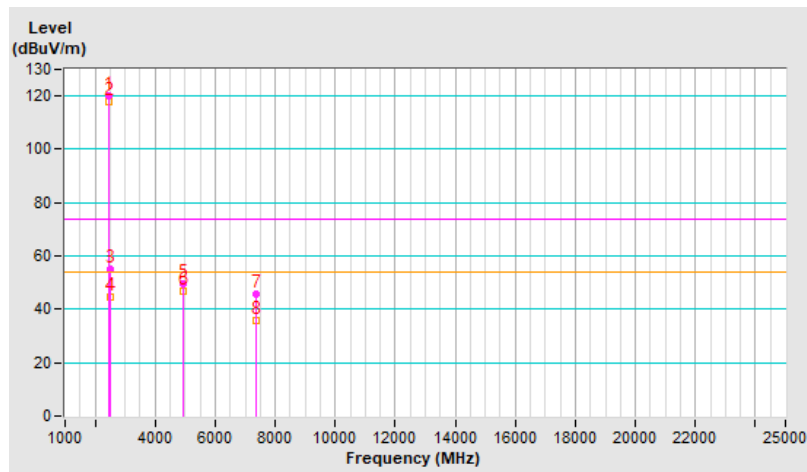

RF Mode	802.11b	Channel	CH 11 : 2462 MHz
Frequency Range	1 GHz ~ 25 GHz	Detector Function & Bandwidth	PK: RB=1 MHz, VB=3 MHz, DET=Peak AV: RB=1 MHz, VB=10 Hz, DET=Peak
Input Power	120 Vac, 60 Hz	Environmental Conditions	22°C, 69% RH
Tested By	Sampson Chen		

Antenna Polarity & Test Distance : Vertical at 3 m								
No	Frequency (MHz)	Emission Level (dBuV/m)	Limit (dBuV/m)	Margin (dB)	Antenna Height (m)	Table Angle (Degree)	Raw Value (dBuV)	Correction Factor (dB/m)
1	*2462.00	119.8 PK			1.29 V	283	120.2	-0.4
2	*2462.00	117.7 AV			1.29 V	283	118.1	-0.4
3	2483.50	54.9 PK	74.0	-19.1	1.29 V	283	55.3	-0.4
4	2483.50	44.7 AV	54.0	-9.3	1.29 V	283	45.1	-0.4
5	4924.00	55.4 PK	74.0	-18.6	1.72 V	175	50.9	4.5
6	4924.00	53.7 AV	54.0	-0.3	1.72 V	175	49.2	4.5
7	7386.00	45.5 PK	74.0	-28.5	1.77 V	254	34.0	11.5
8	7386.00	35.1 AV	54.0	-18.9	1.77 V	254	23.6	11.5

Remarks:

1. Emission Level(dBuV/m) = Raw Value(dBuV) + Correction Factor(dB/m)
2. Correction Factor(dB/m) = Antenna Factor(dB/m) + Cable Factor(dB) – Pre-Amplifier Factor(dB)
3. Margin value = Emission Level – Limit value
4. The other emission levels were very low against the limit.
5. " * " : Fundamental frequency, the limit was restricted at the RF Output Power.

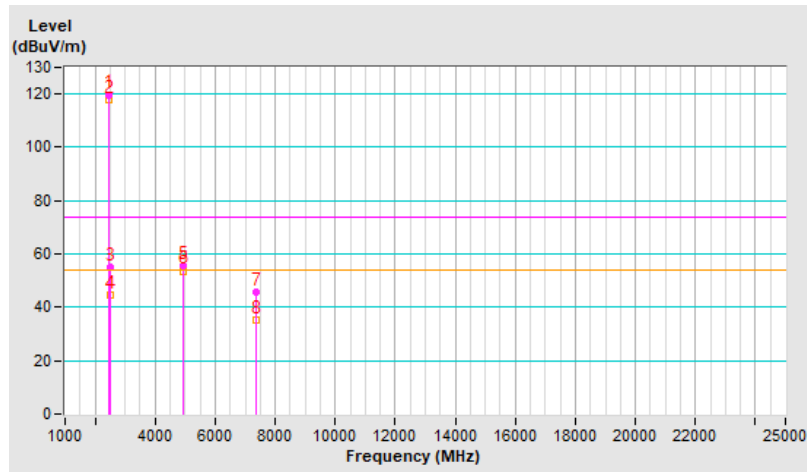

RF Mode	802.11g	Channel	CH 1 : 2412 MHz
Frequency Range	1 GHz ~ 25 GHz	Detector Function & Bandwidth	PK: RB=1 MHz, VB=3 MHz, DET=Peak AV: RB=1 MHz, VB=1 kHz, DET=Peak
Input Power	120 Vac, 60 Hz	Environmental Conditions	22°C, 69% RH
Tested By	Sampson Chen		

Antenna Polarity & Test Distance : Horizontal at 3 m								
No	Frequency (MHz)	Emission Level (dBuV/m)	Limit (dBuV/m)	Margin (dB)	Antenna Height (m)	Table Angle (Degree)	Raw Value (dBuV)	Correction Factor (dB/m)
1	2390.00	61.6 PK	74.0	-12.4	1.50 H	360	62.0	-0.4
2	2390.00	48.4 AV	54.0	-5.6	1.50 H	360	48.8	-0.4
3	*2412.00	125.1 PK			1.50 H	360	125.5	-0.4
4	*2412.00	115.9 AV			1.50 H	360	116.3	-0.4
5	4824.00	51.0 PK	74.0	-23.0	2.22 H	27	46.7	4.3
6	4824.00	39.8 AV	54.0	-14.2	2.22 H	27	35.5	4.3

Remarks:

1. Emission Level(dBuV/m) = Raw Value(dBuV) + Correction Factor(dB/m)
2. Correction Factor(dB/m) = Antenna Factor(dB/m) + Cable Factor(dB) – Pre-Amplifier Factor(dB)
3. Margin value = Emission Level – Limit value
4. The other emission levels were very low against the limit.
5. " * " : Fundamental frequency, the limit was restricted at the RF Output Power.

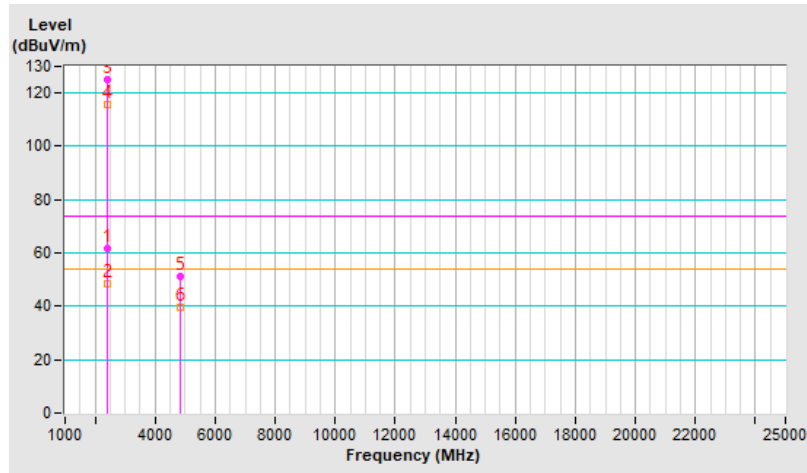

RF Mode	802.11g	Channel	CH 1 : 2412 MHz
Frequency Range	1 GHz ~ 25 GHz	Detector Function & Bandwidth	PK: RB=1 MHz, VB=3 MHz, DET=Peak AV: RB=1 MHz, VB=1 kHz, DET=Peak
Input Power	120 Vac, 60 Hz	Environmental Conditions	22°C, 69% RH
Tested By	Sampson Chen		

Antenna Polarity & Test Distance : Vertical at 3 m								
No	Frequency (MHz)	Emission Level (dBuV/m)	Limit (dBuV/m)	Margin (dB)	Antenna Height (m)	Table Angle (Degree)	Raw Value (dBuV)	Correction Factor (dB/m)
1	2390.00	62.6 PK	74.0	-11.4	1.32 V	90	63.0	-0.4
2	2390.00	49.0 AV	54.0	-5.0	1.32 V	90	49.4	-0.4
3	*2412.00	126.5 PK			1.32 V	90	126.9	-0.4
4	*2412.00	117.6 AV			1.32 V	90	118.0	-0.4
5	4824.00	56.1 PK	74.0	-17.9	1.33 V	181	51.8	4.3
6	4824.00	44.2 AV	54.0	-9.8	1.33 V	181	39.9	4.3

Remarks:

1. Emission Level(dBuV/m) = Raw Value(dBuV) + Correction Factor(dB/m)
2. Correction Factor(dB/m) = Antenna Factor(dB/m) + Cable Factor(dB) – Pre-Amplifier Factor(dB)
3. Margin value = Emission Level – Limit value
4. The other emission levels were very low against the limit.
5. " * " : Fundamental frequency, the limit was restricted at the RF Output Power.

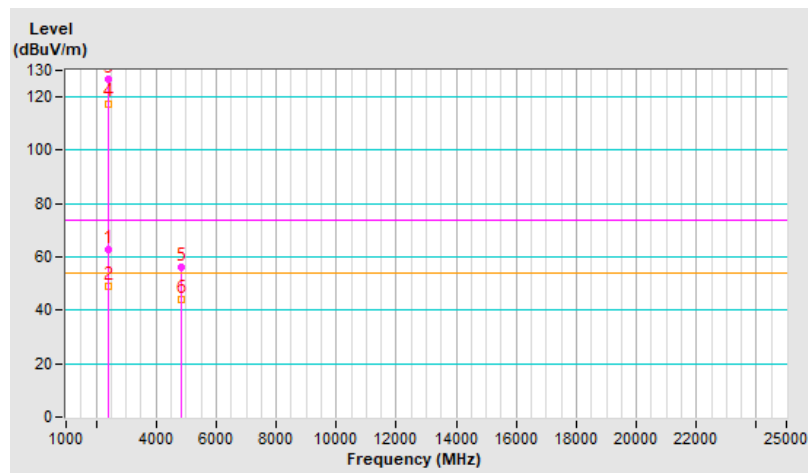

RF Mode	802.11g	Channel	CH 6 : 2437 MHz
Frequency Range	1 GHz ~ 25 GHz	Detector Function & Bandwidth	PK: RB=1 MHz, VB=3 MHz, DET=Peak AV: RB=1 MHz, VB=1 kHz, DET=Peak
Input Power	120 Vac, 60 Hz	Environmental Conditions	22°C, 69% RH
Tested By	Sampson Chen		

Antenna Polarity & Test Distance : Horizontal at 3 m								
No	Frequency (MHz)	Emission Level (dBuV/m)	Limit (dBuV/m)	Margin (dB)	Antenna Height (m)	Table Angle (Degree)	Raw Value (dBuV)	Correction Factor (dB/m)
1	2390.00	56.7 PK	74.0	-17.3	1.51 H	346	57.1	-0.4
2	2390.00	43.9 AV	54.0	-10.1	1.51 H	346	44.3	-0.4
3	*2437.00	124.8 PK			1.51 H	346	125.1	-0.3
4	*2437.00	115.3 AV			1.51 H	346	115.6	-0.3
5	2483.50	56.6 PK	74.0	-17.4	1.51 H	346	57.0	-0.4
6	2483.50	43.8 AV	54.0	-10.2	1.51 H	346	44.2	-0.4
7	4874.00	51.0 PK	74.0	-23.0	2.29 H	37	46.6	4.4
8	4874.00	40.1 AV	54.0	-13.9	2.29 H	37	35.7	4.4
9	7311.00	46.7 PK	74.0	-27.3	1.48 H	5	35.3	11.4
10	7311.00	35.1 AV	54.0	-18.9	1.48 H	5	23.7	11.4

Remarks:

1. Emission Level(dBuV/m) = Raw Value(dBuV) + Correction Factor(dB/m)
2. Correction Factor(dB/m) = Antenna Factor(dB/m) + Cable Factor(dB) – Pre-Amplifier Factor(dB)
3. Margin value = Emission Level – Limit value
4. The other emission levels were very low against the limit.
5. " * " : Fundamental frequency, the limit was restricted at the RF Output Power.

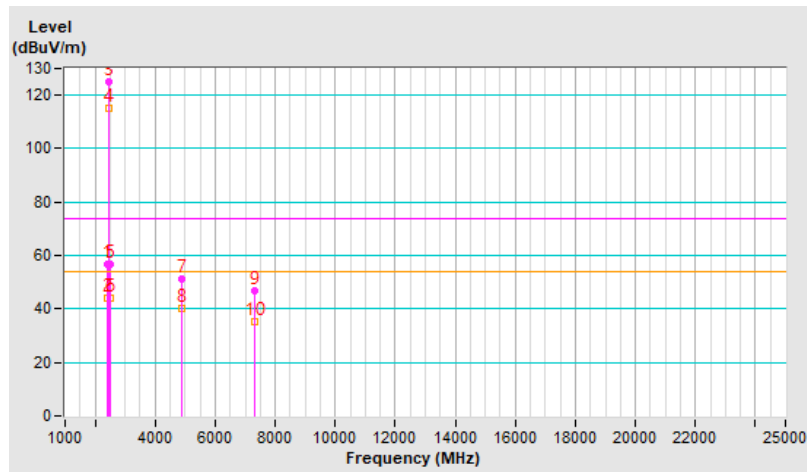

RF Mode	802.11g	Channel	CH 6 : 2437 MHz
Frequency Range	1 GHz ~ 25 GHz	Detector Function & Bandwidth	PK: RB=1 MHz, VB=3 MHz, DET=Peak AV: RB=1 MHz, VB=1 kHz, DET=Peak
Input Power	120 Vac, 60 Hz	Environmental Conditions	22°C, 69% RH
Tested By	Sampson Chen		

Antenna Polarity & Test Distance : Vertical at 3 m								
No	Frequency (MHz)	Emission Level (dBuV/m)	Limit (dBuV/m)	Margin (dB)	Antenna Height (m)	Table Angle (Degree)	Raw Value (dBuV)	Correction Factor (dB/m)
1	2390.00	57.5 PK	74.0	-16.5	1.42 V	89	57.9	-0.4
2	2390.00	44.2 AV	54.0	-9.8	1.42 V	89	44.6	-0.4
3	*2437.00	126.2 PK			1.42 V	89	126.5	-0.3
4	*2437.00	117.1 AV			1.42 V	89	117.4	-0.3
5	2483.50	57.3 PK	74.0	-16.7	1.42 V	89	57.7	-0.4
6	2483.50	44.1 AV	54.0	-9.9	1.42 V	89	44.5	-0.4
7	4874.00	55.7 PK	74.0	-18.3	1.37 V	178	51.3	4.4
8	4874.00	43.9 AV	54.0	-10.1	1.37 V	178	39.5	4.4
9	7311.00	48.4 PK	74.0	-25.6	2.42 V	350	37.0	11.4
10	7311.00	37.5 AV	54.0	-16.5	2.42 V	350	26.1	11.4

Remarks:

1. Emission Level(dBuV/m) = Raw Value(dBuV) + Correction Factor(dB/m)
2. Correction Factor(dB/m) = Antenna Factor(dB/m) + Cable Factor(dB) – Pre-Amplifier Factor(dB)
3. Margin value = Emission Level – Limit value
4. The other emission levels were very low against the limit.
5. " * " : Fundamental frequency, the limit was restricted at the RF Output Power.

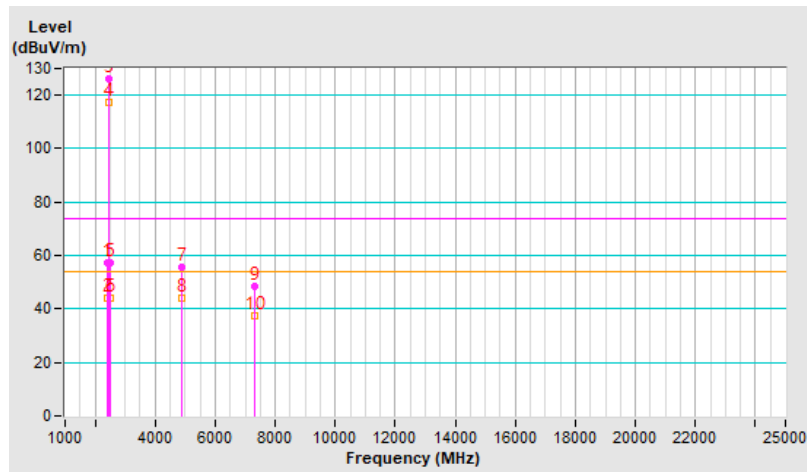

RF Mode	802.11g	Channel	CH 11 : 2462 MHz
Frequency Range	1 GHz ~ 25 GHz	Detector Function & Bandwidth	PK: RB=1 MHz, VB=3 MHz, DET=Peak AV: RB=1 MHz, VB=1 kHz, DET=Peak
Input Power	120 Vac, 60 Hz	Environmental Conditions	22°C, 69% RH
Tested By	Sampson Chen		

Antenna Polarity & Test Distance : Horizontal at 3 m								
No	Frequency (MHz)	Emission Level (dBuV/m)	Limit (dBuV/m)	Margin (dB)	Antenna Height (m)	Table Angle (Degree)	Raw Value (dBuV)	Correction Factor (dB/m)
1	*2462.00	125.5 PK			2.10 H	358	125.9	-0.4
2	*2462.00	116.1 AV			2.10 H	358	116.5	-0.4
3	2483.50	69.6 PK	74.0	-4.4	2.10 H	358	70.0	-0.4
4	2483.50	52.8 AV	54.0	-1.2	2.10 H	358	53.2	-0.4
5	4924.00	51.2 PK	74.0	-22.8	2.23 H	36	46.7	4.5
6	4924.00	40.3 AV	54.0	-13.7	2.23 H	36	35.8	4.5
7	7386.00	46.9 PK	74.0	-27.1	1.43 H	12	35.4	11.5
8	7386.00	35.3 AV	54.0	-18.7	1.43 H	12	23.8	11.5

Remarks:

1. Emission Level(dBuV/m) = Raw Value(dBuV) + Correction Factor(dB/m)
2. Correction Factor(dB/m) = Antenna Factor(dB/m) + Cable Factor(dB) – Pre-Amplifier Factor(dB)
3. Margin value = Emission Level – Limit value
4. The other emission levels were very low against the limit.
5. " * " : Fundamental frequency, the limit was restricted at the RF Output Power.

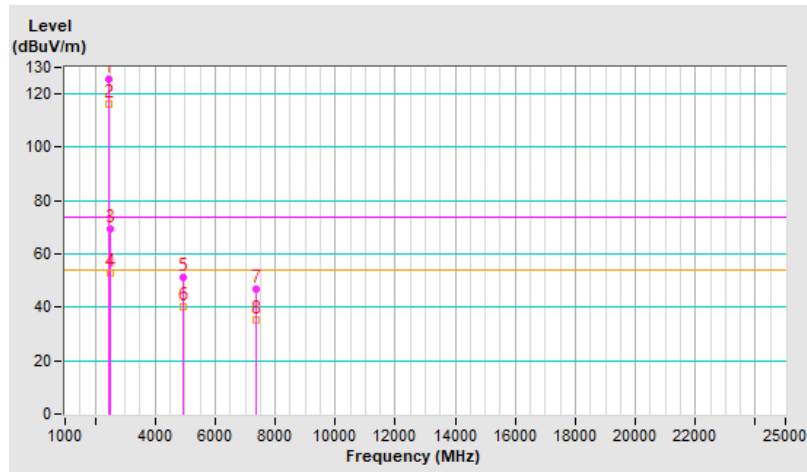

RF Mode	802.11g	Channel	CH 11 : 2462 MHz
Frequency Range	1 GHz ~ 25 GHz	Detector Function & Bandwidth	PK: RB=1 MHz, VB=3 MHz, DET=Peak AV: RB=1 MHz, VB=1 kHz, DET=Peak
Input Power	120 Vac, 60 Hz	Environmental Conditions	22°C, 69% RH
Tested By	Sampson Chen		

Antenna Polarity & Test Distance : Vertical at 3 m								
No	Frequency (MHz)	Emission Level (dBuV/m)	Limit (dBuV/m)	Margin (dB)	Antenna Height (m)	Table Angle (Degree)	Raw Value (dBuV)	Correction Factor (dB/m)
1	*2462.00	125.4 PK			1.53 V	285	125.8	-0.4
2	*2462.00	116.4 AV			1.53 V	285	116.8	-0.4
3	2483.50	60.9 PK	74.0	-13.1	1.53 V	285	61.3	-0.4
4	2483.50	47.2 AV	54.0	-6.8	1.53 V	285	47.6	-0.4
5	4924.00	56.1 PK	74.0	-17.9	1.33 V	175	51.6	4.5
6	4924.00	44.2 AV	54.0	-9.8	1.33 V	175	39.7	4.5
7	7386.00	48.3 PK	74.0	-25.7	2.37 V	350	36.8	11.5
8	7386.00	37.4 AV	54.0	-16.6	2.37 V	350	25.9	11.5

Remarks:

1. Emission Level(dBuV/m) = Raw Value(dBuV) + Correction Factor(dB/m)
2. Correction Factor(dB/m) = Antenna Factor(dB/m) + Cable Factor(dB) – Pre-Amplifier Factor(dB)
3. Margin value = Emission Level – Limit value
4. The other emission levels were very low against the limit.
5. " * " : Fundamental frequency, the limit was restricted at the RF Output Power.

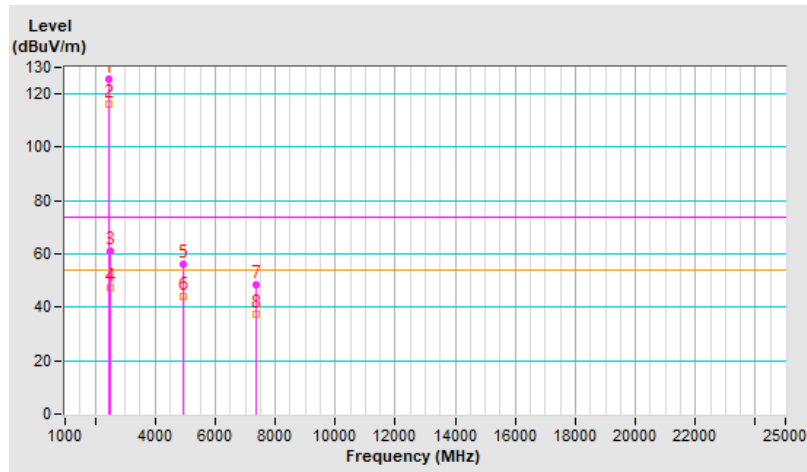

RF Mode	802.11ax (HE20)	Channel	CH 1 : 2412 MHz
Frequency Range	1 GHz ~ 25 GHz	Detector Function & Bandwidth	PK: RB=1 MHz, VB=3 MHz, DET=Peak AV: RB=1 MHz, VB=10 Hz, DET=Peak
Input Power	120 Vac, 60 Hz	Environmental Conditions	22°C, 69% RH
Tested By	Sampson Chen		

Antenna Polarity & Test Distance : Horizontal at 3 m								
No	Frequency (MHz)	Emission Level (dBuV/m)	Limit (dBuV/m)	Margin (dB)	Antenna Height (m)	Table Angle (Degree)	Raw Value (dBuV)	Correction Factor (dB/m)
1	2390.00	66.9 PK	74.0	-7.1	1.34 H	360	67.3	-0.4
2	2390.00	47.7 AV	54.0	-6.3	1.34 H	360	48.1	-0.4
3	*2412.00	125.2 PK			1.34 H	360	125.6	-0.4
4	*2412.00	113.9 AV			1.34 H	360	114.3	-0.4
5	4824.00	52.1 PK	74.0	-21.9	2.27 H	33	47.8	4.3
6	4824.00	40.9 AV	54.0	-13.1	2.27 H	33	36.6	4.3

Remarks:

1. Emission Level(dBuV/m) = Raw Value(dBuV) + Correction Factor(dB/m)
2. Correction Factor(dB/m) = Antenna Factor(dB/m) + Cable Factor(dB) – Pre-Amplifier Factor(dB)
3. Margin value = Emission Level – Limit value
4. The other emission levels were very low against the limit.
5. " * " : Fundamental frequency, the limit was restricted at the RF Output Power.

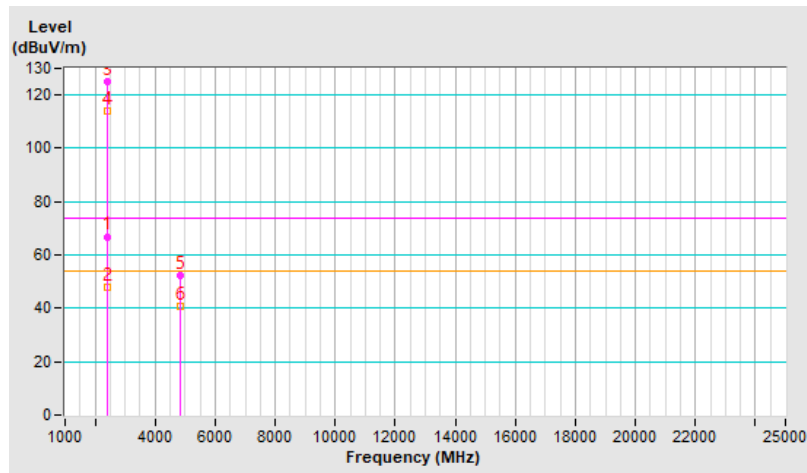

RF Mode	802.11ax (HE20)	Channel	CH 1 : 2412 MHz
Frequency Range	1 GHz ~ 25 GHz	Detector Function & Bandwidth	PK: RB=1 MHz, VB=3 MHz, DET=Peak AV: RB=1 MHz, VB=10 Hz, DET=Peak
Input Power	120 Vac, 60 Hz	Environmental Conditions	22°C, 69% RH
Tested By	Sampson Chen		

Antenna Polarity & Test Distance : Vertical at 3 m								
No	Frequency (MHz)	Emission Level (dBuV/m)	Limit (dBuV/m)	Margin (dB)	Antenna Height (m)	Table Angle (Degree)	Raw Value (dBuV)	Correction Factor (dB/m)
1	2390.00	72.3 PK	74.0	-1.7	1.28 V	85	72.7	-0.4
2	2390.00	53.9 AV	54.0	-0.1	1.28 V	85	54.3	-0.4
3	*2412.00	126.0 PK			1.28 V	85	126.4	-0.4
4	*2412.00	114.6 AV			1.28 V	85	115.0	-0.4
5	4824.00	56.9 PK	74.0	-17.1	1.31 V	186	52.6	4.3
6	4824.00	44.7 AV	54.0	-9.3	1.31 V	186	40.4	4.3

Remarks:

1. Emission Level(dBuV/m) = Raw Value(dBuV) + Correction Factor(dB/m)
2. Correction Factor(dB/m) = Antenna Factor(dB/m) + Cable Factor(dB) – Pre-Amplifier Factor(dB)
3. Margin value = Emission Level – Limit value
4. The other emission levels were very low against the limit.
5. " * " : Fundamental frequency, the limit was restricted at the RF Output Power.

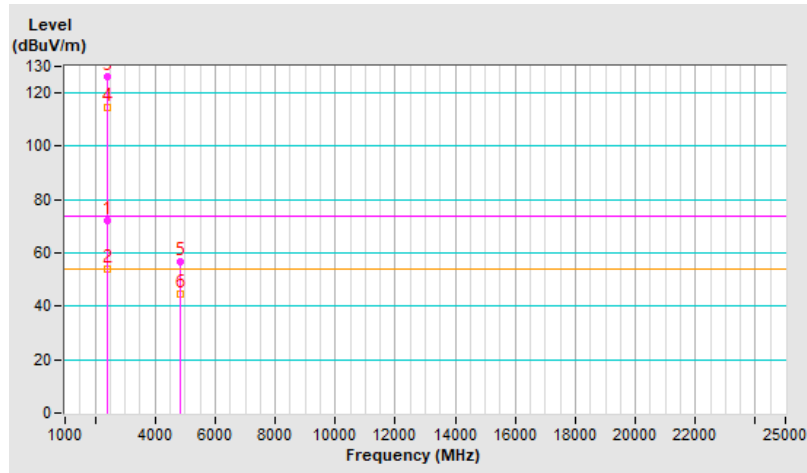

RF Mode	802.11ax (HE20)	Channel	CH 6 : 2437 MHz
Frequency Range	1 GHz ~ 25 GHz	Detector Function & Bandwidth	PK: RB=1 MHz, VB=3 MHz, DET=Peak AV: RB=1 MHz, VB=10 Hz, DET=Peak
Input Power	120 Vac, 60 Hz	Environmental Conditions	22°C, 69% RH
Tested By	Sampson Chen		

Antenna Polarity & Test Distance : Horizontal at 3 m								
No	Frequency (MHz)	Emission Level (dBuV/m)	Limit (dBuV/m)	Margin (dB)	Antenna Height (m)	Table Angle (Degree)	Raw Value (dBuV)	Correction Factor (dB/m)
1	2390.00	57.0 PK	74.0	-17.0	1.47 H	358	57.4	-0.4
2	2390.00	43.8 AV	54.0	-10.2	1.47 H	358	44.2	-0.4
3	*2437.00	126.0 PK			1.47 H	358	126.3	-0.3
4	*2437.00	114.2 AV			1.47 H	358	114.5	-0.3
5	2483.50	56.9 PK	74.0	-17.1	1.47 H	358	57.3	-0.4
6	2483.50	43.9 AV	54.0	-10.1	1.47 H	358	44.3	-0.4
7	4874.00	51.4 PK	74.0	-22.6	2.23 H	34	47.0	4.4
8	4874.00	40.4 AV	54.0	-13.6	2.23 H	34	36.0	4.4
9	7311.00	47.2 PK	74.0	-26.8	1.46 H	8	35.8	11.4
10	7311.00	35.8 AV	54.0	-18.2	1.46 H	8	24.4	11.4

Remarks:

1. Emission Level(dBuV/m) = Raw Value(dBuV) + Correction Factor(dB/m)
2. Correction Factor(dB/m) = Antenna Factor(dB/m) + Cable Factor(dB) – Pre-Amplifier Factor(dB)
3. Margin value = Emission Level – Limit value
4. The other emission levels were very low against the limit.
5. " * " : Fundamental frequency, the limit was restricted at the RF Output Power.

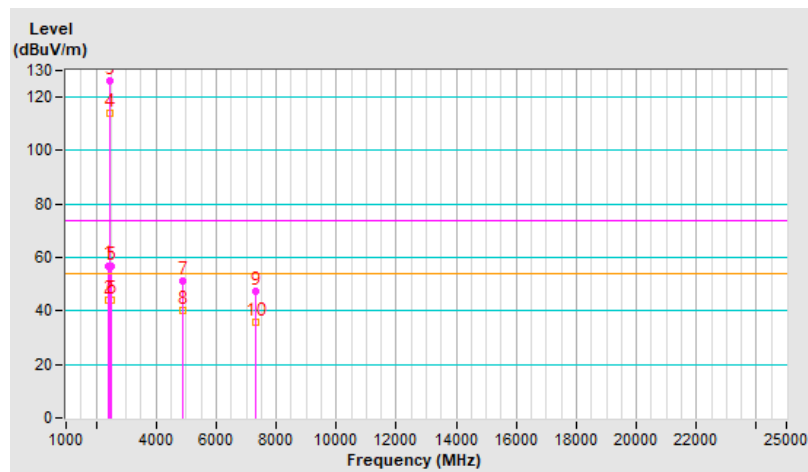

RF Mode	802.11ax (HE20)	Channel	CH 6 : 2437 MHz
Frequency Range	1 GHz ~ 25 GHz	Detector Function & Bandwidth	PK: RB=1 MHz, VB=3 MHz, DET=Peak AV: RB=1 MHz, VB=10 Hz, DET=Peak
Input Power	120 Vac, 60 Hz	Environmental Conditions	22°C, 69% RH
Tested By	Sampson Chen		

Antenna Polarity & Test Distance : Vertical at 3 m								
No	Frequency (MHz)	Emission Level (dBuV/m)	Limit (dBuV/m)	Margin (dB)	Antenna Height (m)	Table Angle (Degree)	Raw Value (dBuV)	Correction Factor (dB/m)
1	2390.00	57.4 PK	74.0	-16.6	1.46 V	84	57.8	-0.4
2	2390.00	44.0 AV	54.0	-10.0	1.46 V	84	44.4	-0.4
3	*2437.00	127.3 PK			1.46 V	84	127.6	-0.3
4	*2437.00	115.1 AV			1.46 V	84	115.4	-0.3
5	2483.50	57.1 PK	74.0	-16.9	1.46 V	84	57.5	-0.4
6	2483.50	44.0 AV	54.0	-10.0	1.46 V	84	44.4	-0.4
7	4874.00	55.9 PK	74.0	-18.1	1.33 V	176	51.5	4.4
8	4874.00	43.9 AV	54.0	-10.1	1.33 V	176	39.5	4.4
9	7311.00	48.1 PK	74.0	-25.9	2.43 V	344	36.7	11.4
10	7311.00	37.3 AV	54.0	-16.7	2.43 V	344	25.9	11.4

Remarks:

1. Emission Level(dBuV/m) = Raw Value(dBuV) + Correction Factor(dB/m)
2. Correction Factor(dB/m) = Antenna Factor(dB/m) + Cable Factor(dB) – Pre-Amplifier Factor(dB)
3. Margin value = Emission Level – Limit value
4. The other emission levels were very low against the limit.
5. " * ": Fundamental frequency, the limit was restricted at the RF Output Power.

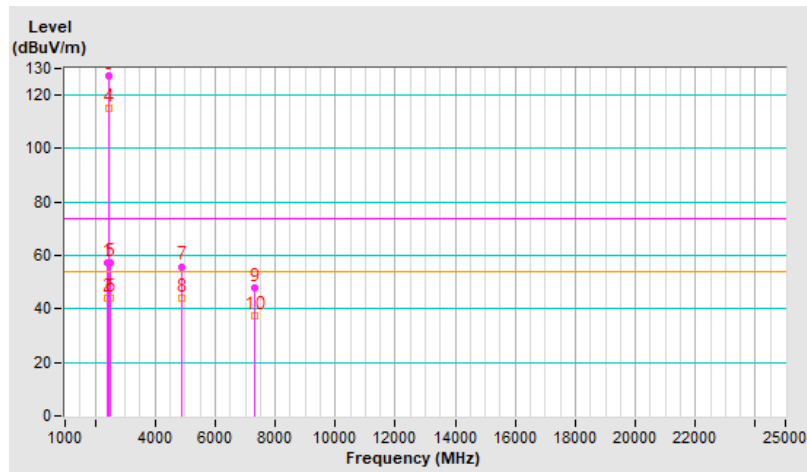

RF Mode	802.11ax (HE20)	Channel	CH 11 : 2462 MHz
Frequency Range	1 GHz ~ 25 GHz	Detector Function & Bandwidth	PK: RB=1 MHz, VB=3 MHz, DET=Peak AV: RB=1 MHz, VB=10 Hz, DET=Peak
Input Power	120 Vac, 60 Hz	Environmental Conditions	22°C, 69% RH
Tested By	Sampson Chen		

Antenna Polarity & Test Distance : Horizontal at 3 m								
No	Frequency (MHz)	Emission Level (dBuV/m)	Limit (dBuV/m)	Margin (dB)	Antenna Height (m)	Table Angle (Degree)	Raw Value (dBuV)	Correction Factor (dB/m)
1	*2462.00	125.6 PK			1.61 H	174	126.0	-0.4
2	*2462.00	113.2 AV			1.61 H	174	113.6	-0.4
3	2483.50	64.2 PK	74.0	-9.8	1.61 H	174	64.6	-0.4
4	2483.50	50.0 AV	54.0	-4.0	1.61 H	174	50.4	-0.4
5	4924.00	51.7 PK	74.0	-22.3	2.22 H	27	47.2	4.5
6	4924.00	40.6 AV	54.0	-13.4	2.22 H	27	36.1	4.5
7	7386.00	46.9 PK	74.0	-27.1	1.49 H	10	35.4	11.5
8	7386.00	35.2 AV	54.0	-18.8	1.49 H	10	23.7	11.5

Remarks:

1. Emission Level(dBuV/m) = Raw Value(dBuV) + Correction Factor(dB/m)
2. Correction Factor(dB/m) = Antenna Factor(dB/m) + Cable Factor(dB) – Pre-Amplifier Factor(dB)
3. Margin value = Emission Level – Limit value
4. The other emission levels were very low against the limit.
5. " * " : Fundamental frequency, the limit was restricted at the RF Output Power.

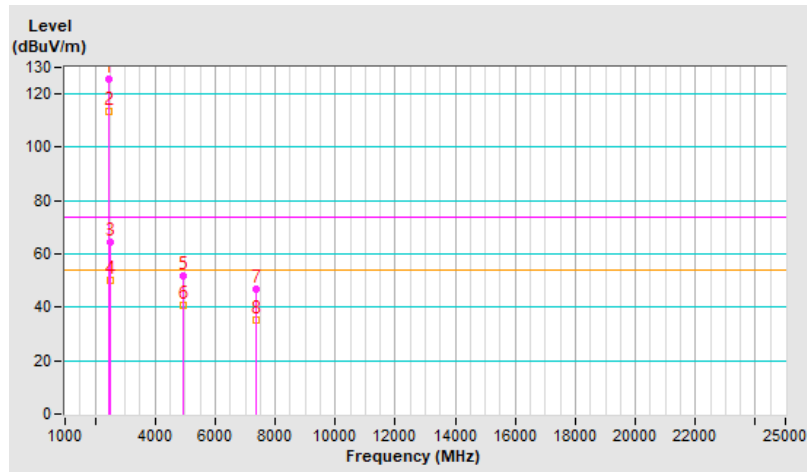

RF Mode	802.11ax (HE20)	Channel	CH 11 : 2462 MHz
Frequency Range	1 GHz ~ 25 GHz	Detector Function & Bandwidth	PK: RB=1 MHz, VB=3 MHz, DET=Peak AV: RB=1 MHz, VB=10 Hz, DET=Peak
Input Power	120 Vac, 60 Hz	Environmental Conditions	22°C, 69% RH
Tested By	Sampson Chen		

Antenna Polarity & Test Distance : Vertical at 3 m								
No	Frequency (MHz)	Emission Level (dBuV/m)	Limit (dBuV/m)	Margin (dB)	Antenna Height (m)	Table Angle (Degree)	Raw Value (dBuV)	Correction Factor (dB/m)
1	*2462.00	126.2 PK			1.38 V	80	126.6	-0.4
2	*2462.00	114.7 AV			1.38 V	80	115.1	-0.4
3	2483.50	70.5 PK	74.0	-3.5	1.38 V	80	70.9	-0.4
4	2483.50	53.5 AV	54.0	-0.5	1.38 V	80	53.9	-0.4
5	4924.00	56.5 PK	74.0	-17.5	1.39 V	166	52.0	4.5
6	4924.00	44.4 AV	54.0	-9.6	1.39 V	166	39.9	4.5
7	7386.00	48.2 PK	74.0	-25.8	2.42 V	337	36.7	11.5
8	7386.00	37.3 AV	54.0	-16.7	2.42 V	337	25.8	11.5

Remarks:

1. Emission Level(dBuV/m) = Raw Value(dBuV) + Correction Factor(dB/m)
2. Correction Factor(dB/m) = Antenna Factor(dB/m) + Cable Factor(dB) – Pre-Amplifier Factor(dB)
3. Margin value = Emission Level – Limit value
4. The other emission levels were very low against the limit.
5. " * " : Fundamental frequency, the limit was restricted at the RF Output Power.

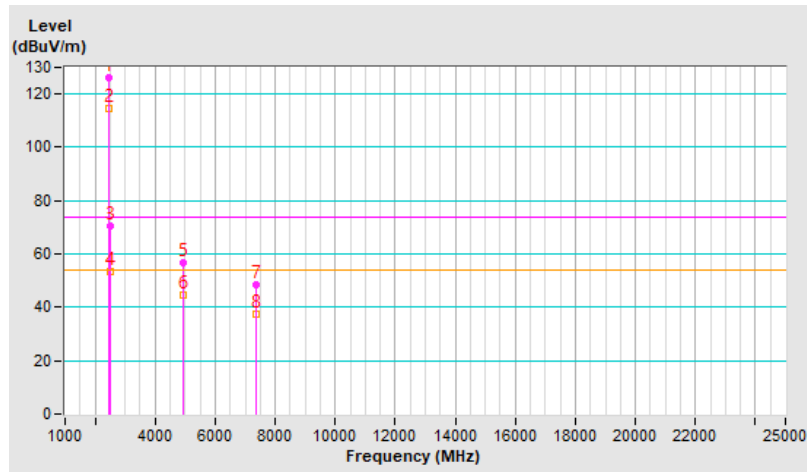

RF Mode	802.11ax (HE40)	Channel	CH 3 : 2422 MHz
Frequency Range	1 GHz ~ 25 GHz	Detector Function & Bandwidth	PK: RB=1 MHz, VB=3 MHz, DET=Peak AV: RB=1 MHz, VB=10 Hz, DET=Peak
Input Power	120 Vac, 60 Hz	Environmental Conditions	22°C, 69% RH
Tested By	Sampson Chen		

Antenna Polarity & Test Distance : Horizontal at 3 m								
No	Frequency (MHz)	Emission Level (dBuV/m)	Limit (dBuV/m)	Margin (dB)	Antenna Height (m)	Table Angle (Degree)	Raw Value (dBuV)	Correction Factor (dB/m)
1	2387.90	60.2 PK	74.0	-13.8	1.51 H	177	60.6	-0.4
2	2387.90	46.7 AV	54.0	-7.3	1.51 H	177	47.1	-0.4
3	*2422.00	121.6 PK			1.51 H	177	121.9	-0.3
4	*2422.00	109.3 AV			1.51 H	177	109.6	-0.3
5	4844.00	52.0 PK	74.0	-22.0	2.21 H	46	47.7	4.3
6	4844.00	40.8 AV	54.0	-13.2	2.21 H	46	36.5	4.3
7	7266.00	47.1 PK	74.0	-26.9	1.51 H	12	35.9	11.2
8	7266.00	35.7 AV	54.0	-18.3	1.51 H	12	24.5	11.2

Remarks:

1. Emission Level(dBuV/m) = Raw Value(dBuV) + Correction Factor(dB/m)
2. Correction Factor(dB/m) = Antenna Factor(dB/m) + Cable Factor(dB) – Pre-Amplifier Factor(dB)
3. Margin value = Emission Level – Limit value
4. The other emission levels were very low against the limit.
5. " * ": Fundamental frequency, the limit was restricted at the RF Output Power.

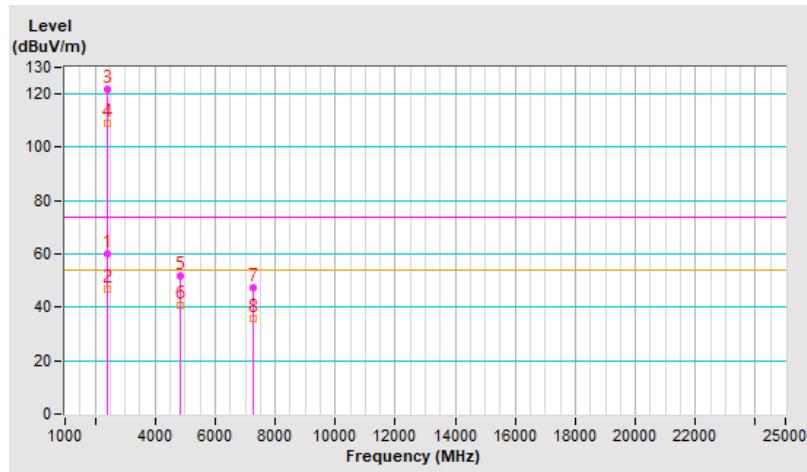

RF Mode	802.11ax (HE40)	Channel	CH 3 : 2422 MHz
Frequency Range	1 GHz ~ 25 GHz	Detector Function & Bandwidth	PK: RB=1 MHz, VB=3 MHz, DET=Peak AV: RB=1 MHz, VB=10 Hz, DET=Peak
Input Power	120 Vac, 60 Hz	Environmental Conditions	22°C, 69% RH
Tested By	Sampson Chen		

Antenna Polarity & Test Distance : Vertical at 3 m								
No	Frequency (MHz)	Emission Level (dBuV/m)	Limit (dBuV/m)	Margin (dB)	Antenna Height (m)	Table Angle (Degree)	Raw Value (dBuV)	Correction Factor (dB/m)
1	2390.00	68.2 PK	74.0	-5.8	1.26 V	85	68.6	-0.4
2	2390.00	53.5 AV	54.0	-0.5	1.26 V	85	53.9	-0.4
3	*2422.00	122.2 PK			1.26 V	85	122.5	-0.3
4	*2422.00	110.7 AV			1.26 V	85	111.0	-0.3
5	4844.00	53.8 PK	74.0	-20.2	1.30 V	173	49.5	4.3
6	4844.00	41.8 AV	54.0	-12.2	1.30 V	173	37.5	4.3
7	7266.00	45.6 PK	74.0	-28.4	2.31 V	335	34.4	11.2
8	7266.00	34.8 AV	54.0	-19.2	2.31 V	335	23.6	11.2

Remarks:

1. Emission Level(dBuV/m) = Raw Value(dBuV) + Correction Factor(dB/m)
2. Correction Factor(dB/m) = Antenna Factor(dB/m) + Cable Factor(dB) – Pre-Amplifier Factor(dB)
3. Margin value = Emission Level – Limit value
4. The other emission levels were very low against the limit.
5. " * ": Fundamental frequency, the limit was restricted at the RF Output Power.

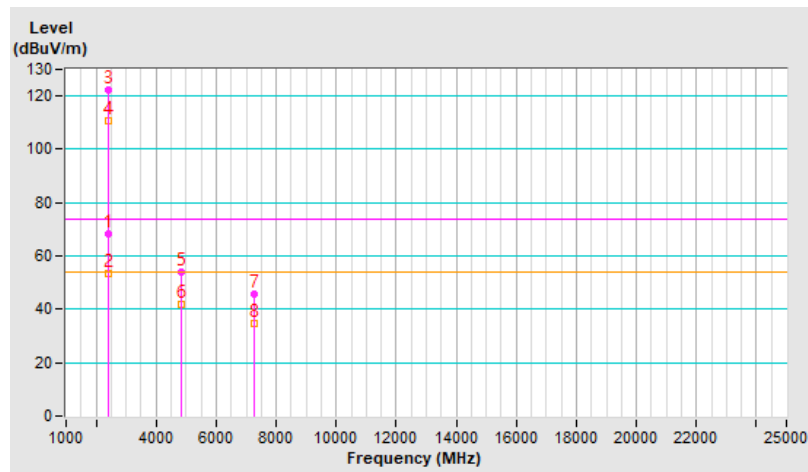

RF Mode	802.11ax (HE40)	Channel	CH 6 : 2437 MHz
Frequency Range	1 GHz ~ 25 GHz	Detector Function & Bandwidth	PK: RB=1 MHz, VB=3 MHz, DET=Peak AV: RB=1 MHz, VB=10 Hz, DET=Peak
Input Power	120 Vac, 60 Hz	Environmental Conditions	22°C, 69% RH
Tested By	Sampson Chen		

Antenna Polarity & Test Distance : Horizontal at 3 m								
No	Frequency (MHz)	Emission Level (dBuV/m)	Limit (dBuV/m)	Margin (dB)	Antenna Height (m)	Table Angle (Degree)	Raw Value (dBuV)	Correction Factor (dB/m)
1	2390.00	64.3 PK	74.0	-9.7	1.52 H	188	64.7	-0.4
2	2390.00	49.8 AV	54.0	-4.2	1.52 H	188	50.2	-0.4
3	*2437.00	123.8 PK			1.52 H	188	124.1	-0.3
4	*2437.00	111.3 AV			1.52 H	188	111.6	-0.3
5	2483.50	69.7 PK	74.0	-4.3	1.52 H	188	70.1	-0.4
6	2483.50	50.8 AV	54.0	-3.2	1.52 H	188	51.2	-0.4
7	4874.00	51.5 PK	74.0	-22.5	2.21 H	31	47.1	4.4
8	4874.00	40.6 AV	54.0	-13.4	2.21 H	31	36.2	4.4
9	7311.00	46.9 PK	74.0	-27.1	1.44 H	20	35.5	11.4
10	7311.00	35.5 AV	54.0	-18.5	1.44 H	20	24.1	11.4

Remarks:

1. Emission Level(dBuV/m) = Raw Value(dBuV) + Correction Factor(dB/m)
2. Correction Factor(dB/m) = Antenna Factor(dB/m) + Cable Factor(dB) – Pre-Amplifier Factor(dB)
3. Margin value = Emission Level – Limit value
4. The other emission levels were very low against the limit.
5. " * ": Fundamental frequency, the limit was restricted at the RF Output Power.

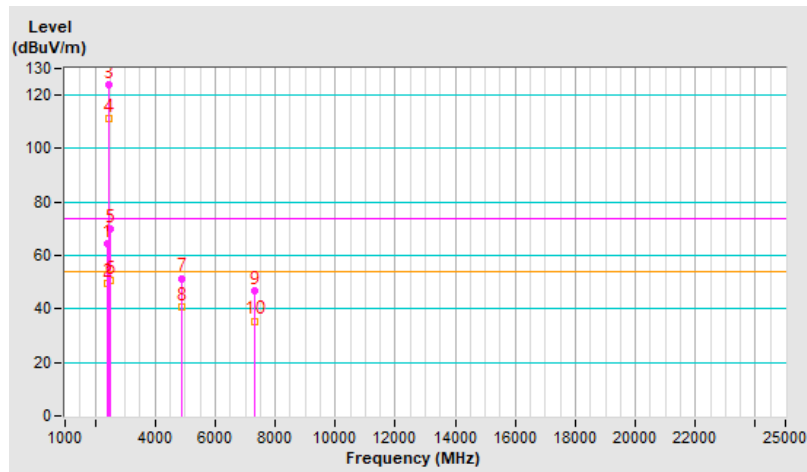

RF Mode	802.11ax (HE40)	Channel	CH 6 : 2437 MHz
Frequency Range	1 GHz ~ 25 GHz	Detector Function & Bandwidth	PK: RB=1 MHz, VB=3 MHz, DET=Peak AV: RB=1 MHz, VB=10 Hz, DET=Peak
Input Power	120 Vac, 60 Hz	Environmental Conditions	22°C, 69% RH
Tested By	Sampson Chen		

Antenna Polarity & Test Distance : Vertical at 3 m								
No	Frequency (MHz)	Emission Level (dBuV/m)	Limit (dBuV/m)	Margin (dB)	Antenna Height (m)	Table Angle (Degree)	Raw Value (dBuV)	Correction Factor (dB/m)
1	2390.00	67.6 PK	74.0	-6.4	1.46 V	84	68.0	-0.4
2	2390.00	52.5 AV	54.0	-1.5	1.46 V	84	52.9	-0.4
3	*2437.00	124.7 PK			1.46 V	84	125.0	-0.3
4	*2437.00	112.5 AV			1.46 V	84	112.8	-0.3
5	2483.50	72.4 PK	74.0	-1.6	1.46 V	84	72.8	-0.4
6	2483.50	53.8 AV	54.0	-0.2	1.46 V	84	54.2	-0.4
7	4874.00	54.1 PK	74.0	-19.9	1.35 V	165	49.7	4.4
8	4874.00	42.4 AV	54.0	-11.6	1.35 V	165	38.0	4.4
9	7311.00	46.9 PK	74.0	-27.1	2.37 V	344	35.5	11.4
10	7311.00	35.8 AV	54.0	-18.2	2.37 V	344	24.4	11.4

Remarks:

1. Emission Level(dBuV/m) = Raw Value(dBuV) + Correction Factor(dB/m)
2. Correction Factor(dB/m) = Antenna Factor(dB/m) + Cable Factor(dB) – Pre-Amplifier Factor(dB)
3. Margin value = Emission Level – Limit value
4. The other emission levels were very low against the limit.
5. " * " : Fundamental frequency, the limit was restricted at the RF Output Power.

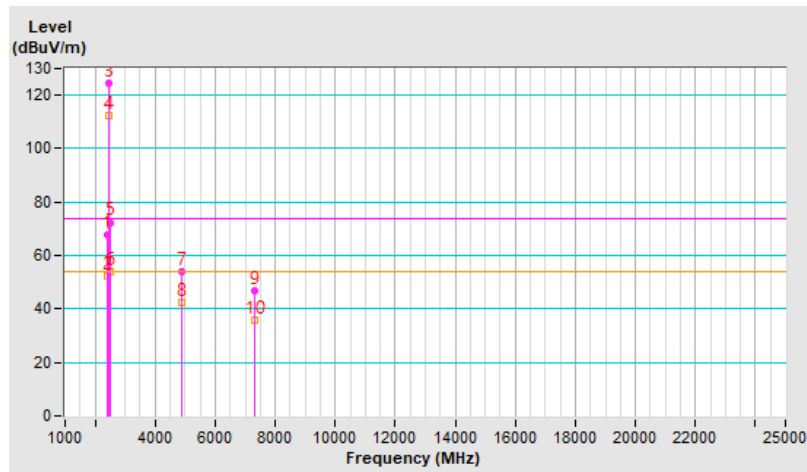

RF Mode	802.11ax (HE40)	Channel	CH 9 : 2452 MHz
Frequency Range	1 GHz ~ 25 GHz	Detector Function & Bandwidth	PK: RB=1 MHz, VB=3 MHz, DET=Peak AV: RB=1 MHz, VB=10 Hz, DET=Peak
Input Power	120 Vac, 60 Hz	Environmental Conditions	22°C, 69% RH
Tested By	Sampson Chen		

Antenna Polarity & Test Distance : Horizontal at 3 m								
No	Frequency (MHz)	Emission Level (dBuV/m)	Limit (dBuV/m)	Margin (dB)	Antenna Height (m)	Table Angle (Degree)	Raw Value (dBuV)	Correction Factor (dB/m)
1	*2452.00	120.2 PK			1.50 H	112	120.6	-0.4
2	*2452.00	108.5 AV			1.50 H	112	108.9	-0.4
3	2483.50	62.7 PK	74.0	-11.3	1.50 H	112	63.1	-0.4
4	2483.50	48.8 AV	54.0	-5.2	1.50 H	112	49.2	-0.4
5	4904.00	51.8 PK	74.0	-22.2	2.21 H	21	47.4	4.4
6	4904.00	40.8 AV	54.0	-13.2	2.21 H	21	36.4	4.4
7	7356.00	46.7 PK	74.0	-27.3	1.40 H	19	35.1	11.6
8	7356.00	35.3 AV	54.0	-18.7	1.40 H	19	23.7	11.6

Remarks:

1. Emission Level(dBuV/m) = Raw Value(dBuV) + Correction Factor(dB/m)
2. Correction Factor(dB/m) = Antenna Factor(dB/m) + Cable Factor(dB) – Pre-Amplifier Factor(dB)
3. Margin value = Emission Level – Limit value
4. The other emission levels were very low against the limit.
5. " * ": Fundamental frequency, the limit was restricted at the RF Output Power.

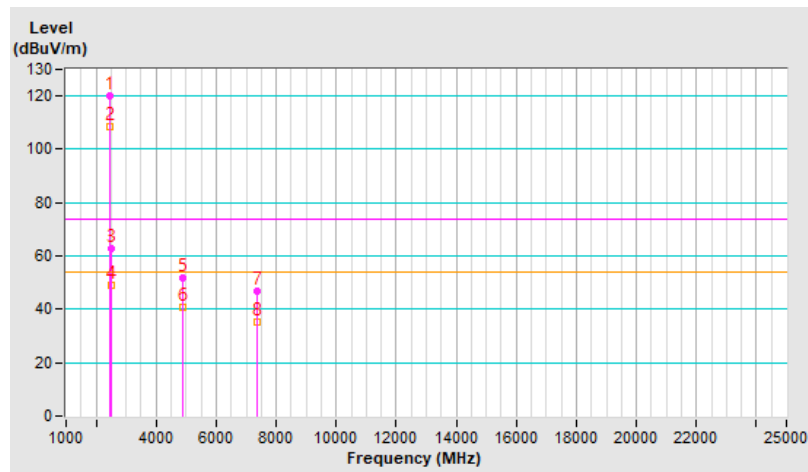

RF Mode	802.11ax (HE40)	Channel	CH 9 : 2452 MHz
Frequency Range	1 GHz ~ 25 GHz	Detector Function & Bandwidth	PK: RB=1 MHz, VB=3 MHz, DET=Peak AV: RB=1 MHz, VB=10 Hz, DET=Peak
Input Power	120 Vac, 60 Hz	Environmental Conditions	22°C, 69% RH
Tested By	Sampson Chen		

Antenna Polarity & Test Distance : Vertical at 3 m								
No	Frequency (MHz)	Emission Level (dBuV/m)	Limit (dBuV/m)	Margin (dB)	Antenna Height (m)	Table Angle (Degree)	Raw Value (dBuV)	Correction Factor (dB/m)
1	*2452.00	123.1 PK			1.41 V	81	123.5	-0.4
2	*2452.00	110.6 AV			1.41 V	81	111.0	-0.4
3	2483.50	70.9 PK	74.0	-3.1	1.41 V	81	71.3	-0.4
4	2483.50	53.8 AV	54.0	-0.2	1.41 V	81	54.2	-0.4
5	4904.00	53.6 PK	74.0	-20.4	1.27 V	166	49.2	4.4
6	4904.00	41.4 AV	54.0	-12.6	1.27 V	166	37.0	4.4
7	7356.00	45.6 PK	74.0	-28.4	2.30 V	343	34.0	11.6
8	7356.00	34.6 AV	54.0	-19.4	2.30 V	343	23.0	11.6

Remarks:

1. Emission Level(dBuV/m) = Raw Value(dBuV) + Correction Factor(dB/m)
2. Correction Factor(dB/m) = Antenna Factor(dB/m) + Cable Factor(dB) – Pre-Amplifier Factor(dB)
3. Margin value = Emission Level – Limit value
4. The other emission levels were very low against the limit.
5. " * " : Fundamental frequency, the limit was restricted at the RF Output Power.

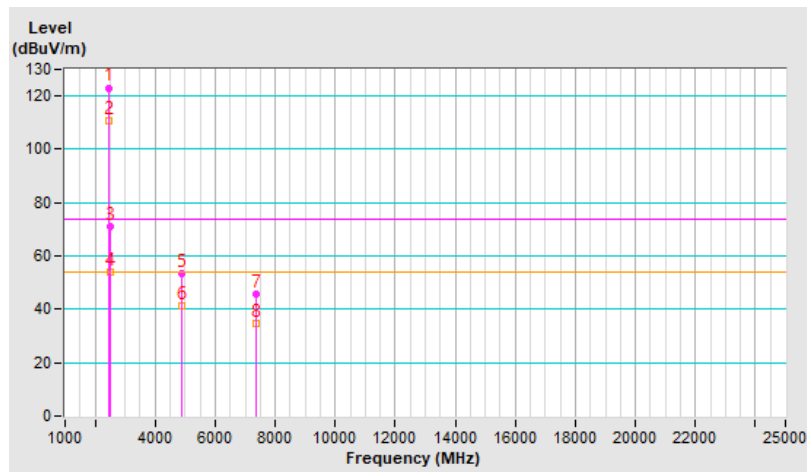

Plot of Band Edge

Frequency Range	2.31 GHz ~ 2.5 GHz	Detector Function & Bandwidth	PK: RB=1 MHz, VB=3 MHz, DET=Peak AV: RB=1 MHz, VB=10 Hz, DET=Peak
-----------------	--------------------	-------------------------------	--

802.11b Channel 1

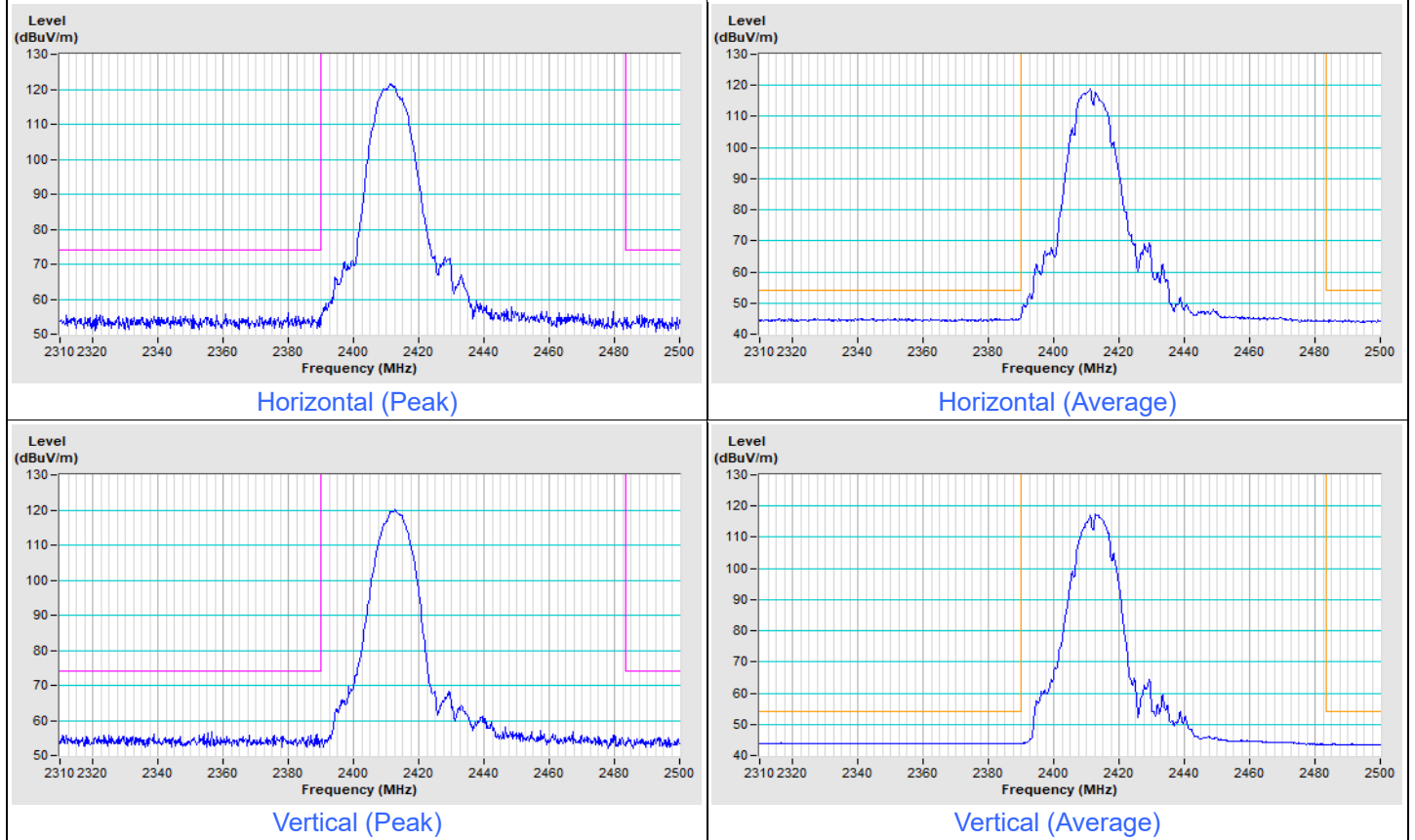

802.11b Channel 11

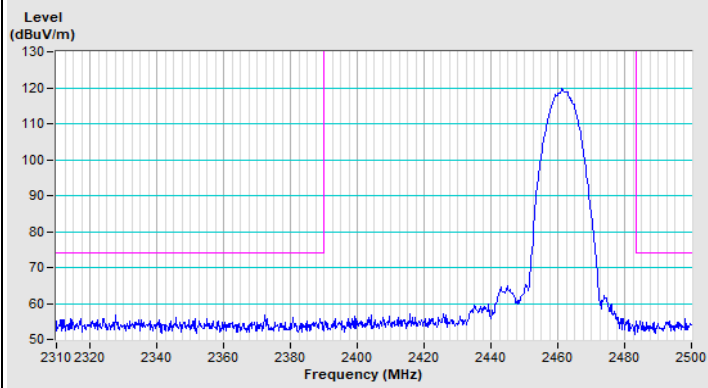

Horizontal (Peak)

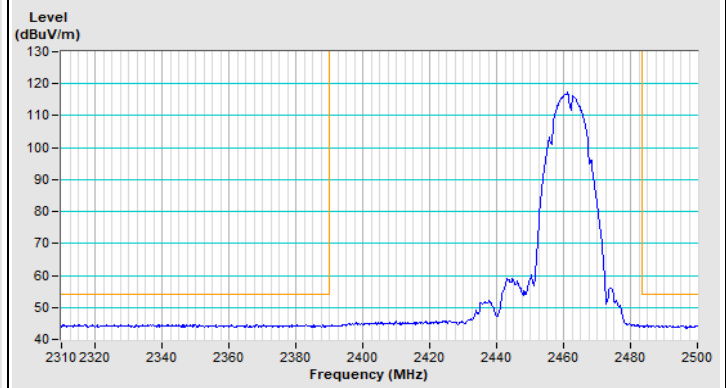

Horizontal (Average)

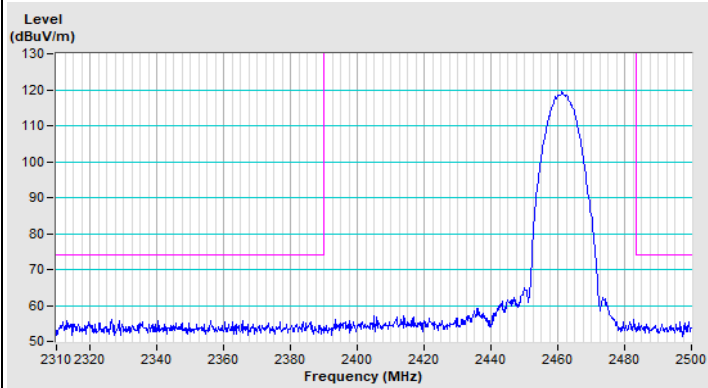

Vertical (Peak)

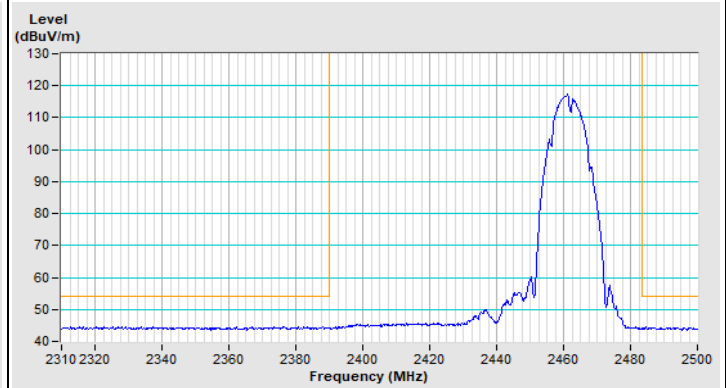

Vertical (Average)

Frequency Range	2.31 GHz ~ 2.5 GHz	Detector Function & Bandwidth	PK: RB=1 MHz, VB=3 MHz, DET=Peak AV: RB=1 MHz, VB=1 kHz, DET=Peak
-----------------	--------------------	-------------------------------	--

802.11g Channel 1

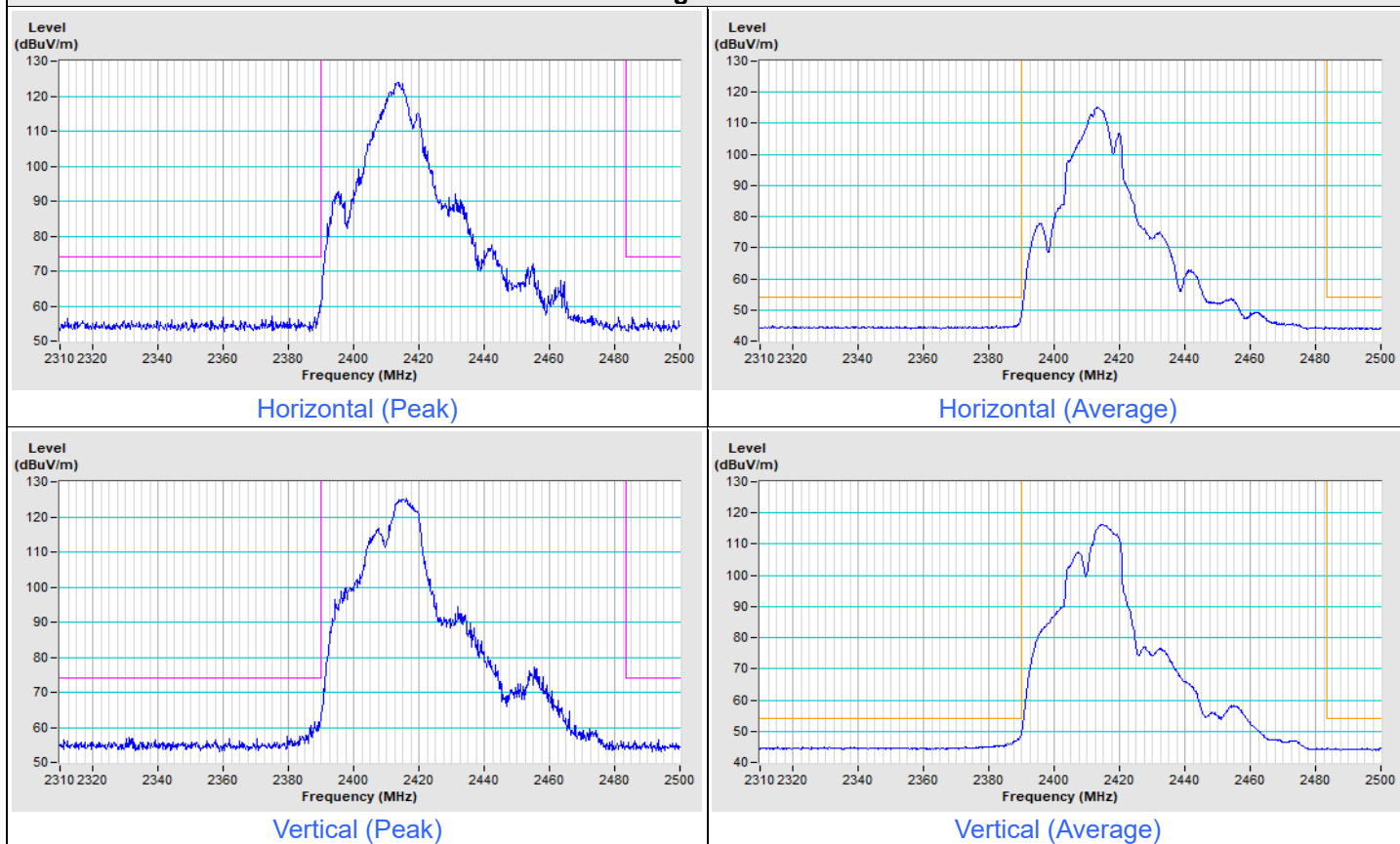

802.11g Channel 11

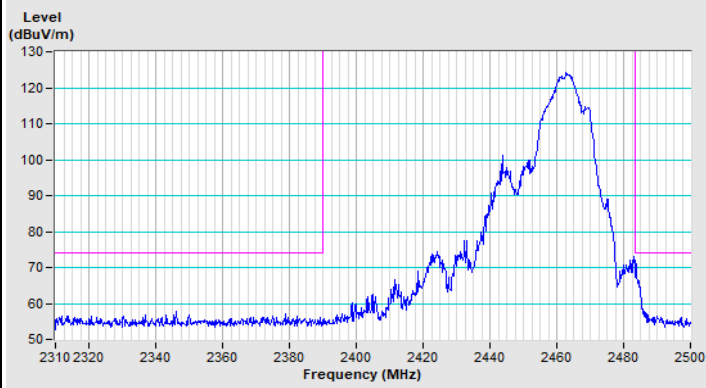

Horizontal (Peak)

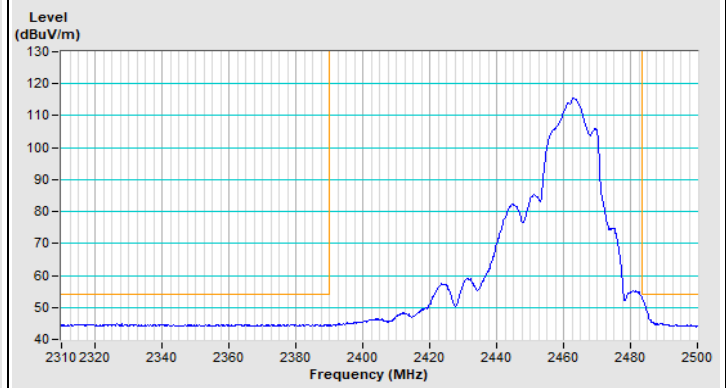

Horizontal (Average)

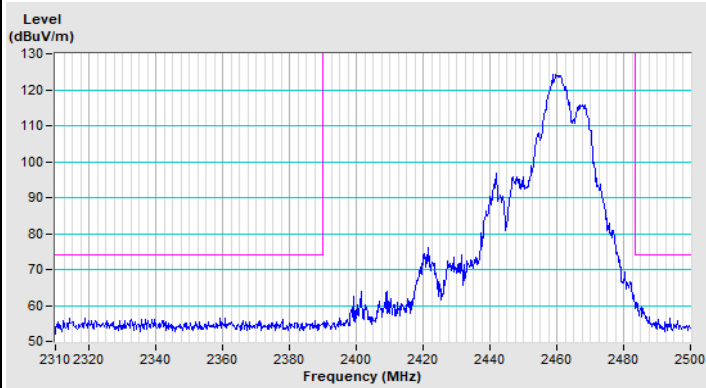

Vertical (Peak)

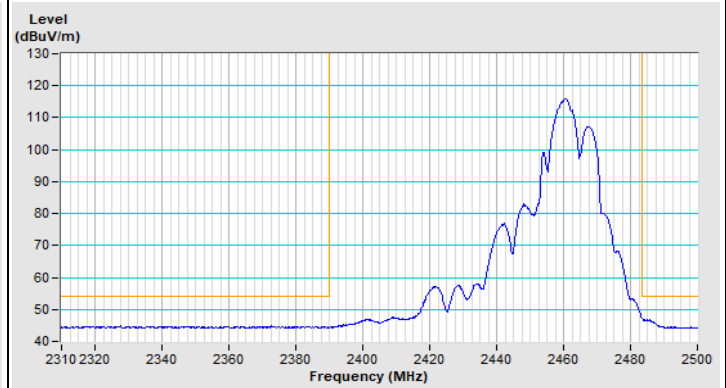

Vertical (Average)

Frequency Range	2.31 GHz ~ 2.5 GHz	Detector Function & Bandwidth	PK: RB=1 MHz, VB=3 MHz, DET=Peak AV: RB=1 MHz, VB=10 Hz, DET=Peak
-----------------	--------------------	-------------------------------	--

802.11ax (HE20) Channel 1

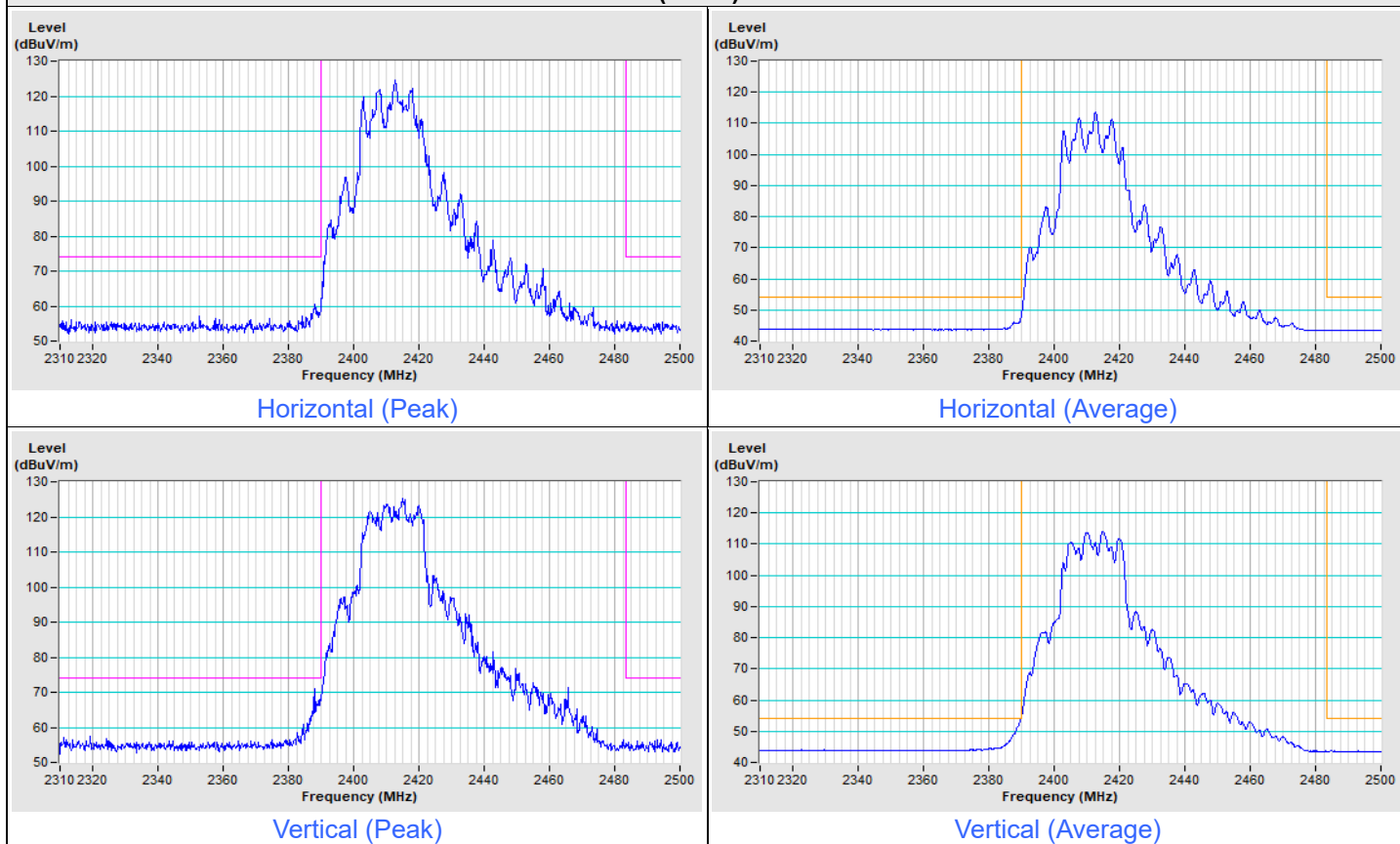

802.11ax (HE20) Channel 11

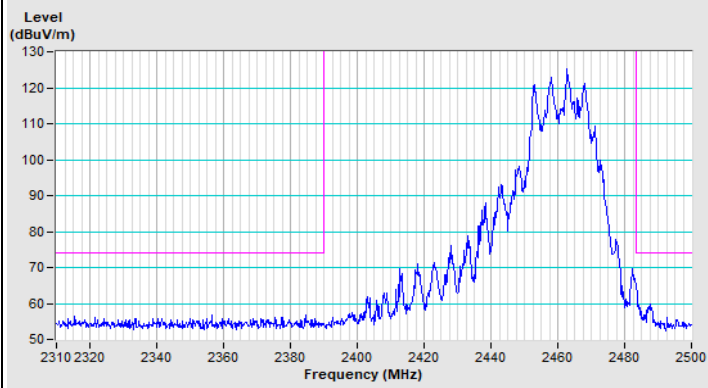

Horizontal (Peak)

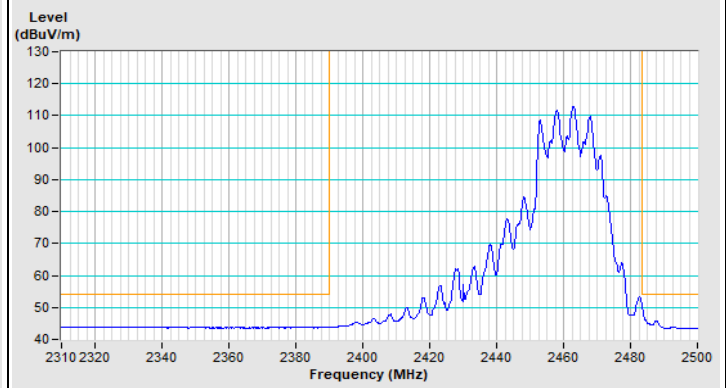

Horizontal (Average)

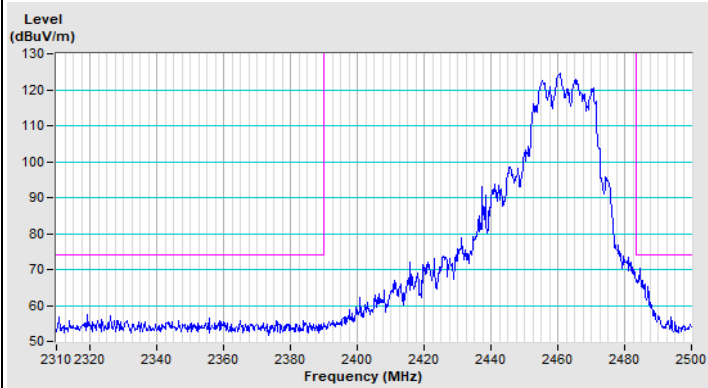

Vertical (Peak)

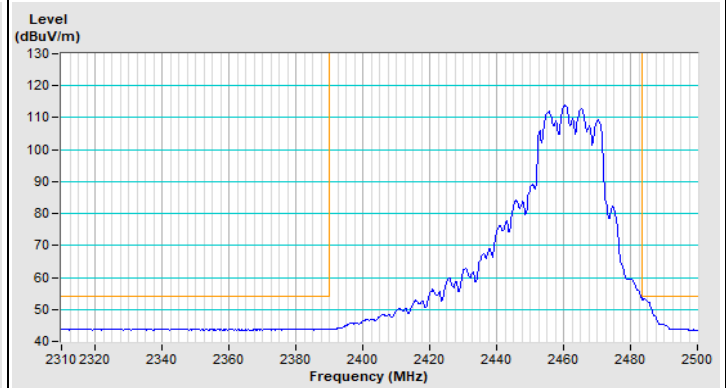

Vertical (Average)

Frequency Range	2.31 GHz ~ 2.5 GHz	Detector Function & Bandwidth	PK: RB=1 MHz, VB=3 MHz, DET=Peak AV: RB=1 MHz, VB=10 Hz, DET=Peak
-----------------	--------------------	-------------------------------	--

802.11ax (HE40) Channel 3

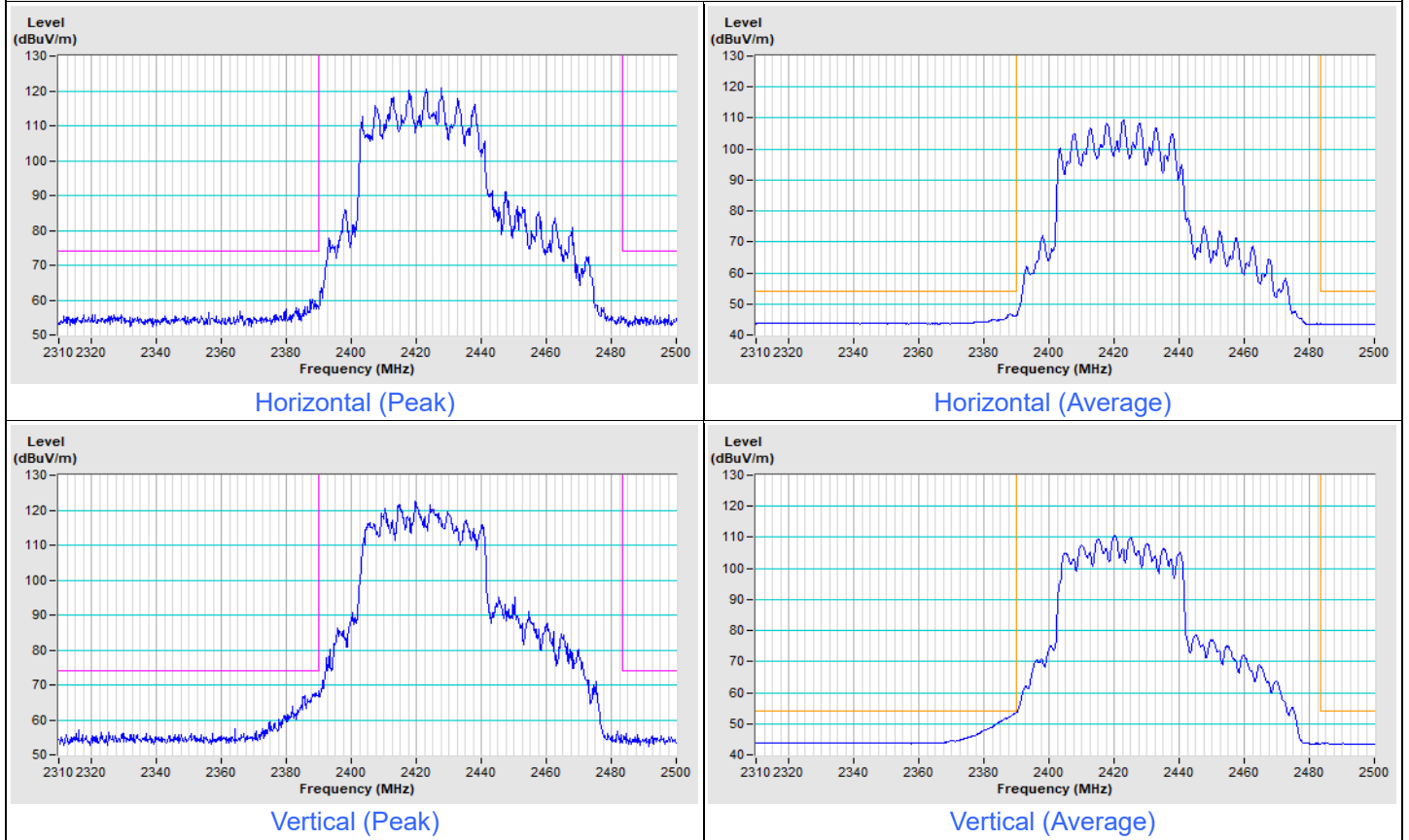

802.11ax (HE40) Channel 9

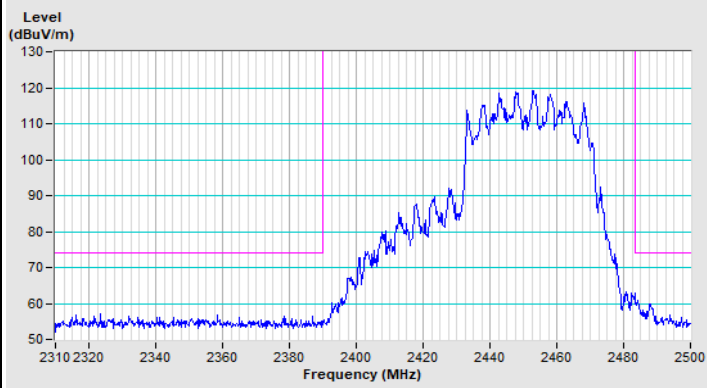

Horizontal (Peak)

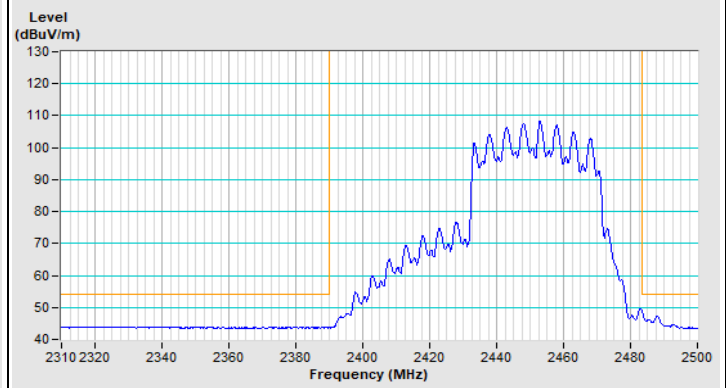

Horizontal (Average)

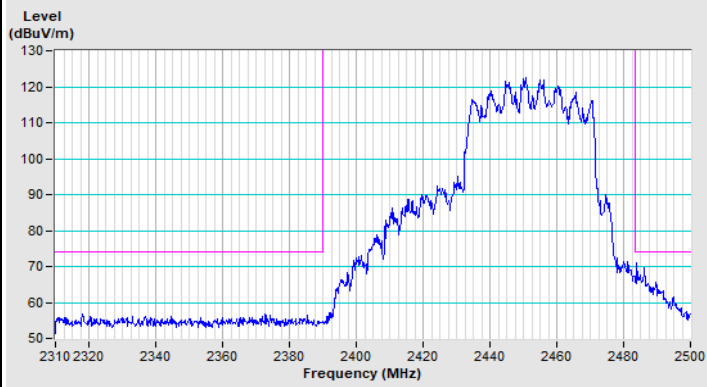

Vertical (Peak)

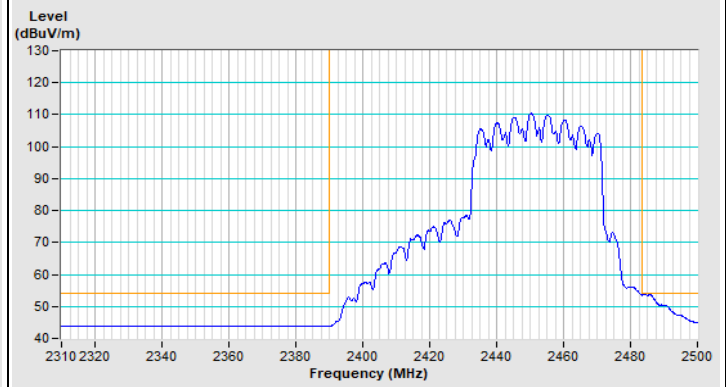

Vertical (Average)

8 Pictures of Test Arrangements

Please refer to the attached file (Test Setup Photo)



9 Information of the Testing Laboratories

We, Bureau Veritas Consumer Products Services (H.K.) Ltd., Taoyuan Branch, were founded in 1988 to provide our best service in EMC, Radio, Telecom and Safety consultation. Our laboratories are FCC recognized accredited test firms and accredited according to ISO/IEC 17025.

If you have any comments, please feel free to contact us at the following:

Lin Kou EMC/RF Lab

Tel: 886-2-26052180

Fax: 886-2-26051924

Hsin Chu EMC/RF/Telecom Lab

Tel: 886-3-6668565

Fax: 886-3-6668323

Hwa Ya EMC/RF/Safety Lab

Tel: 886-3-3183232

Fax: 886-3-3270892

Email: service.adt@bureauveritas.com

Web Site: <http://ee.bureauveritas.com.tw>

The address and road map of all our labs can be found in our web site also.

--- END ---