

FCC RADIO TEST REPORT

FCC ID: 2AWFB-KCWSC

Product: ION UV PRO PHONE SANITIZER
Trade Name: N/A
Model Name: 7609
Serial Model: 7565, BW-UV-01
Report No.: UNIA20061308ER-01

Prepared for

SHENZHEN BWAY TECH CO.,LTD
FL 3, BLDG A, NO 4, LONGSHAN 4TH RD, LUOTIAN COMMUNITY
Shenzhen China

Prepared by

Shenzhen United Testing Technology Co., Ltd.
2F, Annex Bldg, Jiahuangyuan Tech Park, #365 Baotian 1 Rd, Tiegang
Community, Xixiang Str, Bao'an District, Shenzhen, China

TEST RESULT CERTIFICATION

Applicant's name..... : SHENZHEN BWAY TECH CO.,LTD
Address..... : FL 3, BLDG A, NO 4, LONGSHAN 4TH RD, LUOTIAN
COMMUNITY Shenzhen China
Manufacture's Name..... : SHENZHEN BWAY TECH CO.,LTD
Address..... : FL 3, BLDG A, NO 4, LONGSHAN 4TH RD, LUOTIAN
COMMUNITY Shenzhen China

Product description

Product name..... : ION UV PRO PHONE SANITIZER
Trade Mark..... : N/A
Model and/or type reference : 7609, 7565, BW-UV-01
Standards..... : FCC Rules and Regulations Part 15 Subpart C Section 15.209
ANSI C63.10: 2013

This device described above has been tested by Shenzhen United Testing Technology Co., Ltd., and the test results show that the equipment under test (EUT) is in compliance with the FCC requirements. And it is applicable only to the tested sample identified in the report.

This report shall not be reproduced except in full, without the written approval of UNI, this document may be altered or revised by Shenzhen United Testing Technology Co., Ltd., personnel only, and shall be noted in the revision of the document.

Date of Test..... :
Date (s) of performance of tests..... : Jun. 13, 2020 ~Aug. 11, 2020
Date of Issue..... : Aug. 11, 2020
Test Result..... : Pass

Prepared by:

Bob Liao

Bob liao/Editor

Reviewer:

Kahn Yang

Kahn yang/Supervisor

Approved & Authorized Signer:

Liuze

Liuze/Manager

Table of Contents

Page

1 TEST SUMMARY.....	4
2 GENERAL INFORMATION.....	5
2.1 GENERAL DESCRIPTION OF EUT.....	5
2.2 Carrier Frequency of Channels.....	6
2.3 Operation of EUT during testing.....	6
2.4 DESCRIPTION OF TEST SETUP.....	6
2.5 MEASUREMENT INSTRUMENTS LIST.....	7
3 CONDUCTED EMISSION TEST.....	8
3.1 Conducted Power Line Emission Limit.....	8
3.2 Test Setup.....	8
3.3 Test Procedure.....	8
3.4 Test Result.....	8
4 RADIATED EMISSION TEST.....	11
4.1 Block Diagram of Test Setup.....	11
4.2 Rules and specifications.....	12
4.3 Test Procedure.....	13
4.4 Test Result.....	13
5 ANTENNA REQUIREMENT.....	16
6 PHOTOGRAPH OF TEST.....	17
6.1 Radiated Emission.....	17
6.2 Conducted Emission.....	18

1 TEST SUMMARY

TEST PROCEDURES AND RESULTS

DESCRIPTION OF TEST	STANGARD	RESULT
CONDUCTED EMISSION TEST	FCC Part 15.207	COMPLIANT
RADIA TED EMISSION TEST	FCC Part 15.209	COMPLIANT
ANTENNA REQUIREMENT	FCC Part 15.203	COMPLIANT

TEST FACILITY

Test Firm : Shenzhen United Testing Technology Co., Ltd.
 Address : 2F, Annex Bldg, Jiahuangyuan Tech Park, #365 Baotian 1 Rd, Tiegang Community, Xixiang Str, Bao'an District, Shenzhen, China

The testing quality ability of our laboratory meet with "Quality Law of People's Republic of China" Clause 19.The testing quality system of our laboratory meets with ISO/IEC-17025 requirements. This approval result is accepted by MRA of APLAC.

Our test facility is recognized, certified, or accredited by the following organizations:

A2LA Certificate Number: 4747.01

The EMC Laboratory has been accredited by A2LA, and in compliance with ISO/IEC 17025:2017 General Requirements for testing Laboratories.

FCC Registration Number: 674885

The EMC Laboratory has been registered and fully described in a report filed with the (FCC) Federal Communications commission.

IC Registration Number: 21947

The EMC Laboratory has been registered and fully described in a report filed with the (IC) Industry Canada.

MEASUREMENT UNCERTAINTY

Measurement Uncertainty

Conducted Emission Expanded Uncertainty	=	2.23dB, k=2
Radiated emission expanded uncertainty(9kHz-30MHz)	=	3.08dB, k=2
Radiated emission expanded uncertainty(30MHz-1000MHz)	=	4.42dB, k=2
Radiated emission expanded uncertainty(Above 1GHz)	=	4.06dB, k=2

2 GENERAL INFORMATION

2.1 GENERAL DESCRIPTION OF EUT

Equipment	ION UV PRO PHONE SANITIZER
Trade Mark	N/A
Model Name	7609
Serial No.	7565, BW-UV-01
Model Difference	All model's the function, software and electric circuit are the same, only with a product color and model named different. Test sample model: 7609.
FCC ID	2AWFB-KCWSC
Antenna Type	Coil Antenna
Antenna Gain	0dBi
Operation frequency	125KHz
Number of Channels	1CH
Modulation Type	MSK
Battery	N/A
PowerSource	DC 5V from adapter

2.2 Carrier Frequency of Channels

Operation Frequency each of channel	
Channel	Frequency
01	125KHz

2.3 Operation of EUT during testing

Operating Mode

The mode is used: Transmitting mode

2.4 DESCRIPTION OF TEST SETUP

Operation of EUT during testing:



Setup: Transmission mode

Table for auxiliary equipment:

Equipment Description	Manufacturer	Model	Calibration Due Date
Adapter	XinShenHai	P12USB020200	N/A
Mobile phone	MI	Note3	N/A

2.5 MEASUREMENT INSTRUMENTS LIST

Item	Equipment	Manufacturer	Model No.	Serial No.	Calibrated until
Conduction Emissions Measurement					
1	Conducted Emission Test Software	EZ-EMC	Ver.CCS-3A1-CE	N/A	N/A
2	AMN	Schwarzbeck	NNLK8121	8121370	2020.10.15
3	AMN	ETS	3810/2	00020199	2020.10.15
4	AAN	TESEQ	T8-Cat6	38888	2020.10.15
5	Pulse Limiter	CYBRTEK	EM5010	E115010056	2021.05.26
6	EMI Test Receiver	Rohde&Schwarz	ESCI	101210	2020.10.15
Radiated Emissions Measurement					
1	Radiated Emission Test Software	EZ-EMC	Ver.CCS-03A1	N/A	N/A
2	Horn Antenna	Sunol	DRH-118	A101415	2020.10.18
3	Broadband Hybrid Antenna	Sunol	JB1	A090215	2020.11.15
4	PREAMP	HP	8449B	3008A00160	2020.10.21
5	PREAMP	HP	8447D	2944A07999	2021.05.26
6	EMI Test Receiver	Rohde&Schwarz	ESR3	101891	2020.10.15
7	MXA Signal Analyzer	Keysight	N9020A	MY51110104	2020.10.15
8	Active Loop Antenna	Com-Power	AL-310R	10160009	2021.05.28
9	Horn Antenna	Schwarzbeck	BBHA9120D	9120D-1680	2021.05.28
10	Horn Antenna	A-INFOMW	LB-180400-KF	J211060660	2020.10.23
11	Loop Antenna	Beijing daze Technology	ZN30401	13015	2020.10.15
12	EM Clamp	Schwarzbeck	MDS21	03350	2020.10.20

3 CONDUCTED EMISSION TEST

3.1 Conducted Power Line Emission Limit

For unintentional device, according to § 15.107(a) Line Conducted Emission Limits is as following

Frequency (MHz)	Maximum RF Line Voltage(dBμV)			
	CLASS A		CLASS B	
	Q.P.	Ave.	Q.P.	Ave.
0.15~0.50	79	66	66~56*	56~46*
0.50~5.00	73	60	56	46
5.00~30.0	73	60	60	50

* Decreasing linearly with the logarithm of the frequency

For intentional device, according to §15.207(a) Line Conducted Emission Limit is same as above table.

3.2 Test Setup

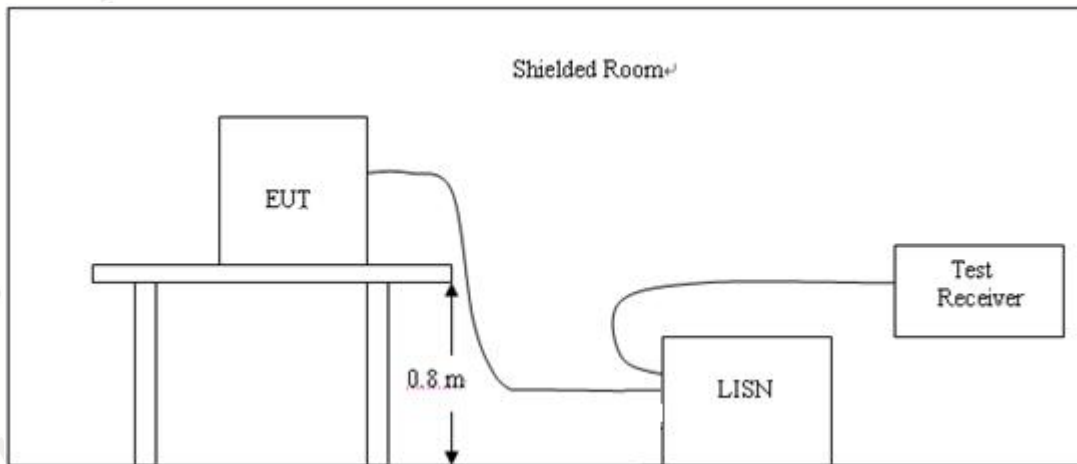

3.3 Test Procedure

- 1, The equipment was set up as per the test configuration to simulate typical actual usage per the user's manual. A wooden table with a height of 0.8 meters is used and is placed on the ground plane as per ANSI C63.10.
- 2, Support equipment, if needed, was placed as per ANSI C63.10.
- 3, All I/O cables were positioned to simulate typical actual usage as per ANSI C63.10.
- 4, If a EUT received DC power from the USB Port of Notebook PC, the PC's adapter received AC120V/60Hz power through a Line Impedance Stabilization Network (LISN) which supplied power source and was grounded to the ground plane.
- 5, All support equipments received AC power from a second LISN, if any.
- 6, The EUT test program was started. Emissions were measured on each current carrying line of the EUT using a spectrum Analyzer / Receiver connected to the LISN powering the EUT. The LISN has two monitoring points: Line 1 (Hot Side) and Line 2 (Neutral Side). Two scans were taken: one with Line 1 connected to Analyzer / Receiver and Line 2 connected to a 50 ohm load; the second scan had Line 1 connected to a 50 ohm load and Line 2 connected to the Analyzer / Receiver.
- 7, Analyzer/Receiver scanned from 150 KHz to 30MHz for emissions in each of the test modes.

3.4 Test Result

PSSS

Remark: EUT was tested at AC 120V and 240V, only the worst result of AC 120V was reported.

Temperature:	24°C	Relative Humidity:	45%
Test Date:	Jul. 20, 2020	Pressure:	1010hPa
Test Voltage:	AC 120V, 60Hz	Phase:	Line
Test Mode:	Transmitting mode		

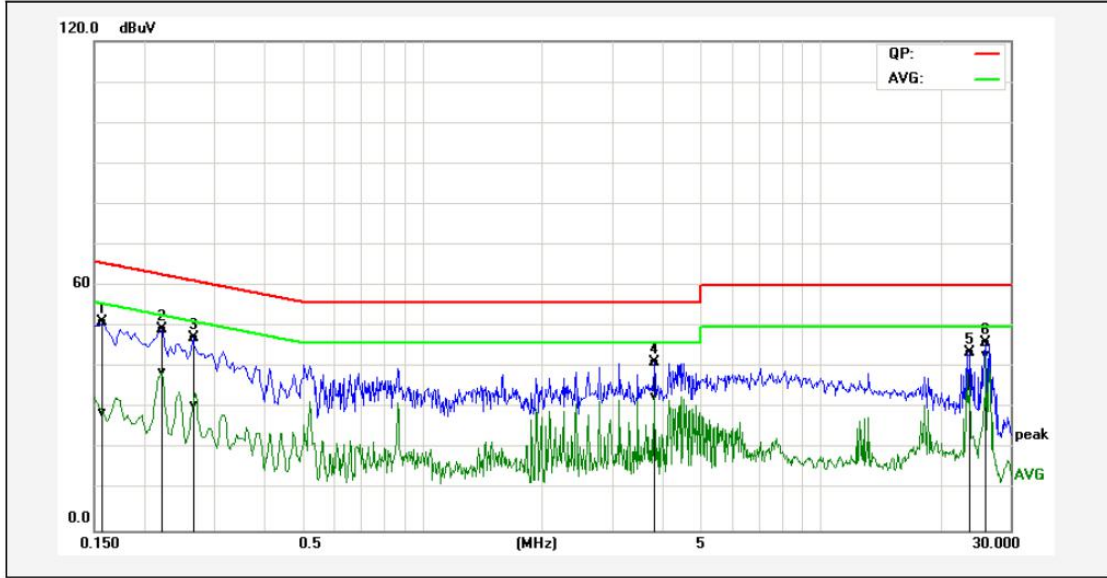

No.	Frequency (MHz)	QuasiPeak reading (dBuV)	Average reading (dBuV)	Correction factor (dB)	QuasiPeak result (dBuV)	Average result (dBuV)	QuasiPeak limit (dBuV)	Average limit (dBuV)	QuasiPeak margin (dB)	Average margin (dB)	Remark
1P	0.1580	41.40	19.19	9.65	51.05	28.84	65.56	55.57	-14.51	-26.73	Pass
2P	0.2220	39.68	29.22	9.75	49.43	38.97	62.74	52.74	-13.31	-13.77	Pass
3P	0.2660	37.62	20.97	9.78	47.40	30.75	61.24	51.24	-13.84	-20.49	Pass
4P	3.8300	31.41	22.77	9.94	41.35	32.71	56.00	46.00	-14.65	-13.29	Pass
5P	23.6860	43.13	34.54	0.60	43.73	35.14	60.00	50.00	-16.27	-14.86	Pass
6*	26.1180	45.45	42.42	0.69	46.14	43.11	60.00	50.00	-13.86	-6.89	Pass

Remark: Factor = Insertion Loss + Cable Loss, Result = Reading + Factor, Margin = Result – Limit.

Temperature:	24°C	Relative Humidity:	45%
Test Date:	Jul. 20, 2020	Pressure:	1010hPa
Test Voltage:	AC 120V, 60Hz	Phase:	Neutral
Test Mode:	Transmitting mode		

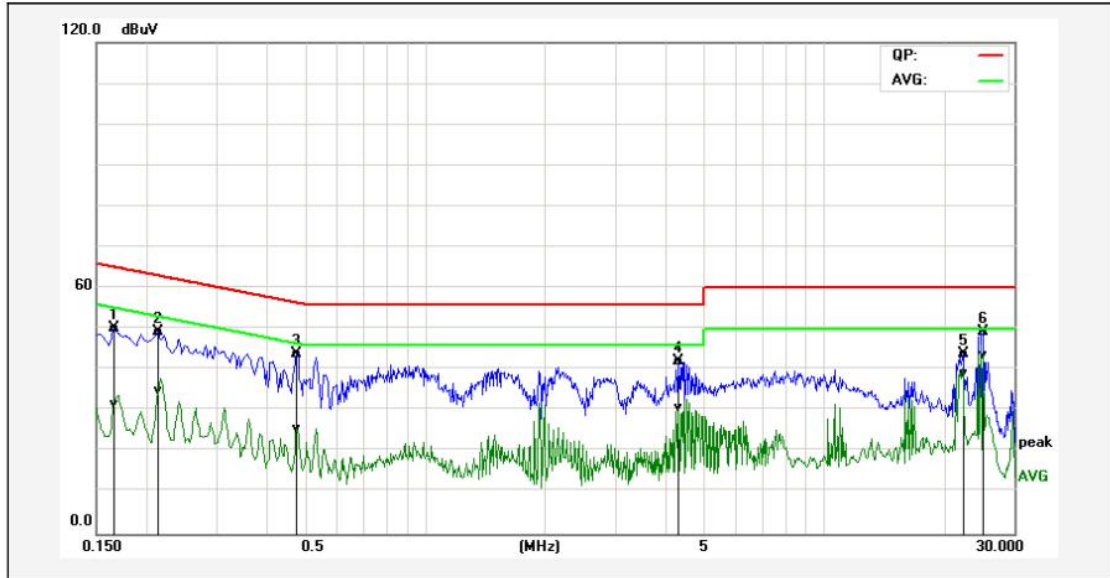

No.	Frequency (MHz)	QuasiPeak reading (dBuV)	Average reading (dBuV)	Correction factor (dB)	QuasiPeak result (dBuV)	Average result (dBuV)	QuasiPeak limit (dBuV)	Average limit (dBuV)	QuasiPeak margin (dB)	Average margin (dB)	Remark
1P	0.1660	40.69	22.03	9.67	50.36	31.70	65.15	55.16	-14.79	-23.46	Pass
2P	0.2140	39.65	25.14	9.75	49.40	34.89	63.04	53.05	-13.64	-18.16	Pass
3P	0.4780	34.08	15.83	9.80	43.88	25.63	56.37	46.37	-12.49	-20.74	Pass
4P	4.3220	32.35	20.91	9.94	42.29	30.85	56.00	46.00	-13.71	-15.15	Pass
5P	22.2979	43.30	38.66	0.55	43.85	39.21	60.00	50.00	-16.15	-10.79	Pass
6*	25.0940	48.81	43.13	0.66	49.47	43.79	60.00	50.00	-10.53	-6.21	Pass

Remark: Factor = Insertion Loss + Cable Loss, Result = Reading + Factor, Margin = Result – Limit.

4 RADIATED EMISSION TEST

4.1 Block Diagram of Test Setup

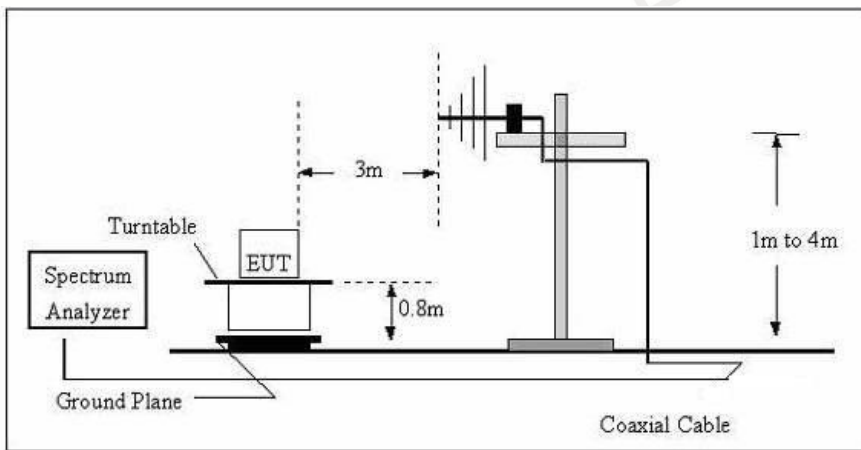
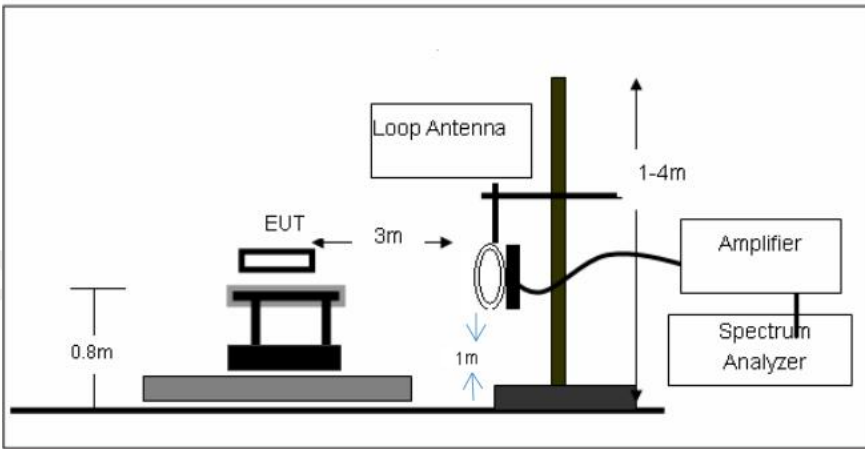

4.2 Rules and specifications

CFR 47 Part 15, section 15.205

Only spurious emissions are permitted in any of the frequency bands listed the tables in these sections.

MHz	MHz	MHz	GHz
0.090-0.110	16.42-16.423	399.9-410	4.5-5.15
1\ 0.495-0.505	16.69475-16.69525	608-614	5.35-5.46
2.1735-2.1905	16.80425-16.80475	960-1240	7.25-7.75
4.125-4.128	25.5-25.67	1300-1427	8.025-8.5
4.17725-4.17775	37.5-38.25	1435-1626.5	9.0-9.2
4.20725-4.20775	73-74.6	1645.5-1646.5	9.3-9.5
6.215-6.218	74.8-75.2	1660-1710	10.6-12.7
6.26775-6.26825	108-121.94	1718.8-1722.2	13.25-13.4
6.31175-6.31225	123-138	2200-2300	14.47-14.5
8.291-8.294	149.9-150.05	2310-2390	15.35-16.2
8.362-8.366	156.52475-156.52525	2483.5-2500	17.7-21.4
8.37625-8.38675	156.7-156.9	2690-2900	22.01-23.12
8.41425-8.41475	162.0125-167.17	3260-3267	23.6-24.0
12.29-12.293	167.72-173.2	3332-3339	31.2-31.8
12.51975-12.52025	240-285	3345.8-3358	36.43-36.5
12.57675-12.57725	322-335.4	3600-4400	(12)
13.36-13.41			

CFR 47 Part 15, section 15.209

The emissions from an intentional radiator shall not exceed the limits in the tables in these sections using an average detector

Frequency (MHz)	Field strength (microvolts/meter)	Measurement distance (meters)
0.009-0.490	2400/F(kHz)	300
0.490-1.705	24000/F(kHz)	30
1.705-30.0	30	30
30-88	100**	3
88-216	150**	3
216-960	200**	3
Above 960	500	3

Limit calculation and transfer to 3m distance as showed in the following table:

Frequency (MHz)	Limit (dBuV/m)	Distance (m)
0.009-0.490	$20\log(2400/F(KHz))+40\log(300/3)$	3
0.490-1.705	$20\log(24000/F(KHz))+40\log(30/3)$	3
1.705-30.0	69.5	3
30-88	40.0	3
88-216	43.5	3
216-960	46.0	3
Above 960	54.0	3

CFR 47 Part 15, section 15.35

When average radiated emission measurements are specified, the limit on the peak level of the radio Frequency emission is 20dB above the maximum permitted average emission limit.

Transmitter Spurious Emissions 9KHz-30MHz			
	9-150KHz	150-490KHz	490KHz-30MHz
Resolution Bandwidth	200Hz	9KHz	9KHz
Video Bandwidth	2KHz	100KHz	100KHz
Detector	Peak	Peak	Peak
Trace Mode	Max Hold	Max Hold	Max Hold
Sweep Time	Auto	Auto	Auto

4.3 Test Procedure

Measurement distance is 3m.

For the measurement range up to 30MHz in the following plots the field strength result from 3m Distance measurement are extrapolated to 300m and 30m distance respectively, by 40dB/decade, According to part 15.31(f)(2), per antenna factor scaling.

Measurements below 1000MHz are performed with a peak detector and compared to average limits, Measurements with an average detector are not required.

Note:

For battery operated equipment, the equipment tests shall be performed using a new battery.

4.4 Test Result

PASS

For 9KHz-30MHz Test Results:

Temperature:	26°C	Relative Humidity:	44%
Test Date:	Jul. 20, 2020	Pressure:	1010hPa
Test Voltage:	AC 120V, 60Hz	Polarization:	Horizontal
Test Mode:	Transmitting mode		



No.	Frequency (MHz)	Reading (dBuV)	Correction factor(dB/m)	Result (dBuV/m)	Limit (dBuV/m)	Margin (dB)	Degree (deg.)	Height (cm)	Remark
1	0.0482	49.26	0.00	49.26	113.94	-64.68	210	100	peak
2	0.0651	48.25	0.00	48.25	111.33	-63.08	360	100	peak
3	0.1257	91.74	-27.74	64.00	105.55	-41.55	120	100	peak
4	0.4638	65.45	-29.28	36.17	94.28	-58.11	240	100	peak
5*	1.9337	66.39	-29.23	37.16	69.50	-32.34	180	100	peak
6	20.8253	65.95	-29.53	36.42	69.50	-33.08	150	100	peak

Remark: Absolute Level= Reading Level+ Factor, Margin= Absolute Level – Limit
 Factor=Ant. Factor + Cable Loss – Pre-amplifier

For 30MHz-1GHz Test Results:

Temperature:	26°C	Relative Humidity:	44%
Test Date:	Jul. 20, 2020	Pressure:	1010hPa
Test Voltage:	AC 120V, 60Hz	Polarization:	Horizontal
Test Mode:	Transmitting mode		



No.	Frequency (MHz)	Reading (dBuV)	Correction factor (dB/m)	Result (dBuV/m)	Limit (dBuV/m)	Margin (dB)	Degree (deg.)	Height (cm)	Remark
1	30.8535	28.81	-7.82	20.99	40.00	-19.01	120	100	peak
2	85.8984	42.07	-21.39	20.68	40.00	-19.32	240	100	peak
3	211.5265	38.41	-17.70	20.71	43.50	-22.79	180	100	peak
4	281.9946	38.86	-15.21	23.65	46.00	-22.35	210	100	peak
5	413.2706	51.72	-12.81	38.91	46.00	-7.09	150	100	peak
6*	467.2349	51.45	-11.62	39.83	46.00	-6.17	30	100	peak

Remark: Absolute Level= Reading Level+ Factor, Margin= Absolute Level – Limit
 Factor=Ant. Factor + Cable Loss – Pre-amplifier

Temperature:	26°C	Relative Humidity:	44%
Test Date:	Jul. 20, 2020	Pressure:	1010hPa
Test Voltage:	AC 120V, 60Hz	Polarization:	Vertical
Test Mode:	Transmitting mode		

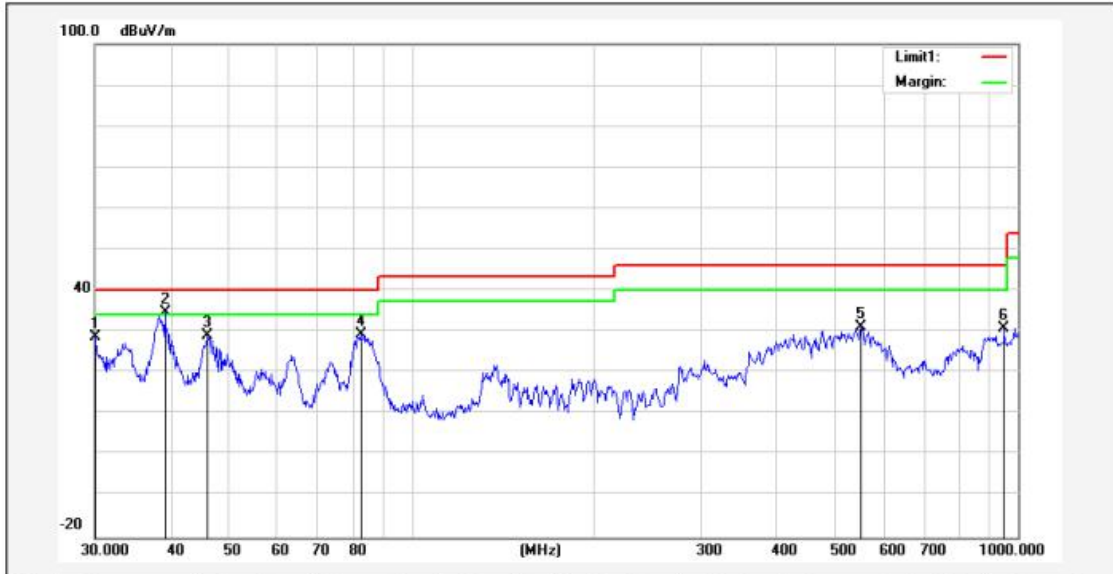

No.	Frequency (MHz)	Reading (dBuV)	Correction factor (dB/m)	Result (dBuV/m)	Limit (dBuV/m)	Margin (dB)	Degree (deg.)	Height (cm)	Remark
1	30.1054	35.87	-7.23	28.64	40.00	-11.36	210	100	peak
2*	39.1616	48.80	-14.15	34.65	40.00	-5.35	240	100	peak
3	46.0164	47.76	-18.84	28.92	40.00	-11.08	150	100	peak
4	82.3588	50.98	-21.52	29.46	40.00	-10.54	90	100	peak
5	550.9480	42.02	-10.99	31.03	46.00	-14.97	30	100	peak
6	948.7610	37.07	-6.15	30.92	46.00	-15.08	120	100	peak

Remark: Absolute Level= Reading Level+ Factor, Margin= Absolute Level – Limit
 Factor=Ant. Factor + Cable Loss – Pre-amplifier

Remark:

- (1) * denotes emission frequency which appearing within the Restricted Bands specified in provision of 15.205, then the general radiated emission limits in 15.209 apply.
- (2) The IF bandwidth of EMI Test Receiver between 30MHz to 1GHz was 120KHz, 1 MHz for measuring above 1 GHz, below 30MHz was 10KHz.

5 ANTENNA REQUIREMENT

Standard Applicable:

For intentional device, according to FCC 47 CFR Section 15.203, an intentional radiator shall be designed to ensure that no antenna other than that furnished by the responsible party shall be used with the device.

Antenna Connected Construction

The antenna used in this product is a Coil Antenna, The directional gains of antenna used for transmitting is 0dBi.

ANTENNA:

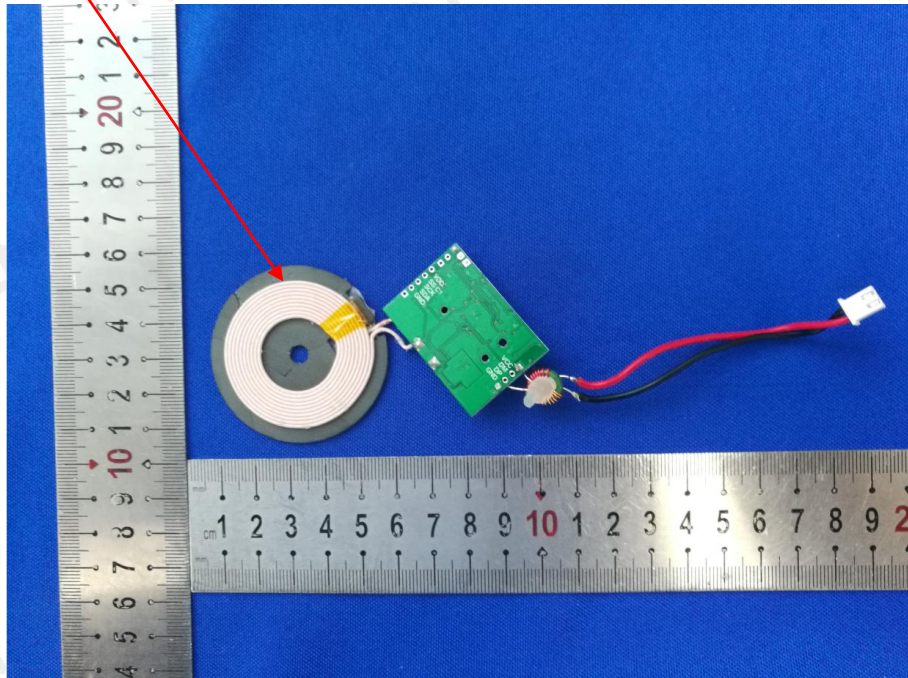

6PHOTOGRAPH OF TEST

6.1 Radiated Emission



6.2 Conducted Emission



End of Report