



RF TEST REPORT

Report No.: 20230817G09967X-W8

Product Name: LTE Smart Phone

Model No.: SH4650

FCC ID: 2AWF6-SH4650

Applicant: START USA, INC.

Address: 6860 Dallas Parkway, Suite 200, Plano, TX 75024, USA

Dates of Testing: 04/23/2023 - 06/16/2023

Issued by: CCIC Southern Testing Co., Ltd.

Lab Location: Electronic Testing Building, No. 43 Shahe Road, Xili Street,
Nanshan District, Shenzhen, Guangdong, China.

Tel: 86 755 26627338 **Fax:** 86 755 26627238

This test report consists of 25 pages in total. It may be duplicated completely for legal use with the approval of the applicant. It should not be reproduced except in full, without the written approval of our laboratory. The client should not use it to claim product endorsement by CCIC-SET. The test results in the report only apply to the tested sample. The test report shall be invalid without all the signatures of testing engineers, reviewer and approver. Any objections must be raised to CCIC-SET within 15 days since the date when the report is received. It will not be taken into consideration beyond this limit.



Test Report

Product.....: LTE Smart Phone
Brand Name.....: START, Consumer Cellular, Verve, IRIS
Trade Name: START, Consumer Cellular, Verve, IRIS
Marketing Name: Roadrunner
Applicant.....: START USA, INC.
Applicant Address.....: 6860 Dallas Parkway, Suite 200, Plano, TX 75024, USA
Manufacturer.....: THINKSTART ELECTRONIC TECHNOLOGY CO., LTD.
Manufacturer Address.....: Unit A1-403, Kexing Science Park, 15 Keyuan Road,
Nanshan District, Shenzhen, CHINA
Test Standards.....: 47 CFR Part 15 Subpart E 15.407
Test Result.....: Pass

Tested by: Kim Li 2023.09.01

Kim Li, Test Engineer

Reviewed by.....: Chris You 2023.09.01

Chris You, Senior Engineer

Approved by.....: Yang Fan 2023.09.01

Yang Fan, Manager



Table of Contents

1. GENERAL INFORMATION.....	5
1.1. EUT Description.....	5
1.2. Test Standards and Results.....	6
1.3. Laboratory Facilities.....	6
2. U-NII DFS RULE REQUIREMENTS.....	7
2.1. Working modes and required test items.....	7
2.2. Test limits and radar signal parameters.....	8
3. TEST PROCEDURE.....	11
3.1. DFS Test Setup configuration.....	11
3.2. BVADT DFS Measurement system.....	12
4. U-NII DFS RULE REQUIREMENTS.....	22
5. U-NII DFS RULE REQUIREMENTS.....	25



Change History		
Issue	Date	Reason for change
1.0	2023.09.01	First edition



1. GENERAL INFORMATION

1.1. EUT Description

Product Name	LTE Smart Phone
Model No.	SH4650
Hardware Version	SH4650HV1.0
Software Version	SH4650SV1.0.5
Operation	<input type="checkbox"/> Master device
	<input type="checkbox"/> Slaver device with radar detection function
	<input checked="" type="checkbox"/> Slaver device without radar detection function
TPC	Not support
EUT supports Radios application	WLAN5.0GHz 802.11a/n/ac
Modulation Type	802.11a/n: OFDM (BPSK/QPSK/16QAM/64QAM) 802.11ac: OFDM (BPSK/QPSK/16QAM/64QAM/256QAM)
Transfer Rate	802.11a: 54/48/36/24/18/12/9/6 Mbps 802.11n: up to 150 Mbps 802.11ac: up to 433.333 Mbps
Frequency Range	UNII-1: 5150 ~ 5250MHz UNII-2a: 5250 ~ 5350MHz UNII-2c: 5470 ~ 5725MHz UNII-3: 5725 ~ 5850MHz
Channel Bandwidth	802.11a: 20MHz 802.11n: 20MHz/40MHz 802.11ac: 20MHz/40MHz/80MHz
Antenna Type	Internal Antenna
Antenna Gain	0.80dBi
Power supply	Rechargeable Li-ion Polymer Battery DC3.85V/4000mAh

Note 1: This report is based on the 20230417G03483X-W8 report. The following 3 points have been updated:

1. Phase in 2nd source: WTR-3925-2-106BWL PSP-TR-03-0.
2. Phase in 2nd source: 1W ACC speaker, and change the horn pad of the SUB board.
3. Change the main RF PA and external speaker as well as other hardware and software of the small auxiliary board.

This change does not involve Bluetooth and WIFI, so no Bluetooth and WIFI test is required.



1.2. Test Standards and Results

The objective of the report is to perform testing according to 47 CFR Part 15 Subpart E:

No.	Identity	Document Title
1	47 CFR Part 15 Subpart E §15.407	Radio Frequency Devices
2	KDB Publication 905462 D02v02	UNII DFS Compliance Procedures New Rules
3	KDB Publication 905462 D03v01	UNII Clients Without Radar Detection New Rules

Test detailed items/section required by FCC rules and results are as below:

No.	FCC Rule	Description	Result
1	15.407 (h)(2)	Channel Move Time	PASS
2		Channel Closing Transmission Time	PASS
3		Non- Occupancy Period	PASS

1.3. Laboratory Facilities

FCC-Registration No.: 406086

CCIC Southern Testing Co., Ltd EMC Laboratory has been registered and fully described in a report filed with the FCC (Federal Communications Commission). The acceptance letter from the FCC is maintained in our files. Designation Number: CN1283, valid time is until Sep 30, 2023.

ISED Registration: 11185A-1

CCIC Southern Testing Co., Ltd. EMC Laboratory has been registered by Certification and Engineering Bureau of Industry Canada for the performance of radiated measurements with Registration No. 11185A-1 on Aug. 04, 2016, valid time is until Sep 30, 2023.

A2LA Code: 5721.01

CCIC-SET is a third party testing organization accredited by A2LA according to ISO/IEC 17025. The accreditation certificate number is 5721.01.

2. U-NII DFS Rule Requirements

2.1. Working modes and required test items

The manufacturer shall state whether the UUT is capable of operating as a Master and/or a Client. If the UUT is capable of operating in more than one operating mode then each operating mode shall be tested separately. See tables 1 and 2 for the applicability of DFS requirements for each of the operational modes.

Table 1: Applicability of DFS Requirements prior to use a channel

Requirement	Operational Mode		
	Master	Client without radar detection	Client with radar detection
Non-Occupancy Period	√	Not required	√
DFS Detection Threshold	√	Not required	√
Channel Availability Check Time	√	Not required	Not required
Uniform Spreading	√	Not required	Not required
U-NII Detection Bandwidth	√	Not required	√

Table 2: Applicability of DFS Requirements during normal operation

Requirement	Operational Mode		
	Master	Client without radar detection	Client with radar detection
DFS Detection Threshold	√	Not required	√
Channel Closing Transmission Time	√	√	√
Channel Move Time	√	√	√
U-NII Detection Bandwidth	√	Not required	√



2.2. Test limits and radar signal parameters

DFS Detection thresholds for Master Devices and Client Devices with Radar Detection

Maximum Transmit Power	Value (See Note 1 and 2)
≥ 200 milliwatt	-64 dBm
< 200 milliwatt	-62 dBm

Note 1: This is the level at the input of the receiver assuming a 0 dBi receive antenna.

Note 2: Throughout these test procedures an additional 1 dB has been added to the amplitude of the test transmission waveforms to account for variations in measurement equipment. This will ensure that the test signal is at or above the detection threshold level to trigger a DFS response.

DFS Response requirement values

Parameter	Value
Non-occupancy period	Minimum 30 minutes
Channel Availability Check Time	60 seconds
Channel Move Time	10 seconds See Note 1.
Channel Closing Transmission Time	200 milliseconds + an aggregate of 60 milliseconds over remaining 10 second period. See Notes 1 and 2.
U-NII Detection Bandwidth	100% of the UNII transmission power bandwidth. See Note 3.

Note 1: The instant that the Channel Move Time and the Channel Closing Transmission Time begins is as follows:

- For the Short Pulse Radar Test Signals this instant is the end of the Burst.
- For the Frequency Hopping radar Test Signal, this instant is the end of the last radar Burst generated.
- For the Long Pulse Radar Test Signal this instant is the end of the 12 second period defining the Radar Waveform.

Note 2: The Channel Closing Transmission Time is comprised of 200 milliseconds starting at the beginning of the Channel Move Time plus any additional intermittent control signals required to facilitate a Channel move (an aggregate of 60 milliseconds) during the remainder of the 10 second period. The aggregate duration of control signals will not count quiet periods in between transmissions.

Note 3: During the U-NII Detection Bandwidth detection test, radar type 1 is used and for each frequency step the minimum percentage of detection is 90 percent. Measurements are performed with no data traffic.



Parameters of DFS test signals

Step intervals of 0.1 microsecond for Pulse Width, 1 microsecond for PRI, 1 MHz for chirp width and 1 for the number of pulses will be utilized for the random determination of specific test waveforms.

Short pluse radar test waveforms

Radar Type	Pulse width (μsec)	PRI (μsec)	Number of Pulses	Minimum Percentage of Successful Detection	Minimum Number of Trials
0	1	1428	18	See Note 1	See Note 1
1	1	Test A: 15 unique PRI values randomly selected from the list of 23 PRI values in Table 5a Test B: 15 unique PRI values randomly selected within the range of 518-3066 μsec, with a minimum increment of 1μsec, excluding PRI values selected in Test A	$\text{Roundup} \left\{ \begin{matrix} \left(\frac{1}{360} \right) \\ \left(\frac{10 \cdot 10^6}{\text{PRI}_{\mu\text{sec}}} \right) \end{matrix} \right\}$	60%	30
2	1-5	150-230	23-29	60%	30
3	6-10	200-500	16-18	60%	30
4	11-20	200-500	12-16	60%	30
Aggregate (Radar Types 1-4)				80%	120

Note 1: Short Pulse Radar Type 0 should be used for the detection bandwidth test, channel move time, and channel closing time tests.



Long pulse radar test waveform

Radar Type	Pulse Width (μ sec)	Chirp Width (MHz)	PRI (μ sec)	Number of Pulses per Burst	Number of Bursts	Minimum Percentage of Successful Detection	Minimum Number of Trials
5	50-100	5-20	1000-2000	1-3	8-20	80%	30

Frequency hopping radar test waveform

Radar Type	Pulse Width (μ sec)	PRI (μ sec)	Pulses per Hop	Hopping Rate (kHz)	Hopping Sequence Length (msec)	Minimum Percentage of Successful Detection	Minimum Number of Trials
6	1	333	9	0.333	300	70%	30

3. Test Procedure

3.1. DFS Test Setup configuration

Client without Radar Detection Mode

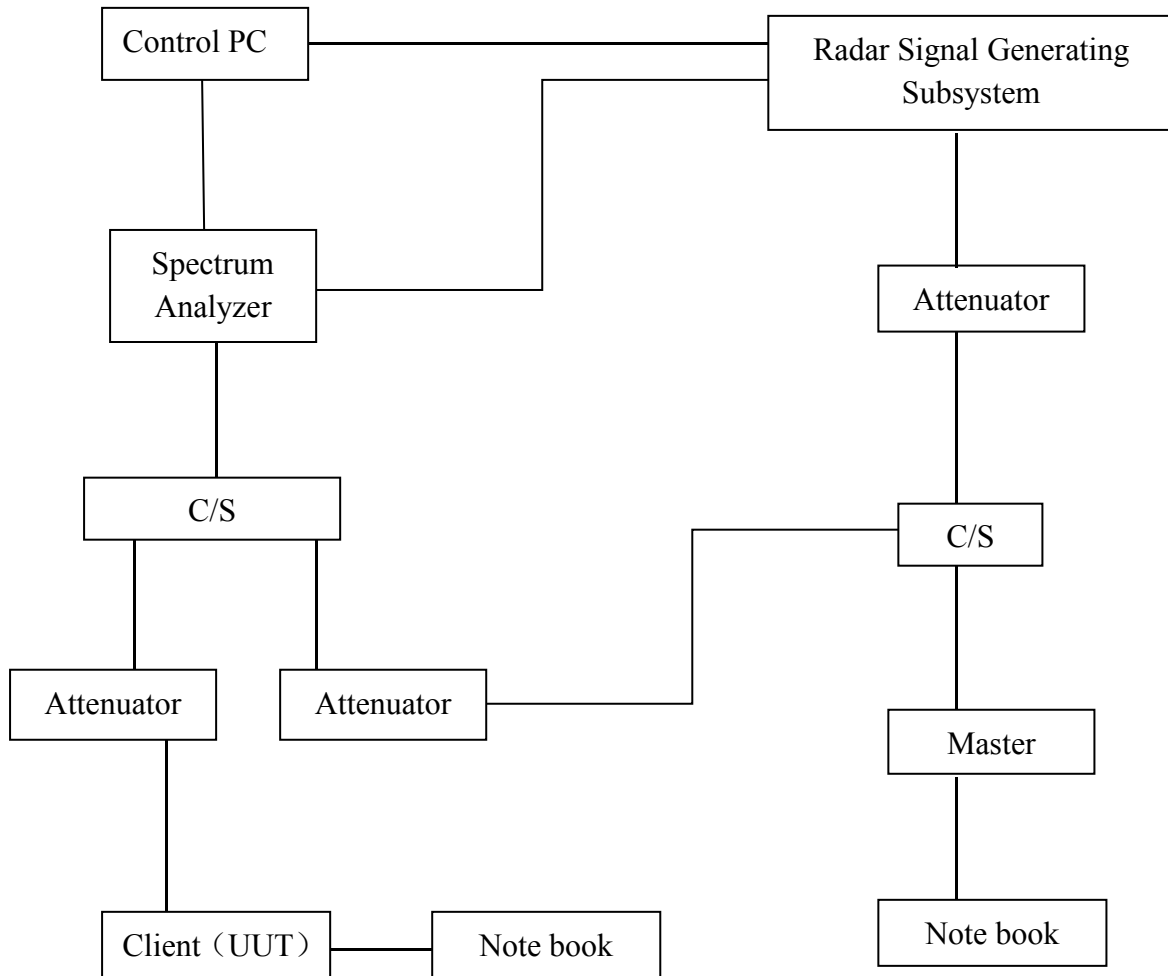

The UUT is a UNII device operating in client mode without radar detection. The radar test signals are injected into the master device.

3.2. BVADT DFS Measurement system

A complete BVADT DFS Measurement System consists of two subsystems: (1) the Radar Signal Generating Subsystem and (2) the Traffic Monitoring Subsystem. The control PC is necessary for generating the Radar waveforms in Table 1, 2. The traffic monitoring subsystem is specified to the type of unit under test (UUT).

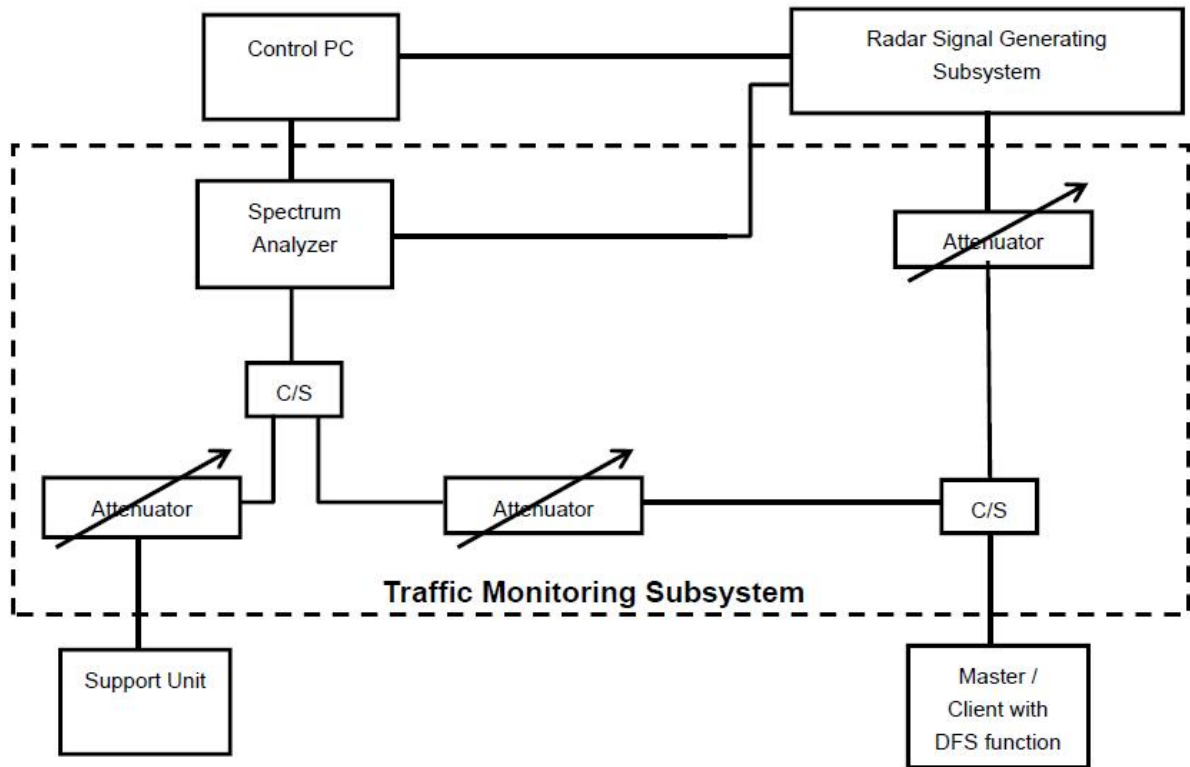

The test transmission will always be from the Master Device to the Client Device. While the Client device is set up to associate with the Master device and play the MPEG file (6 1/2 Magic Hours) from Master device, the designated MPEG test file and instructions are located at:

<http://ntiacsd.ntia.doc.gov/dfs/>.

Calibration of DFS detection threshold level:

The measured channel is 5290 MHz and 5530MHz in 80MHz Bandwidth. The radar signal was the same as transmitted channels, and injected into the antenna port of AP (master) or Client Device with Radar Detection, measured the channel closing transmission time and channel move time.

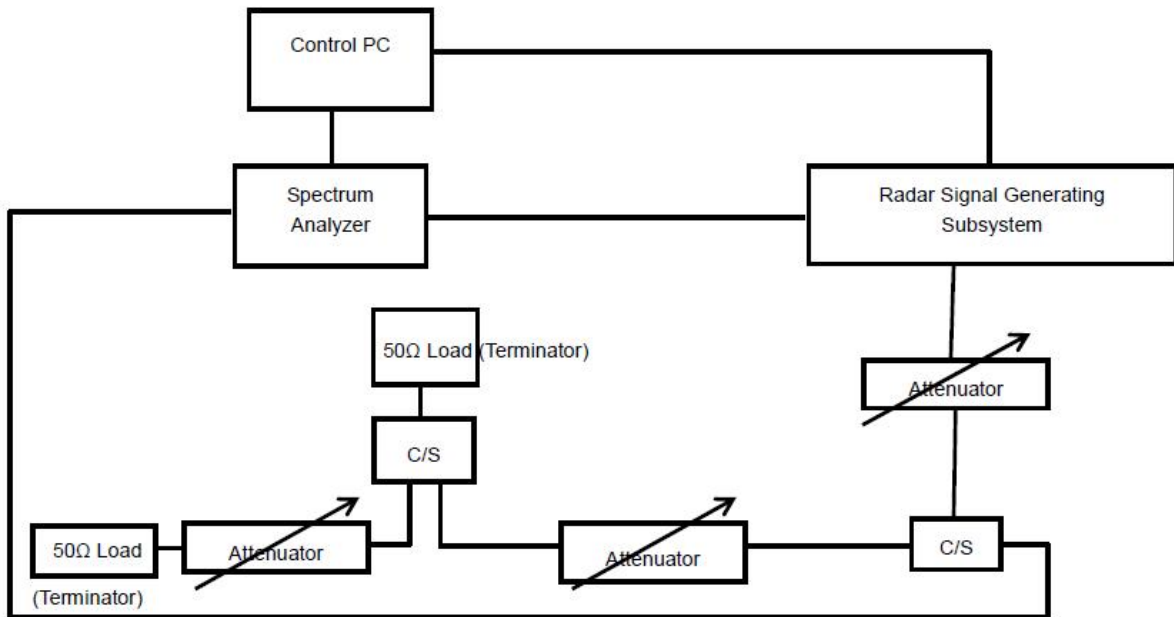
Conducted setup configuration of calibration of DFS detection threshold level

Calibration plots for each of the required radar waveforms

Radar type 0

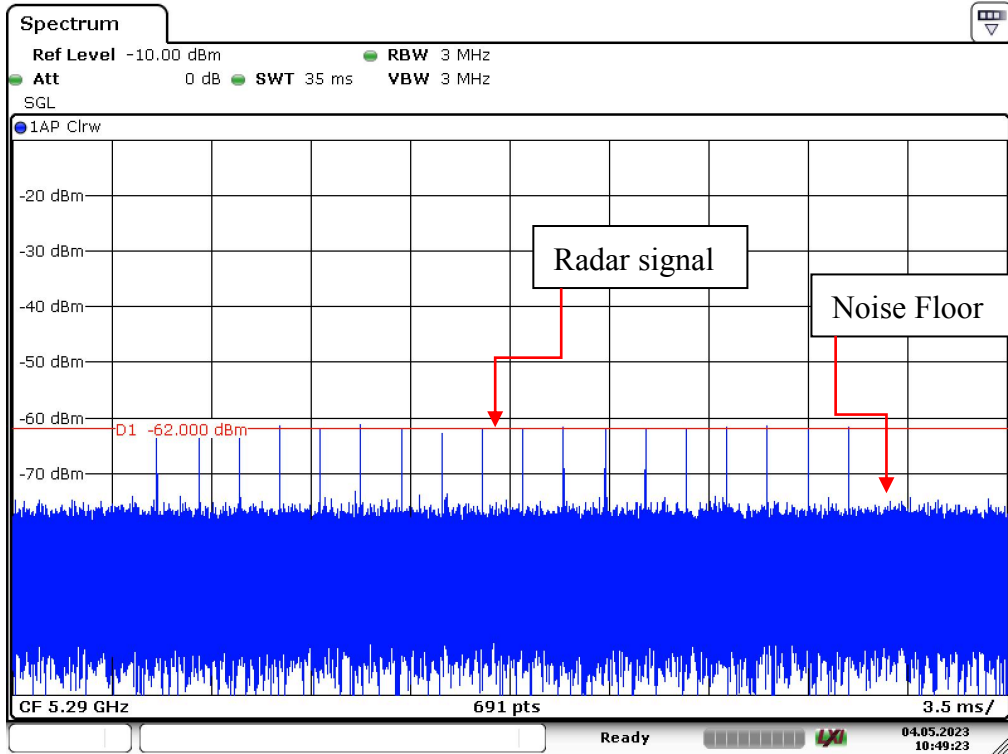

Radar Type 0 – 5290MHz

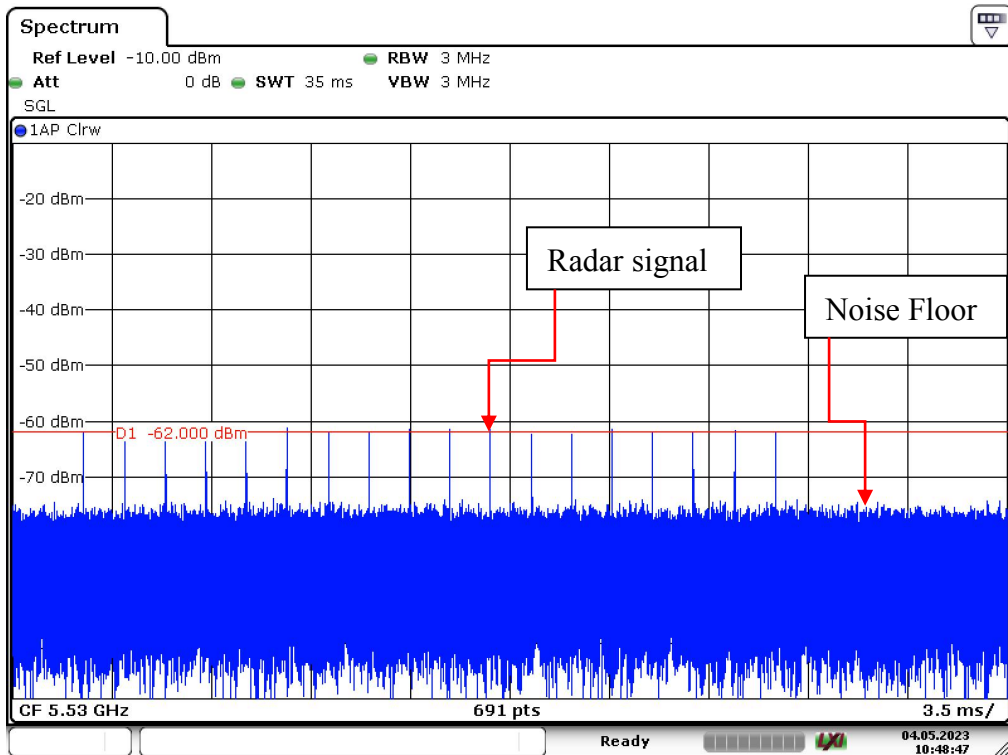

Radar Type 0 – 5530MHz



Radar type 1A

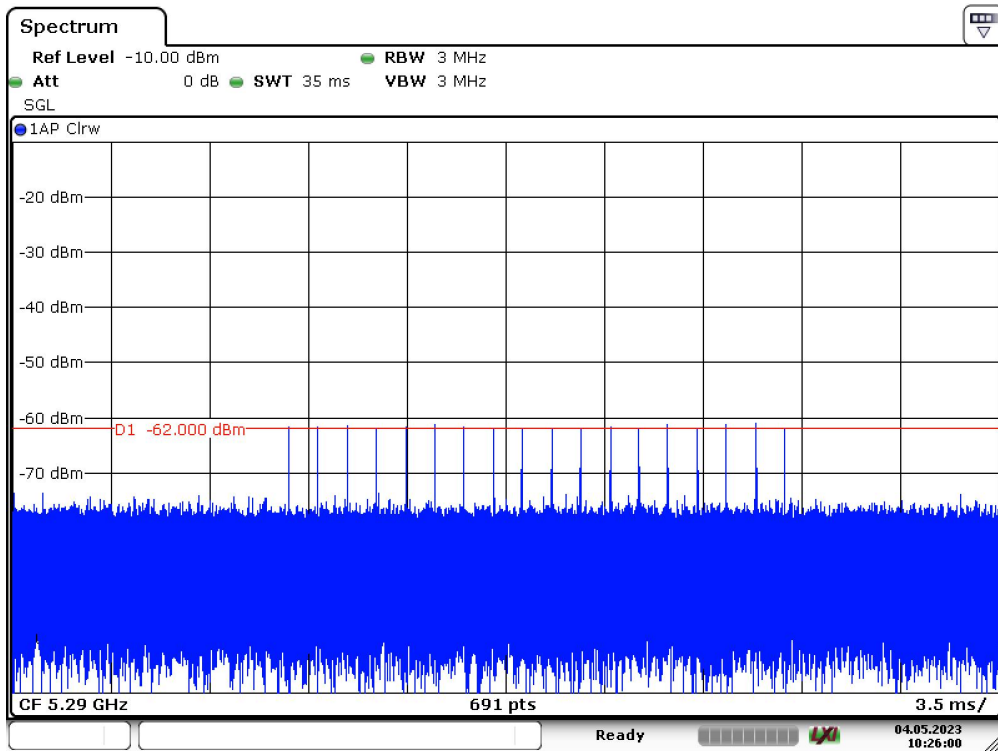

Radar Type 1A – 5290MHz

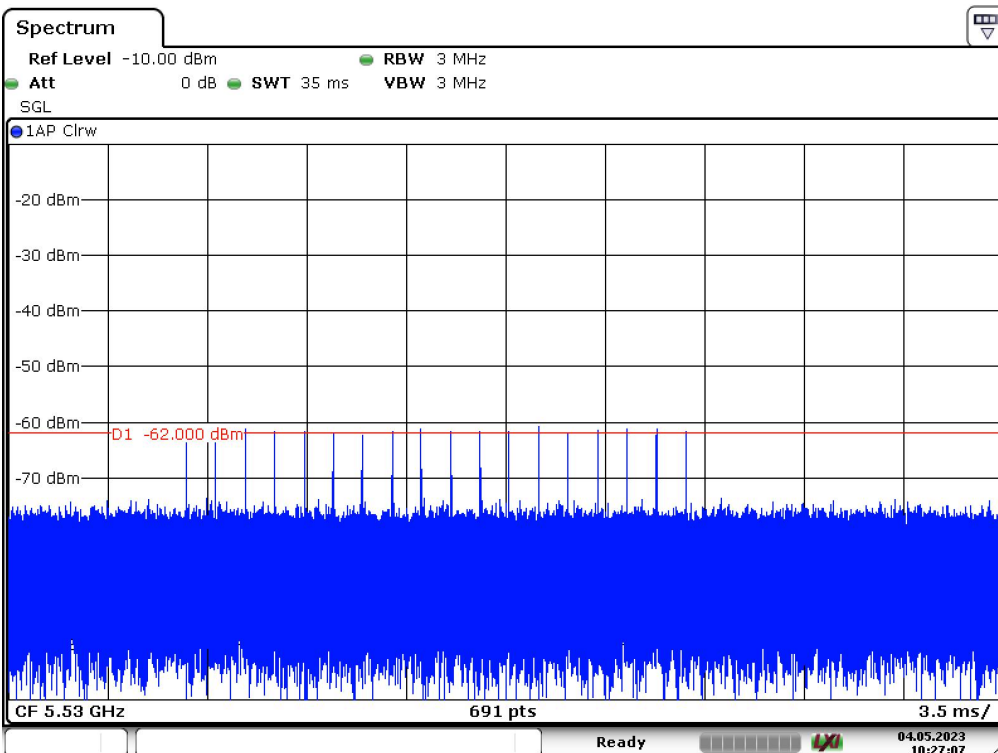

Radar Type 1A – 5530MHz



Radar type 1B

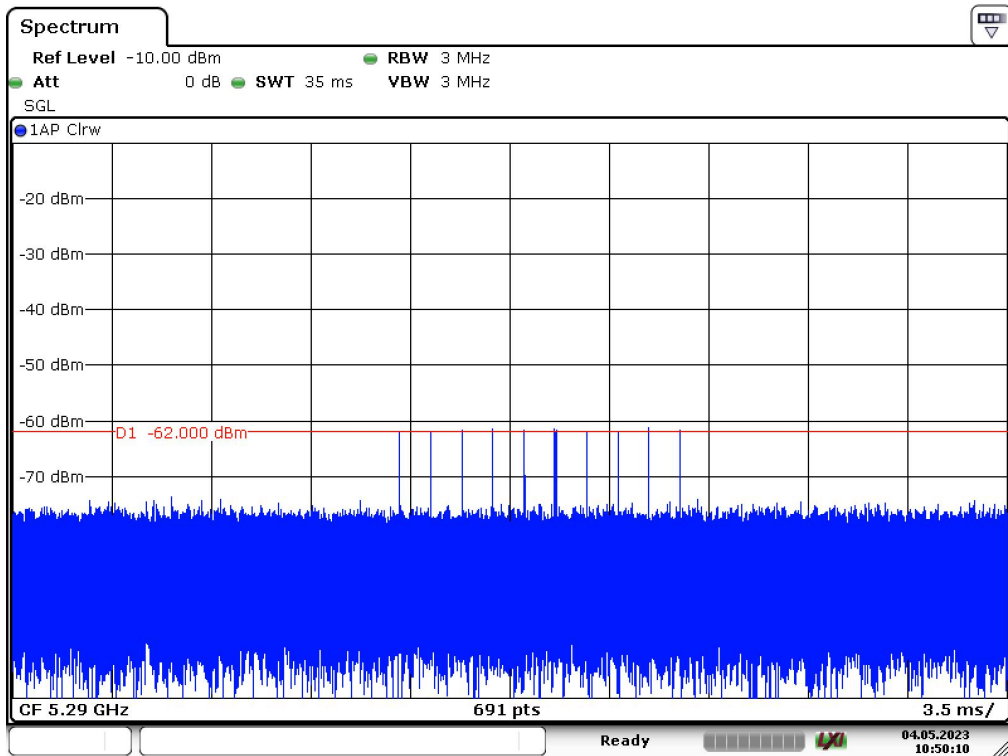

Radar Type 1B – 5290MHz

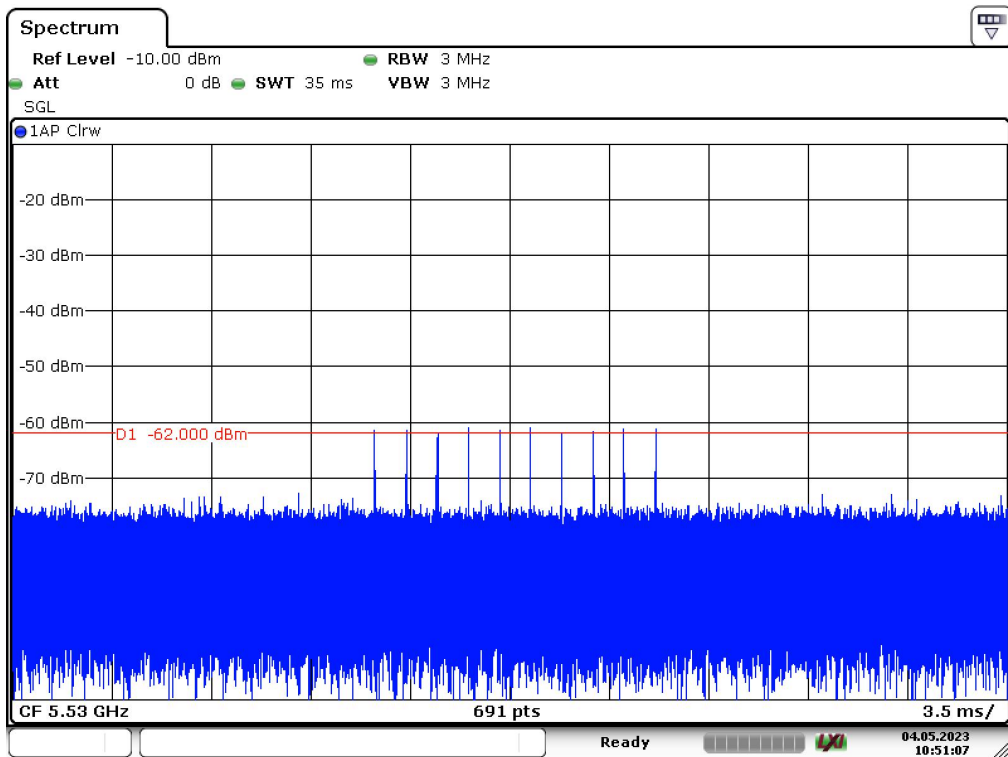

Radar Type 1B – 5530MHz



Radar type 2

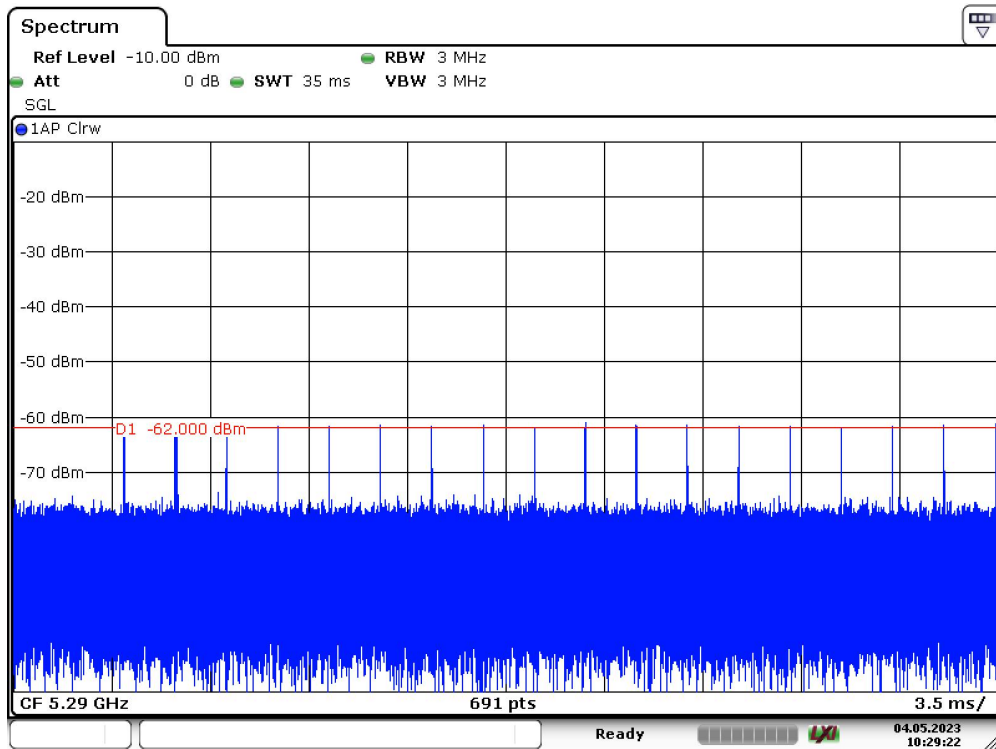

Radar Type 2 – 5290MHz

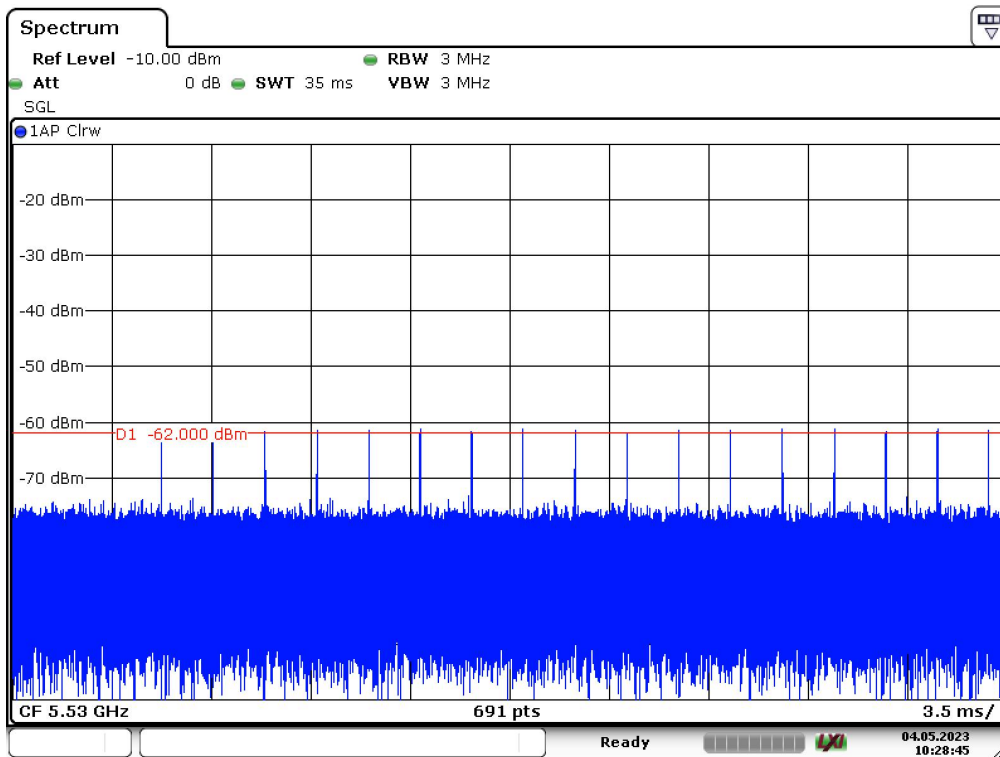

Radar Type 2 – 5530MHz

Radar type 3

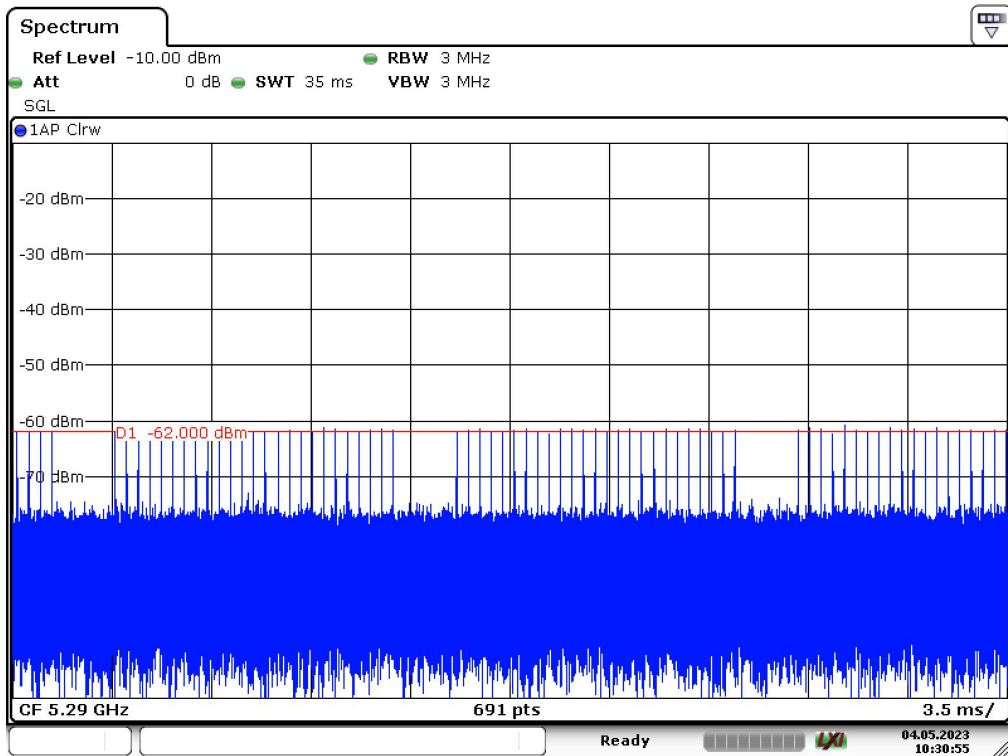

Radar Type 3 – 5290MHz

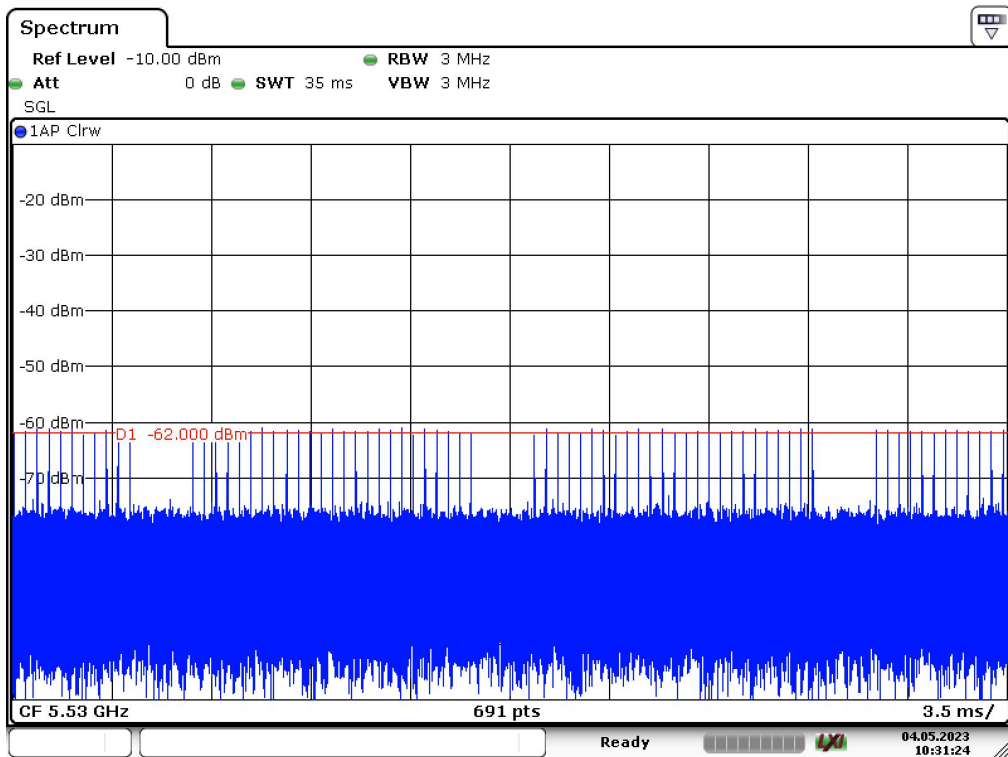

Radar Type 3 – 5530MHz

Radar type 4

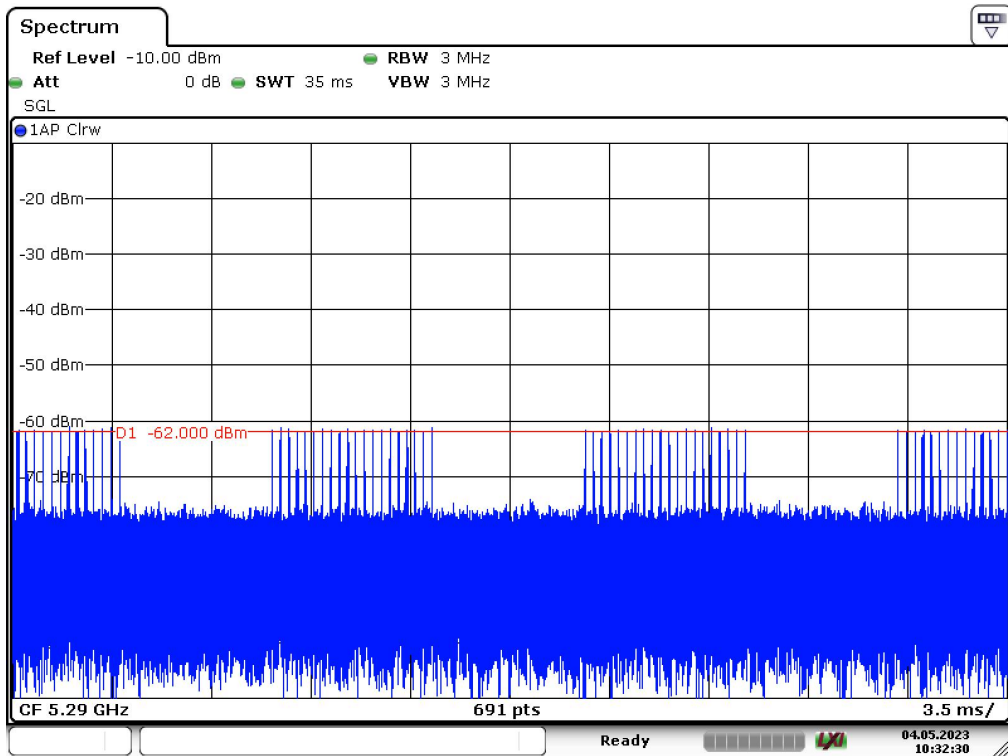

Radar Type 4 – 5290MHz

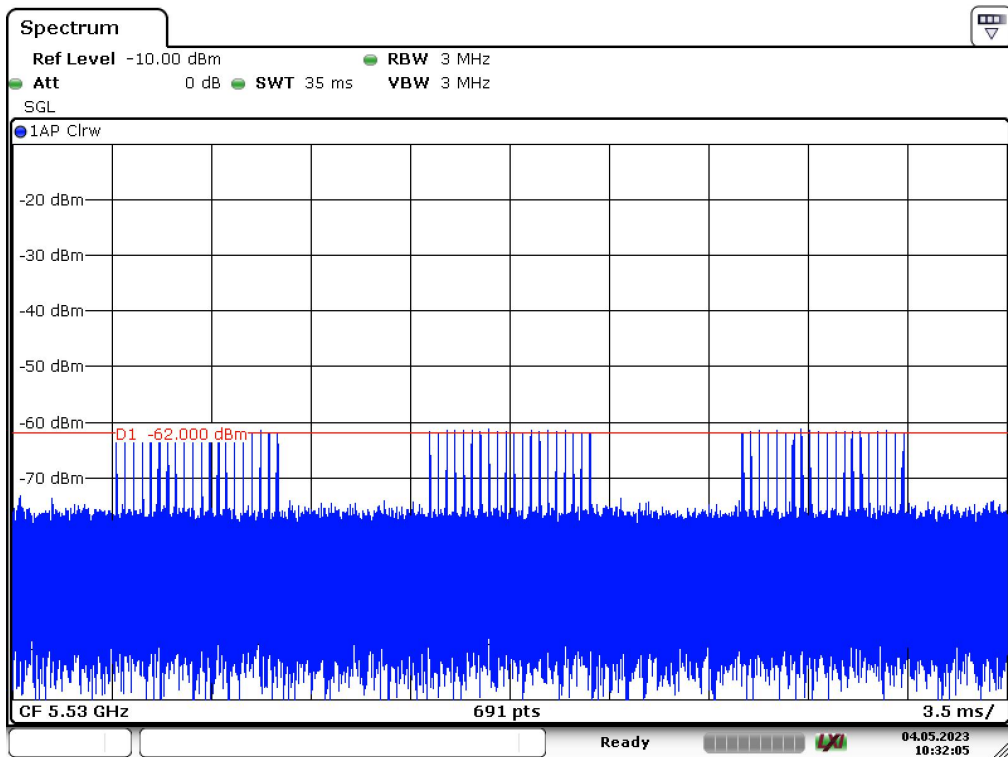

Radar Type 4 – 5530MHz

Radar type 5

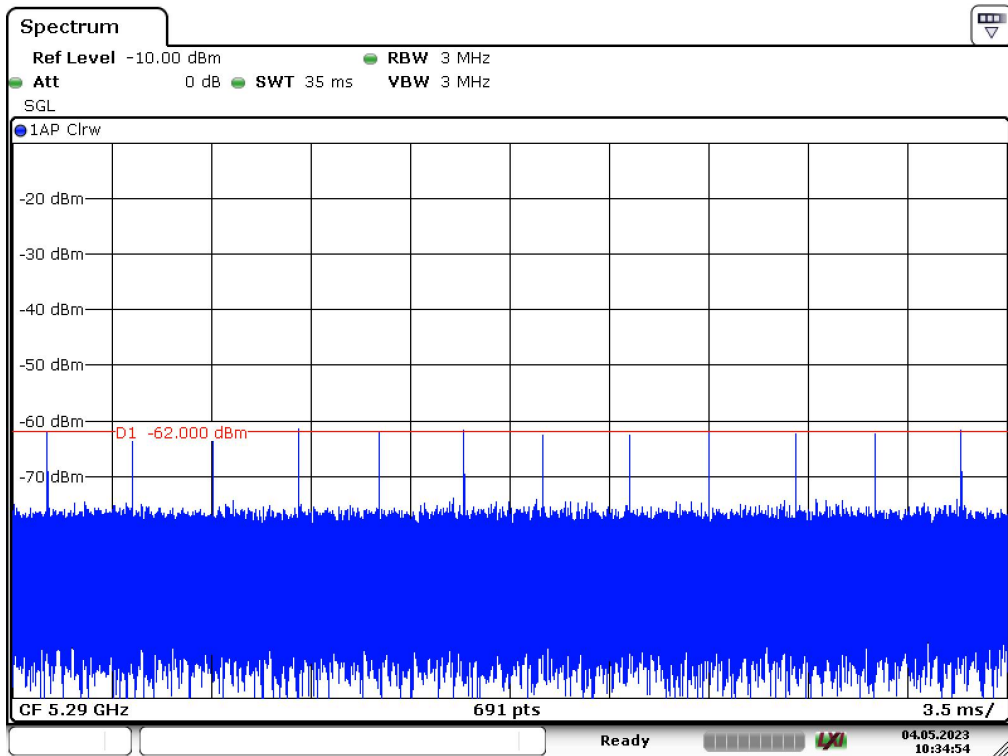

Radar Type 5 – 5290MHz

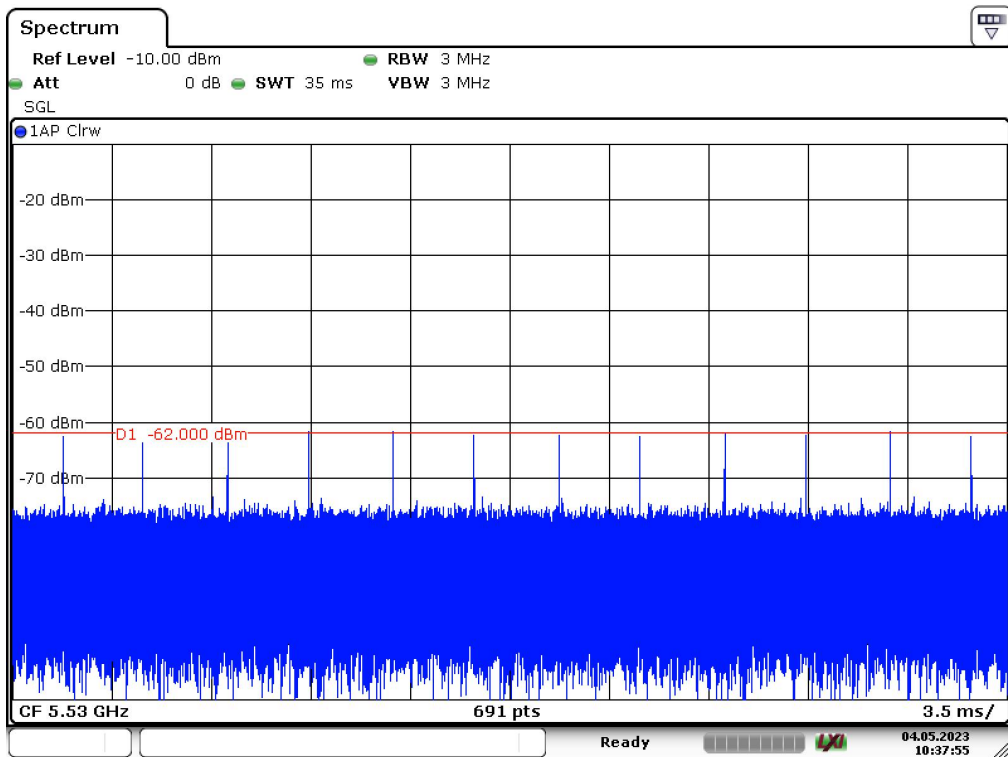

Radar Type 5 – 5530MHz

Radar type 6

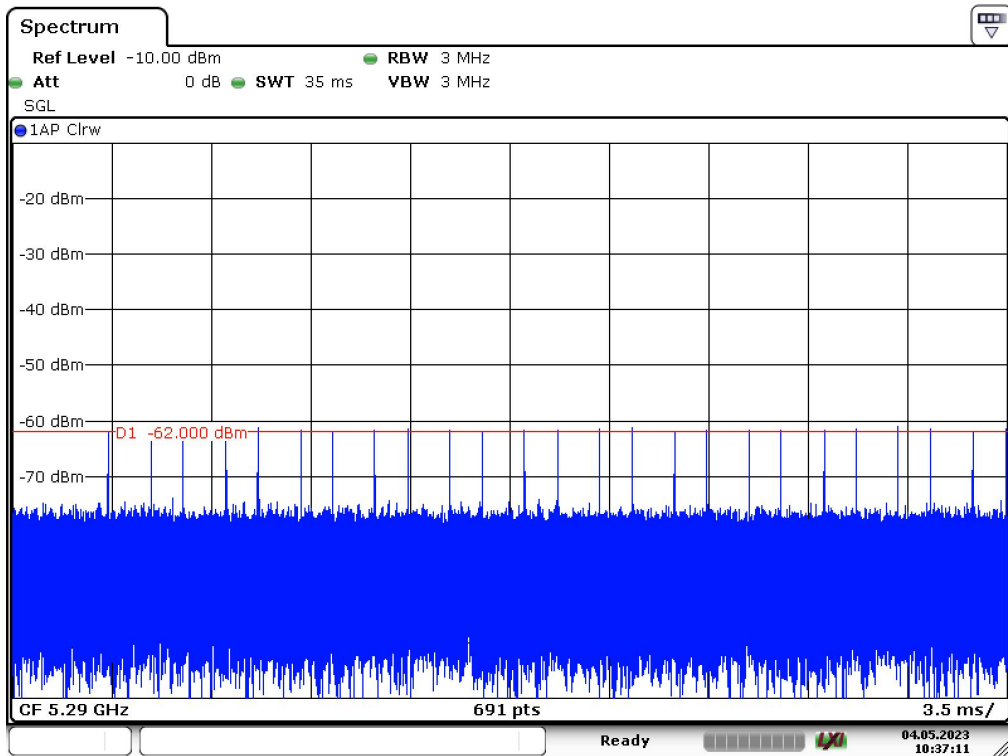

Radar Type 6 – 5290MHz

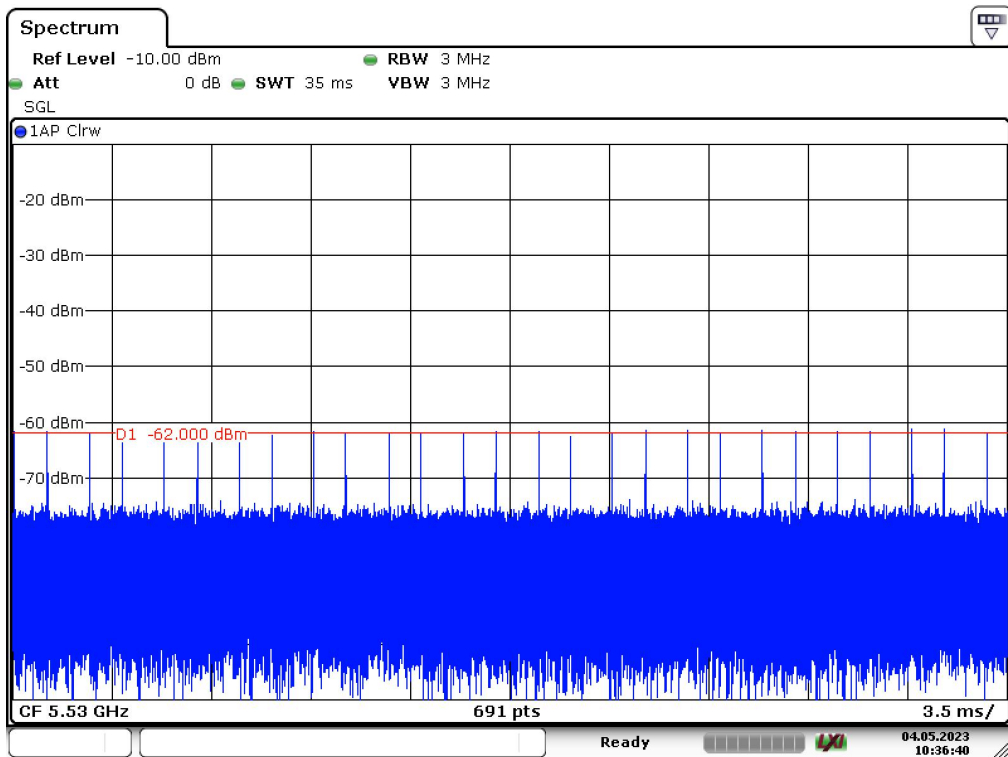

Radar Type 6 – 5530MHz



4. U-NII DFS Rule Requirements

Test Item	Operation Channel	Test Result	Limit	Result
Channel Move Time	58	1.106s	< 10s	Pass
Channel Closing Transmission Time		304.462ms	< 260ms	Pass
Non-Occupancy period		≥ 30	$\geq 30\text{min}$	Pass
Channel Move Time	106	0.006s	< 10s	Pass
Channel Closing Transmission Time		10.499ms	< 260ms	Pass
Non-Occupancy period		≥ 30	$\geq 30\text{min}$	Pass

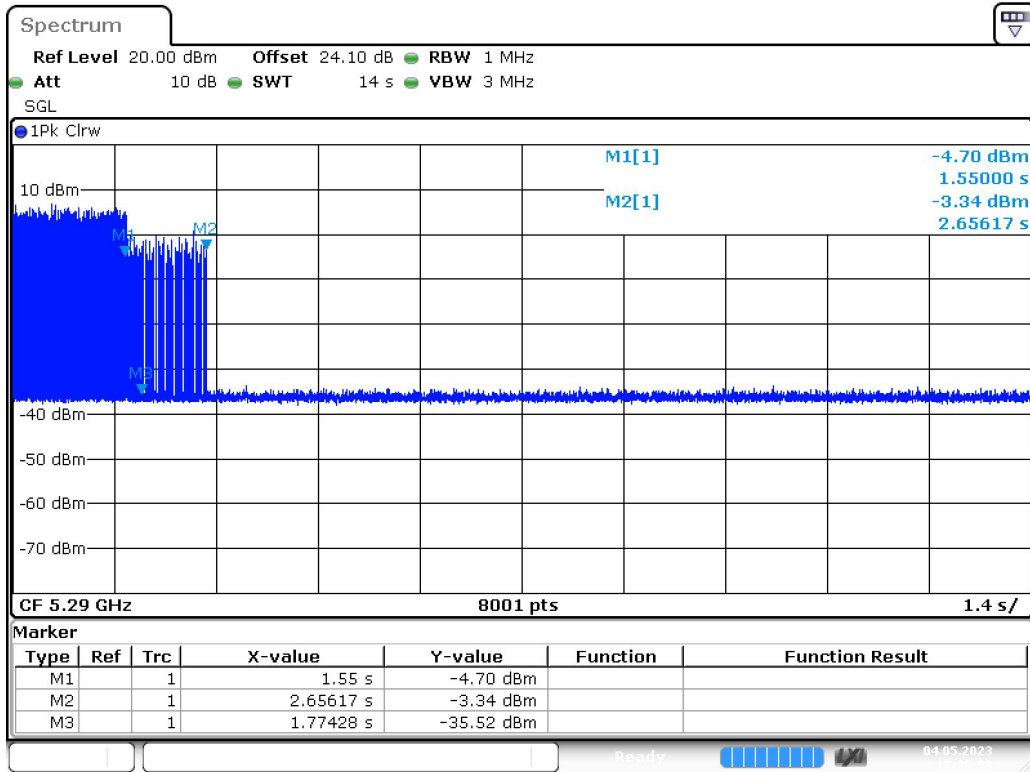

Date: 4.MAY.2023 17:28:08

80MHz_5290_Closing Transmission Time and Channel Move Time

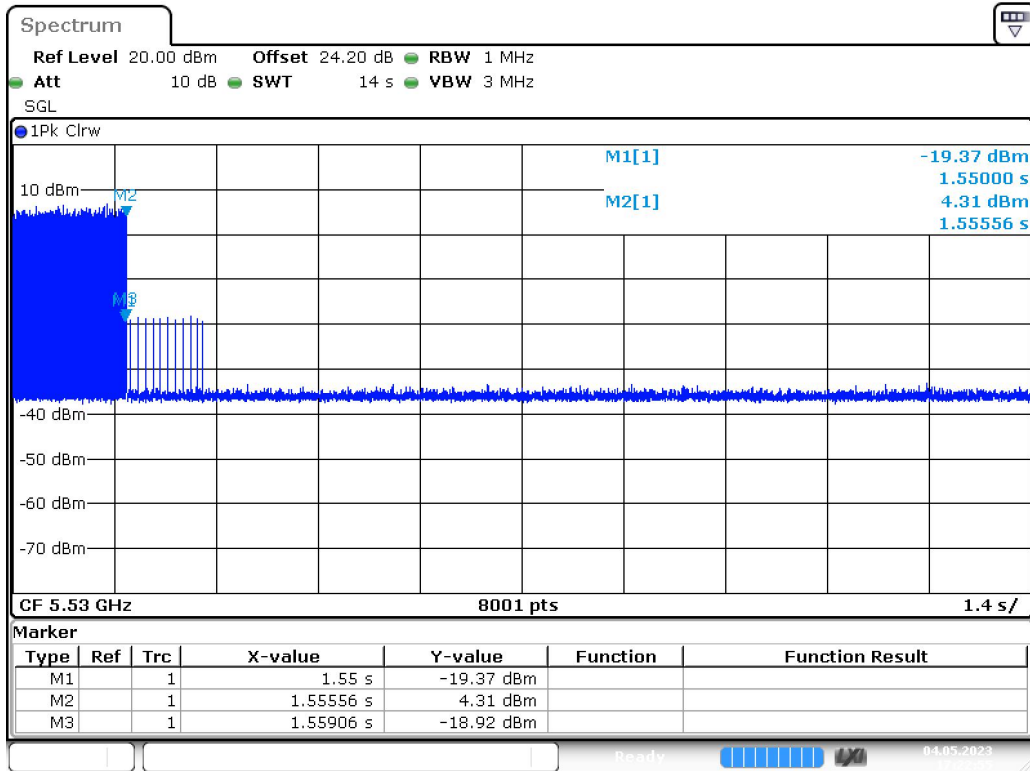

Date: 4.MAY.2023 17:22:56

80MHz_5530_Closing Transmission Time and Channel Move Time

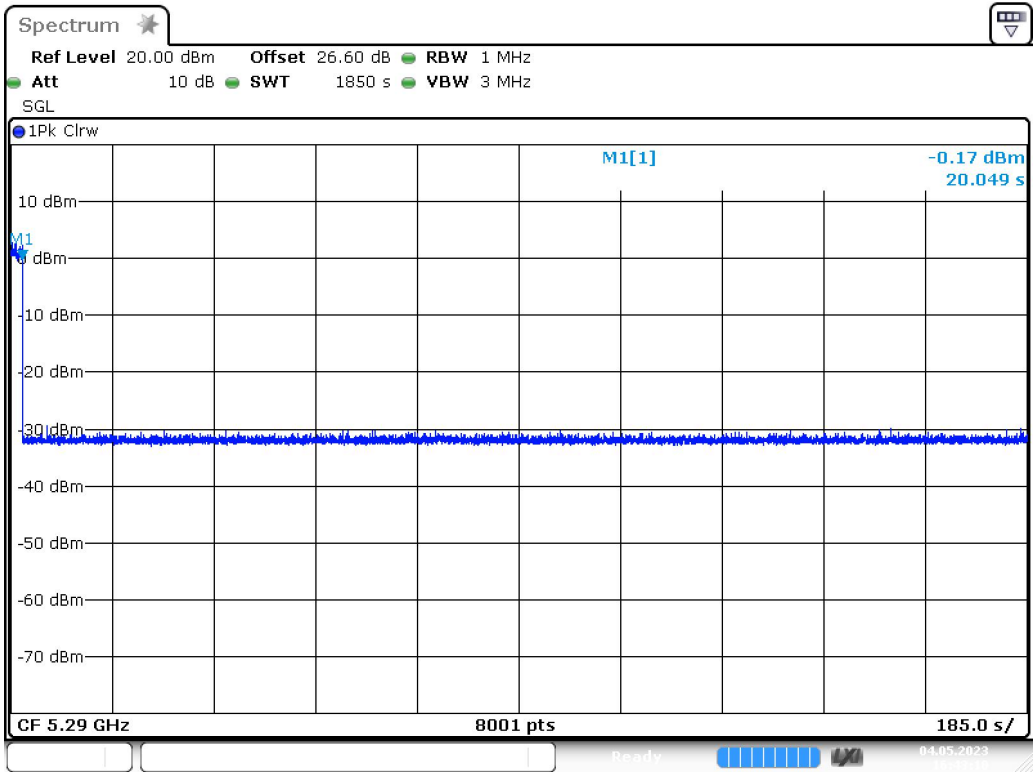

Date: 4.MAY.2023 16:43:10

80MHz_5290_Non Occupancy Period

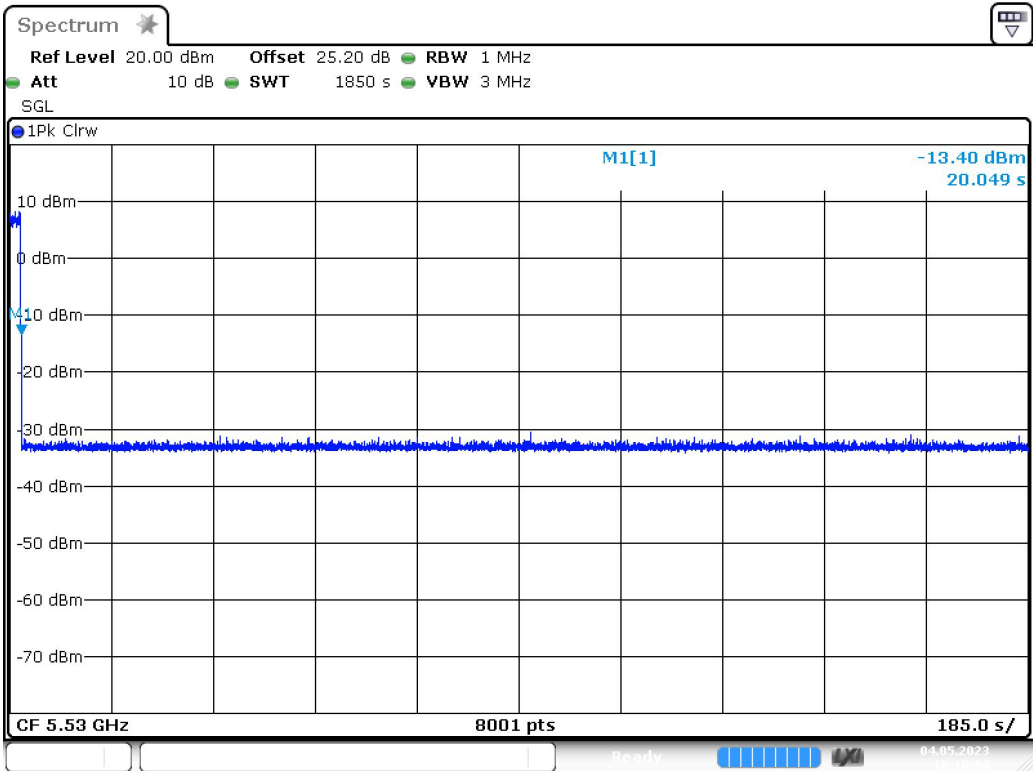

Date: 4.MAY.2023 18:10:04

80MHz_5530_Non Occupancy Period



5. U-NII DFS Rule Requirements

DFS Test System						
No.	Equipment Name	Serial No.	Model No.	Manufacturer	Cal Date	Due Date
1	Spectrum Analyzer	A140801886	FSV-40	R&S	2022.12.13	2023.12.12
2	Vector Signal Generator	A130901494	SMBV100A	R&S	2023.02.20	2024.02.19

Support Unit used in test configuration and system			
Equipment	Brand Name	Model Name	FCC ID
WLAN AP	ASUS	GT-AXE11000	MSQ-RTAXJF00
Notebook	HP	TPN-Q221	N/A

**** END OF REPORT ****