

OTA TEST REPORT

Applicant Espressif Systems
Product ESP ANT B
Model ESP ANT B
Report No. Y2302A0204-T1
Issue Date March 22, 2023

TA Technology (Shanghai) Co., Ltd. tested the above equipment in accordance with the requirements in **ANSI/IEEE Std 149-2021**. The test results show that the equipment tested is capable of demonstrating compliance with the requirements as documented in this report.

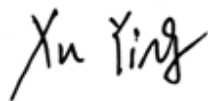

Prepared by: Xu Ying



Approved by: Xu Kai

TA Technology (Shanghai) Co., Ltd.

Building 3, No.145, Jintang Rd, Pudong Shanghai, P.R.China

TEL: +86-021-50791141/2/3

FAX: +86-021-50791141/2/3-8000

TABLE OF CONTENTS

1.	Test Laboratory.....	3
	1.1. Notes of the Test Report	3
	1.2. Test Facility	3
	1.3. Testing Location	3
	1.4. Laboratory Environment	3
2.	General Description of Equipment Under Test	4
	2.1. Applicant and Manufacturer Information.....	4
	2.2. General Information.....	4
	2.3. Test Date	4
	2.4. Received Date	4
	2.5. Applied Standards	5
3.	Test Conditions.....	6
	3.1. Test Configuration	6
	3.2. Test Measurement.....	6
4.	Test Results.....	7
	4.1. Gain and Efficiency.....	7
	4.2. Voltage Standing Wave Ratio (VSWR).....	8
	4.3. Antenna S11.....	9
5.	Equipment List.....	10
	ANNEX A: 2-D Pattern Plots	11
	ANNEX B: The EUT Appearance and Test Configuration.....	17
	B.1 EUT Appearance.....	17
	B.2 Test Configuration	19

1. Test Laboratory

1.1. Notes of the Test Report

This report shall not be reproduced in full or partial, without the written approval of **TA Technology (Shanghai) Co., Ltd.** The results documented in this report apply only to the tested sample, under the conditions and modes of operation as described herein. Measurement Uncertainties were not taken into account and are published for informational purposes only. This report is written to support regulatory compliance of the applicable standards stated above.

1.2. Test Facility

A2LA (Certificate Number: 3857.01)

TA Technology (Shanghai) Co., Ltd. has been listed by American Association for Laboratory Accreditation to perform measurement.

1.3. Testing Location

Company: TA Technology (Shanghai) Co., Ltd.
 Address: Building 3, No.145, Jintang Rd, Pudong Shanghai, P.R.China
 City: Shanghai
 Post code: 201201
 Country: P. R. China
 Contact: Xu Kai
 Telephone: +86-021-50791141/2/3
 Fax: +86-021-50791141/2/3-8000
 Website: <http://www.ta-shanghai.com>
 E-mail: xukai@ta-shanghai.com

1.4. Laboratory Environment

Temperature	Min. =19°C, Max. = 25°C	
Relative humidity	Min. =40%, Max. =72%	
Shield effect	0.7-6GHz	> 100dB
Ground resistance	<0.5Ω	

2. General Description of Equipment Under Test

2.1. Applicant and Manufacturer Information

Applicant Name	Espressif Systems
Applicant address	#101, Block 2, 690 Bibo Road, Zhang Jiang High-Tech Park, Shanghai, China
Manufacturer Name	Espressif Systems
Manufacturer address	#101, Block 2, 690 Bibo Road, Zhang Jiang High-Tech Park, Shanghai, China

2.2. General Information

EUT Description	
Product Name:	ESP ANT B
Model	ESP ANT B
HW Version:	/
SW Version:	/
Antenna Type:	PCB Antenna
Antenna Manufacturer:	Espressif Systems
Test Frequency:	2400MHz ~ 2494MHz
Note: The EUT is sent from the applicant to TA and the information of the EUT is declared by the applicant. All indications of Pass/Fail in this report are opinions expressed by TA Technology (Shanghai) Co., Ltd. based on interpretations and/or observations of test results. Measurement Uncertainties were not taken into account and are published for informational purposes only.	

This report only tests 2400MHz, 2402MHz and 2494MHz frequency points. For other test frequency points, please refer to the ESP ANT B report (Report No: Y1806A0621-T1V3).

2.3. Test Date

The test is performed from February 27, 2023 to March 1, 2023 for Report No: Y2302A0204-T1.

The test is performed from June 25, 2018 to August 3, 2018 for Report No: Y1806A0621-T1V3.

2.4. Received Date

The sample was received on February 27, 2023 for Report No: Y2302A0204-T1.

2.5. Applied Standards

According to the specifications of the manufacturer, it must comply with the requirements of the following standards:

Test Method: **ANSI/IEEE Std 149-2021**

3. Test Conditions

3.1. Test Configuration

Great-Circle-Cut method is used to measure the antenna 3D GAIN of EUT in OTA qualified anechoic chamber. Equipment Under Test (EUT) geometry centre vertical projection at the centre of platform, the distance from EUT to measurement antenna is 5m.

3.2. Test Measurement

Spherical coordinate system

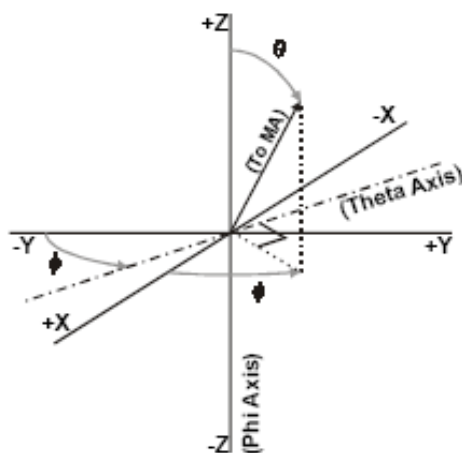
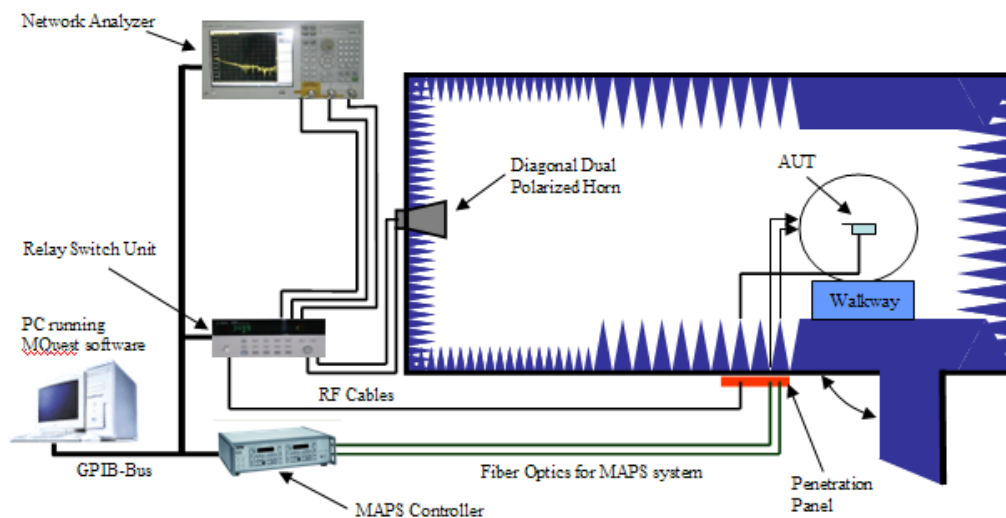

Figure 1 Test coordinate system

Note: Theta is from 0~180 degree. Phi is from 0~360. Rotate the EUT and record the Data, the step of rotation is 15 degree.

Test Setup



4. Test Results

4.1. Gain and Efficiency

Model	Test Item	Test State	Frequency (MHz)	Efficiency (%)	Gain (dBi)	Note
ESP-ANT B	Gain	Free Space	2400	67.12	3.14	/
			2402	62.06	2.89	
			2412	73.79	2.39	
			2417	77.04	2.97	
			2422	79.83	2.80	
			2427	81.19	2.89	
			2432	80.54	3.04	
			2437	76.86	2.86	
			2442	76.17	2.99	
			2447	73.99	2.96	
			2452	72.00	2.80	
			2457	70.71	2.72	
			2462	71.31	2.94	
			2467	71.32	3.12	
			2472	72.03	3.28	
			2477	72.71	3.24	
			2482	75.42	3.42	
2494	61.49	2.65				

Note:

- comment variation is +/- 0.02dBi
- The 2400MHz, 2402MHz, and 2494MHz frequencies were tested on February 27, 2023 to March 1, 2023. Other test frequencies were tested on June 25, 2018 to August 3, 2018.

4.2. Voltage Standing Wave Ratio (VSWR)

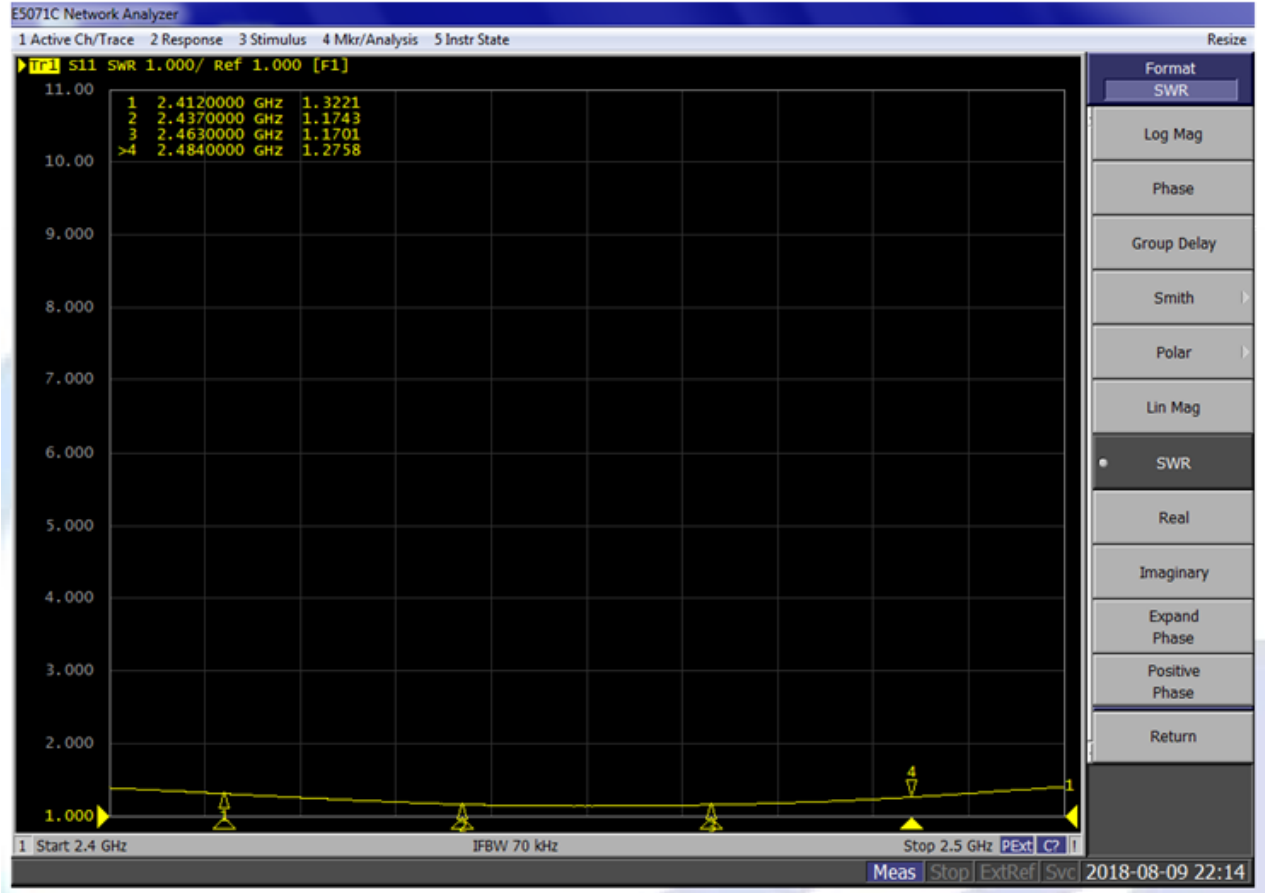

Frequency (MHz)	2412	2437	2463	2484
VSWR	1.32	1.17	1.17	1.28

4.3. Antenna S11



Frequency (MHz)	2412	2437	2463	2484
S11(dB)	-17.07	-21.64	-22.52	-18.51

5. Equipment List

Date of Testing: June 25, 2018 ~ August 3, 2018

Type of Equipment	Manufacture	Model Number	S/N	Calibration Date	Expiration Time
Network Analyzer	Key sight	E5071B	MY42404014	2018-05-20	2019-05-19
Switch Control System	ETS	7006/7001	00059957/MY42001152	2018-05-20	2019-05-19
Dual polarized horn antenna	ETS	3164-04	00062743	2018-05-20	2019-05-19
Anechoic Chamber	ETS	AMS-8500	CT-001157-1219	/	/
Software	ETS-lindgren	EMQ-100 Pattern Measurement software	1.09	/	/

Date of Testing: February 27, 2023 ~ March 1, 2023

Type of Equipment	Manufacture	Model Number	S/N	Calibration Date	Expiration Time
Anechoic Chamber	ETS	AMS-8500	CT-001157-1219	2020-05-17	2025-05-16
Test Software	ETS	EMQuest™	REV 1.16	/	/
EMCenter_Switch Control System	ETS	7006/7001	00059957/MY42001152	/	/
Diagonal Dual Polarized Horn	ETS	ETS 3164-04	00062743	2020-04-14	2025-04-13
Network Analyzer	Keysight	E5071B	MY42404014	2022-05-14	2023-05-13

ANNEX A: 2-D Pattern Plots

Max: 5
 Min: -50
 Scale: 5/div

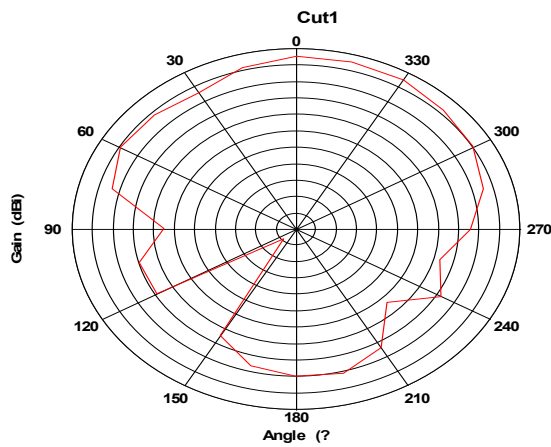

Horizontal X-Y

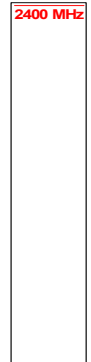

Max: 5
 Min: -25
 Scale: 5/div

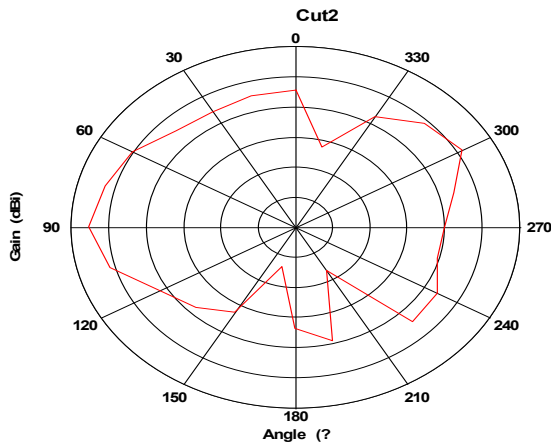

Horizontal X-Z



Max: 0
 Min: -40
 Scale: 5/div

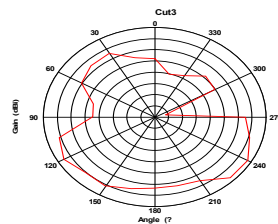

Horizontal Y-Z



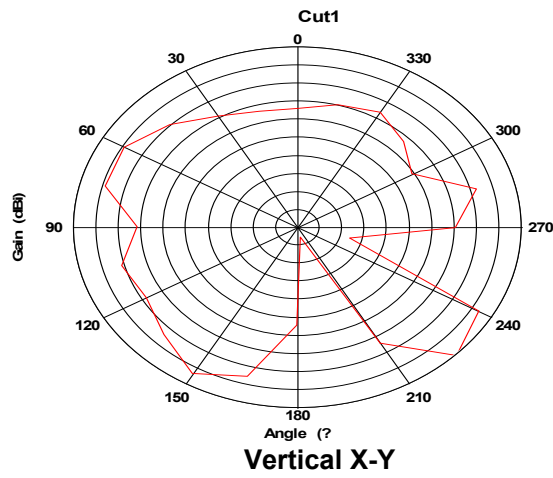

Max: 0
 Min: -20
 Scale: 2/div

2400 MHz

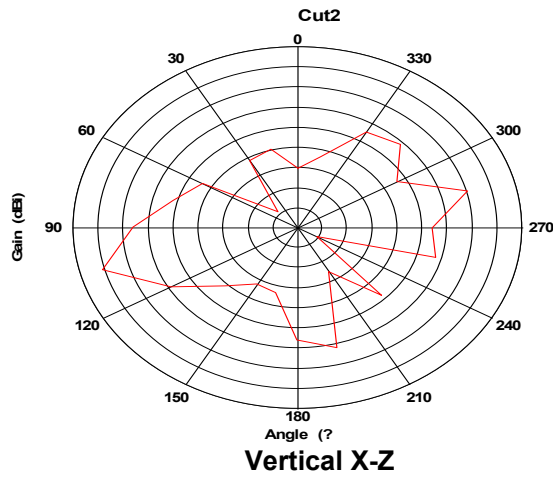

Max: -2
 Min: -20
 Scale: 2/div

2400 MHz

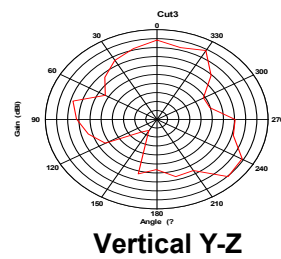

Max: 0
 Min: -20
 Scale: 2/div

2400 MHz

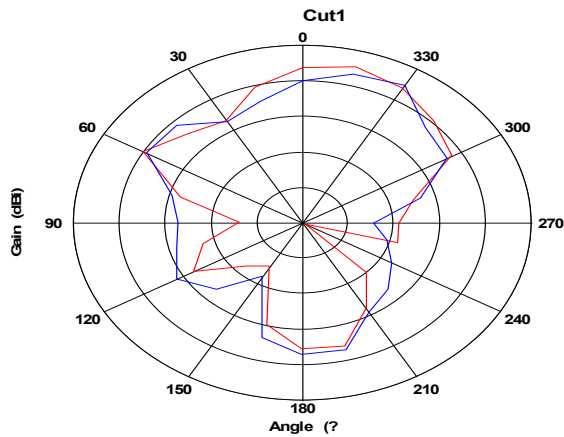

Max: 5
 Min: -20
 Scale: 5/div

2402 MHz
 2494 MHz

Horizontal X-Y

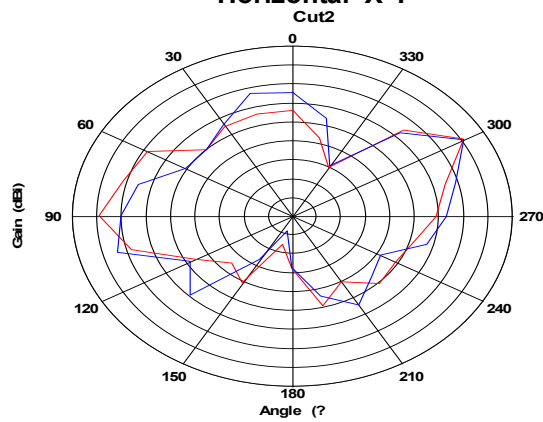

Max: 4
 Min: -14
 Scale: 2/div

2402 MHz
 2494 MHz

Horizontal X-Z

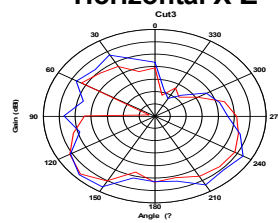

Max: 0
 Min: -35
 Scale: 5/div

2402 MHz
 2494 MHz

Horizontal Y-Z

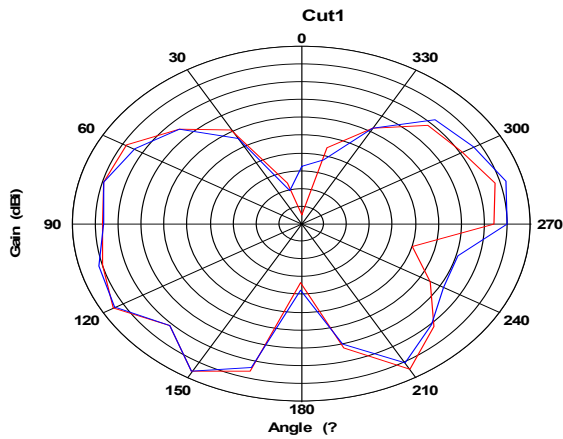

Max: 0
 Min: -20
 Scale: 2/div

2402 MHz
 2494 MHz

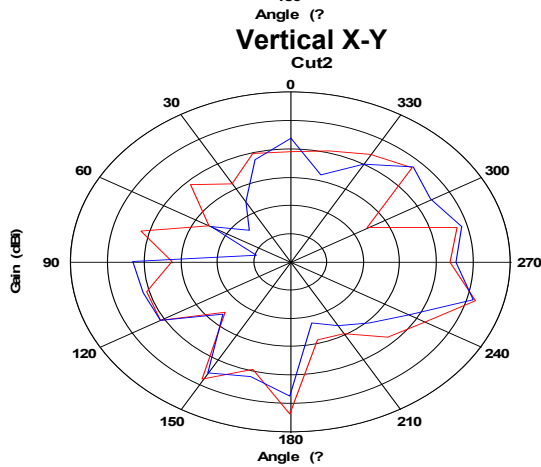

Max: -5
 Min: -35
 Scale: 5/div

2402 MHz
 2494 MHz

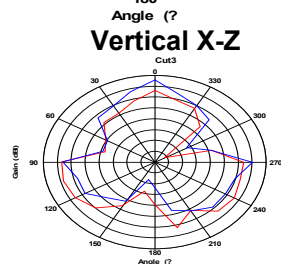

Max: 0
 Min: -15
 Scale: 2/div

2402 MHz
 2494 MHz

Vertical Y-Z

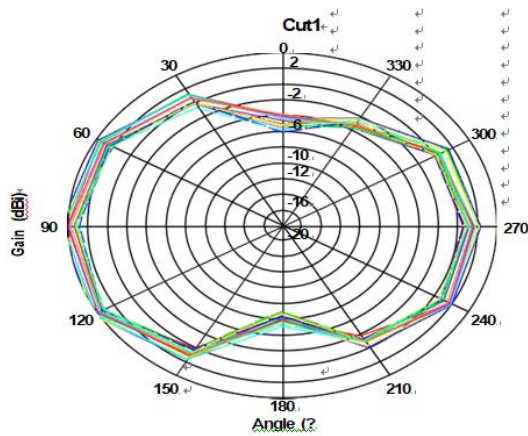

- 2412 MHz
- 2417 MHz
- 2422 MHz
- 2427 MHz
- 2432 MHz
- 2437 MHz
- 2442 MHz
- 2447 MHz
- 2452 MHz
- 2457 MHz
- 2462 MHz
- 2467 MHz
- 2472 MHz
- 2477 MHz
- 2482 MHz

Max: 2
Min: -20
Scale: 2/div

Horizontal X-Y

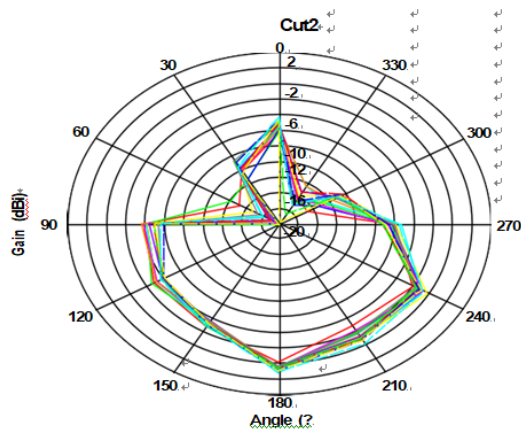

- 2412 MHz
- 2417 MHz
- 2422 MHz
- 2427 MHz
- 2432 MHz
- 2437 MHz
- 2442 MHz
- 2447 MHz
- 2452 MHz
- 2457 MHz
- 2462 MHz
- 2467 MHz
- 2472 MHz
- 2477 MHz
- 2482 MHz

Max: 2
Min: -20
Scale: 2/div

Horizontal X-Z

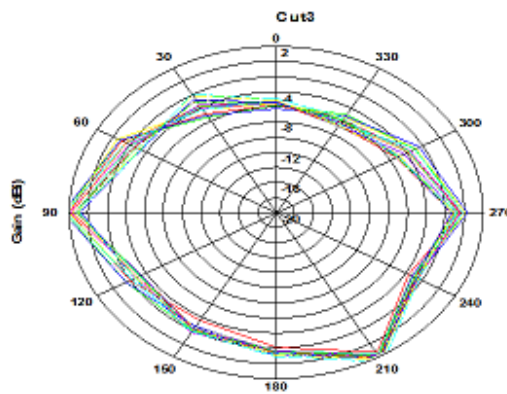

- 2412 MHz
- 2417 MHz
- 2422 MHz
- 2427 MHz
- 2432 MHz
- 2437 MHz
- 2442 MHz
- 2447 MHz
- 2452 MHz
- 2457 MHz
- 2462 MHz
- 2467 MHz
- 2472 MHz
- 2477 MHz
- 2482 MHz

Max: 2
Min: -20
Scale: 2/div

Horizontal Y-Z

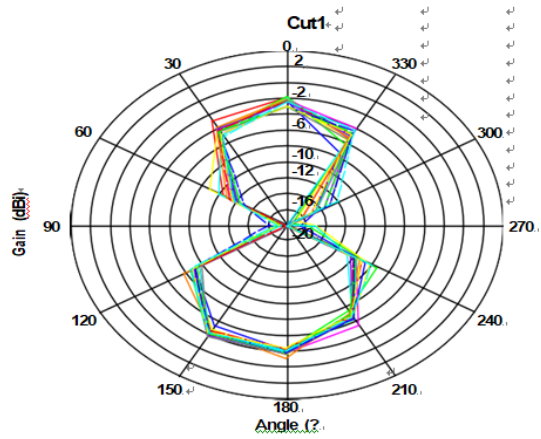

Max: 2
Min: -20
Scale: 2/div

- 2412 MHz
- 2417 MHz
- 2422 MHz
- 2427 MHz
- 2432 MHz
- 2437 MHz
- 2442 MHz
- 2447 MHz
- 2452 MHz
- 2457 MHz
- 2462 MHz
- 2467 MHz
- 2472 MHz
- 2477 MHz
- 2482 MHz

Vertical Y-Z

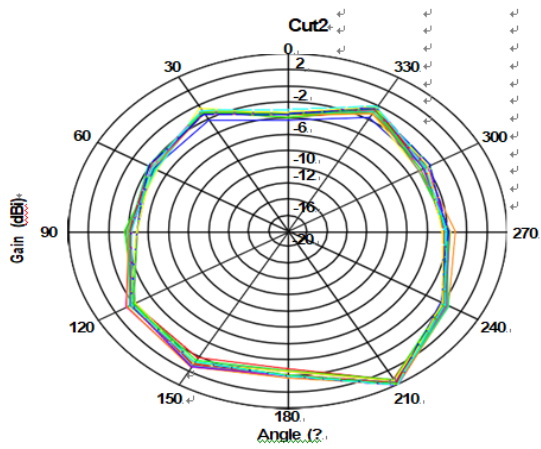

Max: 2
Min: -20
Scale: 2/div

- 2412 MHz
- 2417 MHz
- 2422 MHz
- 2427 MHz
- 2432 MHz
- 2437 MHz
- 2442 MHz
- 2447 MHz
- 2452 MHz
- 2457 MHz
- 2462 MHz
- 2467 MHz
- 2472 MHz
- 2477 MHz
- 2482 MHz

Vertical X-Z

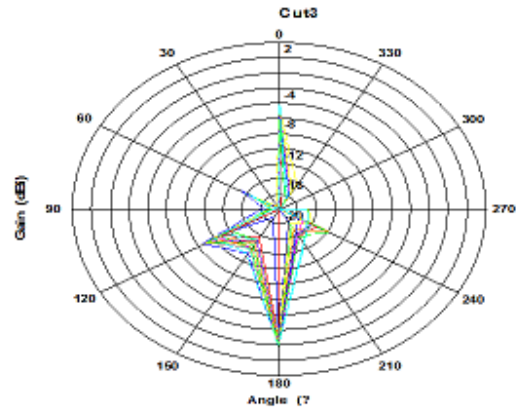

Max: 2
Min: -20
Scale: 2/div

- 2412 MHz
- 2417 MHz
- 2422 MHz
- 2427 MHz
- 2432 MHz
- 2437 MHz
- 2442 MHz
- 2447 MHz
- 2452 MHz
- 2457 MHz
- 2462 MHz
- 2467 MHz
- 2472 MHz
- 2477 MHz
- 2482 MHz

Vertical X-Y

ANNEX B: THE EUT APPEARANCE AND TEST CONFIGURATION

B.1 EUT Appearance

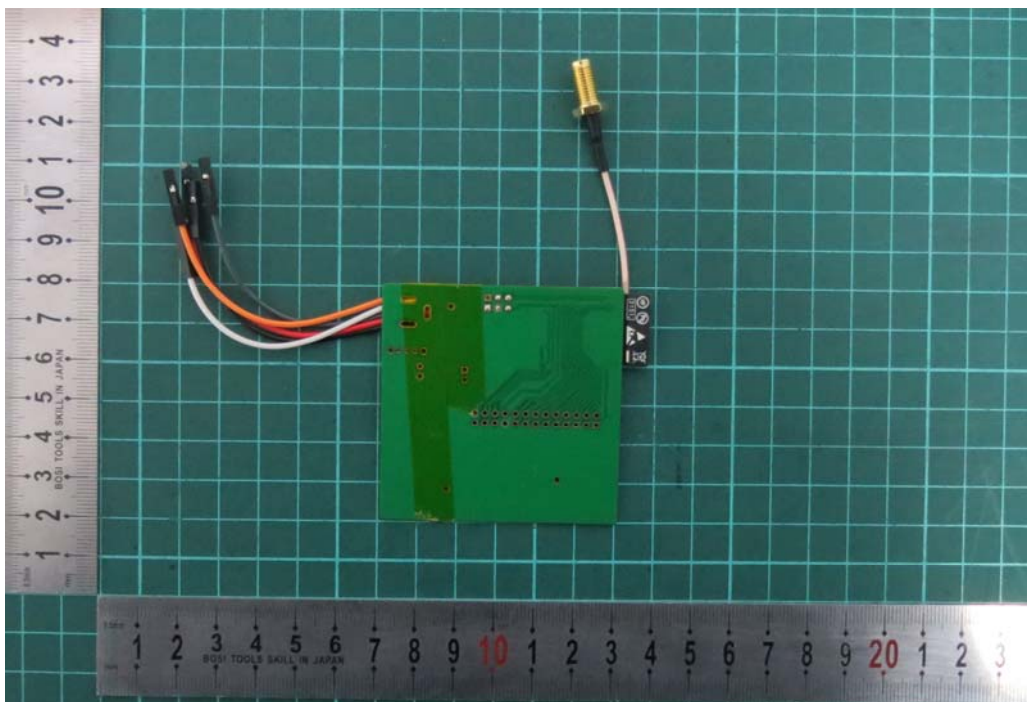
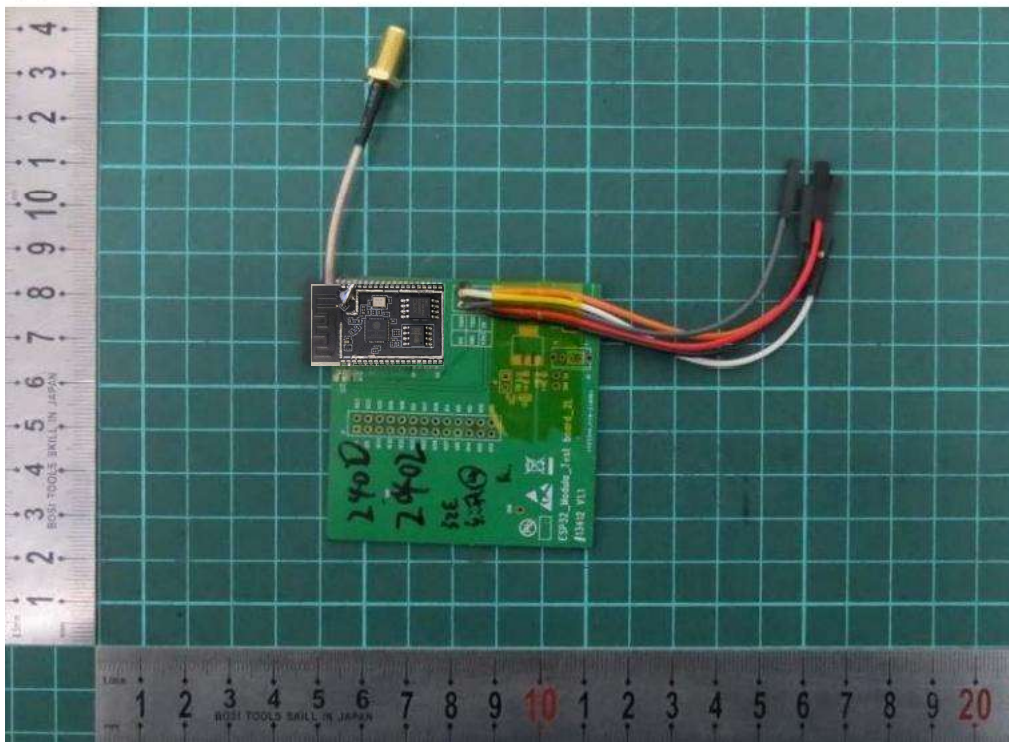

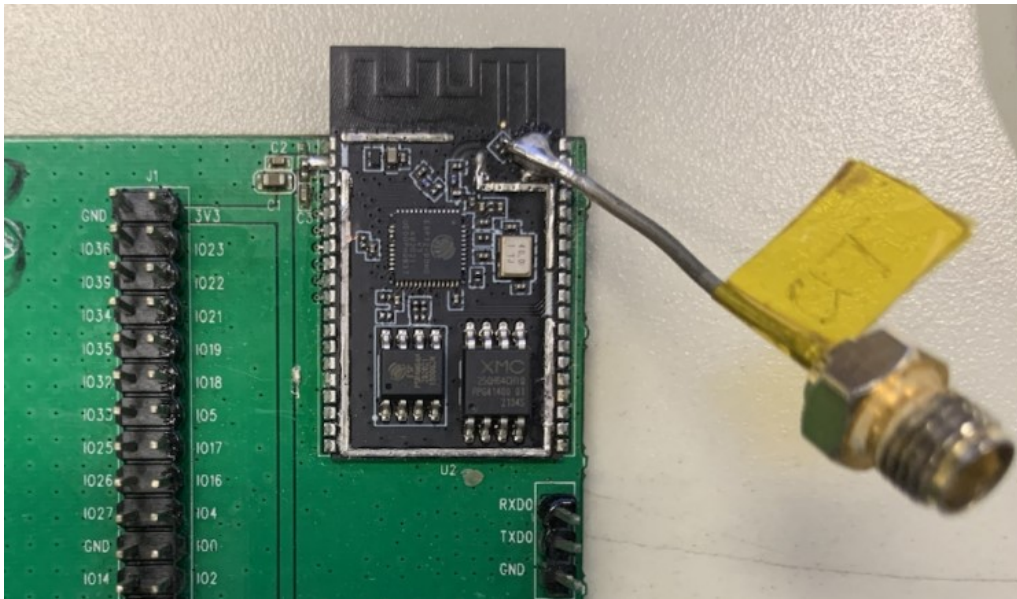

Picture 1 Constituents of EUT

B.2 Test Configuration

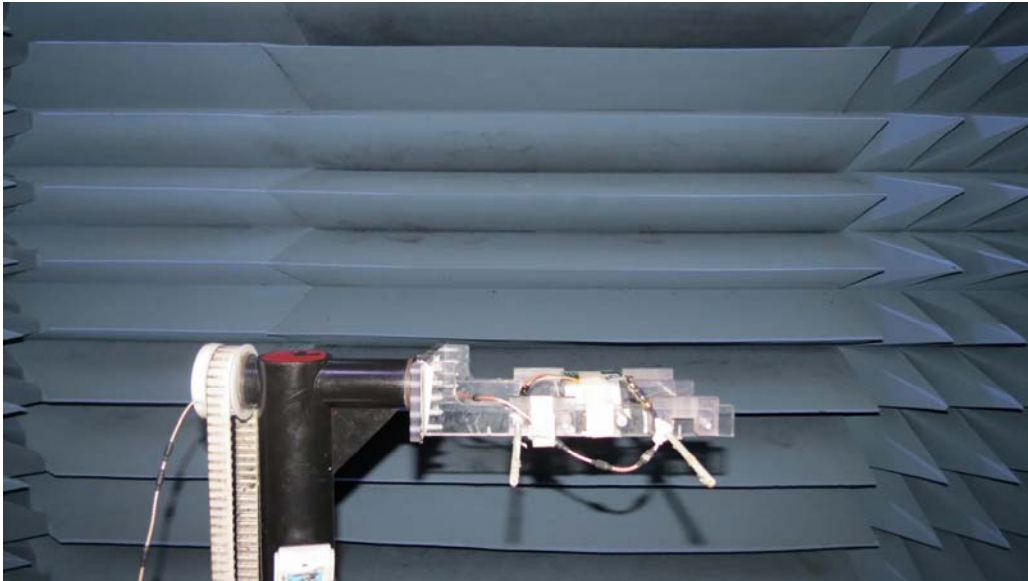

Picture 2 Test Setup

*****END OF REPORT *****