A line art illustration of a hand holding a device. The device has a circular lens or sensor at the bottom and a handle at the top. The word "COXPAL" is written in a stylized, outlined font on the handle.

COXPAL

**COXPAL**

# User Manual

---

Model No: **A9D**



# Contents:

①	Safety Instructions	/01
②	What's In The Box	/02
③	At A Glance	/03
④	microSD Card	/04
⑤	Installation	/06
⑥	Use	/08
	1. Daily Use	
	2. Shortcut Keys	
	3. LED Indicators	
	4. Screen Overview	
	5. Main Menu	
	6. Parking Monitor	
	7. Watch recordings via PC & TV	
	8. Reset	
	9. Firmware Upgrading	
⑦	Android & iOS APP	/15
⑧	Specifications	/18
⑨	FAQs	/19
⑩	Warranty & Support	/21

# Safety Instructions

Please read and understand all instructions hereunder before using this product. If damage is caused by failure to follow the instructions, the warranty does not apply.

- Keep this user manual.
- DO NOT operate this product while driving.
- DO NOT drop, puncture, or disassemble this product.
- DO NOT expose this product to liquid, or open flames.
- DO NOT use any corrosive cleaners/oils to clean this product.
- DO NOT install this product where it can block the driver's view.
- DO NOT use the power charger if the power cable is damaged, or broken.
- Use original accessories only.
- Set time and date correctly before using this product.
- Keep the camera lens clean and nothing blocking the lens.
- Remove this product from your vehicle when not in use for a long period.
- Avoid long exposure to direct sunlight or high temperature that may significantly shorten the lifespan of the product.
- The Company is NOT responsible for the loss of any data during the use.

# 2/ What's In The Box



A. 1 \* Coxpal A9D Dual Dash Camera

B. 1 \* USB to USB Type-C Cable 3.5M(11FT)

C. 1 \* Dual USB Car Charger 5Vdc/2.4A

D. 1 \* Crowbar

E. 1 \* GPS Mount,  
With Adhesive Tape

F. 1 \* Spare Adhesive Tape

G. 1 \* User Manual

# 3 At A Glance

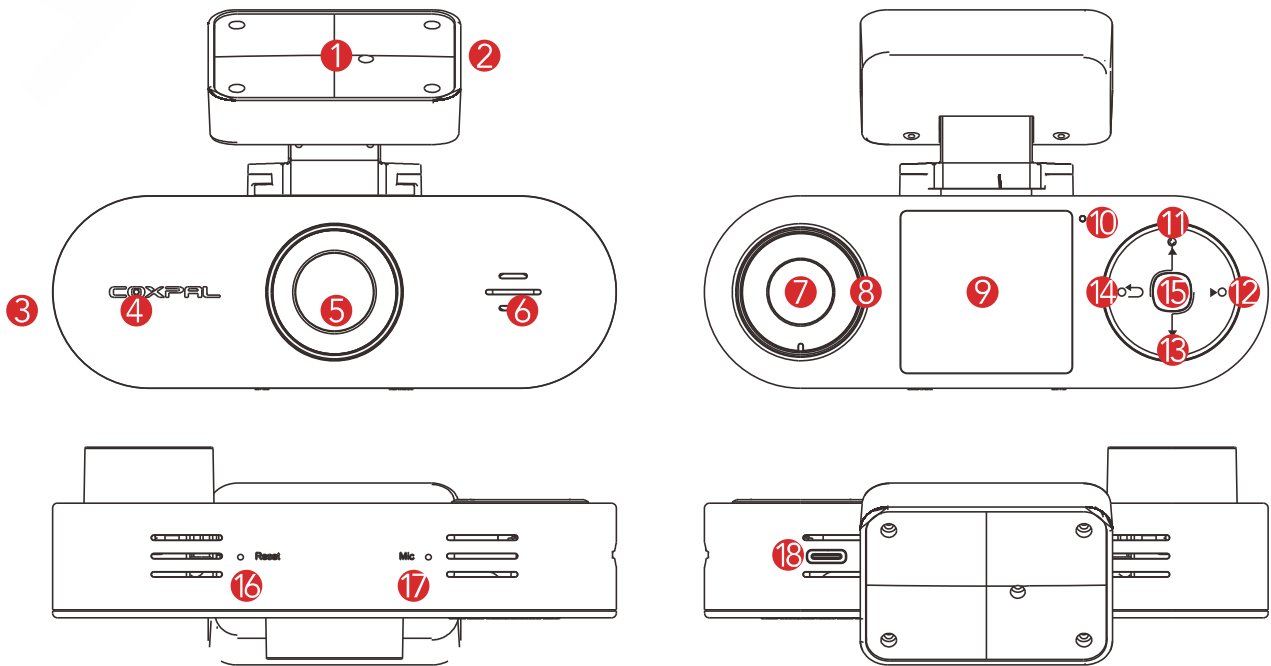

No	Name	Description
1	GPS Mount	Rotatable, detachable, adhesive
2	USB Type-C port 1	5Vdc power input
3	microSD Card Slot	For an external microSD card
4	Parking Indicator	Indicates parking mode
5	Front Camera Lens	Rotatable by GPS mount
6	Speaker	Plays audio
7	Inside Camera Lens	5° all-direction rotatable
8	IR LED lights	6pcs IR LED lights for infrared night vision
9	LCD Screen	1.5" TFT Color LCD Display
10	Working Indicator	Indicates working modes
11	Up	Navigate; Pause Recording Mode
12	Right	Switch front/front+inside/inside preview
13	Down	Navigate; Mute/Unmute
14	Left	Return; Emergency lock; WiFi Shortcut Key
15	OK	Power on/off; Confirm;
16	Reset	Reset to factory default
17	Microphone	Records audio
18	USB Type-C port 2	5Vdc power input & Video output

# 4 microSD Card

1. This camera supports genuine microSD memory card up to 256GB with a speed rating of class 10(UHS-1) or above.
2. For 64GB or 128GB or 256GB card, please beforehand format it to FAT32, the card can be formatted by either this camera or computer (Windows & Mac).
3. DO NOT remove, or insert the card when this camera is powered on which may cause card corruption and data loss.
4. Typical recording time in normal recording mode:

Capacity	1080P@30FPS Dual	1080P@60FPS Front Single	1440P@30FPS Front Single
32GB	3	3.5	3.5
64GB	5.8	7	7
128GB	11.8	14	14

5. Insert the card with the gold contacts facing the screen side of the camera, push the card until it clicks into the place.
6. To remove the card, gently push its top edge inward until it clicks, then pull it out of the card slot.

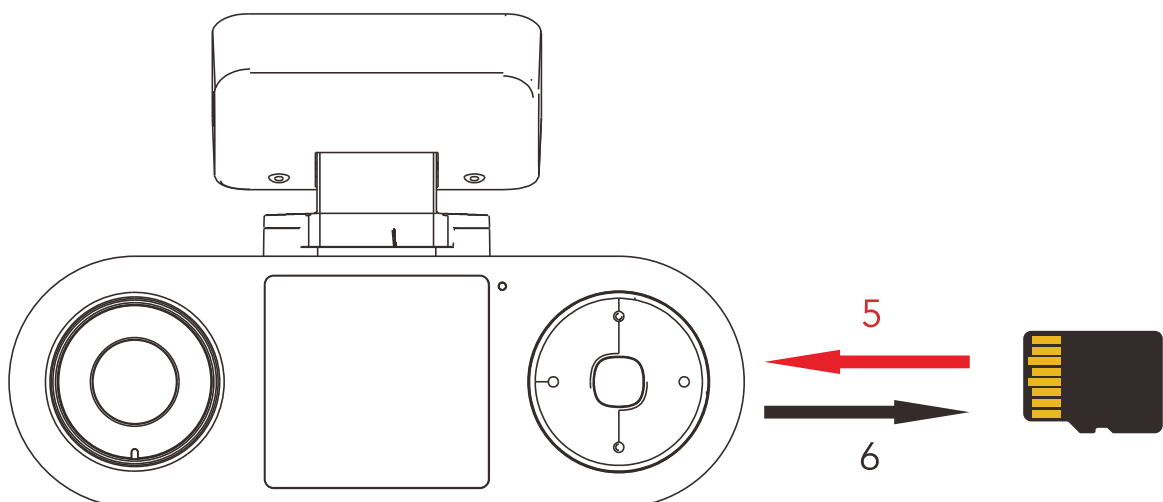

7. The recordings will be saved into following 4 folders respectively:

Folder	What's the folder?	Overwritten if set loop recording?
Front Normal	<ul style="list-style-type: none"> <li>• Normal;</li> <li>• Parking.</li> </ul>	<p><b>Yes</b></p> <ul style="list-style-type: none"> <li>• Based on "First in first out" when storage is full;</li> <li>• If set loop recording off, pop-up box appears when storage is full.</li> </ul>
Front Event	<ul style="list-style-type: none"> <li>• Manually locked;</li> <li>• G-sensor locked;</li> <li>• Moved from "Normal".</li> </ul>	<p><b>No</b></p> <ul style="list-style-type: none"> <li>• Pop-up box appears when storage is full.</li> <li>• Need to manually export/delete the file, or format the SD card.</li> </ul>
Inside Normal	<ul style="list-style-type: none"> <li>• Normal;</li> <li>• Parking.</li> </ul>	<p><b>Yes</b></p> <ul style="list-style-type: none"> <li>• Based on "First in first out" when storage is full;</li> <li>• If set loop recording off, pop-up box appears when storage is full.</li> </ul>
Inside Event	<ul style="list-style-type: none"> <li>• Manually locked;</li> <li>• G-sensor locked;</li> <li>• Moved from "Normal".</li> </ul>	<p><b>No</b></p> <ul style="list-style-type: none"> <li>• Pop-up box appears when storage is full.</li> <li>• Need to manually export/delete the file, or format the SD card.</li> </ul>

**Note:**

1. Loop recording means the memory card is written and overwritten frequently, therefore, we strongly recommend to use high endurance card and not recommend to use generic card.
2. Check and format the microSD card every 2 weeks to ensure it works properly and stores the data securely.



# 5 Installation

1. Install this product near the rear-view mirror to obtain the best open-field view.
2. DO NOT install it in a location where may obstruct driver's view.
3. Ensure the lens is within the wiping range of the windscreen wiper to ensure a clear view in all weather conditions.
4. Keep the lens stays clean to ensure clear videos – be especially careful not to leave fingerprints.
5. Ensure the surface of the windscreen is clean and dry and attach the adhesive mount onto the windscreen securely.
6. Store spare adhesive tape in case of future use.

## Steps to install:

1. Quick test before installation.
  - Insert a memory card into the camera.
  - Power on the camera by connecting with the supplied power cable and USB car charger (or, a 5Vdc/2A wall charger if at home, i.e. DO NOT get power from computer's USB or car's own USB ports).
  - If "SD card error", please format the microSD card.
  - Implement the installation if everything works normally.

2. Select an ideal location (A or B or C) on the windshield near the rear-view mirror, clean with clear water and wait until fully dry.

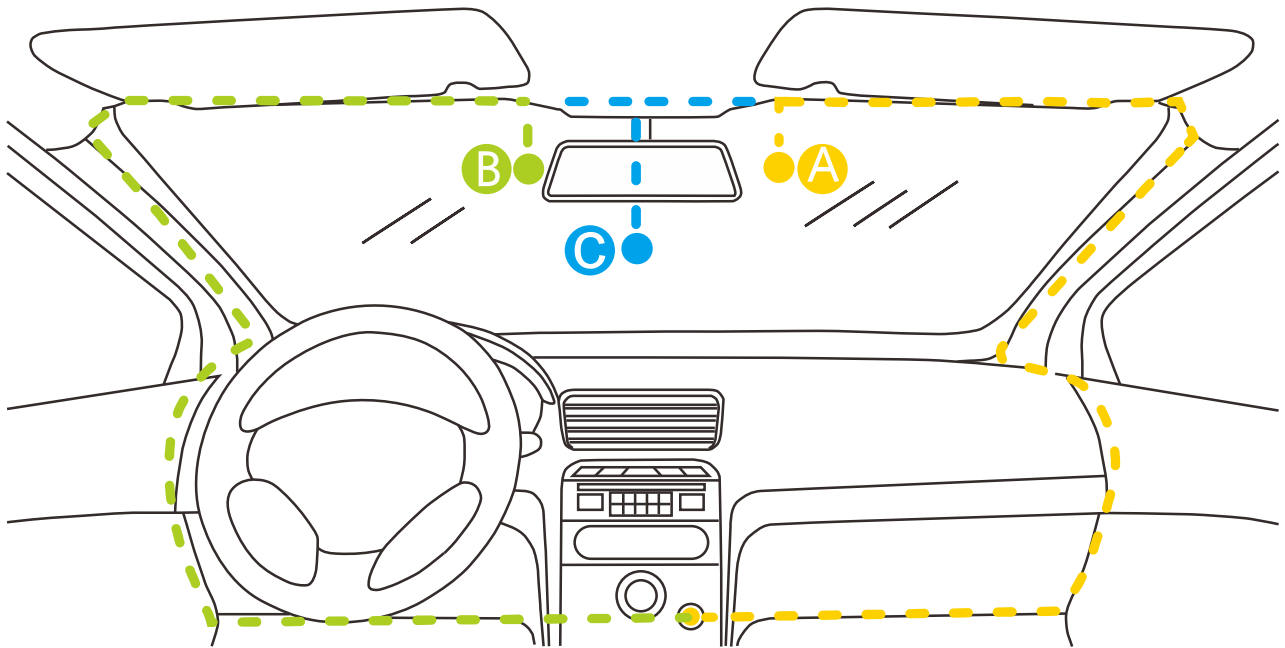

3. Remove the protective film of the adhesive tape and firmly affix the mount onto the windshield.
4. Use the crowbar to tuck and hide the power cable into the seams and weatherstrips around the edge of the dashboard.
5. Adjust the viewing angle of front lens and rear lens respectively to ensure that they are aligned with the road ahead and the cabin inside.

# 6 Use

## 1. Daily Use

Once installed properly, the camera will function without the need for maintenance. The following are 3 key status indicators:

- **Micro SD card:** If the SD card is functioning abnormally, the camera will beep.
- **Camera Power State:** The cameras LED indicates that it is operating normally.
- **Camera Recording Mode:** The red dot will flash on the screen, which indicates that it is recording.

## 2. Shortcut Keys

The shortcut keys valid under Recording Mode (Red dot flashes on screen):

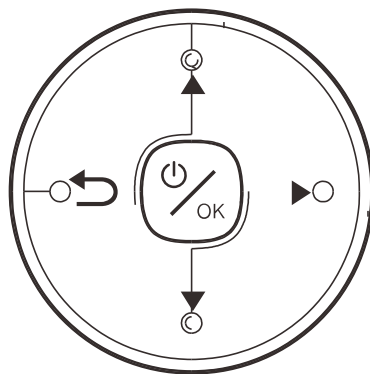

Short Press	UP	Pause Recording Mode
Short Press	RIGHT	Switch screen between Front/Picture in Picture/Inside
Long Press	DOWN	Mute/Unmute, turn off/on audio recording
Short Press	LEFT	Lock/Unlock the current video clip
Long Press		WiFi on
Long Press	OK	Power off/on the camera

### 3. LED Indicators

Working Indicator	Green Flash	Normal recording
	Green Quick Flash	Firmware upgrading
	Green Constant On	Camera power on
Parking Indicator	Red Flash(off optional)	Parking mode

### 4. Screen Overview

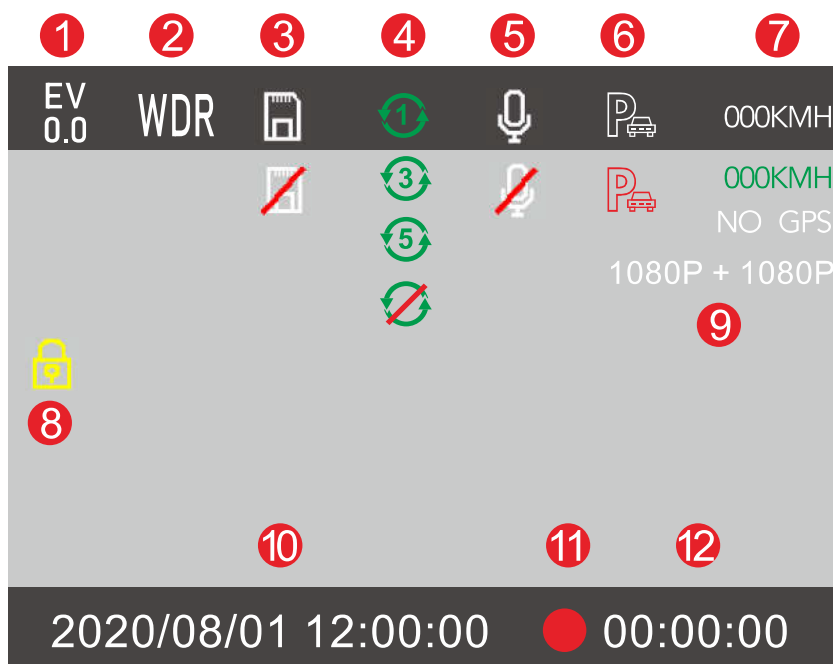

No	Name	Description
1	EV	Exposure Value
2	WDR	Wide Dynamic Range
3	SD card	SD card normal; abnormal
4	Loop Recording	1min; 3min; 5min; Off
5	Microphone	Audio is being recorded; Mute
6	Parking Mode	Parking mode is On; Off
7	GPS	Positioning; GPS normal; No GPS
8	Emergency lock	Current video clip is Locked; Unlock
9	Resolution	Video resolution for front & rear
10	Time	Current time YYYY/MM/DD
11	Recording Mode	Video is being recorded
12	Video Duration	Current video clip recording time

## 5. Main Menu

1. Enter into Main Menu: Short press UP to pause Recording Mode (Red dot disappears on screen) → Short press LEFT.
2. Set parameters in Main Menu: UP/DOWN to navigate; OK to confirm.
3. Exit from Main Menu: Short press LEFT → Back to Recording Mode.
4. Main menu logic structure:

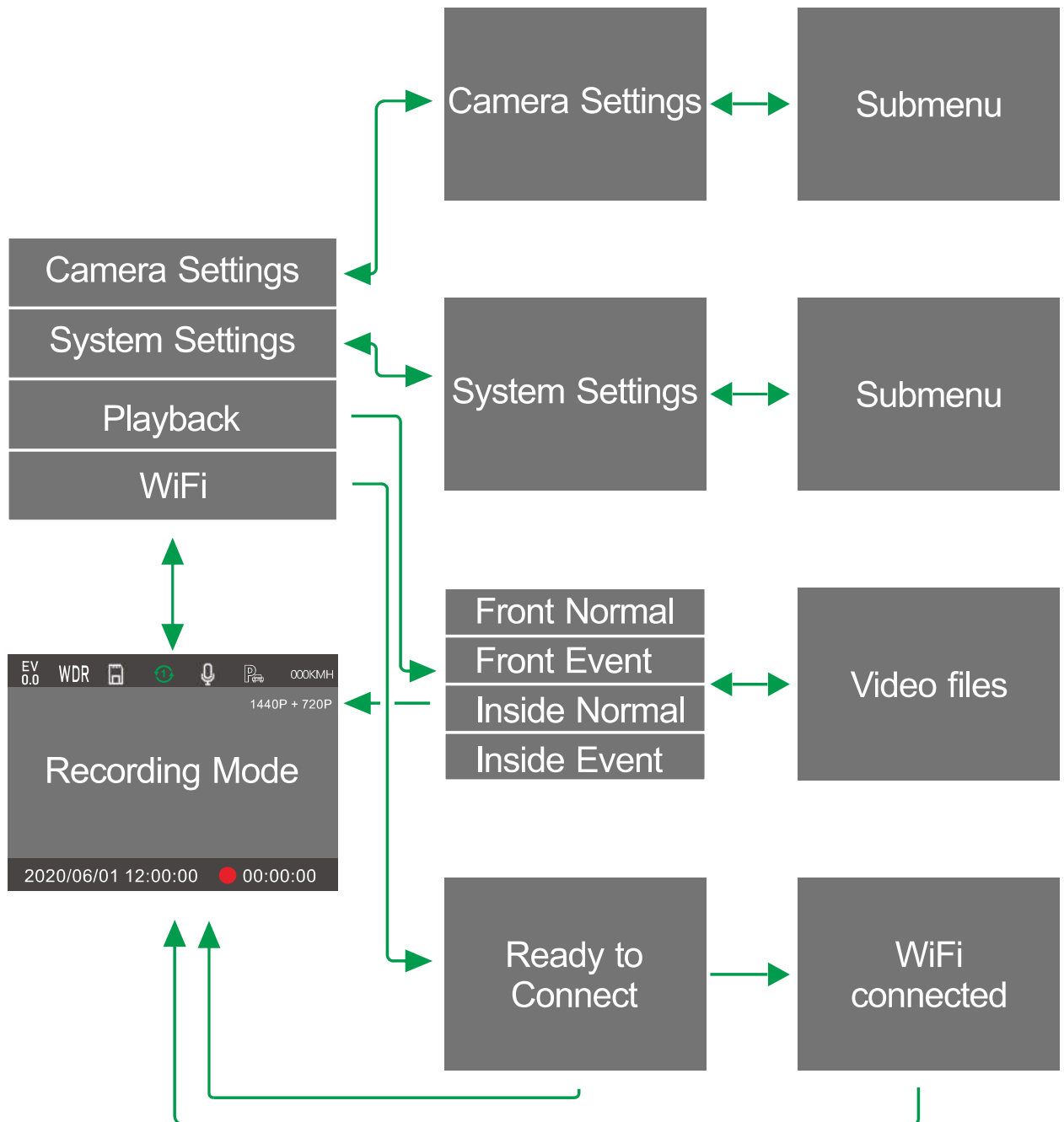

## Note:

**Time Zone:** Set Time Zone correct in "Main Menu→ Camera Settings → GPS" is required for the first use.

**Frequency:** Generally speaking, 220Vac=50Hz; 110Vac=60Hz.

### Infrared LED:

AUTO: The camera automatically turns on/off infrared LED based on

- sensing the changes of luminance through the front lens.

The brightness of 6PCS LED lights is 2-level adjustable automatically according to the ambient brightness.

**Loop Recording:** Loop Recording "Off" poses risk of no recordings after the card storage is full.

**Auto LCD Off:** If screen off by setting "1min off or 3min off or GPS Screen", short press any key to screen on.

**Format:** The data in memory card will be unrecoverable after formatting.

### Playback:

- When the video file is being played, short press RIGHT key to "Delete" or "Lock"/"Unlock" current video clip.
- After the video file is manually locked, it will be automatically transferred to the folder of "Event"; After the video file is manually unlocked, it will be automatically transferred to the folder of "Normal".

**GPS:** Signal reception interference from the camera has been eliminated to the minimum through a series of optimization, GPS positioning is normally fast, however, positioning speed is also affected by other factors such as: metallic tinting on the windshield, high-rise buildings on both sides of the road etc.

## 6. Parking monitor

1. To realize parking monitor, uninterrupted power is required:

Methods	Pros	Cons	Context of use
Official Coxpal Hardwire Kit installed.	<ol style="list-style-type: none"> <li>1. Neat installation and doesn't occupy cigar lighter;</li> <li>2. "Low voltage protection" to avoid car battery from draining.</li> </ol>	<ol style="list-style-type: none"> <li>1. A little extra cost;</li> <li>2. It can't 100% protect car battery from draining especially for old car batteries.</li> </ol>	Regular use
Active cigar lighter (When car engine is off, the cigar lighter still has power supply.)	<ol style="list-style-type: none"> <li>1. Quick and direct.</li> <li>2. Cost-saving.</li> </ol>	<ol style="list-style-type: none"> <li>1. No "low voltage protection", potentially drain car battery.</li> <li>2. Only a few cars equipped with active cigar lighter.</li> </ol>	Short time use
External power bank	Quick and direct.	Poses fire risk.	Urgent or temporary use

## 2. How does parking monitor work?

### Parking Monitor "OFF":

- If hardwire is installed: Camera is still recording.
- If hardwire is not installed: Camera powers off when vehicle engine is off (For a few vehicles which is equipped with active cigarette lighter, please set either "Time lapse 1FPS" or "Low Resolution 720P" and Guard Time 15 minutes, the camera can be off after 30 minutes when the vehicle is parked).

### Parking Monitor "Time Lapse" or "Low Resolution" + Guard Time "X", when vehicle is stationary (zero G-force):

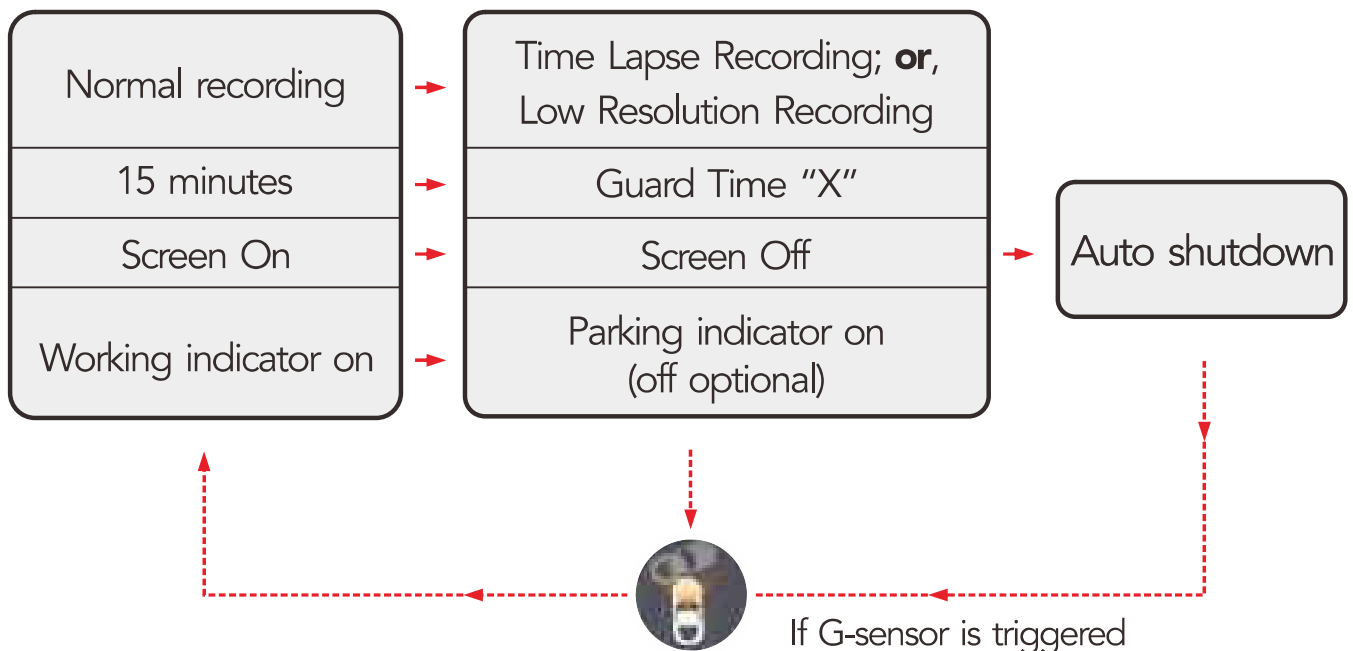

### Note:

Please selectively choose "Inside Camera On" due to excessive power consumption from 6pcs infrared LED lights.



## 7. Watch recordings via PC & TV

1. Two options to watch the recordings:
  - By directly connecting the camera with an USB data cable.  
**Note:** Inferior data cable affects transfer speed.
  - By directly reading the microSD card with a card reader.
2. If watch via Mac or Windows computer, proprietary COXPAL media player is available:
  - It supports play 2-channels simultaneously;
  - It supports play GPS speed & trajectory;
  - The player can be downloaded from [www.coxpal.com](http://www.coxpal.com).

## 8. Reset

Use a needle to press the reset hole and hold for several seconds and then the camera will start to reset automatically.

## 9. Firmware Upgrading.

1. In System Settings, you can find current firmware version No.
2. How to upgrade the firmware:
  - 1). Copy the firmware ( .bin file ) into the root directory of the microSD card (FAT32 format is required);
  - 2). Insert the microSD card into the camera;
  - 3). Power on the camera, the camera will boot up automatically after upgrading successfully.

**Note:** DO NOT cut off power during the upgrading which may cause camera failure.

3. Always stay up-to-date

The latest firmware version is always available at the official website ( [www.coxpal.com](http://www.coxpal.com) ). We strongly recommend registering your product ( [www.coxpal.com](http://www.coxpal.com) ) to receive notification messages when new firmware update available.



1. Compatible with: Smart phone running android 4.0 or higher & iOS7.0 or higher.
2. User Privacy: We take user privacy very seriously and our APP DOES NOT collect any kind of personal data but only basic permissions required, please rest assured to use it.
3. The camera keeps working without connecting the APP, no bother to get APP connected for most of the time but just let the camera work alone.
4. Get the APP connected when APP-Operating is more user-friendly, for example:
  - Set new parameters of the camera in car seat, elegantly;
  - Save one or more video clips to the phone, directly and immediately.

## **1. Before connecting:**

1. Download official "Coxpal" APP from either Google Play Store or Apple App Store, install it into your phone directly.
2. Enable camera WiFi:
  - By Main Menu → WiFi
  - By shortcut key: Long press LEFT button

## **2. Connecting:**

1. Launch Coxpal APP → Click "Connect the camera" button → WLAN networks → Find Coxpal and input password "doourbest" → Back to Coxpal APP → The button shows "Enter".
2. or: Your phone → Settings → WLAN networks → Find Coxpal and input password "doourbest" → Launch Coxpal APP → The button Shows "Enter".

### 3. Use the APP.

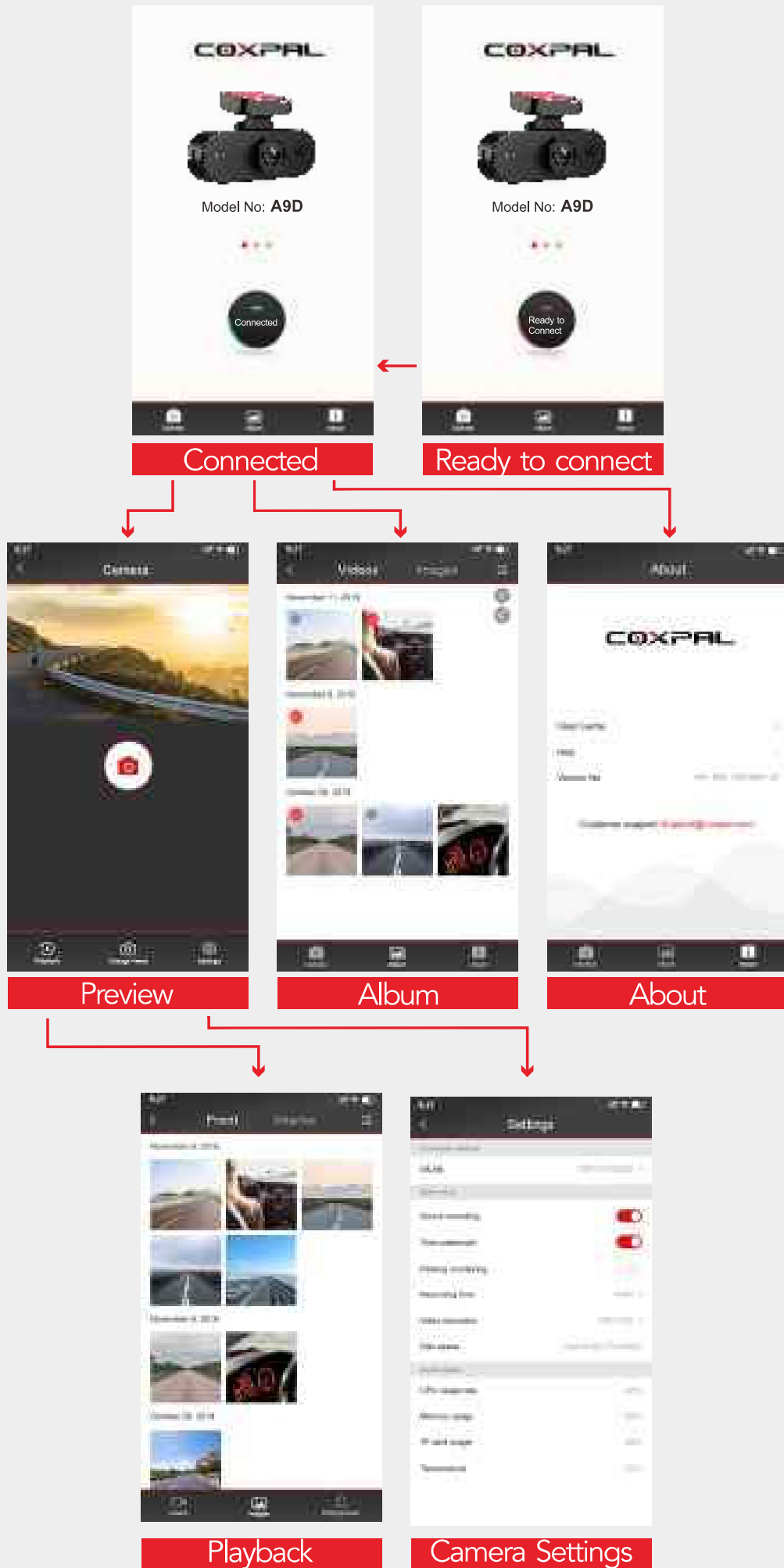

**Note:**

1. To stream preview video smoothly, the image in Preview Mode is not based on the original resolution but compressed.
2. To play video files in APP's Album with GPS information, disconnect with the camera and connect with internet is required.

**4. Troubleshoot connection problems:**

1. If "Coxpal camera" can be found in phone's WLAN networks:
  - iPhone: Enable Airplane Mode in phone settings;
  - Android phone: Disable Mobile Data in phone settings; Or, Disable "Intelligent Network Connection" if this option available in phone settings (Some phones can intelligently switch to mobile data if current WiFi network is not internet capable).
2. If "Coxpal camera" can NOT be found in phone's WLAN networks:
  - Check if the camera is powered on;
  - Or, Check if the camera WiFi is enabled;
  - Or, Check if the camera is near the phone;
  - Or, Reset the camera.
3. There is also a possibility that the APP can't be connected temporarily due to phone's new OS, in this case, please don't worry, we will update our APP quickly to adapt to the new OS.



# Specifications

The specifications of this product hereunder may change without prior notice due to product improvements.

Model No	COXPAL A9D
Main Processor	Novatek96663
Front Image Sensor	Sony IMX335 5-mega pixel CMOS
Inside Image Sensor	Sony IMX307 2-mega pixel CMOS
Front Lens	F1.6; 140° FOV; 7-glasses; 1 infrared filter
Inside Lens	F1.8; 140° FOV; 6-glasses, 6pcs infrared LED
Display Screen	1.5" TFT LCD(4:3)
G-sensor	Built-in; 3-axis; sensitivity 3-level adjustable
GPS	Built-in
WiFi	2.4G
System Language	English/Español/Deutsch/Русский/简体中文/日本語
Video	.MP4 format 2560*1440P 30FPS Front 1920*1080P 60FPS Front 1920*1080P 30FPS Dual
Audio	Built-in microphone & speaker
RAM	2GB
Storage	By external SDHC microSD; Up to 256GB; Class 10(UHS-1) or above; in FAT32
Battery	No, but built-in 85°C 5.5V 2*7F supercapacitor
Power Input	5Vdc/1.5A
Power Interface	USB Type-C
Power Consumption	4W-5.5W
Working Temperature	-4° to 158°F (-20° to 70°C)
Storage Temperature	-4° to 176°F (-20° to 80°C)

# 9 FAQs

## 1. Q: Why "SD card error"?

A: Most probably the card is defective, or fake, you could search and install a tool named "H2TESTW" to test it.

## 2. Q: Why my SD card doesn't work with this camera but it works with other cameras?

A: Different cameras or different applications requires different writing speed, the better image quality recorded, the faster writing speed required.

## 3. Q: Why my Mac computer can't format SD card to FAT32 or can't read FAT32?

A: FAT32 is an universal format that is compatible with Mac, Windows, Linux and DOS, you could search "Format SD card to FAT32 with a Mac" or "convert Mac hard drive to FAT32 by using Disk Utilities" to learn how to do it.

## 4. Q: Why can't make out license plate?

A: See license plate clearly or not depends on various factors such as resolution, weather, distance, speed and so on, by and large, almost all dash cameras adopts non-zoom lens with fixed focal distance, therefore, the farther away the target vehicle and the wider viewing angle of the camera, the less pixels averaged to the target vehicle's license plate.

## 5. Q: The wider viewing angle of the camera. the better?

A: Yes and No, Yes because it has wider coverage; No because the bigger image distortion due to the fisheye lens, and also the less pixels averaged to each details.

6. Q: Why the camera falls off from the windscreen?

A: Clean the surface of the windscreen and initially tight fixation is very important, then the camera never fall off, In addition, the viscous force of the adhesive tape is significantly down for the second use, hence, replace the adhesive tape if the camera falls off from the windscreen.

7. Q: Which one is better? Suction cup mount or adhesive mount?

A: Each has its pros and cons, but judged from the perspective of getting better image, adhesive mount is undoubtedly the better choice because it can minimize the unnecessary shaking.

8. Q: Why supercapacitor but not Li battery?

A: The function of supercapacitor is, to supply power to save the last video clip when camera's external power is cut off, Its advantages compared with Li battery are, no risk of fire and explosion, working temperature range wider.

9. Q: Do we need to worry the safety of the camera especially when it gets hot?

A: No need to worry at all, unlike the camera with built-in Li battery, the camera is absolutely safe and no risk of fire and explosion because of its built-in supercapacitor, furthermore, product is backed by 1 year warranty, please rest assured to use it.

10. Q: Why infrared LED light of this camera invisible but infrared LED light of security camera visible?

A: Because of the longer wavelengths than those of visible light, infrared light is invisible to the human eye, the infrared LED applied in security cameras is artificially set with visible light, its purpose is warning, to deliberately let others know it is recording.

# 10 Warranty & Support

**Warranty:** Full 12-month since the date of purchase.

**Support:** [support@coxpal.com](mailto:support@coxpal.com)

Recommended Mail Subject Format for quickly handling your case:  
Model No + Purchase Channel + Order ID

For example:

Subject

## Your opinion matters!

Coxpal is firmly committed to continually improving our products, services, and user experience. If you have any thoughts on how we can do even better, we always welcome your constructive feedback and suggestions.





This product complies with the radio interference requirements of the European Community. Operating Frequency Range: 2400-2483.5 MHz; Max Output Power: 15 dBm



This product is designed and manufactured with high quality materials and components, which can be recycled and reused.



This symbol means the product must not be discarded as household waste, and should be delivered to an appropriate collection facility for recycling. Follow local rules and never dispose of the product and rechargeable batteries with normal household waste.

## FCC Statement

This device complies with Part 15 of the FCC Rules. Operation is subject to the following two conditions: (1) This device may not cause harmful interference, and (2) This device must accept any interference received, including interference that may cause undesired operation.

**Warning:** Changes or modifications not expressly approved by the party responsible for compliance could void the user's authority to operate the equipment.

Note: This equipment has been tested and found to comply with the limits for a Class B digital device, pursuant to Part 15 of the FCC Rules. These limits are designed to provide reasonable protection against harmful interference in a residential installation.

This equipment generates, uses and can radiate radio frequency energy and, if not installed and used in accordance with the instructions, may cause harmful interference to radio communications. However, there is no guarantee that interference will not occur in a particular installation. If this equipment does cause harmful interference to radio or television reception, which can be determined by turning the equipment off and on, the user is encouraged to try to correct the interference by one or more of the following measures:

- (1) Reorient or relocate the receiving antenna.
- (2) Increase the separation between the equipment and receiver.

(3) Connect the equipment into an outlet on a circuit different from that to which the receiver is connected.

(4) Consult the dealer or an experienced radio / TV technician for help.

This device is acting as slave and operating in the 2.4 GHz (2412-2462 MHz).

### **FCC Radio Frequency Exposure Statement**

The equipment complies with FCC Radiation exposure limits set forth for uncontrolled environment. This equipment should be installed and operated with minimum distance 20cm between the radiator and your body.

Apple and the Apple logo are trademarks of Apple Inc., registered in the U.S. and other countries. App Store is a service mark of Apple Inc., registered in the U.S. and other countries.

Google Play and the Google Play logo are trademarks of Google Inc.

'Android" is a registered trademark of Google Inc. in the United States and other countries.

"iOS" is a registered trademark of Apple Inc. in the United States and other countries.

**COXPAL**

[www.coxpal.com](http://www.coxpal.com)

Made in China