

PCB Antenna for BLE Chips of WCH

1、 Dimension of Antenna

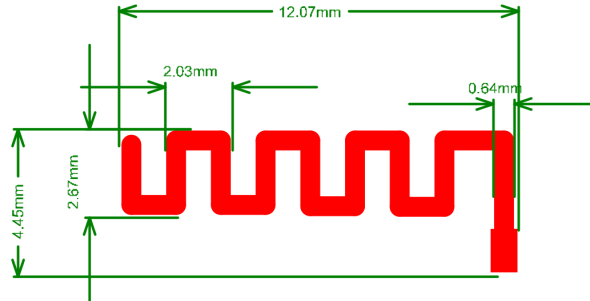

2、 Features

- Dimension: 4.45 * 12.07mm
- Terminal impedance: 50 ohm
- Max Gain: 2.1dBi
- RF Frequency: 2.4GHz

3、 S parameter

Working bandwidth: 157MHz

S11: -43.5dB@2.44GHz

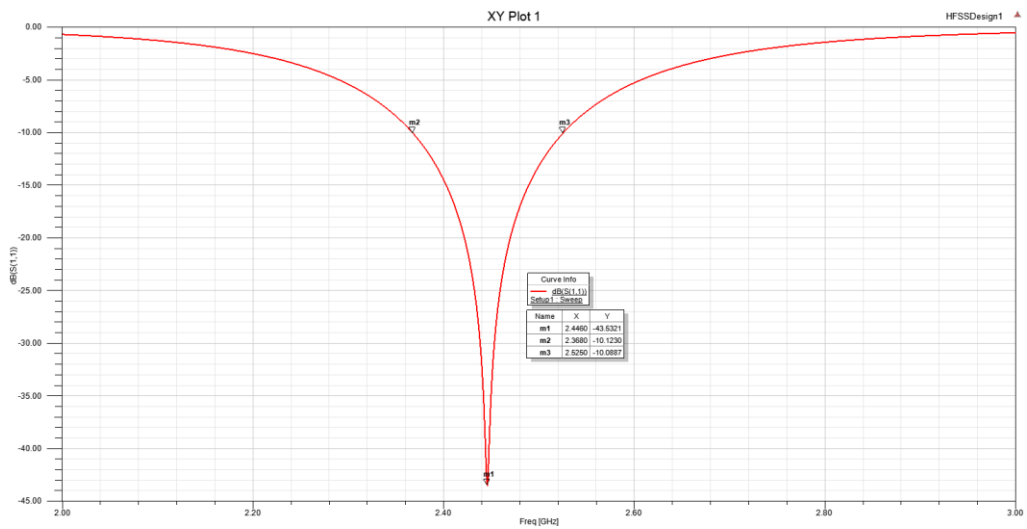

4、 Gain and Radiation pattern

Max gain @2.4GHz: 2.08dBi

E plane:

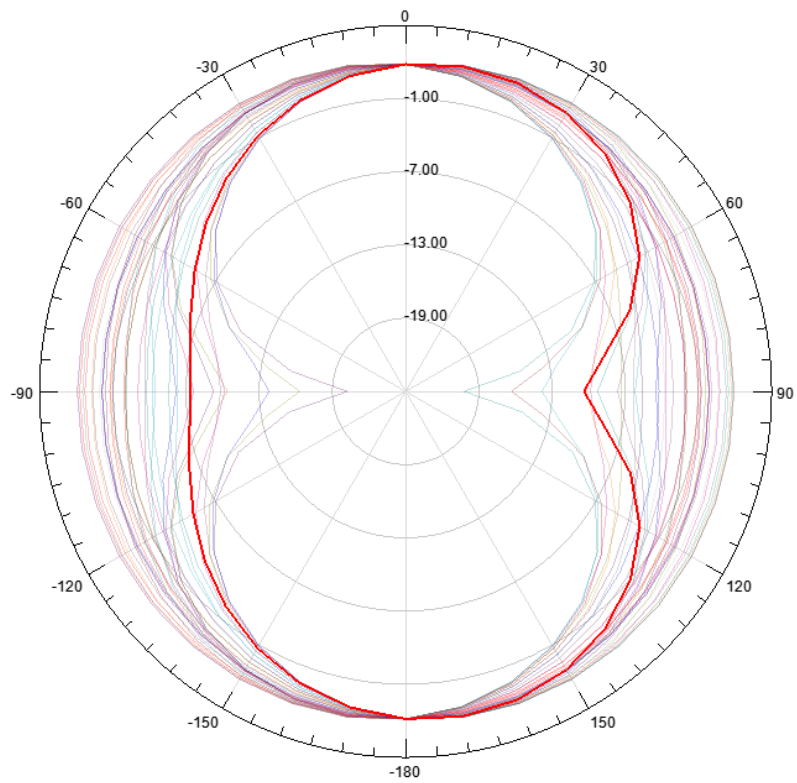

H plane:

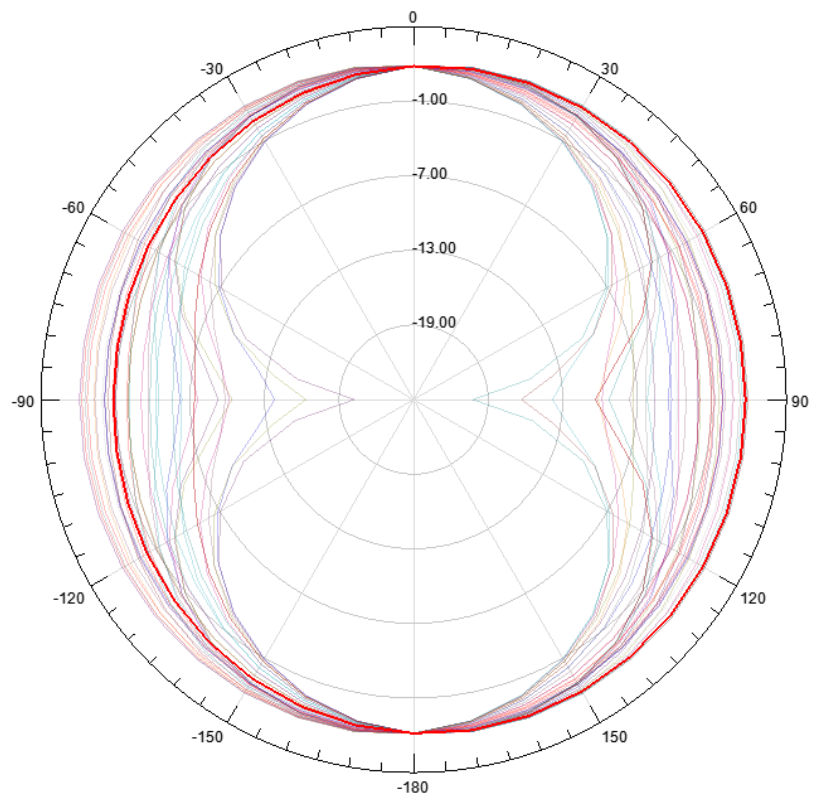

Max Gain @2.44GHz: 2.1dBi

E plane:

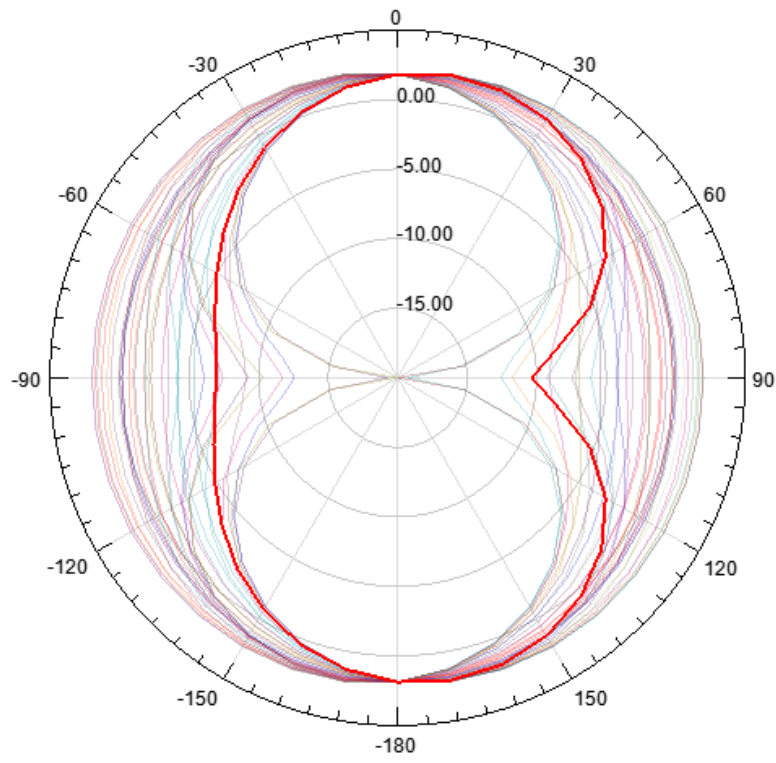

H plane:

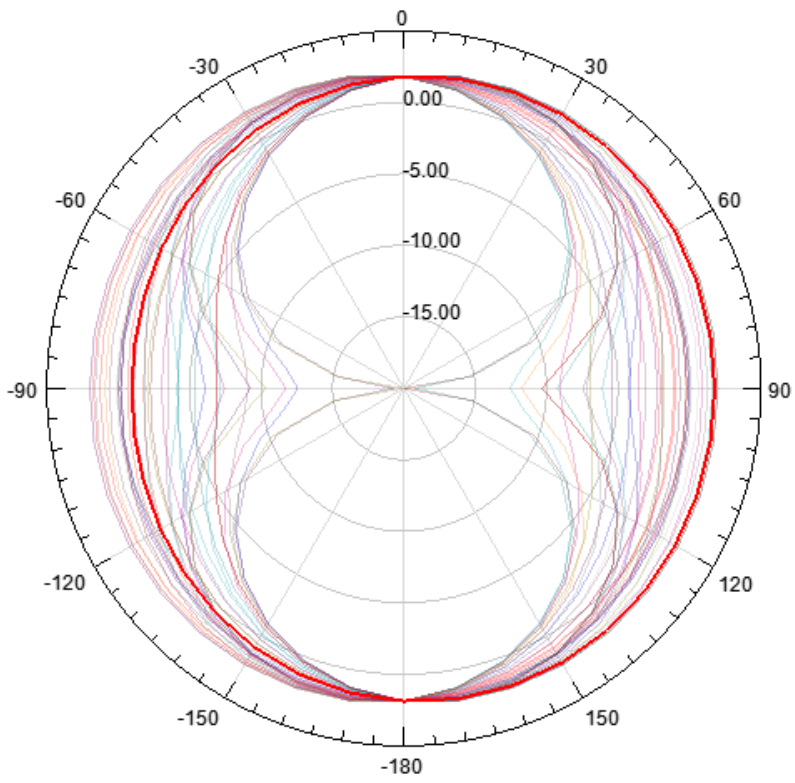

Max Gain @2.48GHz: 2.04dBi

E plane:

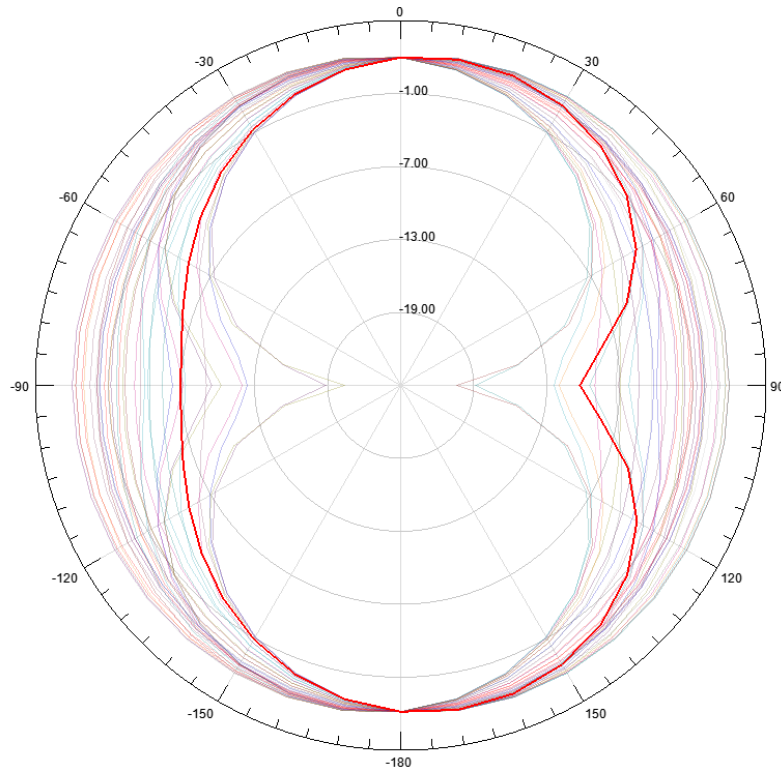

H plane:

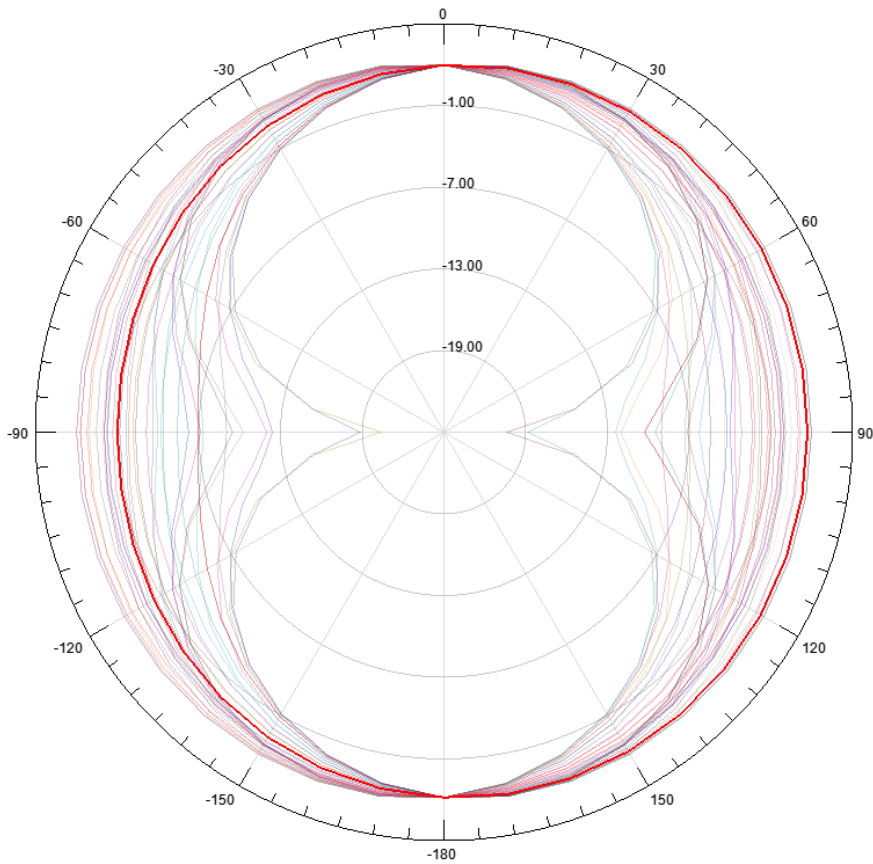

Applicant: Suzhou BeeLinker Technology Co., LTD

Address: Room 104 , National University Science Park, Southeast University, 399 Linquan Street, Suzhou Industrial Park