

Copyright Information

Copyright © 2021 by Icarsoft Technology Inc. (also called iCarsoft for short). All rights reserved. No part of this publication may be reproduced, stored in a retrieval system, or transmitted in any form or by any means, electronic, mechanical, photocopying and recording or otherwise, without the prior written permission.

Statement: iCarsoft owns the complete intellectual property rights for the software used by this product. For any reverse engineering or cracking actions against the software, iCarsoft will block the use of this product and reserve the right to pursue its legal liabilities.

Disclaimer of Warranties and Limitation of Liabilities

All information, illustrations, and specifications in this manual are based on the latest information available at the time of publication.

The right is reserved to make changes at any time without notice. We shall not be liable for any direct, special, incidental, indirect damages or any economic consequential damages (including the loss of profits) due to the use of the document.

Important Safety Precautions

To avoid personal injury, property damage, or accidental damage to the product, read all of the information in this section before using the tool.

DANGER

- When an engine is operating, keep the service area well-ventilated or attach a building exhaust removal system to the engine exhaust system. Engines produce various poisonous compounds (hydrocarbon, carbon monoxide, nitrogen oxides, etc.) that cause slower reaction time and result in death or serious personal injury.
- Please use the included battery and power adaptor. Risk of explosion if the battery is replaced with an incorrect type.
- DO NOT attempt to operate the tool while driving the vehicle. Have a second person to operate the tool. Any distraction may cause an accident.

WARNING

- Always perform automotive testing in a safe environment.
- Do not connect or disconnect any test equipment while the engine is running.
- Before starting the engine, put the gear lever in the Neutral position (for manual transmission) or in the Park (for automatic transmission) position to avoid injury.
- NEVER smoke or allow a spark or flame in vicinity of battery or engine. Do not operate the tool in explosive atmospheres, such as in the presence of flammable liquids, gases, or heavy dust.
- Keep a fire extinguisher suitable for gasoline/chemical/electrical fires nearby.

- Wear an ANSI-approved eye shield when testing or repairing vehicles.
- Put blocks in front of the drive wheels and never leave the vehicle unattended while testing.
- Use extreme caution when working around the ignition coil, distributor cap, ignition wires and spark plugs. These components create hazardous voltage when the engine is running.
- To avoid damaging the tool or generating false data, please make sure the vehicle battery is fully charged and the connection to the vehicle DLC (Data Link Connector) is clear and secure.
- Automotive batteries contain sulfuric acid that is harmful to the skin. In operation, direct contact with the automotive batteries should be avoided. Keep the ignition sources away from the battery at all times.
- Keep the tool dry, clean, free from oil, water or grease. Use a mild detergent on a clean cloth to clear the outside of the equipment when necessary.
- Keep clothing, hair, hands, tools, test equipment, etc. away from all moving or hot engine parts.
- Store the tool and accessories in a locked area out of the reach of children.
- Do not use the tool while standing in water.
- Do not expose the tool or power adapter to rain or wet conditions. Water entering the tool or power adaptor increases the risk of electric shock.
- This tool is a sealed unit. There are no end-user serviceable parts inside. All internal repairs must be done by an authorized repair facility or qualified technician. If there is any inquiry, please contact the dealer.
- Keep the tool far away from magnetic devices because its radiations can damage the screen and erase the data stored on the tool.
- Do not attempt to replace the internal rechargeable lithium battery. Contact the dealer for factory replacement.
- Do not disconnect the battery or any wiring cables in the vehicle when the ignition switch is on, as this could avoid damage to the sensors or the ECU.
- Do not place any magnetic objects near the ECU. Disconnect the power supply to the ECU before performing any welding operations on the vehicle.
- Use extreme caution when performing any operations near the ECU or sensors. Ground yourself when you disassemble PROM, otherwise ECU and sensors can be damaged by static electricity.
- When reconnecting the ECU harness connector, be sure it is attached firmly, otherwise electronic elements, such as ICs inside the ECU, can be damaged.

Table of Contents

1 Packing List	1
2 Overview	2
2.1 Introduction.....	2
2.2 Display Tablet.....	3
2.3 VCI Dongle.....	4
2.4 IM2000 PRO.....	5
3 Initial Use	6
3.1 Charging.....	6
3.2 Power On & Off.....	6
3.3 Basic Operations.....	6
3.4 Change System Language.....	6
3.5 Network Setup.....	7
3.6 Set Standby Time.....	7
3.7 Register & Download Diagnostic Software.....	7
4 Getting Started	8
4.1 Job Menu.....	8
4.2 Connection.....	8
4.3 Communication Setup.....	9
5 Immobilizer Operations	10
5.1 Anti-theft matching.....	10
5.2 IMMO Programming.....	14
6 Diagnose	27
6.1 VIN SCAN.....	27
6.2 Manual Selection.....	28
7 Maintenance	32
8 Feedback	36
9 Update	36
10 Report Printing	37
11 Personal Center	39

1 Packing List

The following accessory items are only for reference. Please consult from the local agency or check the package list supplied with this tool together.

No.	Item	Descriptions	Qt.
1	CR IMMO	Main Unit	1
2	VCI	VCI dongle	1
3	IM2000 PRO	Immobilizer Programmer	1
4	OBD II extension cable	Connects the VCI dongle to the OBD II vehicle's DLC.	1
5	USB cable	Type C to Type C, for charging.	1
6	Power adaptor	For charging the tablet.	1
7	USB cable (Mini B)	Type A to Mini B, for communication between tablet and VCI	1
8	Non-16pin adaptor cable kit	Connect to the vehicle equipped with non-OBD II management system.	1
9	Cigarette lighter cable	Supply power to the non-16pin connector from the vehicle's cigarette lighter receptacle.	1
10	OBD I adaptor box	Connect the diagnostic cable and non-16pin adaptor cable.	1
11	Diagnostic main cable	Connects the VCI dongle, IM2000 PRO and the vehicle's DLC	1
12	Chip Adapter	Place the EEPROM chip onto the socket, and then plug it into the programmer socket.	1
13	MCU_V1 PCBA	Connect the programmer with MCU(chip soldering is required in this procedure).	1
14	MCU_V2 PCBA	Connect the programmer with MCU(chip soldering is required in this procedure).	1
15	EEPROM PCBA	Solder the desired chip on the EEPROM converter, and then plug the board into the programmer(chip soldering is required)	1
16	MB-Key	Connect the programmer with the key lock, insert the key into the programmer for further key operations.	1

17	INS Cable V1	Connect the programmer and vehicle dashboard, and then place the probe (the yellow lead) to the designated area.	1
18	INS Cable V2	After removing the vehicle dashboard, connect programmer, vehicle dashboard, and the cable.	1
19	MCU Cable V1	To connect the programmer and MCU.	1
20	Bench Mode Cable	Connect the programmer and the engine to read engine or gearbox ECU (Connect engine ECU with the BENCH mode cable based on BENCH mode diagram).	1
21	Matching Adapter A	To connect the BENCH mode cable and gearbox ECU/engine.	5
22	Matching Adapter B	To connect the BENCH mode cable and gearbox ECU/engine.	6
23	Matching Adapter C	To connect the BENCH mode cable and gearbox ECU/engine.	7
24	Matching Adapter D	To connect the BENCH mode cable and gearbox ECU/engine.	8
25	Matching Adapter E	To connect the BENCH mode cable and gearbox ECU/engine.	6
26	Switching Power Supply	Supply power to the programmer.	1
27	Password envelope	A piece of paper bearing Product S/N and Activation Code, which is required for your registration.	1
28	User Manual		1

2 Overview

2.1 Introduction

CR IMMO, developed by Icarsoft Technology Inc. is specially designed as a comprehensive immobilizer programmer. It can work with the VCI (Vehicle Communication Interface) dongle to perform full car models and full systems diagnosis (including reading/clearing the diagnostic trouble codes and reading data stream etc.). Additionally, it also can work with the IM2000 PRO to perform anti-theft matching and anti-theft programming operations.

2.2 Display Tablet

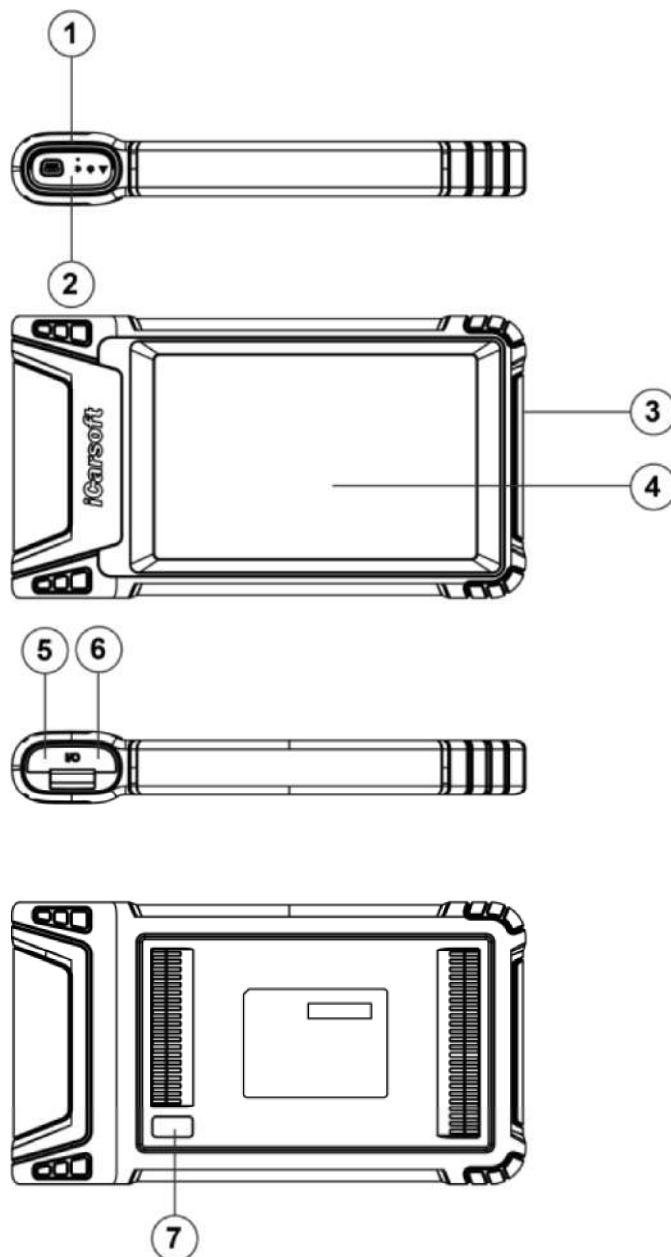

1. Docking slot for VCI dongle - for housing the VCI dongle.
2. VCI dongle - It is pre-installed in the docking slot on the top of the display tablet. Use the hand to press the dongle once, it will be automatically ejected from the docking slot. When it is not in use, please reinsert it into the slot to avoid loss.
3. Power key - Press it to turn the tool on/off.
4. LCD Screen – Indicates the test results.
5. USB Type C port - Connect a charger for charging or data transmission.
6. USB Type A port - Connect the tablet to the VCI dongle via data cable.
7. Rear camera.

Technical Parameters

- CPU: 4-Core 1.8GHz
- Memory: 4GB
- ROM: 64GB
- Screen Size: 8 inches
- Resolution: 1280*800 pixel
- Camera: 8MP rear-facing camera
- Working Voltage: 5V
- Working Current: $\leq 3A$
- Working Environment: 0°C ~45°C
- Storage Environment: -10°C ~60°C

2.3 VCI Dongle

This dongle works as a VCI (Vehicle Communication Interface) device. It is used to obtain the vehicle data, and then send it to the tablet for analysis via Bluetooth.

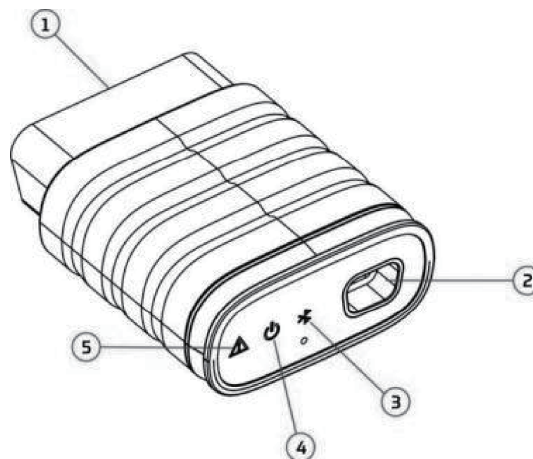

1. OBD-16 diagnostic connector - Connects the OBD-II extension cable or directly plug into the vehicle's DLC (Data Link Connector) port.
2. Data transmission port - Connects to the display tablet via data cable to perform vehicle diagnosis.
3. Communication LED - It lights up and keeps flashing when the VCI dongle is communicating with the tablet.
4. Power LED - It lights up when powered on.
5. Error LED - It lights up when communication failure occurs.

Technical Parameters

- Working Voltage: 12V
- Working Current: $\leq 60mA$
- Working Environment: 0°C ~50°C
- Storage Environment: -10°C ~60°C

2.4 IM2000 PRO

The IM2000 PRO works as a dedicated anti-theft immobilizer programmer. It needs to work with the display tablet to perform the IMMO Matching (for some vehicles) and IMMO Programming operations.

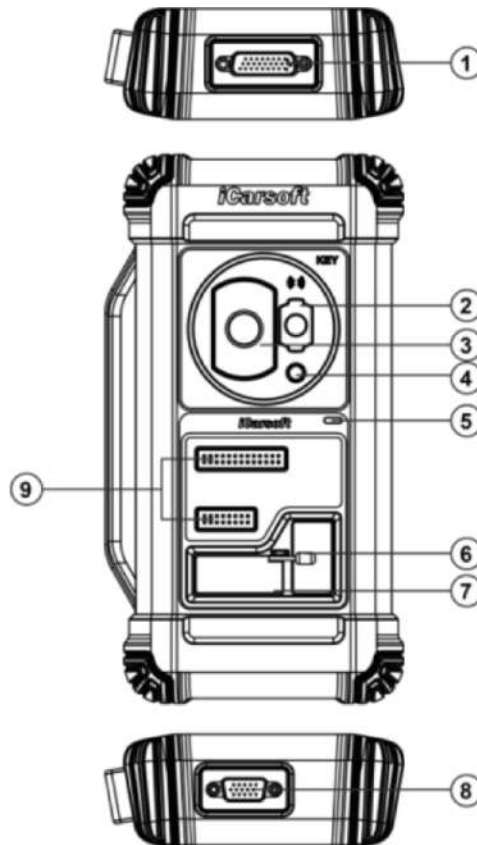

1. DB26 diagnostic connector - Connects with the Mercedes Benz infrared collector, ECU cable and MCU cable etc.
2. Mercedes Benz infrared key slot - Holds the Mercedes Benz key.
3. Vehicle key slot - Holds the car key for RF defection.
4. Transponder slot - Holds the transponder (key chip).
5. Power LED - Red light indicates faults. Orange light indicates functioning normally.
6. Valve - Tighten/Loosen the EEPROM board.
7. EEPROM transponder slot - Holds the EEPROM plug-in transponder or EEPROM socket.
8. DB15 diagnostic connector - Connects with main diagnostic cable.
9. Cross signal pins - Holds the MCU spare cable or vehicle DIY signal cable to read or write MCU and ECU chips.

Technical Parameters

- Input Voltage: 12 V
- Input Current: 500mA
- Working Environment: 0°C ~50°C
- Storage Environment: -20°C ~70°C

3 Initial Use

3.1 Charging

Follow the steps below to charge the tablet:

1. Connect one end of the charging cable to the USB socket of the power adapter.
2. Connect the other end to the charging port on the bottom of the host.
3. Plug the charger power plug into a power outlet to start charging.

⚠ Caution: Please use the included power adaptor to charge your tool. No responsibility can be assumed for any damage or loss caused as a result of using power adaptors other than the one supplied.

📝 Note: If the battery remains unused for a long time or the battery is completely discharged, it is normal that the tool will not power on while being charged. Please charge it for 5 minutes and then turn it on.

3.2 Power On & Off

Long press the POWER button and then the start interface will appear.

Long press the POWER button until the dialog box pops up, and tap **Shutdown** to turn it off or tap **Restart** to reboot it.

3.3 Basic Operations



Single-tap: To select an item or launch a program.



Double-tap: To zoom in so that the text on a webpage appears in a column that fits your device's screen.



Long press: Tap and hold on the desired vehicle software to delete it.



Slide: To jump to different pages.

Swipe from the right edge of the screen: Back to the previous screen or exits.

3.4 Change System Language

The tool supports multiple system languages. To change the language of the tool, please do the following:

1. In the Job Menu, tap **Settings -> System -> Language & input -> Languages**.
2. Tap **Add a language**, and then choose the desired language from the list.
3. Tap and hold the desired language and drag it to the top of the screen and then release it, the system will be changed into the target language.

3.5 Network Setup

The tablet has a built-in Wi-Fi communication module. Once you're online, you can register your tool, update diagnostic software & APK, browse the Internet and send email on your network.

1. In the Job Menu, tap **Settings -> Network & Internet -> Wi-Fi**.
2. Slide the Wi-Fi switch to ON, the tablet starts searching for available wireless LANs.
3. Select the desired WLAN network from the list. If the chosen network is open, you can connect directly. A password may be required for secured networks.

 Note: Once WLAN is set as ON, the tablet will consume more power. While it keeps unused, please set it off to save power. While WLAN is not in use, please turn it off to conserve battery power.

3.6 Set Standby Time

If no activities are made within the defined standby period, the screen will be locked automatically and the system enters sleep mode to save power.

1. In the Job Menu, tap **Settings -> Display -> Advanced -> Screen timeout**.
2. Choose the desired sleep time.

3.7 Register & Download Diagnostic Software

In the Job Menu, tap **Login** on the upper right corner of the screen. The following dialog box will pop up on the screen.

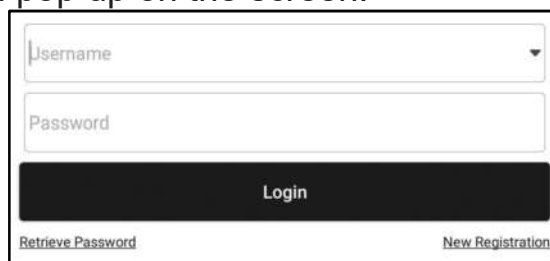

A login dialog box with two input fields: 'Username' and 'Password'. Below the fields is a black 'Login' button. At the bottom left is a link for 'Retrieve Password' and at the bottom right is a link for 'New Registration'.

- A. If you are a new user, tap **New Registration** and follow the on-screen instructions to finish the registration.
1. Create App account: Fill in the information in each field (Items with * must be filled). After inputting, tap **Register**.
 2. Activate VCI: Input the 12-digit Product Serial Number and 8-digit Activation Code (can be obtained from the password envelope), and then tap **Activate**.

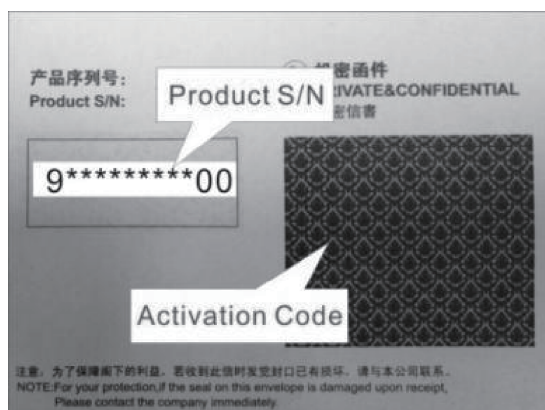

3. Download diagnostic software: Tap **OK** to enter the update center to download all available software.

B. If you have registered to be a member, input your name and password, and then tap **Login** to enter the main menu screen directly.

Note: The tablet has an auto-save function. Once the username and password are correctly entered, the system will automatically store them. Next time you login the system, you will not be asked to input the account manually.

C. If you forgot the password, tap **Retrieve password** and then follow on-screen instructions to set a new password.

4 Getting Started

4.1 Job Menu

It mainly includes the following items:

IMMO Matching	This function enables you to perform the anti-theft key matching function, so that the immobilizer control system on the car identifies and authorizes remote control keys to normally use the car.
IMMO Programming	<ul style="list-style-type: none"> • Read transponder data (including Mercedes Benz infrared smart key), and generate exclusive keys. • Read/write on-board EEPROM chip data, and read/write MCU/ECU chip data. • Read/write remote control transponder data and detect key frequency.
Diagnose	This module allows you to quickly achieve full car models and full systems vehicle trouble diagnosis.
Maintenance	Perform commonly used repair & maintenance services.
Update	Updates vehicle diagnostic software and APK.
Feedback	Feedback the diagnostic issues or bugs to us for analysis and troubleshooting.
Others	Includes the tablet settings, system OTA upgrade, TeamViewer Quick Support, Browser, File explorer, Camera, Gallery, Screen Recording and Email etc.

4.2 Connection

4.2.1 Preparation

Normal testing conditions

- Turn on the vehicle power supply.
- Vehicle battery voltage range should be 9-18V.
- Throttle should be closed at its close position.

- Find DLC location.
The DLC (Data Link Connector or Diagnostic Link Connector) is usually located 12 inches from the center of the instrument panel, under or around the driver's side for most vehicles. For some vehicles with special designs, the DLC location may vary.
If the DLC cannot be found, refer to the vehicle's service manual for the location.

4.2.2 Vehicle Connection

Follow the steps mentioned below to connect OBD II vehicle:

1. Locate the vehicle's DLC socket.
2. Plug the VCI dongle into the vehicle's DLC socket (It is suggested to use the OBD II extension cable to connect the VCI dongle and DLC socket).

For non-OBD II vehicle, please proceed as follows:

1. Select the corresponding adaptor/cable according to the vehicle's DLC type.
2. Plug the non-16pin end of the adaptor cable into the vehicle's DLC port, then connect the other end to the OBD I adaptor, and then tighten the captive screws.
3. Connect the other end of the OBD I adaptor to the diagnostic cable.



Note: If the pin of the DLC is damaged or the DLC has insufficient power, you can get power via the Cigarette Lighter Cable: Plug one end of the cable to the vehicle's cigarette lighter receptacle, and other end to the DC port of the OBD I adaptor.

4.3 Communication Setup

There are 2 ways available for the tablet to communicate with the VCI dongle: BT(wireless) communication and USB cable connection. User can choose either of the following ways to establish communication.

4.3.1 Pairing up via Wireless (BT) Communication

After the sign-up is successfully completed, the Bluetooth communication between the tablet and the VCI dongle is automatically established and user has no need to configure it again.

4.3.2 USB Cable Connection

1. Connect one end of the data cable (optional) to the Data transmission port of the VCI dongle.
2. Connect the other end to the USB expansion slot of the tablet. The power LED of the VCI dongle will light up.

 Note: The USB connection provides the most stable and fastest communication. When both the communication methods are applied at the same time, the tablet will use the USB communication as the default priority.

5 Immobilizer Operations

5.1 Anti-theft matching

This function enables you to perform the anti-theft key matching function, so that the immobilizer control system on the car identifies and authorizes remote control keys to normally use the car.

5.1.1 Vehicle connection

1. For most vehicles, just use the included OBD II extension cable to connect the VCI to the vehicle's DLC port.
2. For other vehicles (including but not limited to the Mercedes Benz, Volkswagen, BMW and Porsche), the IM2000 PRO and main diagnostic cable are required.

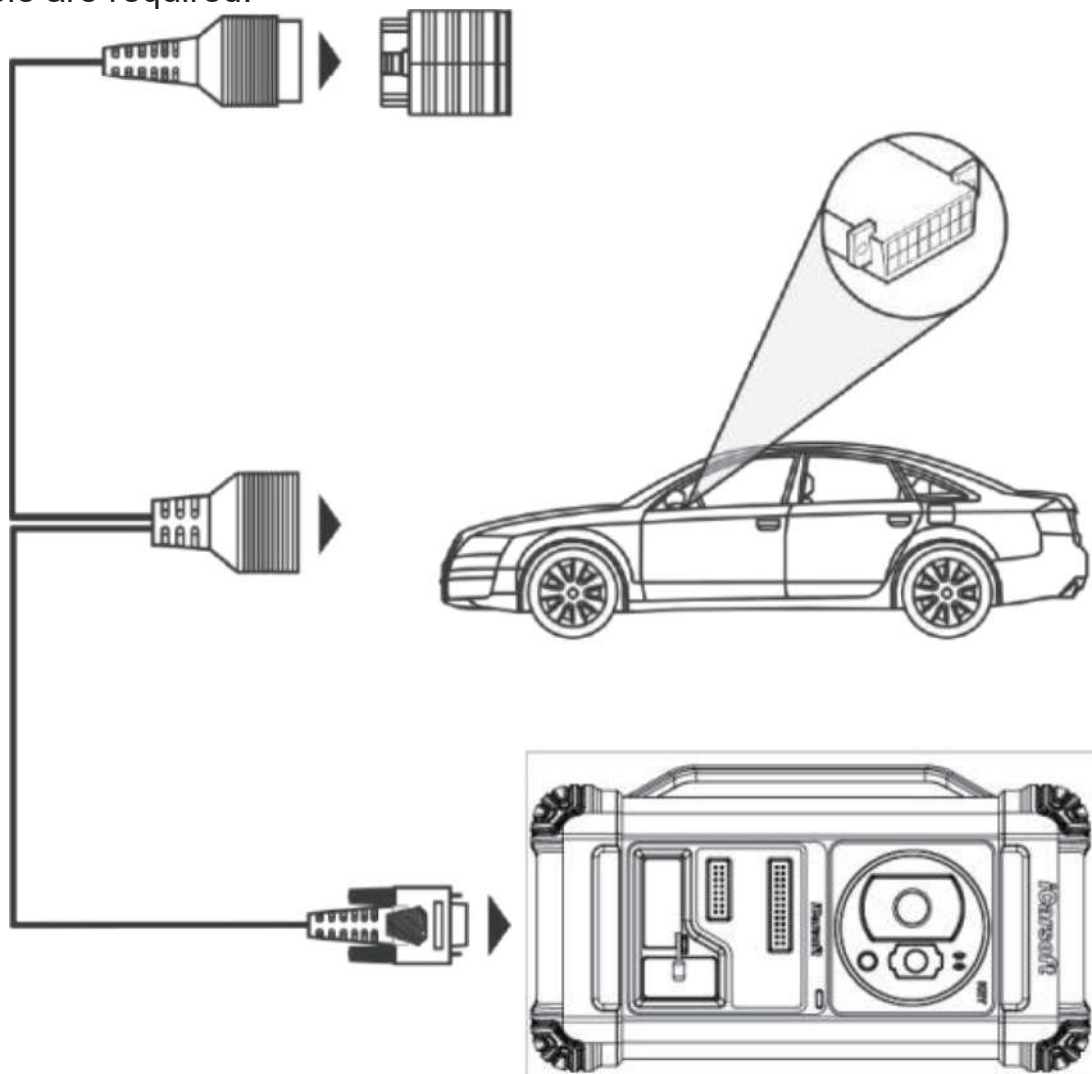

5.1.2 Immobilizer operations

Here we take the BMW for example to demonstrate how to perform the functions of key adding and all lost for BMW CAS4/CAS4 + anti-theft system module.

1. Tap **IMMO Matching** and select BMW to enter the software.

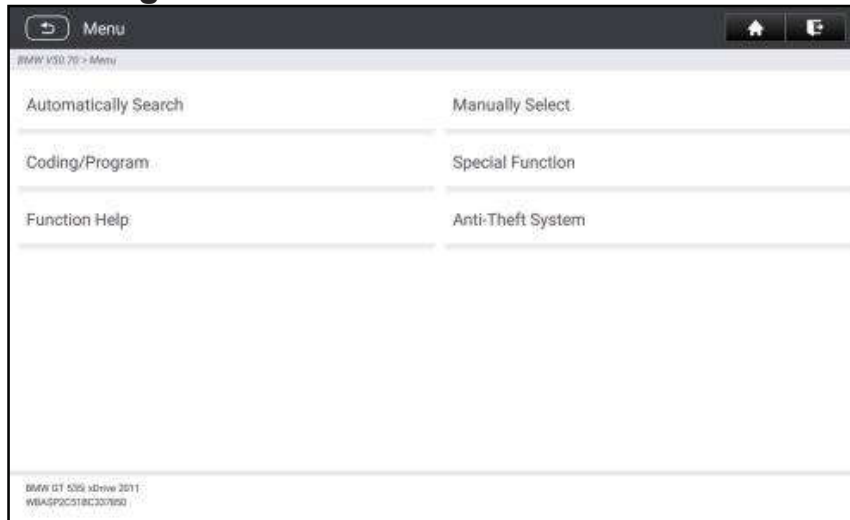

2. Tap **OK**.

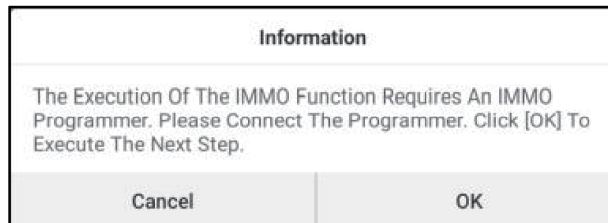

3. Enter the Anti-Theft System, follow the illustration below to connect the VCI dongle, vehicle and IM2000 PRO to perform the next step.

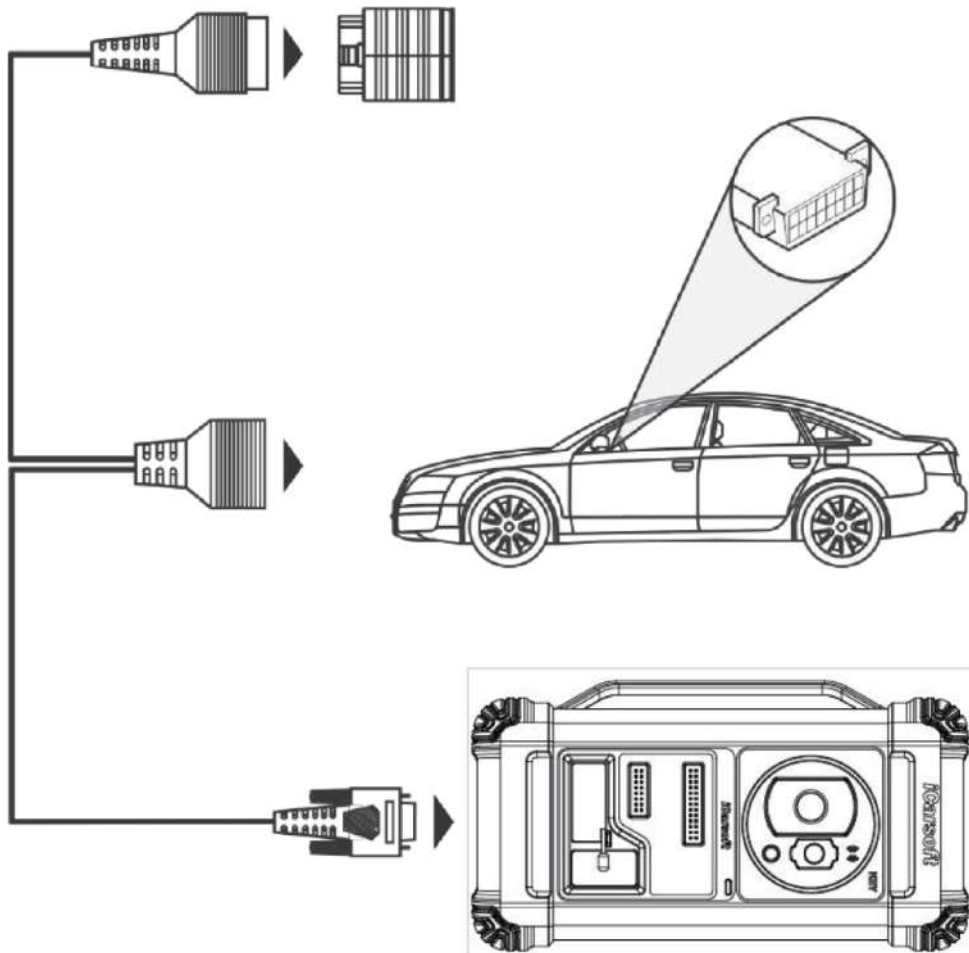

- 4. If you don't know the type of the anti-theft System, tap **Intelligent Mode** to enter.

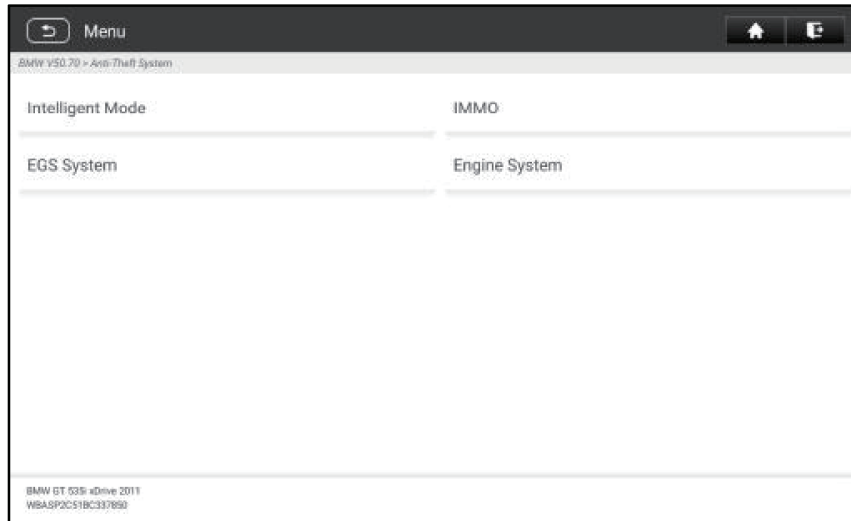

- 5. Tap **CAS4/CAS4+** anti-theft System, the following screen will appear:

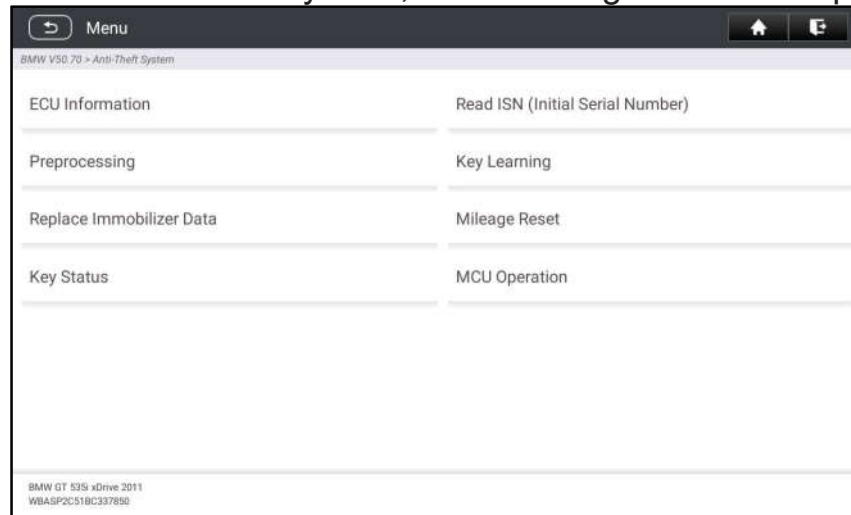

- 6. Tap **Preprocessing** to perform Read anti-theft data, Key matching and more. If it has already been preprocessed, here you can perform the relevant functions. The ECU will be upgraded in this process, and files need to be downloaded online.

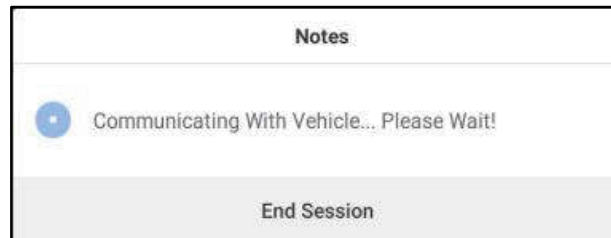

- 7. Make sure that the vehicle power supply voltage is not lower than 13V and stable, and then tap **Yes** to start preprocessing.
- 8. After preprocessing succeeded, tap **OK**.

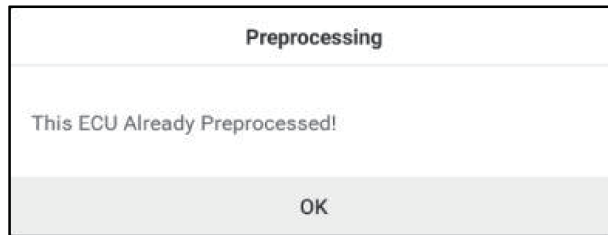

9. Return to the function menu and tap **Key Learning**.

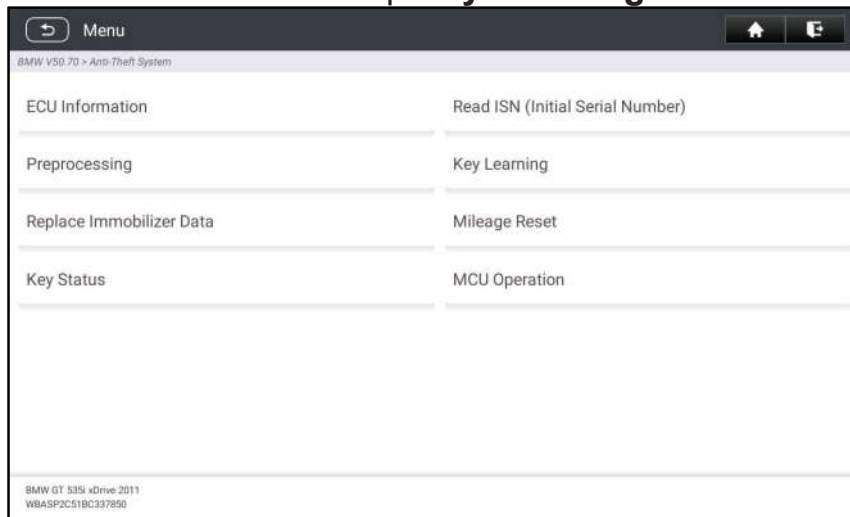

10. After the key information successfully read, select the unused key position and tap **Key Generated By Ignition Switch**.

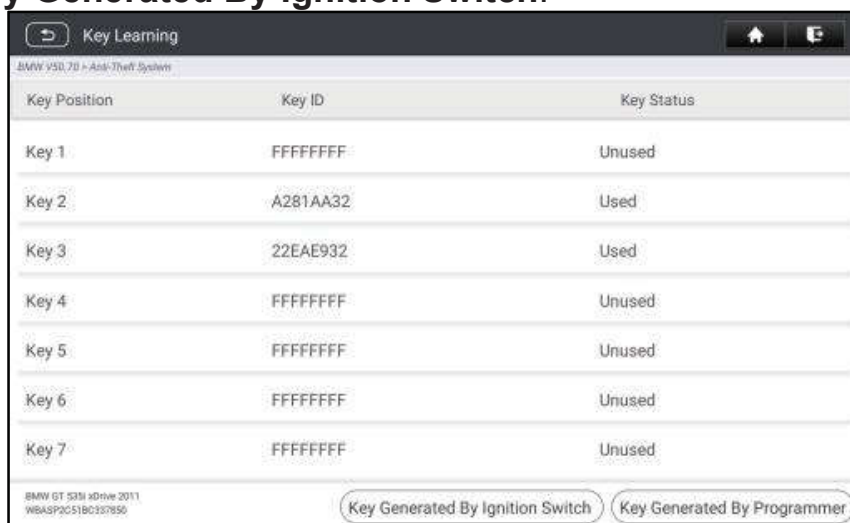

11. Read and display the password, and tap **OK**.

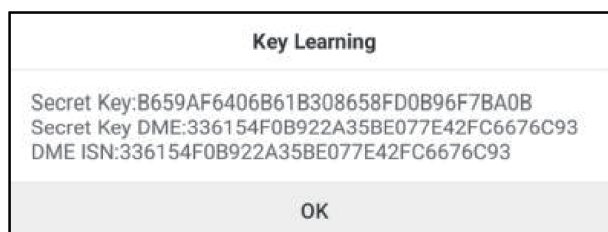

12. Place a new key close to vehicle coil, tap **OK**, and wait for the key to generate.

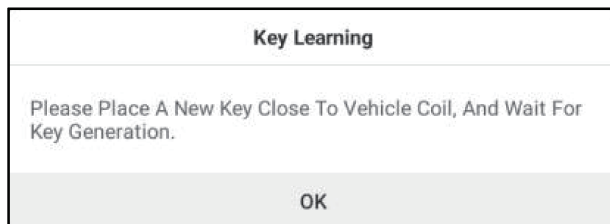

13. After the dealer key is successfully generated, please try to start the vehicle.

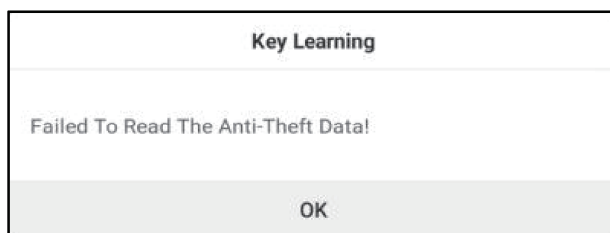

14. Now the key matching is finished and the new key is ready for use.

5.2 IMMO Programming

The IM2000 PRO is required when performing this operation. It has the following functions:

- Read transponder data (including Mercedes Benz infrared smart key), and generate exclusive keys.
- Read/write on-board EEPROM chip data, and read/write MCU/ECU chip data.
- Read/write remote control transponder data and detect key frequency.

1. Before performing this function, please make sure the following connections are properly made.

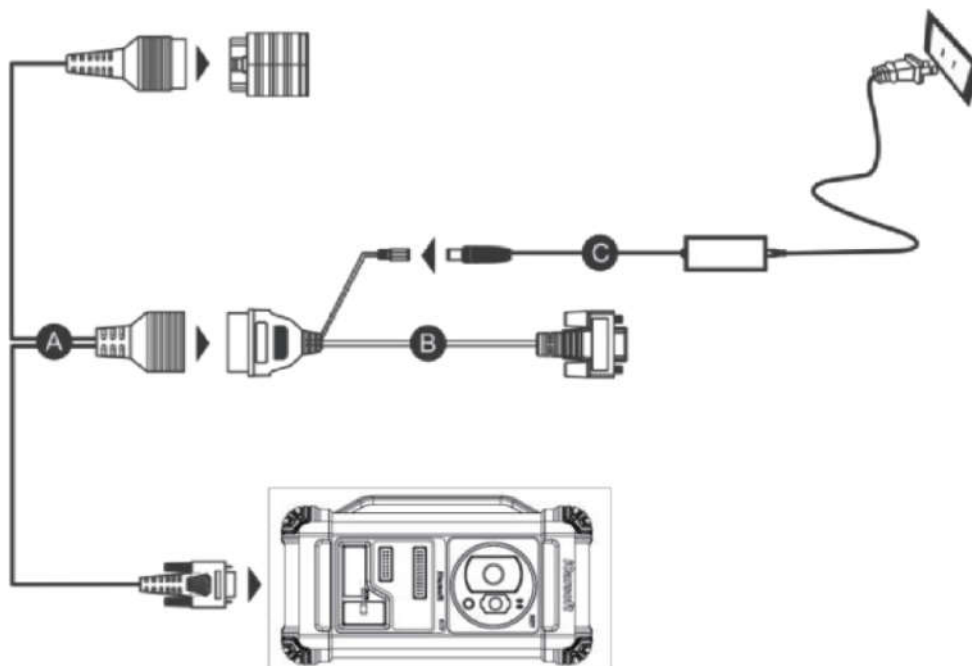

- A. Main diagnostic cable
- B. OBD I adaptor
- C. Switching power supply of the IM2000 PRO

Notes:

- You are suggested to connect the VCI dongle shown in below diagram to the tablet via the USB cable. Using a USB cable could effectively enhance your data transmission speed.
- IMMO Programming does not require a connection to the vehicle. To ensure that the IM2000 PRO works properly, **ONLY** use the switching power supply and OBD I adaptor to supply power to the IM2000 PRO. Obtaining power through a connection to the DC power jack of the IM2000 PRO via the switching power supply alone is failed.

2. Tap **Anti-theft programmer** to enter the following screen.

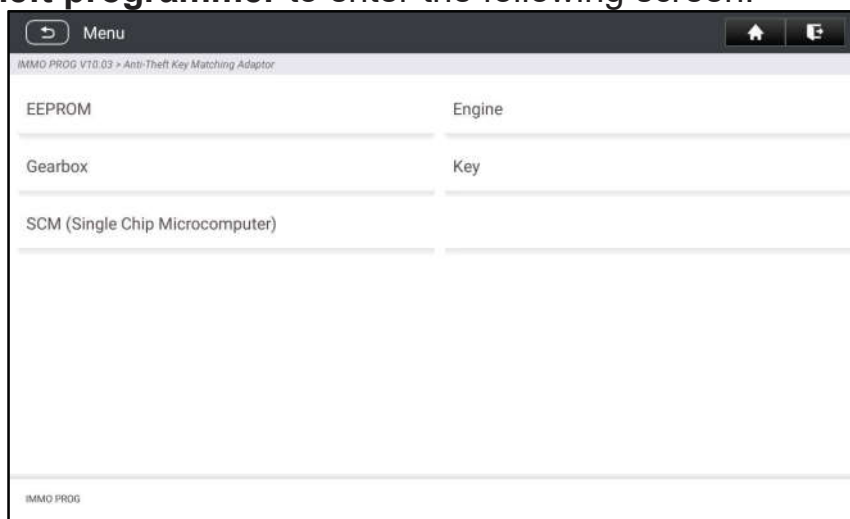

3. Select the desired item to proceed.

5.2.1 EEPROM Programming

This function allows you to read/write on-board EEPROM chip data.

5.2.2 Engine Programming

This function allows you to read the engine data and write in the backup data after a new engine is replaced.

Below procedures show you how to perform engine programming.

1. Tap **Engine**.

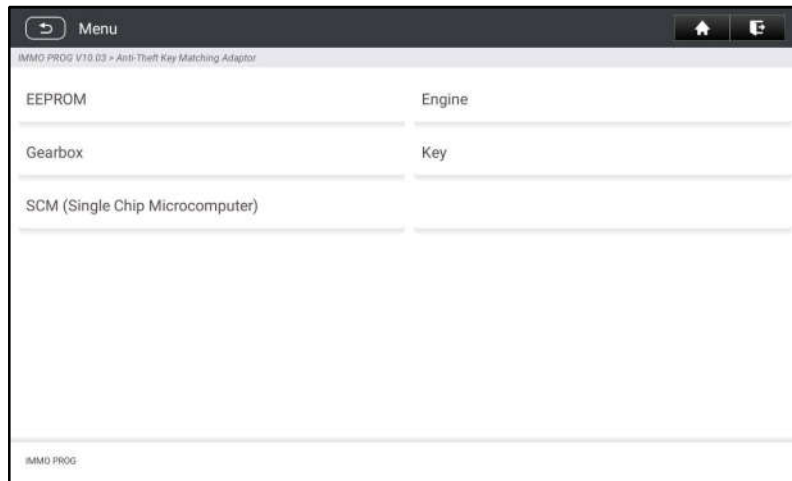

2. Select Engine Brand.

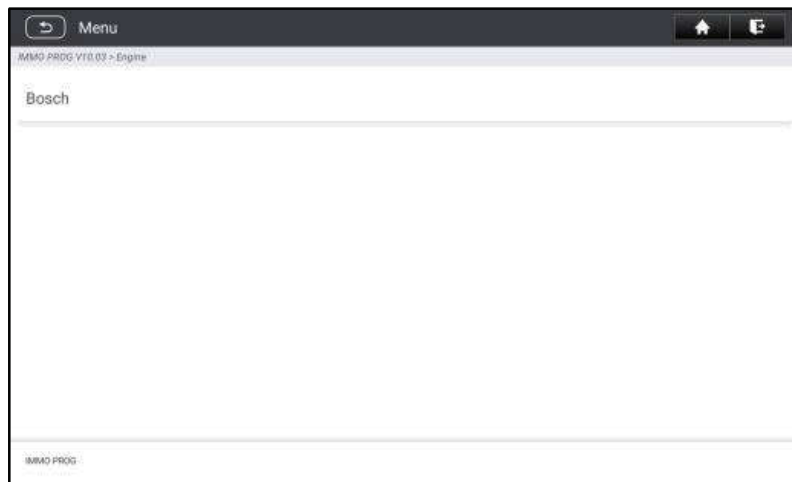

3. Tap **Search for ECU model**.



4. Check ECU model (printed on the sticker on the back of your Engine), enter the engine type in the dialogue box (for example , the engine type should be MED17.7.7) and tap **OK**.

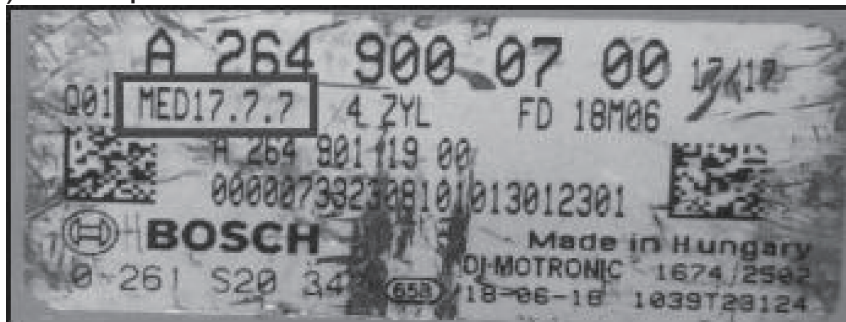

5. Tap **OK** to confirm the engine type and enter the function selection screen.

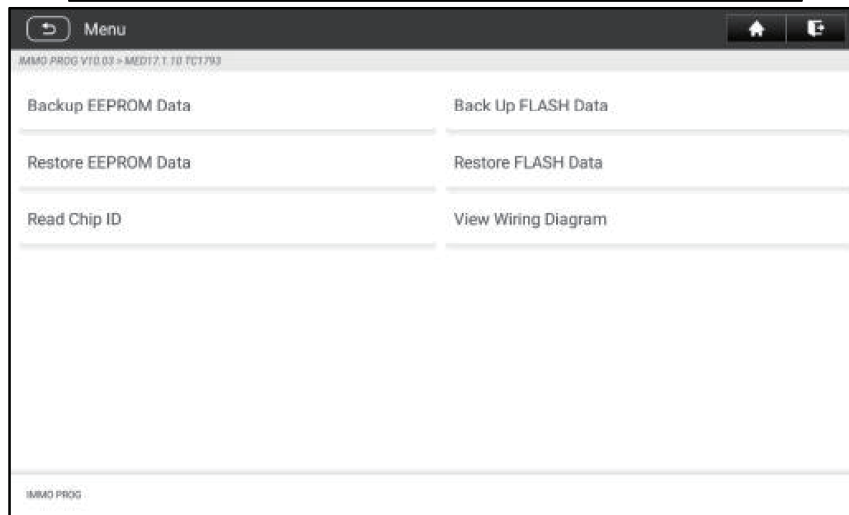
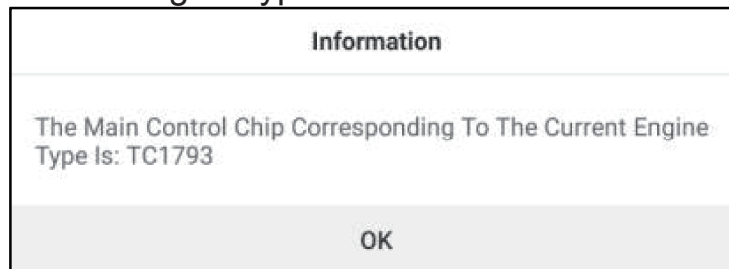

- Note:** The function selection screen varies by different vehicle manufacturers.
- a. Tap **View Wiring Diagram** to check how to connect the engine with the IM2000 PRO.

Note: Vehicle engine connection could vary depending on engine types, for information how to connect the car engine, refer to the onscreen connection diagram.

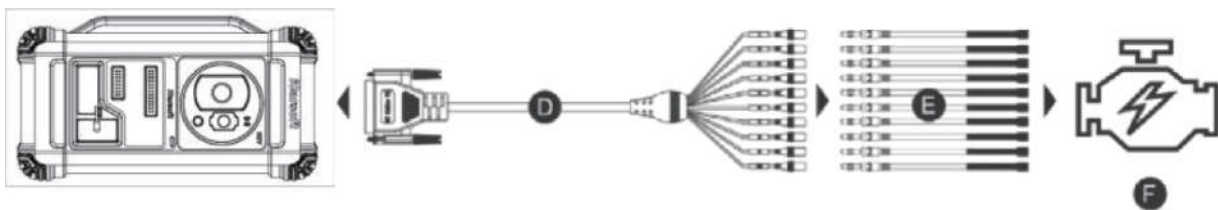
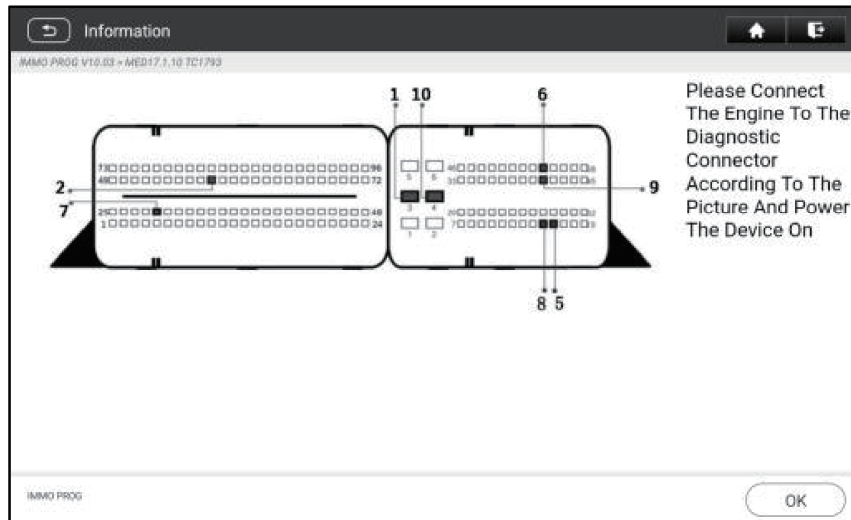

- D. BENCH mode cable
- E. Adaptor cable associated with the BENCH mode cable
- F. Engine

- b. Tap **Backup EEPROM data** to create a file name and save it on the tablet.
- c. Tap **Restore EEPROM data** to write the backup EEPROM data into the new engine.

⚠ Stop: The EEPROM restoration applies only when you have encountered irrevocable faults or after a new engine is replaced.

- d. Tap **Backup FLASH data** to save the FLASH data on the tablet to avoid accidents.
- e. Tap **Read chip ID** to read the chip information.

5.2.3 Gearbox Programming

This function allows you to restore the old gearbox data or write in new data after a new gearbox is replaced.

Below procedures show you how to perform gearbox programming for AUDI.

There are two kinds of gearbox ECU replacements, and the user can choose the corresponding solution according to the actual situation.

Situation 1 - The data of the original vehicle gearbox ECU is readable. Data is not damaged, and the gearbox can be cloned. In this case, we just need to back up the original gearbox EEPROM and FLASH, and then restore them into the gearbox ECU for replacement.

Situation 2 - The data of the original vehicle gearbox ECU is unreadable or the data is damaged. In this case, we need to back up the EEPROM of the ECU for

replacement, and then manually input the original CS code or get the original CS code from the original key.

Situation 1:

1. Tap **Gearbox**.

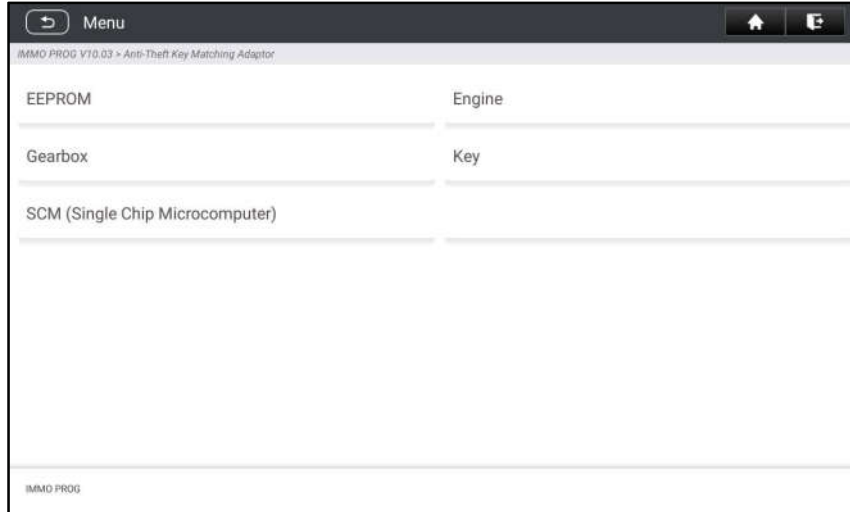

2. Select Gearbox type according to the specific model, here we choose **DQ200-MQB** (take this as an example) to enter the function selection screen.

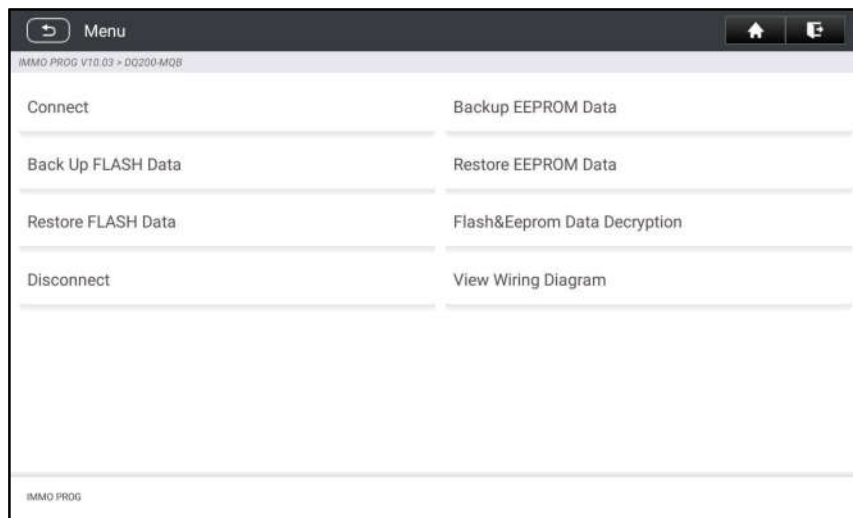

 Note: The function selection screen varies by different vehicle manufacturers.

3. Tap **View Writing Diagram** to check how to view the original car gearbox ECU with IM2000 PRO using the BENCH mode cable and its associated adaptor cable.

 Note: Vehicle gearbox connection could vary depending on gearbox types, for information how to connect the car gearbox, refer to the onscreen connection diagram.

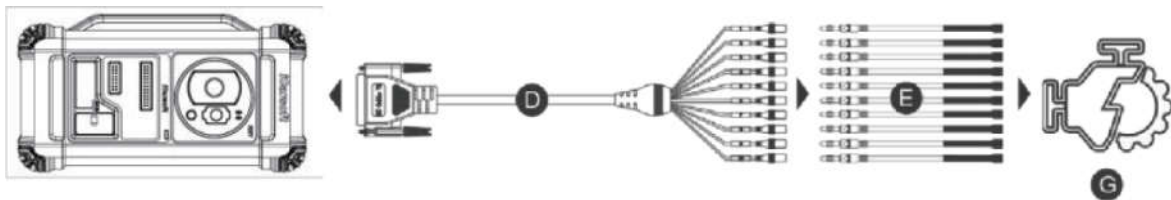
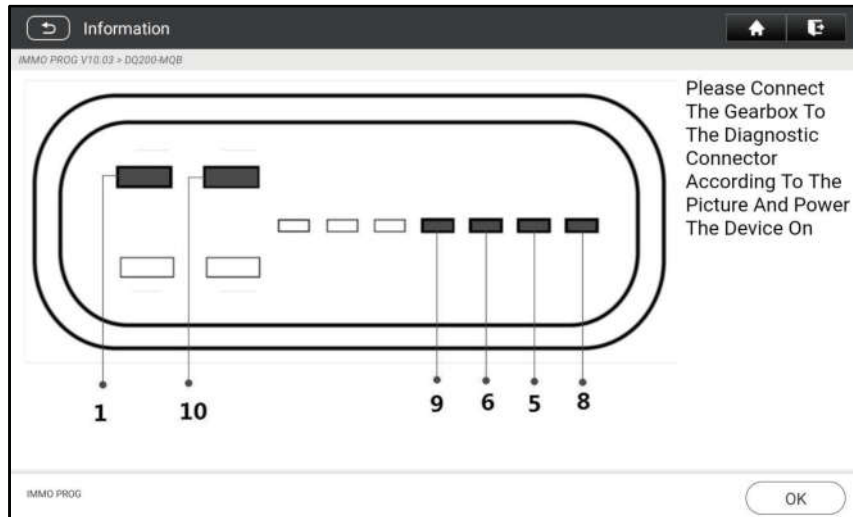

- D. BENCH mode cable
- E. Adaptor cable for the BENCH mode cable
- G. Gearbox ECU

4. Tap **Connect** to read the chip ID of the original car gearbox.

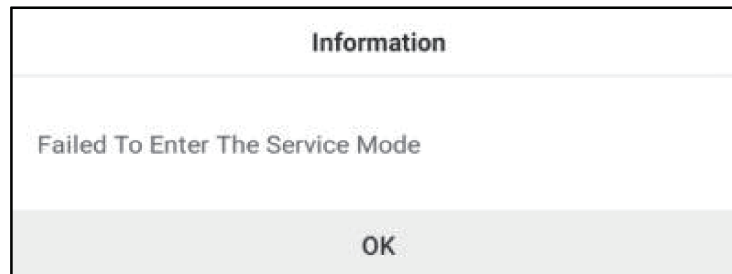

5. Tap **Backup EEPROM Data** to read the EEPROM data of the original car gearbox and then enter the new file name to save it on the tablet.
6. Tap **Backup FLASH Data** to back up the FLASH data of the original vehicle gearbox and then enter the new file name to save it on the tablet.
7. Tap **Disconnect** to disconnect the original vehicle gearbox, and then disconnect the original vehicle gearbox from the BENCH mode cable.
8. Connect the new gearbox ECU to the IM2000 PRO according to the steps 3 and 4.
9. Tap **Restore EEPROM Data**, select the EEPROM data backed up in step 5, and tap **OK** to write the EEPROM data of the original vehicle gearbox in the new gearbox ECU.

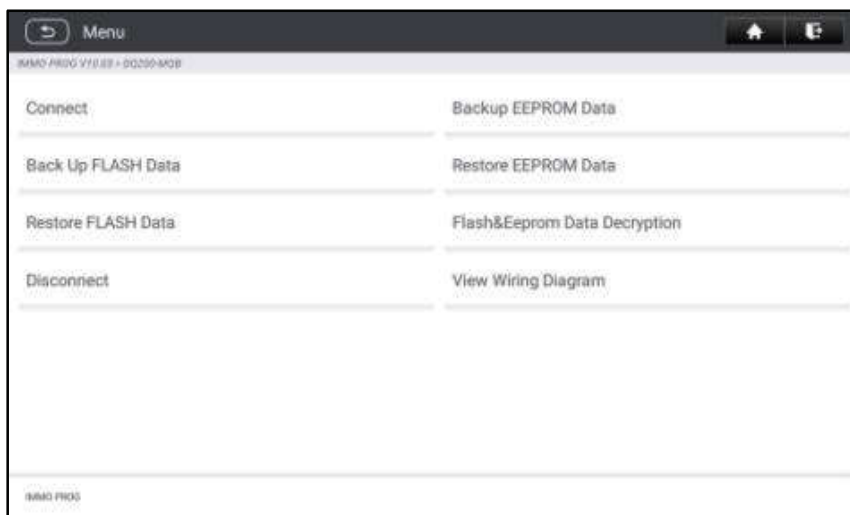

10. Tap **Restore FLASH Data** to write the FLASH data of the original vehicle gearbox backed up in step 6 into the new gearbox ECU.

Situation 2:

1. Tap **Gearbox**.

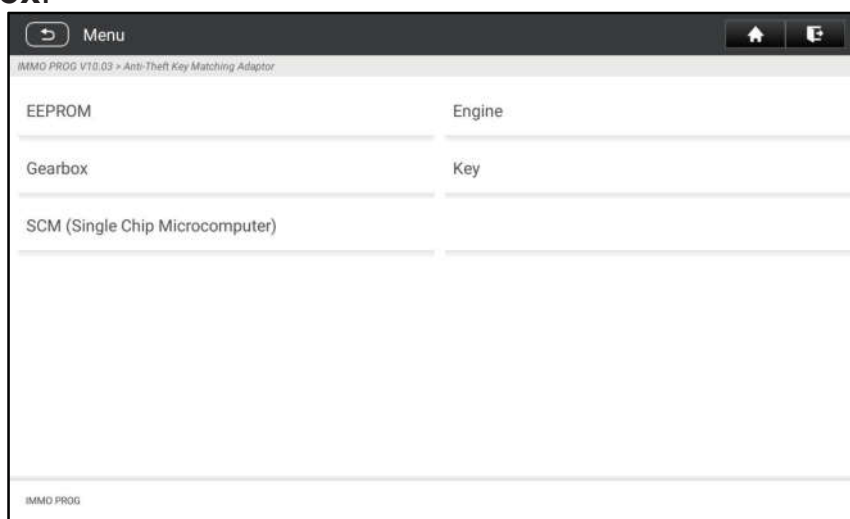

2. Select Gearbox type according to the specific model, here we choose **DQ200-MQB** (take this as an example) to enter the function selection screen.

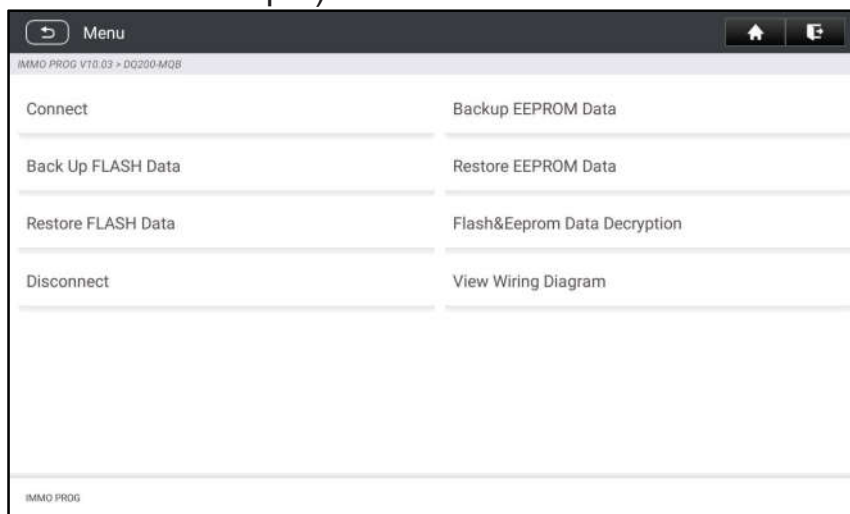

Note: The function selection screen varies by different vehicle manufacturers.

3. Tap **View Writing Diagram** to view how to connect the original car gearbox ECU with IM2000 PRO using the BENCH mode cable and its associated adaptor cable.

Note: Vehicle gearbox connection could vary depending on gearbox types, for information how to connect the car gearbox, refer to the onscreen connection diagram.

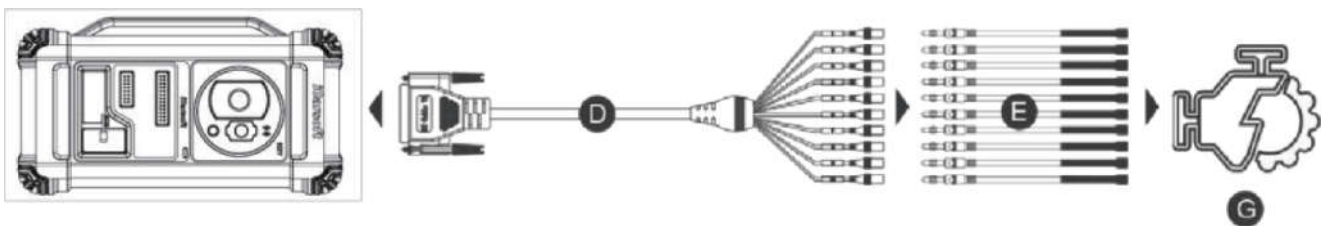
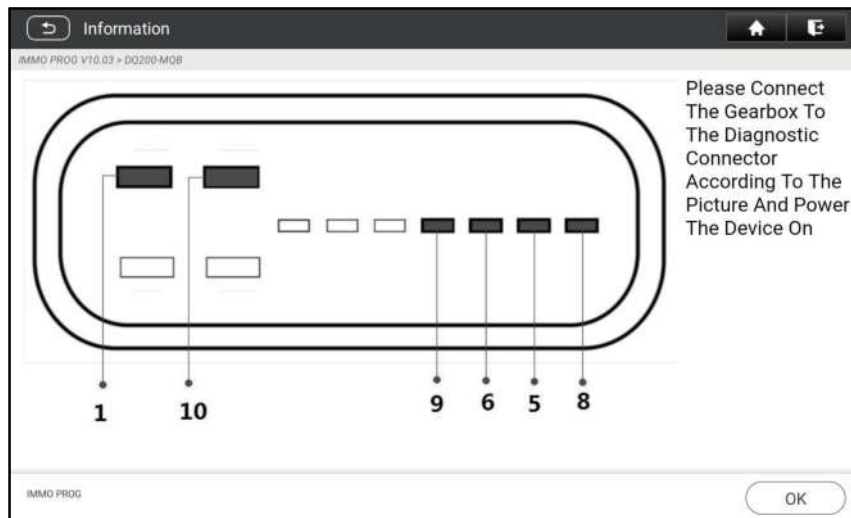

- D. BENCH mode cable
- E. Adaptor cable associated with the BENCH mode cable
- G. Gearbox ECU

4. Tap **Connect** to read the chip ID of the original car gearbox.

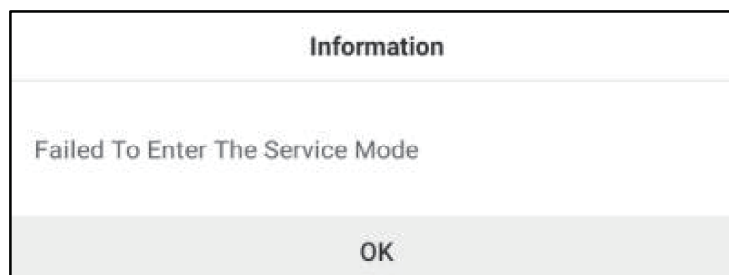

5. Tap **Backup EEPROM Data** to read the EEPROM data of the original car gearbox and then enter the new file name to save it on the tablet.
6. Exit **Anti-theft programmer application**. Install the new gearbox on the vehicle and connect the IM2000 PRO to the vehicle's DLC port.

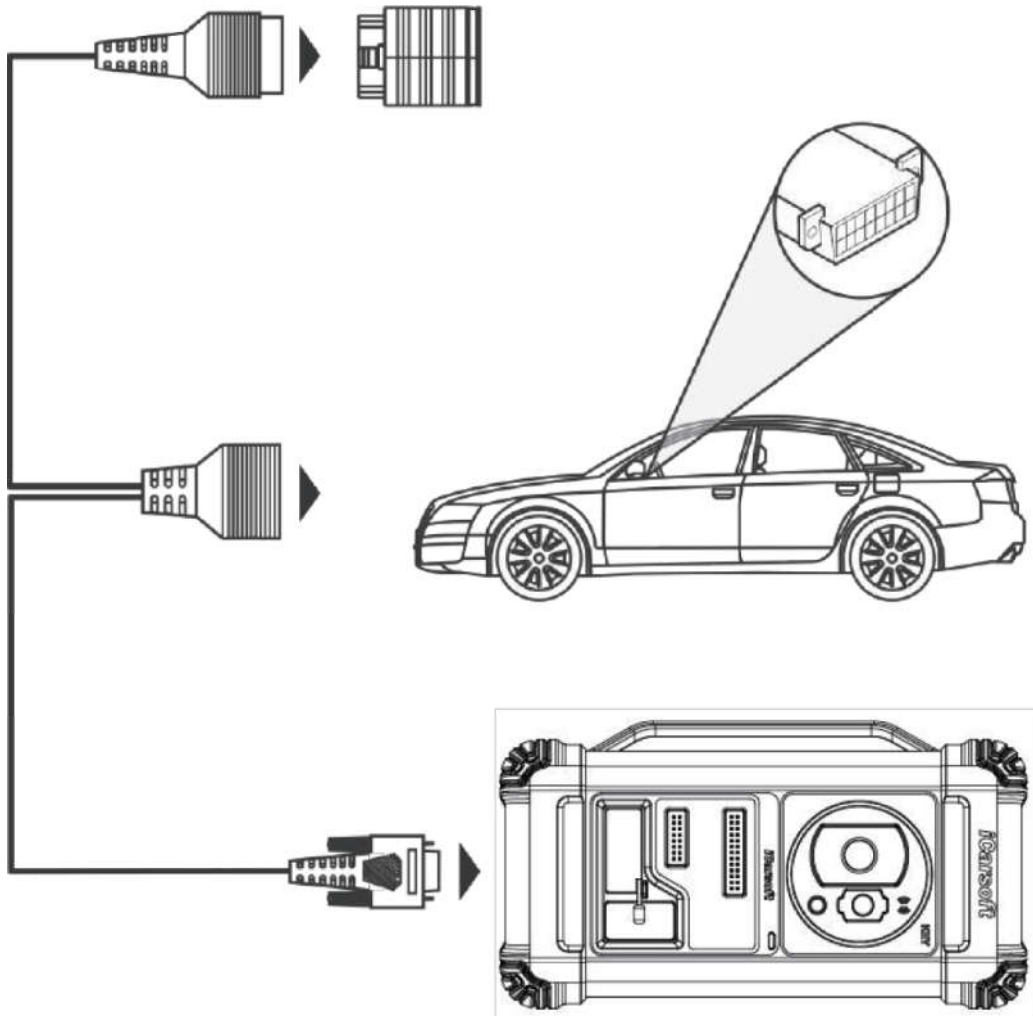

7. Tap **Anti-theft Matching**, choose **VW** to enter the anti-theft system, select **MQB Instrument -> Replacement Of Parts -> Transmission**, tap **OK**.

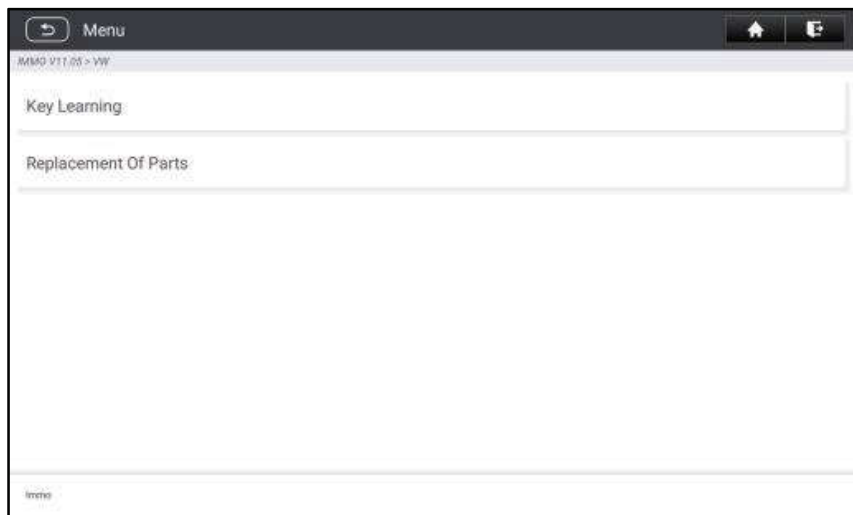

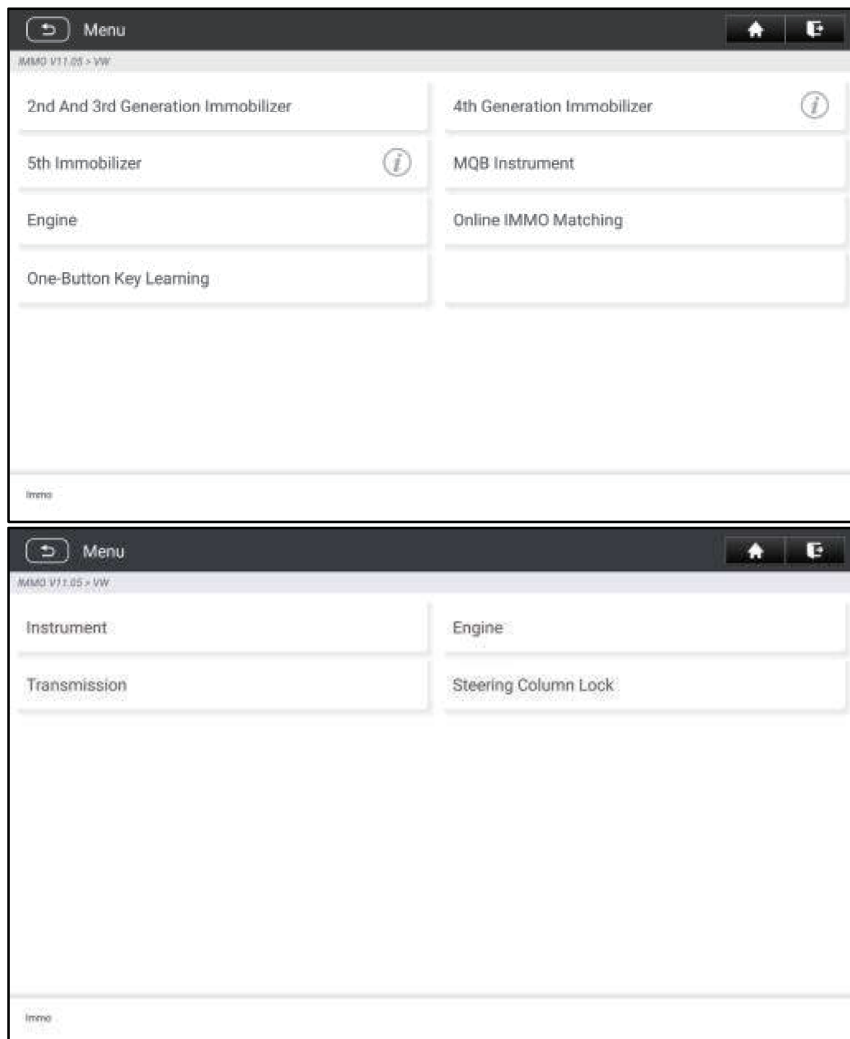

8. Tap **YES** to enter the gearbox replacement screen.

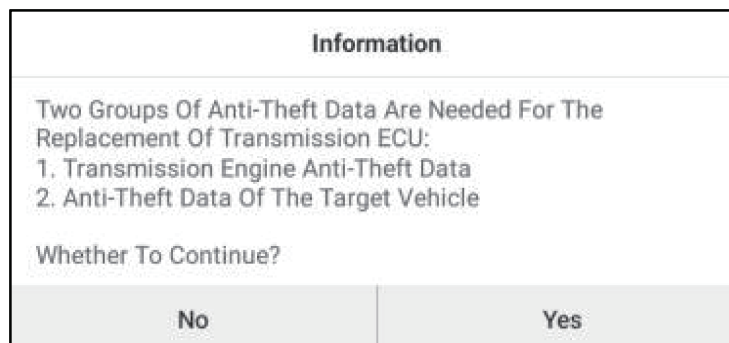

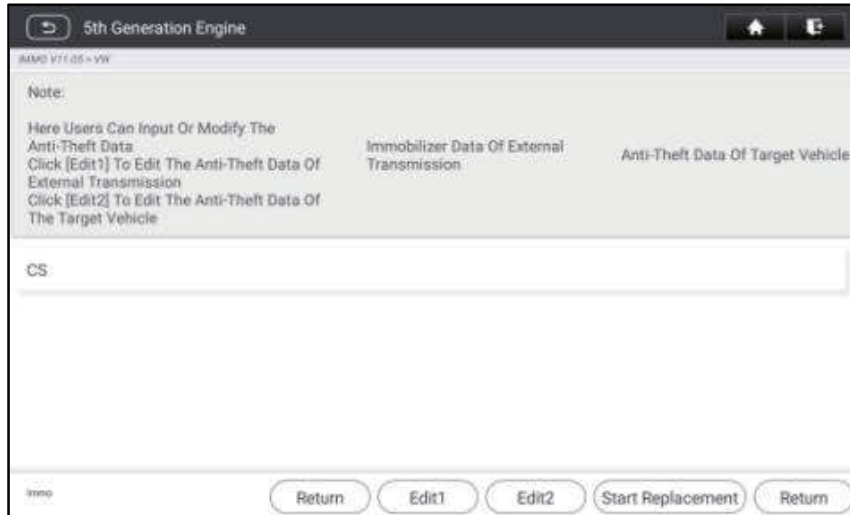

9. When replacing the transmission ECU, two groups of anti-theft data are required:

- Anti-theft data of transmission engine (backed up in step 5)
- Anti-theft data of the target vehicle
 - 1). Select **Edit1**, tap **NO**, tap **Obtain From EEPROM Data**, select the new gearbox EEPROM data backed up in step 5, and tap **OK**.

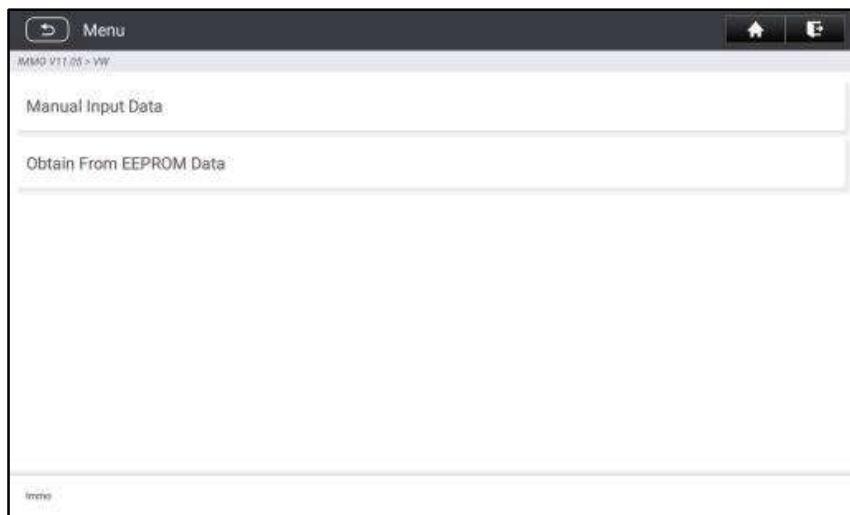
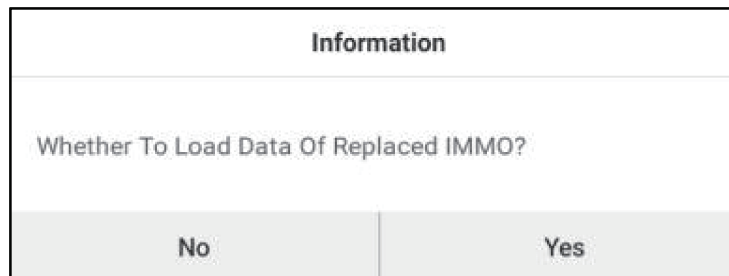

2). Tap **Edit2**, if you have obtained the relevant data of the original vehicle gearbox from other equipment, select **Manual Input Data** and enter the 16-byte CS code of the original vehicle gearbox.

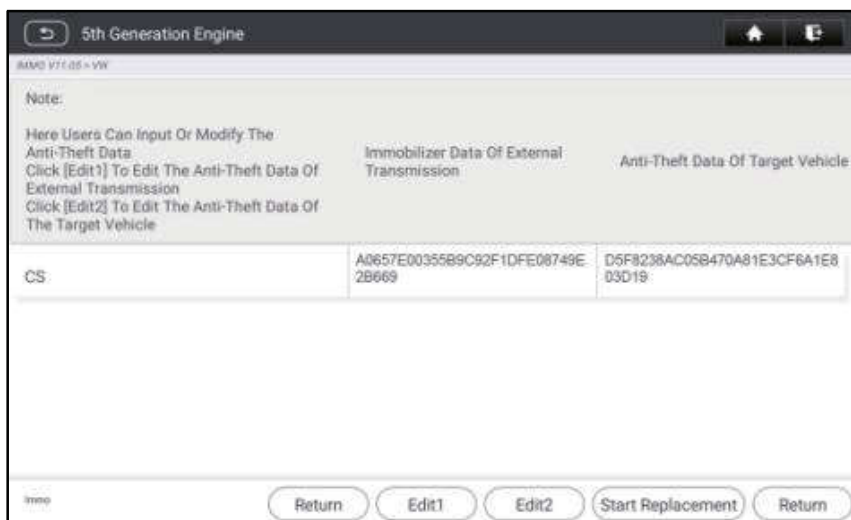
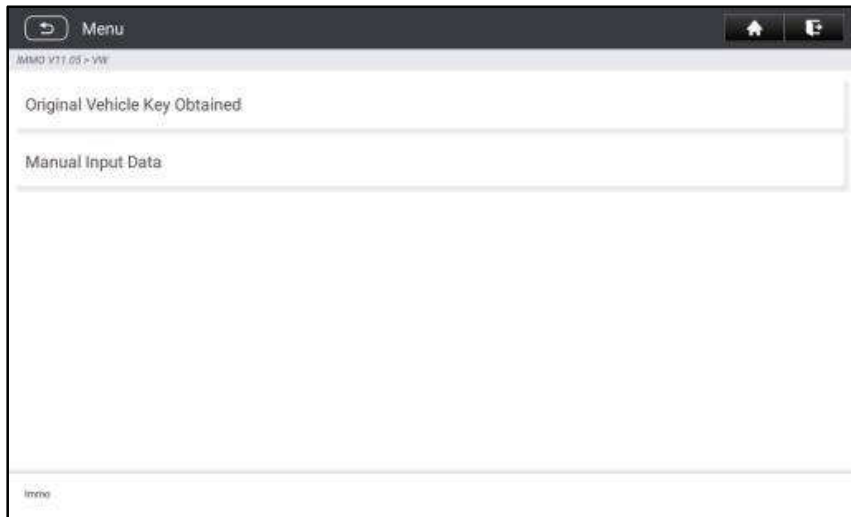

Note: If there is no anti-theft data of the target vehicle, select **Original Vehicle Key Obtained**, put the original vehicle key in the IM2000 PRO, and just follow the prompts to obtain it, no need to enter any data to complete the replacement.

10. Tap **Start Replacement**, and input the original car's VIN code, power level and CS code of the original car instrument according to the information prompts to complete the gearbox replacement.

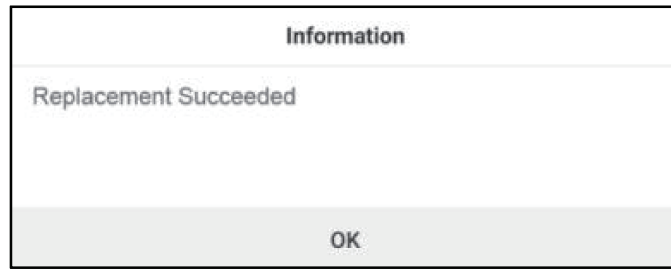

Note: If **Original Vehicle Key Obtained** is selected in step 8, the vehicle’s VIN code, power level and CS code in this step will be automatically obtained. The user is not required to enter any data to complete the replacement.

5.2.4 Key Programming

This function allows you to backup old key data, write in data for new keys and detect remote control frequency.

5.2.5 SCM(Single Chip Microcomputer) Programming

This function allows you to read chip (also called MCU) ID, lock/unlock chip, backup/restore EEPROM data and FLASH data.

Notes:

- The data flow is large when performing reading/writing operations. To improve the communication stability, you are recommended to use a USB cable.
- MCU connection could vary depending on MCU types, for information how to connect the MCU, refer to the onscreen wiring diagram.

6 Diagnose

Two methods are available to access the vehicle diagnostic software.

6.1 VIN SCAN

This function enables you to quickly access the vehicle diagnostic software through reading the vehicle's VIN (Vehicle Identification Number). For this method, camera scan and manual input are available.

Tap **VIN scan**, the following screen will appear:

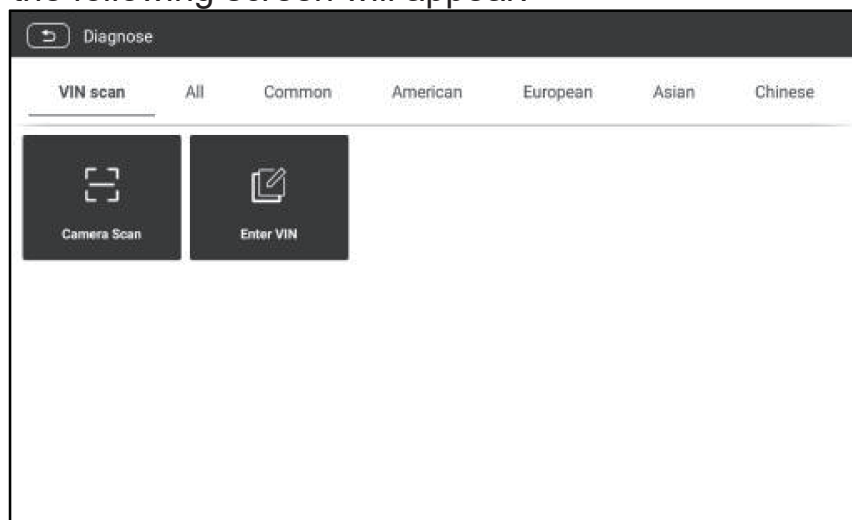

- A. Camera Scan: This mode allows you to identify the vehicle model via scanning the vehicle’s VIN.
Once scanning is complete, the tablet will enter the diagnostic software of the vehicle directly.
- B. Enter VIN: In this mode, input the VIN manually to enter the diagnostic software of the vehicle.
Input the VIN, and tap **OK**, the tablet will automatically identify the vehicle model and enter the diagnostic software of the vehicle.

6.2 Manual Selection

In this mode, tap the appropriate vehicle logo, then follow the on-screen instructions to access the diagnostic software.

Take **DEMO** as an example to demonstrate the basic procedures on how to diagnose a vehicle.

- 1). Select diagnostic software version: Tap DEMO to go to Step 2.
- 2). Select vehicle model (varies with different versions): Select the desired vehicle model. Here we take Ford for example to demonstrate how to diagnose a vehicle.
- 3). Turn the ignition key to ON: Set the ignition switch to on.
- 4). Read vehicle information: After reading the vehicle information, double check if the vehicle information is correct or not. If yes, tap YES to continue.
- 5). Select test item: Select the desired test item to proceed.



6.2.1 Health Report (Quick Test)

This function varies from vehicle to vehicle. It enables you to quickly access all the electronic control units of the vehicle and generate a detailed report about the vehicle health.

Tap **Health Report** on the test item selection screen to scan the vehicle control modules. When scanning is complete, the following screen will appear:

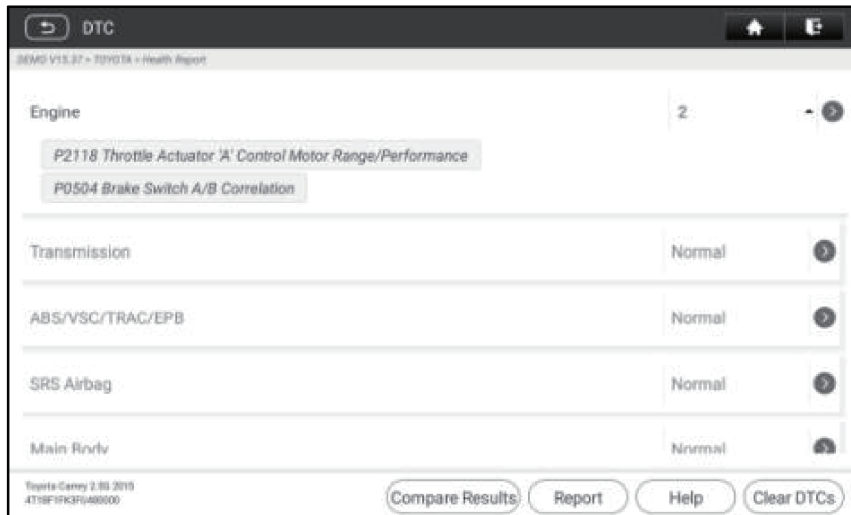

Systems with fault codes are displayed in red. Systems functioning normally are displayed in black.

Explanation of terms:

Report: Tap to save the diagnostic result as a diagnostic report in text format.

Help: Tap to view the help information of the selected DTC.

Compare Results: Tap to select the pre-repair report to compare.

By comparison of the pre- and post- repair reports, you can easily identify which DTCs are cleared and which remain unfixed.

Clear DTCs: Tap to clear the existing diagnostic trouble codes.

6.2.2 System Scan

This option allows you to quickly scan which systems are installed on the vehicle.

6.2.3 System Selection

This option allows you manually select the test system and function step by step. Tap **System Selection** and select the target system (take **Engine** for example) to enter the test function screen.

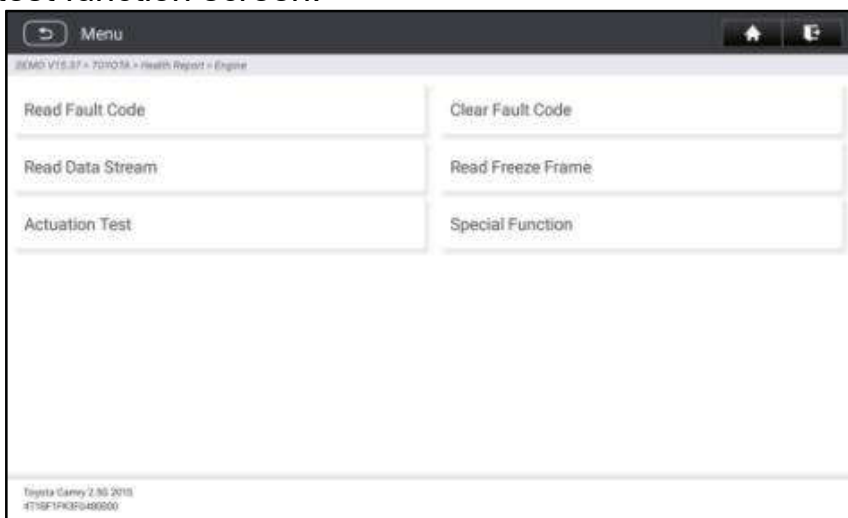

Note: Different vehicle has different diagnostic menus.

A. Read Fault Code

This function displays the detailed information of DTC records retrieved from the vehicle’s control system.

Tap **Read Fault Code** on the test function selection screen, the screen will display the diagnostic result.

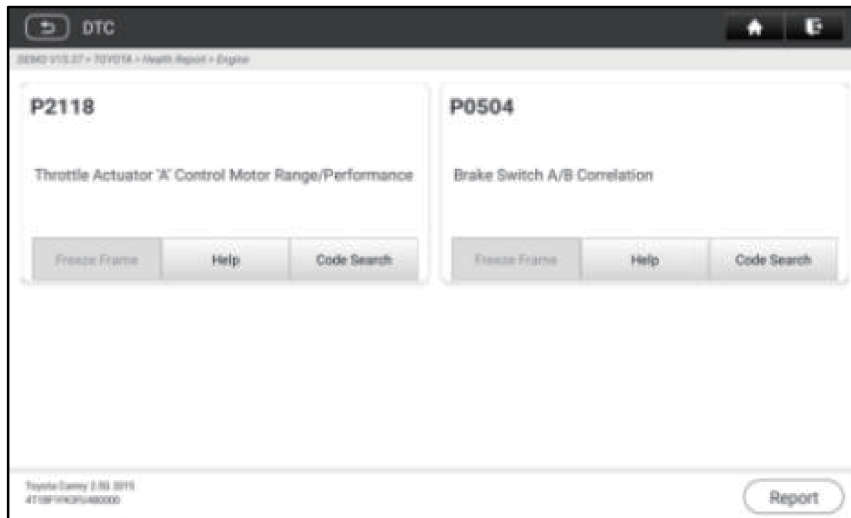

Explanation of terms:

Freeze Frame: A snapshot of critical parameter values at the time the DTC is set.

Help: View the help information.

Code Search: Search for more information about the current DTC online.

Report: Save the current data in text format. All reports are saved in **Reports -> Diagnostic**.

B. Clear Fault Code

This function enables you to erase the codes from the vehicle after reading the retrieved codes from the vehicle and certain repairs have been carried out.

Note: Make sure the vehicle’s ignition key is in the ON position with the engine off before operating.

C. Read Freeze Frame

This option presents you with a snapshot of critical vehicle parameter values at the time the DTC is set.

D. Read Data Stream

This option lets you view and capture (record) real-time Live Data.

Warning: If you must drive the vehicle in order to perform a troubleshooting procedure, ALWAYS have a second person to help you. Trying to drive and operate the diagnostic tool at the same time is dangerous, and could cause a serious traffic accident. Tap **Read Data Stream** and select the desired data stream items to enter the data stream reading page, which is the Value default mode displaying the parameters in texts and shows in list format.

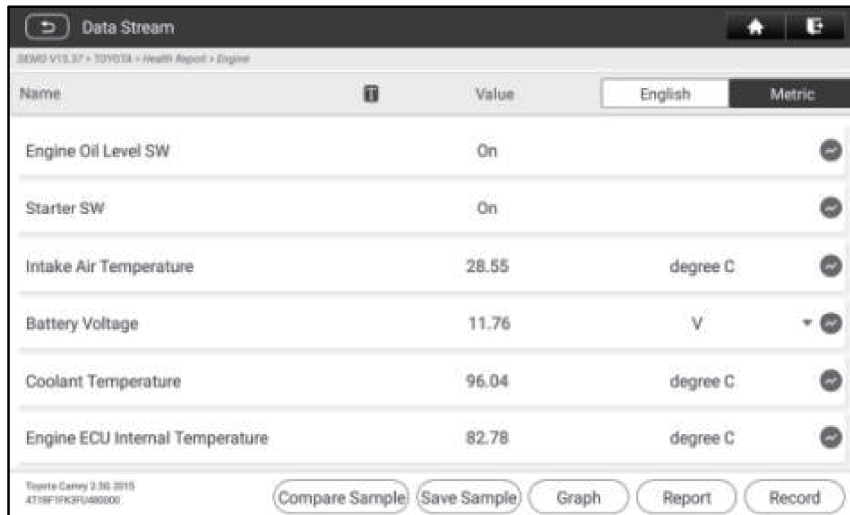

Notes: Tap **T** to set the display style. **↑** indicates sticky top. **B** indicates this item will be displayed in **Bold**. **A** indicates this item will be displayed in Red.

There are 3 types of display modes available for data viewing, allowing you to view various types of parameters in the most suitable way.

- ✓ Value – Display the parameters in texts and shows in list format.
- ✓ Graph – Display the parameters in waveform graphs.
- ✓ Combine – Display the parameters in merged graph mode for data comparison.

Explanation of terms:

Graph: View the parameter in waveform graph of the current data stream item.

Graph: View the parameters in waveform graphs of all data stream items. When in graph mode, the following operations are supported:

- **Combine / <**: Combine different data stream items for data comparison.
- **Value:** View the parameters in text format.

Compare Sample: Select the sampled data stream file. All the values you customized and saved in process of data sampling will be imported into the **Standard Range** column for your comparison.

Note: Before executing this function, you have to sample the values of data stream items and save it as a sample Data Stream file.

Save Sample: Save the running parameters as a data stream sample file.

Note: Only data stream items with measurement units will be recorded.

Report: Tap to save the current data in text format. All reports are saved in **Reports -> Diagnostic**.

Record: Tap to start recording diagnostic data. Recorded live data can serve as valuable information to help you in troubleshooting of vehicle problems. All diagnostic records can be replayed from **Reports -> Datastream**.

E. Actuation Test

This option is used to access vehicle-specific subsystem and component tests.

Available test vary by vehicle manufacturer, year and model.

F. Special Function

In addition to amazing & powerful diagnostic function, the tool also features various reset functions, which varies from vehicle to vehicle.

7 Maintenance

This module provides an easy dial to quickly access the most commonly performed service functions as following.

- Oil Reset Service
- Electronic Parking Brake Reset
- Steering Angle Calibration
- ABS Bleeding
- TPMS (Tire Pressure Monitor System) Reset
- Gear Learning
- IMMO Service
- Injector Coding
- Battery Maintenance System (BMS) Reset
- Diesel Particulate Filter (DPF) Regeneration
- Electronic Throttle Position Reset
- Gearbox Matching
- AFS (Adaptive Front-lighting System) Reset
- Sunroof Initialization
- Suspension Calibration

7.1 Oil Reset Service

This function allows you to perform reset for the engine oil life system, which calculates an optimal oil life change interval depending on the vehicle driving conditions and climate.

This function can be performed in the following cases:

1. If the service lamp is on, you must provide service for the car. After service, you need to reset the driving mileage or driving time so that the service lamp turns off and the system enables the new service cycle.
2. After changing engine oil or electric appliances that monitor oil life, you need to reset the service lamp.

7.2 Electronic Parking Brake Reset

1. If the brake pad wears the brake pad sense line, the brake pad sense line sends a signal sense line to the on-board computer to replace the brake pad. After replacing the brake pad, you must reset the brake pad. Otherwise, the car alarms.
2. Reset must be performed in the following cases:
 - a) The brake pad and brake pad wear sensor are replaced.
 - b) The brake pad indicator lamp is on.
 - c) The brake pad sensor circuit is short, which is recovered.
 - d) The servo motor is replaced.

7.3 Steering Angle Calibration

To reset the steering angle, first find the relative zero point position for the car to drive in straight line. Taking this position as reference, the ECU can calculate the accurate angle for left and right steering.

After replacing the steering angle position sensor, replacing steering mechanical parts (such as steering gearbox, steering column, end tie rod, steering knuckle), performing four-wheel alignment, or recovering car body, you must reset the steering angle.

7.4 ABS Bleeding

This function allows you to perform various bi-directional tests to check the operating conditions of Anti-lock Braking System (ABS).

1. When the ABS contains air, the ABS bleeding function must be performed to bleed the brake system to restore ABS brake sensitivity.
2. If the ABS computer, ABS pump, brake master cylinder, brake cylinder, brake line, or brake fluid is replaced, the ABS bleeding function must be performed to bleed the ABS.

7.5 Tire Pressure Monitor System Reset

This function allows you to quickly look up the tire sensor IDs from the vehicle's ECU, as well as to perform TPMS replacement and sensor test.

1. After the tire pressure MIL turns on and maintenance is performed, the tire pressure resetting function must be performed to reset tire pressure and turn off the tire pressure MIL.
2. Tire pressure resetting must be performed after maintenance is performed in the following cases: tire pressure is too low, tire leaks, tire pressure monitoring device is replaced or installed, tire is replaced, tire pressure sensor is damaged, and tire is replaced for the car with tire pressure monitoring function.

7.6 Gear Learning

The crankshaft position sensor learns crankshaft tooth machining tolerance and saves to the computer to more accurately diagnose engine misfires. If tooth learning is not performed for a car equipped with Delphi engine, the MIL turns on after the engine is started. The diagnostic device detects the DTC P1336 'tooth not learned'. In this case, you must use the diagnostic device to perform tooth learning for the car. After tooth learning is successful, the MIL turns off.

After the engine ECU, crankshaft position sensor, or crankshaft flywheel is replaced, or the DTC 'tooth not learned' is present, tooth learning must be performed.

7.7 IMMO Service

This function enables you to perform the anti-theft key matching function, so that the immobilizer control system on the car identifies and authorizes remote control keys to normally use the car.

It needs to be performed in the following cases:

When the ignition switch key, ignition switch, combined instrument panel, ECU, BCM, or remote control battery is replaced.

7.8 Injector Coding

Write injector actual code or rewrite code in the ECU to the injector code of the corresponding cylinder so as to more accurately control or correct cylinder injection quantity.

After the ECU or injector is replaced, injector code of each cylinder must be confirmed or re-coded so that the cylinder can better identify injectors to accurately control fuel injection.

7.9 Battery Maintenance System Reset

This function enables you to perform a resetting operation on the monitoring unit of vehicle battery, in which the original low battery fault information will be cleared and battery matching will be done.

Battery matching must be performed in the following cases:

- a) Main battery is replaced. Battery matching must be performed to clear original low battery information and prevent the related control module from detecting false information. If the related control module detects false information, it will invalidate some electric auxiliary functions, such as automatic start & stop function, sunroof without one-key trigger function, power window without automatic function.
- b) Battery monitoring sensor. Battery matching is performed to re-match the control module and motoring sensor to detect battery power usage more accurately, which can avoid an error message displaying on the instrument panel.

7.10 Diesel Particulate Filter (DPF) Regeneration

DPF regeneration is used to clear PM (Particulate Matter) from the DPF filter through continuous combustion oxidation mode (such as high temperature heating combustion, fuel additive or catalyst reduce PM ignition combustion) to stabilize the filter performance.

DPF regeneration may be performed in the following cases:

- 1) The exhaust back pressure sensor is replaced.
- 2) The PM trap is removed or replaced.
- 3) The fuel additive nozzle is removed or replaced.
- 4) The catalytic oxidizer is removed or replaced.
- 5) The DPF regeneration MIL is on and maintenance is performed.
- 6) The DPF regeneration control module is replaced.

7.11 Electronic Throttle Position Reset

This function enables you to make initial settings to throttle actuators and returns the learned values stored on ECU to the default state. Doing so can accurately control the actions of regulating throttle (or idle engine) to adjust the amount of air intake.

7.12 Gearbox Matching

1. This function can complete the gearbox self-learning to improve gear shifting quality.
2. When the gearbox is disassembled or repaired (after some of the car battery is powered off), it will lead to shift delay or impact problem. In this

case, this function needs to be done so that the gearbox can automatically compensate according to the driving conditions so as to achieve more comfortable and better shift quality.

7.13 AFS (Adaptive Front-lighting System) Reset

This feature is used to initialize the adaptive headlamp system. According to the ambient light intensity, the adaptive headlamp system may decide whether to automatically turn on the headlamps, and timely adjust the headlamp lighting angle while monitoring the vehicle speed and body posture.

7.14 Sunroof Initialization

This function can set the sunroof lock off, closed when it rains, sliding / tilting sunroof memory function, temperature threshold outside the car etc.

7.15 Suspension Calibration

1. This function can adjust the height of the body.
2. When replacing the body height sensor in the air suspension system, or control module or when the vehicle level is incorrect, you need to perform this function to adjust the body height sensor for level calibration.

7.16 EGR Adaption

This function is used to learn the EGR (Exhaust Gas Recirculation) valve after it is cleaned or replaced.

7.17 Windows Calibration

This feature is designed to perform door window matching to recover ECU initial memory, and recover the automatic ascending and descending function of power window.

7.18 Seats Calibration

This function is applied to match the seats with memory function that are replaced and repaired.

7.19 Tyre Reset

This function is used to set the size parameters of the modified or replaced tire.

7.20 Language Change

This function is used to change the system language of the vehicle central control panel.

7.21 A/F Reset

This function is applied to set or learn Air/Fuel ratio parameters.

7.22 Coolant Bleed

Use this function to activate the electronic water pump before venting the cooling system.

7.23 Transport Mode

In order to reduce power consumption, the following functions may be disabled, including limiting the vehicle speed, not waking up the door opening network,

and disabling the remote control key, etc. At this time, the transport mode needs to be deactivated to restore the vehicle to normal.

7.24 AdBlue Reset (Diesel Engine Exhaust Gas Filter)

After the diesel exhaust treatment fluid (car urea) is replaced or filled up, urea reset operation is required.

7.25 NOx Sensor Reset

NOx sensor is a sensor used to detect the content of nitrogen oxides (NOx) in engine exhaust. If the NOx fault is re-initialized and the NOx catalytic converter is replaced, it is necessary to reset the catalytic converter learned value stored in the engine ECU.

7.26 Stop/Start Reset

This function is used to open or close the automatic start-stop function via setting the hidden function in ECU (provided that the vehicle has a hidden function and supported by hardware).

8 Feedback

This function enables you to feedback the diagnostic issues to us for analysis and troubleshooting.

Tap **Feedback**, and tap **OK** to enter into the vehicle diagnostic record page.

A. Feedback

Tap the target vehicle to enter the feedback page.

B. History

Tap it to view the diagnostic feedback logs which are marked with different color indicating the process status of the diagnostic feedback.

C. Offline list

Tap it to enter the diagnostic feedback offline list page. Once the tool gets a stable network signal, it will be uploaded to the remote server automatically.

9 Update

This module enables you to update the diagnostic software & App and frequently used software.

9.1 Update Diagnostic Software & APP

Tap **Update** on the Job Menu to enter the update center.

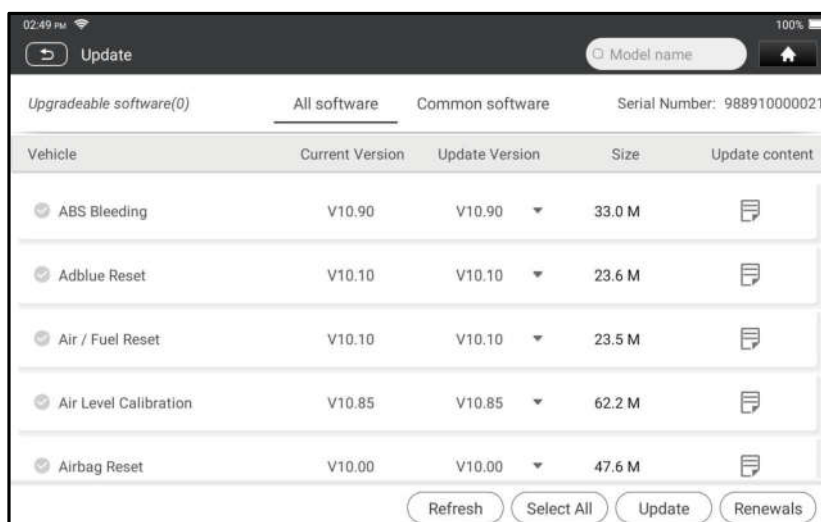

By default, all diagnostic software is selected. To deselect certain software, tap **Unselect**, and then check the box next to vehicle model. Tap **Update** to start downloading.

Once download is finished, the software packages will be installed automatically.

9.2 Renew Subscription

If the software subscription is due or expires, the system will prompt you to renew your subscription.

Tap **Renewals** on the bottom of the screen to enter the payment screen.

1. Tap **Subscription Renewal Card** (*need to buy it from the local dealer where you purchased the tool).
2. Input the 24-digit pin code of Subscription Renewal Card and then tap **Submit** to finish the renewal.
3. Go to update center to update the diagnostic software.

10 Report Printing

10.1 Print via APP

1. Click "Reports" icon to enter the reports display screen.
2. Choose and enter the report which you will printing, enter the report detail page and tap Print button
3. Click ▼ and choose "all printers", searching for printers, and click "ADD PRINTER".



4. Tap “Default Print Service”, and choose “Add printer by IP address”.



5. Input the IP address of the printer, and add the printer.



6. Choose the printer, and click the  icon to printing the report.



10.2 Print via PC

A. Paste reports to the PC:

1. Click **Personal Center - Settings - Mode Switch**, and select **“DEVICE MODEL”**.
2. Connect the device to the PC via USB cable (Type A to Type C).
3. Copy the report files (.PDF), and paste to the PC.

Note: The path of the report files is: .\cnlaunch\CR IMMO\images\

4. Print the report from the printer connected to the PC.

B. Send reports to PC by email:

1. Click “Report” icon to enter the reports display screen.
2. Choose and enter the report which you will printing, enter the report detail page and tap Share button.
3. Select Email, and login your email account.
4. The report is attached to the email, send it to yourself, and download the attachment to the PC.
5. Print the report from the printer connected to the PC.

11 Personal Center

This function allows users to manage personal information and VCI.

11.1 VCI

This option allows you to manage all your activated VCI devices.

11.2 Activate VCI

This item lets you activate the VCI connector in case you ignore the Activate VCI step in process of the product sign-up.

11.3 Fix Connector Firmware

Use this item to upgrade and fix diagnostic firmware. During fixing, please do not cut power or switch to other interfaces.

11.4 Subscription Renewal Card

This item is used to check the status of the subscription renewal card.

11.5 Profile

Use this item to view and configure personal information.

11.6 Change Password

Use this item to change the password of the login account.

11.7 Diagnostic Software Clear

This item allows you to hide/clear the diagnostic software that is not frequently used.

 **Note:** Removing software may completely delete the software from the tool. If some software is not used and the tool runs out of space, you can use this feature to remove it.

11.8 Settings

It enables you to make some application settings and view software version information etc..

11.8.1 Units

It is designed to configure the measurement unit. Metric System and English System are available.

11.8.2 Shop information

This option lets you define your print information.

After inputting, tap **Save**. Once you saved the print information, it will be entered automatically in the "More Information" box every time you save the diagnostic report.

11.8.3 Clear cache

This option is used to set the mode, it contains host mode and device mode.

11.8.4 Mode Switch

It allows you to clear the App cache. Clearing the cache will restart the App.

11.8.5 About

The software version information and disclaimer are included.

11.8.6 Diagnostic software auto update

This option is used to set whether automatic update function is ON.

11.8.7 Login/Logout

To logout the current user ID, tap **Logout**.

To login the system again, tap **Login**.

Warranty

THIS WARRANTY IS EXPRESSLY LIMITED TO PERSONS WHO PURCHASE iCarsoft PRODUCTS FOR PURPOSES OF RESALE OR USE IN THE ORDINARY COURSE OF THE BUYER'S BUSINESS.

iCarsoft electronic product is warranted against defects in materials and workmanship for one year from the date of delivery to the user.

This warranty does not cover any part that has been abused, altered, used for a purpose other than for which it was intended, or used in a manner inconsistent with instructions regarding use. The exclusive remedy for any automotive meter found to be defective is repair or replacement, and iCarsoft shall not be liable for any consequential or incidental damages.

Final determination of defects shall be made by iCarsoft in accordance with procedures established by iCarsoft. No agent, employee, or representative of iCarsoft has any authority to bind iCarsoft to any affirmation, representation, or warranty concerning iCarsoft automotive meters, except as stated herein.

Disclaimer

The above warranty is in lieu of any other warranty, expressed or implied, including any warranty of merchantability or fitness for a particular purpose.

Purchase Order

Replaceable and optional parts can be ordered directly from your iCarsoft authorized tool supplier. Your order should include the following information:

- Order quantity
- Part number
- Part name

FCC Warning:

Any Changes or modifications not expressly approved by the party responsible for compliance could void the user's authority to operate the equipment.

This device complies with part 15 of the FCC Rules. Operation is subject to the following two conditions:

- (1) This device may not cause harmful interference.
- (2) this device must accept any interference received, including interference that may cause undesired operation.

Note: This equipment has been tested and found to comply with the limits for a Class B digital device, pursuant to part 15 of the FCC Rules. These limits are designed to provide reasonable protection against harmful interference in a residential installation. This equipment generates uses and can radiate radio frequency energy and, if not installed and used in accordance with the instructions, may cause harmful interference to radio communications. However, there is no guarantee that interference will not occur in a particular installation. If this equipment does cause harmful interference to radio or television reception, which can be determined by turning the equipment off and on, the user is encouraged to try to correct the interference by one or more of the following measures:

- Reorient or relocate the receiving antenna.
- Increase the separation between the equipment and receiver.
- Connect the equipment into an outlet on a circuit different from that to which the receiver is connected.
- Consult the dealer or an experienced radio/TV technician for help.

The device has been evaluated to meet general RF exposure requirement. The device can be used in portable exposure condition without restriction.

ISED Warning:

This device contains licence-exempt transmitter(s)/receiver(s) that comply with Innovation, Science and Economic Development Canada's licence-exempt RSS(s). Operation is subject to the following two conditions:

- (1) This device may not cause interference.
- (2) This device must accept any interference, including interference that may cause undesired operation of the device.

L'émetteur/récepteur exempt de licence contenu dans le présent appareil est conforme aux CNR d'Innovation, Sciences et Développement économique Canada applicables aux appareils radio exempts de licence. L'exploitation est autorisée aux deux conditions suivantes :

- 1) L'appareil ne doit pas produire de brouillage;
- 2) L'appareil doit accepter tout brouillage radioélectrique subi, même si le brouillage est susceptible d'en compromettre le fonctionnement.

This transmitter must not be co-located or operating in conjunction with any other antenna or transmitter. Cet émetteur ne doit pas être colocalisé ou fonctionner en conjonction avec

une autre antenne ou un autre émetteur.

The device has been evaluated to meet general RF exposure requirement. The device can be used in portable exposure condition without restriction.

Le matériel a été évalué pour répondre aux exigences générales d'exposition aux radiofréquences. Le dispositif peut être utilisé dans des conditions d'exposition portables illimitées.

Statement:

iCarsoft reserves the rights to make any change to product designs and specifications without notice. The actual object may differ a little from the descriptions in the manual in physical appearance, color and configuration. We have tried our best to make the descriptions and illustrations in the manual as accurate as possible, and defects are inevitable, if you have any question, please contact local dealer or after-sale service center of iCarsoft, iCarsoft does not bear any responsibility arising from misunderstandings.

Information sur les droits d'auteur

Droit d'auteur©2021 par Icarsoft Technology Inc. (également appelé iCarsoft en abrégé). Tous droits réservés. Aucune partie de cette publication ne peut être reproduite, stockée dans un système d'extraction ou transmise sous aucune forme ou par quelque moyen que ce soit, électronique, mécanique, par photocopie et enregistrement ou autrement, sans l'autorisation préalable écrite.

Déclaration: iCarsoft détient les droits de propriété intellectuelle complets pour le logiciel utilisé par ce produit. Pour toute action d'ingénierie inverse ou de piratage du logiciel, nous bloquerons l'utilisation de ce produit et nous nous réservons le droit de poursuivre leurs responsabilités juridiques.

Exclusion de garanties et limite de responsabilité

Toutes les informations, illustrations et spécifications contenues dans ce manuel sont basées sur les dernières informations disponibles au moment de la publication.

Nous nous réservons le droit d'apporter des changements à tout moment et sans préavis. Nous ne serons pas responsables des dommages directs, spéciaux, accessoires, indirects ou des dommages économiques consécutifs (y compris la perte de profits) dus à l'utilisation du document.

Précautions de sécurité importantes

Pour éviter des blessures corporelles, des dommages matériels ou des dommages accidentels au produit, lisez toutes les informations contenues dans cette section avant d'utiliser l'outil.

DANGER

- Lorsqu'un moteur fonctionne, gardez la zone de service bien ventilée ou fixez un système d'évacuation du bâtiment au système d'échappement du moteur. Les moteurs produisent divers composés toxiques (hydrocarbures, monoxyde de carbone, oxydes d'azote, etc.) qui entraînent un temps de réaction plus lent et entraînent la mort ou des blessures graves.
- Veuillez utiliser la batterie et l'adaptateur d'alimentation inclus. Risque d'explosion si la batterie est remplacée par un type incorrect.
- NE PAS essayer de faire fonctionner l'outil pendant la conduite du véhicule. Ayez le deuxième personnel faire fonctionner l'outil. car toute distraction pourrait causer un accident.

AVERTISSEMENT

- Toujours effectuer les tests de véhicules dans un environnement sécuritaire.
- Ne pas brancher ou débrancher tout équipement de test alors que le contact est mis ou que le moteur est en marche.
- Avant de démarrer le moteur, placez le levier de vitesses en position Neutre (pour transmission manuelle) ou dans la position Park (pour transmission automatique) pour éviter les blessures.
- NE JAMAIS fumer ou laisser une étincelle ou une flamme à proximité de la batterie ou du moteur. Ne faites pas fonctionner l'outil dans des atmosphères explosives, par exemple en présence de liquides inflammables, de gaz ou de poussières lourdes.
- Gardez un extincteur approprié à portée de main en cas d'incendie dû au carburant, produits chimiques ou circuits électriques.
- Porter de lunette étanche de sécurité lors des tests ou des réparations.
- Placez des cales devant les roues motrices et ne laissez jamais le véhicule sans surveillance pendant les essais.
- Soyez extrêmement prudent lorsque vous travaillez autour de la bobine d'allumage, du chapeau du distributeur, des câbles d'allumage et des bougies d'allumage. Ces composants créent des tensions dangereuses lorsque le moteur tourne.
- Pour éviter d'endommager l'outil ou de générer de fausses données, veillez à ce que la batterie du véhicule soit complètement chargée et que la connexion au DLC (connecteur de liaison de données) du véhicule soit claire et sécurisée.

- Les batteries automobiles contiennent de l'acide sulfurique nocif pour la peau. Pendant l'opération, éviter tout contact avec l'acide de la batterie. Gardez toujours les sources d'inflammation à l'écart de la batterie.
- Gardez l'outil sec, propre, exempt d'huile, d'eau ou de graisse. Utilisez un détergent doux sur un chiffon propre pour dégager l'extérieur de l'équipement si nécessaire.
- Gardez les vêtements, cheveux, mains, outils, équipement d'essai, etc. loin de toutes les pièces moteur chaudes ou mobiles.
- Rangez l'outil et les accessoires dans une zone verrouillée hors de la portée des enfants.
- N'utilisez pas l'outil lorsque vous êtes debout dans l'eau.
- N'exposez pas l'outil ou l'adaptateur secteur à la pluie ou aux conditions humides. L'eau entrant dans l'outil ou l'adaptateur secteur augmente le risque de choc électrique.
- Cet outil est une unité scellée. Il n'y a pas de pièces réparables pour l'utilisateur final à l'intérieur. Toutes les réparations internes doivent être effectuées par une installation de réparation autorisée ou un technicien qualifié. S'il y a n'importe quelle enquête, veuillez contacter le revendeur.
- Gardez l'outil loin des appareils magnétiques car ses radiations peuvent endommager l'écran et effacer les données stockées sur l'outil.
- Ne tentez pas de remplacer la batterie au lithium rechargeable interne. Contactez le concessionnaire pour le remplacement d'usine.
- Ne pas débrancher la batterie ou les fils de câblage du véhicule lorsque le contacteur d'allumage est mis à la position ON, pour éviter d'endommager les capteurs ou l'ECU.
- Ne pas placer d'objets magnétiques près de l'ECU. Débranchez l'alimentation électrique à l'ECU avant d'effectuer toute opération de soudage sur le véhicule.
- Faites preuve d'une extrême prudence lorsque vous effectuez des opérations à proximité de l'ECU ou des capteurs. Raccordez-vous à la terre lorsque vous démontez PROM, sinon ECU et capteurs peuvent être endommagés par l'électricité statique.
- Lorsque vous rebranchez le connecteur du faisceau ECU, assurez-vous qu'il est solidement attaché, autrement éléments électroniques, tels que les circuits intégrés à l'intérieur de l'ECU, peuvent être endommagés.

Table des matières

1 Contenu du pack.....	1
2 Vue d'ensemble.....	2
2.1 Introduction.....	2
2.2 Dongle VCI.....	4
2.3 IM2000 PRO.....	5
3 Utilisation initiale.....	6
3.1 Charge.....	6
3.2 Mise sous et hors tension.....	6
3.3 Opérations de base.....	6
3.4 Changer la langue du système.....	7
3.5 Configuration du réseau.....	7
3.6 Régler l'heure de veille.....	7
3.7 S'inscrire et télécharger le logiciel de diagnostic.....	7
4 Pour Commencer.....	9
4.1 Menu principal.....	9
4.2 Connexion.....	9
4.3 Configuration de la communication.....	10
5 Fonctionnements d'anti-démarrage.....	11
5.1 Correspondance anti-vol.....	11
5.2 Programmation IMMO.....	15
6 Diagnostiquer.....	29
6.1 VIN SCAN.....	29
6.2 Sélection manuelle.....	30
7 Entretien.....	35
8 Rétroaction.....	39
9 Mise à jour.....	39
10 Impression des rapports.....	40
11 Centre personnel.....	42

1 Contenu du pack

Cette liste est fournie à titre indicatif, suivant les revendeurs, le contenu du pack peut être différent. Contacter votre vendeur pour plus d'informations.

Numéro	Article	Descriptions	Qt.
1	CR IMMO	L'Unité principale	1
2	VCI	Dongle VCI	1
3	IM2000 PRO	Programmeur d'immobilisation	1
4	Extension d'OBD II Câble	Connecte le dongle VCI à la prise OBD du véhicule.	1
5	Câble USB	Type C à Type C, pour la charge.	1
6	Adaptateur d'alimentation	Pour charger la tablette.	1
7	Câble USB (Mini B)	Type A à Mini B, pour la communication entre la tablette et VCI	1
8	Adaptateur Non-16pin Kit de câble	Permet de vous connecter aux véhicules non-équipés d'une prise OBDII.	1
9	Allume-cigare Câble	Permet de recharger l'interface via la prise allume-cigare du véhicule.	1
10	Boîte d'adaptateur d'OBD I	Permet de vous connecter aux véhicules non-équipés d'une prise OBDII.	1
11	Câble de diagnostic principal	Connecte le dongle VCI, à la prise OBD de votre véhicule.	1
12	Adaptateur de puce	Placez la puce EEPROM sur l'adaptateur, puis branchez-la dans la prise du programmeur.	1
13	MCU_V1 PCBA	Connectez le programmeur avec MCU (la soudure à la puce est requise dans cette procédure).	1
14	MCU_V2 PCBA	Connectez le programmeur avec MCU (la soudure à la puce est requise dans cette procédure).	1
15	EEPROM PCBA	Souder la puce souhaitée sur le convertisseur EEPROM, puis brancher la carte dans le programmeur (la soudure de la puce est requise)	1
16	Clé-MB	Connectez le programmeur avec le verrou à clé, insérez la clé dans le programmeur pour d'autres opérations clés.	1

17	Câble INS V1	Connectez le programmeur et le tableau de bord du véhicule, puis placez la sonde (le plomb jaune) à la zone désignée.	1
18	Câble INS V2	Après avoir retiré le tableau de bord du véhicule, connectez le programmeur, le tableau de bord du véhicule et le câble.	1
19	MCU Câble V1	Pour connecter le programmeur et MCU.	1
20	Câble mode banc	Connectez le programmeur et le moteur pour lire l'ECU du moteur ou de la boîte de vitesses (Connectez l'ECU du moteur avec le câble du mode BANC basé sur le schéma du mode BANC).	1
21	Adaptation Adaptateur A	Pour connecter le câble de mode BANC et l'ECU de la boîte de vitesses/moteur.	5
22	Adaptation Adaptateur B	Pour connecter le câble de mode BANC et l'ECU de la boîte de vitesses/moteur.	6
23	Adaptation Adaptateur C	Pour connecter le câble de mode BANC et l'ECU de la boîte de vitesses/moteur.	7
24	Adaptation Adaptateur D	Pour connecter le câble de mode BANC et l'ECU de la boîte de vitesses/moteur.	8
25	Adaptation Adaptateur E	Pour connecter le câble de mode BANC et l'ECU de la boîte de vitesses/moteur.	6
26	Commutation Alimentation électrique	Alimentation électrique au programmeur.	1
27	Enveloppe de mot de passe	Comporte le Numéro de Série du produit et le code d'activation, qui est requis pour votre enregistrement.	1
28	Manuel d'utilisateur		1

2 Vue d'ensemble

2.1 Introduction

CR IMMO, développé par Icarsoft Technology Inc. est spécialement conçu comme un programmeur d'antidémarrage complet. Il peut fonctionner avec le dongle VCI (Interface de Communication du véhicule) pour effectuer un diagnostic complet du système de votre véhicule (y compris la lecture/suppression des codes défauts de diagnostic et la lecture de flux de données, etc.). Il peut également fonctionner avec l'IM2000 PRO pour effectuer des opérations de correspondance antivol et de programmation antivol.

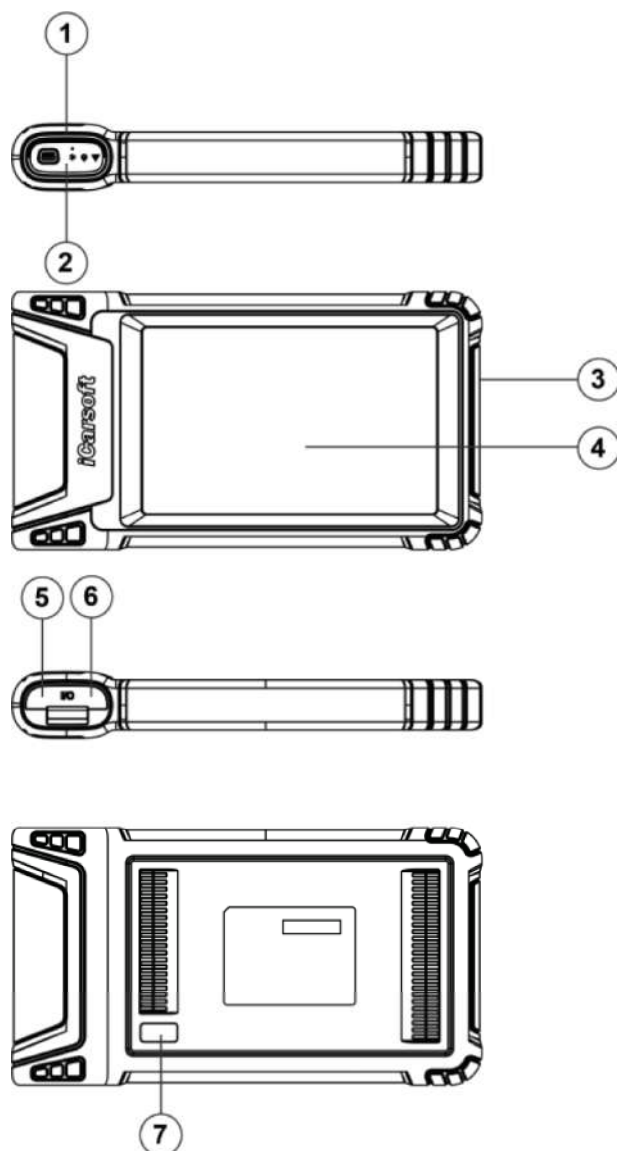

1. Emplacement d'amarrage pour dongle VCI-pour le logement de dongle VCI.
2. Dongle VCI - Il est pré-installé dans la fente d'accueil sur le dessus de la tablette d'affichage. Utilisez la main pour appuyer sur le dongle une fois, il sera automatiquement éjecté de la fente d'amarrage. Lorsqu'il n'est pas utilisé, veuillez le réinsérer dans la fente pour éviter toute perte.
3. Touche d'alimentation- Appuyez dessus pour allumer/éteindre l'outil.
4. Écran LCD-Indique les résultats du test.
5. Port USB Type C-Connectez un chargeur pour le chargement ou la transmission de données.
6. Port USB Type A-Connectez la tablette au dongle VCI via un câble de données.
7. Caméra arrière

Paramètres techniques

- CPU: 4 cœurs 1.8GHz
- Mémoire: 4GB
- ROM (Mémoire à lire seulement): 64GB
- Taille de l'écran: 8 pouces

- Résolution: 1280*800 pixel
- Caméra: Caméra arrière 8MP
- Tension de travail: 5V
- Courant de travail: ≤3A
- Environnement de travail: 0°C ~45°C
- Environnement de stockage: -10°C ~60°C

2.2 Dongle VCI

Ce dongle fonctionne comme un dispositif VCI (Interface de communication du véhicule). Il est utilisé pour obtenir les données du véhicule, puis l'envoyer à la tablette pour analyse via Bluetooth.

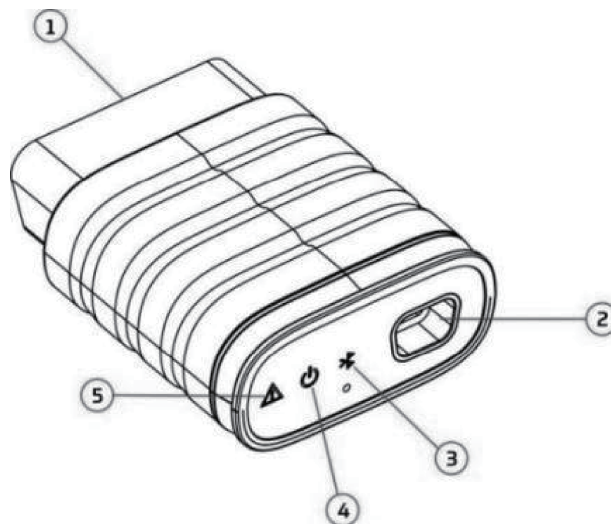

1. Connecteur de diagnostic OBD-II-Connecte le câble d'extension OBD-II ou branchez directement sur la prise OBDII du véhicule.
2. Port de transmission de données-Se connecte à la tablette d'affichage via un câble de données pour effectuer le diagnostic du véhicule.
3. Communication LED-II s'allume et continue de clignoter lorsque le dongle VCI communique avec la tablette.
4. LED d'alimentation-II s'allume lorsqu'il est mis sous tension.
5. Erreur LED-II s'allume en cas de panne de communication.

Paramètres techniques

- Tension de travail: 12V
- Courant de travail: ≤60mA
- Environnement de travail: 0°C ~50°C
- Environnement de stockage: -10°C ~60°C

2.3 IM2000 PRO

L'IM2000 PRO fonctionne comme un programmeur d'antidémarrage antivol dédié. Il doit fonctionner avec la tablette d'affichage pour effectuer les opérations de correspondance IMMO (pour certains véhicules) et de programmation IMMO.

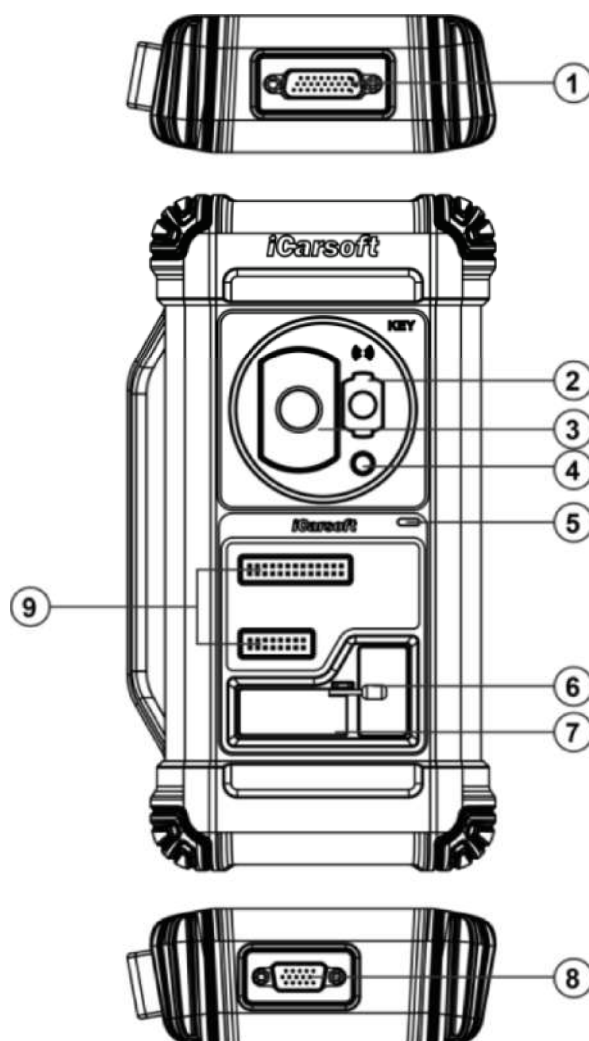

1. Connecteur de diagnostic DB26-Se connecte au collecteur infrarouge Mercedes Benz, au câble ECU et au câble MCU etc.
2. Fente de clé infrarouge Mercedes Benz-Contient la clé Mercedes Benz.
3. Fente de clé de véhicule-Contient la clé de voiture pour la détection RF.
4. Fente de transpondeur-Maintient le transpondeur (puce de clé).
5. LED d'alimentation-La lumière rouge indique des défauts. La lumière orange indique les fonctions normalement.
6. Valve-Serrez/desserrez la carte EEPROM
7. Emplacement du transpondeur EEPROM-Maintient le transpondeur enfichable EEPROM ou la prise EEPROM
8. Connecteur de diagnostic DB15-Se connecte au câble de diagnostic principal.
9. Broches de signalisation croisée-Maintient le câble de rechange MCU ou le câble de signal de bricolage du véhicule pour lire ou écrire des puces MCU et ECU.

Paramètres techniques

- Tension d'entrée: 12 V
- Courant d'entrée: 500mA
- Environnement de travail: 0°C ~50°C
- Environnement de stockage: -20°C ~70°C

3 Utilisation initiale

3.1 Charge

Suivez les étapes ci-dessous pour charger la tablette:

1. Connectez une extrémité du câble de charge à la prise USB de l'adaptateur secteur.
2. Connectez l'autre extrémité au port de charge situé au bas de l'hôte.
3. Branchez la fiche d'alimentation du chargeur sur une prise de courant.

⚠ Attention: Veuillez utiliser l'adaptateur secteur inclus pour charger votre outil. Aucune responsabilité ne peut être assumée pour tout dommage ou perte résultant de l'utilisation d'adaptateurs secteur autres que celui fourni.

📝 Remarque: Si la batterie reste inutilisée pendant une longue période ou si la batterie est complètement déchargée, il est normal que l'outil ne s'allume pas pendant la charge. Veuillez le charger pendant 5 minutes, puis allumez-le.

3.2 Mise sous et hors tension

Appuyez longuement sur le bouton POWER, puis l'interface de démarrage apparaîtra.

Appuyez longuement sur le bouton POWER jusqu'à ce que la boîte de dialogue apparaisse et appuyez sur **Arrêt** pour l'éteindre ou appuyez sur **Redémarrer** pour le redémarrer.

3.3 Opérations de base



Simple clic: Pour sélectionner un élément ou lancer un programme.



Clic double: Pour effectuer un zoom avant, ou pour que l'affichage du texte s'adapte à votre écran



Longue pression: Appuyez et maintenez le logiciel du véhicule souhaité pour le supprimer.



Coulisser: Pour accéder à des pages différentes.

Balayer depuis le bord droit de l'écran: Retour à l'écran

précédent ou aux sorties.

3.4 Changer la langue du système

L'outil prend en charge plusieurs langues. Pour changer la langue de l'outil, veuillez procéder comme suit:

1. Sur l'écran d'accueil, appuyez sur **Paramètres-> Système-> Langue et entrée-> Langues**.
2. Appuyez sur **Ajouter une langue**, puis choisissez la langue souhaitée dans la liste.
3. Appuyez et maintenez la langue souhaitée et faites-la glisser vers le haut de l'écran, puis relâchez-la, elle se transformera en langue cible.

3.5 Configuration du réseau

L'outil dispose d'un Wi-Fi intégré qui peut être utilisé pour se connecter. Une fois que vous êtes en ligne, vous pouvez enregistrer votre outil, surfer sur Internet, envoyer des e-mails, lancer le diagnostic à distance, et vérifier les mises à jour logicielles, etc.

1. Sur l'écran d'accueil, appuyez sur **Paramètres-> Réseau et Internet -> Wi-Fi**.
2. Faites glisser le commutateur Wi-Fi vers ON, l'outil commence à rechercher les réseaux sans fil disponibles.
3. Sélectionnez un réseau sans fil pour se connecter. Lorsque **Connecté** apparaît, cela indique que la connexion Wi-Fi est terminée.

 Remarque: Lorsque le Wi-Fi n'est pas nécessaire, celui-ci doit être désactivé pour économiser la batterie.

3.6 Régler l'heure de veille

Si aucune activité n'est effectuée dans la période de veille définie, l'écran sera Verrouillé automatiquement et le système entre en mode veille pour économiser l'énergie.

1. Dans le menu, appuyez sur **Paramètres-> Affichage-> Avancé-> Expiration de l'écran**.
2. Choisissez la durée de sommeil désirée.

3.7 S'inscrire et télécharger le logiciel de diagnostic

Appuyez sur **Login** dans le coin supérieur droit du menu, la fenêtre de connexion suivante apparaîtra sur l'écran.

A. Si vous êtes un nouvel utilisateur, appuyez sur **Nouvel enregistrement** et suivez les instructions à l'écran pour terminer l'inscription.

1. Créer un compte App: Remplissez les informations dans chaque champ (les éléments avec * doivent être remplis). Après la saisie, appuyez sur **S'inscrire**.
2. Activer VCI: Saisissez le numéro de série de produit à 12 chiffres et le code d'activation à 8 chiffres (peut être obtenu à partir de l'enveloppe de mot de passe), puis appuyez sur **Activer**.

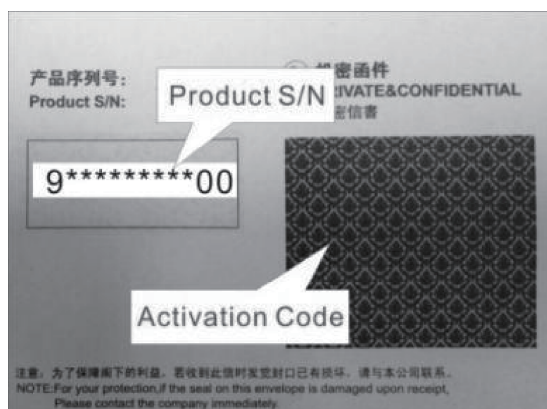

3. Télécharger le logiciel de diagnostic: Appuyez sur **OK** pour entrer dans le centre de mise à jour pour télécharger tous les logiciels disponibles.

B. Si vous vous êtes inscrit pour devenir membre, entrez votre nom et votre mot de passe, puis appuyez sur **Connexion** pour entrer directement dans l'écran du menu principal.

 **Remarque:** L'outil a une fonction de sauvegarde automatique. Une fois que le nom d'utilisateur et le mot de passe sont correctement saisis, le système le stockera automatiquement. La prochaine fois que vous vous connecterez au système, il ne vous sera pas demandé de saisir le compte manuellement.

C. Si vous avez oublié le mot de passe, appuyez sur **Récupérer le mot de passe**, puis suivez les instructions à l'écran pour définir un nouveau mot de passe.

4 Pour Commencer

4.1 Menu principal

Il comprend principalement les éléments suivants:

Adaptation IMMO	Cette fonction vous permet d'effectuer la fonction d'appariement de la clé antivol, de sorte que le système de contrôle antidémarrage sur la voiture identifie et autorise les clés de contrôle à distance pour normalement utiliser la voiture.
Programmation IMMO	<ul style="list-style-type: none"> • Lisez les données du transpondeur (y compris la clé intelligente infrarouge Mercedes Benz) et générez des clés exclusives. • Lisez/écrivez les données de la puce EEPROM à bord et lisez/écrivez les données de la puce MCU/ECU. • Lisez/écrivez les données du transpondeur à distance et détectez la fréquence des clés.
Diagnostiquer	Ce module vous permet d'atteindre rapidement le modèle de voiture et d'effectuer le diagnostic complet du véhicule.
Maintenance	Effectuez des services de réparation et de maintenance couramment utilisés.
Mise à jour	Met à jour le logiciel de diagnostic du véhicule et l'APK.
Rétroaction	Réfléchis aux problèmes de diagnostic ou aux bugs pour l'analyse et le dépannage.
Autres	Comprend les rapports, paramètres, centre personnel, mise à jour système OTA, QS Teamviewer, navigateur, fichiers, explorateur, appareil photo, galerie et e-mail, etc.

4.2 Connexion

4.2.1 Préparation

Conditions d'essai normales

- Activez l'alimentation électrique du véhicule.
- La plage de tension de la batterie du véhicule devrait être de 9 à 18V.
- Le papillon doit être mis en position fermée.
- Trouvez l'emplacement de la prise OBD.
(« On-Board Diagnostic », système de diagnostic embarqué, également appelé DLC) est généralement située à 12 pouces du centre du tableau de bord, sous ou autour du côté conducteur pour la plupart des véhicules. Pour certains véhicules avec des conceptions spéciales, l'emplacement de la prise OBD peut varier.

Si la prise OBD ne peut pas être trouvée, se référer au manuel d'entretien du véhicule pour l'emplacement.

4.2.2 Connexion du véhicule

Suivez les étapes mentionnées ci-dessous pour connecter le véhicule en OBDII :

1. Localisez la prise OBD du véhicule.
2. Branchez le dongle VCI dans la prise OBD du véhicule (il est suggéré d'utiliser le câble d'extension OBDII pour connecter le dongle VCI et la prise OBD).

Pour le véhicule non-équipés d'une prise OBDII, procédez comme suit :

1. Sélectionnez l'adaptateur correspondant en fonction du type de prise de votre véhicule.
2. Branchez l'extrémité non-16pin du câble adaptateur dans la prise OBD du véhicule, puis connectez l'autre extrémité à l'adaptateur OBD I, puis serrez les vis captives.
3. Connectez l'autre extrémité de l'adaptateur OBD I au câble de diagnostic.



Remarque: Si les broches de la prise OBD sont endommagées ou si la prise OBD a une puissance insuffisante, vous pouvez obtenir de la puissance via le câble allume-cigare : Branchez une extrémité du câble au réceptacle d'allume-cigare du véhicule et l'autre extrémité au port CC de l'adaptateur OBD I.

4.3 Configuration de la communication

Il y a 2 façons disponibles pour que la tablette communique avec le dongle VCI: Communication BlueTooth (sans fil) et connexion par câble USB. L'utilisateur peut choisir l'une des façons suivantes pour établir la communication.

4.3.1 Appariement via la communication sans fil (BT)

Une fois l'inscription terminée avec succès, la communication Bluetooth entre la tablette et le dongle VCI est automatiquement établie et l'utilisateur n'a pas besoin de le configurer à nouveau.

4.3.2 Connexion câble USB

1. Connectez une extrémité du câble de données (en option) au port de transmission de données du dongle VCI.
2. Connectez l'autre extrémité à la fente d'extension USB de la tablette. La LED d'alimentation du dongle VCI s'allumera.



Remarque: La connexion USB fournit la communication la plus stable et la plus rapide. Lorsque les deux méthodes de communication sont appliquées en même temps, la tablette utilisera la communication USB comme priorité par défaut.

5 Fonctionnements d'anti-démarrage

5.1 Correspondance anti-vol

Cette fonction vous permet d'effectuer la fonction d'appariement de la clé antivol, de sorte que le système de contrôle antidémarrage sur la voiture identifie et autorise les clés de contrôle à distance pour normalement utiliser la voiture.

5.1.1 Connexion du véhicule

1. Pour la plupart des véhicules, utilisez simplement le câble d'extension OBD II inclus pour connecter le VCI à la prise OBD du véhicule.
2. Pour les autres véhicules (y compris, mais sans s'y limiter, les Mercedes Benz, Volkswagen, BMW et Porsche), l'IM2000 PRO et le câble de diagnostic principal sont nécessaires.

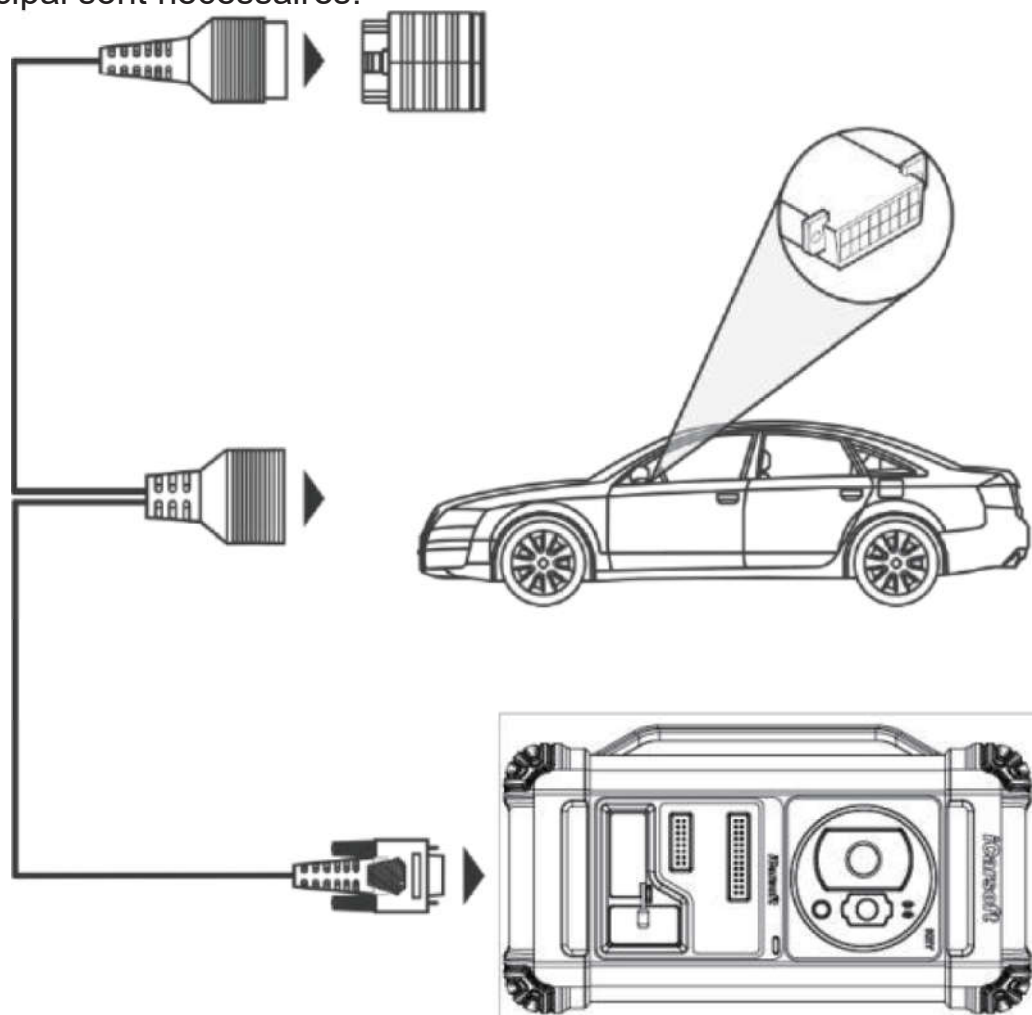

5.1.2 Opérations d'antidémarrage

Ici, nous prenons la BMW par exemple pour montrer comment exécuter les fonctions d'ajout de clé et tout perdu pour le module système antivol BMW CAS4/CAS4.

1. Appuyez sur **Adaptation IMMO** et sélectionnez BMW pour entrer dans le logiciel.

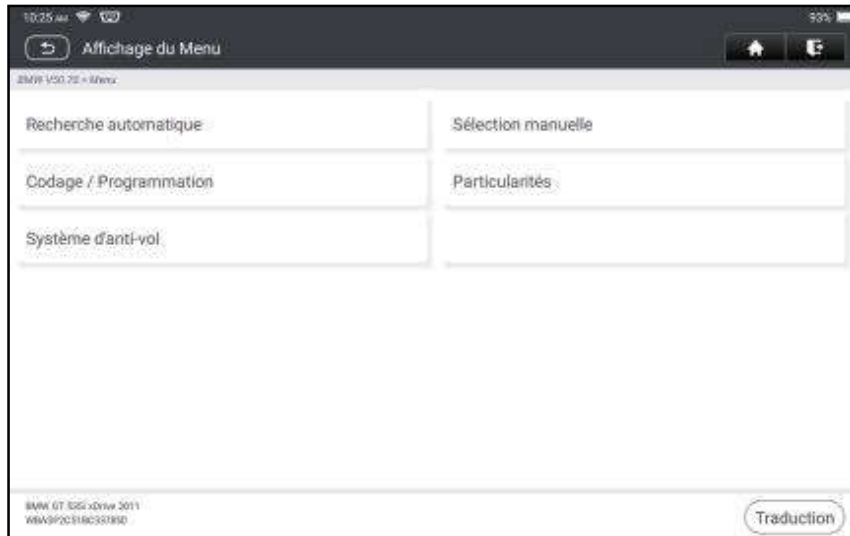

2. Appuyez sur **OK**.

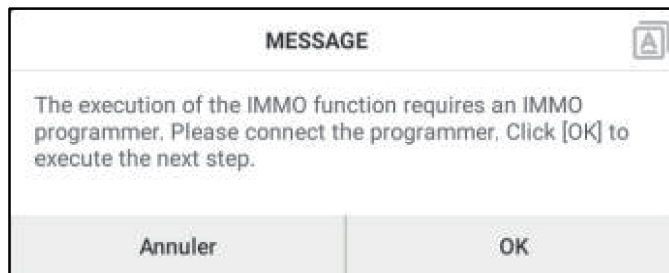

3. Entrez dans le système antivol, suivez l'illustration ci-dessous pour connecter le dongle VCI, le véhicule et IM2000 PRO pour effectuer l'étape suivante.

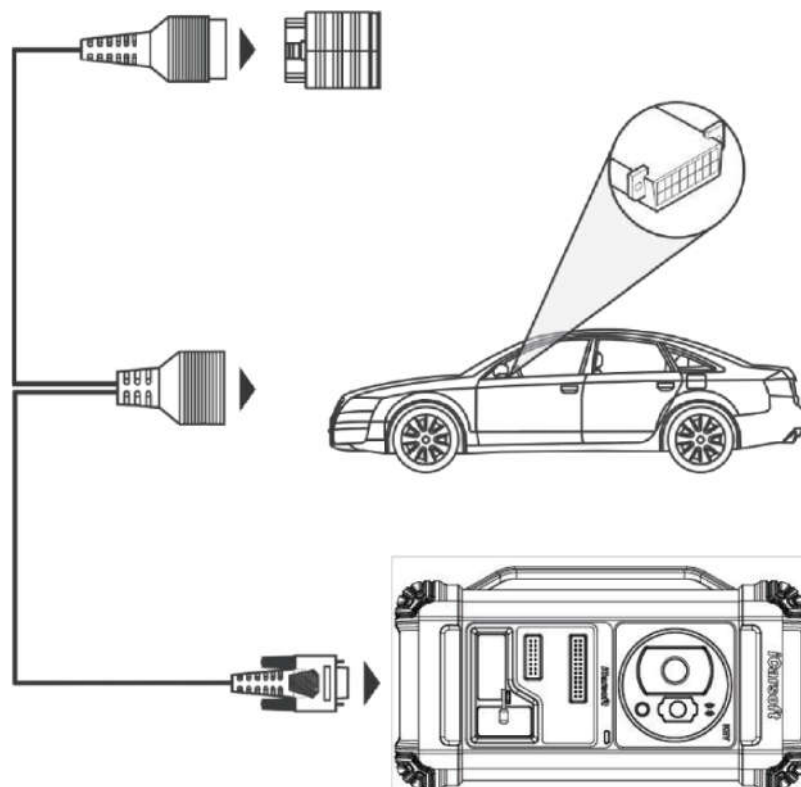

4. Si vous ne connaissez pas le type du système antivol, appuyez sur **Mode intelligent** pour entrer.

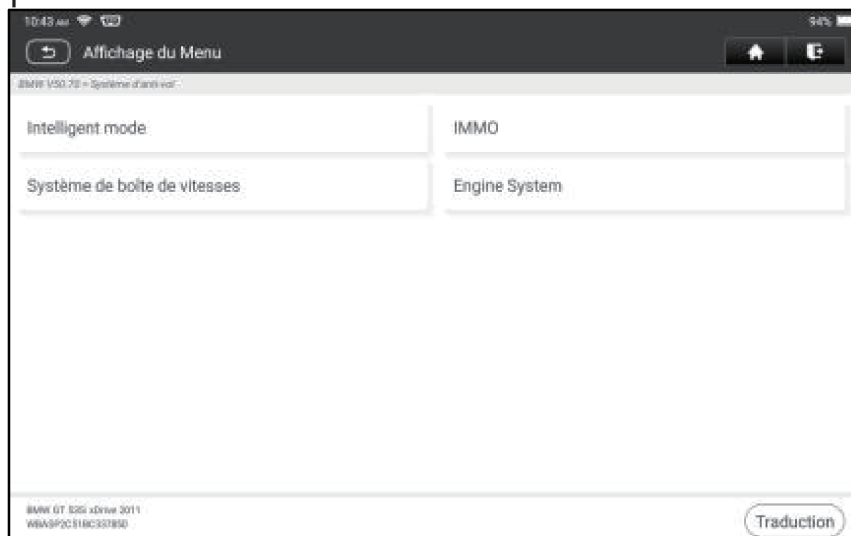

5. Appuyez sur **Système antivol CAS4/CAS4**, l'écran suivant apparaîtra:

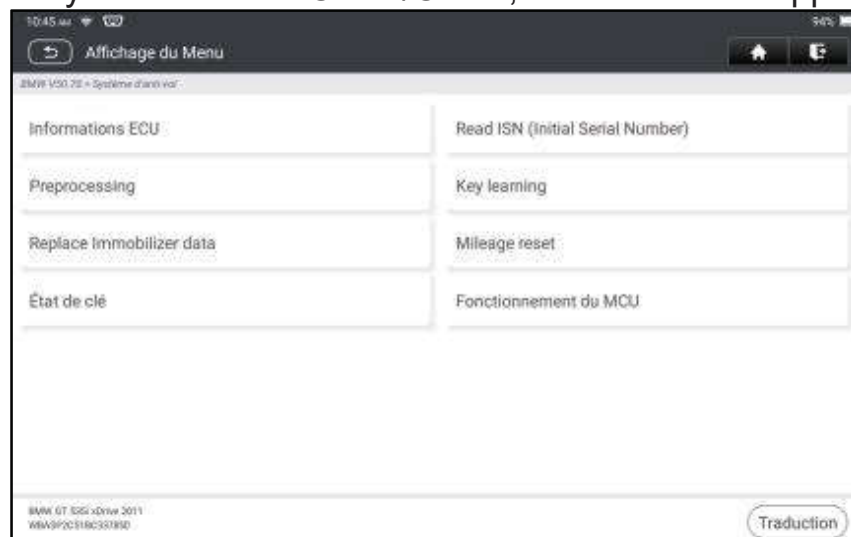

6. Appuyez sur **Prétraitement** pour effectuer la lecture des données antivol, la correspondance des clés et plus encore. S'il a déjà été prétraité, vous pouvez ici effectuer les fonctions pertinentes. L'ECU sera mis à niveau dans ce processus et les fichiers doivent être téléchargés en ligne.

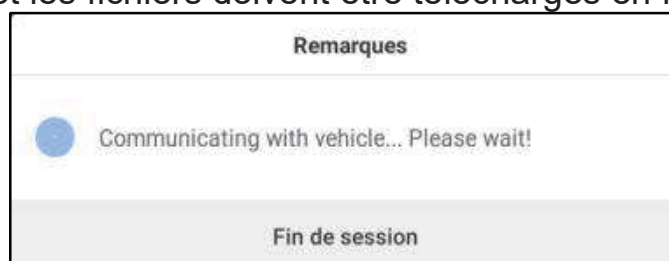

7. Assurez-vous que la tension d'alimentation électrique du véhicule n'est pas inférieure à 13V et stable, puis appuyez sur **Oui** pour commencer le prétraitement.
8. Après le prétraitement réussi, appuyez sur **OK**.

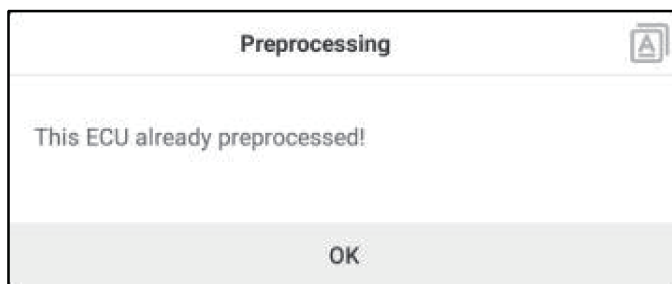

9. Revenez au menu des fonctions et appuyez sur **Apprentissage des clés**.

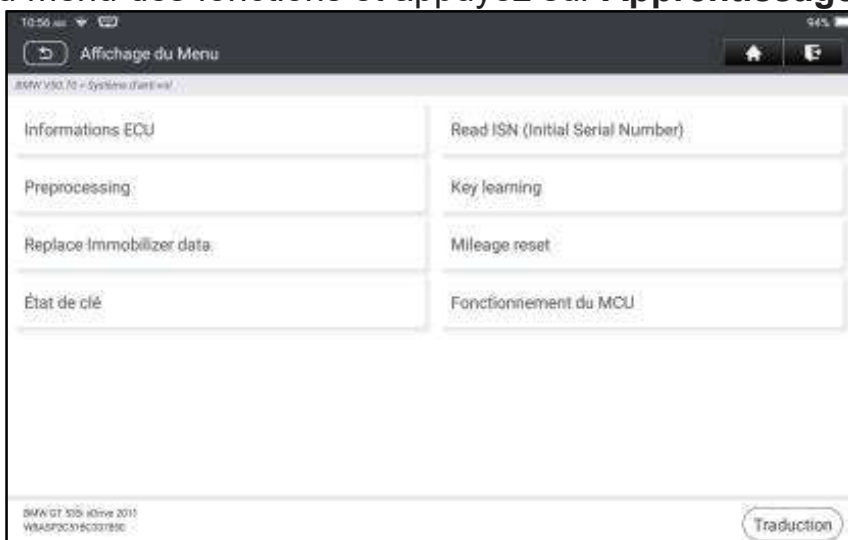

10. Une fois les informations clés lues avec succès, sélectionnez la position clé inutilisée et appuyez sur **Clé générée par le commutateur d'allumage**.

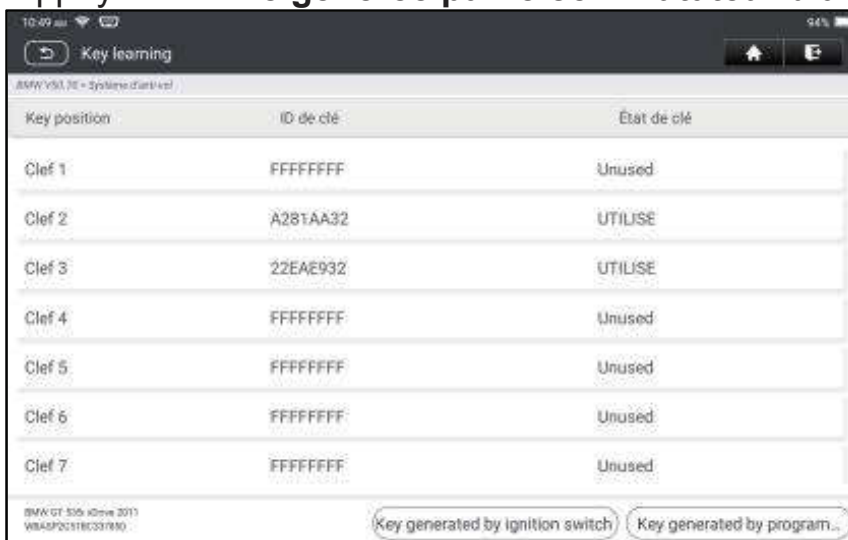

11. Lisez et affichez le mot de passe, et appuyez sur **OK**.

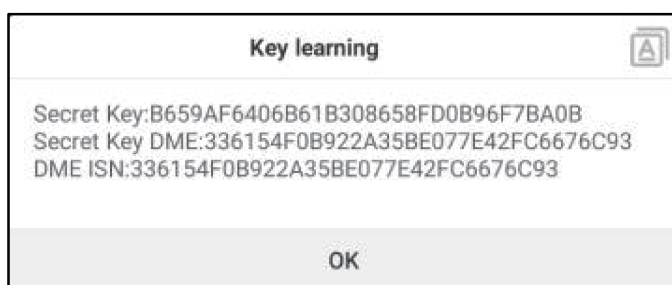

FR

12. Placez une nouvelle clé à proximité de la bobine du véhicule, appuyez sur **OK** et attendez que la clé génère.

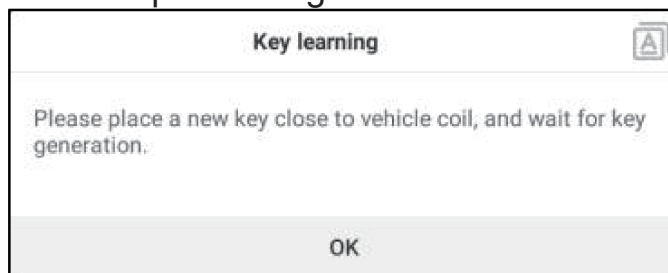

13. Une fois la clé du concessionnaire générée avec succès, veuillez essayer de démarrer le véhicule.

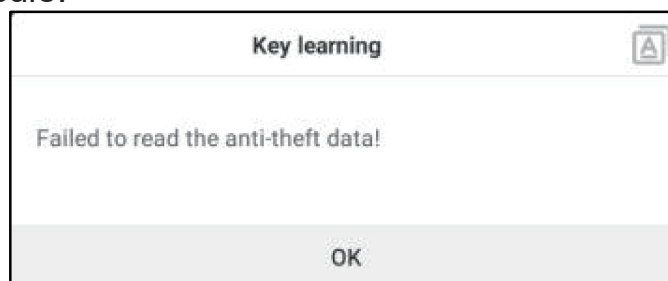

14. Maintenant, la correspondance des clés est terminée et la nouvelle clé est prête à l'emploi.

5.2 Programmation IMMO

L'IM2000 PRO est requis lors de l'exécution de cette opération. Il a les fonctions suivantes:

- Lisez les données du transpondeur (y compris la clé intelligente infrarouge Mercedes Benz) et générez des clés exclusives.
 - Lisez/écrivez les données de la puce EEPROM à bord et lisez/écrivez les données de la puce MCU/ECU.
 - Lisez/écrivez les données du transpondeur à distance et détectez la fréquence des clés.
1. Avant d'effectuer cette fonction, assurez-vous que les connexions suivantes sont correctement effectuées.

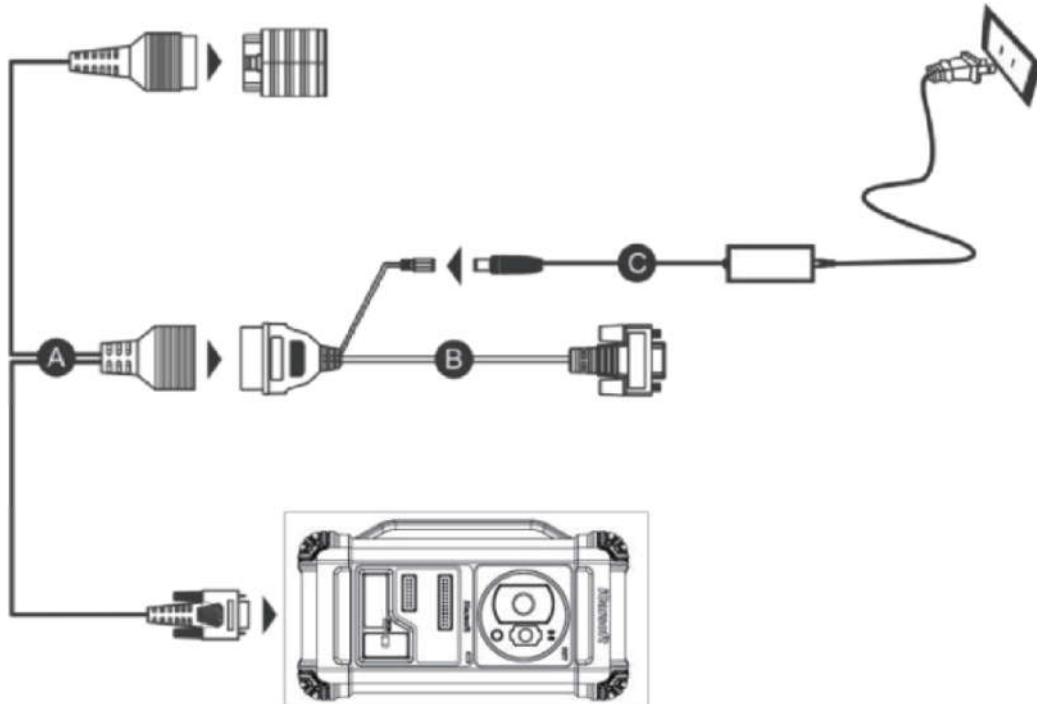

A. Câble de diagnostic principal

B. Adaptateur OBD I

C. Commutation de l'alimentation électrique de l'IM2000 PRO

Remarques:

- Il vous est suggéré de connecter le dongle VCI illustré dans le diagramme ci-dessous à la tablette via le câble USB. L'utilisation d'un câble USB pourrait améliorer efficacement votre vitesse de transmission de données.
- La programmation IMMO ne nécessite pas de connexion au véhicule. Pour s'assurer que l'IM2000 PRO fonctionne correctement, utilisez **UNIQUEMENT** la commutation de l'alimentation électrique et l'adaptateur OBD I pour alimenter l'IM2000 PRO. L'obtention de l'alimentation via une connexion à la prise d'alimentation CC de l'IM2000 PRO via la commutation de l'alimentation électrique seule est défectueuse.

2. Appuyez sur **Programmation IMMO** pour entrer dans l'écran suivant.