

User Manual

Version 7.0 2021/04

ECHTES-156

ECHELON TOUCH SCREEN



About This Document

No part of this publication may be reproduced, transmitted, transcribed, stored in a retrieval system, or translated into any language or computer language, in any form or by any means, including, but not limited to, electronic, magnetic, optical, chemical, manual, or otherwise without prior written permission of Echelon Fitness Multimedia LLC.

The information in this document is subject to change without notice. Echelon makes no representations or warranties with respect to the contents herein, and specifically disclaims any implied warranties of merchantability or fitness for a particular purpose. Echelon reserves the right to revise this publication and to make changes from time to time in the content hereof without obligation of Echelon to notify any person of such revisions or changes. Windows is a registered trademark of Microsoft, Inc. Other brand or product names are trademarks of their respective holders.

Compliance Information

For FCC (USA)

Caution: The user is cautioned that changes or modifications not expressly approved by the party responsible for compliance could void the user's authority to operate the equipment.

This device complies with Part 15 of the FCC Rules and Industry Canada licence-exempt RSS standard(s). Operation is subject to the following two conditions: (1) this device may not cause harmful interference, and (2) this device must accept any interference received, including interference that may cause undesired operation.

Le présent appareil est conforme aux CNR d'Industrie Canada applicables aux appareils radio exempts de licence. L'exploitation est autorisée aux deux conditions suivantes :

- (1) l'appareil ne doit pas produire de brouillage, et
- (2) l'utilisateur de l'appareil doit accepter tout brouillage radioélectrique subi, même si le brouillage est susceptible d'en compromettre le fonctionnement.

NOTE: This equipment has been tested and found to comply with the limits for a Class B digital device, pursuant to Part 15 of the FCC Rules. These limits are designed to provide reasonable protection against harmful interference in a residential installation. This equipment generates, uses and can radiate radio frequency energy and, if not installed and used in accordance with the instructions, may cause harmful interference to radio communications. However, there is no guarantee that interference will not occur in a particular installation.

If this equipment does cause harmful interference to radio or television reception, which can be determined by turning the equipment off and on, the user is encouraged to try to correct the interference by one or more of the following measures:

- Reorient or relocate the receiving antenna.
- Increase the separation between the equipment and receiver.
- Connect the equipment into an outlet on a circuit different from that to which the receiver is connected.
- Consult the dealer or an experienced radio/TV technician for help.

FCC & IC Radiation Exposure Statement:

This equipment complies with FCC and Canada radiation exposure limits set forth for an uncontrolled environment. This equipment should be installed and operated with a minimum distance of 10 mm between the radiator and your body.

This transmitter must not be co-located or operating in conjunction with any other antenna or transmitter.

Déclaration d'IC sur l'exposition aux radiations:

Cet équipement est conforme aux limites d'exposition aux radiations définies par le Canada pour des environnements non contrôlés. Cet équipement doit être installé et utilisé à une distance minimum de 10 mm entre l'antenne et votre corps.

Cet émetteur ne doit pas être installé au même endroit ni utilisé avec une autre antenne ou un autre émetteur.

the device for operation in the band 5150–5250 MHz is only for indoor use to reduce the potential for harmful interference to co-channel mobile satellite systems;

le dispositif utilisé dans la bande 5150-5250 MHz est réservé à une utilisation en intérieur afin de réduire le risque de brouillage préjudiciable aux systèmes mobiles par satellite dans le même canal;

For IC (Canada)

CAN ICES-3(B)/NMB-3(B)

For CE (EU)

The device complies with the EMC Directive 2014/30/EU and Low Voltage Directive 2014/35/EU

Renseignements relatifs à la conformité

Pour la FCC (États-Unis).

Ce matériel a fait l'objet d'essais qui ont déterminé qu'il respectait les limites d'un appareil de classe B selon la partie 15 des règlements de la FCC. Ces limites sont établies pour assurer une protection raisonnable contre les parasites nuisant à une installation résidentielle. Ce matériel génère, utilise et peut émettre des ondes radio électriques, et lorsqu'il n'est pas installé et utilisé selon les instructions, peut causer des parasites nuisant aux communications radio. Il n'y a toutefois aucune garantie qu'il n'y aura pas de parasites dans une installation en particulier. Si ce matériel cause des parasites à la réception d'ondes radio ou de télévision, ce qui peut être déterminé en l'éteignant et en l'allumant, l'utilisateur est invité à essayer de corriger le problème des parasites par l'une ou l'autre des mesures suivantes :

- Réorienter ou déplacer l'antenne de réception.
- Augmenter la distance entre le matériel et la réception.
- Brancher le matériel dans une prise sur un autre circuit que celui où le récepteur est branché.
- Consulter le distributeur ou un technicien radio ou TV expérimenté pour des conseils.

L'appareil respecte la partie 15 des règlements de la FCC. Le fonctionnement doit respecter les deux conditions suivantes : 1) cet appareil ne doit pas causer de parasites et (2) cet appareil doit accepter tous les parasites reçus, notamment ceux pouvant causer un fonctionnement non voulu.





Pour Industrie Canada

Norme canadienne NMB-3(B)

Pour la CE (UE)

L'appareil respecte la directive 2014/30/UE relative à la compatibilité électromagnétique et la directive 2014/35/EU sur les limites de basse tension

Usage Notice

-  **Warning - To prevent the risk of fire or shock hazards, and do not expose the product to moisture.**
-  **Warning - Please do not open or disassemble the product as this may cause electric shock.**
-  **Warning - Power cord shall be connected to a socket-outlet with earthing connection.**
-  **Warning - The cable cover cannot be removed under normal use conditions.**
-  **Warning - Stability Hazard. The touch monitor may fall, causing serious personal injury or death. To prevent injury, this touch monitor must be securely attached to the wall in accordance with the installation instructions.**

Precautions

Please follow all warnings, precautions and maintenance as recommended in this user's manual to maximize the life of your unit.

Do :

- Turn off the product before cleaning.
- Use a soft cloth moistened with mild detergent to clean the product housing.
- Use only the qualified power adapter that comes with your device.
- Disconnect the power plug from AC outlet if the product is not going to be used for an extended period of time.

Don't :

- Do not use abrasive cleaners, waxes or solvents for your cleaning.
- Do not operate the product under the following conditions:
 - Extremely hot, cold or humid environment.
 - Areas susceptible to excessive dust and dirt.
 - Near any appliance generating a strong magnetic field.

Caution

Risk of explosion if battery is replaced by an incorrect type. Dispose of used batteries according to the instructions.

Avis d'utilisation



Mise en garde — Pour prévenir les risques d'incendie ou d'électrocution, ne pas exposer le produit à l'humidité.



Mise en garde — Prière de ne pas ouvrir ou démonter le produit, car cela pourrait entraîner l'électrocution.



Mise en garde – Le cordon d'alimentation doit être branché à une prise pourvue d'une mise à la terre.



Mise en garde – La gaine du câble ne doit pas être retirée en conditions normales d'utilisation.



Mise en garde — Risque de renversement. Le moniteur tactile peut se renverser et causer de graves blessures corporelles, voire la mort. Pour prévenir les blessures, ce moniteur tactile doit être solidement fixé au mur selon les instructions d'installation.

Précautions

Veillez suivre toutes les mises en garde, précautions et entretiens recommandés dans ce manuel d'utilisation pour maximiser la durée de vie de votre unité.

À faire :

- Éteindre l'appareil avant de le nettoyer.
- Utiliser un chiffon humidifié par une solution savonneuse pour nettoyer le boîtier du produit.
- Utiliser uniquement l'adaptateur d'alimentation prescrit pour votre appareil.
- Débrancher l'appareil lorsqu'il n'est pas utilisé pendant une période prolongée.

À éviter :

- Ne pas utiliser de nettoyeurs abrasifs, de cires ou de solvants pour le nettoyage
- Ne jamais utiliser l'appareil dans les conditions suivantes :
 - des conditions environnementales extrêmes (chaud, froid ou humidité)
 - des endroits remplis de poussières et de saletés.
 - à proximité d'appareils produisant un fort champ magnétique.

Mise en garde

Risque d'explosion si la batterie est remplacée par un type incorrect. Jetez les piles usagées conformément aux instructions.

Table of Contents

Chapter 1	7
1.1 Overview	8
1.2 Feature.....	8
1.3 Specifications.....	8
1.4 Block Diagram.....	10
1.5 Interface Connectors.....	11
1.6 Package Overview	13
Chapter 2	14
2.1 About VESA Mount.....	15
2.2 Power On / Off	17
2.3 Dimension	18
Appendix	19
Declaration of the Presence Condition of the Restricted Substances Marking	20

Chapter 1

Product Introduction

1.1 Overview

The ECHTES-156 is a thinner 15.6" touch computer that offers a unique screw less design with expandability and flexibility, making expansion and accessory installation much easier. The versatility of ECHTES-156 is an exceptional choice for applications in all fitness sectors.

1.2 Feature

- Support Rock chip RK3288 processor.
- Support Wi-Fi 802.11ac 2T2R & BT5.0 1T1R.
- Support 5MP FF camera.
- Support Screen rotation.
- Unique screw less design for better user experience.
- Patented I/O design for better wiring management while implementation.

1.3 Specifications

System	
CPU	Rock chip RK3288, Quad-core Cortex-A17 up to 1.8GHz
GPU	Mali-T760 MP4
Memory	4GB dual channel LPDDR3
Storage	16GB eMMC
Input Power	DC in 12V/4A 2PIN
Display	2lane eDP, resolution up to 1920x1080P60
Touch	15.6inch P-Cap touch sensor , supports 10 fingers touch function.
Audio	2 x speaker (5W x 2)
G-sensor	3-axis
Network	Gigabit Ethernet Wi-Fi 802.11a/b/g/n/ac, 2T2R

	Bluetooth 5.0 (Support BLE) 1T1R
External IO Ports	1 x LAN (Support 10/100/1000Mbps) 1 x TF slot (Support SDHC 2.0) 1 x Recovery key 1 x HDMI (Support 1080P@60Hz) 2 x USB2.0 Type-A (1 x HOST, 1 x OTG) 2 x 3.5mm earphone jack (Only one can be used at the same time) 1 x 12V DC In 1 x 12V DC out (12V/1A) 1 x Power button, 1 x vol -, 1 x vol +
OS Version	Android 9.0
Operation Temp	0°C~40°C
Storage Temp.	-20°C to 60°C
Operation Humidity	20~80%, Non-Condensing
Storage Humidity	10~90%, Non-Condensing
LCD Touch Panel	
Size	15.6" TFT LCD
Brightness (non-touch screen)	Typical 250 cd/m ² ; min. 200 cd/m ²
Brightness (P-CAP)	Typical 225 cd/m ² ; min. 180 cd/m ²
Number of Pixels	1920 (H) × 1080 (V)/ 60Hz
Environment	
Certificate	CE、FCC、IC、LVD、UL、UKCA、RF、NOM、RCM、ANATEL
Mounting	VESA 100 mm x 100 mm
Dimension (W x H x D)	375.40 mm x 271.70 mm x 45.92 mm
Net Weight	1.8 Kg
Gross Weight	2.85 Kg

1.4 Block Diagram

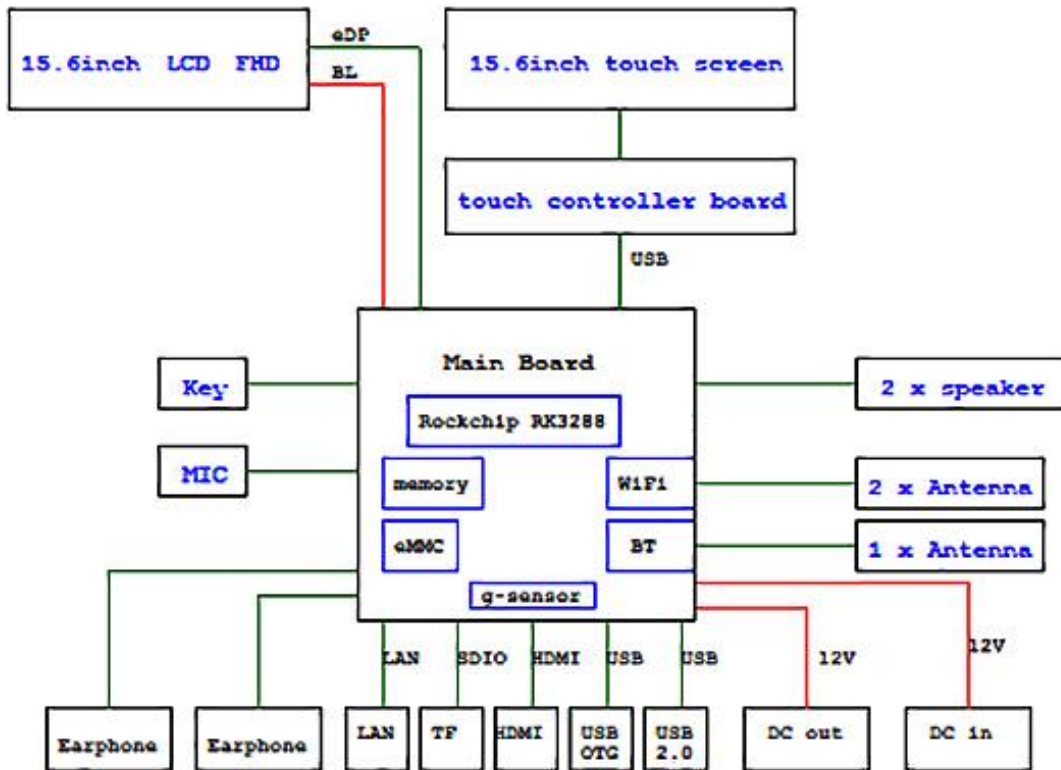

1.5 Interface Connectors

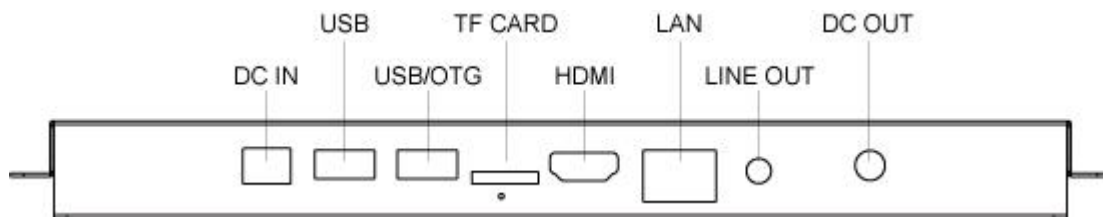

12V DC in

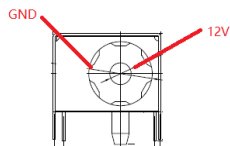

Pin #	Signal Name	Pin #	Signal Name
1	12V	2	GND

12V DC out

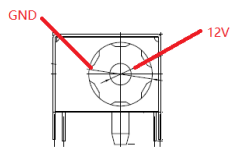

Pin #	Signal Name	Pin #	Signal Name
1	12V	2	GND

RJ45 for LAN

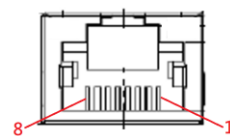

Pin #	Signal Name	Pin #	Signal Name
1	TP1+	2	TP1-
3	TP2+	4	TP3-
5	TP3+	6	TP2-
7	TP4+	8	TP4-

USB2.0

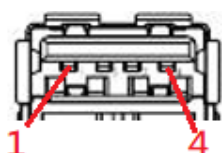

Pin #	Signal Name	Pin #	Signal Name
1	USB5V	2	D-
3	D+	4	GND

HDMI

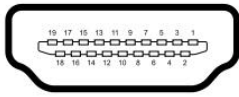

Pin #	Signal Name	Pin #	Signal Name
1	TMDS Data2+	2	TMDS Data2 Shield
3	TMDS Data2-	4	TMDS Data1+
5	TMDS Data1 Shield	6	TMDS Data1-
7	TMDS Data0+	8	TMDS Data0 Shield
9	TMDS Data0-	10	TMDS Clock+
11	TMDS Clock Shield	12	TMDS Clock-
13	CEC (N.C on device)	14	Reserved (N.C. on device)
15	SCL	16	SDA
17	DDC/CEC Ground	18	+5V Power
19	Hot Plug Detect		

TF card

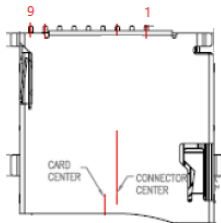

Pin #	Signal Name	Pin #	Signal Name
1	DAT2	2	DAT3
3	CMD	4	VCC
5	CLK	6	GND
7	DAT0	8	DAT1
9	CD		

Line Out

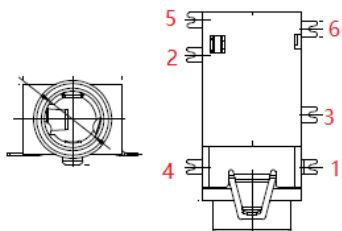

Pin #	Signal Name	Pin #	Signal Name
1	MIC IN	2	Left
3	Right	4	GND
5	NC	6	DET

1.6 Package Overview

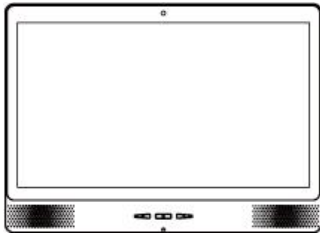

ECHELON TOUCH
SCREEN

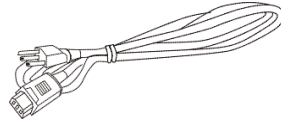

Power Cord

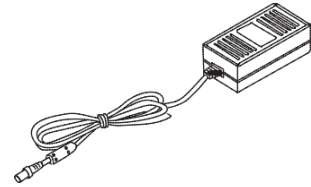

DC Power Supply



Warning!

This product is intended to be supplied by a UL Listed Power Adapter, rated 12Vdc, 4A minimum. (complied with LPS or PS2) Tma = 40 degree C minimum, and the altitude of operation = 2000m minimum. If it needs further assistance with purchasing the power source, please contact to Echelon for further information.



Mise en garde!

Cet appareil est conçu avec une alimentation de courant CA, d'une tension nominale de 12Vdc, 4A minimum. (conforme au LPS ou PS2) Tma = 40 degrés C minimum et l'altitude de l'utilisation = 2000m minimum. Pour d'autres conseils pour l'installation de la source d'alimentation, communiquer avec Echelon pour de plus amples renseignements.

Chapter 2

Product Installation

2.1 About VESA Mount

The ECHTES-156 conform to the “VESA Flat Display Mounting Interface Standard” which defines a physical mounting interface for touch computer, and corresponding with the standards of touch computer mounting devices, such as wall-mounted. The VESA mount is located on the back of this unit.

The equipment is only for wall mounting for horizontal (output connector facing down) and vertical mounting orientations (output connector facing left or right) when EUT without base.

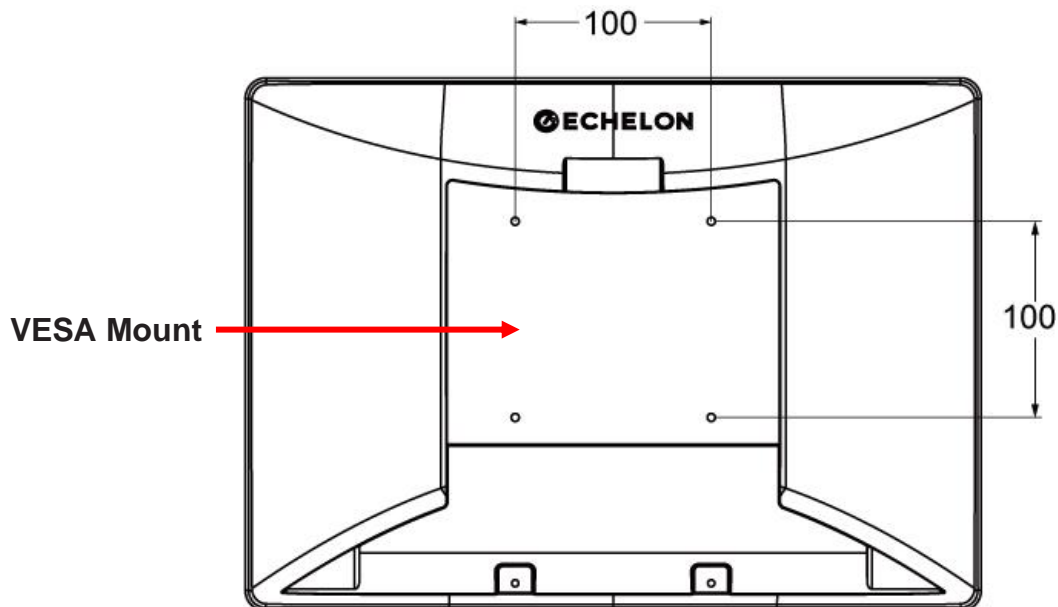

Warning!

*Please select the Echelon original screws!
The distance between the back cover surface and the bottom of the screw hole is 8 mm. Please use four M4 / 8 mm screws diameter with proper length to mount your monitor.*

Note: The mounting stand must be able to support at least 3.97 lbs (1.8 Kg).



Mise en garde!

Sélectionner les vis d'origine de Echelon!

La distance entre la surface du couvercle arrière et le bas de l'orifice de la vis est de 8 mm. Utiliser quatre vis M4 de 8 mm de diamètre pour le montage de votre moniteur.

Remarque : Le support de montage doit pouvoir supporter un poids d'au moins 3,97 lb (1,8 kg).

2.2 Power On / Off

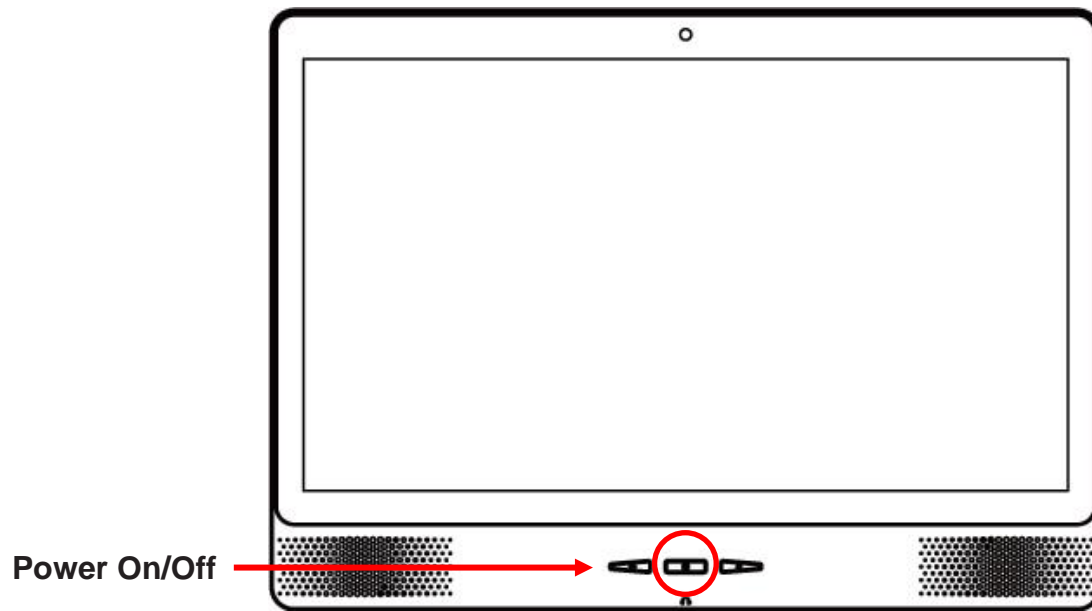

Function	Description
Power on	Press the power button
Power off	Press the power button 2 sec and click power off.
Vol-	Press the vol- button to turn the volume down.
Vol+	Press the vol+ button to turn the volume up.

2.3 Dimension

Front View

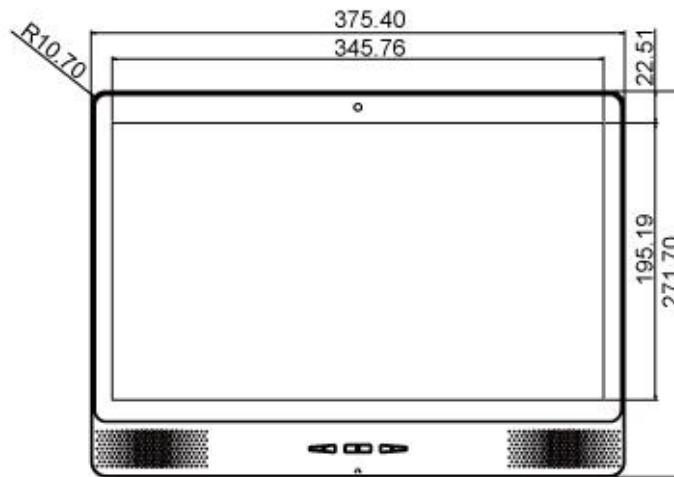

Side View



Rear View

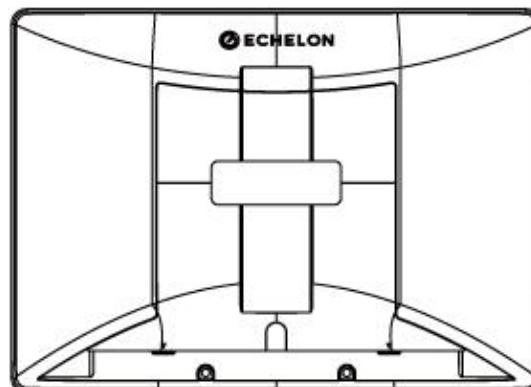

Bottom View



Appendix

Declaration of the Presence Condition of the Restricted Substances Marking

設備名稱：ECHELON TOUCH SCREEN Equipment name: ECHELON TOUCH SCREEN		型號（型式）：ECHTES-156 Type designation (Type): ECHTES-156				
單元 Unit	限用物質及其化學符號 Restricted substances and its chemical symbols					
	鉛 Lead (Pb)	汞 Mercury (Hg)	鎘 Cadmium (Cd)	六價鉻 Hexavalent chromium (Cr ⁺⁶)	多溴聯苯 Polybrominated biphenyls (PBB)	多溴二苯醚 Polybrominated diphenyl ethers (PBDE)
塑膠零件 Plastic Parts	○	○	○	○	○	○
金屬零件 Metal Parts	—	○	○	○	○	○
線纜和電纜組件 Cable component	—	○	○	○	○	○
液晶面板 LCD Panel	—	○	○	○	○	○
觸控式螢幕面板 Touch Panel	—	○	○	○	○	○
電路板總成 PCBA	—	○	○	○	○	○
軟體(光碟片等) Software	○	○	○	○	○	○
<p>Note 1 : “Exceeding 0.1 wt %” and “exceeding 0.01 wt %” indicate that the percentage content of the restricted substance exceeds the reference percentage value of presence condition. ◦</p> <p>Note 2 : “○” indicates that the percentage content of the restricted substance does not exceed the percentage of reference value of presence.</p> <p>Note 3 : The “—” indicates that the restricted substance corresponds to the exemption.</p>						