



RADIO TEST REPORT

Report No: STS2004278W01

Issued for

4G NET INC

3000 NW 72 AVENUE MIAMI FL 33122

Product Name:	Mobile phone
Brand Name:	UNIQCELL, UNIQ
Model Name:	Q6
Series Model:	Q6.3, Q6 PRO, Q6.3 PRO
FCC ID:	2AWCN-Q6
Test Standard:	FCC Part 22H and 24E

Any reproduction of this document must be done in full. No single part of this document may be reproduced without permission from STS, All Test Data Presented in this report is only applicable to presented Test sample.





TEST RESULT CERTIFICATION

Applicant's Name: 4G NET INC

Address: 3000 NW 72 AVENUE MIAMI FL 33122

Manufacture's Name: METELL TECHNOLOGY CO., LIMITED

Address: FLAT 1506.15/F LUCKY CTR NO 165-171 WAN CHAI RD WAN CHAI HONG KONG

Product Description

Product Name: Mobile phone

Brand Name: UNIQCELL, UNIQ

Model Name: Q6

Series Model: Q6.3, Q6 PRO, Q6.3 PRO

Test Standards: FCC Part 22H and 24E

Test Procedure: KDB 971168 D01 v03r01,ANSI C63.26(2015)

This device described above has been tested by STS, the test results show that the equipment under test (EUT) is in compliance with the FCC requirements. And it is applicable only to the tested sample identified in the report.

This report shall not be reproduced except in full, without the written approval of STS, this document may be altered or revised by STS, personal only, and shall be noted in the revision of the document.

Date of Test.....:

Date of receipt of test item.....: 24 Mar. 2020

Date (s) of performance of tests.: 24 Mar. 2020 ~ 11 May 2020

Date of Issue: 12 May 2020

Test Result: Pass

Testing Engineer : 

 (Chris Chen)

Technical Manager : 

 (Sunday Hu)

Authorized Signatory : 

 (Vita Li)





Table of Contents	Page
1 INTRODUCTION	6
1.1 TEST FACTORY	6
1.2 MEASUREMENT UNCERTAINTY	6
2 PRODUCT INFORMATION	7
3 TEST CONFIGURATION OF EQUIPMENT UNDER TEST	9
4 MEASUREMENT INSTRUMENTS	10
5 TEST ITEMS	11
5.1 CONDUCTED OUTPUT POWER	11
5.2 PEAK TO AVERAGE RATIO	12
5.3 TRANSMITTER RADIATED POWER (EIRP/ERP)	13
5.4 OCCUPIED BANDWIDTH	14
5.5 FREQUENCY STABILITY	15
5.6 SPURIOUS EMISSIONS AT ANTENNA TERMINALS	16
5.7 BAND EDGE	17
5.8 FIELD STRENGTH OF SPURIOUS RADIATION MEASUREMENT	18
APPENDIX A.TESTRESULT	20
A1.CONDUCTED OUTPUT POWER	20
A2. PEAK-TO-AVERAGE RADIO	24
A3. TRANSMITTER RADIATED POWER (EIRP/ERP)	33
A4. OCCUPIED BANDWIDTH (99% OCCUPIED BANDWIDTH/26DB BANDWIDTH)	37
A5.FREQUENCY STABILITY	46
A6. SPURIOUS EMISSIONS AT ANTENNA TERMINALS	50
A7. BAND EDGE	58
A8. FIELD STRENGTH OF SPURIOUS RADIATION MEASUREMENT	62
APPENDIX-PHOTOS OF TEST SETUP	74



Revision History

Rev.	Issue Date	Report NO.	Effect Page	Contents
00	12 May 2020	STS2004278W01	ALL	Initial Issue





SUMMARY OF TEST RESULTS

Test procedures according to the technical standards:

The radiated emission testing was performed according to the procedures of KDB 971168 D01 v03r01 and ANSI C63.26(2015)

FCC Rules	Test Description	Test Limit	Test Result	Reference
2.1046	Conducted OutputPower	Reporting Only	PASS	
22.913d 24.232d	Peak-to-AverageRatio	< 13 dB	PASS	
2.1046 22.913 24.232	Effective Radiated Power/Equivalent Isotropic Radiated Power	< 7 Watts max. ERP(Part 22) < 2 Watts max. EIRP(Part 24)	PASS	
2.1049 22.917 24.238	Occupied Bandwidth	Reporting Only	PASS	
2.1055 22.355 24.235	Frequency Stability	< 2.5 ppm (Part 22) Emission must remain in band (Part 24)	PASS	
2.1051 22.917 24.238	Spurious Emission at Antenna Terminals	< 43+10log10(P[Watts])	PASS	
2.1053 22.917 24.238	Field Strength of Spurious Radiation	< 43+10log10(P[Watts])	PASS	
2.1051 22.917 24.238	Band Edge	< 43+10log10(P[Watts])	PASS	



1 INTRODUCTION

1.1 TEST FACTORY

SHENZHEN STS TEST SERVICES CO., LTD

Add. : A 1/F, Building B, Zhuoke Science Park, No.190 Chongqing Road, HepingShequ, Fuyong Sub-District, Bao'an District, Shenzhen, Guang Dong, China

FCC test Firm Registration Number: 625569

IC test Firm Registration Number: 12108A

A2LA Certificate No.: 4338.01

1.2 MEASUREMENT UNCERTAINTY

The measurement uncertainties shown below were calculated in accordance with the requirements of ANSI C63.4-2014. All measurement uncertainty values are shown with a coverage factor of $k = 2$ to indicate a 95% level of confidence. The measurement data shown herein meets or exceeds the CISPR measurement uncertainty values specified in CISPR 16-4-2 and, thus, can be compared directly to specified limits to determine compliance.

No.	Item	Uncertainty
1	RF output power, conducted	$\pm 0.68\text{dB}$
2	Unwanted Emissions, conducted	$\pm 2.988\text{dB}$
3	All emissions, radiated 30-1GHz	$\pm 6.7\text{dB}$
4	All emissions, radiated 1G-6GHz	$\pm 5.5\text{dB}$
5	All emissions, radiated >6G	$\pm 5.8\text{dB}$
6	Conducted Emission (9KHz-150KHz)	$\pm 4.43\text{dB}$
7	Conducted Emission (150KHz-30MHz)	$\pm 5\text{dB}$



2 PRODUCT INFORMATION

Product Name	Mobile phone
Trade Name	UNIQCELL, UNIQ
Model Name	Q6
Series Model	Q6.3, Q6 PRO, Q6.3 PRO
Model Difference	Only different in model name, brand name. cameras and memory.
Tx Frequency:	GSM/GPRS/EDGE: 850: 824 MHz ~ 849MHz 1900: 1850 MHz ~ 1910MHz WCDMA: Band V: 824 MHz ~ 849 MHz Band II: 1850 MHz ~ 1910 MHz
Rx Frequency:	GSM/GPRS/EDGE: 850: 869 MHz ~ 894 MHz 1900: 1930 MHz ~ 1990MHz WCDMA: Band V: 869 MHz ~ 894 MHz Band II: 1930 MHz ~ 1990 MHz
Max RF Output Power:	GSM850:30.72dBm, PCS1900:27.67dBm GPRS850(1-Slot):30.74dBm, GPRS1900(1-Slot):27.67dBm GPRS850(2-Slot):30.34dBm, GPRS1900(2-Slot):27.23dBm GPRS850(3-Slot):29.85dBm, GPRS1900(3-Slot):26.78dBm GPRS850(4-Slot):29.35dBm, GPRS1900(4-Slot):26.32dBm EDGE 850(1-Slot):32.22dBm, EDGE 1900(1-Slot):29.52dBm EDGE 850(2-Slot):31.43dBm, EDGE 1900(2-Slot):28.79dBm EDGE 850(3-Slot):30.72dBm, EDGE 1900(3-Slot):28.00dBm EDGE 850(4-Slot):29.96dBm, EDGE 1900(4-Slot):27.22dBm WCDMA Band II:22.71dBm, WCDMA Band V:21.24dBm
Type of Emission:	GSM(850): 319KGXW; PCS(1900): 320KGXW GPRS(850): 325KGXW; GPRS(1900): 318KGXW EDGE(850): 433KG7W; EDGE(1900): 325KG7W WCDMA850: 4M83F9W; WCDMA1900: 4M84F9W
Modulation Characteristics:	GMSK for GSM/GPRS; GMSK and 8PSK for EDGE WCDMA: QPSK; HSDPA:QPSK/16QAM; HSUPA:BPSK
SIM Card:	SIM 1 and SIM 2 is a chipset unit and tested as single chipset, SIM 1 is used to tested.
Antenna:	PIFA
Antenna gain:	GSM 850: 1.77dBi ,PCS 1900:2.11dBi WCDMA 850: 1.77dBi, WCDMA1900:2.12dBi
Battery parameter:	Rated Voltage: 3.7V Charge Limit: 4.2V Capacity: 2000mAh
Adapter:	Input: 100-240 0.15A 50/60Hz Output: 5V 1000mah
GPRS/EDGE Class:	Multi-Class12
Extreme Vol. Limits:	DC 3.4V~ DC 4.2V(Normal: DC 3.7V)
Extreme Temp. Tolerance:	-30°C to +50°C



Hardware version number:	V2.1
Software version number:	UNIQ_CELL_1+16_Q6_C8EM_3M2_20200327
<p>** Note: The High Voltage 4.2V and Low Voltage 3.4V was declared by manufacturer, The EUT couldn't be operate normally with higher or lower voltage.</p>	

RF Function	Band	Mode	Modulation	Power Class	Ant Gain(dBi)	Ant Type	SIM Card
GSM	850	GSM	GMSK	4 (power control level 5)	GSM850: 1.77dbi	PIFA	2 SIM 1 is used to tested.
		GPRS	GMSK	4			
		EDGE	GMSK、 8PSK	E2			
	1900	GSM	GMSK	1 (power control level 0)	GSM1900: 2.11dbi		
		GPRS	GMSK	1			
		EDGE	GMSK	E2			

RF Function	Band	Mode	Modulation	Power Class	Ant Gain(dBi)	Ant Type	SIM Card
WCDMA	2/5	WCDMA	GMSK	3	WCDMA850: 1.77dbi WCDMA1900: 2.12dbi	PIFA	2 SIM 1 is used to tested.
		HSDPA	QPSK、 16QAM				
		HSUPA	BPSK				



3 TEST CONFIGURATION OF EQUIPMENT UNDER TEST

Antenna port conducted and radiated test items were performed according to KDB 971168 D01 and ANSI C63.26 2015 Power Meas. License Digital Systems with maximum output power.

Radiated measurements were performed with rotating EUT in different three orthogonal test planes to find the maximum emission.

Radiated emissions were investigated as following frequency range:

1. 30 MHz to 10th harmonic for GSM850 and WCDMA Band V.
2. 30 MHz to 10th harmonic for GSM1900 and WCDMA Band II.

All modes and data rates and positions were investigated.

Test modes are chosen to be reported as the worst case configuration below:

BAND	TEST MODES	
	RADIATED TCS	CONDUCTED TCS
GSM 850	GSM LINK	GSM LINK
	GPRS/EDGE CLASS 12 LINK	GPRS/EDGE CLASS 12 LINK
GSM 1900	GSM LINK	GSM LINK
	GPRS/EDGE CLASS 12 LINK	GPRS/EDGE CLASS 12 LINK
WCDMA BAND V	RMC 12.2KBPS LINK	RMC 12.2KBPS LINK
WCDMA BAND II	RMC 12.2KBPS LINK	RMC 12.2KBPS LINK



4 MEASUREMENT INSTRUMENTS

Radiation Test equipment

Kind of Equipment	Manufacturer	Type No.	Serial No.	Last calibration	Calibrated until
Test Receiver	R&S	ESCI	101427	2019.07.29	2020.07.28
Signal Analyzer	Agilent	N9020A	MY51110105	2020.03.05	2021.03.04
Wireless Communications Test Set	R&S	CMW 500	133884	2020.03.05	2021.03.04
Bilog Antenna	TESEQ	CBL6111D	34678	2017.11.02	2020.11.01
Horn Antenna	SCHWARZBECK	BBHA 9120D(1201)	9120D-1343	2018.10.19	2021.10.18
SHF-EHF Horn Antenna (18G-40GHz)	A-INFO	LB-180400-KF	J211020657	2018.03.11	2021.03.10
Pre-Amplifier (0.1M-3GHz)	EM	EM330	060665	2019.10.09	2020.10.08
Pre-Amplifier (1G-18GHz)	SKET	LNPA-01018G-45	SK2018080901	2019.10.12	2020.10.11
Turn table	EM	SC100_1	60531	N/A	N/A
Antenna mast	EM	SC100	N/A	N/A	N/A
Temperature & Humidity	HH660	Mieo	N/A	2019.10.12	2020.10.11
Test SW	BULUN	BL410-E/18.905			

RF Connected Test

Kind of Equipment	Manufacturer	Type No.	Serial No.	Last calibration	Calibrated until
Universal Radio communication tester	R&S	CMU200	11764	2019.10.11	2020.10.10
Wireless Communications Test Set	R&S	CMW 500	133884	2020.03.05	2021.03.04
Signal Analyzer	Agilent	N9020A	MY49100060	2019.10.09	2020.10.08
Temperature & Humidity	HH660	Mieo	N/A	2019.10.12	2020.10.11
Test SW	FARAD	LZ-RF /LzRf-3A3			

Equipment with a calibration date of "NCR" shown in this list was not used to make direct calibrated measurements.

5 TEST ITEMS

5.1 CONDUCTED OUTPUT POWER

Test overview

A system simulator was used to establish communication with the EUT. Its parameters were set to enforce EUT transmitting at the maximum power. The measured power in the radio frequency on the transmitter output terminals shall be reported.

Test procedures

1. The transmitter output port was connected to the system simulator.
2. Set eut at maximum power through the system simulator.
3. Select lowest, middle, and highest channels for each band and different modulation.
4. Measure and record the power level from the system simulator.

Test setup



5.2 PEAK TO AVERAGE RATIO

TEST OVERVIEW

According to §24.232(d), power measurements for transmissions by stations authorized under this section may be made either in accordance with a commission-approved average power technique or in compliance with paragraph (e) of this section. In both instances, equipment employed must be authorized in accordance with the provisions of §24.51. In measuring transmissions in this band using an average power technique, the peak-to-average ratio (PAR) of the transmission may not exceed 13 db.

TEST PROCEDURES

1. The testing follows fckdb 971168 v03r01 section
2. The eut was connected to the and peak and av system simulator& spectrum analysis reads
3. Select lowest, middle, and highest channels for each band and different modulation.
4. Set the test probe and measure average power of the spectrum analysis

TEST SETUP

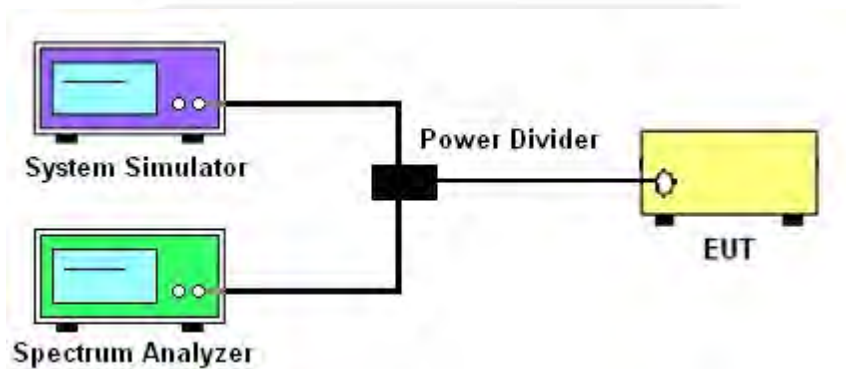



5.3 TRANSMITTER RADIATED POWER (EIRP/ERP)

TEST OVERVIEW

Effective Radiated Power (ERP) and Equivalent Isotropic Radiated Power (EIRP) measurements are performed using the substitution method described in ANSI C63.26 2015 with the EUT transmitting into an integral antenna. Measurements on signals operating below 1GHz are performed using vertically polarized tuned dipole antennas. Measurements on signals operating above 1GHz are performed using vertically polarized broadband horn antennas. All measurements are performed as RMS average measurements while the EUT is operating at maximum power, and at the appropriate frequencies.

TEST PROCEDURE

1. The testing follows FCC KDB 971168 Section 5.8 and ANSI C63.26-2015 Section 5.2.
2. The transmitter was placed on a wooden turntable, and it was transmitting into a non-radiating load which was also placed on the turntable.
3. The measurement antenna was placed at a distance of 3 meters from the EUT. During the tests, the antenna height and polarization as well as EUT azimuth were varied in order to identify the maximum level of emissions from the EUT. The test was performed by placing the EUT on 3-orthogonal axis.
4. The frequency range up to tenth harmonic of the fundamental frequency was investigated.
5. Remove the EUT and replace it with substitution antenna. A signal generator was connected to the substitution antenna by a nonradiating cable. The absolute levels of the spurious emissions were measured by the substitution.
6. Effective Isotropic Radiated Power (EIRP) was measured by substitution method according to ANSI C63.26-2015. The EUT was replaced by the substitution antenna at same location, and then a known power from S.G. was applied into the dipole antenna through a Tx cable, and then recorded the maximum Analyzer reading through raised and lowered the test antenna.
The correction factor (in dB) = S.G. - Tx Cable loss + Substitution antenna gain - Analyzer reading. Then the EUT's EIRP/ERP was calculated with the correction factor,
$$\text{ERP/EIRP} = \text{P.SG} + \text{GT} - \text{LC}$$

ERP/EIRP = effective or equivalent radiated power, respectively (expressed in the same units as P_{Me} as, typically dBW or dBm);
P_{Meas}(PK) = measured transmitter output power or PSD, in dBm or dBW;
GT = gain of the transmitting antenna, in dBd (ERP) or dBi (EIRP);
LC = signal attenuation in the connecting cable between the transmitter and antenna, in dB.

5.4 OCCUPIED BANDWIDTH

TEST OVERVIEW

The occupied bandwidth, that is the frequency bandwidth such that, below its lower and above its upper frequency limits, the mean powers radiated are each equal to 0.5 percent of the total mean power radiated by a given emission shall be measured.

The 26 dB emission bandwidth is defined as the frequency range between two points, one above and one below the carrier frequency, at which the spectral density of the emission is attenuated 26 dB below the maximum in-band spectral density of the modulated signal. Spectral density (power per unit bandwidth) is to be measured with a detector of resolution bandwidth equal to approximately 1.0% of the emission bandwidth.

All modes of operation were investigated and the worst case configuration results are reported in this section.

TEST PROCEDURE

1. The signal analyzer's automatic bandwidth measurement capability was used to perform the 99% occupied bandwidth and the 26dB bandwidth. The bandwidth measurement was not influenced by any intermediate power nulls in the fundamental emission.
2. $RBW = 1 - 5\%$ of the expected OBW
3. $VBW \geq 3 \times RBW$
4. Detector = Peak
5. Trace mode = max hold
6. Sweep = auto couple
7. The trace was allowed to stabilize
8. If necessary, steps 2 – 7 were repeated after changing the RBW such that it would be within 1 – 5% of the 99% occupied bandwidth observed in Step 7

TEST SETUP

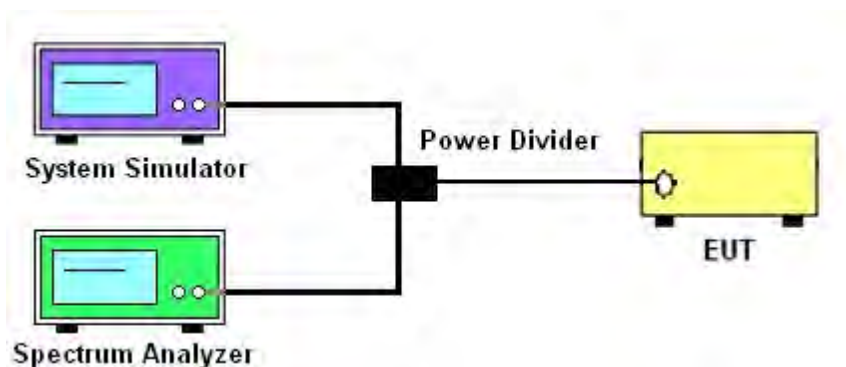

5.5 FREQUENCY STABILITY

Test Overview

Frequency stability testing is performed in accordance with the guidelines of ANSI C63.26 2015. The frequency stability of the transmitter is measured by:

- a.) Temperature: The temperature is varied from -30°C to $+50^{\circ}\text{C}$ in 10°C increments using an environmental chamber.
- b.) Primary Supply Voltage: The primary supply voltage is varied from 85% to 115% of the nominal value for non hand-carried battery and AC powered equipment. For hand-carried, battery-powered equipment, primary supply voltage is reduced to the battery operating end point which shall be specified by the manufacturer.

For Part 22, the frequency stability of the transmitter shall be maintained within $\pm 0.00025\%$ (± 2.5 ppm) of the center frequency. For Part 24 the frequency stability shall be sufficient to ensure that the fundamental emission stays within the authorized frequency block.

Test Procedure

Temperature Variation

1. The testing follows fccdb 971168 D01 section 9.0
2. The EUT was set up in the thermal chamber and connected with the system simulator.
3. With power OFF, the temperature was decreased to -30°C and the EUT was stabilized before testing. Power was applied and the maximum change in frequency was recorded within one minute.
4. With power OFF, the temperature was raised in 10°C steps up to 50°C . The EUT was stabilized at each step for at least half an hour. Power was applied and the maximum frequency change was recorded within one minute.

Voltage Variation

1. The testing follows FCC KDB 971168 D01 Section 9.0.
2. The EUT was placed in a temperature chamber at $25\pm 5^{\circ}\text{C}$ and connected with the system simulator.
3. The power supply voltage to the EUT was varied from 85% to 115% of the nominal value measured at the input to the EUT.
4. The variation in frequency was measured for the worst case.

TEST SETUP

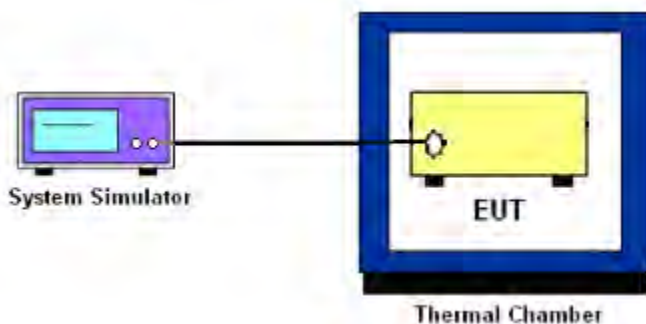

5.6 SPURIOUS EMISSIONS AT ANTENNA TERMINALS

Test Overview

The power of any emission outside of the authorized operating frequency ranges must be lower than the transmitter power (P) by a factor of at least $43 + 10 \log (P)$ dB.

It is measured by means of a calibrated spectrum analyzer and scanned from 30 MHz up to a frequency including its 10th harmonic.

Test procedure

1. The testing FCC KDB 971168 D01 v03r01 Section 6.0. and ANSI C63.26-2015-Section 5.5
2. The EUT was connected to the spectrum analyzer and system simulator via a power divider.
3. The RF output of EUT was connected to the spectrum analyzer by an RF cable and attenuator. The path loss was compensated to the results for each measurement.
4. The middle channel for the highest RF power within the transmitting frequency was measured.
5. The conducted spurious emission for the whole frequency range was taken.
6. The RF fundamental frequency should be excluded against the limit line in the operating frequency band.
7. The limit line is derived from $43 + 10\log(P)$ dB below the transmitter power P(Watts)
 $= P(W) - [43 + 10\log(P)]$ (dB)
 $= [30 + 10\log(P)]$ (dBm) - $[43 + 10\log(P)]$ (dB)
 $= -13\text{dBm}$.

Test Setup

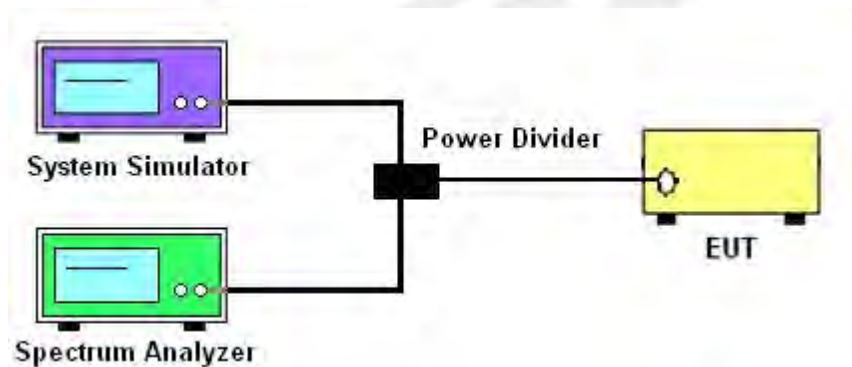

5.7 BAND EDGE

OVERVIEW

All out of band emissions are measured with a spectrum analyzer connected to the antenna terminal of the EUT while the EUT is operating at maximum power, and at the appropriate frequencies. All data rates were investigated to determine the worst case configuration. All modes of operation were investigated and the worst case configuration results are reported in this section.

The minimum permissible attenuation level of any spurious emission is $43 + \log_{10}(P[\text{Watts}])$, where P is the transmitter power in Watts.

TEST PROCEDURE

1. The testing FCC KDB 971168 D01 v03r01 Section 6.0. and ANSI C63.26-2015-Section 5.7
2. Start and stop frequency were set such that the band edge would be placed in the center of the Plot.
3. The EUT was connected to the spectrum analyzer and system simulator via a power divider.
4. The RF output of EUT was connected to the spectrum analyzer by an RF cable and attenuator.

The path loss was compensated to the results for each measurement.

5. The band edges of low and high channels for the highest RF powers were measured.

6. The RF fundamental frequency should be excluded against the limit line in the operating frequency band.

7. The limit line is derived from $43 + 10\log(P)$ dB below the transmitter power P(Watts)

$$= P(\text{W}) - [43 + 10\log(P)] (\text{dB})$$

$$= [30 + 10\log(P)] (\text{dBm}) - [43 + 10\log(P)] (\text{dB})$$

$$= -13\text{dBm}.$$

TEST SETUP

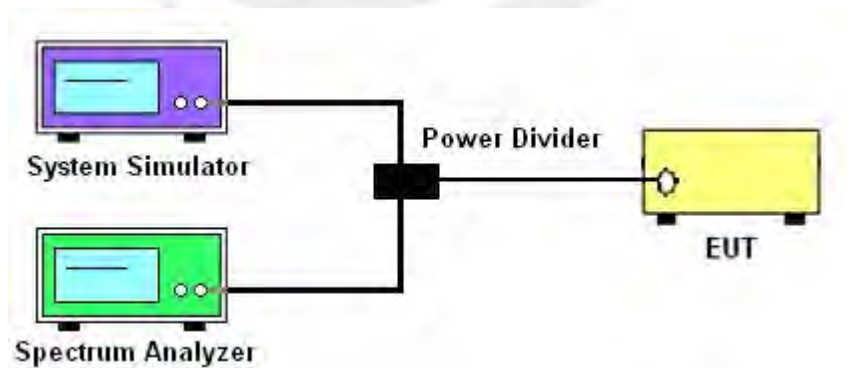



5.8 FIELD STRENGTH OF SPURIOUS RADIATION MEASUREMENT

Test overview

Radiated spurious emissions measurements are performed using the substitution method described in ANSI C63.26-2015 with the EUT transmitting into an integral antenna. Measurements on signals operating below 1GHz are performed using horizontally and vertically polarized tuned dipole antennas. Measurements on signals operating above 1GHz are performed using vertically and horizontally polarized horn antennas. All measurements are performed as peak measurements while the EUT is operating at maximum power and at the appropriate frequencies.

It is measured by means of a calibrated spectrum analyzer and scanned from 30 MHz up to a frequency including its 10th harmonic.

Test procedure

1. The testing FCC KDB 971168 D01 Section 5.8 and ANSI C63.26-2015-Section 5.5.
2. RBW = 100kHz for emissions below 1GHz and 1MHz for emissions above 1GHz
3. VBW $\geq 3 \times$ RBW
4. Span = 1.5 times the OBW
5. No. of sweep points $> 2 \times$ span/RBW
6. Detector = Peak
7. Trace mode = max hold
8. The trace was allowed to stabilize
9. Effective Isotropic Spurious Radiation was measured by substitution method according to TIA/EIA-603-D. The EUT was replaced by the substitution antenna at same location, and then a known power from S.G. was applied into the dipole antenna through a Tx cable, and then recorded the maximum Analyzer reading through raised and lowered the test antenna. The correction factor (in dB) = S.G. - Tx Cable loss + Substitution antenna gain - Analyzer reading. Then the EUT's EIRP/ERP was calculated with the correction factor,
 $ERP/EIRP = P.SG + GT - LC$
ERP/EIRP = effective or equivalent radiated power, respectively (expressed in the same units as P_{Meas}, typically dBW or dBm);
P.SG = measured transmitter output power or PSD, in dBm or dBW;
GT = gain of the transmitting antenna, in dBd (ERP) or dBi (EIRP);
LC = signal attenuation in the connecting cable between the transmitter and antenna, in dB.

TEST SETUP

For radiated test from 30MHz to 1GHz

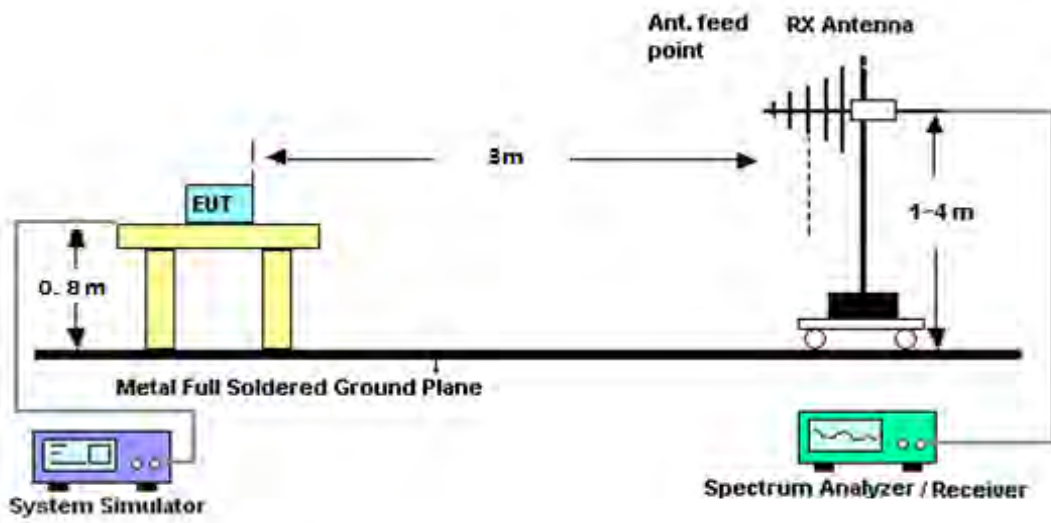

For radiated test from above 1GHz

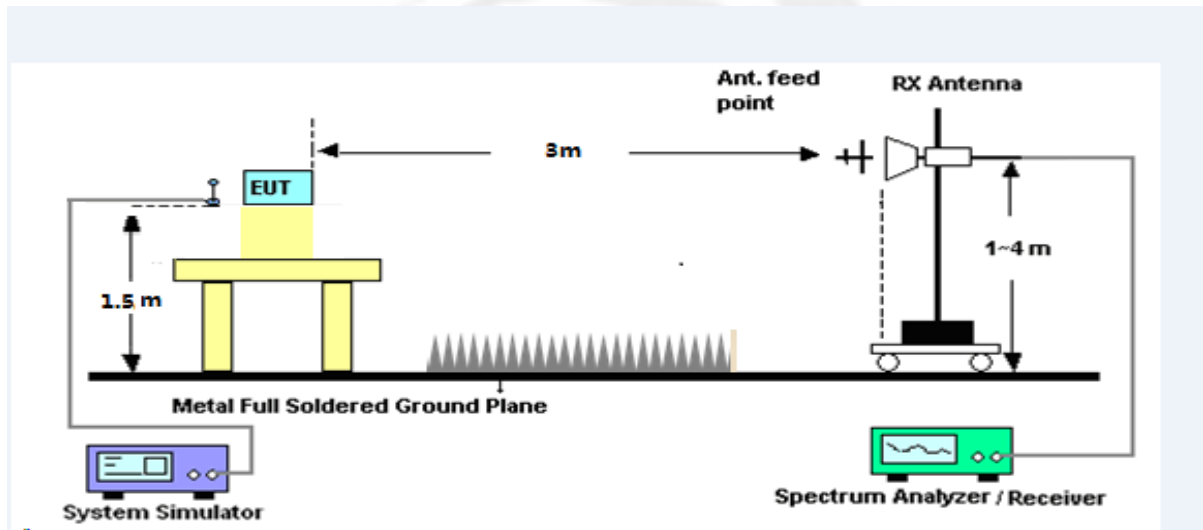

APPENDIX A.TESTRESULT
A1.CONDUCTED OUTPUT POWER

GSM 850:

GSM 850		
Mode	Frequency (MHz)	AVG Power(dBm)
GSM (GMSK,1-Slot)	824.2	30.58
	836.6	30.59
	848.8	30.72
GPRS (GMSK,1-Slot)	824.2	30.53
	836.6	30.58
	848.8	30.74
GPRS (GMSK,2-Slot)	824.2	30.08
	836.6	30.12
	848.8	30.34
GPRS (GMSK,3-Slot)	824.2	29.62
	836.6	29.70
	848.8	29.85
GPRS (GMSK,4-Slot)	824.2	29.18
	836.6	29.29
	848.8	29.35
EGPRS (8PSK,1-Slot)	824.2	31.82
	836.6	32.00
	848.8	32.22
EGPRS (8PSK,2-Slot)	824.2	31.02
	836.6	31.22
	848.8	31.43
EGPRS (8PSK,3-Slot)	824.2	30.30
	836.6	30.47
	848.8	30.72
EGPRS (8PSK,4-Slot)	824.2	29.57
	836.6	29.70
	848.8	29.96



PCS 1900:

PCS 1900		
Mode	Frequency (MHz)	AVG Power(dBm)
GSM (GMSK,1-Slot)	1850.2	27.50
	1880.0	27.28
	1909.8	27.67
GPRS (GMSK,1-Slot)	1850.2	27.49
	1880.0	27.28
	1909.8	27.67
GPRS (GMSK,2-Slot)	1850.2	27.05
	1880.0	26.83
	1909.8	27.23
GPRS (GMSK,3-Slot)	1850.2	26.58
	1880.0	26.39
	1909.8	26.78
GPRS (GMSK,4-Slot)	1850.2	26.13
	1880.0	25.96
	1909.8	26.32
EGPRS (8PSK,1-Slot)	1850.2	28.96
	1880.0	29.52
	1909.8	29.18
EGPRS (8PSK,2-Slot)	1850.2	28.18
	1880.0	28.79
	1909.8	28.48
EGPRS (8PSK,3-Slot)	1850.2	27.47
	1880.0	28.00
	1909.8	27.70
EGPRS (8PSK,4-Slot)	1850.2	26.72
	1880.0	27.22
	1909.8	26.91



UMTS BAND V

UMTS BAND V		
Mode	Frequency(MHz)	AVG Power
WCDMA 850 RMC	826.4	20.41
	836.6	20.93
	846.6	21.24
HSDPA Subtest 1	826.4	19.23
	836.6	19.66
	846.6	20.13
HSDPA Subtest 2	826.4	18.74
	836.6	19.18
	846.6	19.68
HSDPA Subtest 3	826.4	18.26
	836.6	18.73
	846.6	19.21
HSDPA Subtest 4	826.4	17.94
	836.6	18.29
	846.6	18.85
HSUPA Subtest 1	826.4	19.25
	836.6	19.60
	846.6	20.06
HSUPA Subtest 2	826.4	18.37
	836.6	18.65
	846.6	19.07
HSUPA Subtest 3	826.4	18.37
	836.6	18.17
	846.6	18.60
HSUPA Subtest 4	826.4	17.92
	836.6	17.71
	846.6	18.30
HSUPA Subtest 5	826.4	16.49
	836.6	16.26
	846.6	16.84



UMTS BAND II

UMTS BAND II		
Mode	Frequency(MHz)	AVG Power
WCDMA 1900 RMC	1852.4	22.71
	1880	22.26
	1907.6	22.34
HSDPA Subtest 1	1852.4	20.08
	1880	19.82
	1907.6	19.64
HSDPA Subtest 2	1852.4	19.65
	1880	19.41
	1907.6	19.20
HSDPA Subtest 3	1852.4	19.32
	1880	18.93
	1907.6	18.81
HSDPA Subtest 4	1852.4	18.83
	1880	18.50
	1907.6	18.38
HSUPA Subtest 1	1852.4	20.09
	1880	19.82
	1907.6	19.88
HSUPA Subtest 2	1852.4	19.25
	1880	18.84
	1907.6	18.92
HSUPA Subtest 3	1852.4	19.11
	1880	18.37
	1907.6	18.53
HSUPA Subtest 4	1852.4	18.65
	1880	17.96
	1907.6	18.22
HSUPA Subtest 5	1852.4	17.20
	1880	16.54
	1907.6	16.80



A2. PEAK-TO-AVERAGE RADIO

GSM 850		
Mode	Frequency (MHz)	PAR
GSM 850	824.2	0.13
	836.6	0.14
	848.8	0.15
GPRS 850	824.2	0.12
	836.6	0.13
	848.8	0.14
EGPRS 850	824.2	1.18
	836.6	1.28
	848.8	1.66

PCS 1900		
Mode	Frequency (MHz)	PAR
PCS1900	1850.2	0.09
	1880	0.10
	1909.8	0.09
GPRS1900	1850.2	0.09
	1880	0.09
	1909.8	0.09
EGPRS1900	1850.2	3.01
	1880	2.91
	1909.8	2.77

UMTS Band II		
Mode	Frequency (MHz)	PAR
WCDMA 1900 RMC	1852.4	2.81
	1880	2.86
	1907.6	2.82
HSDPA 1900	1852.4	3.35
	1880	3.43
	1907.6	3.30
HSUPA 1900	1852.4	3.28
	1880	3.48
	1907.6	3.64

UMTS Band V		
Mode	Frequency (MHz)	PAR
WCDMA 850 RMC	826.4	2.92
	836.6	2.74
	846.6	2.72
HSDPA 850	826.4	3.12
	836.6	3.06
	846.6	3.13
HSUPA 850	826.4	3.51
	836.6	3.36
	846.6	3.17

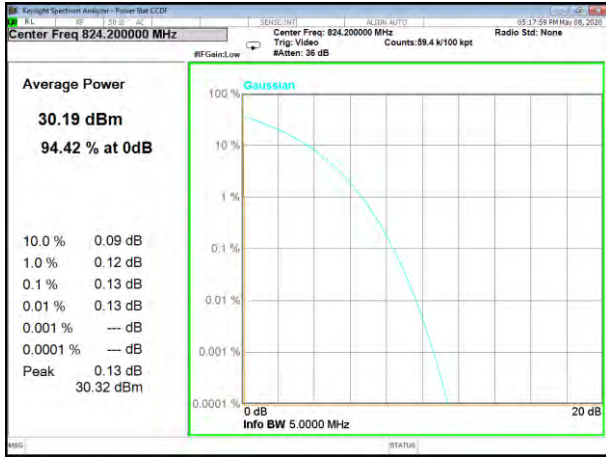

GSM850 Lower

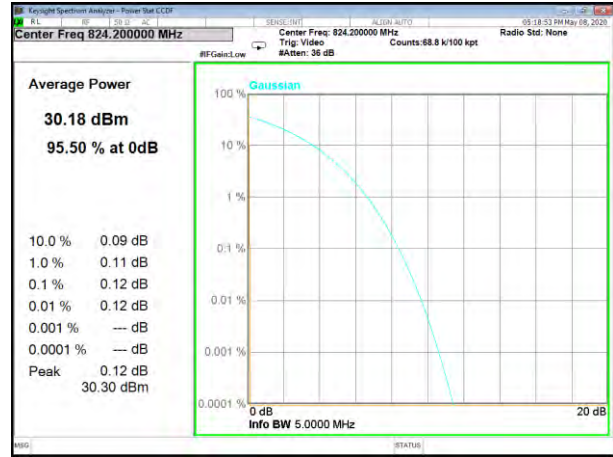

GPRS850 Lower

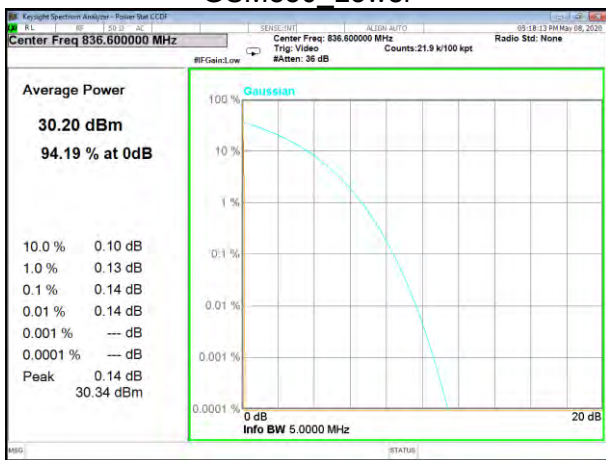

GSM850 Middle

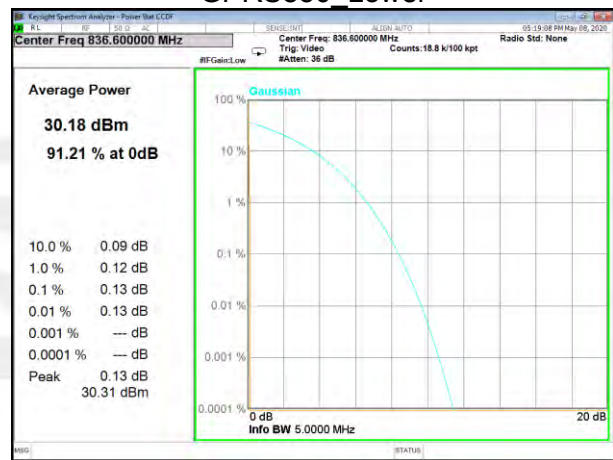

GPRS850 Middle

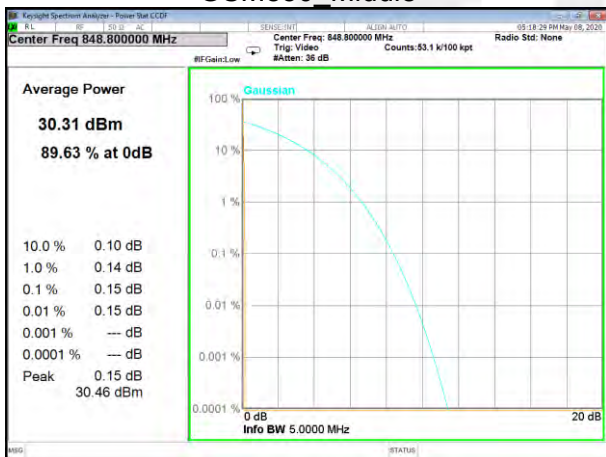

GSM850_Higher

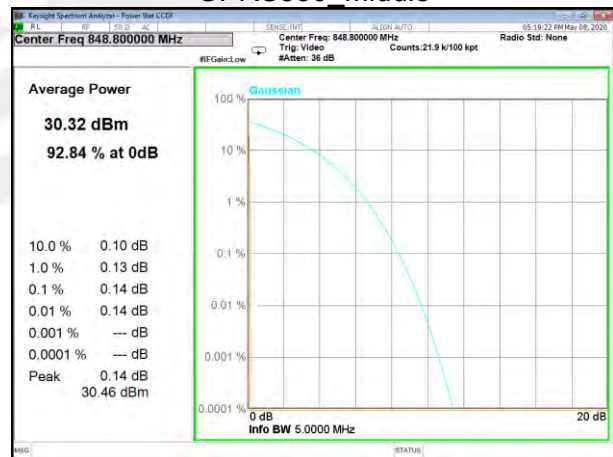

GPRS850_Higher

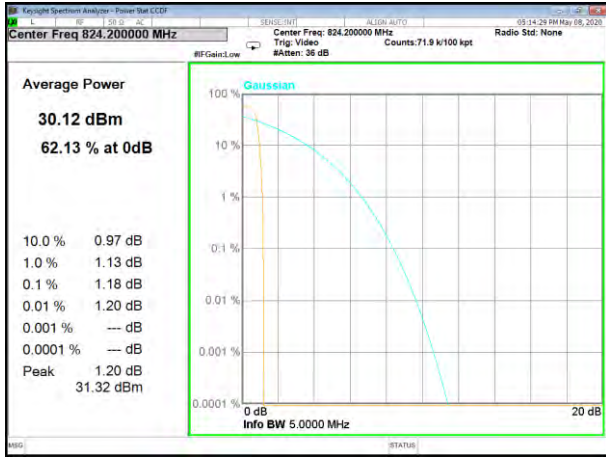

EGPRS850_Lower

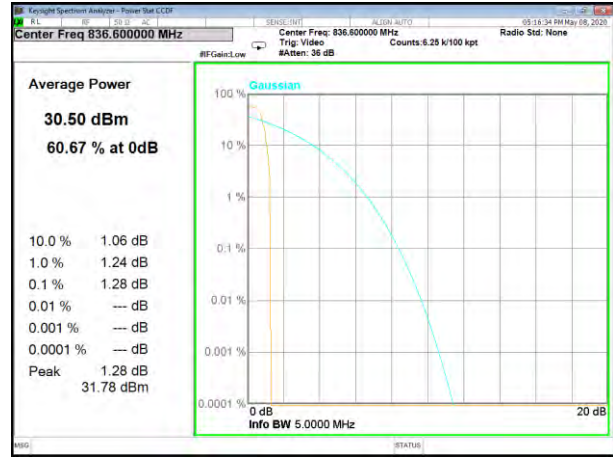

EGPRS850_Middle

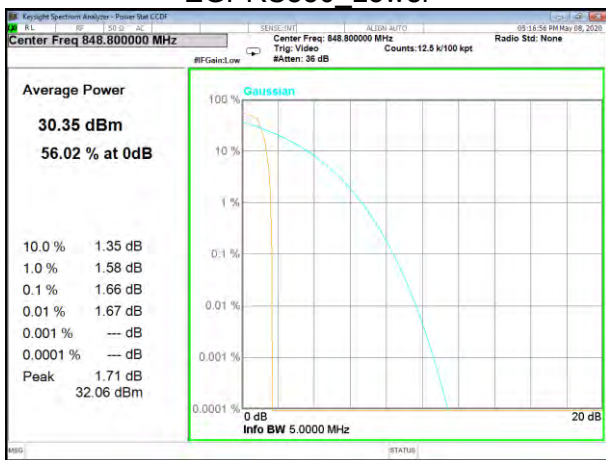

EGPRS850_Higher

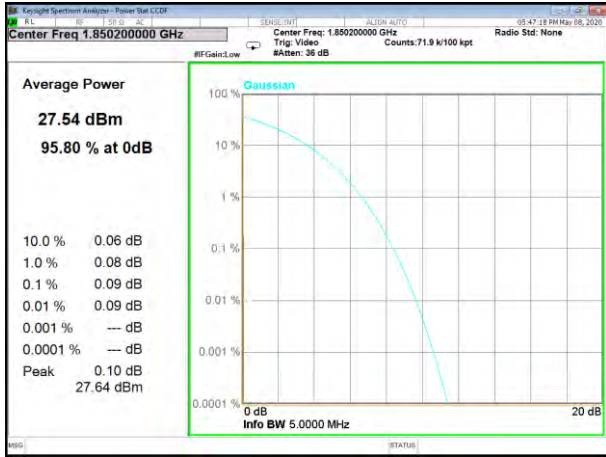

GSM1900 Lower

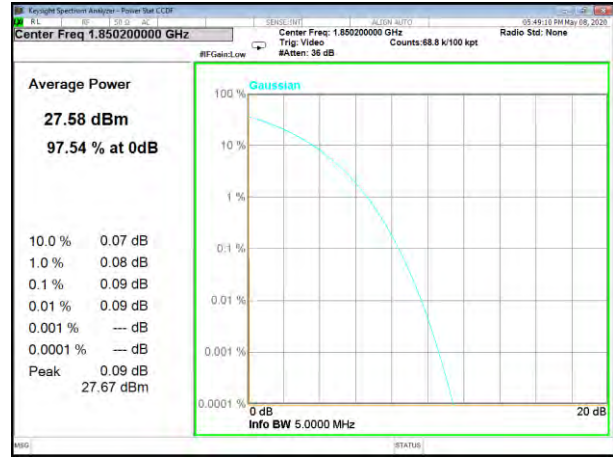

GPRS1900 Lower

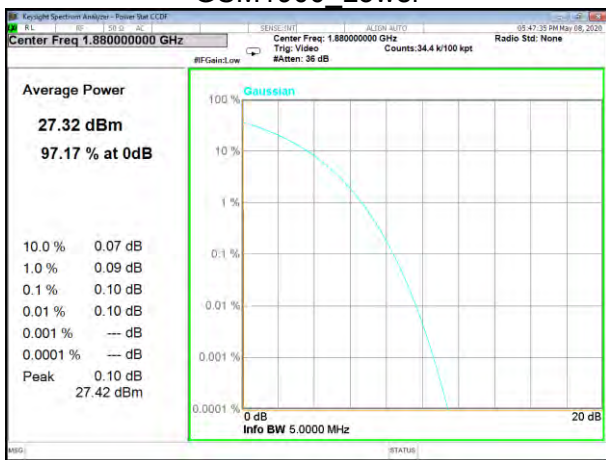

GSM1900 Middle

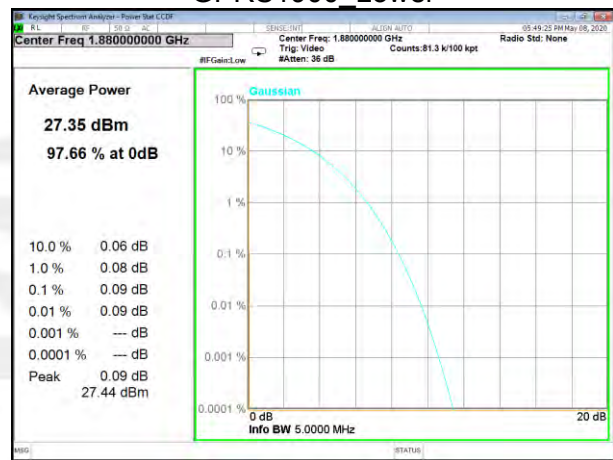

GPRS1900 Middle

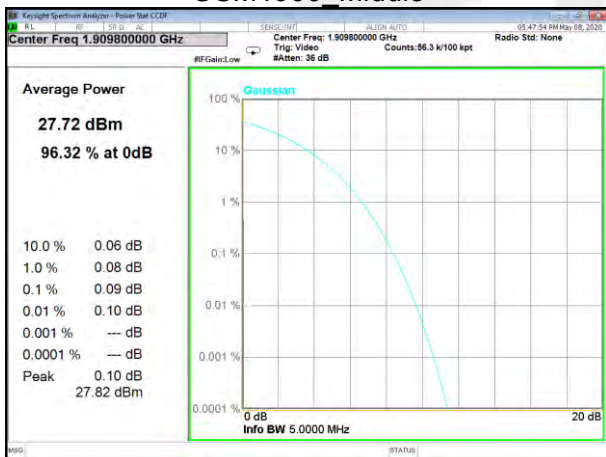

GSM1900_Higher

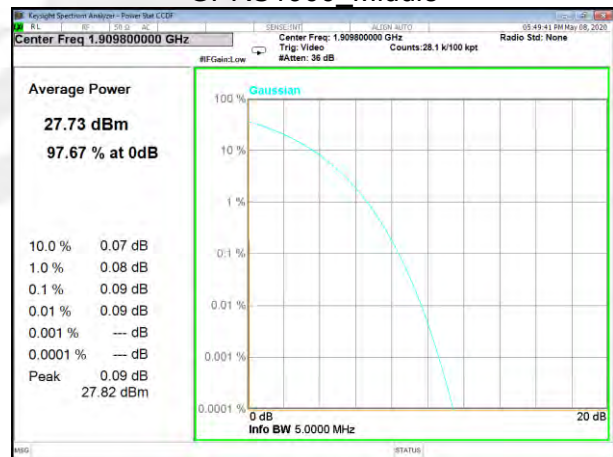

GPRS1900_Higher

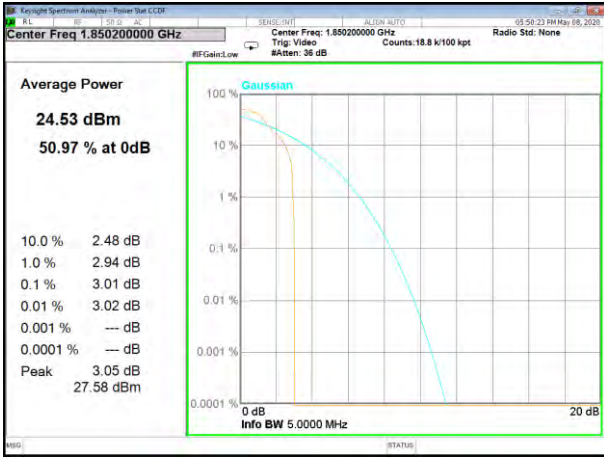

EGPRS1900_Lower

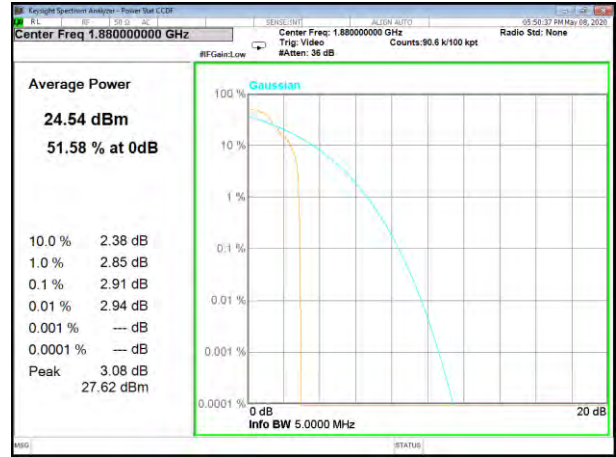

EGPRS1900_Middle

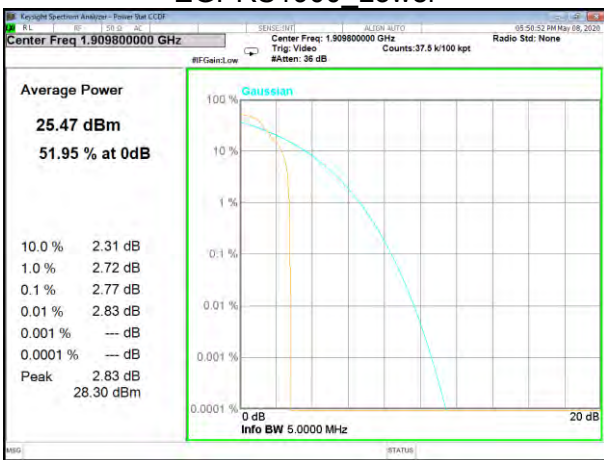

EGPRS1900_Higher

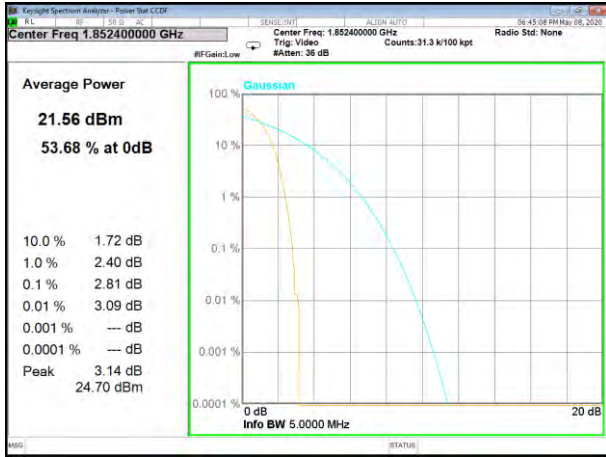

WCDMA B2_Lower

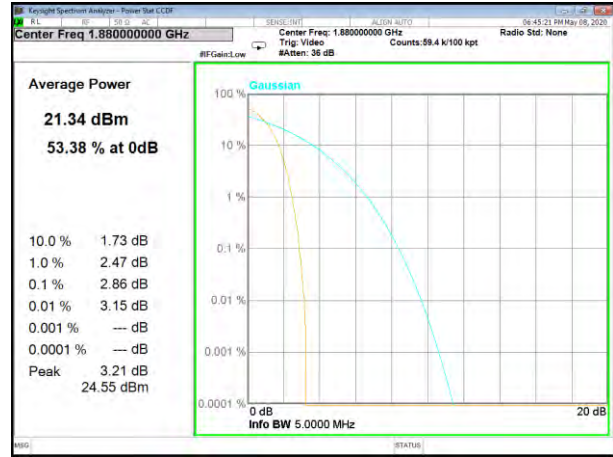

WCDMA B2_Middle

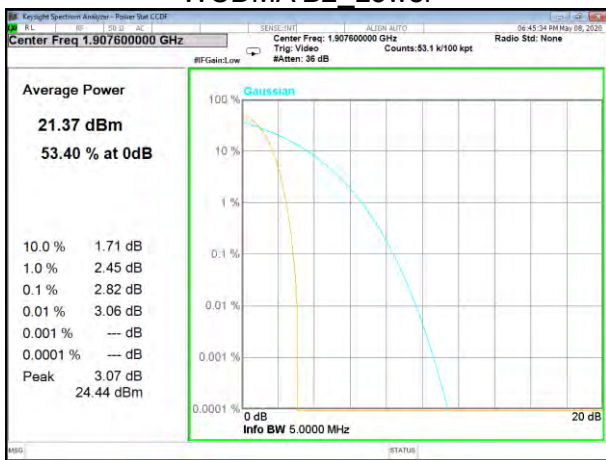

WCDMA B2_Higher



HSDPA B2_Lower



HSDPA B2_Middle



HSDPA B2_Higher

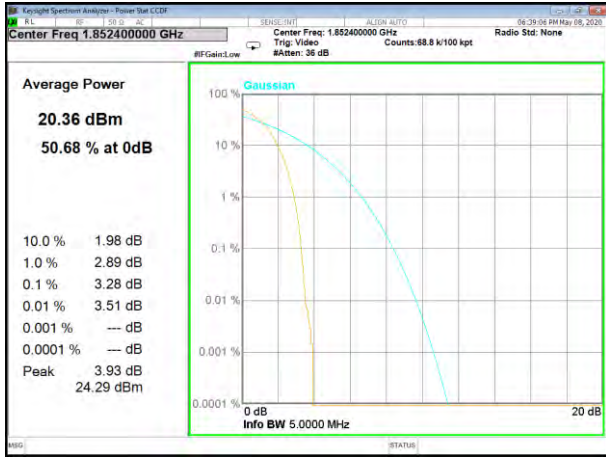

HSUPA B2_Lower

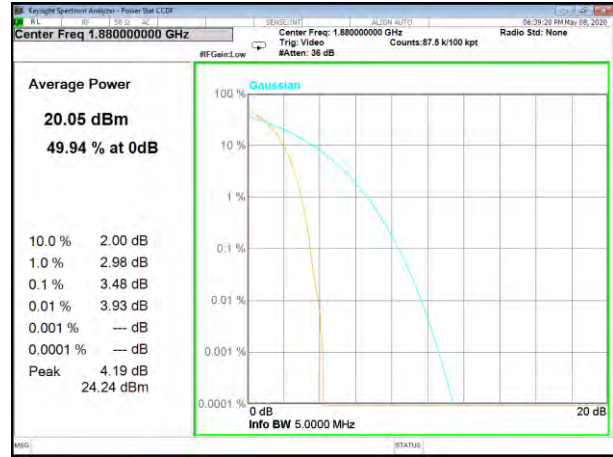

HSUPA B2_Middle

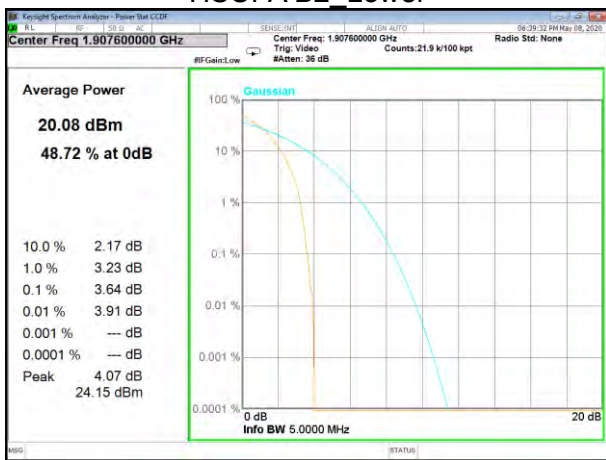

HSUPA B2_Higher

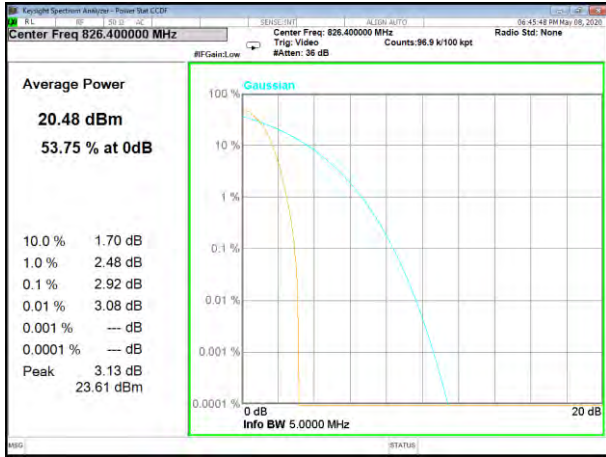

WCDMA B5 Lower

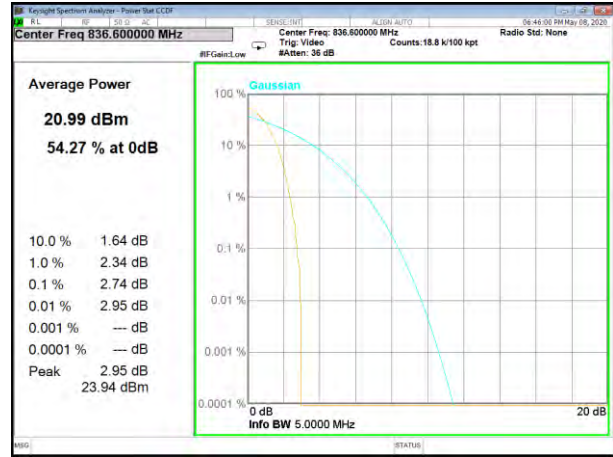

WCDMA B5 Middle

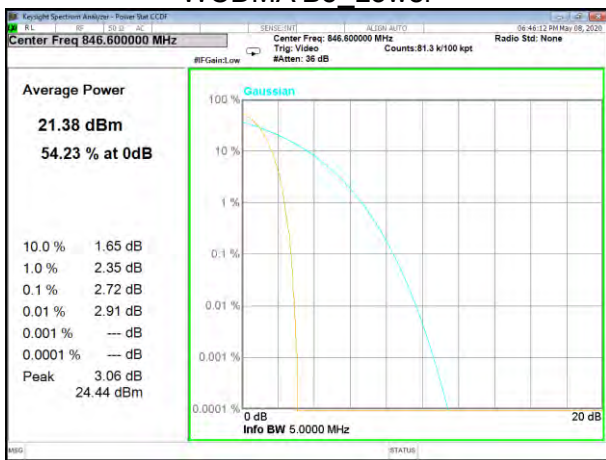

WCDMA B5 Higher

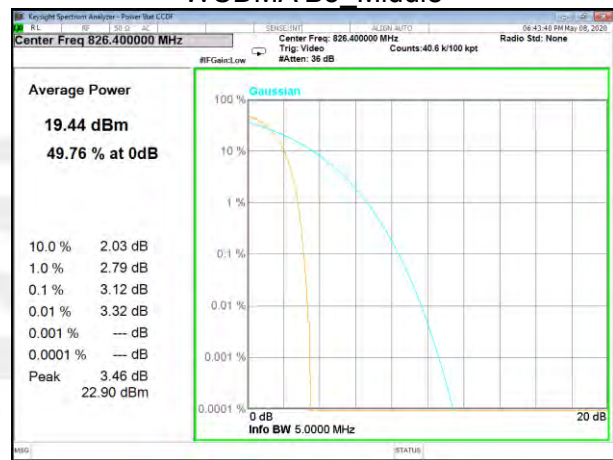

HSDPA B5 Lower

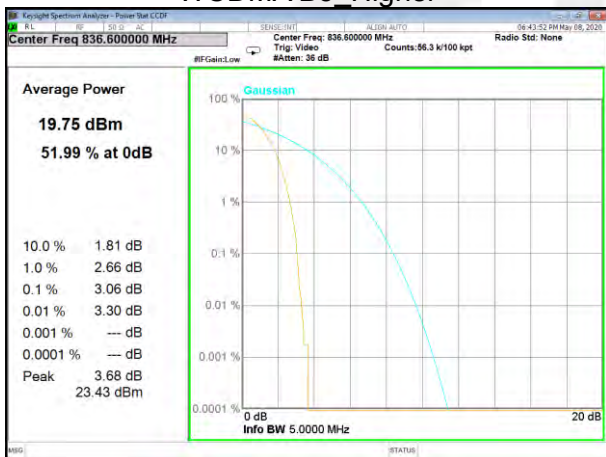

HSDPA B5 Middle

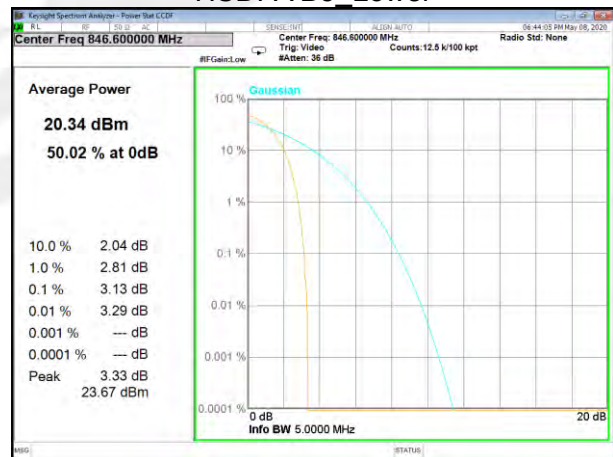

HSDPA B5 Higher

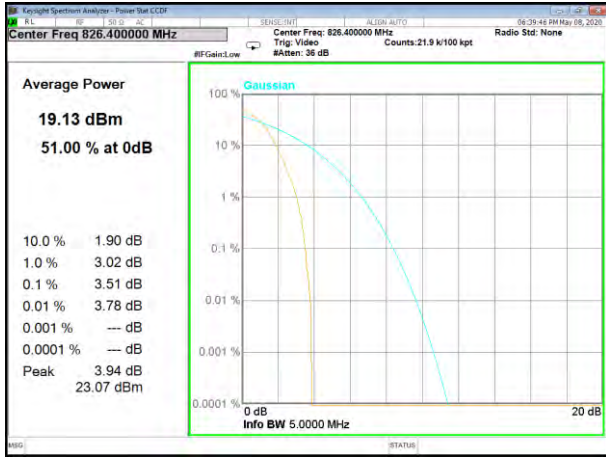

HSUPA B5_Lower

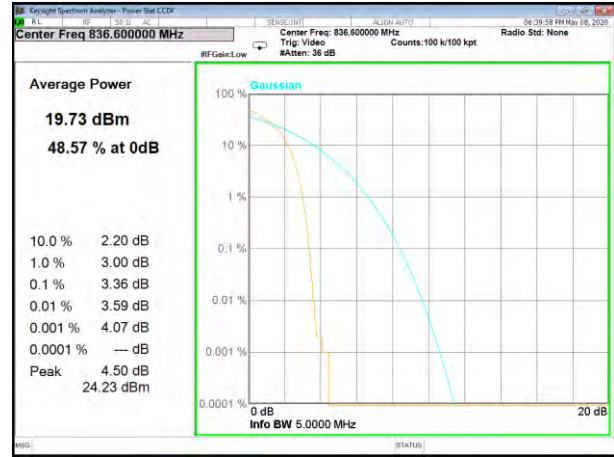

HSUPA B5_Middle

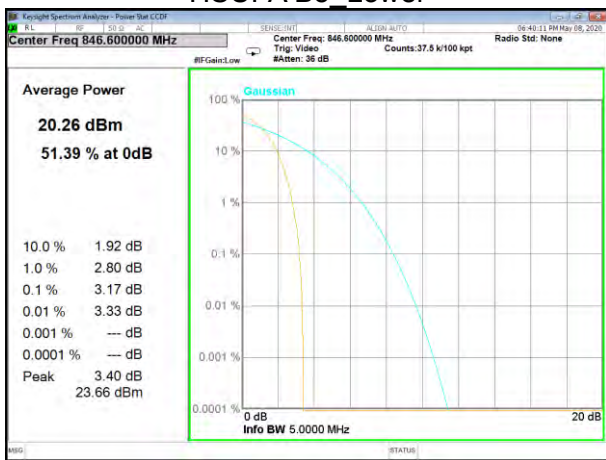

HSUPA B5_Higher



A3. TRANSMITTER RADIATED POWER (EIRP/ERP)

Note: Test is divided into three directions, X/Y/Z. X pattern for the worst

Radiated Power (ERP) for GSM 850 MHZ								
Mode	Frequency	Result						Conclusion
		S G.Level (dBm)	Cable loss	Gain(dBi)	correction factor(dB)	PMeas E.R.P(dBm)	Polarization Of Max. ERP	
GSM850	824.2	24.20	0.44	6.5	2.15	28.11	Horizontal	Pass
	824.2	25.97	0.44	6.5	2.15	29.88	Vertical	Pass
	836.6	23.89	0.45	6.5	2.15	27.79	Horizontal	Pass
	836.6	25.80	0.45	6.5	2.15	29.70	Vertical	Pass
	848.8	24.29	0.46	6.5	2.15	28.18	Horizontal	Pass
	848.8	26.03	0.46	6.5	2.15	29.92	Vertical	Pass
GPRS850	824.2	23.78	0.44	6.5	2.15	27.69	Horizontal	Pass
	824.2	25.95	0.44	6.5	2.15	29.86	Vertical	Pass
	836.6	24.07	0.45	6.5	2.15	27.97	Horizontal	Pass
	836.6	26.17	0.45	6.5	2.15	30.07	Vertical	Pass
	848.8	24.06	0.46	6.5	2.15	27.95	Horizontal	Pass
	848.8	26.13	0.46	6.5	2.15	30.02	Vertical	Pass
EGPRS850	824.2	25.01	0.44	6.5	2.15	28.92	Horizontal	Pass
	824.2	27.26	0.44	6.5	2.15	31.17	Vertical	Pass
	836.6	25.36	0.45	6.5	2.15	29.26	Horizontal	Pass
	836.6	27.41	0.45	6.5	2.15	31.31	Vertical	Pass
	848.8	25.29	0.46	6.5	2.15	29.18	Horizontal	Pass
	848.8	27.59	0.46	6.5	2.15	31.48	Vertical	Pass
Limit	ERP<7W=38.45dBm							



Radiated Power (EIRP) for PCS 1900 MHZ							
Mode	Frequency	Result					Conclusion
		S G.Level (dBm)	Cable loss	Gain (dBi)	PMeas E.I.R.P.(dBm)	Polarization Of Max. ERP	
PCS1900	1850.2	16.96	2.41	10.35	24.90	Horizontal	Pass
	1850.2	18.91	2.41	10.35	26.85	Vertical	Pass
	1880	16.7	2.42	10.35	24.63	Horizontal	Pass
	1880	18.49	2.42	10.35	26.42	Vertical	Pass
	1909.8	17.35	2.43	10.35	25.27	Horizontal	Pass
	1909.8	19.24	2.43	10.35	27.16	Vertical	Pass
GPRS1900	1850.2	16.44	2.41	10.35	24.38	Horizontal	Pass
	1850.2	18.45	2.41	10.35	26.39	Vertical	Pass
	1880	15.89	2.42	10.35	23.82	Horizontal	Pass
	1880	18.17	2.42	10.35	26.10	Vertical	Pass
	1909.8	16.52	2.43	10.35	24.44	Horizontal	Pass
	1909.8	18.73	2.43	10.35	26.65	Vertical	Pass
EGPRS1900	1850.2	17.94	2.41	10.35	25.88	Horizontal	Pass
	1850.2	20.34	2.41	10.35	28.28	Vertical	Pass
	1880	18.63	2.42	10.35	26.56	Horizontal	Pass
	1880	20.9	2.42	10.35	28.83	Vertical	Pass
	1909.8	18.4	2.43	10.35	26.32	Horizontal	Pass
	1909.8	20.61	2.43	10.35	28.53	Vertical	Pass
Limit	EIRP<2W=33dBm						



Radiated Power (EIRP) for WCDMA Band II							
Mode	Frequency	Result					Conclusion
		S G.Level (dBm)	Cable loss	Gain (dBi)	PMeas E.I.R.P.(dBm)	Polarization Of Max. EIRP	
WCDMA	1852.4	12.24	2.41	10.35	20.18	Horizontal	Pass
	1852.4	14.14	2.41	10.35	22.08	Vertical	Pass
	1880	11.7	2.42	10.35	19.63	Horizontal	Pass
	1880	13.69	2.42	10.35	21.62	Vertical	Pass
	1907.4	11.78	2.43	10.35	19.70	Horizontal	Pass
	1907.4	13.73	2.43	10.35	21.65	Vertical	Pass
HSUPA	1852.4	9.34	2.41	10.35	17.28	Horizontal	Pass
	1852.4	11.32	2.41	10.35	19.26	Vertical	Pass
	1880	9.54	2.42	10.35	17.47	Horizontal	Pass
	1880	11.35	2.42	10.35	19.28	Vertical	Pass
	1907.4	9.12	2.43	10.35	17.04	Horizontal	Pass
	1907.4	10.92	2.43	10.35	18.84	Vertical	Pass
HSDPA	1852.4	9.31	2.41	10.35	17.25	Horizontal	Pass
	1852.4	11.29	2.41	10.35	19.23	Vertical	Pass
	1880	9.11	2.42	10.35	17.04	Horizontal	Pass
	1880	11.01	2.42	10.35	18.94	Vertical	Pass
	1907.4	9.37	2.43	10.35	17.29	Horizontal	Pass
	1907.4	11.11	2.43	10.35	19.03	Vertical	Pass
Limit	EIRP<2W=33dBm						



Radiated Power (ERP) for WCDMA Band V								
Mode	Frequency	Result						Conclusion
		S G.Level (dBm)	Cable loss	Gain (dBi)	correction factor(dB)	PMeas E.R.P(dBm)	Polarization Of Max. ERP	
WCDMA	826.4	14.00	0.44	6.5	2.15	17.91	Horizontal	Pass
	826.4	15.81	0.44	6.5	2.15	19.72	Vertical	Pass
	836.6	14.61	0.45	6.5	2.15	18.51	Horizontal	Pass
	836.6	16.35	0.45	6.5	2.15	20.25	Vertical	Pass
	846.4	14.66	0.46	6.5	2.15	18.55	Horizontal	Pass
	846.4	16.66	0.46	6.5	2.15	20.55	Vertical	Pass
HSUPA	826.4	12.68	0.44	6.5	2.15	16.59	Horizontal	Pass
	826.4	14.68	0.44	6.5	2.15	18.59	Vertical	Pass
	836.6	13.45	0.45	6.5	2.15	17.35	Horizontal	Pass
	836.6	15.23	0.45	6.5	2.15	19.13	Vertical	Pass
	846.4	13.77	0.46	6.5	2.15	17.66	Horizontal	Pass
	846.4	15.72	0.46	6.5	2.15	19.61	Vertical	Pass
HSDPA	826.4	12.84	0.44	6.5	2.15	16.75	Horizontal	Pass
	826.4	14.71	0.44	6.5	2.15	18.62	Vertical	Pass
	836.6	13.24	0.45	6.5	2.15	17.14	Horizontal	Pass
	836.6	15.10	0.45	6.5	2.15	19.00	Vertical	Pass
	846.4	13.69	0.46	6.5	2.15	17.58	Horizontal	Pass
	846.4	15.52	0.46	6.5	2.15	19.41	Vertical	Pass
Limit	ERP<7W=38.45dBm							



A4. OCCUPIED BANDWIDTH (99% OCCUPIED BANDWIDTH/26dB BANDWIDTH)

GSM Bandwidth [KHz]						
Mode	Lowest		Middle		Highest	
	99% BW	26dB BW	99% BW	26dB BW	99% BW	26dB BW
GSM850	247.08	318.2	246.91	315	247.7	318.9
GPRS850	245.85	319.1	247.58	324.8	246.29	312.9
EGPRS850	307.17	433.4	283.4	395.4	287.53	383.6

GSM Bandwidth [KHz]						
Mode	Lowest		Middle		Highest	
	99% BW	26dB BW	99% BW	26dB BW	99% BW	26dB BW
GSM1900	245.55	320.1	247.15	312.3	247.05	317.8
GPRS1900	242.34	317.4	245.23	318.1	244.26	309.2
EGPRS1900	250.68	324.7	251.02	325.1	257.38	325.1

WCDMA Bandwidth [MHz]						
Mode	Lowest		Middle		Highest	
	99% BW	26dB BW	99% BW	26dB BW	99% BW	26dB BW
WCDMA II	4.208	4.821	4.196	4.826	4.214	4.827
HSDPA II	4.198	4.823	4.199	4.814	4.207	4.819
HSUPA II	4.204	4.818	4.205	4.82	4.2054	4.832

WCDMA Bandwidth [MHz]						
Mode	Lowest		Middle		Highest	
	99% BW	26dB BW	99% BW	26dB BW	99% BW	26dB BW
WCDMA V	4.1955	4.811	4.2	4.824	4.203	4.838
HSDPA V	4.197	4.826	4.206	4.837	4.2	4.824
HSUPA V	4.208	4.844	4.201	4.829	4.191	4.829

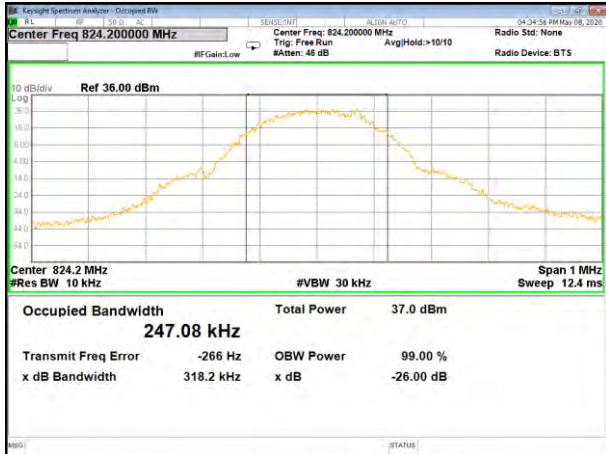

GSM_850_Lower_26BW_and_99%

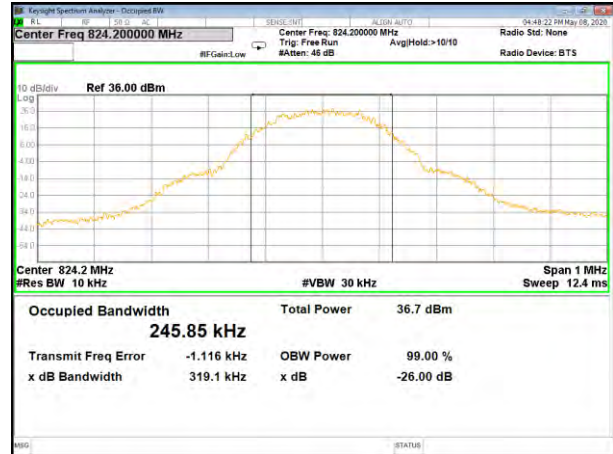

GPRS_850_Lower_26BW_and_99%

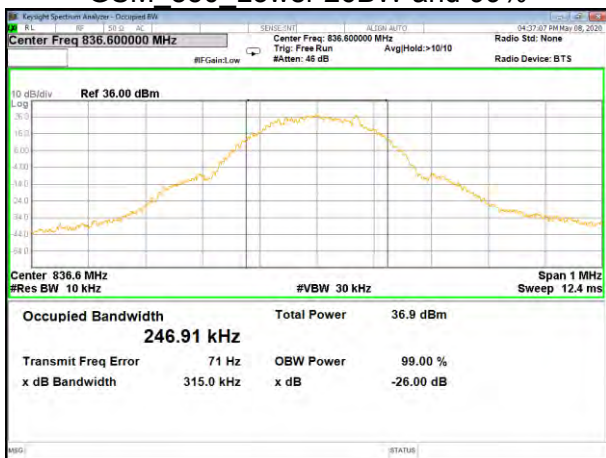

GSM_850_Middle_26BW_and_99%

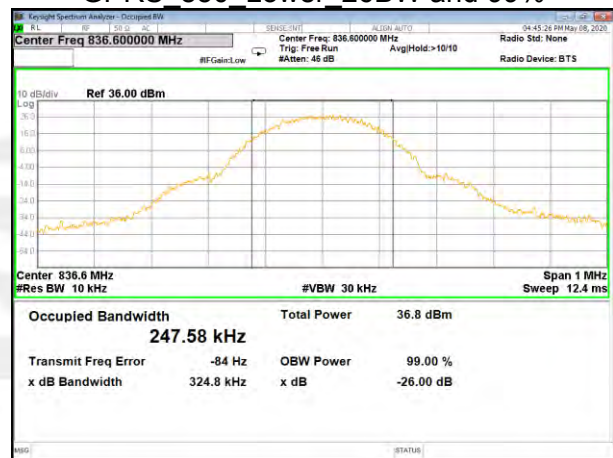

GPRS_850_Middle_26BW_and_99%

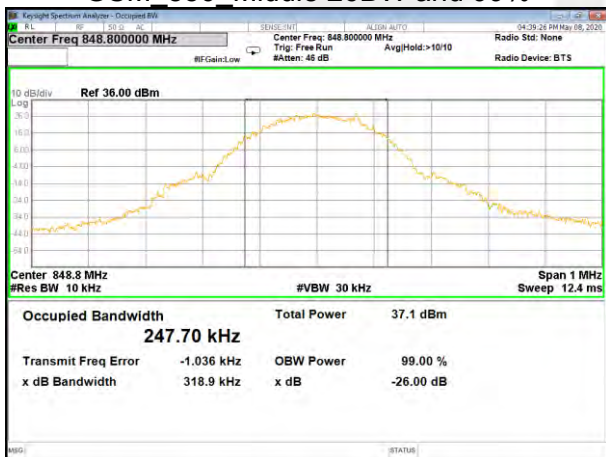

GSM_850_Higher_26BW_and_99%

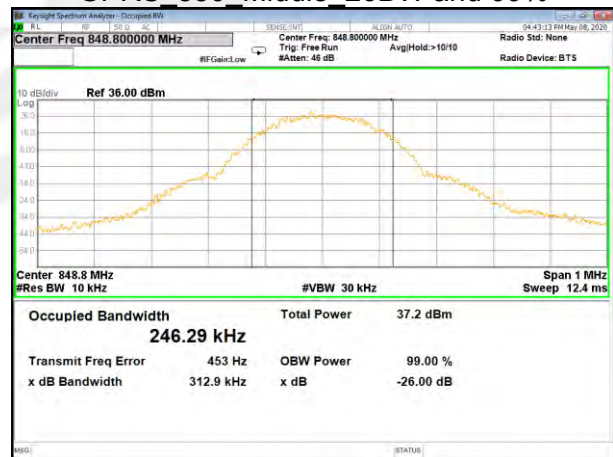

GPRS_850_Higher_26BW_and_99%

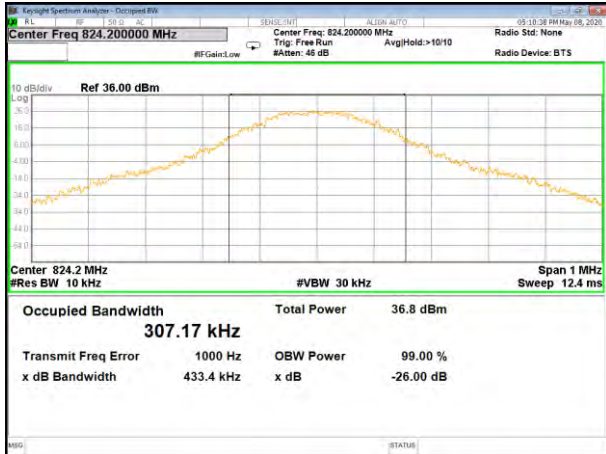

EGPRS 850 Lower 26BW and 99%

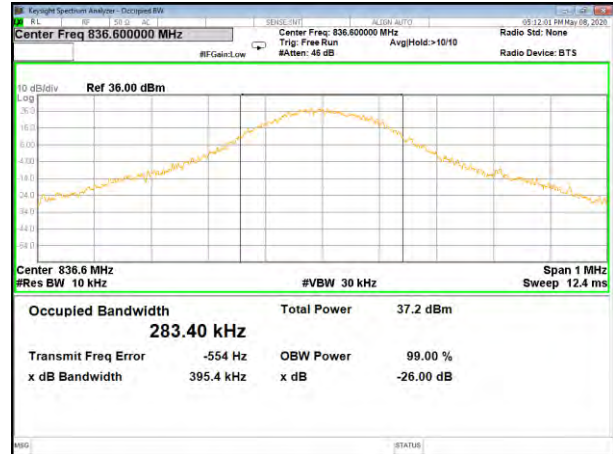

EGPRS_850_Middle_26BW and 99%

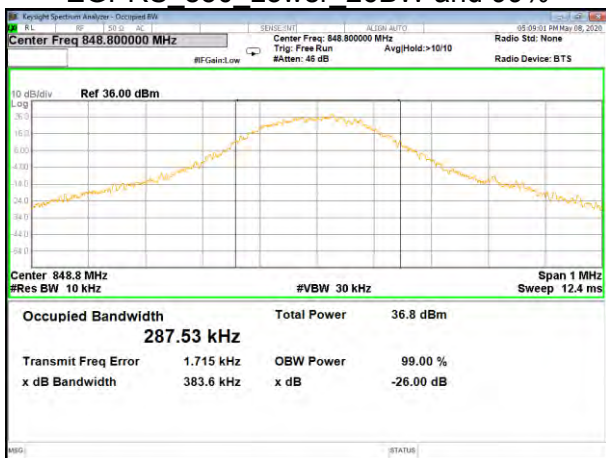

EGPRS_850_Higher_26BW and 99%

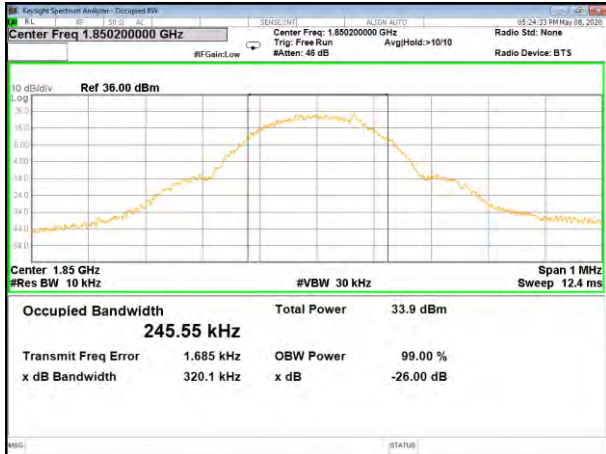

GSM 1900 Lower 26BW and 99%

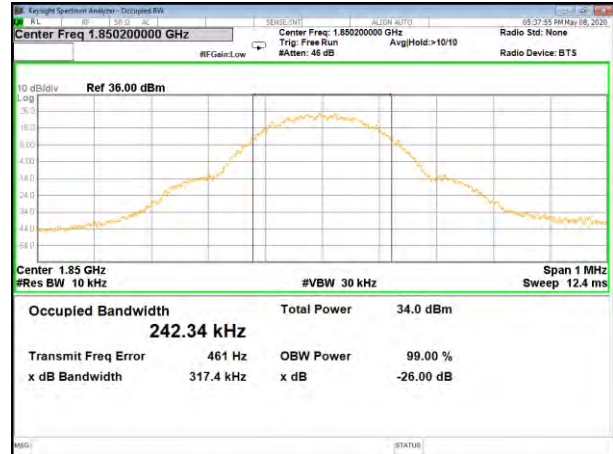

GPRS 1900 Lower 26BW and 99%



GSM 1900 Middle 26BW and 99%

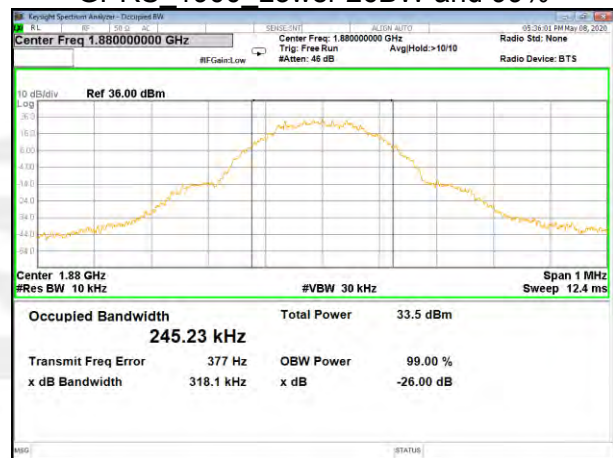

GPRS 1900 Middle 26BW and 99%



GSM_1900_Higher 26BW and 99%



GPRS_1900_Higher 26BW and 99%

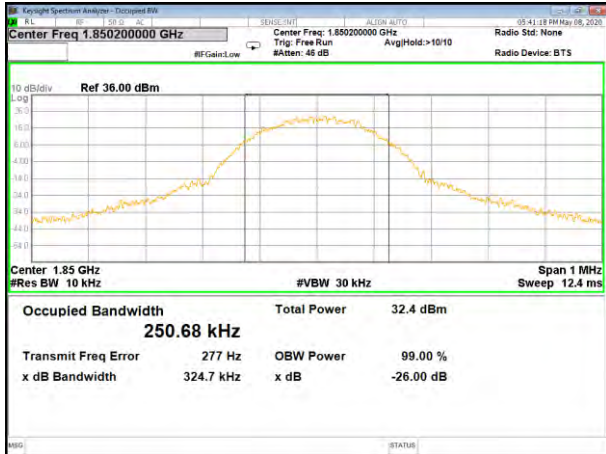

EGPRS_1900_Lower_26BW and 99%

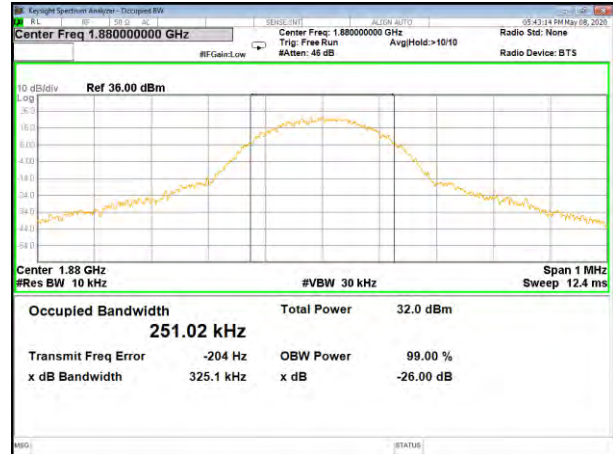

EGPRS_1900_Middle_26BW and 99%



EGPRS_1900_Higher_26BW and 99%

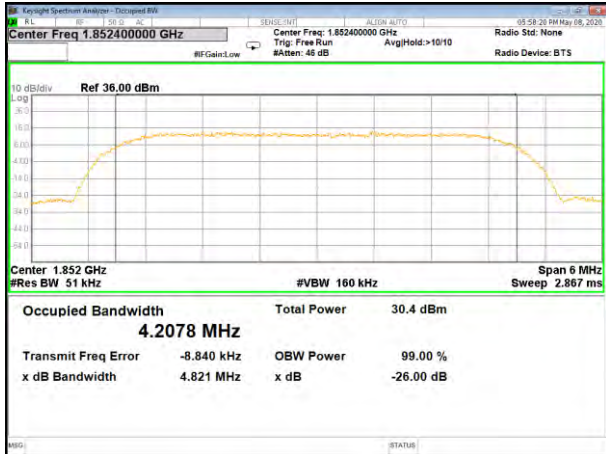

WCDMA B2 26BW and 99% Low

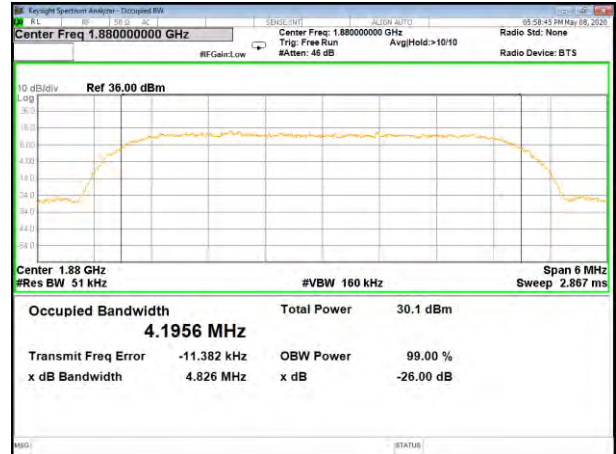

WCDMA B2 26BW and 99% Middle

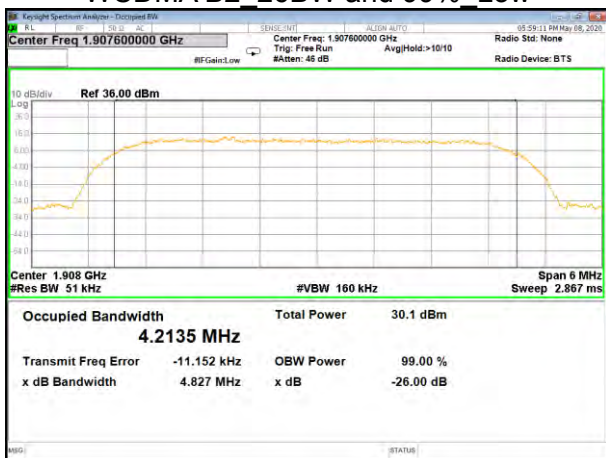

WCDMA B2 26BW and 99% High

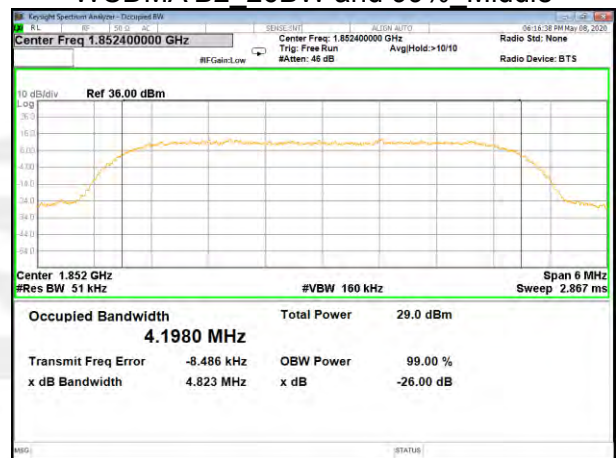

HSDPA B2 26BW and 99% Low

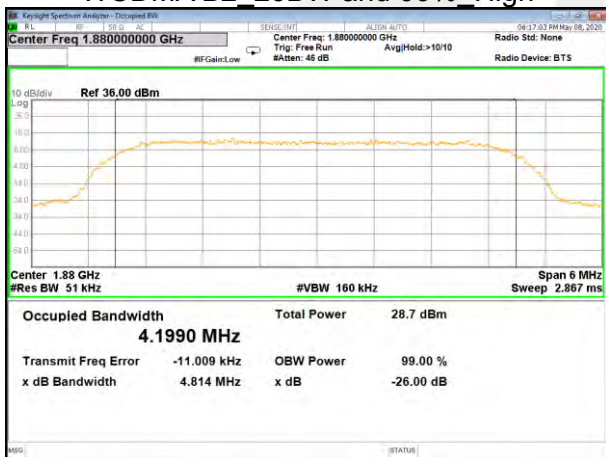

HSDPA B2_26BW and 99%_Middle

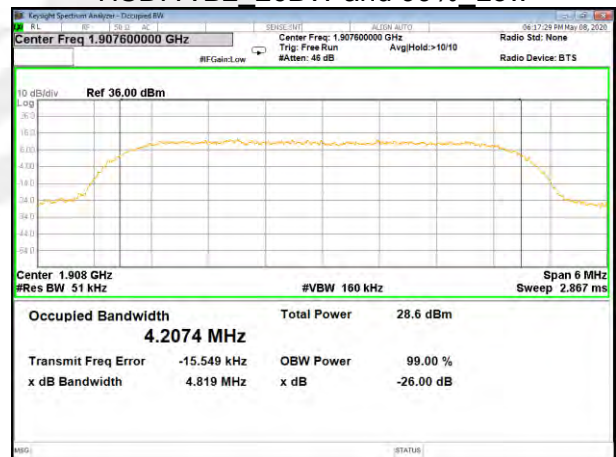

HSDPA B2_26BW and 99%_High

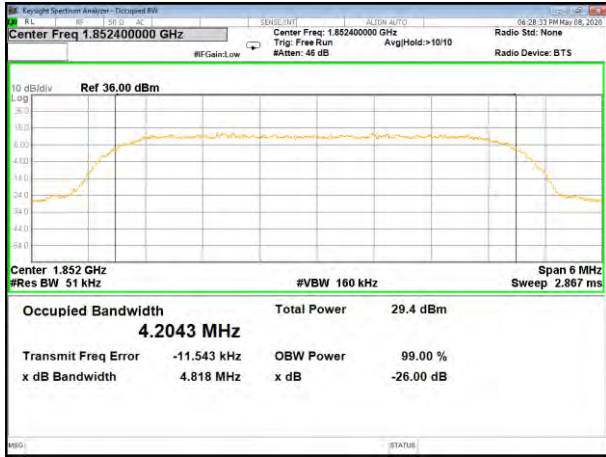

HSUPA B2_26BW and 99% Low

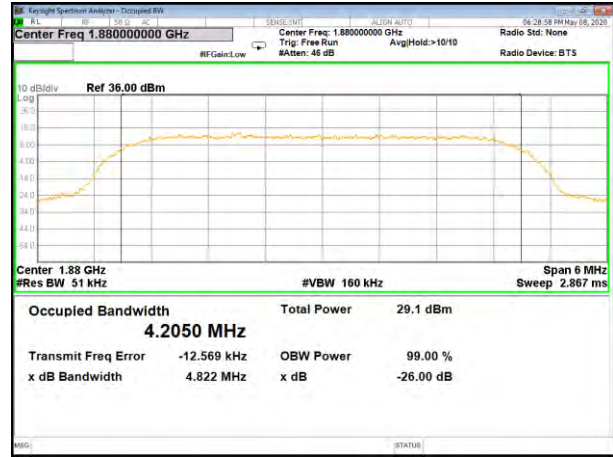

HSUPA B2_26BW and 99% Middle

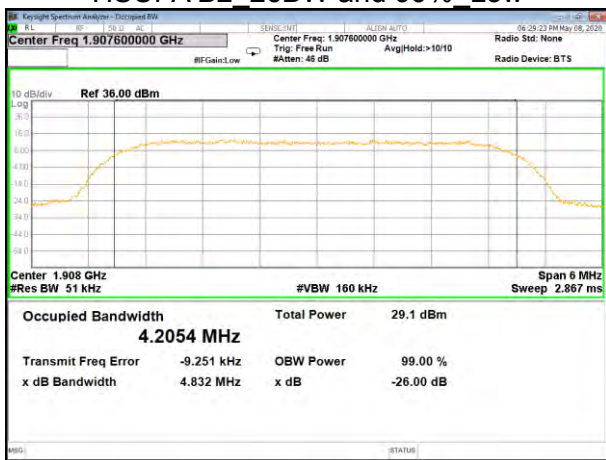

HSUPA B2_26BW and 99% High

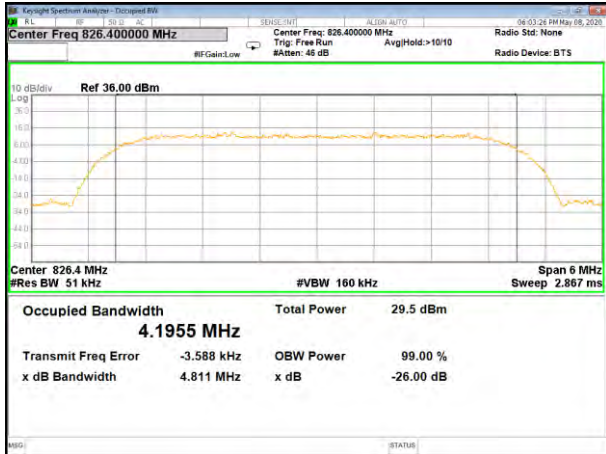

WCDMA B5 26BW and 99% Low

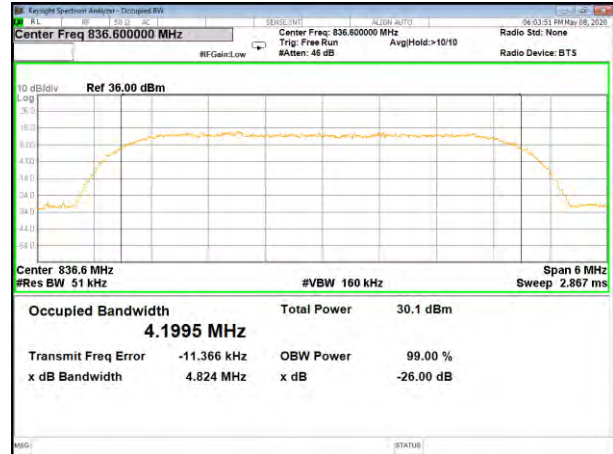

WCDMA B5 26BW and 99% Middle

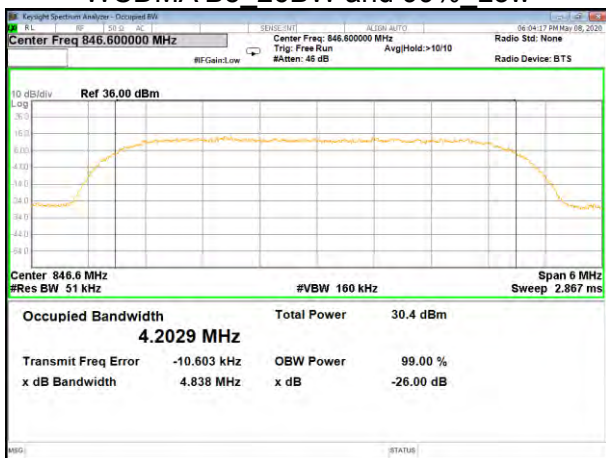

WCDMA B5 26BW and 99% High

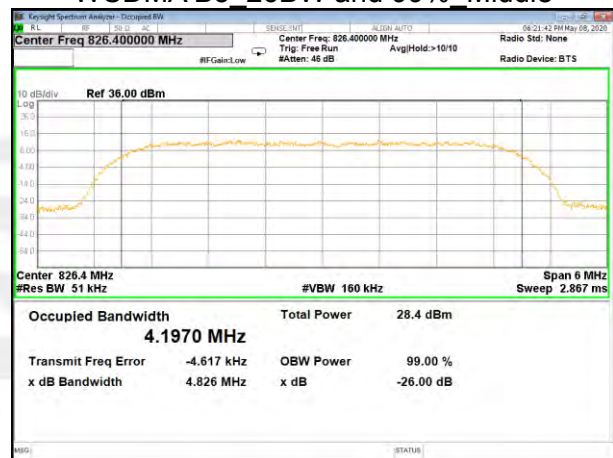

HSDPA B5 26BW and 99% Low

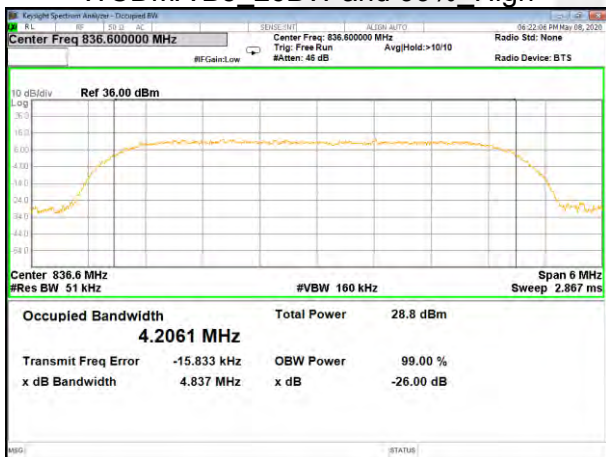

HSDPA B5_26BW and 99%_Middle

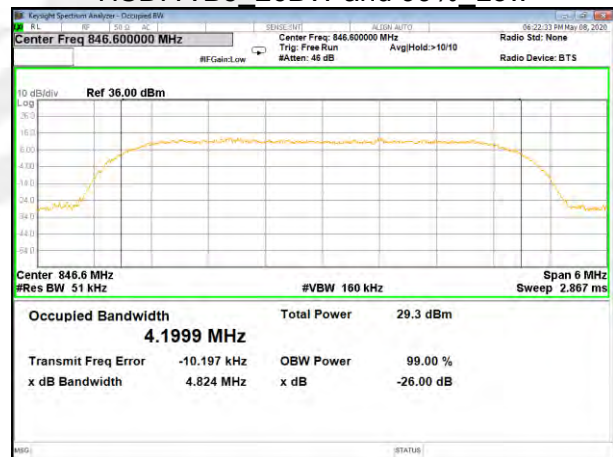

HSDPA B5_26BW and 99%_High

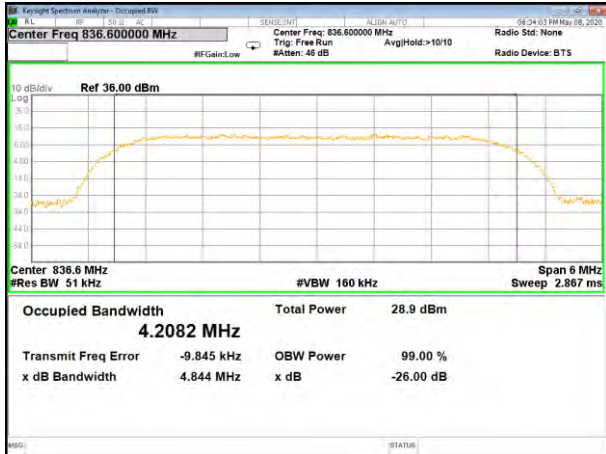

HSUPA B5_26BW and 99%_Middle

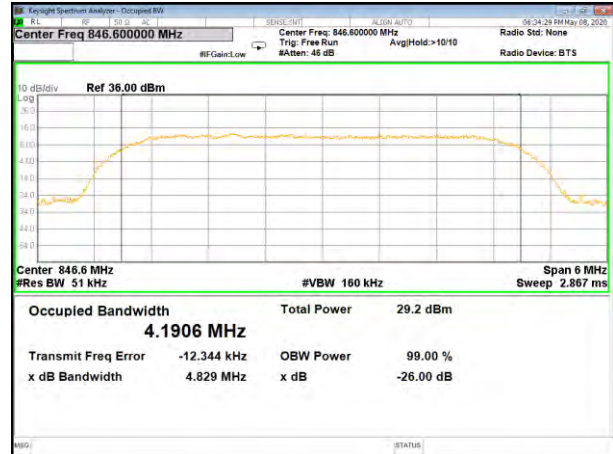

HSUPA B5_26BW and 99%_High





A5.FREQUENCY STABILITY

Normal Voltage = 3.7V; Battery End Point (BEP) = 3.4V; Maximum Voltage =4.2V

GSM 850 /836.6MHz					
Temperature (°C)	Voltage	Freq. Dev.	Freq. Dev.	Limit	Result
	(Volt)	(Hz)	(ppm)		
50	Normal Voltage	27.69	0.033	2.5ppm	PASS
40		36.20	0.043		
30		22.21	0.027		
20		30.64	0.037		
10		27.98	0.033		
0		13.51	0.016		
-10		26.45	0.032		
-20		14.24	0.017		
-30		30.91	0.037		
25		Maximum Voltage	18.16		
25	BEP	29.73	0.036		

GPRS 850 /836.6MHz					
Temperature (°C)	Voltage	Freq. Dev.	Freq. Dev.	Limit	Result
	(Volt)	(Hz)	(ppm)		
50	Normal Voltage	35.97	0.043	2.5ppm	PASS
40		15.79	0.019		
30		17.57	0.021		
20		26.08	0.031		
10		35.69	0.043		
0		19.05	0.023		
-10		27.19	0.033		
-20		35.98	0.043		
-30		21.77	0.026		
25		Maximum Voltage	19.79		
25	BEP	16.08	0.019		

EGPRS 850 /836.6MHz					
Temperature (°C)	Voltage	Freq. Dev.	Freq. Dev.	Limit	Result
	(Volt)	(Hz)	(ppm)		
50	Normal Voltage	22.87	0.027	2.5ppm	PASS
40		20.82	0.025		
30		31.81	0.038		
20		28.61	0.034		
10		20.87	0.025		
0		14.46	0.017		
-10		20.99	0.025		
-20		33.63	0.040		
-30		25.34	0.030		
25		Maximum Voltage	27.91		
25	BEP	26.91	0.032		



GSM 1900 / 1880MHz					
Temperature (°C)	Voltage	Freq. Dev.	Freq. Dev.	Limit	Result
	(Volt)	(Hz)	(ppm)		
50	Normal Voltage	17.14	0.009	Within Authorized Band	PASS
40		11.64	0.006		
30		33.98	0.018		
20		27.37	0.015		
10		31.95	0.017		
0		25.34	0.013		
-10		34.60	0.018		
-20		23.31	0.012		
-30		27.28	0.015		
25		Maximum Voltage	30.91		
25	BEP	27.04	0.014		

GPRS 1900 / 1880MHz					
Temperature (°C)	Voltage	Freq. Dev.	Freq. Dev.	Limit	Result
	(Volt)	(Hz)	(ppm)		
50	Normal Voltage	13.83	0.007	Within Authorized Band	PASS
40		12.56	0.007		
30		29.39	0.016		
20		21.64	0.012		
10		28.58	0.015		
0		29.80	0.016		
-10		12.17	0.006		
-20		25.15	0.013		
-30		15.80	0.008		
25		Maximum Voltage	23.28		
25	BEP	21.49	0.011		

EGPRS 1900 / 1880MHz					
Temperature (°C)	Voltage	Freq. Dev.	Freq. Dev.	Limit	Result
	(Volt)	(Hz)	(ppm)		
50	Normal Voltage	36.34	0.019	Within Authorized Band	PASS
40		12.85	0.007		
30		32.09	0.017		
20		33.91	0.018		
10		28.67	0.015		
0		28.39	0.015		
-10		18.18	0.010		
-20		28.02	0.015		
-30		31.23	0.017		
25		Maximum Voltage	17.27		
25	BEP	28.45	0.015		



UMTS Band II /1880MHz					
Temperature (°C)	Voltage	Freq. Dev.	Freq. Dev.	Limit	Result
	(Volt)	(Hz)	(ppm)		
50	Normal Voltage	19.14	0.010	Within Authorized Band	PASS
40		18.21	0.010		
30		23.16	0.012		
20		13.40	0.007		
10		29.57	0.016		
0		28.81	0.015		
-10		28.89	0.015		
-20		35.86	0.019		
-30		28.01	0.015		
25		Maximum Voltage	24.84		
25	BEP	13.87	0.007		

HSDPA Band II /1880MHz					
Temperature (°C)	Voltage	Freq. Dev.	Freq. Dev.	Limit	Result
	(Volt)	(Hz)	(ppm)		
50	Normal Voltage	32.19	0.017	Within Authorized Band	PASS
40		20.93	0.011		
30		14.45	0.008		
20		13.41	0.007		
10		34.41	0.018		
0		26.09	0.014		
-10		13.86	0.007		
-20		13.14	0.007		
-30		34.77	0.018		
25		Maximum Voltage	14.97		
25	BEP	26.50	0.014		

HSUPA Band II /1880MHz					
Temperature (°C)	Voltage	Freq. Dev.	Freq. Dev.	Limit	Result
	(Volt)	(Hz)	(ppm)		
50	Normal Voltage	24.99	0.013	Within Authorized Band	PASS
40		21.84	0.012		
30		21.13	0.011		
20		35.38	0.019		
10		23.70	0.013		
0		32.01	0.017		
-10		15.67	0.008		
-20		32.84	0.017		
-30		35.76	0.019		
25		Maximum Voltage	24.00		
25	BEP	16.20	0.009		



UMTS Band V / 836.6MHz					
Temperature (°C)	Voltage	Freq. Dev.	Freq. Dev.	Limit	Result
	(Volt)	(Hz)	(ppm)		
50	Normal Voltage	22.82	0.027	2.5ppm	PASS
40		18.36	0.022		
30		22.06	0.026		
20		16.18	0.019		
10		28.90	0.035		
0		30.33	0.036		
-10		23.16	0.028		
-20		34.55	0.041		
-30		24.60	0.029		
25		Maximum Voltage	16.92		
25	BEP	28.21	0.034		

HSDPA Band V / 836.6MHz					
Temperature (°C)	Voltage	Freq. Dev.	Freq. Dev.	Limit	Result
	(Volt)	(Hz)	(ppm)		
50	Normal Voltage	20.58	0.025	2.5ppm	PASS
40		33.56	0.040		
30		23.62	0.028		
20		32.33	0.039		
10		25.23	0.030		
0		22.39	0.027		
-10		29.45	0.035		
-20		35.39	0.042		
-30		12.39	0.015		
25		Maximum Voltage	31.93		
25	BEP	33.85	0.040		

HSUPA Band V / 836.6MHz					
Temperature (°C)	Voltage	Freq. Dev.	Freq. Dev.	Limit	Result
	(Volt)	(Hz)	(ppm)		
50	Normal Voltage	28.77	0.034	2.5ppm	PASS
40		18.83	0.023		
30		23.23	0.028		
20		30.23	0.036		
10		21.29	0.025		
0		12.11	0.014		
-10		29.71	0.036		
-20		24.78	0.030		
-30		14.16	0.017		
25		Maximum Voltage	19.61		
25	BEP	13.85	0.017		

1. The frequency fundamental emissions stay within the authorized frequency block based on the frequency deviation measured is small.



A6. SPURIOUS EMISSIONS AT ANTENNA TERMINALS

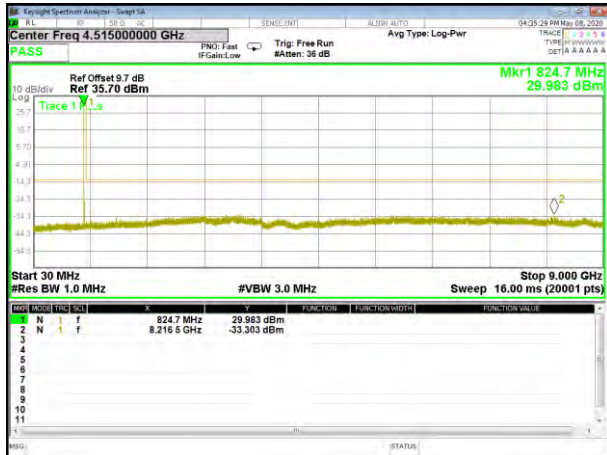

GSM_850_Lower_Conducted_Spurious



GPRS_850_Lower_Conducted_Spurious

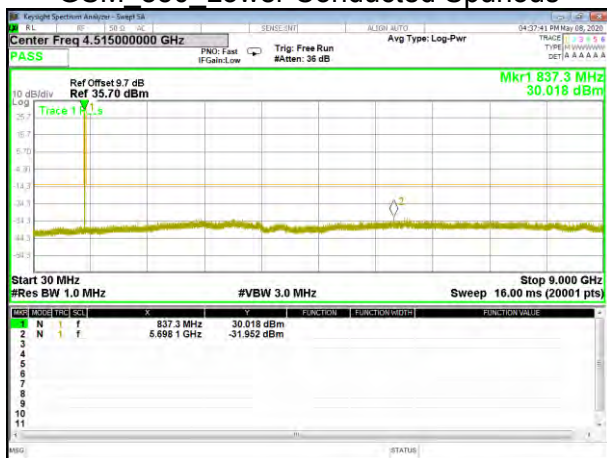

GSM_850_Middle_Conducted_Spurious



GPRS_850_Middle_Conducted_Spurious

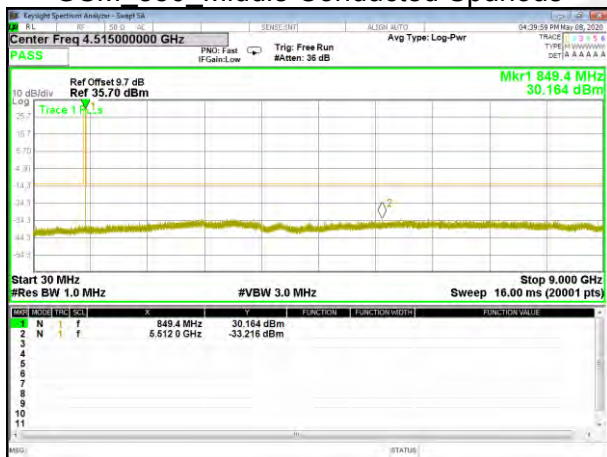

GSM_850_Higher_Conducted_Spurious



GPRS_850_Higher_Conducted_Spurious



EGPRS_850_Lower_Conducted Spurious



EGPRS_850_Middle_Conducted Spurious



EGPRS_850_Higher_Conducted Spurious

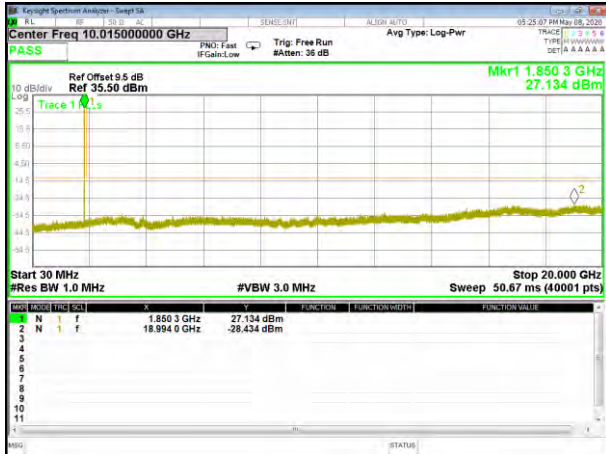

GSM 1900 Lower Conducted Spurious

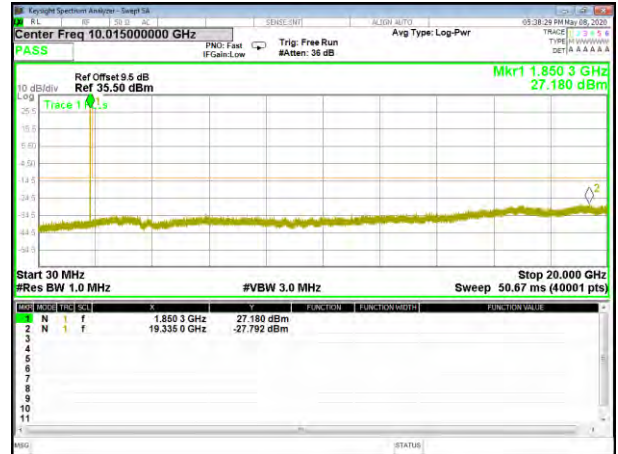

GPRS 1900 Lower Conducted Spurious

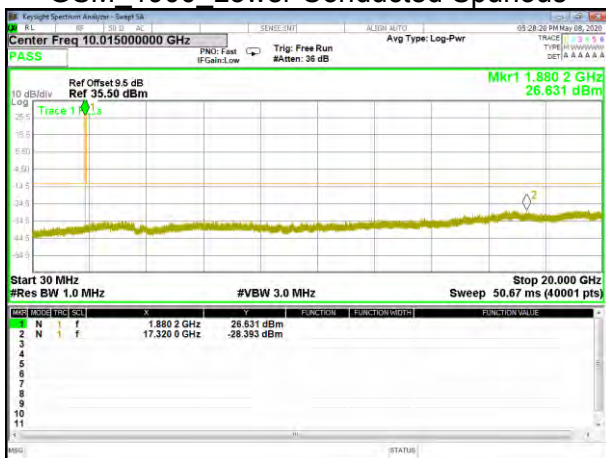

GSM 1900 Middle Conducted Spurious

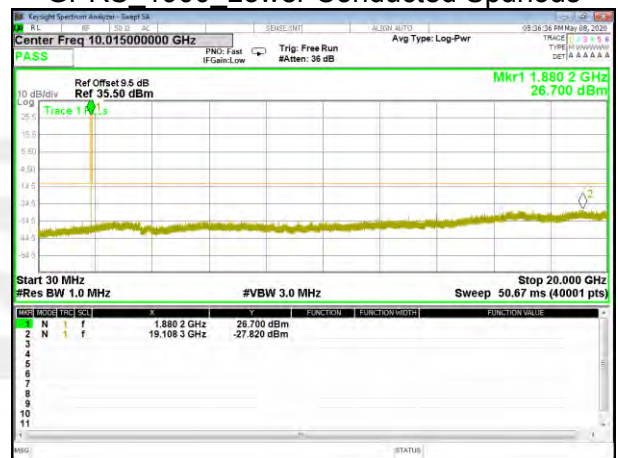

GPRS 1900 Middle Conducted Spurious

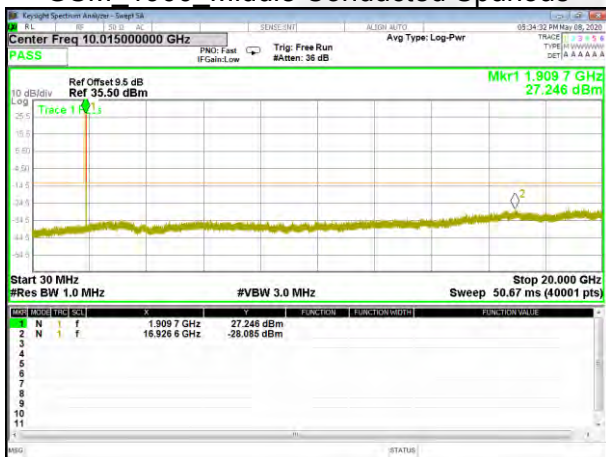

GPRS_1900_Higher Conducted Spurious

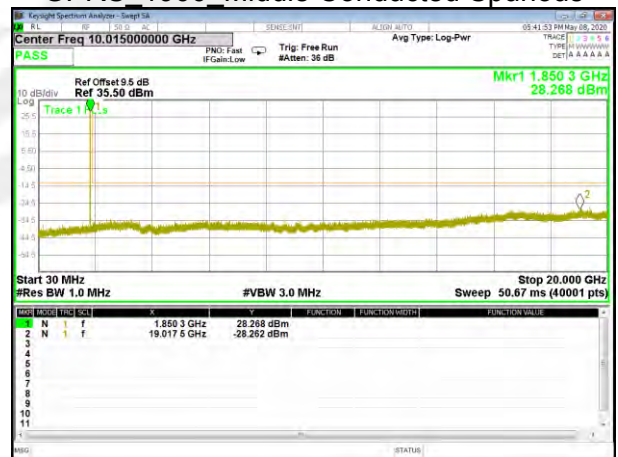

EGPRS_1900_Lower Conducted Spurious

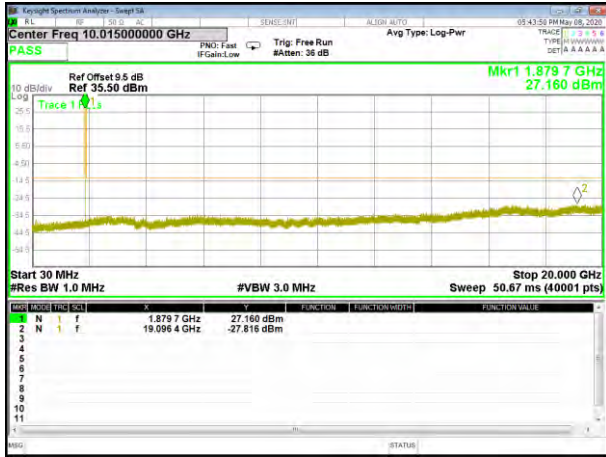

EGPRS_1900_Middle Conducted Spurious

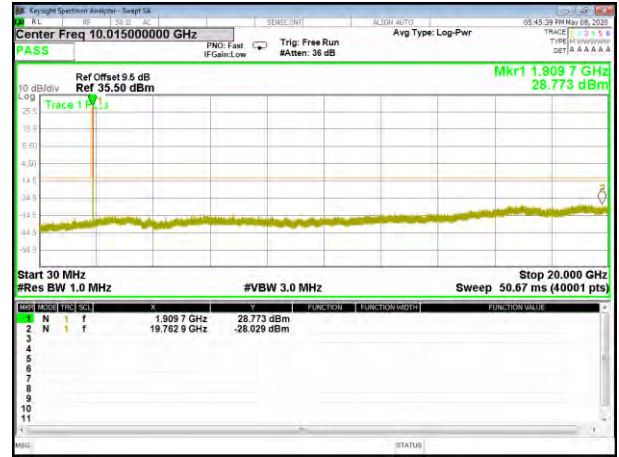

EGPRS_1900_Higher Conducted Spurious





WCDMA B2 Conducted Spurious_Low

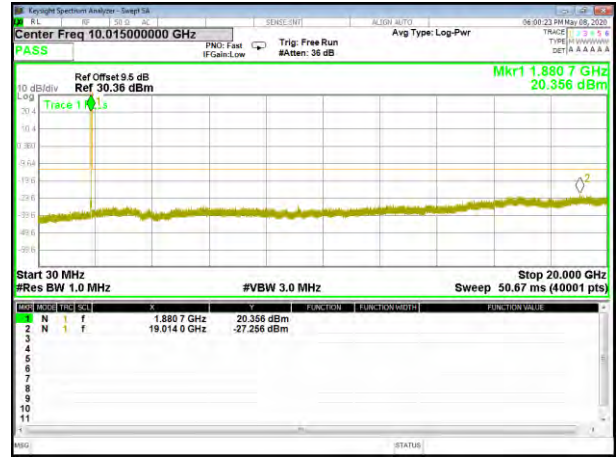

WCDMA B2 Conducted Spurious_Middle



WCDMA B2 Conducted Spurious_High

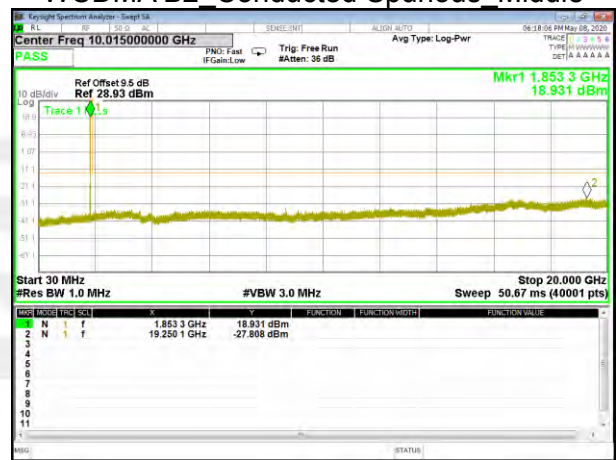

HSDPA B2 Conducted Spurious_Low

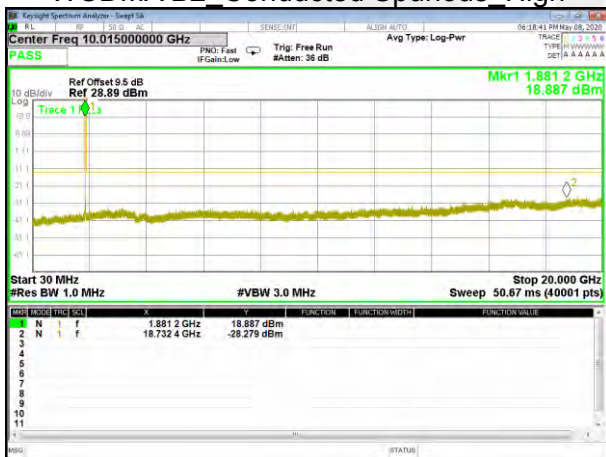

HSDPA B2 Conducted Spurious_Middle

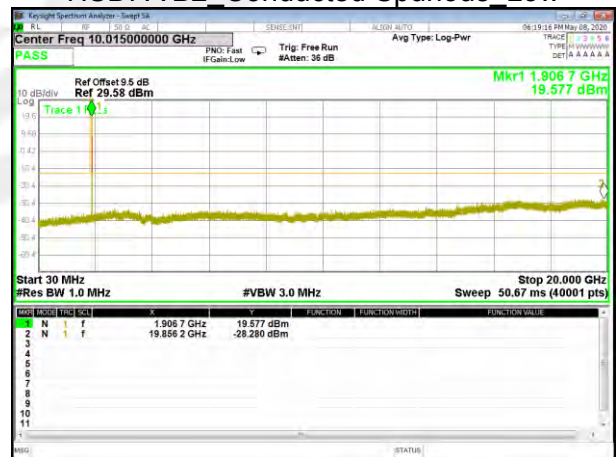

HSDPA B2 Conducted Spurious_High

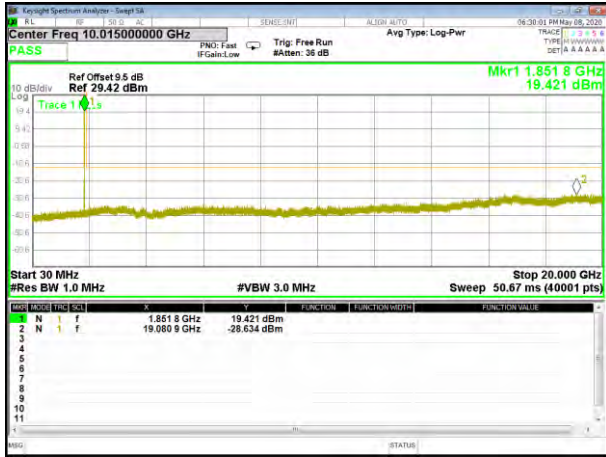

HSUPA B2_Conducted Spurious_Low

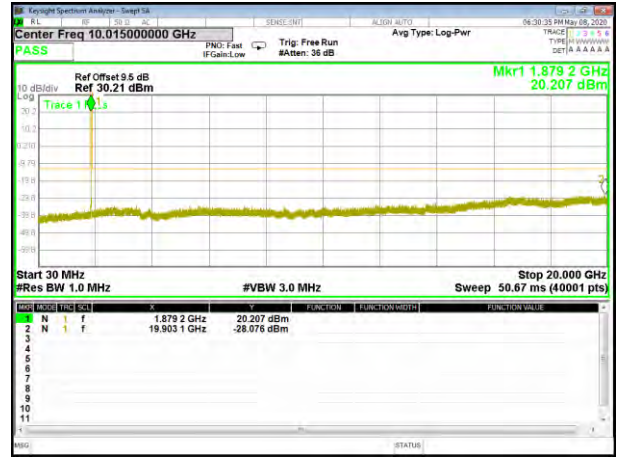

HSUPA B2_Conducted Spurious_Middle



HSUPA B2_Conducted Spurious_High



WCDMA B5 Conducted Spurious_Low



WCDMA B5 Conducted Spurious_Middle



WCDMA B5 Conducted Spurious_High

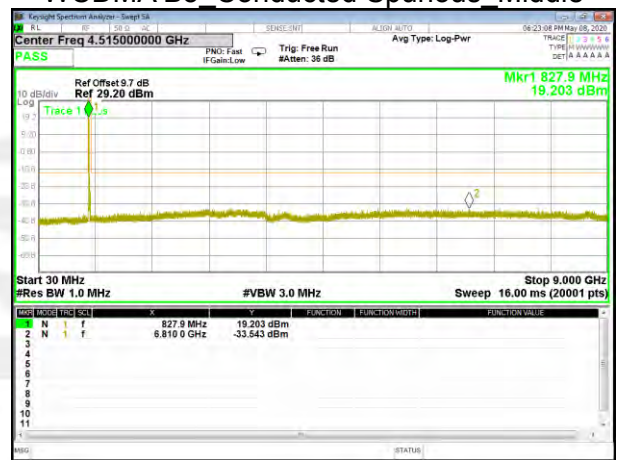

HSDPA B5 Conducted Spurious_Low

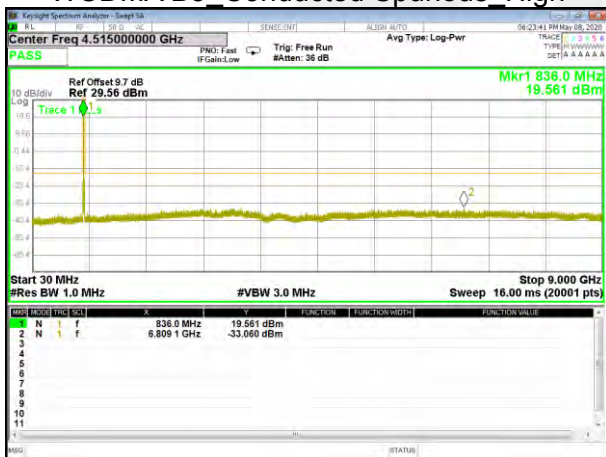

HSDPA B5 Conducted Spurious_Middle



HSDPA B5 Conducted Spurious_High



HSUPA B5_Conducted Spurious_Low



HSUPA B5_Conducted Spurious_Middle



HSUPA B5_Conducted Spurious_High



A7. BAND EDGE

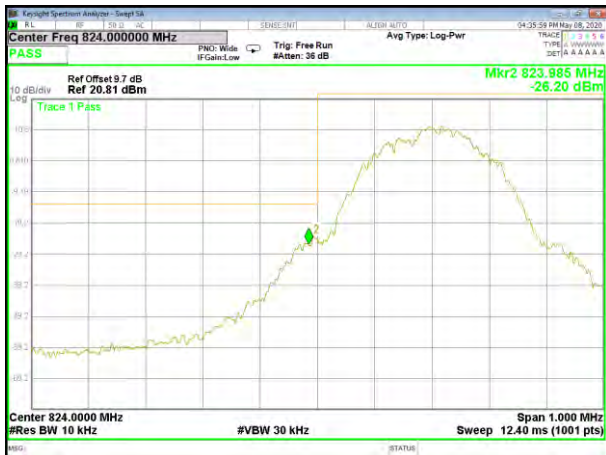

GSM 850 Lower Band edge

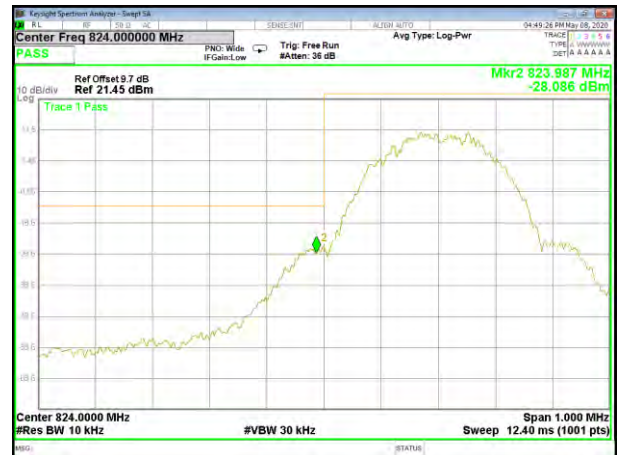

GPRS 850 Lower Band edge



GSM 850 Higher Band edge



GPRS 850 Higher Band edge



EGPRS_850_Lower_Band edge



EGPRS_850_Higher_Band edge

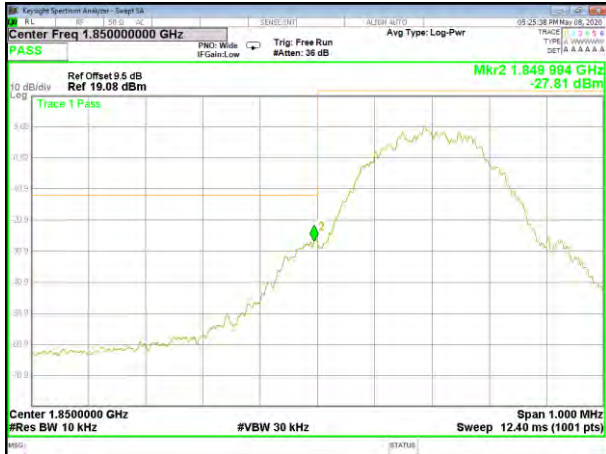

GSM 1900 Lower Band edge

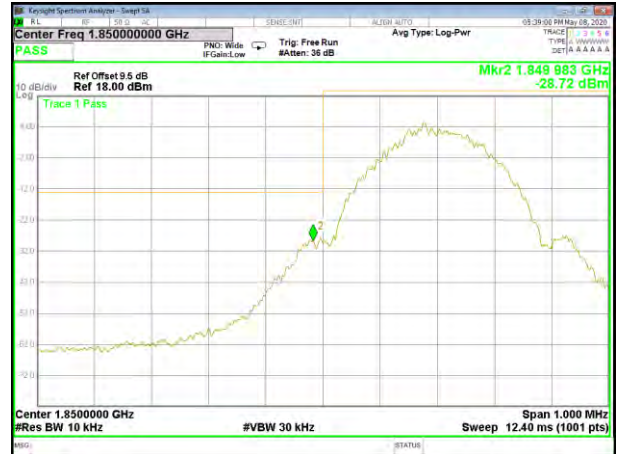

GPRS 1900 Lower Band edge

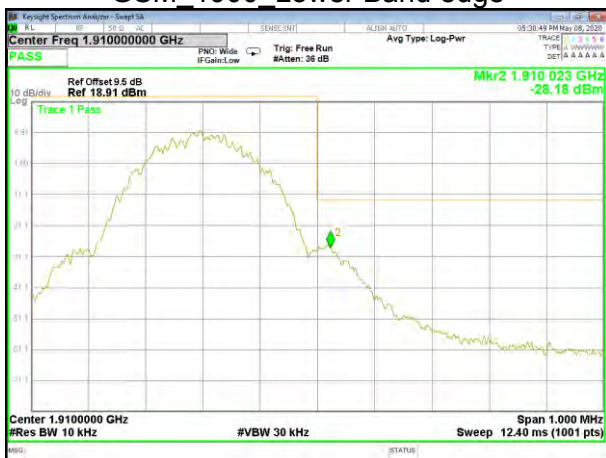

GSM 1900 Higher Band edge



GPRS 1900 Higher Band edge



EGPRS_1900_Lower Band edge



EGPRS_1900_Higher Band edge

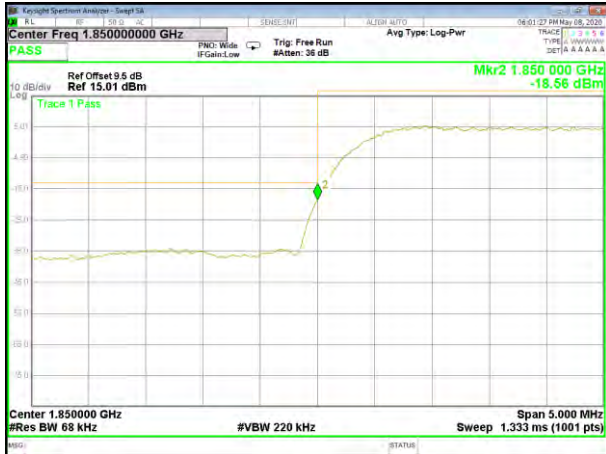

WCDMA B2_Band edge_Low



WCDMA B2_Band edge_High

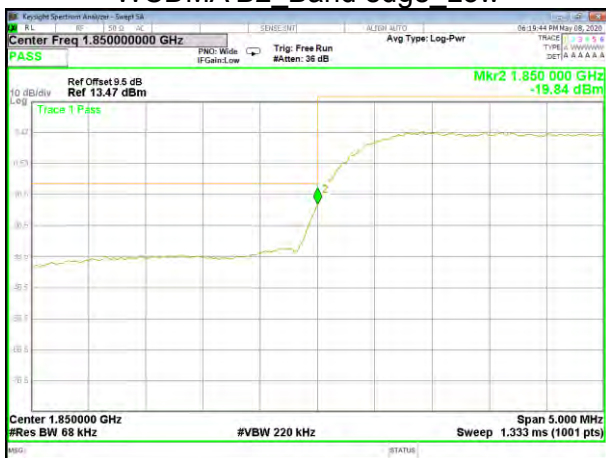

HSDPA B2_Band edge_Low



HSDPA B2_Band edge_High



HSUPA B2_Band edge_Low



HSUPA B2_Band edge_High



WCDMA B5_Band edge_Low



WCDMA B5_Band edge_High

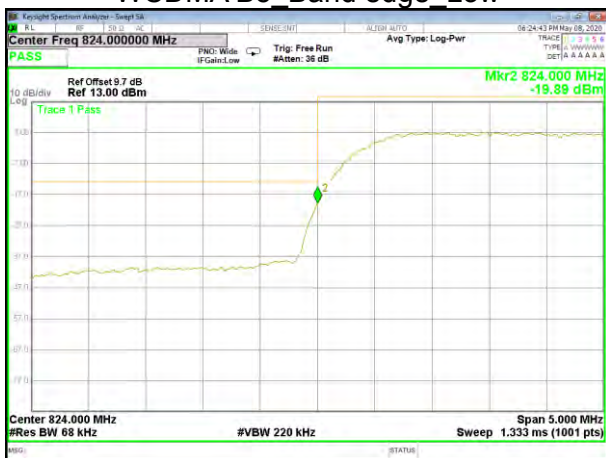

HSDPA B5_Band edge_Low



HSDPA B5_Band edge_High



HSUPA B5_Band edge_Low



HSUPA B5_Band edge_High



A8. FIELD STRENGTH OF SPURIOUS RADIATION MEASUREMENT

Note: (1) Below 30MHz no Spurious found is the worst condition.

(2) Above 3.5GHz amplitude of spurious emissions which are attenuated by more than 20dB below the permissible value

(3) Test is divided into three directions, X/Y/Z. X pattern for the worst.

GSM 850: (30-9000)MHz							
The Worst Test Results Channel 128/824.2 MHz							
Frequency(MHz)	S G.Lev (dBm)	Ant(dBi)	Loss	PMea	Limit	Margin	Polarity
				(dBm)	(dBm)	(dBm)	
1648.25	-40.23	9.40	4.75	-35.58	-13.00	-22.58	H
2472.26	-39.87	10.60	8.39	-37.66	-13.00	-24.66	H
3296.69	-32.28	12.00	11.79	-32.07	-13.00	-19.07	H
1648.12	-44.16	9.40	4.75	-39.51	-13.00	-26.51	V
2472.47	-44.32	10.60	8.39	-42.11	-13.00	-29.11	V
3296.59	-42.57	12.00	11.79	-42.36	-13.00	-29.36	V
The Worst Test Results Channel 190/836.6 MHz							
Frequency(MHz)	S G.Lev (dBm)	Ant(dBi)	Loss	PMea	Limit	Margin	Polarity
				(dBm)	(dBm)	(dBm)	
1673.06	-40.98	9.50	4.76	-36.24	-13.00	-23.24	H
2509.77	-40.46	10.70	8.40	-38.16	-13.00	-25.16	H
3346.00	-31.50	12.20	11.80	-31.10	-13.00	-18.10	H
1673.07	-43.30	9.40	4.75	-38.65	-13.00	-25.65	V
2509.77	-45.00	10.60	8.39	-42.79	-13.00	-29.79	V
3346.36	-42.68	12.20	11.82	-42.30	-13.00	-29.30	V
The Worst Test Results Channel 251/848.8 MHz							
Frequency(MHz)	S G.Lev (dBm)	Ant(dBi)	Loss	PMea	Limit	Margin	Polarity
				(dBm)	(dBm)	(dBm)	
1697.18	-40.33	9.60	4.77	-35.50	-13.00	-22.50	H
2546.24	-39.20	10.80	8.50	-36.90	-13.00	-23.90	H
3395.06	-32.11	12.50	11.90	-31.51	-13.00	-18.51	H
1697.21	-43.71	9.60	4.77	-38.88	-13.00	-25.88	V
2546.31	-44.87	10.80	8.50	-42.57	-13.00	-29.57	V
3395.08	-43.10	12.50	11.90	-42.50	-13.00	-29.50	V



GPRS 850: (30-9000)MHz							
The Worst Test Results Channel 128/824.2 MHz							
Frequency(MHz)	S G.Lev (dBm)	Ant(dBi)	Loss	PMea	Limit	Margin	Polarity
				(dBm)	(dBm)	(dBm)	
1648.04	-40.65	9.40	4.75	-36.00	-13.00	-23.00	H
2472.70	-40.29	10.60	8.39	-38.08	-13.00	-25.08	H
3296.59	-31.80	12.00	11.79	-31.59	-13.00	-18.59	H
1648.07	-43.46	9.40	4.75	-38.81	-13.00	-25.81	V
2472.35	-45.20	10.60	8.39	-42.99	-13.00	-29.99	V
3296.47	-43.24	12.00	11.79	-43.03	-13.00	-30.03	V
The Worst Test Results Channel 190/836.6 MHz							
Frequency(MHz)	S G.Lev (dBm)	Ant(dBi)	Loss	PMea	Limit	Margin	Polarity
				(dBm)	(dBm)	(dBm)	
1673.04	-40.77	9.50	4.76	-36.03	-13.00	-23.03	H
2509.87	-39.40	10.70	8.40	-37.10	-13.00	-24.10	H
3346.31	-31.91	12.20	11.80	-31.51	-13.00	-18.51	H
1672.87	-43.78	9.40	4.75	-39.13	-13.00	-26.13	V
2509.47	-45.16	10.60	8.39	-42.95	-13.00	-29.95	V
3345.99	-43.44	12.20	11.82	-43.06	-13.00	-30.06	V
The Worst Test Results Channel 251/848.8 MHz							
Frequency(MHz)	S G.Lev (dBm)	Ant(dBi)	Loss	PMea	Limit	Margin	Polarity
				(dBm)	(dBm)	(dBm)	
1697.34	-40.71	9.60	4.77	-35.88	-13.00	-22.88	H
2546.27	-40.19	10.80	8.50	-37.89	-13.00	-24.89	H
3395.16	-31.08	12.50	11.90	-30.48	-13.00	-17.48	H
1697.62	-43.73	9.60	4.77	-38.90	-13.00	-25.90	V
2546.06	-44.02	10.80	8.50	-41.72	-13.00	-28.72	V
3395.31	-43.59	12.50	11.90	-42.99	-13.00	-29.99	V



EGPRS 850: (30-9000)MHz							
The Worst Test Results Channel 128/824.2 MHz							
Frequency(MHz)	S G.Lev (dBm)	Ant(dBi)	Loss	PMea	Limit	Margin	Polarity
				(dBm)	(dBm)	(dBm)	
1648.14	-41.61	9.40	4.75	-36.96	-13.00	-23.96	H
2472.53	-39.21	10.60	8.39	-37.00	-13.00	-24.00	H
3296.66	-31.60	12.00	11.79	-31.39	-13.00	-18.39	H
1648.16	-43.23	9.40	4.75	-38.58	-13.00	-25.58	V
2472.56	-44.94	10.60	8.39	-42.73	-13.00	-29.73	V
3296.57	-42.52	12.00	11.79	-42.31	-13.00	-29.31	V
The Worst Test Results Channel 190/836.6 MHz							
Frequency(MHz)	S G.Lev (dBm)	Ant(dBi)	Loss	PMea	Limit	Margin	Polarity
				(dBm)	(dBm)	(dBm)	
1673.01	-41.38	9.50	4.76	-36.64	-13.00	-23.64	H
2509.52	-40.03	10.70	8.40	-37.73	-13.00	-24.73	H
3346.32	-32.00	12.20	11.80	-31.60	-13.00	-18.60	H
1673.08	-44.06	9.40	4.75	-39.41	-13.00	-26.41	V
2509.74	-44.58	10.60	8.39	-42.37	-13.00	-29.37	V
3346.35	-43.81	12.20	11.82	-43.43	-13.00	-30.43	V
The Worst Test Results Channel 251/848.8 MHz							
Frequency(MHz)	S G.Lev (dBm)	Ant(dBi)	Loss	PMea	Limit	Margin	Polarity
				(dBm)	(dBm)	(dBm)	
1697.35	-40.85	9.60	4.77	-36.02	-13.00	-23.02	H
2546.27	-39.59	10.80	8.50	-37.29	-13.00	-24.29	H
3394.88	-31.10	12.50	11.90	-30.50	-13.00	-17.50	H
1697.57	-44.01	9.60	4.77	-39.18	-13.00	-26.18	V
2546.31	-44.31	10.80	8.50	-42.01	-13.00	-29.01	V
3395.04	-43.36	12.50	11.90	-42.76	-13.00	-29.76	V



DCS 1900: (30-20000)MHz							
The Worst Test Results for Channel 512/1850.2MHz							
Frequency(MHz)	S G.Lev (dBm)	Ant(dBi)	Loss	PMea	Limit	Margin	Polarity
				(dBm)	(dBm)	(dBm)	
3700.39	-34.74	12.60	12.93	-35.07	-13.00	-22.07	H
5550.63	-34.31	13.10	17.11	-38.32	-13.00	-25.32	H
7400.62	-32.60	11.50	22.20	-43.30	-13.00	-30.30	H
3700.23	-34.95	12.60	12.93	-35.28	-13.00	-22.28	V
5550.31	-34.63	13.10	17.11	-38.64	-13.00	-25.64	V
7400.53	-32.44	11.50	22.20	-43.14	-13.00	-30.14	V
The Worst Test Results for Channel 661/1880.0MHz							
Frequency(MHz)	S G.Lev (dBm)	Ant(dBi)	Loss	PMea	Limit	Margin	Polarity
				(dBm)	(dBm)	(dBm)	
3760.10	-34.39	12.60	12.93	-34.72	-13.00	-21.72	H
5639.88	-34.13	13.10	17.11	-38.14	-13.00	-25.14	H
7519.86	-33.21	11.50	22.20	-43.91	-13.00	-30.91	H
3759.86	-34.96	12.60	12.93	-35.29	-13.00	-22.29	V
5640.18	-34.34	13.10	17.11	-38.35	-13.00	-25.35	V
7520.07	-32.39	11.50	22.20	-43.09	-13.00	-30.09	V
The Worst Test Results for Channel 810/1909.8MHz							
Frequency(MHz)	S G.Lev (dBm)	Ant(dBi)	Loss	PMea	Limit	Margin	Polarity
				(dBm)	(dBm)	(dBm)	
3819.25	-34.32	12.60	12.93	-34.65	-13.00	-21.65	H
5729.04	-35.13	13.10	17.11	-39.14	-13.00	-26.14	H
7639.06	-32.63	11.50	22.20	-43.33	-13.00	-30.33	H
3819.45	-35.54	12.60	12.93	-35.87	-13.00	-22.87	V
5729.19	-35.20	13.10	17.11	-39.21	-13.00	-26.21	V
7639.07	-32.55	11.50	22.20	-43.25	-13.00	-30.25	V



GPRS1900: (30-20000)MHz							
The Worst Test Results for Channel 512/1850.2MHz							
Frequency(MHz)	S G.Lev (dBm)	Ant(dBi)	Loss	PMea	Limit	Margin	Polarity
				(dBm)	(dBm)	(dBm)	
3700.42	-34.08	12.60	12.93	-34.41	-13.00	-21.41	H
5550.57	-34.19	13.10	17.11	-38.20	-13.00	-25.20	H
7400.75	-33.43	11.50	22.20	-44.13	-13.00	-31.13	H
3700.18	-34.62	12.60	12.93	-34.95	-13.00	-21.95	V
5550.68	-34.59	13.10	17.11	-38.60	-13.00	-25.60	V
7400.56	-32.94	11.50	22.20	-43.64	-13.00	-30.64	V
The Worst Test Results for Channel 661/1880.0MHz							
Frequency(MHz)	S G.Lev (dBm)	Ant(dBi)	Loss	PMea	Limit	Margin	Polarity
				(dBm)	(dBm)	(dBm)	
3760.00	-33.56	12.60	12.93	-33.89	-13.00	-20.89	H
5640.01	-35.20	13.10	17.11	-39.21	-13.00	-26.21	H
7519.95	-32.30	11.50	22.20	-43.00	-13.00	-30.00	H
3759.87	-34.76	12.60	12.93	-35.09	-13.00	-22.09	V
5640.19	-33.93	13.10	17.11	-37.94	-13.00	-24.94	V
7519.95	-33.18	11.50	22.20	-43.88	-13.00	-30.88	V
The Worst Test Results for Channel 810/1909.8MHz							
Frequency(MHz)	S G.Lev (dBm)	Ant(dBi)	Loss	PMea	Limit	Margin	Polarity
				(dBm)	(dBm)	(dBm)	
3819.29	-34.46	12.60	12.93	-34.79	-13.00	-21.79	H
5729.01	-34.69	13.10	17.11	-38.70	-13.00	-25.70	H
7638.98	-32.86	11.50	22.20	-43.56	-13.00	-30.56	H
3819.59	-35.16	12.60	12.93	-35.49	-13.00	-22.49	V
5729.19	-33.78	13.10	17.11	-37.79	-13.00	-24.79	V
7639.24	-32.02	11.50	22.20	-42.72	-13.00	-29.72	V



EGPRS 1900: (30-20000)MHz							
The Worst Test Results for Channel 512/1850.2MHz							
Frequency(MHz)	S G.Lev (dBm)	Ant(dBi)	Loss	PMea	Limit	Margin	Polarity
				(dBm)	(dBm)	(dBm)	
3700.31	-34.26	12.60	12.93	-34.59	-13.00	-21.59	H
5550.42	-34.09	13.10	17.11	-38.10	-13.00	-25.10	H
7400.75	-33.14	11.50	22.20	-43.84	-13.00	-30.84	H
3700.17	-36.02	12.60	12.93	-36.35	-13.00	-23.35	V
5550.64	-33.95	13.10	17.11	-37.96	-13.00	-24.96	V
7400.81	-32.27	11.50	22.20	-42.97	-13.00	-29.97	V
The Worst Test Results for Channel 661/1880.0MHz							
Frequency(MHz)	S G.Lev (dBm)	Ant(dBi)	Loss	PMea	Limit	Margin	Polarity
				(dBm)	(dBm)	(dBm)	
3760.07	-34.53	12.60	12.93	-34.86	-13.00	-21.86	H
5639.95	-34.10	13.10	17.11	-38.11	-13.00	-25.11	H
7520.02	-33.35	11.50	22.20	-44.05	-13.00	-31.05	H
3760.22	-35.96	12.60	12.93	-36.29	-13.00	-23.29	V
5640.02	-34.08	13.10	17.11	-38.09	-13.00	-25.09	V
7520.03	-31.80	11.50	22.20	-42.50	-13.00	-29.50	V
The Worst Test Results for Channel 810/1909.8MHz							
Frequency(MHz)	S G.Lev (dBm)	Ant(dBi)	Loss	PMea	Limit	Margin	Polarity
				(dBm)	(dBm)	(dBm)	
3819.59	-34.71	12.60	12.93	-35.04	-13.00	-22.04	H
5729.18	-34.90	13.10	17.11	-38.91	-13.00	-25.91	H
7638.84	-33.01	11.50	22.20	-43.71	-13.00	-30.71	H
3819.80	-35.12	12.60	12.93	-35.45	-13.00	-22.45	V
5729.22	-34.97	13.10	17.11	-38.98	-13.00	-25.98	V
7638.93	-31.92	11.50	22.20	-42.62	-13.00	-29.62	V



WCDMA Band V: (30-9000)MHz							
The most testresults channel 4132/826.4MHz							
Frequency(MHz)	S G.Lev (dBm)	Ant(dBi)	Loss	PMea	Limit	Margin	Polarity
				(dBm)	(dBm)	(dBm)	
1652.32	-40.32	9.40	4.75	-35.67	-13.00	-22.67	H
2479.58	-40.62	10.60	8.39	-38.41	-13.00	-25.41	H
3305.77	-30.99	12.00	11.79	-30.78	-13.00	-17.78	H
1652.43	-44.38	9.40	4.75	-39.73	-13.00	-26.73	V
2479.55	-44.09	10.60	8.39	-41.88	-13.00	-28.88	V
3305.50	-43.47	12.00	11.79	-43.26	-13.00	-30.26	V
The Worst Test Results Channel 4183/836.6MHz							
Frequency(MHz)	S G.Lev (dBm)	Ant(dBi)	Loss	PMea	Limit	Margin	Polarity
				(dBm)	(dBm)	(dBm)	
1672.82	-41.34	9.40	4.75	-36.69	-13.00	-23.69	H
2509.55	-40.63	10.60	8.39	-38.42	-13.00	-25.42	H
3346.11	-32.00	12.00	11.79	-31.79	-13.00	-18.79	H
1672.98	-43.90	9.40	4.75	-39.25	-13.00	-26.25	V
2509.50	-45.16	10.60	8.39	-42.95	-13.00	-29.95	V
3346.21	-43.45	12.00	11.79	-43.24	-13.00	-30.24	V
The Worst Test Results Channel 4233/846.6MHz							
Frequency(MHz)	S G.Lev (dBm)	Ant(dBi)	Loss	PMea	Limit	Margin	Polarity
				(dBm)	(dBm)	(dBm)	
1693.30	-40.53	9.40	4.75	-35.88	-13.00	-22.88	H
2539.18	-40.42	10.60	8.39	-38.21	-13.00	-25.21	H
3386.20	-31.22	12.00	11.79	-31.01	-13.00	-18.01	H
1693.31	-44.33	9.40	4.75	-39.68	-13.00	-26.68	V
2539.26	-45.36	10.60	8.39	-43.15	-13.00	-30.15	V
3385.90	-42.69	12.00	11.79	-42.48	-13.00	-29.48	V



HSUPA Band V: (30-9000)MHz							
The most testresults channel 4132/826.4MHz							
Frequency(MHz)	S G.Lev (dBm)	Ant(dBi)	Loss	PMea	Limit	Margin	Polarity
				(dBm)	(dBm)	(dBm)	
1652.26	-41.51	9.40	4.75	-36.86	-13.00	-23.86	H
2479.28	-40.32	10.60	8.39	-38.11	-13.00	-25.11	H
3305.78	-31.88	12.00	11.79	-31.67	-13.00	-18.67	H
1652.27	-44.41	9.40	4.75	-39.76	-13.00	-26.76	V
2479.35	-44.80	10.60	8.39	-42.59	-13.00	-29.59	V
3305.77	-43.03	12.00	11.79	-42.82	-13.00	-29.82	V
The Worst Test Results Channel 4183/836.6MHz							
Frequency(MHz)	S G.Lev (dBm)	Ant(dBi)	Loss	PMea	Limit	Margin	Polarity
				(dBm)	(dBm)	(dBm)	
1673.04	-40.40	9.40	4.75	-35.75	-13.00	-22.75	H
2509.51	-39.73	10.60	8.39	-37.52	-13.00	-24.52	H
3346.15	-31.59	12.00	11.79	-31.38	-13.00	-18.38	H
1672.90	-44.15	9.40	4.75	-39.50	-13.00	-26.50	V
2509.56	-44.07	10.60	8.39	-41.86	-13.00	-28.86	V
3346.26	-42.93	12.00	11.79	-42.72	-13.00	-29.72	V
The Worst Test Results Channel 4233/846.6MHz							
Frequency(MHz)	S G.Lev (dBm)	Ant(dBi)	Loss	PMea	Limit	Margin	Polarity
				(dBm)	(dBm)	(dBm)	
1693.43	-40.25	9.40	4.75	-35.60	-13.00	-22.60	H
2539.56	-40.41	10.60	8.39	-38.20	-13.00	-25.20	H
3386.25	-31.79	12.00	11.79	-31.58	-13.00	-18.58	H
1693.42	-44.59	9.40	4.75	-39.94	-13.00	-26.94	V
2539.13	-44.20	10.60	8.39	-41.99	-13.00	-28.99	V
3386.23	-43.25	12.00	11.79	-43.04	-13.00	-30.04	V



HSDPA Band V: (30-9000)MHz							
The most testresults channel 4132/826.4MHz							
Frequency(MHz)	S G.Lev (dBm)	Ant(dBi)	Loss	PMea	Limit	Margin	Polarity
				(dBm)	(dBm)	(dBm)	
1652.48	-40.55	9.40	4.75	-35.90	-13.00	-22.90	H
2479.38	-40.07	10.60	8.39	-37.86	-13.00	-24.86	H
3305.78	-31.44	12.00	11.79	-31.23	-13.00	-18.23	H
1652.03	-43.18	9.40	4.75	-38.53	-13.00	-25.53	V
2479.29	-44.00	10.60	8.39	-41.79	-13.00	-28.79	V
3305.68	-43.63	12.00	11.79	-43.42	-13.00	-30.42	V
The Worst Test Results Channel 4183/836.6MHz							
Frequency(MHz)	S G.Lev (dBm)	Ant(dBi)	Loss	PMea	Limit	Margin	Polarity
				(dBm)	(dBm)	(dBm)	
1672.98	-40.85	9.40	4.75	-36.20	-13.00	-23.20	H
2509.61	-40.15	10.60	8.39	-37.94	-13.00	-24.94	H
3346.35	-32.17	12.00	11.79	-31.96	-13.00	-18.96	H
1673.03	-43.52	9.40	4.75	-38.87	-13.00	-25.87	V
2509.72	-44.95	10.60	8.39	-42.74	-13.00	-29.74	V
3346.32	-43.14	12.00	11.79	-42.93	-13.00	-29.93	V
The Worst Test Results Channel 4233/846.6MHz							
Frequency(MHz)	S G.Lev (dBm)	Ant(dBi)	Loss	PMea	Limit	Margin	Polarity
				(dBm)	(dBm)	(dBm)	
1693.42	-40.36	9.40	4.75	-35.71	-13.00	-22.71	H
2539.51	-40.10	10.60	8.39	-37.89	-13.00	-24.89	H
3385.90	-32.17	12.00	11.79	-31.96	-13.00	-18.96	H
1693.24	-43.58	9.40	4.75	-38.93	-13.00	-25.93	V
2539.08	-44.47	10.60	8.39	-42.26	-13.00	-29.26	V
3385.86	-43.70	12.00	11.79	-43.49	-13.00	-30.49	V



WCDMA Band II: (30-20000)MHz							
The Worst Test Results for Channel 9262/1852.4MHz							
Frequency(MHz)	S G.Lev (dBm)	Ant(dBi)	Loss	PMea	Limit	Margin	Polarity
				(dBm)	(dBm)	(dBm)	
3704.02	-34.37	12.60	12.93	-34.70	-13.00	-21.70	H
5557.38	-34.60	13.10	17.11	-38.61	-13.00	-25.61	H
7409.89	-32.85	11.50	22.20	-43.55	-13.00	-30.55	H
3704.06	-35.60	12.60	12.93	-35.93	-13.00	-22.93	V
5557.42	-34.38	13.10	17.11	-38.39	-13.00	-25.39	V
7409.80	-33.00	11.50	22.20	-43.70	-13.00	-30.70	V
The Worst Test Results for Channel 9400/1880MHz							
Frequency(MHz)	S G.Lev (dBm)	Ant(dBi)	Loss	PMea	Limit	Margin	Polarity
				(dBm)	(dBm)	(dBm)	
3759.80	-33.81	12.60	12.93	-34.14	-13.00	-21.14	H
5640.23	-34.84	13.10	17.11	-38.85	-13.00	-25.85	H
7519.91	-33.25	11.50	22.20	-43.95	-13.00	-30.95	H
3760.01	-34.71	12.60	12.93	-35.04	-13.00	-22.04	V
5640.07	-34.58	13.10	17.11	-38.59	-13.00	-25.59	V
7519.89	-31.78	11.50	22.20	-42.48	-13.00	-29.48	V
The Worst Test Results for Channel 9538/1907.6MHz							
Frequency(MHz)	S G.Lev (dBm)	Ant(dBi)	Loss	PMea	Limit	Margin	Polarity
				(dBm)	(dBm)	(dBm)	
3815.72	-34.27	12.60	12.93	-34.60	-13.00	-21.60	H
5722.17	-35.15	13.10	17.11	-39.16	-13.00	-26.16	H
7629.94	-32.27	11.50	22.20	-42.97	-13.00	-29.97	H
3815.25	-35.25	12.60	12.93	-35.58	-13.00	-22.58	V
5722.26	-33.88	13.10	17.11	-37.89	-13.00	-24.89	V
7630.27	-32.42	11.50	22.20	-43.12	-13.00	-30.12	V



HSUPA Band II: (30-20000)MHz							
The Worst Test Results for Channel 9262/1852.4MHz							
Frequency(MHz)	S G.Lev (dBm)	Ant(dBi)	Loss	PMea	Limit	Margin	Polarity
				(dBm)	(dBm)	(dBm)	
3704.14	-34.61	12.60	12.93	-34.94	-13.00	-21.94	H
5557.57	-35.47	13.10	17.11	-39.48	-13.00	-26.48	H
7409.80	-32.46	11.50	22.20	-43.16	-13.00	-30.16	H
3704.49	-35.75	12.60	12.93	-36.08	-13.00	-23.08	V
5557.56	-34.41	13.10	17.11	-38.42	-13.00	-25.42	V
7409.93	-31.73	11.50	22.20	-42.43	-13.00	-29.43	V
The Worst Test Results for Channel 9400/1880MHz							
Frequency(MHz)	S G.Lev (dBm)	Ant(dBi)	Loss	PMea	Limit	Margin	Polarity
				(dBm)	(dBm)	(dBm)	
3759.78	-34.44	12.60	12.93	-34.77	-13.00	-21.77	H
5640.09	-34.91	13.10	17.11	-38.92	-13.00	-25.92	H
7520.19	-33.49	11.50	22.20	-44.19	-13.00	-31.19	H
3760.23	-35.58	12.60	12.93	-35.91	-13.00	-22.91	V
5640.03	-34.87	13.10	17.11	-38.88	-13.00	-25.88	V
7519.83	-32.58	11.50	22.20	-43.28	-13.00	-30.28	V
The Worst Test Results for Channel 9538/1907.6MHz							
Frequency(MHz)	S G.Lev (dBm)	Ant(dBi)	Loss	PMea	Limit	Margin	Polarity
				(dBm)	(dBm)	(dBm)	
3815.51	-33.77	12.60	12.93	-34.10	-13.00	-21.10	H
5722.20	-34.42	13.10	17.11	-38.43	-13.00	-25.43	H
7630.26	-32.51	11.50	22.20	-43.21	-13.00	-30.21	H
3815.43	-35.43	12.60	12.93	-35.76	-13.00	-22.76	V
5722.51	-34.05	13.10	17.11	-38.06	-13.00	-25.06	V
7630.15	-32.62	11.50	22.20	-43.32	-13.00	-30.32	V



HSDPA Band II: (30-20000)MHz							
The Worst Test Results for Channel 9262/1852.4MHz							
Frequency(MHz)	S G.Lev (dBm)	Ant(dBi)	Loss	PMea	Limit	Margin	Polarity
				(dBm)	(dBm)	(dBm)	
3704.41	-34.23	12.60	12.93	-34.56	-13.00	-21.56	H
5557.31	-35.15	13.10	17.11	-39.16	-13.00	-26.16	H
7409.52	-32.80	11.50	22.20	-43.50	-13.00	-30.50	H
3704.24	-34.53	12.60	12.93	-34.86	-13.00	-21.86	V
5557.24	-34.57	13.10	17.11	-38.58	-13.00	-25.58	V
7409.89	-32.64	11.50	22.20	-43.34	-13.00	-30.34	V
The Worst Test Results for Channel 9400/1880MHz							
Frequency(MHz)	S G.Lev (dBm)	Ant(dBi)	Loss	PMea	Limit	Margin	Polarity
				(dBm)	(dBm)	(dBm)	
3760.20	-33.87	12.60	12.93	-34.20	-13.00	-21.20	H
5639.83	-35.28	13.10	17.11	-39.29	-13.00	-26.29	H
7520.17	-33.33	11.50	22.20	-44.03	-13.00	-31.03	H
3760.35	-35.43	12.60	12.93	-35.76	-13.00	-22.76	V
5640.33	-34.84	13.10	17.11	-38.85	-13.00	-25.85	V
7520.01	-33.11	11.50	22.20	-43.81	-13.00	-30.81	V
The Worst Test Results for Channel 9538/1907.6MHz							
Frequency(MHz)	S G.Lev (dBm)	Ant(dBi)	Loss	PMea	Limit	Margin	Polarity
				(dBm)	(dBm)	(dBm)	
3815.38	-34.63	12.60	12.93	-34.96	-13.00	-21.96	H
5722.48	-35.27	13.10	17.11	-39.28	-13.00	-26.28	H
7630.13	-32.67	11.50	22.20	-43.37	-13.00	-30.37	H
3815.24	-34.54	12.60	12.93	-34.87	-13.00	-21.87	V
5722.03	-33.96	13.10	17.11	-37.97	-13.00	-24.97	V
7629.87	-33.03	11.50	22.20	-43.73	-13.00	-30.73	V



APPENDIX-PHOTOS OF TEST SETUP

Note: See test photos in setup photo document for the actual connections between Product and support equipment.

*****END OF THE REPORT*****

