

ELECTROMAGNETIC EMISSIONS COMPLIANCE REPORT

Applicant: Zorachka LTD
ALPHA TOWER, Floor 1, Flat 11, Pavlou Nirvana & Aipeias,
3021 Limassol, Cyprus

Product Name: Homam

Brand Name: Zorachka

Model No.: C1132

Model Difference: N/A

Report Number: ER/2020/20061

FCC ID: 2AWBH-C1132

IC: 25832-C1132

FCC Rule Part: §15.407, Cat: NII

ISED RSS: RSS-247 issue 2 Feb. 2017

Issue Date: Jul. 02, 2020

Date of Test: Mar. 02, 2020 ~ Apr. 22, 2020

Date of EUT Received: Feb. 19, 2020

We hereby certify that:

The above equipment was tested by SGS Taiwan Ltd. The test data, data evaluation, test procedures, and equipment configurations shown in this report were made in accordance with the procedures given in ANSI C63.10: 2013 and the energy emitted by the sample EUT tested as described in this report is in compliance with conducted and radiated emission limits.

The test results of this report relate only to the tested sample identified in this report.

Approved By: _____



Blue Yang / Asst. Manager



Unless otherwise stated the results shown in this test report refer only to the sample(s) tested and such sample(s) are retained for 90 days only.

除非另有說明，此報告結果僅對測試之樣品負責，同時此樣品僅保留90天。本報告未經本公司書面許可，不可部份複製。

This document is issued by the Company subject to its General Conditions of Service printed overleaf, available on request or accessible at <http://www.sgs.com.tw/Terms-and-Conditions> and for electronic format documents, subject to Terms and Conditions for Electronic Documents at <http://www.sgs.com.tw/Terms-and-Conditions>. Attention is drawn to the limitation of liability, indemnification and jurisdiction issues defined therein. Any holder of this document is advised that information contained hereon reflects the Company's findings at the time of its intervention only and within the limits of Client's instructions, if any. The Company's sole responsibility is to its Client and this document does not exonerate parties to a transaction from exercising all their rights and obligations under the transaction documents. This document cannot be reproduced except in full, without prior written approval of the Company. Any unauthorized alteration, forgery or falsification of the content or appearance of this document is unlawful and offenders may be prosecuted to the fullest extent of the law.

SGS Taiwan Ltd.

台灣檢驗科技股份有限公司

No.134,Wu Kung Road, New Taipei Industrial Park, Wuku District, New Taipei City, Taiwan/新北市五股區新北產業園區五工路134號

t (886-2) 2299-3279

f (886-2) 2298-0488

www.sgs.com.tw

Member of SGS Group

Revision History

Report Number	Revision	Description	Issue Date	Remark
ER/2020/20061	Rev.00	Original.	Jul. 02, 2020	Revised By: Karen Huang

Note:

1. Disclaimer

Antenna information is provided by the applicant, test results of this report are applicable to the sample EUT received.

Unless otherwise stated the results shown in this test report refer only to the sample(s) tested and such sample(s) are retained for 90 days only.

除非另有說明，此報告結果僅對測試之樣品負責，同時此樣品僅保留90天。本報告未經本公司書面許可，不可部份複製。

This document is issued by the Company subject to its General Conditions of Service printed overleaf, available on request or accessible at <http://www.sgs.com.tw/Terms-and-Conditions> and for electronic format documents, subject to Terms and Conditions for Electronic Documents at <http://www.sgs.com.tw/Terms-and-Conditions>. Attention is drawn to the limitation of liability, indemnification and jurisdiction issues defined therein. Any holder of this document is advised that information contained hereon reflects the Company's findings at the time of its intervention only and within the limits of Client's instructions, if any. The Company's sole responsibility is to its Client and this document does not exonerate parties to a transaction from exercising all their rights and obligations under the transaction documents. This document cannot be reproduced except in full, without prior written approval of the Company. Any unauthorized alteration, forgery or falsification of the content or appearance of this document is unlawful and offenders may be prosecuted to the fullest extent of the law.

SGS Taiwan Ltd.

台灣檢驗科技股份有限公司

No.134,Wu Kung Road, New Taipei Industrial Park, Wuku District, New Taipei City, Taiwan/新北市五股區新北產業園區五工路134號

t (886-2) 2299-3279

f (886-2) 2298-0488

www.sgs.com.tw

Member of SGS Group

Contents

1	GENERAL INFORMATION	4
2	SYSTEM TEST CONFIGURATION.....	8
3	SUMMARY OF TEST RESULT	11
4	DESCRIPTION OF TEST MODES.....	12
5	MEASUREMENT UNCERTAINTY	16
6	CONDUCTED EMISSION TEST.....	17
7	DUTY CYCLE TEST SIGNAL	21
8	26dB, 99% & 6dB EMISSION BANDWIDTH MEASUREMENT.....	25
9	MAXIMUM CONDUCTED OUTPUT POWER MEASUREMENT	65
10	MAXIMUM POWER SPECTRAL DENSITY.....	73
11	UNDESIRABLE RADIATED EMISSION MEASUREMENT	86
12	TRANSMISSION IN THE ABSENCE OF DATA.....	238
13	FREQUENCY STABILITY	239
14	ANTENNA REQUIREMENT.....	242

Unless otherwise stated the results shown in this test report refer only to the sample(s) tested and such sample(s) are retained for 90 days only.

除非另有說明，此報告結果僅對測試之樣品負責，同時此樣品僅保留90天。本報告未經本公司書面許可，不可部份複製。

This document is issued by the Company subject to its General Conditions of Service printed overleaf, available on request or accessible at <http://www.sgs.com.tw/Terms-and-Conditions> and for electronic format documents, subject to Terms and Conditions for Electronic Documents at <http://www.sgs.com.tw/Terms-and-Conditions>. Attention is drawn to the limitation of liability, indemnification and jurisdiction issues defined therein. Any holder of this document is advised that information contained hereon reflects the Company's findings at the time of its intervention only and within the limits of Client's instructions, if any. The Company's sole responsibility is to its Client and this document does not exonerate parties to a transaction from exercising all their rights and obligations under the transaction documents. This document cannot be reproduced except in full, without prior written approval of the Company. Any unauthorized alteration, forgery or falsification of the content or appearance of this document is unlawful and offenders may be prosecuted to the fullest extent of the law.

SGS Taiwan Ltd.

台灣檢驗科技股份有限公司

No.134,Wu Kung Road, New Taipei Industrial Park, Wuku District, New Taipei City, Taiwan/新北市五股區新北產業園區五工路134號

t (886-2) 2299-3279

f (886-2) 2298-0488

www.sgs.com.tw

Member of SGS Group

1 GENERAL INFORMATION

1.1 Product Description

Product Name:	Homam	
Brand Name:	Zorachka	
Model No.:	C1132	
Model Difference:	N/A	
Hardware Version:	1.3.1	
Software Version:	1.x.x	
USB Cable	Model No.: N/A, Supplier: Zorachka	
Power Supply:	5Vdc from Adapter	
	Adapter:	Model No.: PS-10U5 Supplier: Zorachka
Modulation type	64QAM, 16QAM, QPSK, BPSK for OFDM 256QAM for OFDM in 802.11ac only	
Transition Rate:	802.11 a: 6/9/12/18/24/36/48/54 Mbps 802.11 n_20MHz: 6.5 – 144.4Mbps 802.11 n_40MHz: 13.5 – 300.0Mbps	802.11 ac_20MHz: 6.5 – 173.3Mbps 802.11 ac_40MHz: 13.5 – 400.0Mbps 802.11 ac_80MHz: 29.3 – 866.7Mbps

1.2 Antenna Designation

Antenna Type	Supplier	Antenna Part No.	Freq.	Peak Antenna Gain (dBi)	Worst Antenna Gain
Flex	molex	2042810100	5GHz	3.3	-
		2042810100	5GHz	3.3	-

Note: Pre-scanned was done on the above 2 antennas, the MIMO mode results higher emission at 5GHz. Therefore, the completed set of measurement was done on the antenna to be presented on this test report.

Unless otherwise stated the results shown in this test report refer only to the sample(s) tested and such sample(s) are retained for 90 days only.

除非另有說明，此報告結果僅對測試之樣品負責，同時此樣品僅保留90天。本報告未經本公司書面許可，不可部份複製。

This document is issued by the Company subject to its General Conditions of Service printed overleaf, available on request or accessible at <http://www.sgs.com.tw/Terms-and-Conditions> and for electronic format documents, subject to Terms and Conditions for Electronic Documents at <http://www.sgs.com.tw/Terms-and-Conditions>. Attention is drawn to the limitation of liability, indemnification and jurisdiction issues defined therein. Any holder of this document is advised that information contained hereon reflects the Company's findings at the time of its intervention only and within the limits of Client's instructions, if any. The Company's sole responsibility is to its Client and this document does not exonerate parties to a transaction from exercising all their rights and obligations under the transaction documents. This document cannot be reproduced except in full, without prior written approval of the Company. Any unauthorized alteration, forgery or falsification of the content or appearance of this document is unlawful and offenders may be prosecuted to the fullest extent of the law.

1.3 FCC worst power

Wi-Fi 802.11	Frequency Range	Channels	Rated Power (Avg.) (dBm) (Worst case)	Modulation Technology
a	5150~5250	4	12.73	OFDM
	5250~5350	4	14.98	
	5470~5725	12	14.85	
	5725-5850	5	14.99	
n_HT ac_VHT 20M	5150~5250	4	HT: 12.89	OFDM
	5250~5350	4	HT: 14.99	
	5470~5725	12	HT: 14.97	
	5725-5850	5	HT: 14.98	
n_HT ac_VHT 40M	5150~5250	2	HT: 14.94	OFDM
	5250~5350	2	HT: 14.96	
	5470~5725	6	HT: 14.98	
	5725-5850	2	HT: 14.98	
ac_VHT 80M	5150~5250	1	5.89	OFDM
	5250~5350	1	6.01	
	5470~5725	3	14.64	
	5725-5850	1	14.89	

Unless otherwise stated the results shown in this test report refer only to the sample(s) tested and such sample(s) are retained for 90 days only.

除非另有說明，此報告結果僅對測試之樣品負責，同時此樣品僅保留90天。本報告未經本公司書面許可，不可部份複製。

This document is issued by the Company subject to its General Conditions of Service printed overleaf, available on request or accessible at <http://www.sgs.com.tw/Terms-and-Conditions> and for electronic format documents, subject to Terms and Conditions for Electronic Documents at <http://www.sgs.com.tw/Terms-and-Conditions>. Attention is drawn to the limitation of liability, indemnification and jurisdiction issues defined therein. Any holder of this document is advised that information contained hereon reflects the Company's findings at the time of its intervention only and within the limits of Client's instructions, if any. The Company's sole responsibility is to its Client and this document does not exonerate parties to a transaction from exercising all their rights and obligations under the transaction documents. This document cannot be reproduced except in full, without prior written approval of the Company. Any unauthorized alteration, forgery or falsification of the content or appearance of this document is unlawful and offenders may be prosecuted to the fullest extent of the law.

SGS Taiwan Ltd.

No. 134, Wu Kung Road, New Taipei Industrial Park, Wuku District, New Taipei City, Taiwan/新北市五股區新北產業園區五工路 134 號

台灣檢驗科技股份有限公司

t (886-2) 2299-3279

f (886-2) 2298-0488

www.sgs.com.tw

Member of SGS Group

1.4 ISED worst power

Wi-Fi 802.11	Frequency Range	Channels	Avg. or EIRP	Rated Power(dBm) (Worst Case)	Modulation Technology
11a	5150~5250	4	EIRP	19.04	OFDM
	5250~5350	4	Avg.	14.98	
	5470~5725	12	Avg.	14.85	
	5725-5850	5	Avg.	14.99	
11n_HT / ac_VHT 20M	5150~5250	4	EIRP	HT: 19.20	OFDM
	5250~5350	4	Avg.	HT: 14.99	
	5470~5725	12	Avg.	HT: 14.97	
	5725-5850	5	Avg.	HT: 14.98	
11n_HT / ac_VHT 40M	5150~5250	2	EIRP	HT: 21.25	OFDM
	5250~5350	2	Avg.	HT: 14.96	
	5470~5725	6	Avg.	HT: 14.98	
	5725-5850	2	Avg.	HT: 14.98	
11ac VHT80M	5150~5250	1	EIRP	12.21	OFDM
	5250~5350	1	Avg.	6.01	
	5470~5725	3	Avg.	14.64	
	5725-5850	1	Avg.	14.89	

Unless otherwise stated the results shown in this test report refer only to the sample(s) tested and such sample(s) are retained for 90 days only.

除非另有說明，此報告結果僅對測試之樣品負責，同時此樣品僅保留90天。本報告未經本公司書面許可，不可部份複製。

This document is issued by the Company subject to its General Conditions of Service printed overleaf, available on request or accessible at <http://www.sgs.com.tw/Terms-and-Conditions> and for electronic format documents, subject to Terms and Conditions for Electronic Documents at <http://www.sgs.com.tw/Terms-and-Conditions>. Attention is drawn to the limitation of liability, indemnification and jurisdiction issues defined therein. Any holder of this document is advised that information contained hereon reflects the Company's findings at the time of its intervention only and within the limits of Client's instructions, if any. The Company's sole responsibility is to its Client and this document does not exonerate parties to a transaction from exercising all their rights and obligations under the transaction documents. This document cannot be reproduced except in full, without prior written approval of the Company. Any unauthorized alteration, forgery or falsification of the content or appearance of this document is unlawful and offenders may be prosecuted to the fullest extent of the law.

1.5 Test Methodology of Applied Standards

FCC Part 15, Subpart E §15.407
FCC KDB 789033 D02 General UNII Test Procedures New Rules v02r01
FCC KDB 662911 D01 Multiple Transmitter Output v02r01
RSS-247 issue 2 Feb. 2017
RSS-Gen. issue 5, Amendment 1, March 2019
ANSI C63.10:2013

1.6 Test Facility

SGS Taiwan Ltd. Central RF Lab (TAF code 3702)
No.134, Wu Kung Road, New Taipei Industrial Park, Wuku District, New Taipei City, Taiwan
24803

FCC Designation number: TW0027

ISED CAB identifier: TW3702

1.7 Special Accessories

There are no special accessories used while test was conducted.

1.8 Equipment Modifications

There was no modification incorporated into the EUT.

Unless otherwise stated the results shown in this test report refer only to the sample(s) tested and such sample(s) are retained for 90 days only.

除非另有說明，此報告結果僅對測試之樣品負責，同時此樣品僅保留90天。本報告未經本公司書面許可，不可部份複製。

This document is issued by the Company subject to its General Conditions of Service printed overleaf, available on request or accessible at <http://www.sgs.com.tw/Terms-and-Conditions> and for electronic format documents, subject to Terms and Conditions for Electronic Documents at <http://www.sgs.com.tw/Terms-and-Conditions>. Attention is drawn to the limitation of liability, indemnification and jurisdiction issues defined therein. Any holder of this document is advised that information contained hereon reflects the Company's findings at the time of its intervention only and within the limits of Client's instructions, if any. The Company's sole responsibility is to its Client and this document does not exonerate parties to a transaction from exercising all their rights and obligations under the transaction documents. This document cannot be reproduced except in full, without prior written approval of the Company. Any unauthorized alteration, forgery or falsification of the content or appearance of this document is unlawful and offenders may be prosecuted to the fullest extent of the law.

SGS Taiwan Ltd.

台灣檢驗科技股份有限公司

No.134,Wu Kung Road, New Taipei Industrial Park, Wuku District, New Taipei City, Taiwan/新北市五股區新北產業園區五工路134號

t (886-2) 2299-3279

f (886-2) 2298-0488

www.sgs.com.tw

Member of SGS Group

2 SYSTEM TEST CONFIGURATION

2.1 EUT Configuration

The EUT configuration for testing is installed on RF field strength measurement to meet the Commissions requirement and operating in a manner which intends to maximize its emission characteristics in a continuous normal application.

2.2 EUT Exercise

An engineering test mode (software/firmware) that applicant provided was utilized to manipulate the EUT into transmit, selection of the test channel, and modulation scheme.

2.3 Test Procedure

2.3.1 Conducted Emissions

The EUT is a placed on a table which is 0.8 m above ground plane. Conducted emissions from the EUT measured in the frequency range between 0.15 MHz and 30MHz. The CISPR Quasi-Peak and Average detector mode is employed. The two LISNs provide 50uH/50 ohm of coupling impedance for the measuring instrument. Both lines of the power mains connected to the EUT were checked for maximum conducted interference.

2.3.2 Conducted Test (RF)

The active antenna port of the unlicensed wireless device is connected to the spectrum analyzer with attenuator to protect the instrumentation. If a second antenna port is available, it is tested at one operating frequency, with other port(s) appropriately terminated, to verify it has similar output characteristics as the fully tested port.

2.3.3 Radiated Emissions

The EUT is a placed on a turn table. For emissions testing at or below 1 GHz, the table height shall be 0.8 m above the reference ground plane. For emission measurements above 1 GHz, the table height shall be 1.5 m. The turn table shall rotate 360 degrees to determine the position of maximum emission level. EUT is set 3m away from the receiving antenna which varied from 1m to 4m to find out the highest emission. And also, each emission was to be maximized by changing the polarization of receiving antenna both horizontal and vertical. In order to find out the max. emission, the relative positions of this transmitter (EUT) was rotated through three orthogonal axes and measurement procedures for electric field radiated emissions above 1 GHz the EUT measurement is to be made "while keeping the antenna in the 'cone of radiation' from that area and pointed at the area both in azimuth and elevation, with polarization oriented for maximum response." is still within the 3dB illumination BW of the measurement antenna.

Unless otherwise stated the results shown in this test report refer only to the sample(s) tested and such sample(s) are retained for 90 days only.

除非另有說明，此報告結果僅對測試之樣品負責，同時此樣品僅保留90天。本報告未經本公司書面許可，不可部份複製。

This document is issued by the Company subject to its General Conditions of Service printed overleaf, available on request or accessible at <http://www.sgs.com.tw/Terms-and-Conditions> and for electronic format documents, subject to Terms and Conditions for Electronic Documents at <http://www.sgs.com.tw/Terms-and-Conditions>. Attention is drawn to the limitation of liability, indemnification and jurisdiction issues defined therein. Any holder of this document is advised that information contained hereon reflects the Company's findings at the time of its intervention only and within the limits of Client's instructions, if any. The Company's sole responsibility is to its Client and this document does not exonerate parties to a transaction from exercising all their rights and obligations under the transaction documents. This document cannot be reproduced except in full, without prior written approval of the Company. Any unauthorized alteration, forgery or falsification of the content or appearance of this document is unlawful and offenders may be prosecuted to the fullest extent of the law.

2.4 Measurement Results Explanation Example

2.4.1 Radiated Emission Test Sites For Measurements From 9 kHz To 30 MHz

Radiated emission below 30MHz is measured in a 9m*9m*6m semi-anechoic chamber, the measurements correspond to those obtained at an open-field test site.

There is a comparison data of both open-field test site and semi-Anechoic chamber, and the result came out very similar.

2.4.2 For all conducted test items:

The offset level is set in the spectrum analyzer to compensate the RF cable loss and attenuation factor between EUT conducted port and spectrum analyzer. With the offset compensation, the spectrum analyzer reading level is exactly EUT RF output level.

Unless otherwise stated the results shown in this test report refer only to the sample(s) tested and such sample(s) are retained for 90 days only.

除非另有說明，此報告結果僅對測試之樣品負責，同時此樣品僅保留90天。本報告未經本公司書面許可，不可部份複製。

This document is issued by the Company subject to its General Conditions of Service printed overleaf, available on request or accessible at <http://www.sgs.com.tw/Terms-and-Conditions> and for electronic format documents, subject to Terms and Conditions for Electronic Documents at <http://www.sgs.com.tw/Terms-and-Conditions>. Attention is drawn to the limitation of liability, indemnification and jurisdiction issues defined therein. Any holder of this document is advised that information contained hereon reflects the Company's findings at the time of its intervention only and within the limits of Client's instructions, if any. The Company's sole responsibility is to its Client and this document does not exonerate parties to a transaction from exercising all their rights and obligations under the transaction documents. This document cannot be reproduced except in full, without prior written approval of the Company. Any unauthorized alteration, forgery or falsification of the content or appearance of this document is unlawful and offenders may be prosecuted to the fullest extent of the law.

SGS Taiwan Ltd.

台灣檢驗科技股份有限公司

No.134,Wu Kung Road, New Taipei Industrial Park, Wuku District, New Taipei City, Taiwan/新北市五股區新北產業園區五工路134號

t (886-2) 2299-3279

f (886-2) 2298-0488

www.sgs.com.tw

Member of SGS Group

2.5 Configuration of Tested System

Fig. 2-1 Conducted (Antenna Port) Configuration



Fig 2-2 Radiated Emission



Fig 2-3 Conduction (AC Power Line) Radiated Emission

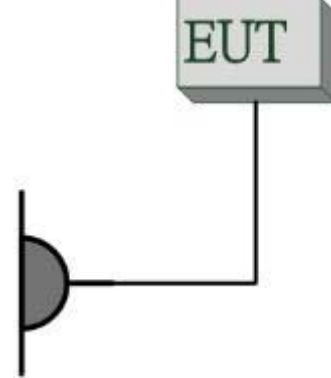

Table 2-1 Equipment Used in Tested System

Item	Equipment	Mfr/Brand	Model/Type No.	Series No.	Data Cable	Power Cord
1.	WLAN Test Software	N/A	N/A	N/A	N/A	N/A
2.	Notebook	Lenovo	L480	PF-1S9Q32	N/A	N/A

Unless otherwise stated the results shown in this test report refer only to the sample(s) tested and such sample(s) are retained for 90 days only.

除非另有說明，此報告結果僅對測試之樣品負責，同時此樣品僅保留90天。本報告未經本公司書面許可，不可部份複製。

This document is issued by the Company subject to its General Conditions of Service printed overleaf, available on request or accessible at <http://www.sgs.com.tw/Terms-and-Conditions> and for electronic format documents, subject to Terms and Conditions for Electronic Documents at <http://www.sgs.com.tw/Terms-and-Conditions>. Attention is drawn to the limitation of liability, indemnification and jurisdiction issues defined therein. Any holder of this document is advised that information contained hereon reflects the Company's findings at the time of its intervention only and within the limits of Client's instructions, if any. The Company's sole responsibility is to its Client and this document does not exonerate parties to a transaction from exercising all their rights and obligations under the transaction documents. This document cannot be reproduced except in full, without prior written approval of the Company. Any unauthorized alteration, forgery or falsification of the content or appearance of this document is unlawful and offenders may be prosecuted to the fullest extent of the law.

SGS Taiwan Ltd.

台灣檢驗科技股份有限公司

No.134,Wu Kung Road, New Taipei Industrial Park, Wuku District, New Taipei City, Taiwan/新北市五股區新北產業園區五工路134號

t (886-2) 2299-3279

f (886-2) 2298-0488

www.sgs.com.tw

Member of SGS Group

3 SUMMARY OF TEST RESULT

FCC Rules	IC Rules	Description Of Test	Result
§15.207	RSS-Gen §8.8	AC Power Line Conducted Emission	Compliant
§15.403(i) §15.407(e)	RSS-Gen §6.7 RSS-247 §6.2.4.1	26 dB & 6dB & 99% Emission Bandwidth	Compliant
§15.407(a)	RSS-247 §6.2.1~ 4 (1)	Maximum Conducted Output Power	Compliant
§15.407(a)	RSS-247 §6.2.1~ 4 (1)	Power Spectral Density	Compliant
§15.205 §15.209 §15.407(b)	RSS-247 §6.2.1~ 4 (2)	Undesirable Radiated Emissions	Compliant
§15.407(c)	RSS-247 §6.4	Transmission in case of Absence of Information	Compliant
§15.407(g)	RSS-Gen §6.11	Frequency Stability	Compliant
§15.203 §15.407(a)	RSS- Gen §6.8	Antenna Requirement	Compliant

Unless otherwise stated the results shown in this test report refer only to the sample(s) tested and such sample(s) are retained for 90 days only.

除非另有說明，此報告結果僅對測試之樣品負責，同時此樣品僅保留90天。本報告未經本公司書面許可，不可部份複製。

This document is issued by the Company subject to its General Conditions of Service printed overleaf, available on request or accessible at <http://www.sgs.com.tw/Terms-and-Conditions> and for electronic format documents, subject to Terms and Conditions for Electronic Documents at <http://www.sgs.com.tw/Terms-and-Conditions>. Attention is drawn to the limitation of liability, indemnification and jurisdiction issues defined therein. Any holder of this document is advised that information contained hereon reflects the Company's findings at the time of its intervention only and within the limits of Client's instructions, if any. The Company's sole responsibility is to its Client and this document does not exonerate parties to a transaction from exercising all their rights and obligations under the transaction documents. This document cannot be reproduced except in full, without prior written approval of the Company. Any unauthorized alteration, forgery or falsification of the content or appearance of this document is unlawful and offenders may be prosecuted to the fullest extent of the law.

4 DESCRIPTION OF TEST MODES

4.1 802.11a/n/ac operated in U-NII Bands

Operated band in 5150 MHz ~5250 MHz:

20 M	
CH	Freq (MHz)
36	5180
40	5200
44	5220
48	5240

40 M	
CH	Freq (MHz)
38	5190
46	5230

80 M	
CH	Freq (MHz)
42	5210

Operated band in 5250 MHz ~5350 MHz:

20 M	
CH	Freq (MHz)
52	5260
56	5280
60	5300
64	5320

40 M	
CH	Freq (MHz)
54	5270
62	5310

80 M	
CH	Freq (MHz)
58	5290

Operated band in 5470 MHz ~5725 MHz:

20 M	
CH	Freq (MHz)
100	5500
104	5520
108	5540
112	5560
116	5580
120	5600
124	5620
128	5640
132	5660
136	5680
140	5700
144	5720

40 M	
CH	Freq (MHz)
102	5510
110	5550
118	5590
126	5630
134	5670
142	5710

80 M	
CH	Freq (MHz)
106	5530
122	5610
138	5690

Operated band in 5745 MHz ~5850 MHz:

20 M	
CH	Freq (MHz)
149	5745
153	5765
157	5785
161	5805
165	5825

40 M	
CH	Freq (MHz)
151	5755
159	5795

80 M	
CH	Freq (MHz)
155	5775

Unless otherwise stated the results shown in this test report refer only to the sample(s) tested and such sample(s) are retained for 90 days only.

除非另有說明，此報告結果僅對測試之樣品負責，同時此樣品僅保留90天。本報告未經本公司書面許可，不可部份複製。

This document is issued by the Company subject to its General Conditions of Service printed overleaf, available on request or accessible at <http://www.sgs.com.tw/Terms-and-Conditions> and for electronic format documents, subject to Terms and Conditions for Electronic Documents at <http://www.sgs.com.tw/Terms-and-Conditions>. Attention is drawn to the limitation of liability, indemnification and jurisdiction issues defined therein. Any holder of this document is advised that information contained hereon reflects the Company's findings at the time of its intervention only and within the limits of Client's instructions, if any. The Company's sole responsibility is to its Client and this document does not exonerate parties to a transaction from exercising all their rights and obligations under the transaction documents. This document cannot be reproduced except in full, without prior written approval of the Company. Any unauthorized alteration, forgery or falsification of the content or appearance of this document is unlawful and offenders may be prosecuted to the fullest extent of the law.

SGS Taiwan Ltd.

No.134,Wu Kung Road, New Taipei Industrial Park, Wuku District, New Taipei City, Taiwan/新北市五股區新北產業園區五工路134號

台灣檢驗科技股份有限公司

t (886-2) 2299-3279

f (886-2) 2298-0488

www.sgs.com.tw

Member of SGS Group

4.2 The Worst Test Modes and Channel Details

1. The EUT has been tested under operating condition.
2. Test program used to control the EUT for staying in continuous transmitting mode is programmed.
3. Investigation has been done on all the possible configurations for searching the worst case. The gevin UE is pre-scanned among below modes.

Modulation	Transmission Chain				Single Transmission Spatial	Multiple Transmission Spatial
	Ch0	Ch1	Ch2	Ch3		
<input checked="" type="checkbox"/> 802.11 a	<input checked="" type="checkbox"/> Ch0	<input checked="" type="checkbox"/> Ch1	<input type="checkbox"/> Ch2	<input type="checkbox"/> Ch3	<input checked="" type="checkbox"/> 1TX	<input checked="" type="checkbox"/> 2TX
<input checked="" type="checkbox"/> 802.11 n	<input checked="" type="checkbox"/> Ch0	<input checked="" type="checkbox"/> Ch1	<input type="checkbox"/> Ch2	<input type="checkbox"/> Ch3	<input checked="" type="checkbox"/> SISO	<input checked="" type="checkbox"/> MIMO
<input checked="" type="checkbox"/> 802.11 ac	<input checked="" type="checkbox"/> Ch0	<input checked="" type="checkbox"/> Ch1	<input type="checkbox"/> Ch2	<input type="checkbox"/> Ch3	<input checked="" type="checkbox"/> SISO	<input checked="" type="checkbox"/> MIMO
<input type="checkbox"/> 802.11 ax	<input type="checkbox"/> Ch0	<input type="checkbox"/> Ch1	<input type="checkbox"/> Ch2	<input type="checkbox"/> Ch3	<input type="checkbox"/> SISO	<input type="checkbox"/> MIMO

4. Therefore, below summary is the modes of test configuration that yield the highest reading and generate the highest emission chosen to carry out the relevantly mandatory test items.

Unless otherwise stated the results shown in this test report refer only to the sample(s) tested and such sample(s) are retained for 90 days only.

除非另有說明，此報告結果僅對測試之樣品負責，同時此樣品僅保留90天。本報告未經本公司書面許可，不可部份複製。

This document is issued by the Company subject to its General Conditions of Service printed overleaf, available on request or accessible at <http://www.sgs.com.tw/Terms-and-Conditions> and for electronic format documents, subject to Terms and Conditions for Electronic Documents at <http://www.sgs.com.tw/Terms-and-Conditions>. Attention is drawn to the limitation of liability, indemnification and jurisdiction issues defined therein. Any holder of this document is advised that information contained hereon reflects the Company's findings at the time of its intervention only and within the limits of Client's instructions, if any. The Company's sole responsibility is to its Client and this document does not exonerate parties to a transaction from exercising all their rights and obligations under the transaction documents. This document cannot be reproduced except in full, without prior written approval of the Company. Any unauthorized alteration, forgery or falsification of the content or appearance of this document is unlawful and offenders may be prosecuted to the fullest extent of the law.

SGS Taiwan Ltd.

台灣檢驗科技股份有限公司

No.134,Wu Kung Road, New Taipei Industrial Park, Wuku District, New Taipei City, Taiwan/新北市五股區新北產業園區五工路134號

t (886-2) 2299-3279

f (886-2) 2298-0488

www.sgs.com.tw

Member of SGS Group

4.2.1 RADIATED EMISSION TEST:

RADIATED EMISSION TEST (BELOW 1 GHz)						
MODE	FREQUENCY BAND (MHz)	AVAILABLE CHANNEL	TESTED CHANNEL	MODULATION	DATA RATE (Mbps)	AN-TENNA PORT
802.11a	5180~5240	36 to 48	44	OFDM	6	2TX
	5260~5320	52 to 64	60			
	5500~5720	100 to 144	116			
	5745~5825	149 to 165	157			
802.11ac_VHT80	5210	42	42		MCS0	MIMO
	5290	58	58			
	5530~5690	106 to 138	122			
	5775	155	155			

RADIATED EMISSION TEST (ABOVE 1 GHz)						
MODE	FREQUENCY BAND (MHz)	AVAILABLE CHANNEL	TESTED CHANNEL	MODULATION	DATA RATE (Mbps)	AN-TENNA PORT
802.11a	5180~5240	36 to 48	36,44,48	OFDM	6	2TX
	5260~5320	52 to 64	52,60,64			
	5500~5720	100 to 144	100,116,140,144			
	5745~5825	149 to 165	149,157,165			
802.11n_HT20	5180~5240	36 to 48	36,44,48		MCS8	MIMO
	5260~5320	52 to 64	52,60,64			
	5500~5720	100 to 144	100,116,140,144			
	5745~5825	149 to 165	149,157,165			
802.11n_HT40	5190~5230	38 to 46	38,46		MCS8	MIMO
	5270~5310	54 to 62	54,62			
	5510~5710	102 to 142	102,110,134,142			
	5755~5795	151 to 159	151,159			
802.11ac_VHT80	5210	42	42	MCS0	MIMO	
	5290	58	58			
	5530~5690	106 to 138	106,122,138			
	5775	155	155			

Note:

The field strength of radiation emission was measured as EUT stand-up position (H mode) and lie down position (E1, E2 mode) for 802.11a/n/ac WLAN Transmitter for channel Low, Mid and High, the worst case H position was reported.

Unless otherwise stated the results shown in this test report refer only to the sample(s) tested and such sample(s) are retained for 90 days only.

除非另有說明，此報告結果僅對測試之樣品負責，同時此樣品僅保留90天。本報告未經本公司書面許可，不可部份複製。

This document is issued by the Company subject to its General Conditions of Service printed overleaf, available on request or accessible at <http://www.sgs.com.tw/Terms-and-Conditions> and for electronic format documents, subject to Terms and Conditions for Electronic Documents at <http://www.sgs.com.tw/Terms-and-Conditions>. Attention is drawn to the limitation of liability, indemnification and jurisdiction issues defined therein. Any holder of this document is advised that information contained hereon reflects the Company's findings at the time of its intervention only and within the limits of Client's instructions, if any. The Company's sole responsibility is to its Client and this document does not exonerate parties to a transaction from exercising all their rights and obligations under the transaction documents. This document cannot be reproduced except in full, without prior written approval of the Company. Any unauthorized alteration, forgery or falsification of the content or appearance of this document is unlawful and offenders may be prosecuted to the fullest extent of the law.

4.2.2 ANTENNA PORT CONDUCTED MEASUREMENT:

CONDUCTED TEST						
MODE	FREQUENCY BAND (MHz)	AVAILABLE CHANNEL	TESTED CHANNEL	MODULATION	DATA RATE (Mbps)	AN-TENNA PORT
802.11a	5180~5240	36 to 48	36,44,48	OFDM	6	2TX
	5260~5320	52 to 64	52,60,64			
	5500~5720	100 to 144	100,116,140,144			
	5745~5825	149 to 165	149,157,165			
802.11n_HT20	5180~5240	36 to 48	36,44,48		MCS8	MIMO
	5260~5320	52 to 64	52,60,64			
	5500~5720	100 to 144	100,116,140,144			
	5745~5825	149 to 165	149,157,165			
802.11ac_VHT20	5180~5240	36 to 48	36,44,48		MCS0	MIMO
	5260~5320	52 to 64	52,60,64			
	5500~5720	100 to 144	100,116,140,144			
	5745~5825	149 to 165	149,157,165			
802.11n_HT40	5190~5230	38 to 46	38,46		MCS8	MIMO
	5270~5310	54 to 62	54,62			
	5510~5710	102 to 142	102,110,134,142			
	5755~5795	151 to 159	151,159			
802.11ac_VHT40	5190~5230	38 to 46	38,46	MCS0	MIMO	
	5270~5310	54 to 62	54,62			
	5510~5710	102 to 142	102,110,134,142			
	5755~5795	151 to 159	151,159			
802.11ac_VHT80	5210	42	42	MCS0	MIMO	
	5290	58	58			
	5530~5690	106 to 138	106,122,138			
	5775	155	155			

Note: EUT serial number is WFB0054.

Unless otherwise stated the results shown in this test report refer only to the sample(s) tested and such sample(s) are retained for 90 days only.

除非另有說明，此報告結果僅對測試之樣品負責，同時此樣品僅保留90天。本報告未經本公司書面許可，不可部份複製。

This document is issued by the Company subject to its General Conditions of Service printed overleaf, available on request or accessible at <http://www.sgs.com.tw/Terms-and-Conditions> and for electronic format documents, subject to Terms and Conditions for Electronic Documents at <http://www.sgs.com.tw/Terms-and-Conditions>. Attention is drawn to the limitation of liability, indemnification and jurisdiction issues defined therein. Any holder of this document is advised that information contained hereon reflects the Company's findings at the time of its intervention only and within the limits of Client's instructions, if any. The Company's sole responsibility is to its Client and this document does not exonerate parties to a transaction from exercising all their rights and obligations under the transaction documents. This document cannot be reproduced except in full, without prior written approval of the Company. Any unauthorized alteration, forgery or falsification of the content or appearance of this document is unlawful and offenders may be prosecuted to the fullest extent of the law.

5 MEASUREMENT UNCERTAINTY

Test Items	Uncertainty
AC Power Line Conducted Emission	+/- 2.586 dB
26dB & 6dB Emission Bandwidth	+/- 123.36 Hz
The Maximum Output Power Measurement	+/- 0.96 dB
Peak Power Spectral Density Measurement	+/- 1.67 dB
Frequency Stability	+/- 123.36 Hz
Temperature	+/- 0.65 °C
Humidity	+/- 4.6 %
DC / AC Power Source	DC= +/- 0.13%, AC= +/- 0.2%

Radiated Spurious Emission Measurement Uncertainty	
Polarization: Vertical	9kHz~30MHz: +2.3dB
	30MHz - 180MHz: +/- 3.37dB
	180MHz -417MHz: +/- 3.19dB
	0.417GHz-1GHz: +/- 3.19dB
	1GHz - 18GHz: +/- 4.04dB
	18GHz - 40GHz: +/- 4.04dB
Polarization: Horizontal	9kHz~30MHz: +2.3dB
	30MHz - 167MHz: +/- 4.22dB
	167MHz -500MHz: +/- 3.44dB
	0.5GHz-1GHz: +/- 3.39dB
	1GHz - 18GHz: +/- 4.08dB
	18GHz - 40GHz: +/- 4.08dB

Note:

1. This uncertainty represents an expanded uncertainty expressed at approximately the 95% confidence level using a coverage factor of k=2.
2. The conformity assessment statement in this report is based solely on the test results, measurement uncertainty is excluded.

Unless otherwise stated the results shown in this test report refer only to the sample(s) tested and such sample(s) are retained for 90 days only.

除非另有說明，此報告結果僅對測試之樣品負責，同時此樣品僅保留90天。本報告未經本公司書面許可，不可部份複製。

This document is issued by the Company subject to its General Conditions of Service printed overleaf, available on request or accessible at <http://www.sgs.com.tw/Terms-and-Conditions> and for electronic format documents, subject to Terms and Conditions for Electronic Documents at <http://www.sgs.com.tw/Terms-and-Conditions>. Attention is drawn to the limitation of liability, indemnification and jurisdiction issues defined therein. Any holder of this document is advised that information contained hereon reflects the Company's findings at the time of its intervention only and within the limits of Client's instructions, if any. The Company's sole responsibility is to its Client and this document does not exonerate parties to a transaction from exercising all their rights and obligations under the transaction documents. This document cannot be reproduced except in full, without prior written approval of the Company. Any unauthorized alteration, forgery or falsification of the content or appearance of this document is unlawful and offenders may be prosecuted to the fullest extent of the law.

6 CONDUCTED EMISSION TEST

6.1 Standard Applicable

Frequency range within 150 kHz to 30 MHz shall not exceed the Limit table as below.

Frequency range MHz	Limits dB(uV)	
	Quasi-peak	Average
0.15 to 0.50	66 to 56	56 to 46
0.50 to 5	56	46
5 to 30	60	50

Note

- The lower limit shall apply at the transition frequencies
- The limit decreases linearly with the logarithm of the frequency in the range 0.15 MHz to 0.50 MHz.

6.2 Measurement Equipment Used

Conducted Emission Test Site					
EQUIPMENT TYPE	MFR	MODEL NUMBER	SERIAL NUMBER	LAST CAL.	CAL DUE.
EMI Test Receiver	R&S	ESCI 7	1166.5950.07	07/04/2019	07/03/2020
LISN	SCHWARZBECK	NSLK 8127	8127-649	04/02/2019	04/01/2020
Test Software	Farad	EZ-EMC	Ver. SGS-03A2	N.C.R	N.C.R
Coaxial Cables	N/A	WK CE Cable	N/A	01/02/2020	01/01/2021

Note: N.C.R refers to Not Calibrated Required.

6.3 EUT Setup

- The conducted emission tests were performed in the test site, using the setup in accordance with the ANSI C63.10:2013.
- The AC/DC Power adaptor of EUT was plug-in LISN. The rear of the EUT and peripherals were placed flushed with the rear of the tabletop.
- The LISN was connected with 120Vac/60Hz power source.

Unless otherwise stated the results shown in this test report refer only to the sample(s) tested and such sample(s) are retained for 90 days only.

除非另有說明，此報告結果僅對測試之樣品負責，同時此樣品僅保留90天。本報告未經本公司書面許可，不可部份複製。

This document is issued by the Company subject to its General Conditions of Service printed overleaf, available on request or accessible at <http://www.sgs.com.tw/Terms-and-Conditions> and for electronic format documents, subject to Terms and Conditions for Electronic Documents at <http://www.sgs.com.tw/Terms-and-Conditions>. Attention is drawn to the limitation of liability, indemnification and jurisdiction issues defined therein. Any holder of this document is advised that information contained hereon reflects the Company's findings at the time of its intervention only and within the limits of Client's instructions, if any. The Company's sole responsibility is to its Client and this document does not exonerate parties to a transaction from exercising all their rights and obligations under the transaction documents. This document cannot be reproduced except in full, without prior written approval of the Company. Any unauthorized alteration, forgery or falsification of the content or appearance of this document is unlawful and offenders may be prosecuted to the fullest extent of the law.

6.4 Test SET-UP

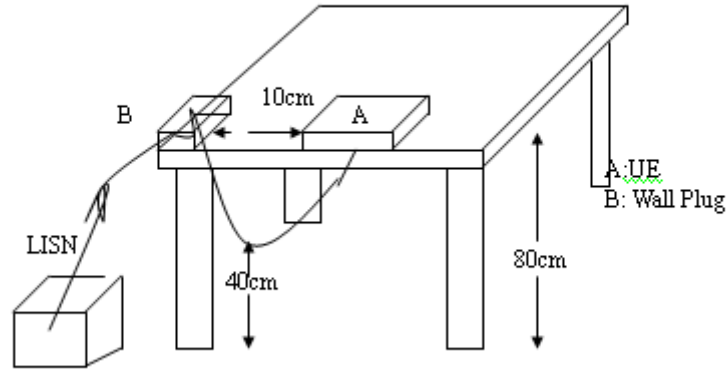

6.5 Measurement Procedure

1. The EUT was placed on a table which is 0.8m above ground plane.
2. Maximum procedure was performed on the six highest emissions to ensure EUT compliance.
3. Repeat above procedures until all phases of power being supplied by given UE are completed.

6.6 Measurement Result

Note: Refer to next page for measurement data and plots.

Note2: The * reveals the worst-case results that closet to the limit.

Unless otherwise stated the results shown in this test report refer only to the sample(s) tested and such sample(s) are retained for 90 days only.

除非另有說明，此報告結果僅對測試之樣品負責，同時此樣品僅保留90天。本報告未經本公司書面許可，不可部份複製。

This document is issued by the Company subject to its General Conditions of Service printed overleaf, available on request or accessible at <http://www.sgs.com.tw/Terms-and-Conditions> and for electronic format documents, subject to Terms and Conditions for Electronic Documents at <http://www.sgs.com.tw/Terms-and-Conditions>. Attention is drawn to the limitation of liability, indemnification and jurisdiction issues defined therein. Any holder of this document is advised that information contained hereon reflects the Company's findings at the time of its intervention only and within the limits of Client's instructions, if any. The Company's sole responsibility is to its Client and this document does not exonerate parties to a transaction from exercising all their rights and obligations under the transaction documents. This document cannot be reproduced except in full, without prior written approval of the Company. Any unauthorized alteration, forgery or falsification of the content or appearance of this document is unlawful and offenders may be prosecuted to the fullest extent of the law.

SGS Taiwan Ltd.

No.134,Wu Kung Road, New Taipei Industrial Park, Wuku District, New Taipei City, Taiwan/新北市五股區新北產業園區五工路134號

台灣檢驗科技股份有限公司

t (886-2) 2299-3279

f (886-2) 2298-0488

www.sgs.com.tw

Member of SGS Group

AC POWER LINE CONDUCTED EMISSION TEST DATA

Description:	Operation	Date:	2020/03/28
Line:	L1	Temp.(°C)/Hum.(%):	23(°C)/70%
Test Voltage:	AC 120V/60Hz	Test By:	Nick
Report Number:	ER-2020-20061		

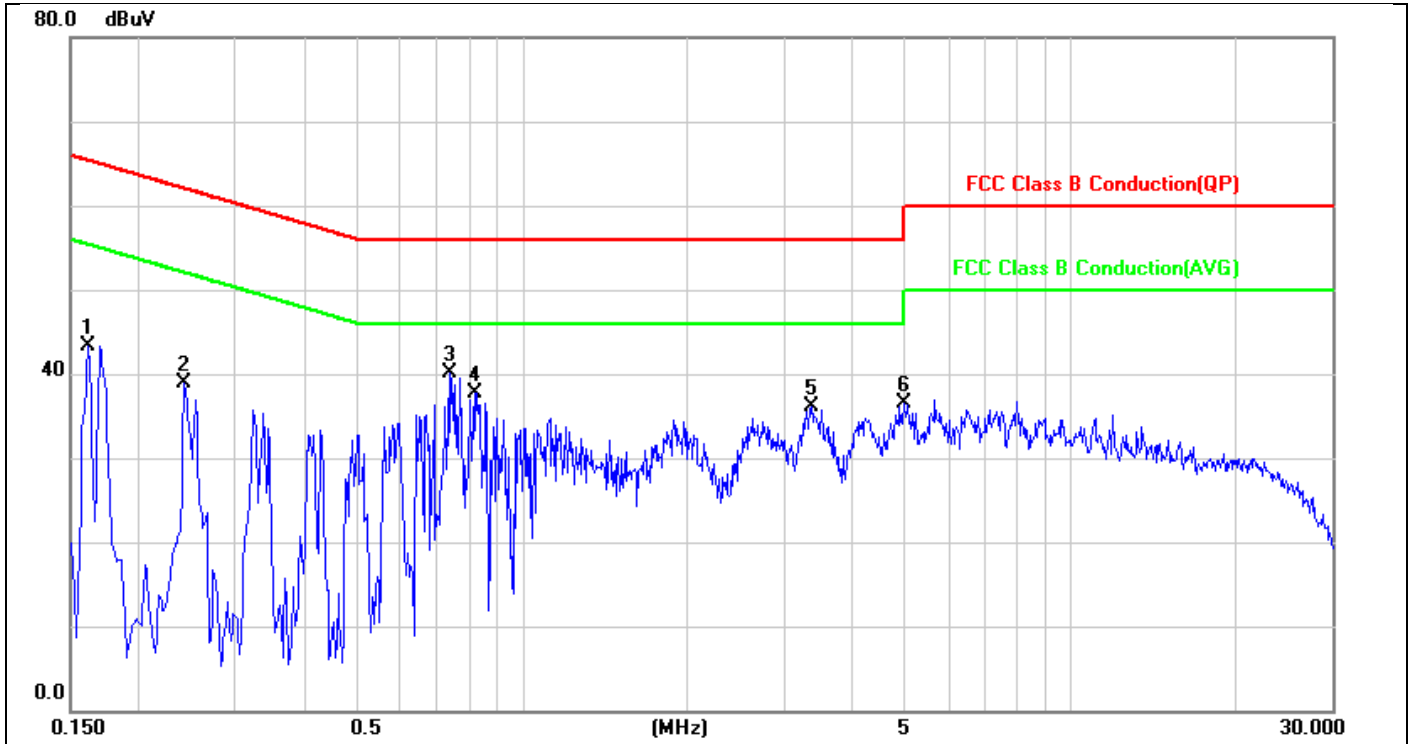

No.	Mk.	Freq.	Reading	Factor	Measurement	Limit	Over	Detector	Comment
		(MHz)	(dBuV)	(dB)	(dBuV)	(dBuV)	(dB)		
1		0.1620	43.38	0.00	43.38	65.36	-21.98	peak	
2		0.2420	38.84	0.01	38.85	62.03	-23.18	peak	
3	*	0.7380	40.08	0.02	40.10	56.00	-15.90	peak	
4		0.8180	37.71	0.02	37.73	56.00	-18.27	peak	
5		3.3660	36.08	0.11	36.19	56.00	-19.81	peak	
6		4.9820	36.40	0.19	36.59	56.00	-19.41	peak	

Unless otherwise stated the results shown in this test report refer only to the sample(s) tested and such sample(s) are retained for 90 days only.

除非另有說明，此報告結果僅對測試之樣品負責，同時此樣品僅保留90天。本報告未經本公司書面許可，不可部份複製。

This document is issued by the Company subject to its General Conditions of Service printed overleaf, available on request or accessible at <http://www.sgs.com.tw/Terms-and-Conditions> and for electronic format documents, subject to Terms and Conditions for Electronic Documents at <http://www.sgs.com.tw/Terms-and-Conditions>. Attention is drawn to the limitation of liability, indemnification and jurisdiction issues defined therein. Any holder of this document is advised that information contained hereon reflects the Company's findings at the time of its intervention only and within the limits of Client's instructions, if any. The Company's sole responsibility is to its Client and this document does not exonerate parties to a transaction from exercising all their rights and obligations under the transaction documents. This document cannot be reproduced except in full, without prior written approval of the Company. Any unauthorized alteration, forgery or falsification of the content or appearance of this document is unlawful and offenders may be prosecuted to the fullest extent of the law.

SGS Taiwan Ltd.

No.134,Wu Kung Road, New Taipei Industrial Park, Wuku District, New Taipei City, Taiwan/新北市五股區新北產業園區五工路134號

台灣檢驗科技股份有限公司

t (886-2) 2299-3279

f (886-2) 2298-0488

www.sgs.com.tw

Member of SGS Group

Description:	Operation	Date:	2020/03/28
Line:	N	Temp.(°C)/Hum.(%):	23(°C)/70%
Test Voltage:	AC 120V/60Hz	Test By:	Nick
Report Number:	ER-2020-20061		

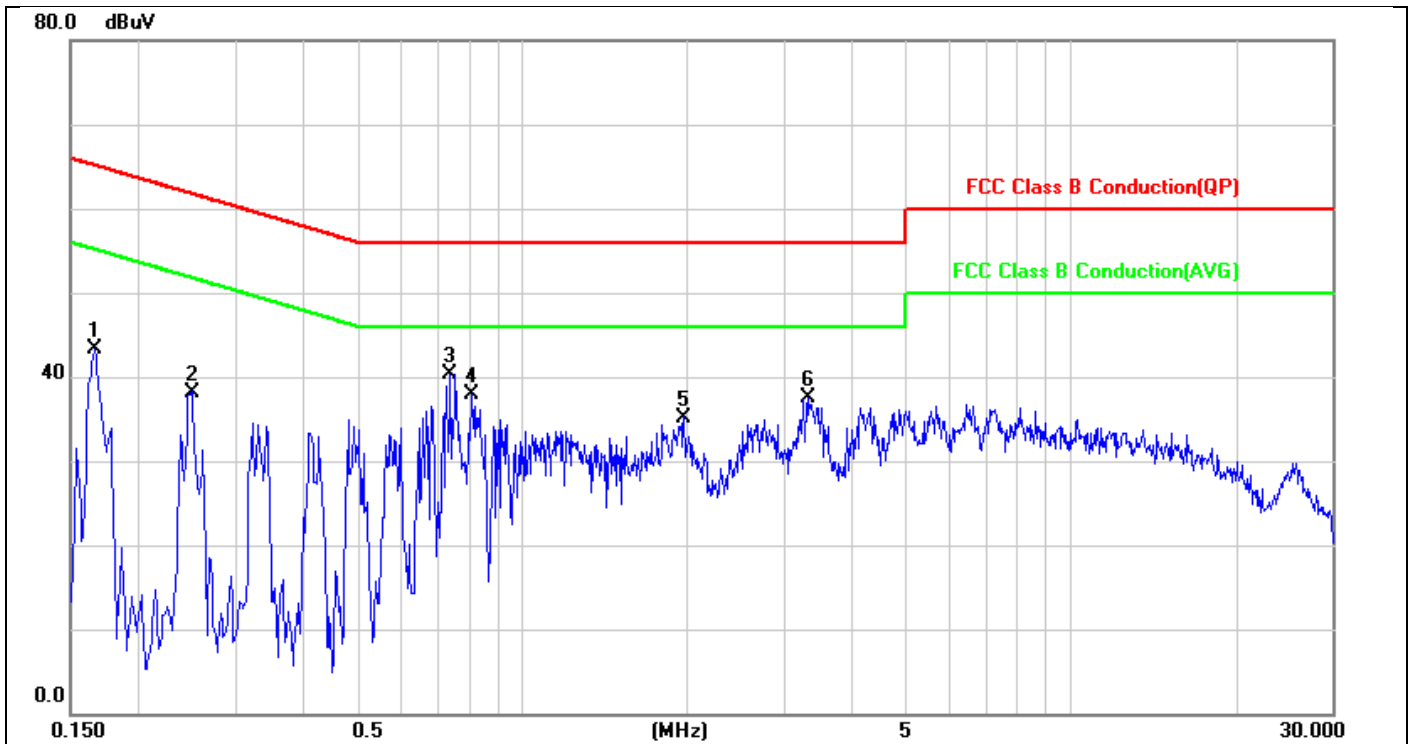

No.	Mk.	Freq.	Reading	Factor	Measurement	Limit	Over	Detector	Comment
		(MHz)	(dBuV)	(dB)	(dBuV)	(dBuV)	(dB)		
1		0.1660	43.36	0.03	43.39	65.16	-21.77	peak	
2		0.2500	38.17	0.03	38.20	61.76	-23.56	peak	
3	*	0.7420	40.26	0.04	40.30	56.00	-15.70	peak	
4		0.8100	37.77	0.04	37.81	56.00	-18.19	peak	
5		1.9740	35.14	0.06	35.20	56.00	-20.80	peak	
6		3.3340	37.46	0.11	37.57	56.00	-18.43	peak	

Unless otherwise stated the results shown in this test report refer only to the sample(s) tested and such sample(s) are retained for 90 days only.

除非另有說明，此報告結果僅對測試之樣品負責，同時此樣品僅保留90天。本報告未經本公司書面許可，不可部份複製。

This document is issued by the Company subject to its General Conditions of Service printed overleaf, available on request or accessible at <http://www.sgs.com.tw/Terms-and-Conditions> and for electronic format documents, subject to Terms and Conditions for Electronic Documents at <http://www.sgs.com.tw/Terms-and-Conditions>. Attention is drawn to the limitation of liability, indemnification and jurisdiction issues defined therein. Any holder of this document is advised that information contained hereon reflects the Company's findings at the time of its intervention only and within the limits of Client's instructions, if any. The Company's sole responsibility is to its Client and this document does not exonerate parties to a transaction from exercising all their rights and obligations under the transaction documents. This document cannot be reproduced except in full, without prior written approval of the Company. Any unauthorized alteration, forgery or falsification of the content or appearance of this document is unlawful and offenders may be prosecuted to the fullest extent of the law.

SGS Taiwan Ltd.

No.134,Wu Kung Road, New Taipei Industrial Park, Wuku District, New Taipei City, Taiwan/新北市五股區新北產業園區五工路134號

台灣檢驗科技股份有限公司

t (886-2) 2299-3279

f (886-2) 2298-0488

www.sgs.com.tw

Member of SGS Group

7 DUTY CYCLE TEST SIGNAL

Pre-analysis Check: While conducting average power measurement, duty cycle of each mode shall be checked to ensure its duty cycle in order to compensate for the loss due to insufficient ratio of duty cycle. All duty cycle is pre-scanned, and result as obtained below shows only the most representative ones where duty cycle is conducted as the given transmission with given virtual operation that expresses the percentage.

7.1 Measurement Procedure:

1. Set span = Zero
2. RBW = 8MHz
3. VBW = 8MHz,
4. Detector = Peak

Duty Cycle:

Mode	Duty Cycle (%) =Ton / (Ton+Toff)	Duty Factor (dB) =10*log (1/Duty Cycle)	1/T (kHz)	VBW setting (kHz)
802.11a	96.63	0.15	2.72	3.00
802.11n_20	93.75	0.28	5.44	6.00
802.11ac_20	96.36	0.16	3.02	4.00
802.11n_40	90.50	0.43	8.91	9.00
802.11ac_40	93.60	0.29	5.56	6.00
802.11ac_80	89.23	0.49	9.58	10.00

Duty Cycle Factor: $10 * \log(1/0.9663) = 0.15$

Duty Cycle Factor: $10 * \log(1/0.9375) = 0.28$

Duty Cycle Factor: $10 * \log(1/0.9636) = 0.16$

Duty Cycle Factor: $10 * \log(1/0.905) = 0.43$

Duty Cycle Factor: $10 * \log(1/0.936) = 0.29$

Duty Cycle Factor: $10 * \log(1/0.8923) = 0.49$

Unless otherwise stated the results shown in this test report refer only to the sample(s) tested and such sample(s) are retained for 90 days only.

除非另有說明，此報告結果僅對測試之樣品負責，同時此樣品僅保留90天。本報告未經本公司書面許可，不可部份複製。

This document is issued by the Company subject to its General Conditions of Service printed overleaf, available on request or accessible at <http://www.sgs.com.tw/Terms-and-Conditions> and for electronic format documents, subject to Terms and Conditions for Electronic Documents at <http://www.sgs.com.tw/Terms-and-Conditions>. Attention is drawn to the limitation of liability, indemnification and jurisdiction issues defined therein. Any holder of this document is advised that information contained hereon reflects the Company's findings at the time of its intervention only and within the limits of Client's instructions, if any. The Company's sole responsibility is to its Client and this document does not exonerate parties to a transaction from exercising all their rights and obligations under the transaction documents. This document cannot be reproduced except in full, without prior written approval of the Company. Any unauthorized alteration, forgery or falsification of the content or appearance of this document is unlawful and offenders may be prosecuted to the fullest extent of the law.

7.2 DUTY CYCLE TEST SIGNAL MEASUREMENT RESULT

802.11a_20MHz\5180 MHz-5180



802.11n_20MHz\5180 MHz-5180

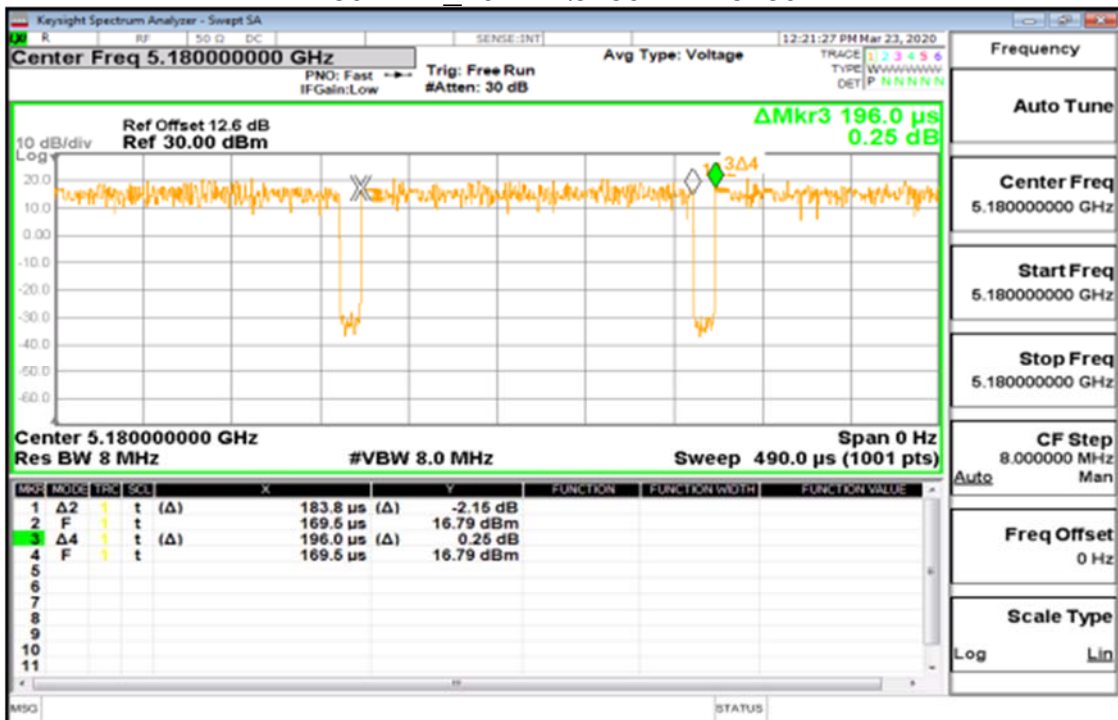

Unless otherwise stated the results shown in this test report refer only to the sample(s) tested and such sample(s) are retained for 90 days only.

除非另有說明，此報告結果僅對測試之樣品負責，同時此樣品僅保留90天。本報告未經本公司書面許可，不可部份複製。

This document is issued by the Company subject to its General Conditions of Service printed overleaf, available on request or accessible at <http://www.sgs.com.tw/Terms-and-Conditions> and for electronic format documents, subject to Terms and Conditions for Electronic Documents at <http://www.sgs.com.tw/Terms-and-Conditions>. Attention is drawn to the limitation of liability, indemnification and jurisdiction issues defined therein. Any holder of this document is advised that information contained hereon reflects the Company's findings at the time of its intervention only and within the limits of Client's instructions, if any. The Company's sole responsibility is to its Client and this document does not exonerate parties to a transaction from exercising all their rights and obligations under the transaction documents. This document cannot be reproduced except in full, without prior written approval of the Company. Any unauthorized alteration, forgery or falsification of the content or appearance of this document is unlawful and offenders may be prosecuted to the fullest extent of the law.

SGS Taiwan Ltd.

No.134,Wu Kung Road, New Taipei Industrial Park, Wuku District, New Taipei City, Taiwan/新北市五股區新北產業園區五工路134號

台灣檢驗科技股份有限公司

t (886-2) 2299-3279

f (886-2) 2298-0488

www.sgs.com.tw

Member of SGS Group

802.11ac 20MHz\5180 MHz-5180

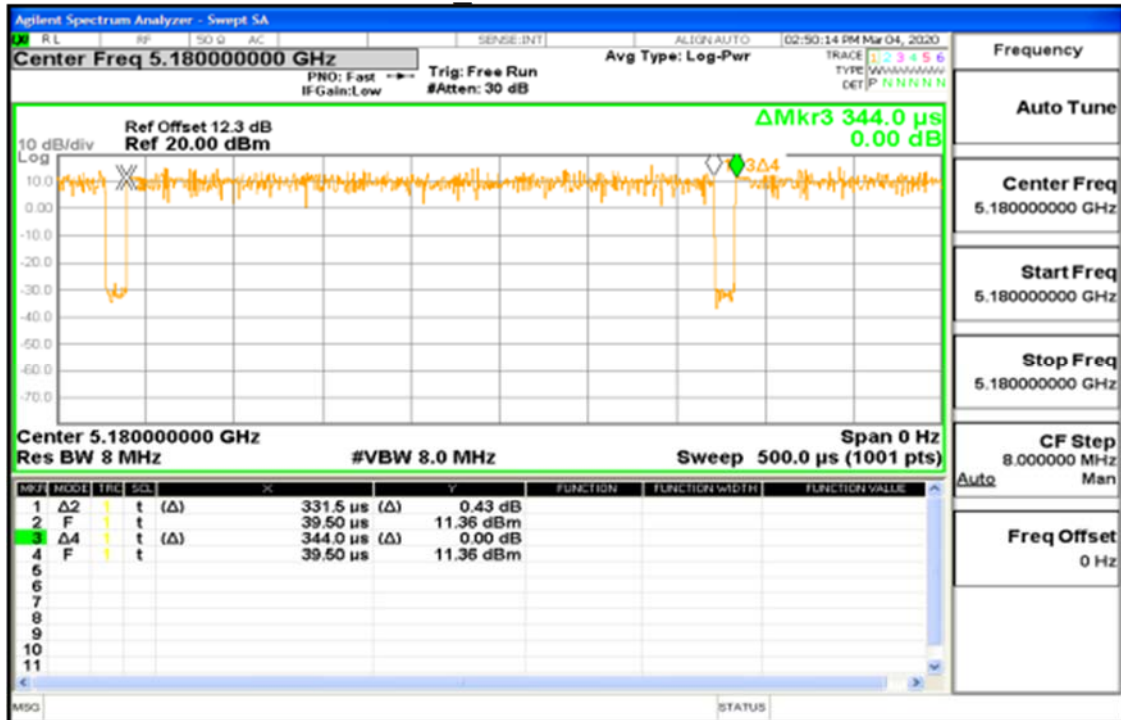

802.11n_40MHz\5190 MHz-5190

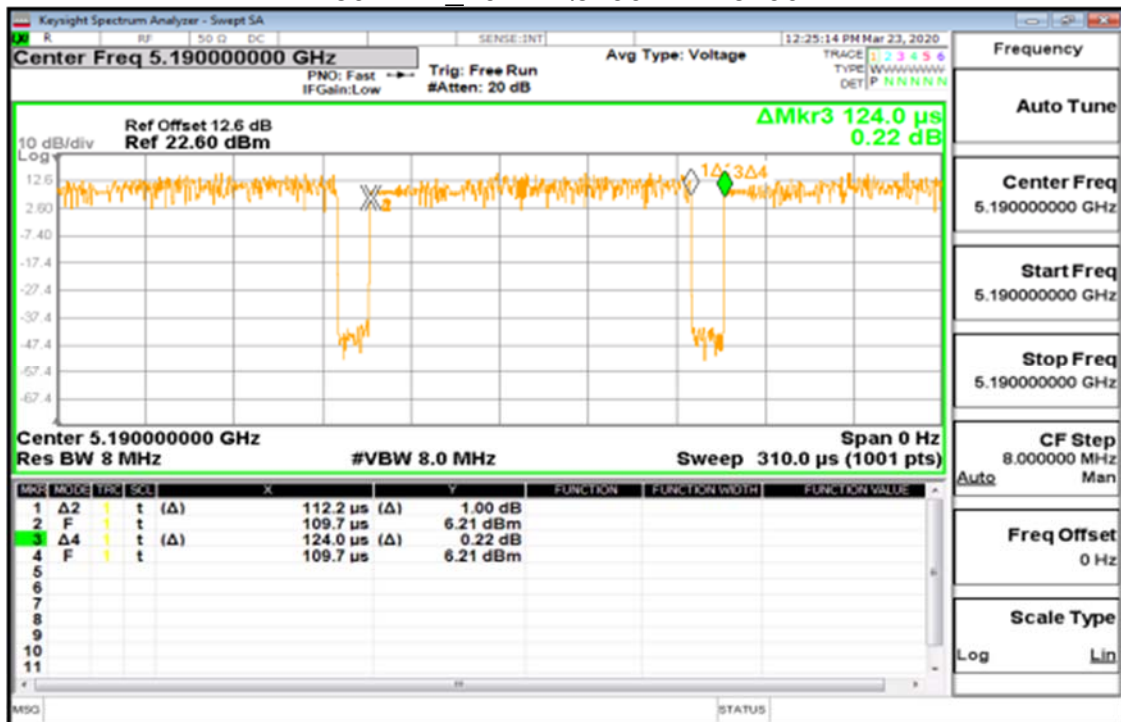

Unless otherwise stated the results shown in this test report refer only to the sample(s) tested and such sample(s) are retained for 90 days only.

除非另有說明，此報告結果僅對測試之樣品負責，同時此樣品僅保留90天。本報告未經本公司書面許可，不可部份複製。

This document is issued by the Company subject to its General Conditions of Service printed overleaf, available on request or accessible at <http://www.sgs.com.tw/Terms-and-Conditions> and for electronic format documents, subject to Terms and Conditions for Electronic Documents at <http://www.sgs.com.tw/Terms-and-Conditions>. Attention is drawn to the limitation of liability, indemnification and jurisdiction issues defined therein. Any holder of this document is advised that information contained hereon reflects the Company's findings at the time of its intervention only and within the limits of Client's instructions, if any. The Company's sole responsibility is to its Client and this document does not exonerate parties to a transaction from exercising all their rights and obligations under the transaction documents. This document cannot be reproduced except in full, without prior written approval of the Company. Any unauthorized alteration, forgery or falsification of the content or appearance of this document is unlawful and offenders may be prosecuted to the fullest extent of the law.

SGS Taiwan Ltd.

No.134,Wu Kung Road, New Taipei Industrial Park, Wuku District, New Taipei City, Taiwan/新北市五股區新北產業園區五工路134號

台灣檢驗科技股份有限公司

t (886-2) 2299-3279

f (886-2) 2298-0488

www.sgs.com.tw

Member of SGS Group

802.11ac 40MHz\5190 MHz-5190



802.11ac 80MHz\5210 MHz-5210



Unless otherwise stated the results shown in this test report refer only to the sample(s) tested and such sample(s) are retained for 90 days only.

除非另有說明，此報告結果僅對測試之樣品負責，同時此樣品僅保留90天。本報告未經本公司書面許可，不可部份複製。

This document is issued by the Company subject to its General Conditions of Service printed overleaf, available on request or accessible at <http://www.sgs.com.tw/Terms-and-Conditions> and for electronic format documents, subject to Terms and Conditions for Electronic Documents at <http://www.sgs.com.tw/Terms-and-Conditions>. Attention is drawn to the limitation of liability, indemnification and jurisdiction issues defined therein. Any holder of this document is advised that information contained hereon reflects the Company's findings at the time of its intervention only and within the limits of Client's instructions, if any. The Company's sole responsibility is to its Client and this document does not exonerate parties to a transaction from exercising all their rights and obligations under the transaction documents. This document cannot be reproduced except in full, without prior written approval of the Company. Any unauthorized alteration, forgery or falsification of the content or appearance of this document is unlawful and offenders may be prosecuted to the fullest extent of the law.

SGS Taiwan Ltd.

No.134,Wu Kung Road, New Taipei Industrial Park, Wuku District, New Taipei City, Taiwan/新北市五股區新北產業園區五工路134號

台灣檢驗科技股份有限公司

t (886-2) 2299-3279

f (886-2) 2298-0488

www.sgs.com.tw

Member of SGS Group

8 26DB, 99% & 6DB EMISSION BANDWIDTH MEASUREMENT

8.1 Standard Applicable

There is no limit bandwidth for U-NII-1, U-NII-2-A and U-NII-2-C.
The minimum of 6dB Bandwidth measurement is 0.5 MHz for U-NII-3

8.2 Measurement Procedure

1. Place the EUT on the table and set it in transmitting mode.
2. The testing follows FCC KDB 789033 D02 General UNII Test Procedures New Rules.
3. Remove the antenna from the EUT and then connect a low loss RF cable from the Antenna port to the spectrum analyzer.
 - 3.a. 26dB Band width Measurement: Set the spectrum analyzer as 1% of emission BW
Sweep=auto,
Detector = Peak,
Trace Mode = Max Hold,
Manually readjust RBW until the RBW/EBW ratio is 1% based on EBW as observed on the result of pre-sequence measurement.
 - 3.b. Mark the peak frequency and -26dB (upper and lower) frequency.
4. Repeat the procedures as list above until all test default channels (low, middle, and high) are completed.
5. Minimum Emission Bandwidth for the band 5.725-5.850GHz.
 - a. Set the spectrum analyzer as
RBW = 100 kHz,
VBW = 3*RBW,
Span = 30M/50MHz,
Detector=Peak,
Sweep=auto
 - b. Mark the peak frequency and -6dB (upper and lower) frequency.
6. For 99% Bandwidth: Set the spectrum analyzer as
RBW=1%,
VBW = 3*RBW,
Span = 30M/50MHz,
Detector=Sample,
Sweep=auto.
7. Turn on the 99% bandwidth function, max reading.
8. Repeat above procedures until all frequency of interest measured was complete.

Unless otherwise stated the results shown in this test report refer only to the sample(s) tested and such sample(s) are retained for 90 days only.

除非另有說明，此報告結果僅對測試之樣品負責，同時此樣品僅保留90天。本報告未經本公司書面許可，不可部份複製。

This document is issued by the Company subject to its General Conditions of Service printed overleaf, available on request or accessible at <http://www.sgs.com.tw/Terms-and-Conditions> and for electronic format documents, subject to Terms and Conditions for Electronic Documents at <http://www.sgs.com.tw/Terms-and-Conditions>. Attention is drawn to the limitation of liability, indemnification and jurisdiction issues defined therein. Any holder of this document is advised that information contained hereon reflects the Company's findings at the time of its intervention only and within the limits of Client's instructions, if any. The Company's sole responsibility is to its Client and this document does not exonerate parties to a transaction from exercising all their rights and obligations under the transaction documents. This document cannot be reproduced except in full, without prior written approval of the Company. Any unauthorized alteration, forgery or falsification of the content or appearance of this document is unlawful and offenders may be prosecuted to the fullest extent of the law.

8.3 Measurement Equipment Used

SGS Conducted Room					
EQUIPMENT TYPE	MFR	MODEL NUMBER	SERIAL NUMBER	LAST CAL.	CAL DUE.
Temperature Chamber	TERCHY	MHG-120LF	911009	05/17/2019	05/16/2020
EXA Spectrum Analyzer	KEYSIGHT	N9010A	MY57120290	02/20/2020	02/19/2021
Attenuator	Mini-Circuit	BW-S10W2+	2	01/02/2020	01/01/2021
DC Block	Mini-Circuits	BLK-18-S+	1	01/02/2020	01/01/2021

8.4 Test Set-up

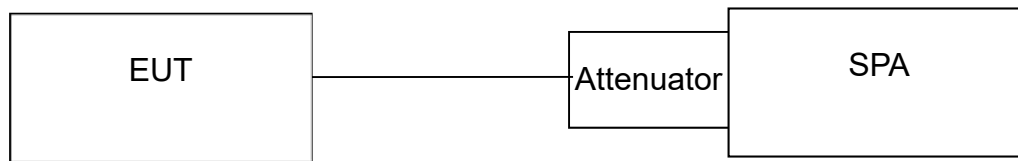

8.5 Measurement Result

8.5.1 FCC 26dB Bandwidth

802.11a_Ch0

Freq. (MHz)	26dB BW (MHz)	10 Log (B) (dB)
5180	20.058	13.023
5220	19.597	12.922
5240	19.336	12.864
5260	19.453	12.890
5300	19.842	12.976
5320	19.68	12.940
5500	19.72	12.949
5580	20.125	13.037
5700	19.537	12.909
5720	19.44	12.887

Unless otherwise stated the results shown in this test report refer only to the sample(s) tested and such sample(s) are retained for 90 days only.

除非另有說明，此報告結果僅對測試之樣品負責，同時此樣品僅保留90天。本報告未經本公司書面許可，不可部份複製。

This document is issued by the Company subject to its General Conditions of Service printed overleaf, available on request or accessible at <http://www.sgs.com.tw/Terms-and-Conditions> and for electronic format documents, subject to Terms and Conditions for Electronic Documents at <http://www.sgs.com.tw/Terms-and-Conditions>. Attention is drawn to the limitation of liability, indemnification and jurisdiction issues defined therein. Any holder of this document is advised that information contained hereon reflects the Company's findings at the time of its intervention only and within the limits of Client's instructions, if any. The Company's sole responsibility is to its Client and this document does not exonerate parties to a transaction from exercising all their rights and obligations under the transaction documents. This document cannot be reproduced except in full, without prior written approval of the Company. Any unauthorized alteration, forgery or falsification of the content or appearance of this document is unlawful and offenders may be prosecuted to the fullest extent of the law.

802.11a_Ch1

Freq. (MHz)	26dB BW (MHz)	10 Log (B) (dB)
5180	19.398	12.878
5220	19.403	12.879
5240	19.943	12.998
5260	19.935	12.996
5300	19.566	12.915
5320	19.751	12.956
5500	19.677	12.940
5580	19.245	12.843
5700	19.627	12.929
5720	19.93	12.995

802.11n_HT20_Ch0

Freq. (MHz)	26dB BW (MHz)	10 Log (B) (dB)
5180	20.233	13.061
5220	20.205	13.055
5240	19.879	12.984
5260	19.888	12.986
5300	20.055	13.022
5320	19.814	12.970
5500	20.462	13.109
5580	20.097	13.031
5700	19.89	12.986
5720	20.04	13.019

Unless otherwise stated the results shown in this test report refer only to the sample(s) tested and such sample(s) are retained for 90 days only.

除非另有說明，此報告結果僅對測試之樣品負責，同時此樣品僅保留90天。本報告未經本公司書面許可，不可部份複製。

This document is issued by the Company subject to its General Conditions of Service printed overleaf, available on request or accessible at <http://www.sgs.com.tw/Terms-and-Conditions> and for electronic format documents, subject to Terms and Conditions for Electronic Documents at <http://www.sgs.com.tw/Terms-and-Conditions>. Attention is drawn to the limitation of liability, indemnification and jurisdiction issues defined therein. Any holder of this document is advised that information contained hereon reflects the Company's findings at the time of its intervention only and within the limits of Client's instructions, if any. The Company's sole responsibility is to its Client and this document does not exonerate parties to a transaction from exercising all their rights and obligations under the transaction documents. This document cannot be reproduced except in full, without prior written approval of the Company. Any unauthorized alteration, forgery or falsification of the content or appearance of this document is unlawful and offenders may be prosecuted to the fullest extent of the law.

802.11n_HT20_Ch1

Freq. (MHz)	26dB BW (MHz)	10 Log (B) (dB)
5180	20.207	13.055
5220	20.568	13.132
5240	19.82	12.971
5260	20.127	13.038
5300	20.31	13.077
5320	20.976	13.217
5500	19.894	12.987
5580	20.856	13.192
5700	19.872	12.982
5720	19.97	13.004

802.11n_HT40_Ch0

Freq. (MHz)	26dB BW (MHz)	10 Log (B) (dB)
5190	40.985	16.126
5230	40.463	16.071
5270	39.47	15.963
5310	39.908	16.011
5510	39.927	16.013
5550	41.209	16.150
5670	40.072	16.028
5710	39.32	15.946

802.11n_HT40_Ch1

Freq. (MHz)	26dB BW (MHz)	10 Log (B) (dB)
5190	40.075	16.029
5230	39.732	15.991
5270	39.818	16.001
5310	40.118	16.033
5510	41.024	16.130
5550	40.418	16.066
5670	39.972	16.018
5710	40.29	16.052

Unless otherwise stated the results shown in this test report refer only to the sample(s) tested and such sample(s) are retained for 90 days only.

除非另有說明，此報告結果僅對測試之樣品負責，同時此樣品僅保留90天。本報告未經本公司書面許可，不可部份複製。

This document is issued by the Company subject to its General Conditions of Service printed overleaf, available on request or accessible at <http://www.sgs.com.tw/Terms-and-Conditions> and for electronic format documents, subject to Terms and Conditions for Electronic Documents at <http://www.sgs.com.tw/Terms-and-Conditions>. Attention is drawn to the limitation of liability, indemnification and jurisdiction issues defined therein. Any holder of this document is advised that information contained hereon reflects the Company's findings at the time of its intervention only and within the limits of Client's instructions, if any. The Company's sole responsibility is to its Client and this document does not exonerate parties to a transaction from exercising all their rights and obligations under the transaction documents. This document cannot be reproduced except in full, without prior written approval of the Company. Any unauthorized alteration, forgery or falsification of the content or appearance of this document is unlawful and offenders may be prosecuted to the fullest extent of the law.

802.11ac_VHT80_Ch0

Freq. (MHz)	26dB BW (MHz)	10 Log (B) (dB)
5210	81.586	19.116
5290	83.624	19.223
5530	82.766	19.179
5610	81.267	19.099
5690	81.26	19.099

802.11ac_VHT80_Ch1

Freq. (MHz)	26dB BW (MHz)	10 Log (B) (dB)
5210	80.08	19.035
5290	80.479	19.057
5530	80.702	19.069
5610	80.286	19.046
5690	80.59	19.063

8.5.2 6dB Bandwidth (5725 MHz~ 5850 MHz) measure with Peak detector for FCC
802.11a_Ch0

Freq. (MHz)	6dB BW (MHz)	10 Log (B) (dB)
5745	16.385	12.144
5785	16.348	12.135
5825	16.376	12.142

802.11a_Ch1

Freq. (MHz)	6dB BW (MHz)	10 Log (B) (dB)
5745	16.375	12.142
5785	16.384	12.144
5825	16.384	12.144

Unless otherwise stated the results shown in this test report refer only to the sample(s) tested and such sample(s) are retained for 90 days only.

除非另有說明，此報告結果僅對測試之樣品負責，同時此樣品僅保留90天。本報告未經本公司書面許可，不可部份複製。

This document is issued by the Company subject to its General Conditions of Service printed overleaf, available on request or accessible at <http://www.sgs.com.tw/Terms-and-Conditions> and for electronic format documents, subject to Terms and Conditions for Electronic Documents at <http://www.sgs.com.tw/Terms-and-Conditions>. Attention is drawn to the limitation of liability, indemnification and jurisdiction issues defined therein. Any holder of this document is advised that information contained hereon reflects the Company's findings at the time of its intervention only and within the limits of Client's instructions, if any. The Company's sole responsibility is to its Client and this document does not exonerate parties to a transaction from exercising all their rights and obligations under the transaction documents. This document cannot be reproduced except in full, without prior written approval of the Company. Any unauthorized alteration, forgery or falsification of the content or appearance of this document is unlawful and offenders may be prosecuted to the fullest extent of the law.

802.11n_HT20_Ch0

Freq. (MHz)	6dB BW (MHz)	10 Log (B) (dB)
5745	17.29	12.378
5785	17.459	12.420
5825	17.502	12.431

802.11n_HT20_Ch1

Freq. (MHz)	6dB BW (MHz)	10 Log (B) (dB)
5745	17.469	12.423
5785	17.42	12.410
5825	17.556	12.444

802.11n_HT40_Ch0

Freq. (MHz)	6dB BW (MHz)	10 Log (B) (dB)
5755	35.407	15.491
5795	35.461	15.498

802.11n_HT40_Ch1

Freq. (MHz)	6dB BW (MHz)	10 Log (B) (dB)
5755	35.441	15.495
5795	35.555	15.509

802.11ac_VHT80_Ch0

Freq. (MHz)	6dB BW (MHz)	10 Log (B) (dB)
5775	76.519	18.838

802.11ac_VHT80_Ch1

Freq. (MHz)	6dB BW (MHz)	10 Log (B) (dB)
5775	76.154	18.817

Unless otherwise stated the results shown in this test report refer only to the sample(s) tested and such sample(s) are retained for 90 days only.

除非另有說明，此報告結果僅對測試之樣品負責，同時此樣品僅保留90天。本報告未經本公司書面許可，不可部份複製。

This document is issued by the Company subject to its General Conditions of Service printed overleaf, available on request or accessible at <http://www.sgs.com.tw/Terms-and-Conditions> and for electronic format documents, subject to Terms and Conditions for Electronic Documents at <http://www.sgs.com.tw/Terms-and-Conditions>. Attention is drawn to the limitation of liability, indemnification and jurisdiction issues defined therein. Any holder of this document is advised that information contained hereon reflects the Company's findings at the time of its intervention only and within the limits of Client's instructions, if any. The Company's sole responsibility is to its Client and this document does not exonerate parties to a transaction from exercising all their rights and obligations under the transaction documents. This document cannot be reproduced except in full, without prior written approval of the Company. Any unauthorized alteration, forgery or falsification of the content or appearance of this document is unlawful and offenders may be prosecuted to the fullest extent of the law.

8.5.3 ISED 99% Bandwidth

802.11a_Ch0

Frequency (MHz)	99% BW (MHz)	10 Log (B) (dB)
5180	16.823	12.259
5220	16.765	12.244
5240	16.753	12.241
5260	16.708	12.229
5300	16.785	12.249
5320	16.725	12.234
5500	16.765	12.244
5580	16.753	12.241
5700	16.761	12.243
5720	16.741	12.238

802.11a_Ch1

Frequency (MHz)	99% BW (MHz)	10 Log (B) (dB)
5180	16.727	12.234
5220	16.68	12.222
5240	16.678	12.221
5260	16.72	12.232
5300	16.7	12.227
5320	16.761	12.243
5500	16.718	12.232
5580	16.699	12.227
5700	16.717	12.232
5720	16.732	12.235

Unless otherwise stated the results shown in this test report refer only to the sample(s) tested and such sample(s) are retained for 90 days only.

除非另有說明，此報告結果僅對測試之樣品負責，同時此樣品僅保留90天。本報告未經本公司書面許可，不可部份複製。

This document is issued by the Company subject to its General Conditions of Service printed overleaf, available on request or accessible at <http://www.sgs.com.tw/Terms-and-Conditions> and for electronic format documents, subject to Terms and Conditions for Electronic Documents at <http://www.sgs.com.tw/Terms-and-Conditions>. Attention is drawn to the limitation of liability, indemnification and jurisdiction issues defined therein. Any holder of this document is advised that information contained hereon reflects the Company's findings at the time of its intervention only and within the limits of Client's instructions, if any. The Company's sole responsibility is to its Client and this document does not exonerate parties to a transaction from exercising all their rights and obligations under the transaction documents. This document cannot be reproduced except in full, without prior written approval of the Company. Any unauthorized alteration, forgery or falsification of the content or appearance of this document is unlawful and offenders may be prosecuted to the fullest extent of the law.

802.11n_HT20_Ch0

Frequency (MHz)	99% BW (MHz)	10 Log (B) (dB)
5180	17.745	12.491
5220	17.737	12.489
5240	17.704	12.481
5260	17.733	12.488
5300	17.73	12.487
5320	17.732	12.488
5500	17.706	12.481
5580	17.728	12.487
5700	17.672	12.473
5720	17.736	12.489

802.11n_HT20_Ch1

Frequency (MHz)	99% BW (MHz)	10 Log (B) (dB)
5180	17.714	12.483
5220	17.704	12.481
5240	17.682	12.475
5260	17.726	12.486
5300	17.745	12.491
5320	17.76	12.494
5500	17.696	12.479
5580	17.723	12.485
5700	17.683	12.476
5720	17.687	12.477

802.11n_HT40_Ch0

Frequency (MHz)	99% BW (MHz)	10 Log (B) (dB)
5190	36.114	15.577
5230	36.085	15.573
5270	36.13	15.579
5310	36.101	15.575
5510	36.097	15.575
5550	36.119	15.577
5670	36.111	15.576
5710	36.103	15.575

Unless otherwise stated the results shown in this test report refer only to the sample(s) tested and such sample(s) are retained for 90 days only.

除非另有說明，此報告結果僅對測試之樣品負責，同時此樣品僅保留90天。本報告未經本公司書面許可，不可部份複製。

This document is issued by the Company subject to its General Conditions of Service printed overleaf, available on request or accessible at <http://www.sgs.com.tw/Terms-and-Conditions> and for electronic format documents, subject to Terms and Conditions for Electronic Documents at <http://www.sgs.com.tw/Terms-and-Conditions>. Attention is drawn to the limitation of liability, indemnification and jurisdiction issues defined therein. Any holder of this document is advised that information contained hereon reflects the Company's findings at the time of its intervention only and within the limits of Client's instructions, if any. The Company's sole responsibility is to its Client and this document does not exonerate parties to a transaction from exercising all their rights and obligations under the transaction documents. This document cannot be reproduced except in full, without prior written approval of the Company. Any unauthorized alteration, forgery or falsification of the content or appearance of this document is unlawful and offenders may be prosecuted to the fullest extent of the law.

802.11n_HT40_Ch1

Frequency (MHz)	99% BW (MHz)	10 Log (B) (dB)
5190	36.081	15.573
5230	36.027	15.566
5270	36.102	15.575
5310	36.061	15.570
5510	36.046	15.569
5550	36.097	15.575
5670	36.07	15.571
5710	36.089	15.574

802.11ac_VHT80_Ch0

Frequency (MHz)	99% BW (MHz)	10 Log (B) (dB)
5210	75.786	18.796
5290	75.942	18.805
5530	75.895	18.802
5610	75.913	18.803
5690	75.809	18.797

802.11ac_VHT80_Ch1

Frequency (MHz)	99% BW (MHz)	10 Log (B) (dB)
5210	75.713	18.792
5290	75.669	18.789
5530	75.67	18.789
5610	75.7	18.791
5690	75.672	18.789

8.5.4 6dB Bandwidth (5725 MHz~ 5850 MHz) measure with sample detector for ISED
802.11a_Ch0

Frequency (MHz)	6dB BW (MHz)	10 Log (B) (dB)
5745	16.368	12.140
5785	16.417	12.153
5825	16.466	12.166

Unless otherwise stated the results shown in this test report refer only to the sample(s) tested and such sample(s) are retained for 90 days only.

除非另有說明，此報告結果僅對測試之樣品負責，同時此樣品僅保留90天。本報告未經本公司書面許可，不可部份複製。

This document is issued by the Company subject to its General Conditions of Service printed overleaf, available on request or accessible at <http://www.sgs.com.tw/Terms-and-Conditions> and for electronic format documents, subject to Terms and Conditions for Electronic Documents at <http://www.sgs.com.tw/Terms-and-Conditions>. Attention is drawn to the limitation of liability, indemnification and jurisdiction issues defined therein. Any holder of this document is advised that information contained hereon reflects the Company's findings at the time of its intervention only and within the limits of Client's instructions, if any. The Company's sole responsibility is to its Client and this document does not exonerate parties to a transaction from exercising all their rights and obligations under the transaction documents. This document cannot be reproduced except in full, without prior written approval of the Company. Any unauthorized alteration, forgery or falsification of the content or appearance of this document is unlawful and offenders may be prosecuted to the fullest extent of the law.

802.11a_Ch1

Frequency (MHz)	6dB BW (MHz)	10 Log (B) (dB)
5745	16.462	12.165
5785	16.472	12.167
5825	16.43	12.156

802.11n_HT20_Ch0

Frequency (MHz)	6dB BW (MHz)	10 Log (B) (dB)
5745	17.663	12.471
5785	17.66	12.470
5825	17.484	12.426

802.11n_HT20_Ch1

Frequency (MHz)	6dB BW (MHz)	10 Log (B) (dB)
5745	17.585	12.451
5785	17.69	12.477
5825	17.654	12.468

802.11n_HT40_Ch0

Frequency (MHz)	6dB BW (MHz)	10 Log (B) (dB)
5755	36.445	15.616
5795	36.179	15.585

802.11n_HT40_Ch1

Frequency (MHz)	6dB BW (MHz)	10 Log (B) (dB)
5755	36.183	15.585
5795	36.256	15.594

802.11ac_VHT80_Ch0

Frequency (MHz)	6dB BW (MHz)	10 Log (B) (dB)
5775	76.778	18.852

802.11ac_VHT80_Ch1

Frequency (MHz)	6dB BW (MHz)	10 Log (B) (dB)
5775	76.126	18.815

Unless otherwise stated the results shown in this test report refer only to the sample(s) tested and such sample(s) are retained for 90 days only.

除非另有說明，此報告結果僅對測試之樣品負責，同時此樣品僅保留90天。本報告未經本公司書面許可，不可部份複製。

This document is issued by the Company subject to its General Conditions of Service printed overleaf, available on request or accessible at <http://www.sgs.com.tw/Terms-and-Conditions> and for electronic format documents, subject to Terms and Conditions for Electronic Documents at <http://www.sgs.com.tw/Terms-and-Conditions>. Attention is drawn to the limitation of liability, indemnification and jurisdiction issues defined therein. Any holder of this document is advised that information contained hereon reflects the Company's findings at the time of its intervention only and within the limits of Client's instructions, if any. The Company's sole responsibility is to its Client and this document does not exonerate parties to a transaction from exercising all their rights and obligations under the transaction documents. This document cannot be reproduced except in full, without prior written approval of the Company. Any unauthorized alteration, forgery or falsification of the content or appearance of this document is unlawful and offenders may be prosecuted to the fullest extent of the law.

8.5.5 99% BW Verification for DFS Function

802.11a_Ch0

Freq. (MHz)	Measured Freq. (MHz)	Limit (MHz)
5240	5248.25	< 5250
5745	5736.69	> 5725

802.11a_Ch1

Freq. (MHz)	Measured Freq. (MHz)	Limit (MHz)
5240	5248.22	< 5250
5745	5736.72	> 5725

802.11n_HT20_Ch0

Freq. (MHz)	Measured Freq. (MHz)	Limit (MHz)
5240	5248.76	< 5250
5745	5736.09	> 5725

802.11n_HT20_Ch1

Freq. (MHz)	Measured Freq. (MHz)	Limit (MHz)
5240	5248.73	< 5250
5745	5736.09	> 5725

802.11n_HT40_Ch0

Freq. (MHz)	Measured Freq. (MHz)	Limit (MHz)
5230	5248.00	< 5250
5755	5736.85	> 5725

802.11n_HT40_Ch1

Freq. (MHz)	Measured Freq. (MHz)	Limit (MHz)
5230	5248.00	< 5250
5755	5736.85	> 5725

Unless otherwise stated the results shown in this test report refer only to the sample(s) tested and such sample(s) are retained for 90 days only.

除非另有說明，此報告結果僅對測試之樣品負責，同時此樣品僅保留90天。本報告未經本公司書面許可，不可部份複製。

This document is issued by the Company subject to its General Conditions of Service printed overleaf, available on request or accessible at <http://www.sgs.com.tw/Terms-and-Conditions> and for electronic format documents, subject to Terms and Conditions for Electronic Documents at <http://www.sgs.com.tw/Terms-and-Conditions>. Attention is drawn to the limitation of liability, indemnification and jurisdiction issues defined therein. Any holder of this document is advised that information contained hereon reflects the Company's findings at the time of its intervention only and within the limits of Client's instructions, if any. The Company's sole responsibility is to its Client and this document does not exonerate parties to a transaction from exercising all their rights and obligations under the transaction documents. This document cannot be reproduced except in full, without prior written approval of the Company. Any unauthorized alteration, forgery or falsification of the content or appearance of this document is unlawful and offenders may be prosecuted to the fullest extent of the law.

802.11ac_VHT80_Ch0

Freq. (MHz)	Measured Freq. (MHz)	Limit (MHz)
5210	5248.00	< 5250
5775	5737.10	> 5725

802.11ac_VHT80_Ch1

Freq. (MHz)	Measured Freq. (MHz)	Limit (MHz)
5210	5247.90	< 5250
5775	5737.20	> 5725

Please see next page for test plots.

Unless otherwise stated the results shown in this test report refer only to the sample(s) tested and such sample(s) are retained for 90 days only.

除非另有說明，此報告結果僅對測試之樣品負責，同時此樣品僅保留90天。本報告未經本公司書面許可，不可部份複製。

This document is issued by the Company subject to its General Conditions of Service printed overleaf, available on request or accessible at <http://www.sgs.com.tw/Terms-and-Conditions> and for electronic format documents, subject to Terms and Conditions for Electronic Documents at <http://www.sgs.com.tw/Terms-and-Conditions>. Attention is drawn to the limitation of liability, indemnification and jurisdiction issues defined therein. Any holder of this document is advised that information contained hereon reflects the Company's findings at the time of its intervention only and within the limits of Client's instructions, if any. The Company's sole responsibility is to its Client and this document does not exonerate parties to a transaction from exercising all their rights and obligations under the transaction documents. This document cannot be reproduced except in full, without prior written approval of the Company. Any unauthorized alteration, forgery or falsification of the content or appearance of this document is unlawful and offenders may be prosecuted to the fullest extent of the law.

SGS Taiwan Ltd.

No.134,Wu Kung Road, New Taipei Industrial Park, Wuku District, New Taipei City, Taiwan/新北市五股區新北產業園區五工路134號

台灣檢驗科技股份有限公司

t (886-2) 2299-3279

f (886-2) 2298-0488

www.sgs.com.tw

Member of SGS Group

FCC 802.11a_20MHz_Chain0_5180MHz

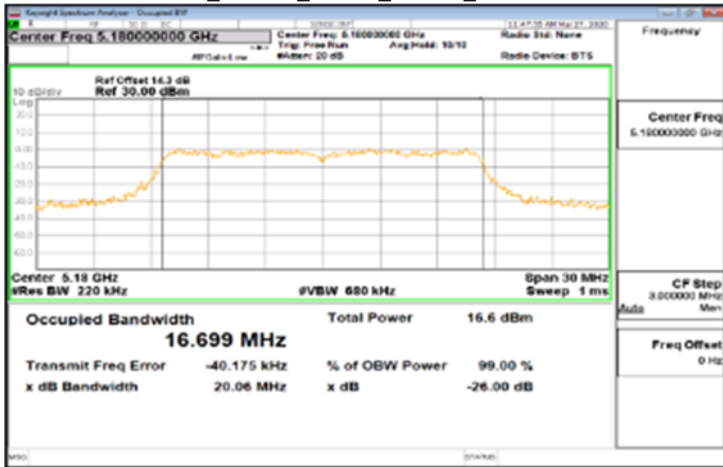

FCC 802.11a_20MHz_Chain0_5260MHz

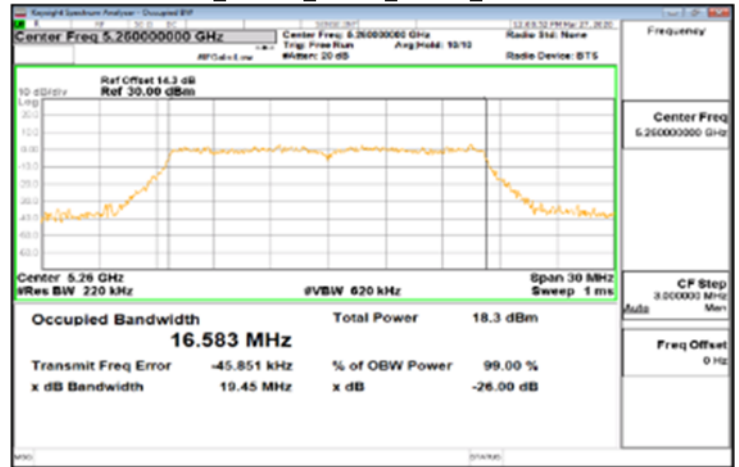

FCC 802.11a_20MHz_Chain0_5220MHz

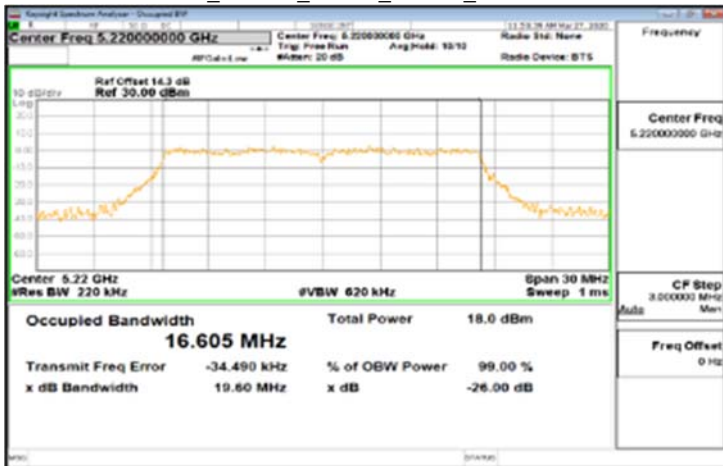

FCC 802.11a_20MHz_Chain0_5300MHz

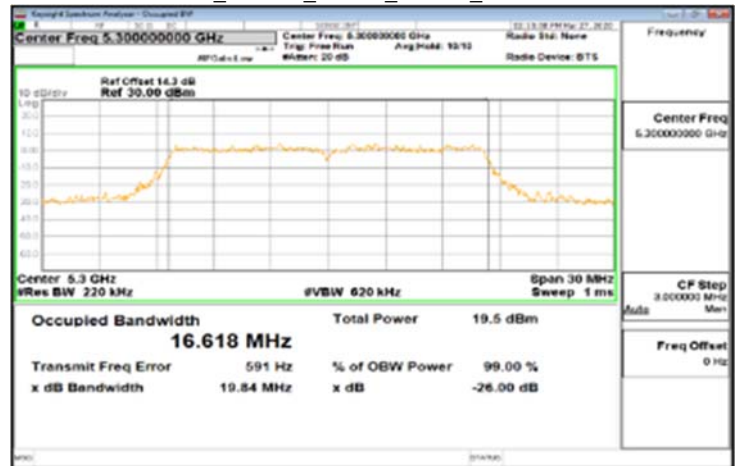

FCC 802.11a_20MHz_Chain0_5240MHz

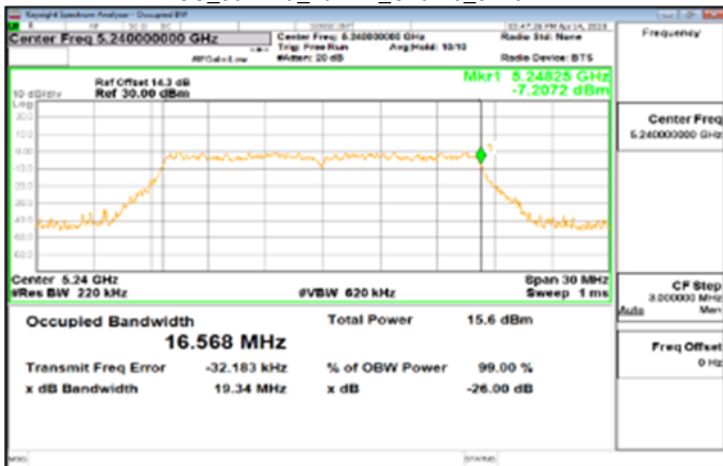

FCC 802.11a_20MHz_Chain0_5320MHz

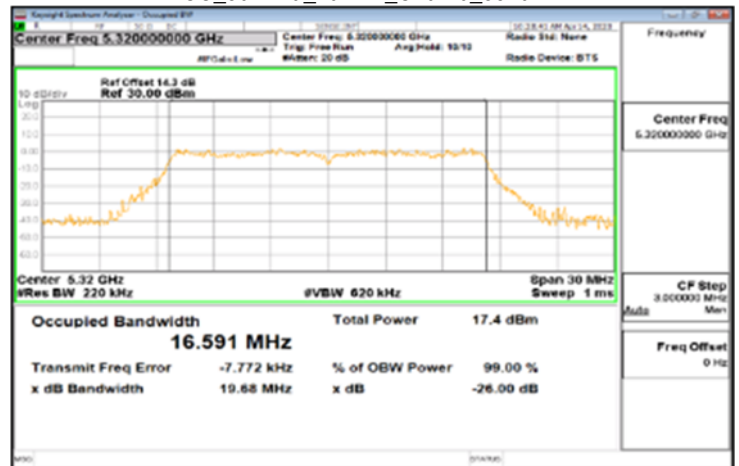

Unless otherwise stated the results shown in this test report refer only to the sample(s) tested and such sample(s) are retained for 90 days only.

除非另有說明，此報告結果僅對測試之樣品負責，同時此樣品僅保留90天。本報告未經本公司書面許可，不可部份複製。

This document is issued by the Company subject to its General Conditions of Service printed overleaf, available on request or accessible at <http://www.sgs.com.tw/Terms-and-Conditions> and for electronic format documents, subject to Terms and Conditions for Electronic Documents at <http://www.sgs.com.tw/Terms-and-Conditions>. Attention is drawn to the limitation of liability, indemnification and jurisdiction issues defined therein. Any holder of this document is advised that information contained hereon reflects the Company's findings at the time of its intervention only and within the limits of Client's instructions, if any. The Company's sole responsibility is to its Client and this document does not exonerate parties to a transaction from exercising all their rights and obligations under the transaction documents. This document cannot be reproduced except in full, without prior written approval of the Company. Any unauthorized alteration, forgery or falsification of the content or appearance of this document is unlawful and offenders may be prosecuted to the fullest extent of the law.

SGS Taiwan Ltd.

台灣檢驗科技股份有限公司

No.134,Wu Kung Road, New Taipei Industrial Park, Wuku District, New Taipei City, Taiwan/新北市五股區新北產業園區五工路 134 號

t (886-2) 2299-3279

f (886-2) 2298-0488

www.sgs.com.tw

Member of SGS Group

FCC 802.11a_20MHz_Chain0_5500MHz

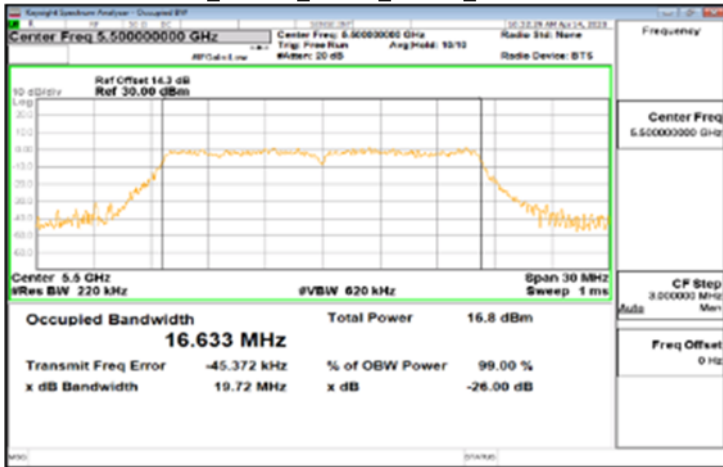

FCC 802.11a_20MHz_Chain0_5720MHz

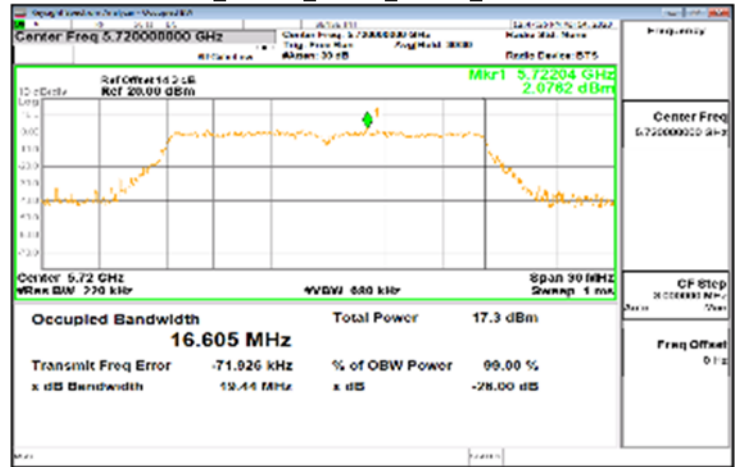

FCC 802.11a_20MHz_Chain0_5580MHz

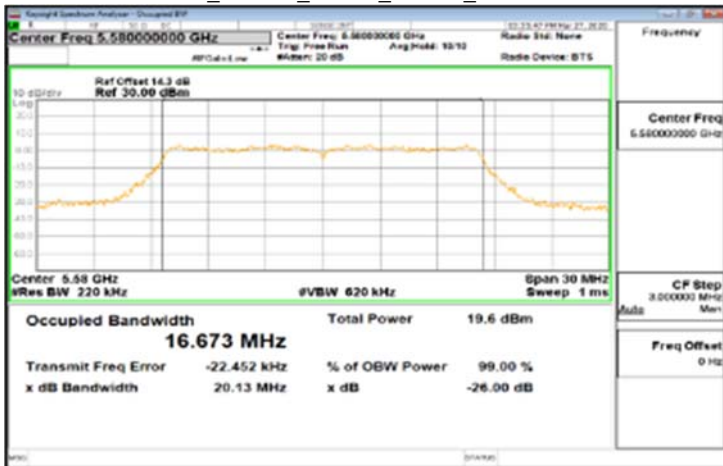

FCC 802.11a_20MHz_Chain0_5745MHz

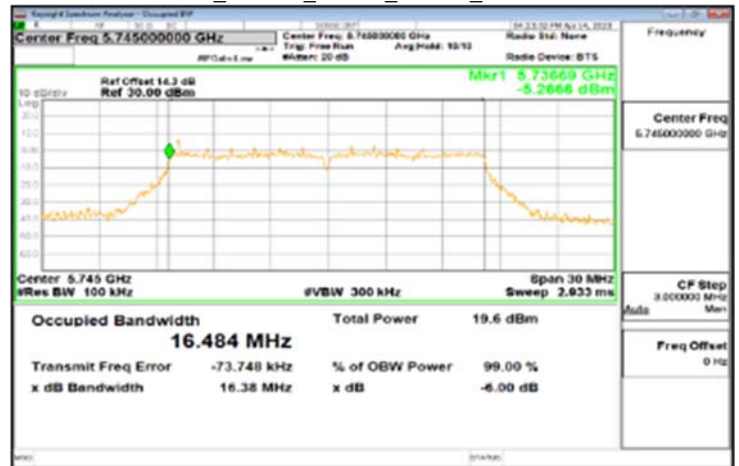

FCC 802.11a_20MHz_Chain0_5700MHz

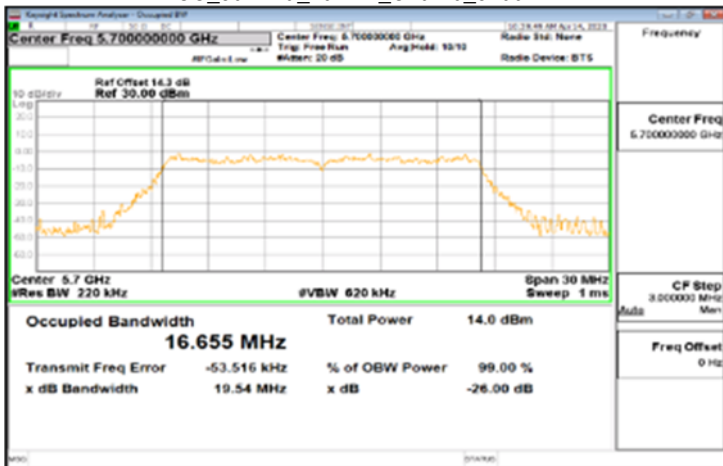

FCC 802.11a_20MHz_Chain0_5785MHz

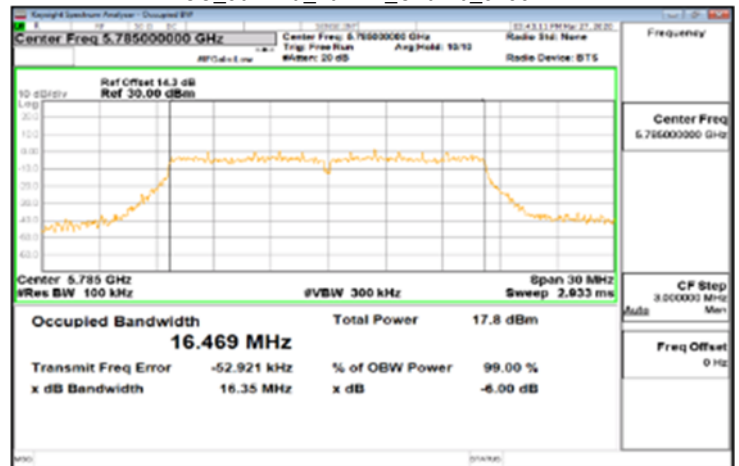

Unless otherwise stated the results shown in this test report refer only to the sample(s) tested and such sample(s) are retained for 90 days only.

除非另有說明，此報告結果僅對測試之樣品負責，同時此樣品僅保留90天。本報告未經本公司書面許可，不可部份複製。

This document is issued by the Company subject to its General Conditions of Service printed overleaf, available on request or accessible at <http://www.sgs.com.tw/Terms-and-Conditions> and for electronic format documents, subject to Terms and Conditions for Electronic Documents at <http://www.sgs.com.tw/Terms-and-Conditions>. Attention is drawn to the limitation of liability, indemnification and jurisdiction issues defined therein. Any holder of this document is advised that information contained hereon reflects the Company's findings at the time of its intervention only and within the limits of Client's instructions, if any. The Company's sole responsibility is to its Client and this document does not exonerate parties to a transaction from exercising all their rights and obligations under the transaction documents. This document cannot be reproduced except in full, without prior written approval of the Company. Any unauthorized alteration, forgery or falsification of the content or appearance of this document is unlawful and offenders may be prosecuted to the fullest extent of the law.

FCC 802.11a_20MHz_Chain0_5825MHz

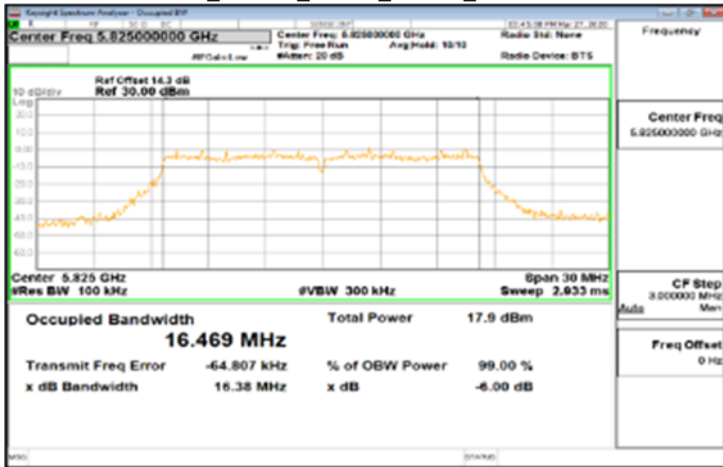

FCC 802.11a_20MHz_Chain1_5240MHz

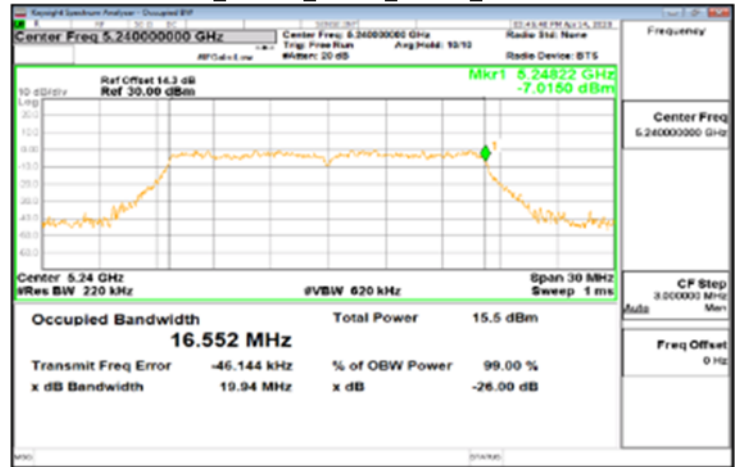

FCC 802.11a_20MHz_Chain1_5180MHz

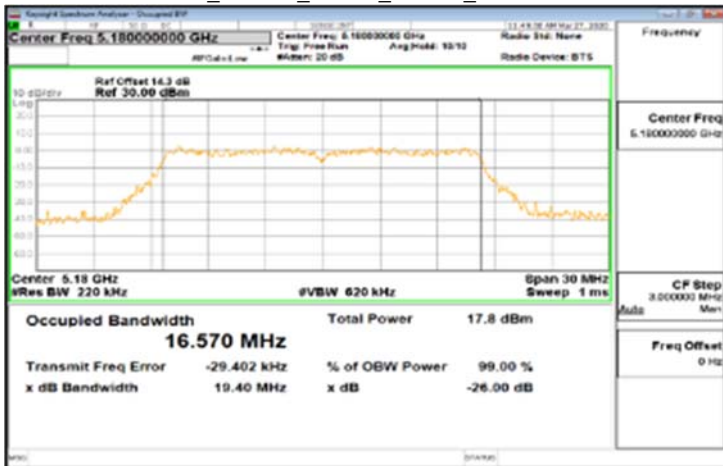

FCC 802.11a_20MHz_Chain1_5260MHz

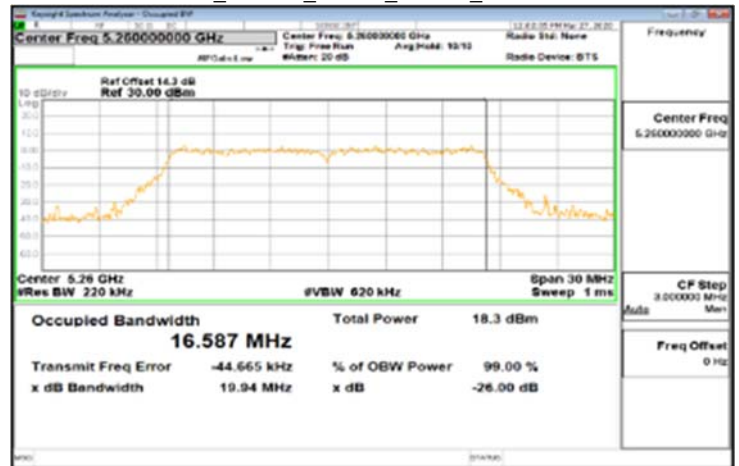

FCC 802.11a_20MHz_Chain1_5220MHz

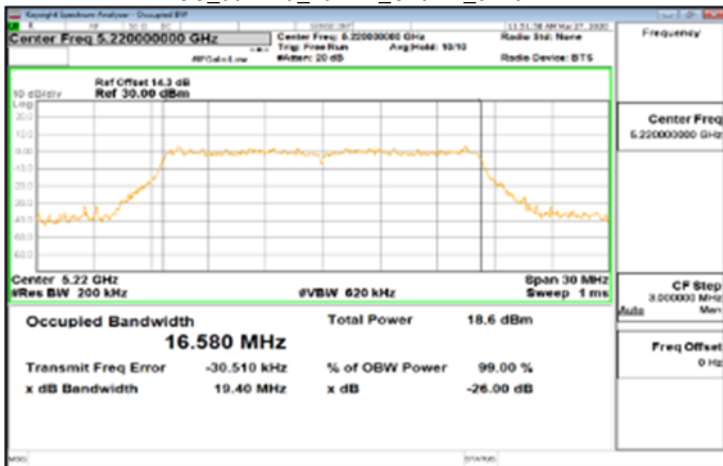

FCC 802.11a_20MHz_Chain1_5300MHz

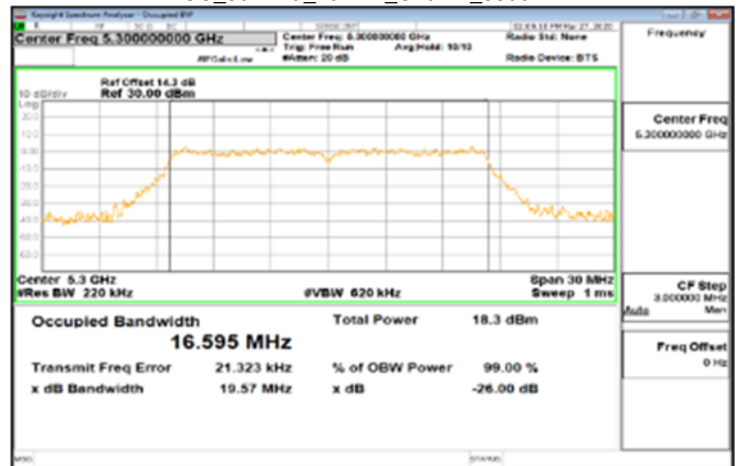

Unless otherwise stated the results shown in this test report refer only to the sample(s) tested and such sample(s) are retained for 90 days only.

除非另有說明，此報告結果僅對測試之樣品負責，同時此樣品僅保留90天。本報告未經本公司書面許可，不可部份複製。

This document is issued by the Company subject to its General Conditions of Service printed overleaf, available on request or accessible at <http://www.sgs.com.tw/Terms-and-Conditions> and for electronic format documents, subject to Terms and Conditions for Electronic Documents at <http://www.sgs.com.tw/Terms-and-Conditions>. Attention is drawn to the limitation of liability, indemnification and jurisdiction issues defined therein. Any holder of this document is advised that information contained hereon reflects the Company's findings at the time of its intervention only and within the limits of Client's instructions, if any. The Company's sole responsibility is to its Client and this document does not exonerate parties to a transaction from exercising all their rights and obligations under the transaction documents. This document cannot be reproduced except in full, without prior written approval of the Company. Any unauthorized alteration, forgery or falsification of the content or appearance of this document is unlawful and offenders may be prosecuted to the fullest extent of the law.

FCC 802.11a_20MHz_Chain1_5320MHz

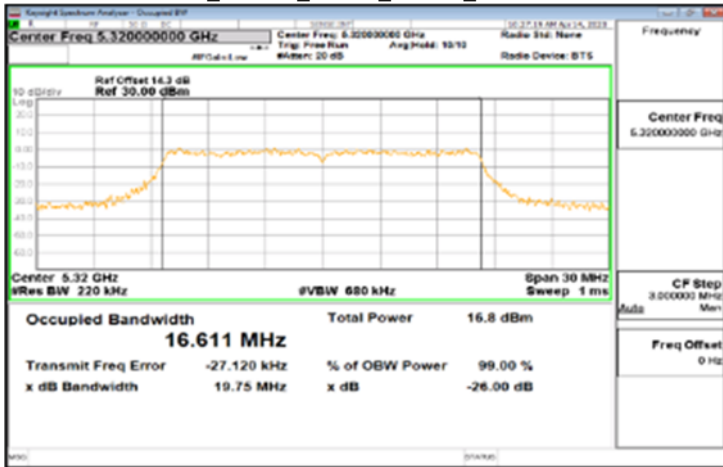

FCC 802.11a_20MHz_Chain1_5700MHz

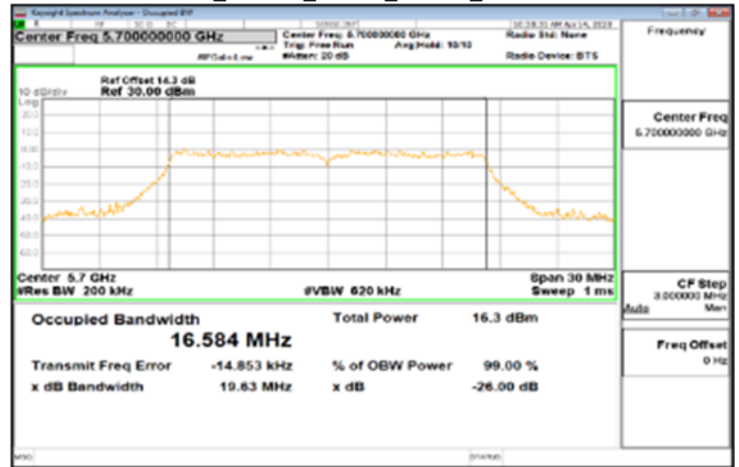

FCC 802.11a_20MHz_Chain1_5500MHz

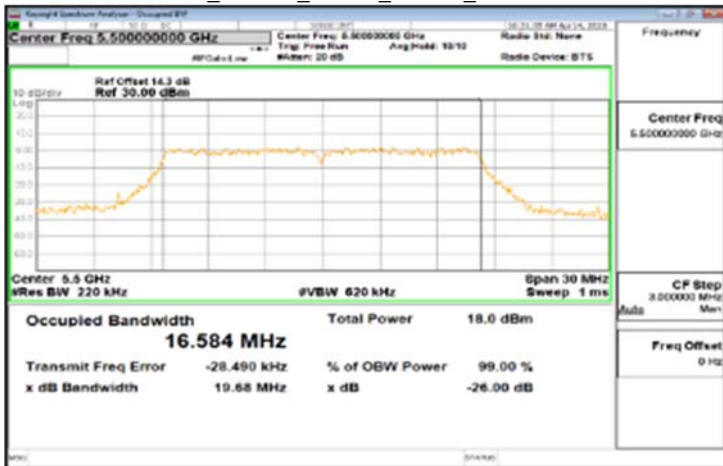

FCC 802.11a_20MHz_Chain1_5720MHz

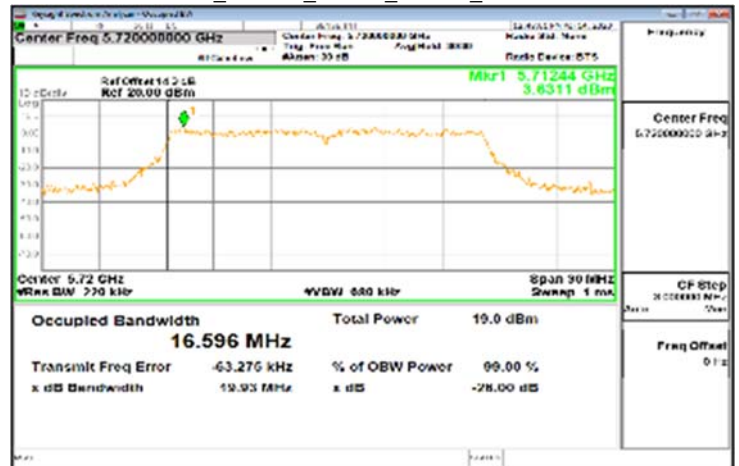

FCC 802.11a_20MHz_Chain1_5580MHz

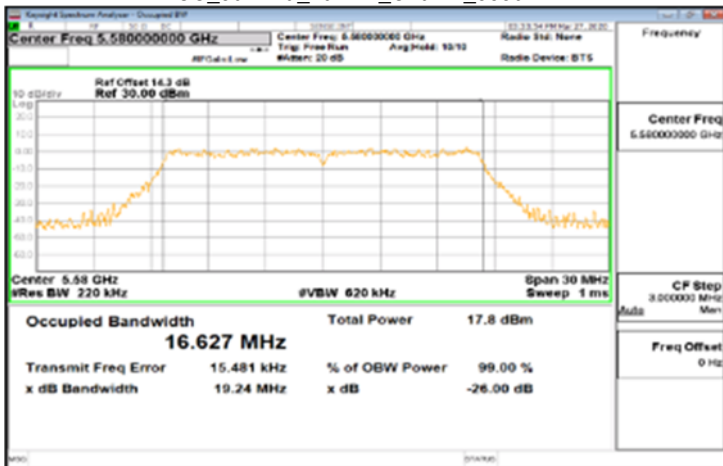

FCC 802.11a_20MHz_Chain1_5745MHz

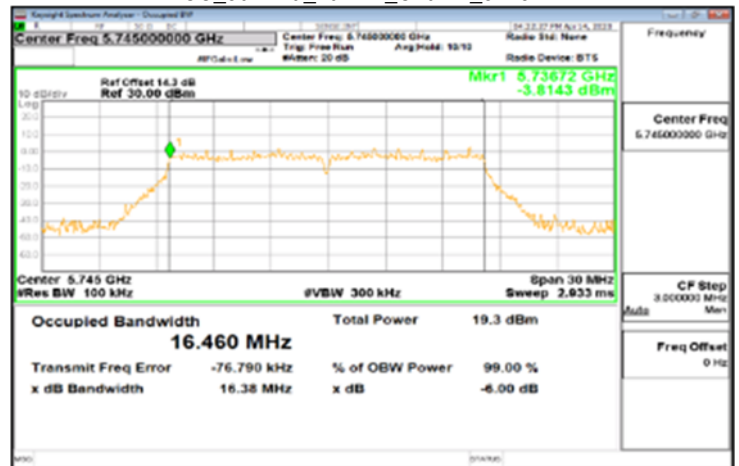

Unless otherwise stated the results shown in this test report refer only to the sample(s) tested and such sample(s) are retained for 90 days only.

除非另有說明，此報告結果僅對測試之樣品負責，同時此樣品僅保留90天。本報告未經本公司書面許可，不可部份複製。

This document is issued by the Company subject to its General Conditions of Service printed overleaf, available on request or accessible at <http://www.sgs.com.tw/Terms-and-Conditions> and for electronic format documents, subject to Terms and Conditions for Electronic Documents at <http://www.sgs.com.tw/Terms-and-Conditions>. Attention is drawn to the limitation of liability, indemnification and jurisdiction issues defined therein. Any holder of this document is advised that information contained hereon reflects the Company's findings at the time of its intervention only and within the limits of Client's instructions, if any. The Company's sole responsibility is to its Client and this document does not exonerate parties to a transaction from exercising all their rights and obligations under the transaction documents. This document cannot be reproduced except in full, without prior written approval of the Company. Any unauthorized alteration, forgery or falsification of the content or appearance of this document is unlawful and offenders may be prosecuted to the fullest extent of the law.

FCC 802.11a_20MHz_Chain1_5785MHz

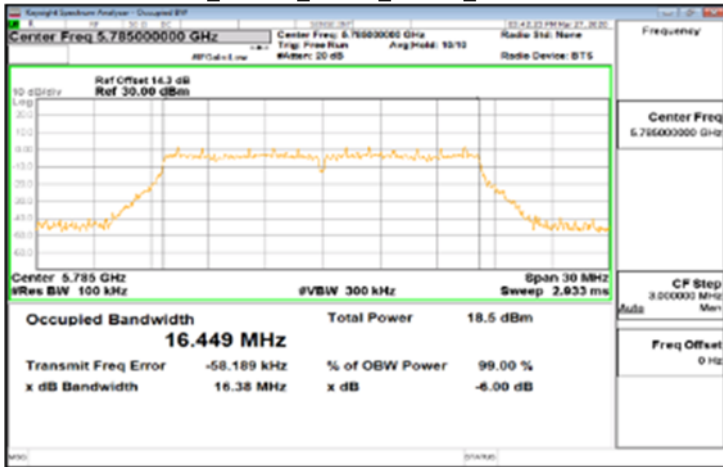

FCC 802.11n_20MHz_Chain0_5220MHz

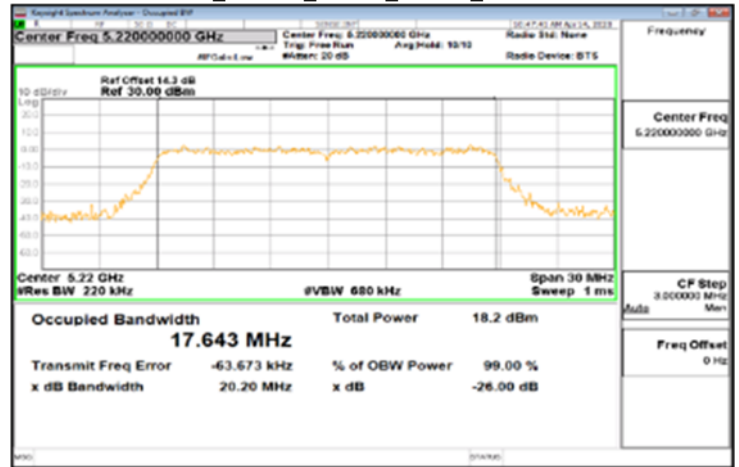

FCC 802.11a_20MHz_Chain1_5825MHz

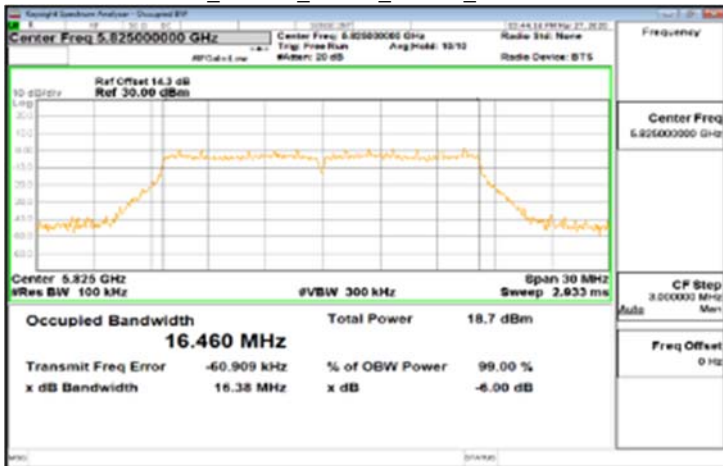

FCC 802.11n_20MHz_Chain0_5240MHz



FCC 802.11n_20MHz_Chain0_5180MHz

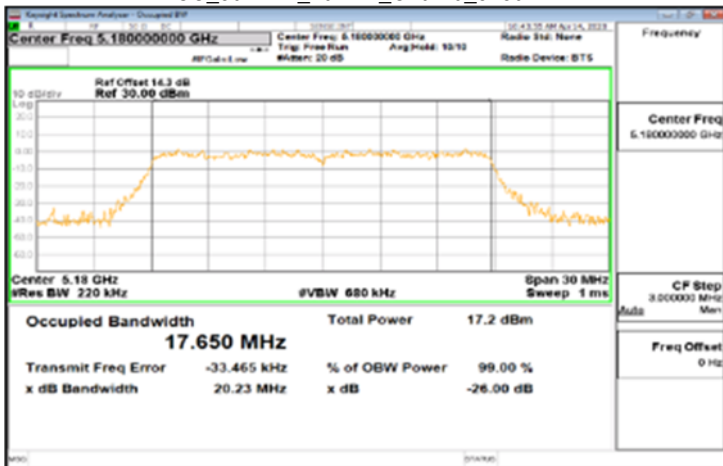

FCC 802.11n_20MHz_Chain0_5260MHz

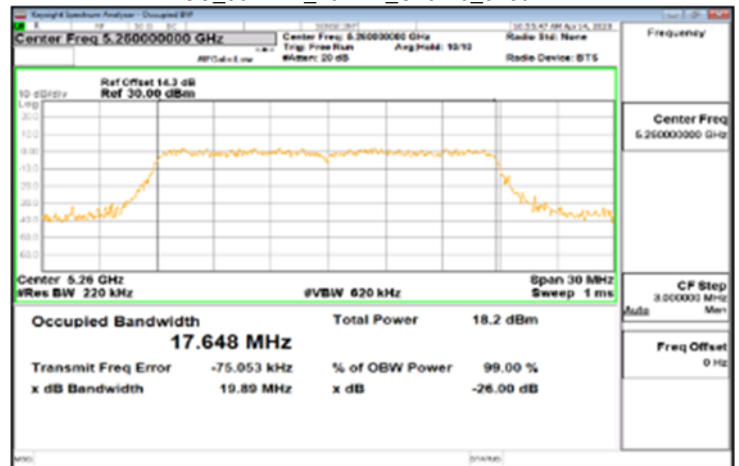

Unless otherwise stated the results shown in this test report refer only to the sample(s) tested and such sample(s) are retained for 90 days only.

除非另有說明，此報告結果僅對測試之樣品負責，同時此樣品僅保留90天。本報告未經本公司書面許可，不可部份複製。

This document is issued by the Company subject to its General Conditions of Service printed overleaf, available on request or accessible at <http://www.sgs.com.tw/Terms-and-Conditions> and for electronic format documents, subject to Terms and Conditions for Electronic Documents at <http://www.sgs.com.tw/Terms-and-Conditions>. Attention is drawn to the limitation of liability, indemnification and jurisdiction issues defined therein. Any holder of this document is advised that information contained hereon reflects the Company's findings at the time of its intervention only and within the limits of Client's instructions, if any. The Company's sole responsibility is to its Client and this document does not exonerate parties to a transaction from exercising all their rights and obligations under the transaction documents. This document cannot be reproduced except in full, without prior written approval of the Company. Any unauthorized alteration, forgery or falsification of the content or appearance of this document is unlawful and offenders may be prosecuted to the fullest extent of the law.

SGS Taiwan Ltd.

台灣檢驗科技股份有限公司

No.134,Wu Kung Road, New Taipei Industrial Park, Wuku District, New Taipei City, Taiwan/新北市五股區新北產業園區五工路 134 號

t (886-2) 2299-3279

f (886-2) 2298-0488

www.sgs.com.tw

Member of SGS Group

FCC 802.11n_20MHz_Chain0_5300MHz

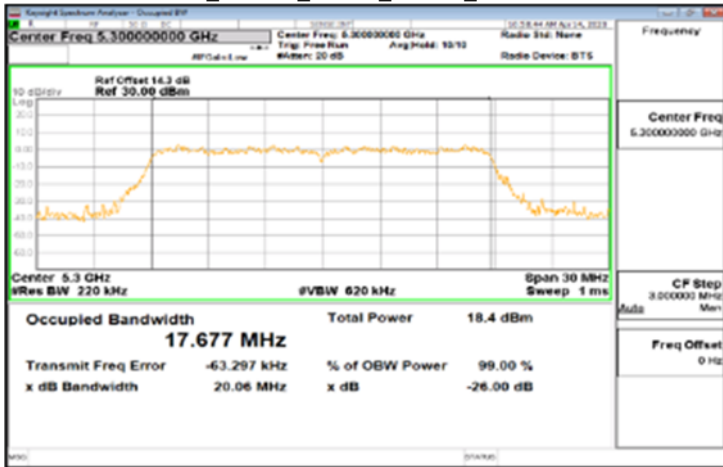

FCC 802.11n_20MHz_Chain0_5580MHz

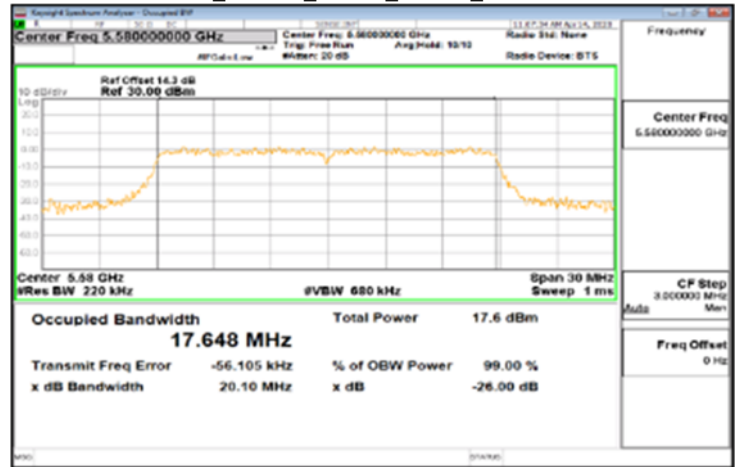

FCC 802.11n_20MHz_Chain0_5320MHz

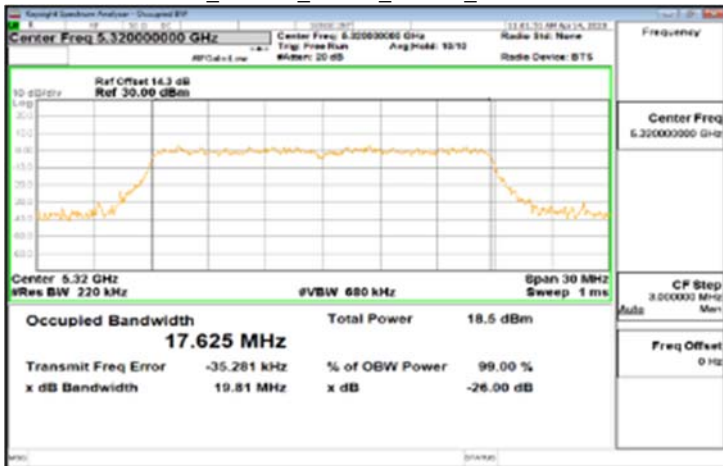

FCC 802.11n_20MHz_Chain0_5700MHz

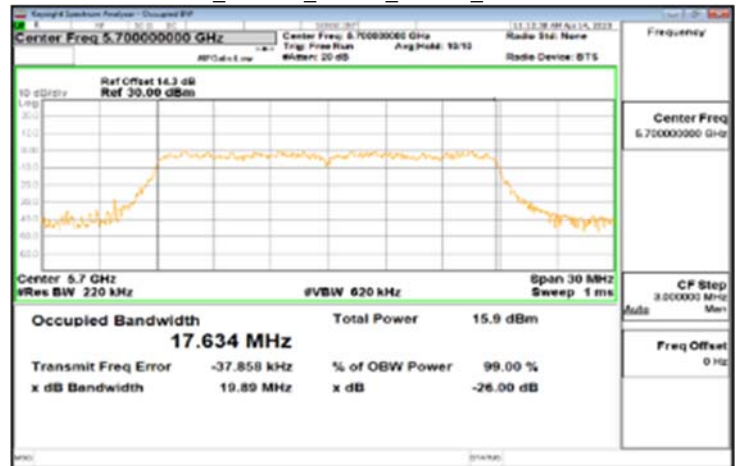

FCC 802.11n_20MHz_Chain0_5500MHz

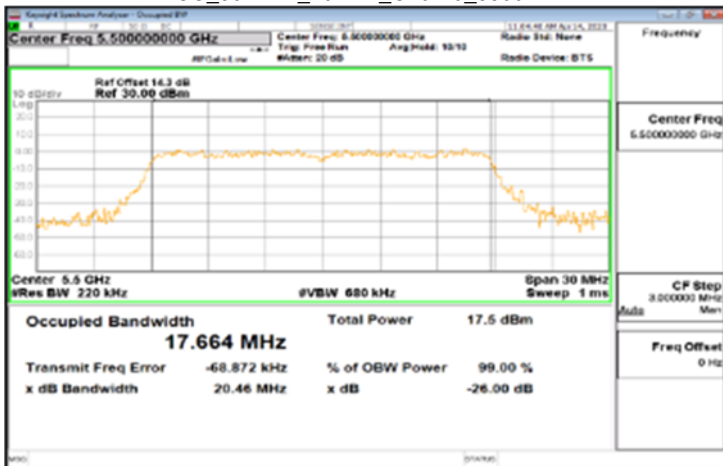

FCC 802.11n_20MHz_Chain0_5720MHz

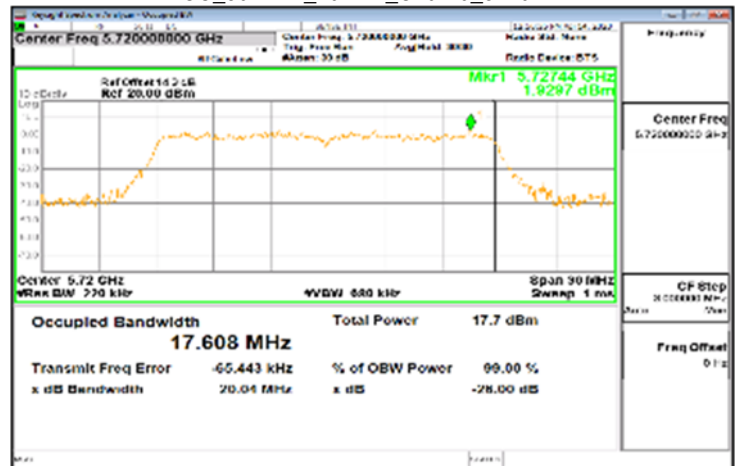

Unless otherwise stated the results shown in this test report refer only to the sample(s) tested and such sample(s) are retained for 90 days only.

除非另有說明，此報告結果僅對測試之樣品負責，同時此樣品僅保留90天。本報告未經本公司書面許可，不可部份複製。

This document is issued by the Company subject to its General Conditions of Service printed overleaf, available on request or accessible at <http://www.sgs.com.tw/Terms-and-Conditions> and for electronic format documents, subject to Terms and Conditions for Electronic Documents at <http://www.sgs.com.tw/Terms-and-Conditions>. Attention is drawn to the limitation of liability, indemnification and jurisdiction issues defined therein. Any holder of this document is advised that information contained hereon reflects the Company's findings at the time of its intervention only and within the limits of Client's instructions, if any. The Company's sole responsibility is to its Client and this document does not exonerate parties to a transaction from exercising all their rights and obligations under the transaction documents. This document cannot be reproduced except in full, without prior written approval of the Company. Any unauthorized alteration, forgery or falsification of the content or appearance of this document is unlawful and offenders may be prosecuted to the fullest extent of the law.

FCC 802.11n_20MHz_Chain0_5745MHz

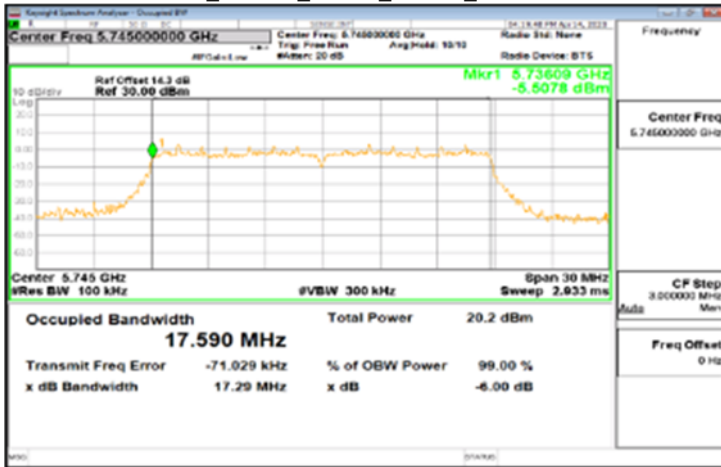

FCC 802.11n_20MHz_Chain1_5180MHz

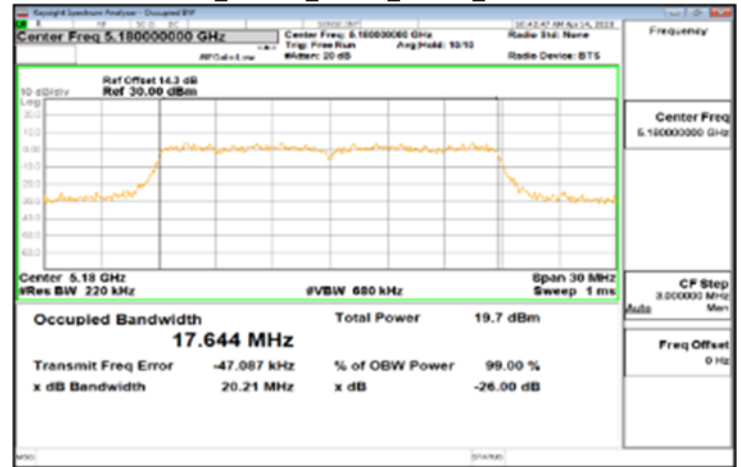

FCC 802.11n_20MHz_Chain0_5785MHz

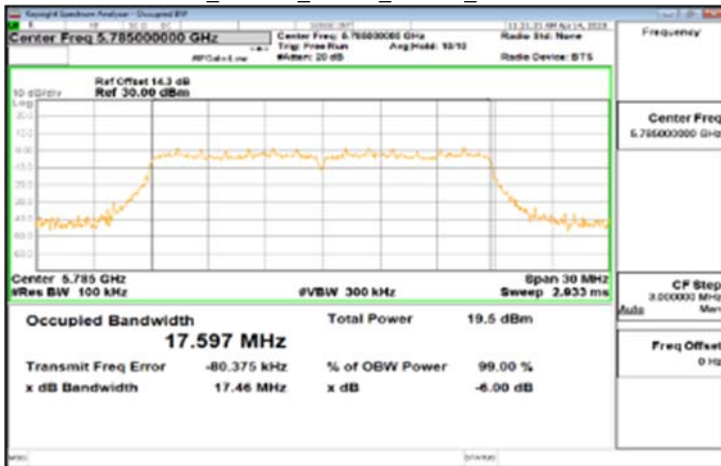

FCC 802.11n_20MHz_Chain1_5220MHz

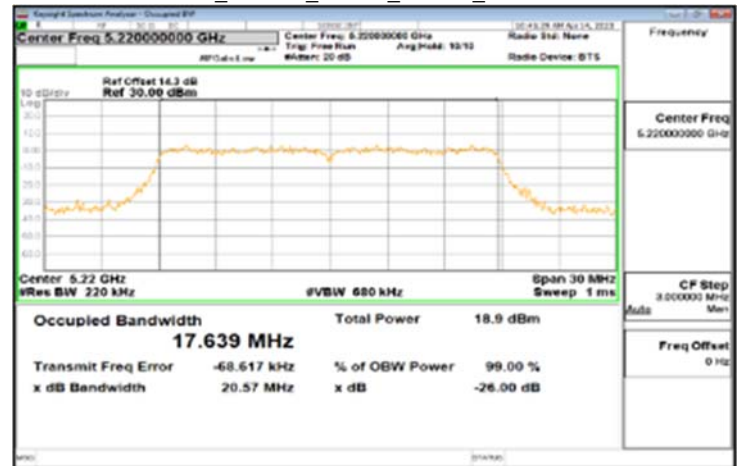

FCC 802.11n_20MHz_Chain0_5825MHz

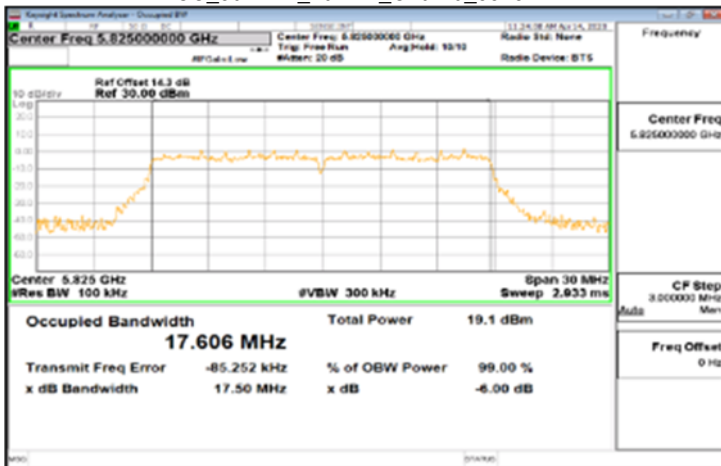

FCC 802.11n_20MHz_Chain1_5240MHz

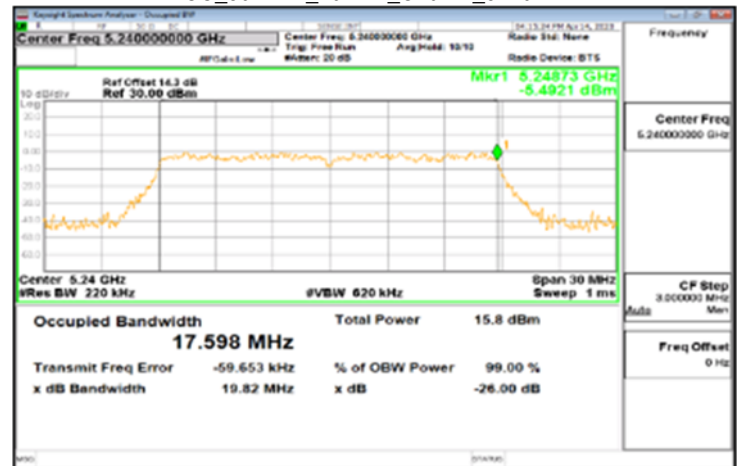

Unless otherwise stated the results shown in this test report refer only to the sample(s) tested and such sample(s) are retained for 90 days only.

除非另有說明，此報告結果僅對測試之樣品負責，同時此樣品僅保留90天。本報告未經本公司書面許可，不可部份複製。

This document is issued by the Company subject to its General Conditions of Service printed overleaf, available on request or accessible at <http://www.sgs.com.tw/Terms-and-Conditions> and for electronic format documents, subject to Terms and Conditions for Electronic Documents at <http://www.sgs.com.tw/Terms-and-Conditions>. Attention is drawn to the limitation of liability, indemnification and jurisdiction issues defined therein. Any holder of this document is advised that information contained hereon reflects the Company's findings at the time of its intervention only and within the limits of Client's instructions, if any. The Company's sole responsibility is to its Client and this document does not exonerate parties to a transaction from exercising all their rights and obligations under the transaction documents. This document cannot be reproduced except in full, without prior written approval of the Company. Any unauthorized alteration, forgery or falsification of the content or appearance of this document is unlawful and offenders may be prosecuted to the fullest extent of the law.

SGS Taiwan Ltd.

台灣檢驗科技股份有限公司

No.134,Wu Kung Road, New Taipei Industrial Park, Wuku District, New Taipei City, Taiwan/新北市五股區新北產業園區五工路 134 號

t (886-2) 2299-3279

f (886-2) 2298-0488

www.sgs.com.tw

Member of SGS Group

FCC 802.11n_20MHz_Chain1_5260MHz

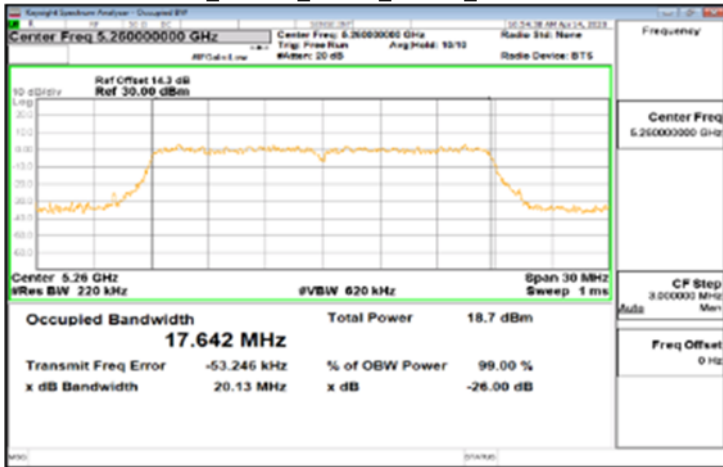

FCC 802.11n_20MHz_Chain1_5500MHz

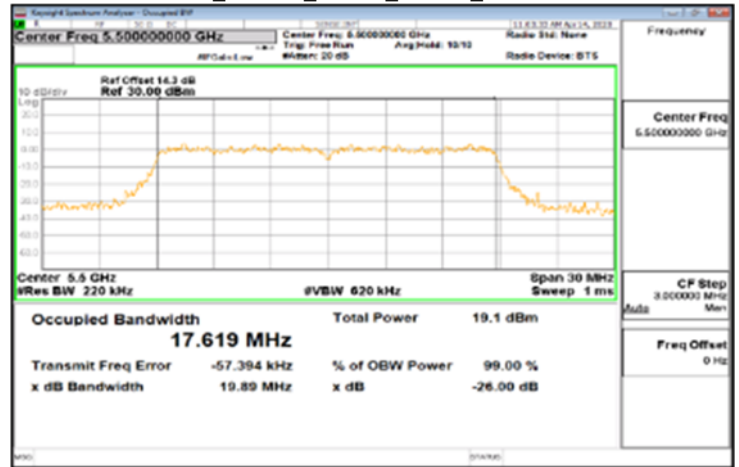

FCC 802.11n_20MHz_Chain1_5300MHz

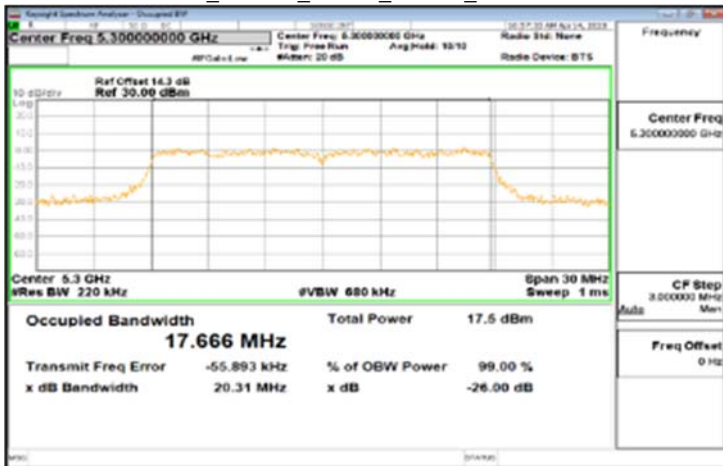

FCC 802.11n_20MHz_Chain1_5580MHz

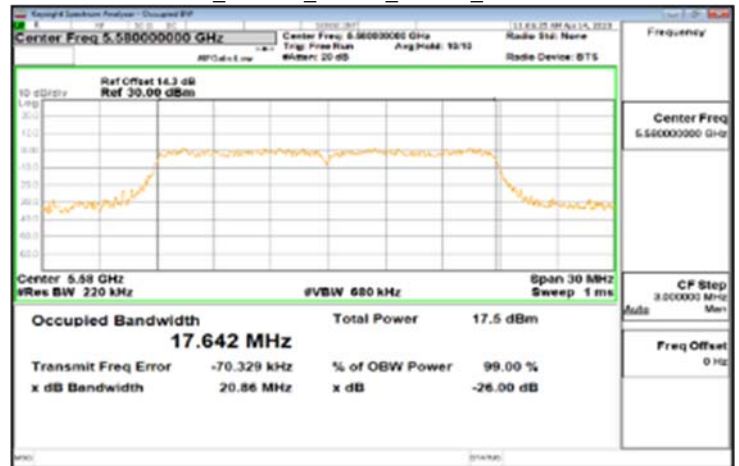

FCC 802.11n_20MHz_Chain1_5320MHz

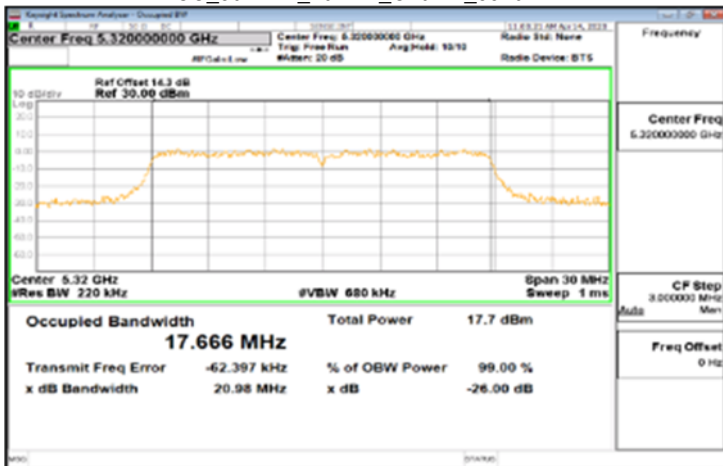

FCC 802.11n_20MHz_Chain1_5700MHz

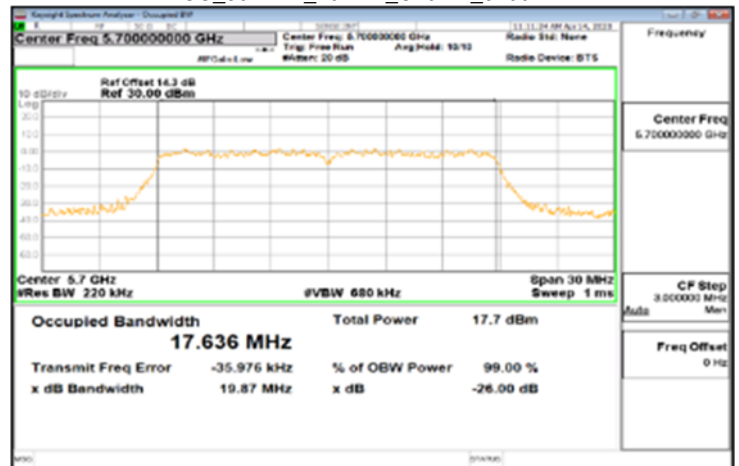

Unless otherwise stated the results shown in this test report refer only to the sample(s) tested and such sample(s) are retained for 90 days only.

除非另有說明，此報告結果僅對測試之樣品負責，同時此樣品僅保留90天。本報告未經本公司書面許可，不可部份複製。

This document is issued by the Company subject to its General Conditions of Service printed overleaf, available on request or accessible at <http://www.sgs.com.tw/Terms-and-Conditions> and for electronic format documents, subject to Terms and Conditions for Electronic Documents at <http://www.sgs.com.tw/Terms-and-Conditions>. Attention is drawn to the limitation of liability, indemnification and jurisdiction issues defined therein. Any holder of this document is advised that information contained hereon reflects the Company's findings at the time of its intervention only and within the limits of Client's instructions, if any. The Company's sole responsibility is to its Client and this document does not exonerate parties to a transaction from exercising all their rights and obligations under the transaction documents. This document cannot be reproduced except in full, without prior written approval of the Company. Any unauthorized alteration, forgery or falsification of the content or appearance of this document is unlawful and offenders may be prosecuted to the fullest extent of the law.