

RF Test Report

Applicant : Nippon POP Rivets & Fasteners Ltd.
Product Type : Power Tool
Trade Name : STANLEY
Model Number : NB08PT-18
Applicable Standard : FCC 47 CFR PART 15 SUBPART C
ANSI C63.10:2013
Received Date : Oct. 19, 2020
Test Period : Nov. 12 ~ Dec. 02, 2020
Issued Date : Dec. 16, 2020

Issued by

A Test Lab Techno Corp.
No. 140-1, Changan Street, Bade District,
Taoyuan City 33465, Taiwan (R.O.C.)
Tel : +886-3-2710188 / Fax : +886-3-2710190



Taiwan Accreditation Foundation accreditation number: 1330
Frequency Range : 9 kHz to 40 GHz
Test Firm MRA designation number: TW0010

Note:

- 1.The test results are valid only for samples provided by customers and under the test conditions described in this report.
- 2.This report shall not be reproduced except in full, without the written approval of A Test Lab Technology Corporation.
- 3.The relevant information is provided by customers in this test report. According to the correctness, appropriateness or completeness of the information provided by the customer, if there is any doubt or error in the information which affects the validity of the test results, the laboratory does not take the responsibility.



Revision History

Rev.	Issued Date	Revisions	Revised By
00	Dec. 16, 2020	Initial Issue	Emma Chao

Verification of Compliance

Applicant : Nippon POP Rivets & Fasteners Ltd.
Product Type : Power Tool
Trade Name : STANLEY
Model Number : NB08PT-18
FCC ID : 2AWAW-NB08PT18
EUT Rated Voltage : DC 20 V
Test Voltage : DC 20 V
Applicable Standard : FCC 47 CFR PART 15 SUBPART C
ANSI C63.10:2013
Test Result : Complied

Performing Lab. : A Test Lab Techno Corp.
No. 140-1, Changan Street, Bade District,
Taoyuan City 33465, Taiwan (R.O.C.)
Tel : +886-3-2710188 / Fax : +886-3-2710190
Taiwan Accreditation Foundation accreditation number: 1330
<http://www.atl-lab.com.tw/e-index.htm>



A Test Lab Techno Corp. tested the above equipment in accordance with the requirements set forth in the above standards. All indications of Pass/Fail in this report are opinions expressed by A Test Lab Techno Corp. based on interpretations and/or observations of test results. The test results show that the equipment tested is capable of demonstrating compliance with the requirements as documented in this report.

Approved By
(Manager)

: Fly Lu
(Fly Lu)



TABLE OF CONTENTS

1	General Information.....	5
	1.1. Summary of Test Result.....	5
	1.2. Measurement Uncertainty.....	5
2	EUT Description.....	6
3	Test Methodology.....	7
	3.1. Mode of Operation.....	7
	3.2. EUT Test Step.....	7
	3.3. Configuration of Test System Details.....	8
	3.4. Test Instruments.....	9
	3.5. Test Site Environment.....	9
4	Measurement Procedure.....	10
	4.1. Maximum Conducted Output Power Measurement.....	10
	4.2. AC Power Line Conducted Emission Measurement.....	11
	4.3. Radiated Emission Measurement.....	13
	4.4. 20 dB RF Bandwidth Measurement.....	16
	4.5. Carrier Frequency Separation Measurement.....	17
	4.6. Number of Hopping Measurement.....	18
	4.7. Time of Occupancy (Dwell Time) Measurement.....	19
	4.8. Out of Band Conducted Emissions Measurement.....	20
	4.9. Antenna Measurement.....	20
5	Test Results.....	21
	Annex A. Conducted Test Results.....	21
	Annex B. Radiated Emission Measurement.....	39



1 General Information

1.1. Summary of Test Result

Standard	Item	Result	Remark
15.207	AC Power Conducted Emission	N/A	The EUT used DC Power source.
15.203	Antenna Requirement	PASS	-----
15.247(b)(1)	Max. Output Power	PASS	-----
15.247(d)	Transmitter Radiated Emissions	PASS	-----
15.247(a)(1)	20 dB RF Bandwidth	PASS	-----
15.247(a)(1)	Carrier Frequency Separation	PASS	-----
15.247(a)(1)(iii)	Number of Hopping	PASS	-----
15.247(a)(1)(iii)	Time of Occupancy (Dwell Time)	PASS	-----
15.247(d)	Out of Band Conducted Spurious Emission	PASS	-----

Standard	Description
CFR47, Part 15, Subpart C	Intentional Radiators
ANSI C63. 10: 2013	American National Standard of Procedures for Compliance Testing of Unlicensed Wireless Devices
DA 00-705	Filing and Measurement Guidelines for Frequency Hopping Spread Spectrum Systems

Decision Rule

- Uncertainty is not included.
- Uncertainty is included.

1.2. Measurement Uncertainty

Test Item	Frequency Range	Uncertainty
Radiated Emission	9 kHz ~ 30 MHz	2.2 dB
	30 MHz ~ 1000 MHz	5.1 dB
	1000 MHz ~ 18000 MHz	5.1 dB
	18000 MHz ~ 26500 MHz	4.4 dB
	26500 MHz ~ 40000 MHz	4.6 dB
Conducted Output Power	1.1 dB	
RF Bandwidth	4.7 %	

2 EUT Description

Applicant	Nippon POP Rivets & Fasteners Ltd. Hosoda, Noyori-cho, Toyohashi-shi, Aichi, 441-8540, Japan		
Manufacturer	Nippon POP Rivets & Fasteners Ltd. Hosoda, Noyori-cho, Toyohashi-shi, Aichi, 441-8540, Japan		
Product	Power Tool		
Trade Name	STANLEY		
Model Number	NB08PT-18		
FCC ID	2AWAW-NB08PT18		
Frequency Range	2402 ~ 2480 MHz		
Modulation Type	GFSK for 1 Mbps		
	$\pi/4$ -DQPSK for 2 Mbps		
	8DPSK for 3 Mbps		
Operate Temp. Range	0 ~ +40 °C		
Antenna information	Type	Max. Gain (dBi)	
	PCB antenna	2	
Max. RF Output Power	GFSK for 1 Mbps	0.00230	W
	$\pi/4$ -DQPSK for 2 Mbps	0.00240	W
	8DPSK for 3 Mbps	0.00262	W

3 Test Methodology

3.1. Mode of Operation

Decision of Test ATL has verified the construction and function in typical operation. All the test modes were carried out with the EUT in normal operation, which was shown in this test report and defined as:

Pre-Test Mode
Mode 1: GFSK Continuous TX mode
Mode 2: $\pi/4$ -DQPSK Continuous TX mode
Mode 3: 8DPSK Continuous TX mode

After verification, all tests were carried out with the worst case test modes.

By preliminary testing and verifying three axis (X and Y) position of EUT transmitted status, it was found that "Y axis" position was the worst, then the final test was executed the worst condition and test data were recorded in this report.

Final-Test Mode
Mode 1: GFSK Continuous TX mode
Mode 3: 8DPSK Continuous TX mode

Description of Test Modes

Preliminary tests were performed in different modulation to find the worst case. The modulation has shown the worst-case in section 4.5. Investigation has been done on all the possible configurations for searching the worst cases.

3.2. EUT Test Step

1	Setup the EUT shown on "Configuration of Test System Details."
2	Turn on the power of all equipment.
3	Turn on TX function
4	EUT run test program.

Measurement Software			
No.	Description	Software	Version
1	Radiated Emission	EZ EMC	1.1.4.4

3.3. Configuration of Test System Details

Radiated Emissions

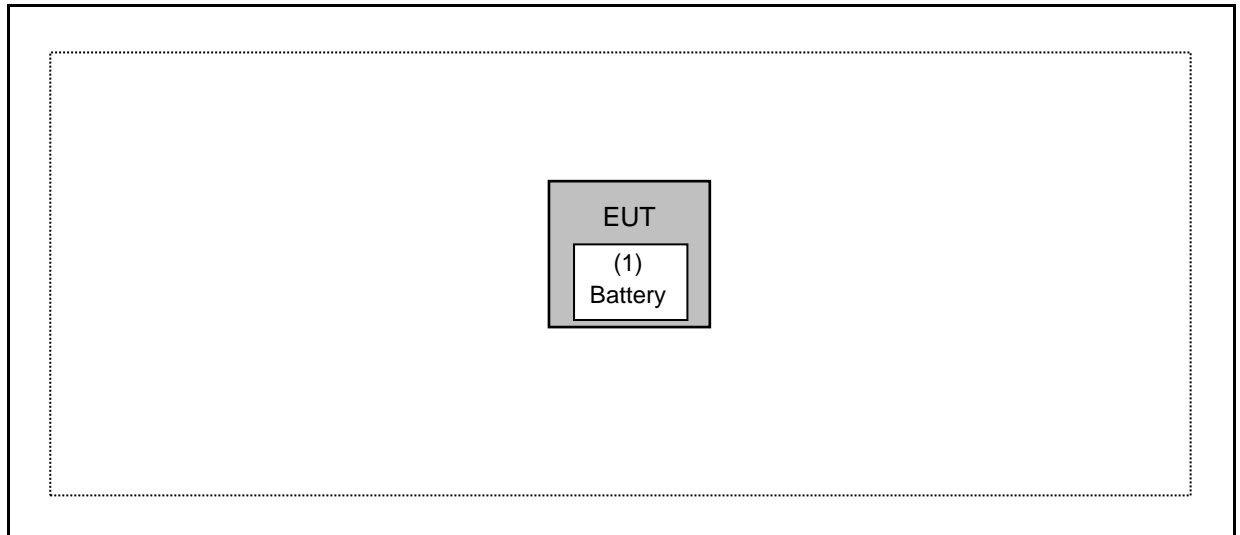

Devices Description					
	Product	Manufacturer	Model Number	Serial Number	Power Cord
(1)	Battery	DEWALT	DCB203	N/A	N/A



3.4. Test Instruments

For Radiated Emissions

Test Period: Nov. 14 ~ Nov. 30, 2020

Testing Engineer: Ricky, Pink.Li, JS.Liao, Marc Yeh

Equipment	Manufacturer	Model Number	Serial Number	Cal. Date	Cal. Period
Spectrum Analyzer	KEYSIGHT	N9030B	MY57143537	04/14/2020	1 year
Pre Amplifier (1 kHz~1 GHz)	Titan	T0910E00014330A1F	001	07/23/2020	1 year
Pre Amplifier (1~26.5 GHz)	Titan	T0912E01263025A1F	002	07/23/2020	1 year
Loop Antenna	COM-POWER CORPORATION	AL-130	121014	03/27/2020	1 year
Broadband Antenna	Schwarzbeck	VULB9168	01146	07/03/2020	1 year
Horn Antenna (1~18 GHz)	SCHWARZBECK MESS-ELEKTRONIK	BBHA9120D	02207	06/30/2020	1 year
Horn Antenna (18~40 GHz)	SCHWARZBECK MESS-ELEKTRONIK	BBHA9170	9170-320	08/18/2020	1 year
Coaxial Cable	Titan	T0710AT327A10A100	J11005	08/13/2020	1 year
Coaxial Cable	Titan	T0710AT327A10A900	J11004	08/13/2020	1 year
Coaxial Cable	Titan	T0712AT340A12A900	J11002	08/13/2020	1 year

For Conducted

Test Period: Nov. 12 ~ Dec. 02, 2020

Testing Engineer: Brian.Lin, Andy Lu, Peter Shui

Equipment	Manufacturer	Model Number	Serial Number	Cal. Date	Cal. Period
Power Sensor	Anritsu	MA2411B	1126022	09/01/2020	1 year
Power Meter	Anritsu	ML2495A	1135009	09/01/2020	1 year
Spectrum Analyzer (20 Hz~26.5 GHz)	Agilent	N9020A	US47520902	09/24/2020	1 year

Note: N.C.R. = No Calibration Request.

3.5. Test Site Environment

Items	Required (IEC 60068-1)	Actual
Temperature (°C)	15-35	20-30
Humidity (%RH)	25-75	45-75

4 Measurement Procedure

4.1. Maximum Conducted Output Power Measurement

■ Limit

For frequency hopping systems operating in the 2400–2483.5 MHz band employing at least 75 non-overlapping hopping channels < 0.125 watt.

■ Test Setup

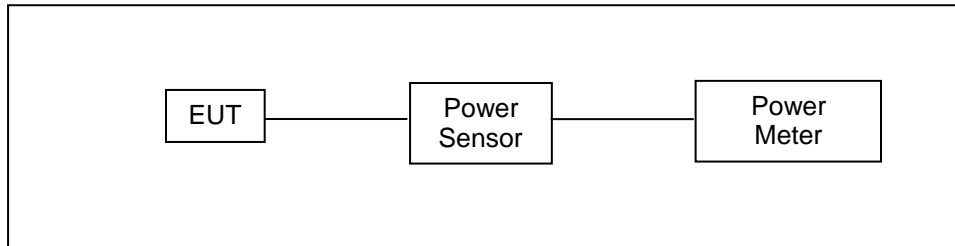

■ Test Procedure

Testing must be done according to this procedure, FCC Public Notice DA 00-705 - Filing and Measurement Guidelines for Frequency Hopping Spread Spectrum Systems. This is the only method recognized by the FCC. The tests below are run with the EUT's transmitter set at high power in TX mode. The EUT is needed to force selection of output power level and channel number. While testing, EUT was set to transmit continuously. Remove the Subjective device's antenna and connect the RF output port to power sensor. The maximum peak output power shall not exceed 1 watt.

Use a direct connection between the antenna port of transmitter and the power sensor, for prevent the power sensor input attenuation 40-50 dB. Set the RBW Bandwidth of the emission or use a channel power meter mode. For antennas with gains of 6 dBi or less, maximum allowed transmitter output is 1 watt (+30 dBm). For antennas with gains greater than 6 dBi, transmitter output level must be decreased by an amount equal to (GAIN - 6)/3 dBm. The antenna port of the EUT was connected to the input of a power sensor. Power was read directly and cable loss correction was added to the reading to obtain power at the EUT antenna terminals.

4.2. AC Power Line Conducted Emission Measurement

■ Limit

Frequency (MHz)	Quasi-peak	Average
0.15 - 0.5	66 to 56	56 to 46
0.50 - 5.0	56	46
5.0 - 30.0	60	50

■ Test Setup

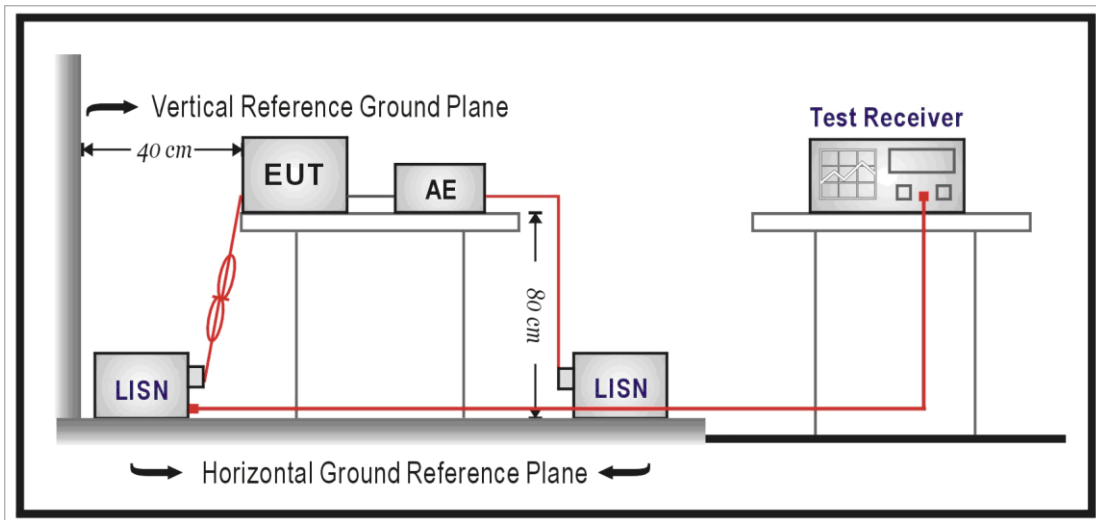

■ Test Procedure

The EUT and simulators are connected to the main power through a line impedance stabilization network (L.I.S.N.). This provides a $50 \Omega // 50 \mu\text{H}$ coupling impedance for the measuring equipment. The peripheral devices are also connected to the main power through a LISN that provides a $50 \Omega // 50 \mu\text{H}$ coupling impedance with 50 ohm termination.

Tabletop device shall be placed on a non-conducting platform, of nominal size 1 m by 1.5 m, raised 80 cm above the reference ground plane. The wall of screened room shall be located 40 cm to the rear of the EUT. Other surfaces of tabletop or floor standing EUT shall be at least 80 cm from any other ground conducting surface including one or more LISNs. For floor-standing device shall be placed under the EUT with a 12 mm insulating material.

Conducted emissions were investigated over the frequency range from 0.15 MHz to 30 MHz using a resolution bandwidth of 9 kHz. The equipment under test (EUT) shall be meet the limits in section 4.1, as applicable, including the average limit and the quasi-peak limit when using respectively, an average detector and quasi-peak detector measured in accordance with the methods described of related standard. When all of peak value were complied with quasi-peak and average limit from 150 kHz to 30 MHz then quasi-peak and average measurement was unnecessary.

The AMN shall be placed 0.8 m from the boundary of the unit under test and bonded to a ground reference plane for AMNs mounted on top of the ground reference plane. This distance is between the closest points of the AMN and the EUT. All other units of the EUT and associated equipment shall be at least 0.8 m from the AMN. If the mains power cable is longer than 1 m then the cable shall be folded back and forth at the centre of the lead to form a bundle no longer than 0.4 m. All of interconnecting cables that hang closer than 40 cm to the ground plane shall be folded back and forth in the center forming a bundle 30 cm to 40 cm long. All of EUT and AE shall be separate place more than 0.1 m. All 50Ω ports of the LISN shall be resistively terminated into 50Ω loads when not connected to the measuring instrument.

If the reading of the measuring receiver shows fluctuations close to the limit, the reading shall be observed for at least 15 s at each measurement frequency; the higher reading shall be recorded with the exception of any brief isolated high reading which shall be ignored.

4.3. Radiated Emission Measurement

■ **Limit**

According to §15.209(a), except as provided elsewhere in this subpart, the emissions from an intentional radiator shall not exceed the field strength levels specified in the following table:

Frequency (MHz)	Field Strength ($\mu\text{V}/\text{m}$ at meter)	Measurement Distance (meters)
0.009 – 0.490	2400 / F (kHz)	300
0.490 – 1.705	24000 / F (kHz)	30
1.705 – 30.0	30	30
30 - 88	100**	3
88-216	150**	3
216-960	200**	3
Above 960	500	3

** Except as provided in paragraph (g), fundamental emissions from intentional radiators operating under this Section shall not be located in the frequency bands 54-72 MHz, 76-88 MHz, 174-216 MHz or 470-806 MHz. However, operation within these frequency bands is permitted under other sections of this Part, e.g., Sections 15.231 and 15.241.

■ **Setup**

9 kHz ~ 30 MHz

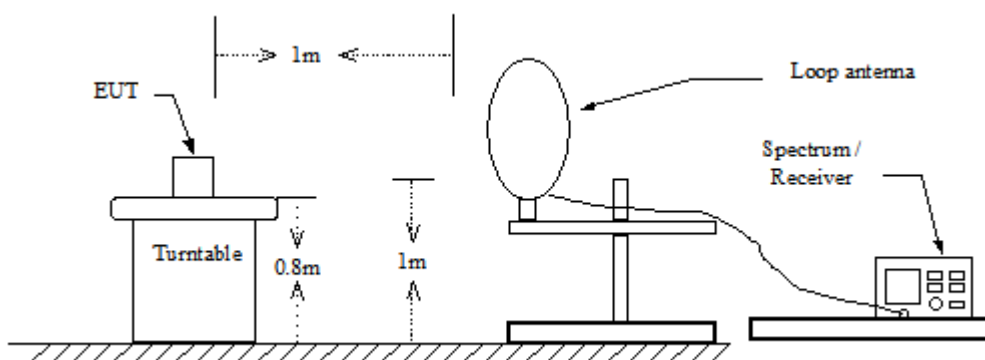

Below 1 GHz

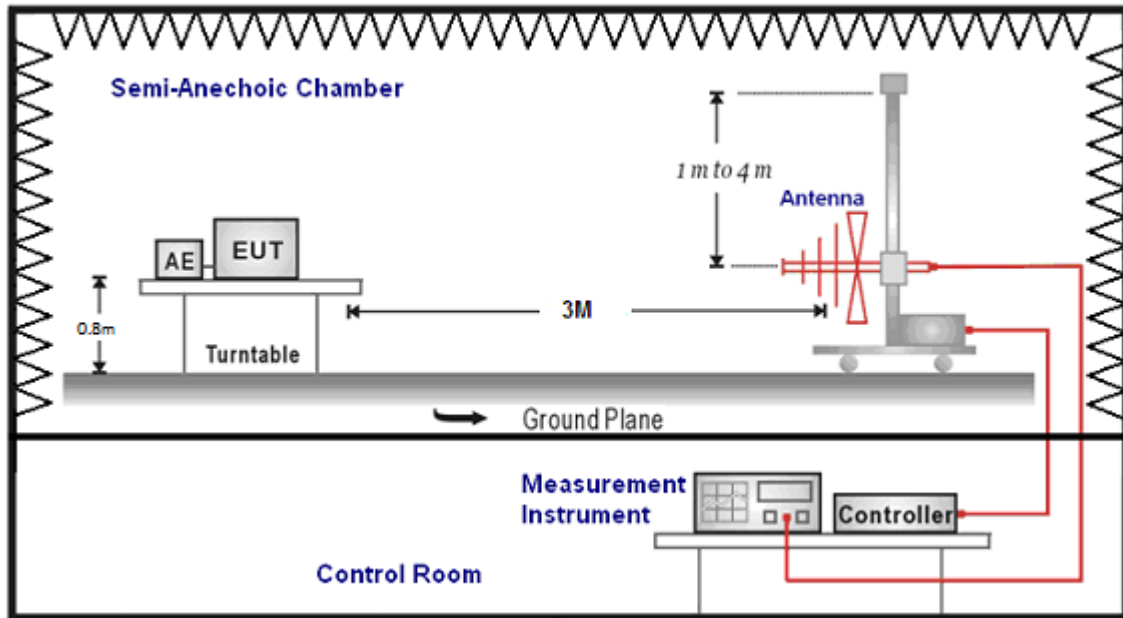

Above 1 GHz

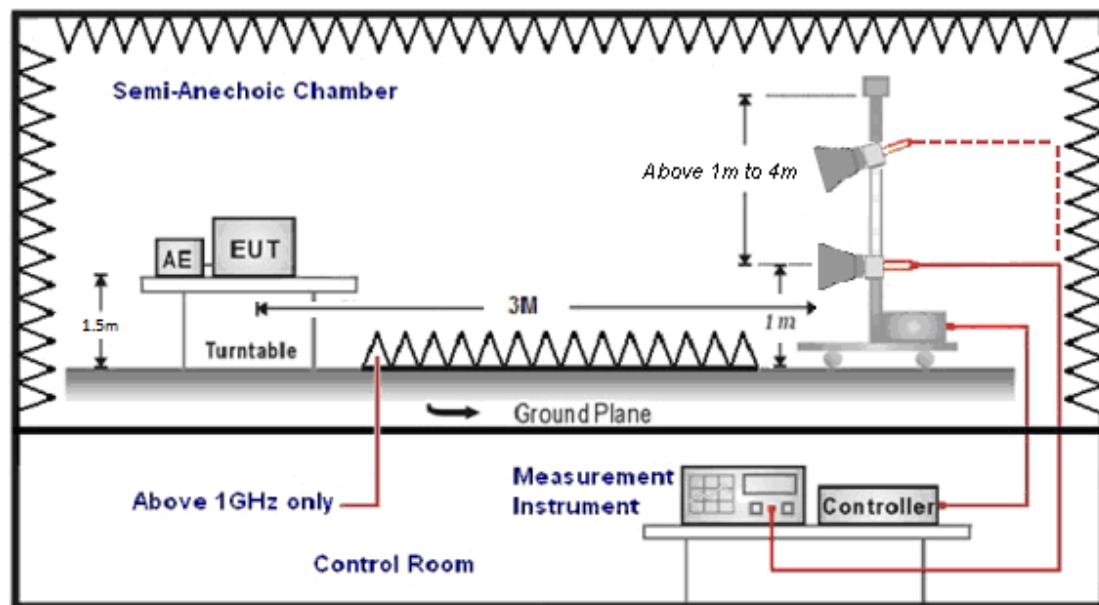



■ Test Procedure

Final radiation measurements were made on a three-meter, Semi Anechoic Chamber. The EUT system was placed on a nonconductive turntable which is 0.8 or 1.5 meters height, top surface 1.0 x 1.5 meter. The spectrum was examined from 250 MHz to 2.5 GHz in order to cover the whole spectrum below 10th harmonic which could generate from the EUT. During the test, EUT was set to transmit continuously & Measurements spectrum range from 9 kHz to 26.5 GHz is investigated.

For measurements below 1 GHz the resolution bandwidth is set to 100 kHz for peak detection measurements or 120 kHz for quasi-peak detection measurements. Peak detection is used unless otherwise noted as quasi-peak.

For measurements above 1 GHz the resolution bandwidth is set to 1 MHz, and then the video bandwidth is set to 3 MHz for peak measurements and 10 Hz for average measurements when Duty cycle >98 % / 1/T for average measurements when Duty cycle <98 %. A nonconductive material surrounded the EUT to supporting the EUT for standing on three orthogonal planes. At each condition, the EUT was rotated 360 degrees, and the antenna was raised and lowered from one to four meters to find the maximum emission levels. Measurements were taken using both horizontal and vertical antenna polarization.

SCHWARZBECK MESS-ELEKTRONIK Biconilog Antenna at 3 Meter and the SCHWARZBECK Double Ridged Guide Antenna was used in frequencies 1 – 26.5 GHz at a distance of 1 meter. All test results were extrapolated to equivalent signal at 3 meters utilizing an inverse linear distance extrapolation Factor (20 dB/decade).

For testing above 1 GHz, the emission level of the EUT in peak mode was 20 dB lower than average limit (that means the emission level in peak mode also complies with the limit in average mode), then testing will be stopped and peak values of EUT will be reported, otherwise, the emissions will be measured in average mode again and reported.

Appropriate preamplifiers were used for improving sensitivity and precautions were taken to avoid overloading or desensitizing the spectrum analyzer. No post – detector video filters were used in the test.

The spectrum analyzer's 6 dB bandwidth was set to 1 MHz, and the analyzer was operated in the peak detection mode, for frequencies both below and up 1 GHz. The average levels were obtained by subtracting the duty cycle correction factor from the peak readings.

The following procedures were used to convert the emission levels measured in decibels referenced to 1 microvolt (dBuV) into field intensity in micro volts per meter (uV/m).

The actual field intensity in decibels referenced to 1 microvolt in to field intensity in micro volts per meter (dBuV/m).

The actual field intensity in referenced to 1 microvolt per meter (dBuV/m) is determined by algebraically adding the measured reading in dBuV, the antenna factor (dB), and cable loss (dB) and Subtracting the gain of preamplifier (dB) is auto calculate in spectrum analyzer.

$$(1) \text{ Amplitude (dBuV/m) = FI (dBuV) +AF (dBuV) +CL (dBuV)-Gain (dB)}$$

FI= Reading of the field intensity.

AF= Antenna factor.

CL= Cable loss.

P.S Amplitude is auto calculate in spectrum analyzer.

$$(2) \text{ Actual Amplitude (dBuV/m) = Amplitude (dBuV)-Dis(dB)}$$

The FCC specified emission limits were calculated according the EUT operating frequency and by following linear interpolation equations:

(a) For fundamental frequency : Transmitter Output < +30 dBm

(b) For spurious frequency : Spurious emission limits = fundamental emission limit /10

Data of measurement within this frequency range without mark in the table above means the reading of emissions are attenuated more than 20 dB below the permissible limits or the field strength is too small to be measured.

4.4. 20 dB RF Bandwidth Measurement

■ **Limit**

N/A

■ **Test Setup**

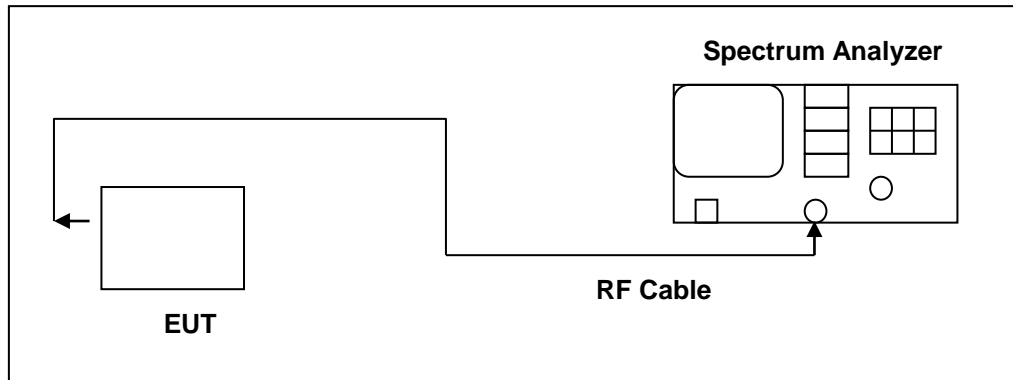

■ **Test Procedure**

Testing must be done according to this procedure, FCC Public Notice DA 00-705 - Filing and Measurement Guidelines for Frequency Hopping Spread Spectrum Systems. This is the only method recognized by the FCC. The RF output port of the Equipment-Under-Test is directly coupled to the input of the EMC analyzer through a specialized RF connector and a 10 dB passive attenuator. A fully charged battery was used for the supply voltage. The Bluetooth frequency hopping function of the EUT was enabled. The spectrum analyzer used the following settings:

1. Span = approx. 2 to 3 times the 20 dB bandwidth, centered on a hopping frequency
2. RBW \geq 1 % of the 20 dB span
3. VBW \geq RBW
4. Sweep = auto
5. Detector function = peak
6. Trace = max hold

The trace was allowed to stabilize. The EUT was transmitting at its maximum data rate. The marker-to-peak function was used to set the marker to the peak of the emission. The marker-delta function was used to measure 20 dB down one side of the emission. The marker-delta function and marker was moved to the other side of the emission until it was even with the reference marker. The marker-delta reading at this point was the 20 dB bandwidth of the emission.

4.5. Carrier Frequency Separation Measurement

■ Limit

Title 47 of the CFR, Part 15 Subpart (c) 15.247(a)(1) requires the measurement of the bandwidth of the transmission between the -20 dB points on the transmitted spectrum. The results of this test determine the limits for channel spacing. The channel spacing shall be a minimum of 25 kHz or the 20 dB bandwidth, whichever is greater. Alternatively, frequency hopping systems operating in the 2400-2483.5 MHz band may have hopping channel carrier frequencies that are separated by 25 kHz or two-thirds of the 20 dB bandwidth of the hopping channel.

■ Test Setup

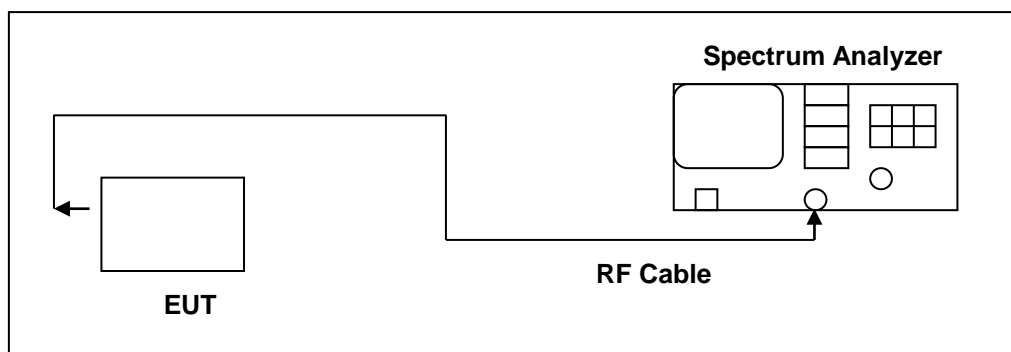

■ Test Procedure

Testing must be done according to this procedure, FCC Public Notice DA 00-705 - Filing and Measurement Guidelines for Frequency Hopping Spread Spectrum Systems. This is the only method recognized by the FCC. The RF output port of the Equipment-Under-Test is directly coupled to the input of the EMC analyzer through a specialized RF connector and a 10 dB passive attenuator. A fully charged battery was used for the supply voltage. The Bluetooth frequency hopping function of the EUT was enabled. The following spectrum analyzer settings were used:

1. Span = wide enough to capture the peaks of two adjacent channels
2. Resolution (or IF) Bandwidth (RBW) \geq 1 % of the span
3. Video (or Average) Bandwidth (VBW) \geq RBW
4. Sweep = auto
5. Detector function = peak
6. Trace = max hold

The trace was allowed to stabilize. The marker-delta function was used to determine the separation between the peaks of the adjacent channels.

4.6. Number of Hopping Measurement

■ Limit

Frequency hopping systems in the 2400–2483.5 MHz band shall use at least 15 channels.

■ Test Setup

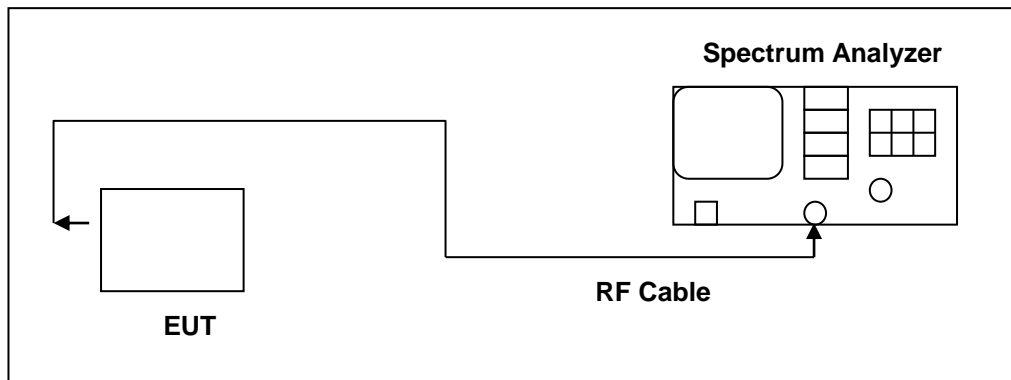

■ Test Procedure

Testing must be done according to this procedure, FCC Public Notice DA 00-705 - Filing and Measurement Guidelines for Frequency Hopping Spread Spectrum Systems. This is the only method recognized by the FCC. The RF output port of the Equipment-Under-Test is directly coupled to the input of the EMC analyzer through a specialized RF connector and a 10 dB passive attenuator. A fully charged battery was used for the supply voltage. The Bluetooth frequency hopping function of the EUT was enabled. The spectrum analyzer used the following settings:

1. Span = the frequency band of operation
2. RBW \geq 1 % of the span
3. VBW \geq RBW
4. Sweep = auto
5. Detector function = peak
6. Trace = max hold

The trace was allowed to stabilize.

4.7. Time of Occupancy (Dwell Time) Measurement

■ Limit

The average time of occupancy on any channel shall not be greater than 0.4 seconds within a period of 0.4 seconds multiplied by the number of hopping channels employed.

■ Test Setup

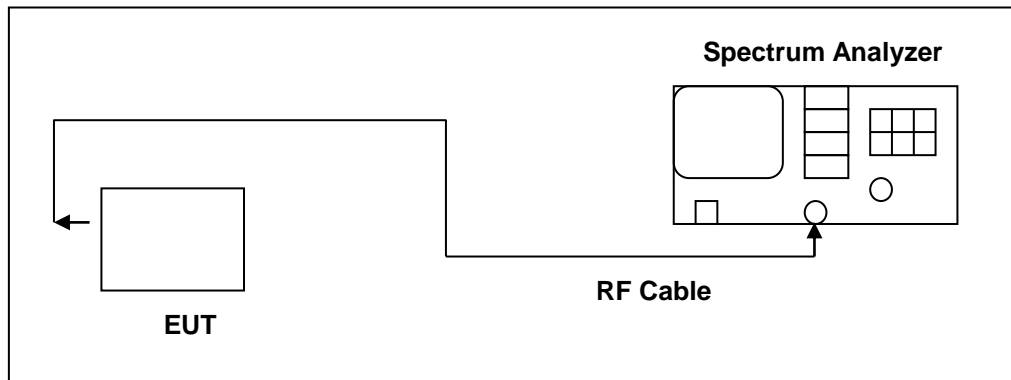

■ Test Procedure

Testing must be done according to this procedure, FCC Public Notice DA 00-705 - Filing and Measurement Guidelines for Frequency Hopping Spread Spectrum Systems. This is the only method recognized by the FCC. The RF output port of the Equipment-Under-Test is directly coupled to the input of the spectrum through a specialized RF connector and a 10 dB passive attenuator. A fully charged battery was used for the supply voltage. The Bluetooth hopping function of the EUT was enabled. The following spectrum analyzer settings were used:

1. Span = zero span, centered on a hopping channel
2. RBW = 1 MHz
3. VBW \geq RBW
4. Sweep = as necessary to capture the entire dwell time per hopping channel
5. Detector function = peak
6. Trace = max hold

The marker-delta function was used to determine the dwell time.

4.8. Out of Band Conducted Emissions Measurement

■ Limit

In any 100 kHz bandwidth outside the frequency band in which the spread spectrum or digitally modulated intentional radiator is operating, the radio frequency power that is produced by the intentional radiator shall be at least 20 dB below that in the 100 kHz bandwidth within the band that contains the highest level of the desired power

■ Test Setup

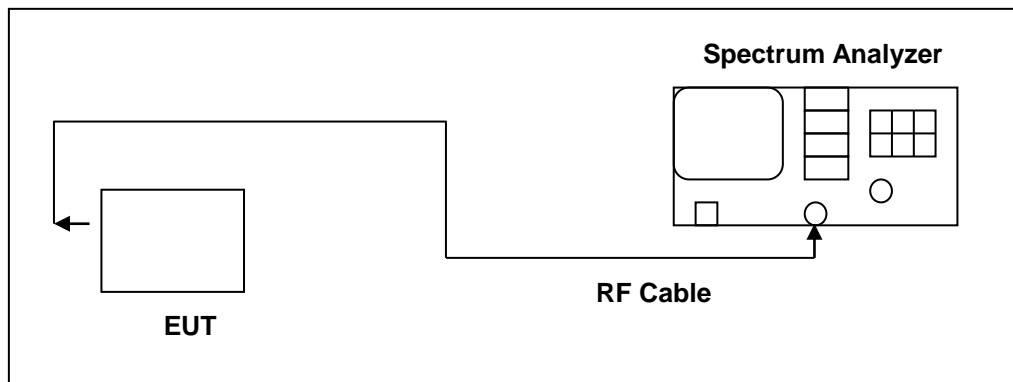

■ Test Procedure

Testing must be done according to this procedure, FCC Public Notice DA 00-705 - Filing and Measurement Guidelines for Frequency Hopping Spread Spectrum Systems. This is the only method recognized by the FCC. In any 100 kHz bandwidth outside the EUT pass band, the RF power produced by the modulation products of the spreading sequence, the information sequence, and the carrier frequency shall be at least 20 dB below that of the maximum in-band 100 kHz emission, antenna output of the EUT was coupled directly to spectrum analyzer; if an external attenuator and/or cable was used, these losses are compensated for with the analyzer OFFSET function. All other types of emissions from the EUT shall meet the general limits for radiated frequencies outside the pass band. The test was performed at 3 channels (Channel 0, 39, 78)

4.9. Antenna Measurement

■ Limit

For intentional device, according to 15.203, an intentional radiator shall be designed to ensure that no antenna other than that furnished by the responsible party shall be used with the device.

And According to 15.247 (b)(4), if transmitting antennas of directional gain greater than 6 dBi are used, the power shall be reduced by the amount in dB that the directional gain of the antenna exceeds 6 dBi.

■ Antenna Connector Construction

See section 2 – antenna information.

5 Test Results

Annex A. Conducted Test Results

Maximum Conducted Output Power Measurement

Test Mode	Frequency (MHz)	Packet Type	Average Power		Peak Power		Limit (W)
			(dBm)	(W)	(dBm)	(W)	
Mode 1	2402	DH1	3.09	0.00204	3.41	0.00219	≤ 0.125
		DH3	3.24	0.00211	3.48	0.00223	≤ 0.125
		DH5	3.79	0.00239	3.62	0.00230	≤ 0.125
	2441	DH1	2.49	0.00177	2.82	0.00191	≤ 0.125
		DH3	2.54	0.00179	2.99	0.00199	≤ 0.125
		DH5	2.69	0.00186	3.08	0.00203	≤ 0.125
	2480	DH1	1.68	0.00147	2.13	0.00163	≤ 0.125
		DH3	1.70	0.00148	2.16	0.00164	≤ 0.125
		DH5	1.91	0.00155	2.38	0.00173	≤ 0.125
Mode 2	2402	2DH1	3.04	0.00201	3.52	0.00225	≤ 0.125
		2DH3	3.13	0.00206	3.68	0.00233	≤ 0.125
		2DH5	3.31	0.00214	3.81	0.00240	≤ 0.125
	2441	2DH1	2.59	0.00182	3.09	0.00204	≤ 0.125
		2DH3	2.69	0.00186	3.21	0.00209	≤ 0.125
		2DH5	2.92	0.00196	3.27	0.00212	≤ 0.125
	2480	2DH1	1.76	0.00150	2.29	0.00169	≤ 0.125
		2DH3	1.91	0.00155	2.51	0.00178	≤ 0.125
		2DH5	2.09	0.00162	2.61	0.00182	≤ 0.125
Mode 3	2402	3DH1	3.31	0.00214	3.79	0.00239	≤ 0.125
		3DH3	3.46	0.00222	3.96	0.00249	≤ 0.125
		3DH5	3.63	0.00231	4.18	0.00262	≤ 0.125
	2441	3DH1	2.61	0.00182	3.13	0.00206	≤ 0.125
		3DH3	2.71	0.00187	3.31	0.00214	≤ 0.125
		3DH5	2.92	0.00196	3.33	0.00215	≤ 0.125
	2480	3DH1	1.77	0.00150	2.32	0.00171	≤ 0.125
		3DH3	1.95	0.00157	2.58	0.00181	≤ 0.125
		3DH5	2.13	0.00163	2.78	0.00190	≤ 0.125

Note: The relevant measured result has the offset with cable loss already.



20 dB RF Bandwidth Measurement

Test Mode	Frequency (MHz)	Measurement Results (MHz)
Mode 1	2402	0.950
	2441	0.952
	2480	0.950
Mode 3	2402	1.313
	2441	1.312
	2480	1.314



■ Test Graphs

Mode 1: GFSK Continuous TX mode	
2402 MHz	<p>Agilent Spectrum Analyzer - Occupied BW</p> <p>Center Freq: 2.40200000 GHz Trig: Free Run #IF Gain: Low #Atten: 30 dB Avg Hold: 1/1 Radio Std: None Radio Device: BTS</p> <p>Ref Offset 0.8 dB Ref 20.00 dBm</p> <p>Center 2.402 GHz #Res BW 30 kHz #VBW 100 kHz Span 3 MHz Sweep 3.2 ms</p> <p>Occupied Bandwidth 843.13 kHz Total Power 11.0 dBm</p> <p>Transmit Freq Error 1.664 kHz OBW Power 99.00 % x dB Bandwidth 949.8 kHz x dB -20.00 dB</p> <p>File <BBB.png> saved</p>
2441 MHz	<p>Agilent Spectrum Analyzer - Occupied BW</p> <p>Center Freq: 2.441000000 GHz Trig: Free Run #IF Gain: Low #Atten: 30 dB Avg Hold: 1/1 Radio Std: None Radio Device: BTS</p> <p>Ref Offset 0.8 dB Ref 20.00 dBm</p> <p>Center 2.441 GHz #Res BW 30 kHz #VBW 100 kHz Span 3 MHz Sweep 3.2 ms</p> <p>Occupied Bandwidth 847.12 kHz Total Power 10.3 dBm</p> <p>Transmit Freq Error 2.637 kHz OBW Power 99.00 % x dB Bandwidth 952.2 kHz x dB -20.00 dB</p> <p>File <BBB.png> saved</p>
2480 MHz	<p>Agilent Spectrum Analyzer - Occupied BW</p> <p>Center Freq: 2.480000000 GHz Trig: Free Run #IF Gain: Low #Atten: 30 dB Avg Hold: 1/1 Radio Std: None Radio Device: BTS</p> <p>Ref Offset 0.8 dB Ref 20.00 dBm</p> <p>Center 2.48 GHz #Res BW 30 kHz #VBW 100 kHz Span 3 MHz Sweep 3.2 ms</p> <p>Occupied Bandwidth 844.36 kHz Total Power 9.44 dBm</p> <p>Transmit Freq Error 1.617 kHz OBW Power 99.00 % x dB Bandwidth 949.5 kHz x dB -20.00 dB</p> <p>File <BBB.png> saved</p>



Mode 3: 8DPSK Continuous TX mode	
2402 MHz	<p>Agilent Spectrum Analyzer - Occupied BW</p> <p>Center Freq: 2.40200000 GHz Trig: Free Run #Gain: Low #Atten: 30 dB AvgHold: 1/1 Radio Std: None Radio Device: BTS</p> <p>Ref Offset 0.8 dB Ref 20.00 dBm</p> <p>Center 2.402 GHz #Res BW 30 kHz #VBW 100 kHz Span 3 MHz Sweep 3.2 ms</p> <p>Occupied Bandwidth 1.1814 MHz Total Power 11.7 dBm</p> <p>Transmit Freq Error 4.031 kHz OBW Power 99.00 %</p> <p>x dB Bandwidth 1.313 MHz x dB -20.00 dB</p> <p>File <BBB.png> saved</p>
2441 MHz	<p>Agilent Spectrum Analyzer - Occupied BW</p> <p>Center Freq: 2.441000000 GHz Trig: Free Run #Gain: Low #Atten: 30 dB AvgHold: 1/1 Radio Std: None Radio Device: BTS</p> <p>Ref Offset 0.8 dB Ref 20.00 dBm</p> <p>Center 2.441 GHz #Res BW 30 kHz #VBW 100 kHz Span 3 MHz Sweep 3.2 ms</p> <p>Occupied Bandwidth 1.1819 MHz Total Power 10.9 dBm</p> <p>Transmit Freq Error 4.248 kHz OBW Power 99.00 %</p> <p>x dB Bandwidth 1.312 MHz x dB -20.00 dB</p> <p>File <BBB.png> saved</p>
2480 MHz	<p>Agilent Spectrum Analyzer - Occupied BW</p> <p>Center Freq: 2.480000000 GHz Trig: Free Run #Gain: Low #Atten: 30 dB AvgHold: 1/1 Radio Std: None Radio Device: BTS</p> <p>Ref Offset 0.8 dB Ref 20.00 dBm</p> <p>Center 2.48 GHz #Res BW 30 kHz #VBW 100 kHz Span 3 MHz Sweep 3.2 ms</p> <p>Occupied Bandwidth 1.1850 MHz Total Power 10.4 dBm</p> <p>Transmit Freq Error 4.876 kHz OBW Power 99.00 %</p> <p>x dB Bandwidth 1.314 MHz x dB -20.00 dB</p> <p>File <BBB.png> saved</p>



Carrier Frequency Separation Measurement

Test Mode	Frequency (MHz)	Measurement Results (MHz)	Limit (MHz)
Mode 1	2402	1.000	≥ 0.633
	2441	1.000	≥ 0.635
	2480	1.000	≥ 0.633
Mode 3	2402	1.000	≥ 0.875
	2441	1.000	≥ 0.875
	2480	1.000	≥ 0.876



■ Test Graphs

Mode 1: GFSK Continuous TX mode																																					
2402 MHz	<table border="1"> <thead> <tr> <th>MKR</th> <th>MODE</th> <th>TRC</th> <th>SCL</th> <th>X</th> <th>Y</th> <th>FUNCTION</th> <th>FUNCTION WIDTH</th> <th>FUNCTION VALUE</th> </tr> </thead> <tbody> <tr> <td>1</td> <td>N</td> <td>1</td> <td>f</td> <td>2.402 017 GHz</td> <td>1.458 dBm</td> <td></td> <td></td> <td></td> </tr> <tr> <td>2</td> <td>N</td> <td>1</td> <td>f</td> <td>2.403 017 GHz</td> <td>1.383 dBm</td> <td></td> <td></td> <td></td> </tr> <tr> <td>3</td> <td>N</td> <td>1</td> <td>f</td> <td>2.404 017 GHz</td> <td>1.527 dBm</td> <td></td> <td></td> <td></td> </tr> </tbody> </table>	MKR	MODE	TRC	SCL	X	Y	FUNCTION	FUNCTION WIDTH	FUNCTION VALUE	1	N	1	f	2.402 017 GHz	1.458 dBm				2	N	1	f	2.403 017 GHz	1.383 dBm				3	N	1	f	2.404 017 GHz	1.527 dBm			
MKR	MODE	TRC	SCL	X	Y	FUNCTION	FUNCTION WIDTH	FUNCTION VALUE																													
1	N	1	f	2.402 017 GHz	1.458 dBm																																
2	N	1	f	2.403 017 GHz	1.383 dBm																																
3	N	1	f	2.404 017 GHz	1.527 dBm																																
2441 MHz	<table border="1"> <thead> <tr> <th>MKR</th> <th>MODE</th> <th>TRC</th> <th>SCL</th> <th>X</th> <th>Y</th> <th>FUNCTION</th> <th>FUNCTION WIDTH</th> <th>FUNCTION VALUE</th> </tr> </thead> <tbody> <tr> <td>1</td> <td>N</td> <td>1</td> <td>f</td> <td>2.440 017 GHz</td> <td>0.678 dBm</td> <td></td> <td></td> <td></td> </tr> <tr> <td>2</td> <td>N</td> <td>1</td> <td>f</td> <td>2.441 017 GHz</td> <td>0.674 dBm</td> <td></td> <td></td> <td></td> </tr> <tr> <td>3</td> <td>N</td> <td>1</td> <td>f</td> <td>2.442 017 GHz</td> <td>0.726 dBm</td> <td></td> <td></td> <td></td> </tr> </tbody> </table>	MKR	MODE	TRC	SCL	X	Y	FUNCTION	FUNCTION WIDTH	FUNCTION VALUE	1	N	1	f	2.440 017 GHz	0.678 dBm				2	N	1	f	2.441 017 GHz	0.674 dBm				3	N	1	f	2.442 017 GHz	0.726 dBm			
MKR	MODE	TRC	SCL	X	Y	FUNCTION	FUNCTION WIDTH	FUNCTION VALUE																													
1	N	1	f	2.440 017 GHz	0.678 dBm																																
2	N	1	f	2.441 017 GHz	0.674 dBm																																
3	N	1	f	2.442 017 GHz	0.726 dBm																																
2480 MHz	<table border="1"> <thead> <tr> <th>MKR</th> <th>MODE</th> <th>TRC</th> <th>SCL</th> <th>X</th> <th>Y</th> <th>FUNCTION</th> <th>FUNCTION WIDTH</th> <th>FUNCTION VALUE</th> </tr> </thead> <tbody> <tr> <td>1</td> <td>N</td> <td>1</td> <td>f</td> <td>2.478 014 GHz</td> <td>0.096 dBm</td> <td></td> <td></td> <td></td> </tr> <tr> <td>2</td> <td>N</td> <td>1</td> <td>f</td> <td>2.479 014 GHz</td> <td>0.119 dBm</td> <td></td> <td></td> <td></td> </tr> <tr> <td>3</td> <td>N</td> <td>1</td> <td>f</td> <td>2.480 014 GHz</td> <td>0.197 dBm</td> <td></td> <td></td> <td></td> </tr> </tbody> </table>	MKR	MODE	TRC	SCL	X	Y	FUNCTION	FUNCTION WIDTH	FUNCTION VALUE	1	N	1	f	2.478 014 GHz	0.096 dBm				2	N	1	f	2.479 014 GHz	0.119 dBm				3	N	1	f	2.480 014 GHz	0.197 dBm			
MKR	MODE	TRC	SCL	X	Y	FUNCTION	FUNCTION WIDTH	FUNCTION VALUE																													
1	N	1	f	2.478 014 GHz	0.096 dBm																																
2	N	1	f	2.479 014 GHz	0.119 dBm																																
3	N	1	f	2.480 014 GHz	0.197 dBm																																



Mode 3: 8DPSK Continuous TX mode																																					
2402 MHz	<table border="1"> <thead> <tr> <th>MKR</th> <th>MODE</th> <th>TRIG</th> <th>SOL</th> <th>X</th> <th>Y</th> <th>FUNCTION</th> <th>FUNCTION WIDTH</th> <th>FUNCTION VALUE</th> </tr> </thead> <tbody> <tr> <td>1</td> <td>N</td> <td>1</td> <td>f</td> <td>2.402024 GHz</td> <td>1.108 dBm</td> <td></td> <td></td> <td></td> </tr> <tr> <td>2</td> <td>N</td> <td>1</td> <td>f</td> <td>2.403024 GHz</td> <td>1.220 dBm</td> <td></td> <td></td> <td></td> </tr> <tr> <td>3</td> <td>N</td> <td>1</td> <td>f</td> <td>2.404024 GHz</td> <td>1.026 dBm</td> <td></td> <td></td> <td></td> </tr> </tbody> </table>	MKR	MODE	TRIG	SOL	X	Y	FUNCTION	FUNCTION WIDTH	FUNCTION VALUE	1	N	1	f	2.402024 GHz	1.108 dBm				2	N	1	f	2.403024 GHz	1.220 dBm				3	N	1	f	2.404024 GHz	1.026 dBm			
MKR	MODE	TRIG	SOL	X	Y	FUNCTION	FUNCTION WIDTH	FUNCTION VALUE																													
1	N	1	f	2.402024 GHz	1.108 dBm																																
2	N	1	f	2.403024 GHz	1.220 dBm																																
3	N	1	f	2.404024 GHz	1.026 dBm																																
2441 MHz	<table border="1"> <thead> <tr> <th>MKR</th> <th>MODE</th> <th>TRIG</th> <th>SOL</th> <th>X</th> <th>Y</th> <th>FUNCTION</th> <th>FUNCTION WIDTH</th> <th>FUNCTION VALUE</th> </tr> </thead> <tbody> <tr> <td>1</td> <td>N</td> <td>1</td> <td>f</td> <td>2.440021 GHz</td> <td>0.342 dBm</td> <td></td> <td></td> <td></td> </tr> <tr> <td>2</td> <td>N</td> <td>1</td> <td>f</td> <td>2.441021 GHz</td> <td>0.384 dBm</td> <td></td> <td></td> <td></td> </tr> <tr> <td>3</td> <td>N</td> <td>1</td> <td>f</td> <td>2.442021 GHz</td> <td>0.336 dBm</td> <td></td> <td></td> <td></td> </tr> </tbody> </table>	MKR	MODE	TRIG	SOL	X	Y	FUNCTION	FUNCTION WIDTH	FUNCTION VALUE	1	N	1	f	2.440021 GHz	0.342 dBm				2	N	1	f	2.441021 GHz	0.384 dBm				3	N	1	f	2.442021 GHz	0.336 dBm			
MKR	MODE	TRIG	SOL	X	Y	FUNCTION	FUNCTION WIDTH	FUNCTION VALUE																													
1	N	1	f	2.440021 GHz	0.342 dBm																																
2	N	1	f	2.441021 GHz	0.384 dBm																																
3	N	1	f	2.442021 GHz	0.336 dBm																																
2480 MHz	<table border="1"> <thead> <tr> <th>MKR</th> <th>MODE</th> <th>TRIG</th> <th>SOL</th> <th>X</th> <th>Y</th> <th>FUNCTION</th> <th>FUNCTION WIDTH</th> <th>FUNCTION VALUE</th> </tr> </thead> <tbody> <tr> <td>1</td> <td>N</td> <td>1</td> <td>f</td> <td>2.478022 GHz</td> <td>-0.035 dBm</td> <td></td> <td></td> <td></td> </tr> <tr> <td>2</td> <td>N</td> <td>1</td> <td>f</td> <td>2.479022 GHz</td> <td>-0.119 dBm</td> <td></td> <td></td> <td></td> </tr> <tr> <td>3</td> <td>N</td> <td>1</td> <td>f</td> <td>2.480022 GHz</td> <td>-0.239 dBm</td> <td></td> <td></td> <td></td> </tr> </tbody> </table>	MKR	MODE	TRIG	SOL	X	Y	FUNCTION	FUNCTION WIDTH	FUNCTION VALUE	1	N	1	f	2.478022 GHz	-0.035 dBm				2	N	1	f	2.479022 GHz	-0.119 dBm				3	N	1	f	2.480022 GHz	-0.239 dBm			
MKR	MODE	TRIG	SOL	X	Y	FUNCTION	FUNCTION WIDTH	FUNCTION VALUE																													
1	N	1	f	2.478022 GHz	-0.035 dBm																																
2	N	1	f	2.479022 GHz	-0.119 dBm																																
3	N	1	f	2.480022 GHz	-0.239 dBm																																



Number of Hopping Measurement

Test Mode	Frequency Range (MHz)	Measurement Results (Channel Numbers)	Limit (ch)
Mode 1	2402 - 2480	79	≥ 15
Mode 3	2402 - 2480	79	≥ 15

■ Test Graphs

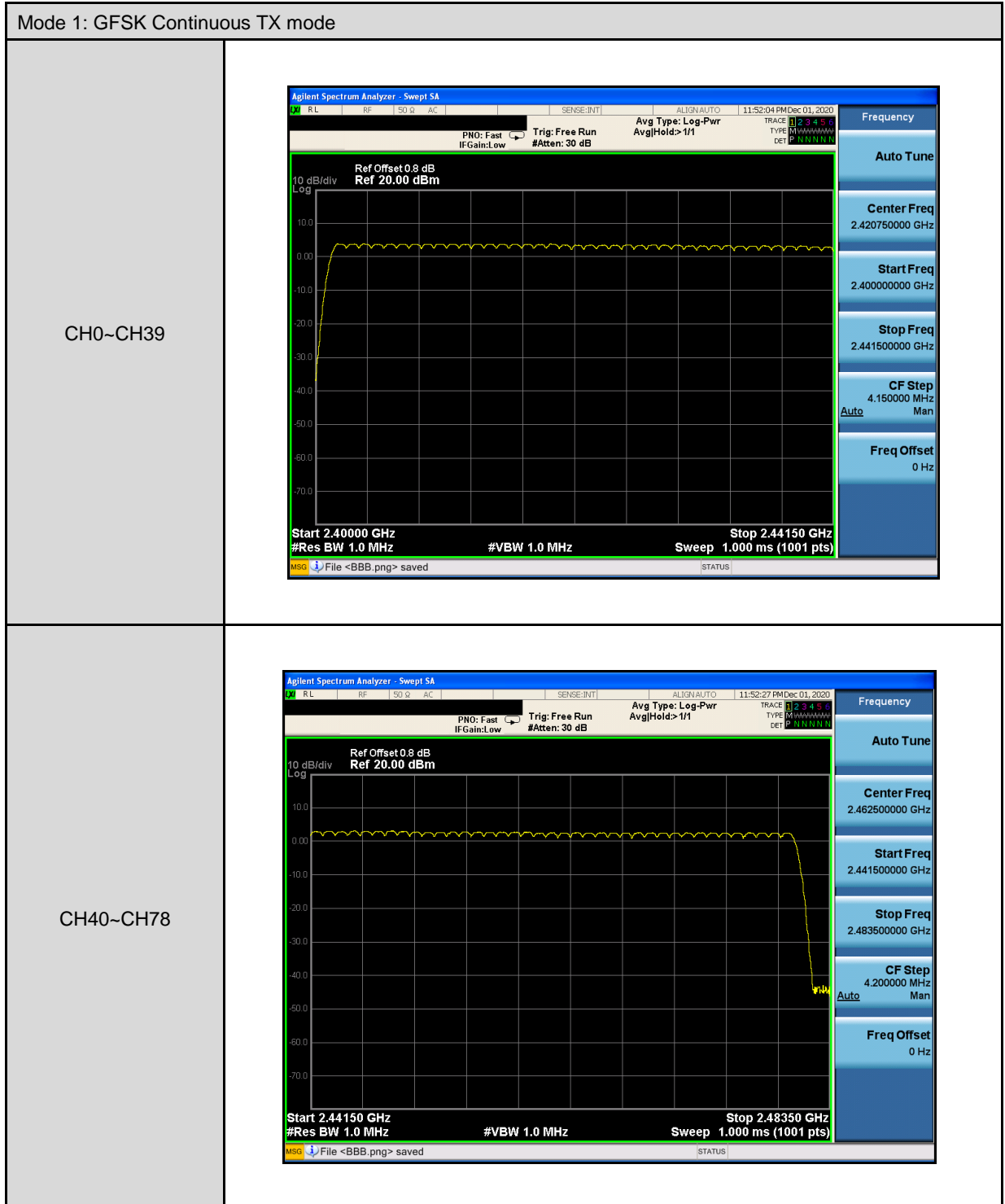

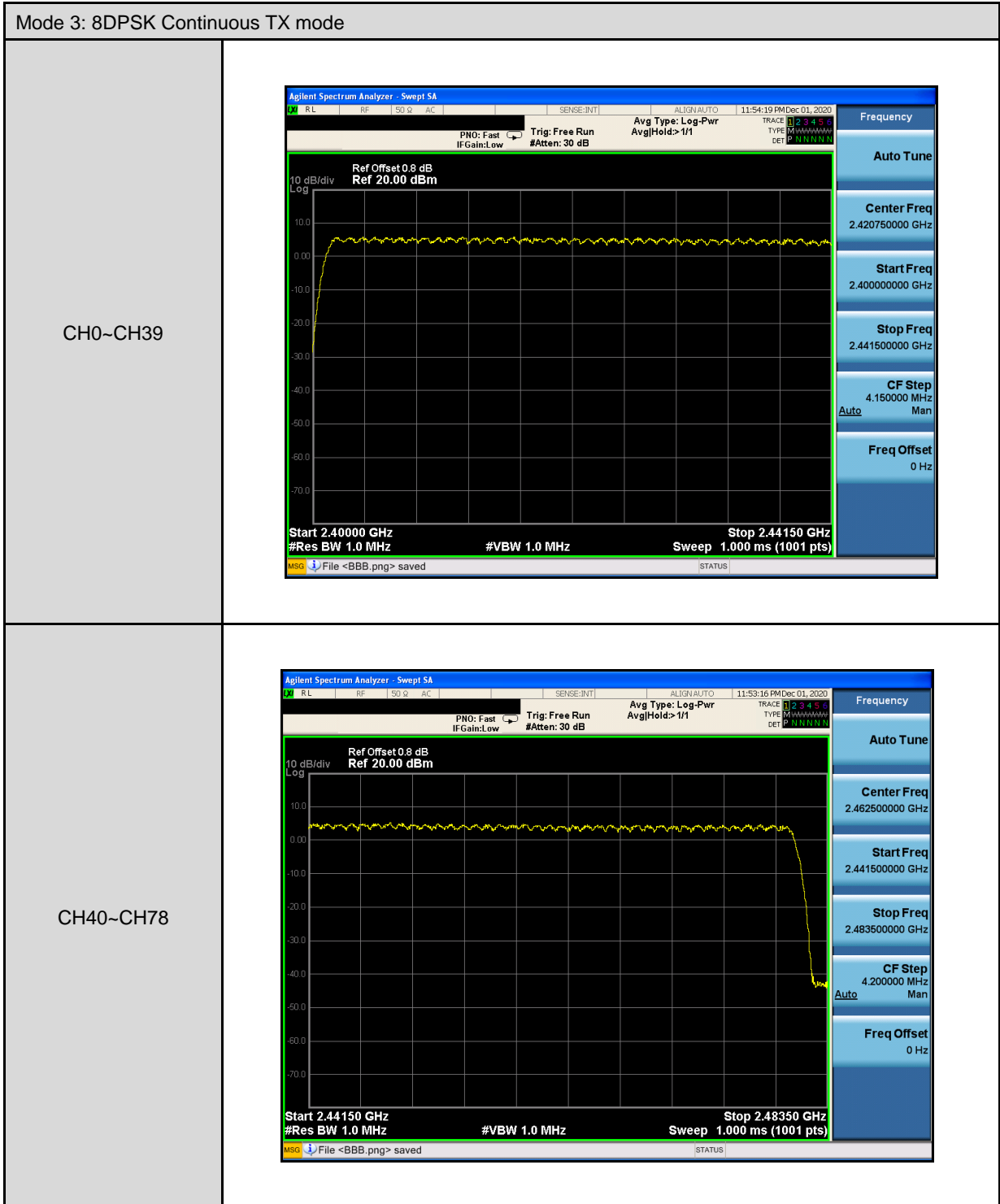



Time of Occupancy (Dwell Time) Measurement

Mode 1: GFSK Continuous TX mode	
DH1	
Cycle Calculate	$79CH * 0.4 = 31.6 \text{ (sec)}$
The EUT Hopping Number per Sec	1600 times/sec
Each Channel Dwell Times per Sec	$800/79CH = 10.13(\text{times/sec})$
Each Channel Dwell Times on Cycle(1)	$31.6 * 10.13 = 320.108(\text{times})$
Each Channel Dwell Times (2)	0.400 ms (sec)
Dwell Times on Cycle (1) * (2)	128.043 ms (sec)
LIMIT(msec)	$< = 400$
DH3	
Cycle Calculate	$79CH * 0.4 = 31.6 \text{ (sec)}$
The EUT Hopping Number per Sec	1600 times/sec
Each Channel Dwell Times per Sec	$400/79CH = 5.1(\text{times/sec})$
Each Channel Dwell Times on Cycle(1)	$31.6 * 5.1 = 161.16(\text{times})$
Each Channel Dwell Times (2)	1.660 ms (sec)
Dwell Times on Cycle (1) * (2)	265.427 ms (sec)
LIMIT(msec)	$< = 400$
DH5	
Cycle Calculate	$79CH * 0.4 = 31.6 \text{ (sec)}$
The EUT Hopping Number per Sec	1600 times/sec
Each Channel Dwell Times per Sec	$266.7/79CH = 3.37(\text{times/sec})$
Each Channel Dwell Times on Cycle(1)	$31.6 * 3.37 = 106.492(\text{times})$
Each Channel Dwell Times (2)	2.900 ms (sec)
Dwell Times on Cycle (1) * (2)	309.743 ms (sec)
LIMIT(msec)	$< = 400$



Mode 3: 8DPSK Continuous TX mode	
3DH1	
Cycle Calculate	$79CH * 0.4 = 31.6 \text{ (sec)}$
The EUT Hopping Number per Sec	1600 times/sec
Each Channel Dwell Times per Sec	$800/79CH = 10.13(\text{times/sec})$
Each Channel Dwell Times on Cycle(1)	$31.6 * 10.13 = 320.108(\text{times})$
Each Channel Dwell Times (2)	0.430 ms (sec)
Dwell Times on Cycle (1) * (2)	137.646 ms (sec)
LIMIT(msec)	$< = 400$
3DH3	
Cycle Calculate	$79CH * 0.4 = 31.6 \text{ (sec)}$
The EUT Hopping Number per Sec	1600 times/sec
Each Channel Dwell Times per Sec	$400/79CH = 5.1(\text{times/sec})$
Each Channel Dwell Times on Cycle(1)	$31.6 * 5.1 = 161.16(\text{times})$
Each Channel Dwell Times (2)	1.670 ms (sec)
Dwell Times on Cycle (1) * (2)	267.026 ms (sec)
LIMIT(msec)	$< = 400$
3DH5	
Cycle Calculate	$79CH * 0.4 = 31.6 \text{ (sec)}$
The EUT Hopping Number per Sec	1600 times/sec
Each Channel Dwell Times per Sec	$266.7/79CH = 3.37(\text{times/sec})$
Each Channel Dwell Times on Cycle(1)	$31.6 * 3.37 = 106.492(\text{times})$
Each Channel Dwell Times (2)	2.930 ms (sec)
Dwell Times on Cycle (1) * (2)	312.947 ms (sec)
LIMIT(msec)	$< = 400$



■ Test Graphs

Mode 1: GFSK Continuous TX mode	
DH1	
DH3	
DH5	



Mode 3: 8DPSK Continuous TX mode	
3DH1	<p>Agilent Spectrum Analyzer - Swept SA PRO: Fast Trig: Free Run Avg Type: Log-Pwr IF Gain: Low #Atten: 30 dB Ref Offset 0.8 dB Ref 20.00 dBm ΔMkr1 430.0 μs 1.53 dB Center 2.40200000 GHz Res BW 1.0 MHz #VBW 1.0 MHz Sweep 10.00 ms (1001 pts) Span 0 Hz File <BBB.png> saved</p>
3DH3	<p>Agilent Spectrum Analyzer - Swept SA PRO: Fast Trig: Free Run Avg Type: Log-Pwr IF Gain: Low #Atten: 30 dB Ref Offset 0.8 dB Ref 20.00 dBm ΔMkr1 1.670 ms -1.54 dB Center 2.40200000 GHz Res BW 1.0 MHz #VBW 1.0 MHz Sweep 10.00 ms (1001 pts) Span 0 Hz File <BBB.png> saved</p>
3DH5	<p>Agilent Spectrum Analyzer - Swept SA PRO: Fast Trig: Free Run Avg Type: Log-Pwr IF Gain: Low #Atten: 30 dB Ref Offset 0.8 dB Ref 20.00 dBm ΔMkr1 2.930 ms 1.97 dB Center 2.40200000 GHz Res BW 1.0 MHz #VBW 1.0 MHz Sweep 10.00 ms (1001 pts) Span 0 Hz File <BBB.png> saved</p>



Out of Band Conducted Emissions Measurement

Test Graphs

Mode 1: GFSK Continuous TX mode																																														
2402 MHz	<table border="1"> <thead> <tr> <th>MKR</th> <th>MODE</th> <th>TRC</th> <th>SCL</th> <th>X</th> <th>Y</th> <th>FUNCTION</th> <th>FUNCTION WIDTH</th> <th>FUNCTION VALUE</th> </tr> </thead> <tbody> <tr> <td>1</td> <td>N</td> <td>1</td> <td>f</td> <td>2.402 0 GHz</td> <td>2.937 dBm</td> <td></td> <td></td> <td></td> </tr> <tr> <td>2</td> <td>N</td> <td>1</td> <td>f</td> <td>300.9 MHz</td> <td>-42.495 dBm</td> <td></td> <td></td> <td></td> </tr> <tr> <td>3</td> <td>N</td> <td>1</td> <td>f</td> <td>3702.4 GHz</td> <td>-47.412 dBm</td> <td></td> <td></td> <td></td> </tr> <tr> <td>4</td> <td>N</td> <td>1</td> <td>f</td> <td>26.780 7 GHz</td> <td>-47.684 dBm</td> <td></td> <td></td> <td></td> </tr> </tbody> </table>	MKR	MODE	TRC	SCL	X	Y	FUNCTION	FUNCTION WIDTH	FUNCTION VALUE	1	N	1	f	2.402 0 GHz	2.937 dBm				2	N	1	f	300.9 MHz	-42.495 dBm				3	N	1	f	3702.4 GHz	-47.412 dBm				4	N	1	f	26.780 7 GHz	-47.684 dBm			
MKR	MODE	TRC	SCL	X	Y	FUNCTION	FUNCTION WIDTH	FUNCTION VALUE																																						
1	N	1	f	2.402 0 GHz	2.937 dBm																																									
2	N	1	f	300.9 MHz	-42.495 dBm																																									
3	N	1	f	3702.4 GHz	-47.412 dBm																																									
4	N	1	f	26.780 7 GHz	-47.684 dBm																																									
2441 MHz	<table border="1"> <thead> <tr> <th>MKR</th> <th>MODE</th> <th>TRC</th> <th>SCL</th> <th>X</th> <th>Y</th> <th>FUNCTION</th> <th>FUNCTION WIDTH</th> <th>FUNCTION VALUE</th> </tr> </thead> <tbody> <tr> <td>1</td> <td>N</td> <td>1</td> <td>f</td> <td>2.441 0 GHz</td> <td>2.711 dBm</td> <td></td> <td></td> <td></td> </tr> <tr> <td>2</td> <td>N</td> <td>1</td> <td>f</td> <td>813.5 MHz</td> <td>-42.556 dBm</td> <td></td> <td></td> <td></td> </tr> <tr> <td>3</td> <td>N</td> <td>1</td> <td>f</td> <td>3254.7 GHz</td> <td>-44.850 dBm</td> <td></td> <td></td> <td></td> </tr> <tr> <td>4</td> <td>N</td> <td>1</td> <td>f</td> <td>26.727 7 GHz</td> <td>-47.932 dBm</td> <td></td> <td></td> <td></td> </tr> </tbody> </table>	MKR	MODE	TRC	SCL	X	Y	FUNCTION	FUNCTION WIDTH	FUNCTION VALUE	1	N	1	f	2.441 0 GHz	2.711 dBm				2	N	1	f	813.5 MHz	-42.556 dBm				3	N	1	f	3254.7 GHz	-44.850 dBm				4	N	1	f	26.727 7 GHz	-47.932 dBm			
MKR	MODE	TRC	SCL	X	Y	FUNCTION	FUNCTION WIDTH	FUNCTION VALUE																																						
1	N	1	f	2.441 0 GHz	2.711 dBm																																									
2	N	1	f	813.5 MHz	-42.556 dBm																																									
3	N	1	f	3254.7 GHz	-44.850 dBm																																									
4	N	1	f	26.727 7 GHz	-47.932 dBm																																									
2480 MHz	<table border="1"> <thead> <tr> <th>MKR</th> <th>MODE</th> <th>TRC</th> <th>SCL</th> <th>X</th> <th>Y</th> <th>FUNCTION</th> <th>FUNCTION WIDTH</th> <th>FUNCTION VALUE</th> </tr> </thead> <tbody> <tr> <td>1</td> <td>N</td> <td>1</td> <td>f</td> <td>2.480 0 GHz</td> <td>1.739 dBm</td> <td></td> <td></td> <td></td> </tr> <tr> <td>2</td> <td>N</td> <td>1</td> <td>f</td> <td>826.7 MHz</td> <td>-42.393 dBm</td> <td></td> <td></td> <td></td> </tr> <tr> <td>3</td> <td>N</td> <td>1</td> <td>f</td> <td>26.632 0 GHz</td> <td>-47.687 dBm</td> <td></td> <td></td> <td></td> </tr> </tbody> </table>	MKR	MODE	TRC	SCL	X	Y	FUNCTION	FUNCTION WIDTH	FUNCTION VALUE	1	N	1	f	2.480 0 GHz	1.739 dBm				2	N	1	f	826.7 MHz	-42.393 dBm				3	N	1	f	26.632 0 GHz	-47.687 dBm												
MKR	MODE	TRC	SCL	X	Y	FUNCTION	FUNCTION WIDTH	FUNCTION VALUE																																						
1	N	1	f	2.480 0 GHz	1.739 dBm																																									
2	N	1	f	826.7 MHz	-42.393 dBm																																									
3	N	1	f	26.632 0 GHz	-47.687 dBm																																									

Mode 3: 8DPSK Continuous TX mode																																														
2402 MHz	<p>Agilent Spectrum Analyzer - Swept SA</p> <p>Ref Offset: 0.8 dB Ref: 20.00 dBm</p> <p>Mkr1 2.402 0 GHz 0.813 dBm</p> <p>Start 30 MHz #Res BW 100 kHz #VBW 300 kHz Stop 26.50 GHz Sweep 2.531 s (40001 pts)</p> <table border="1"> <thead> <tr> <th>MKR</th> <th>MODE</th> <th>TRC</th> <th>SOL</th> <th>X</th> <th>Y</th> <th>FUNCTION</th> <th>FUNCTION WIDTH</th> <th>FUNCTION VALUE</th> </tr> </thead> <tbody> <tr> <td>1</td> <td>N</td> <td>1</td> <td>f</td> <td>2.402 0 GHz</td> <td>0.813 dBm</td> <td></td> <td></td> <td></td> </tr> <tr> <td>2</td> <td>N</td> <td>1</td> <td>f</td> <td>800.9 MHz</td> <td>-43.750 dBm</td> <td></td> <td></td> <td></td> </tr> <tr> <td>3</td> <td>N</td> <td>1</td> <td>f</td> <td>3.2924 GHz</td> <td>-50.739 dBm</td> <td></td> <td></td> <td></td> </tr> <tr> <td>4</td> <td>N</td> <td>1</td> <td>f</td> <td>26.6510 GHz</td> <td>-47.811 dBm</td> <td></td> <td></td> <td></td> </tr> </tbody> </table>	MKR	MODE	TRC	SOL	X	Y	FUNCTION	FUNCTION WIDTH	FUNCTION VALUE	1	N	1	f	2.402 0 GHz	0.813 dBm				2	N	1	f	800.9 MHz	-43.750 dBm				3	N	1	f	3.2924 GHz	-50.739 dBm				4	N	1	f	26.6510 GHz	-47.811 dBm			
MKR	MODE	TRC	SOL	X	Y	FUNCTION	FUNCTION WIDTH	FUNCTION VALUE																																						
1	N	1	f	2.402 0 GHz	0.813 dBm																																									
2	N	1	f	800.9 MHz	-43.750 dBm																																									
3	N	1	f	3.2924 GHz	-50.739 dBm																																									
4	N	1	f	26.6510 GHz	-47.811 dBm																																									
2441 MHz	<p>Agilent Spectrum Analyzer - Swept SA</p> <p>Ref Offset: 0.8 dB Ref: 20.00 dBm</p> <p>Mkr1 2.441 0 GHz 0.599 dBm</p> <p>Start 30 MHz #Res BW 100 kHz #VBW 300 kHz Stop 26.50 GHz Sweep 2.531 s (40001 pts)</p> <table border="1"> <thead> <tr> <th>MKR</th> <th>MODE</th> <th>TRC</th> <th>SOL</th> <th>X</th> <th>Y</th> <th>FUNCTION</th> <th>FUNCTION WIDTH</th> <th>FUNCTION VALUE</th> </tr> </thead> <tbody> <tr> <td>1</td> <td>N</td> <td>1</td> <td>f</td> <td>2.441 0 GHz</td> <td>0.599 dBm</td> <td></td> <td></td> <td></td> </tr> <tr> <td>2</td> <td>N</td> <td>1</td> <td>f</td> <td>813.5 MHz</td> <td>-44.620 dBm</td> <td></td> <td></td> <td></td> </tr> <tr> <td>3</td> <td>N</td> <td>1</td> <td>f</td> <td>3.2547 GHz</td> <td>-55.298 dBm</td> <td></td> <td></td> <td></td> </tr> <tr> <td>4</td> <td>N</td> <td>1</td> <td>f</td> <td>26.7231 GHz</td> <td>-48.014 dBm</td> <td></td> <td></td> <td></td> </tr> </tbody> </table>	MKR	MODE	TRC	SOL	X	Y	FUNCTION	FUNCTION WIDTH	FUNCTION VALUE	1	N	1	f	2.441 0 GHz	0.599 dBm				2	N	1	f	813.5 MHz	-44.620 dBm				3	N	1	f	3.2547 GHz	-55.298 dBm				4	N	1	f	26.7231 GHz	-48.014 dBm			
MKR	MODE	TRC	SOL	X	Y	FUNCTION	FUNCTION WIDTH	FUNCTION VALUE																																						
1	N	1	f	2.441 0 GHz	0.599 dBm																																									
2	N	1	f	813.5 MHz	-44.620 dBm																																									
3	N	1	f	3.2547 GHz	-55.298 dBm																																									
4	N	1	f	26.7231 GHz	-48.014 dBm																																									
2480 MHz	<p>Agilent Spectrum Analyzer - Swept SA</p> <p>Ref Offset: 0.8 dB Ref: 20.00 dBm</p> <p>Mkr1 2.480 0 GHz 0.251 dBm</p> <p>Start 30 MHz #Res BW 100 kHz #VBW 300 kHz Stop 26.50 GHz Sweep 2.531 s (40001 pts)</p> <table border="1"> <thead> <tr> <th>MKR</th> <th>MODE</th> <th>TRC</th> <th>SOL</th> <th>X</th> <th>Y</th> <th>FUNCTION</th> <th>FUNCTION WIDTH</th> <th>FUNCTION VALUE</th> </tr> </thead> <tbody> <tr> <td>1</td> <td>N</td> <td>1</td> <td>f</td> <td>2.480 0 GHz</td> <td>0.251 dBm</td> <td></td> <td></td> <td></td> </tr> <tr> <td>2</td> <td>N</td> <td>1</td> <td>f</td> <td>826.7 MHz</td> <td>-43.283 dBm</td> <td></td> <td></td> <td></td> </tr> <tr> <td>3</td> <td>N</td> <td>1</td> <td>f</td> <td>3.337 0 GHz</td> <td>-53.295 dBm</td> <td></td> <td></td> <td></td> </tr> <tr> <td>4</td> <td>N</td> <td>1</td> <td>f</td> <td>26.1539 GHz</td> <td>-48.040 dBm</td> <td></td> <td></td> <td></td> </tr> </tbody> </table>	MKR	MODE	TRC	SOL	X	Y	FUNCTION	FUNCTION WIDTH	FUNCTION VALUE	1	N	1	f	2.480 0 GHz	0.251 dBm				2	N	1	f	826.7 MHz	-43.283 dBm				3	N	1	f	3.337 0 GHz	-53.295 dBm				4	N	1	f	26.1539 GHz	-48.040 dBm			
MKR	MODE	TRC	SOL	X	Y	FUNCTION	FUNCTION WIDTH	FUNCTION VALUE																																						
1	N	1	f	2.480 0 GHz	0.251 dBm																																									
2	N	1	f	826.7 MHz	-43.283 dBm																																									
3	N	1	f	3.337 0 GHz	-53.295 dBm																																									
4	N	1	f	26.1539 GHz	-48.040 dBm																																									

Conducted Band Edge

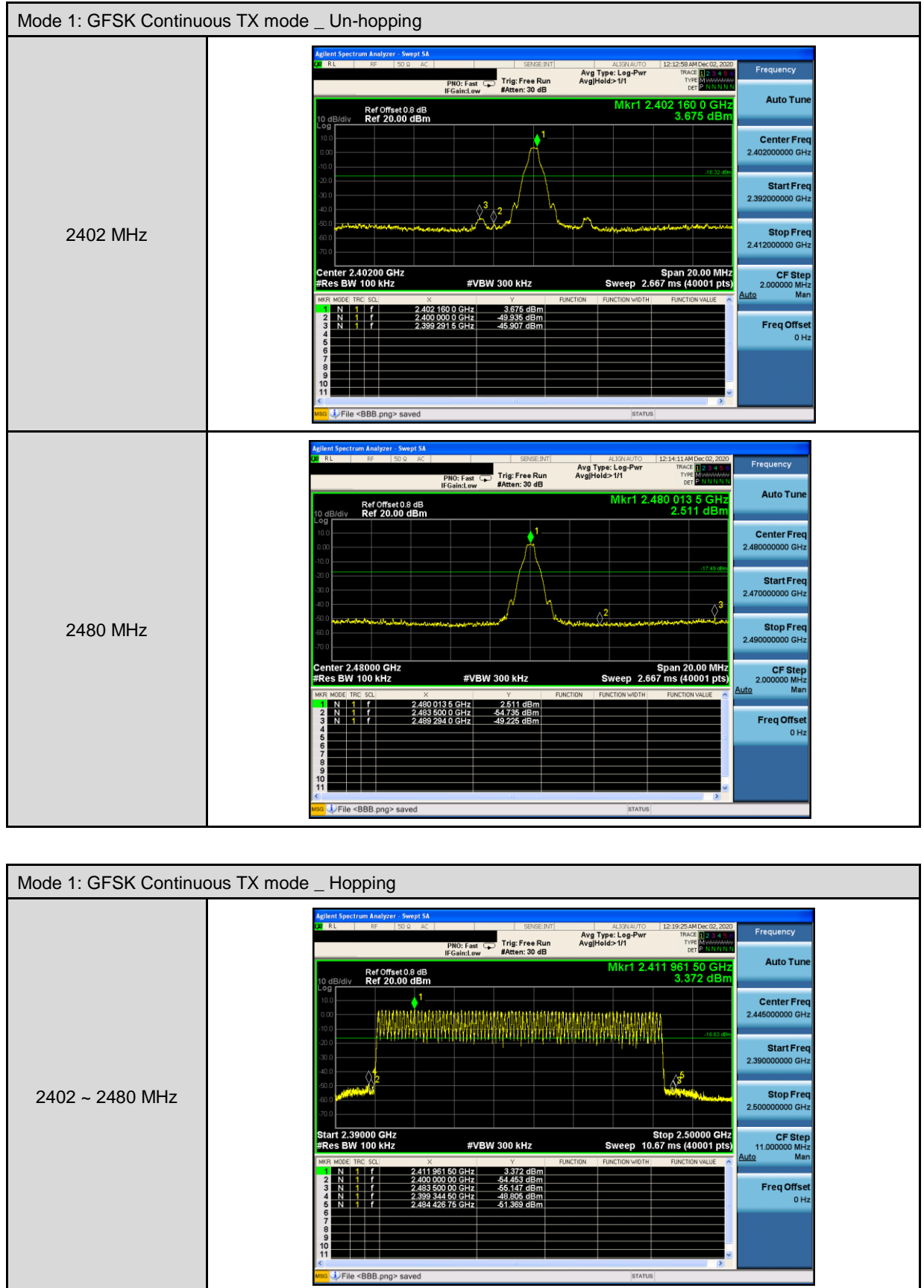



Mode 3: 8DPSK Continuous TX mode _ Un-hopping

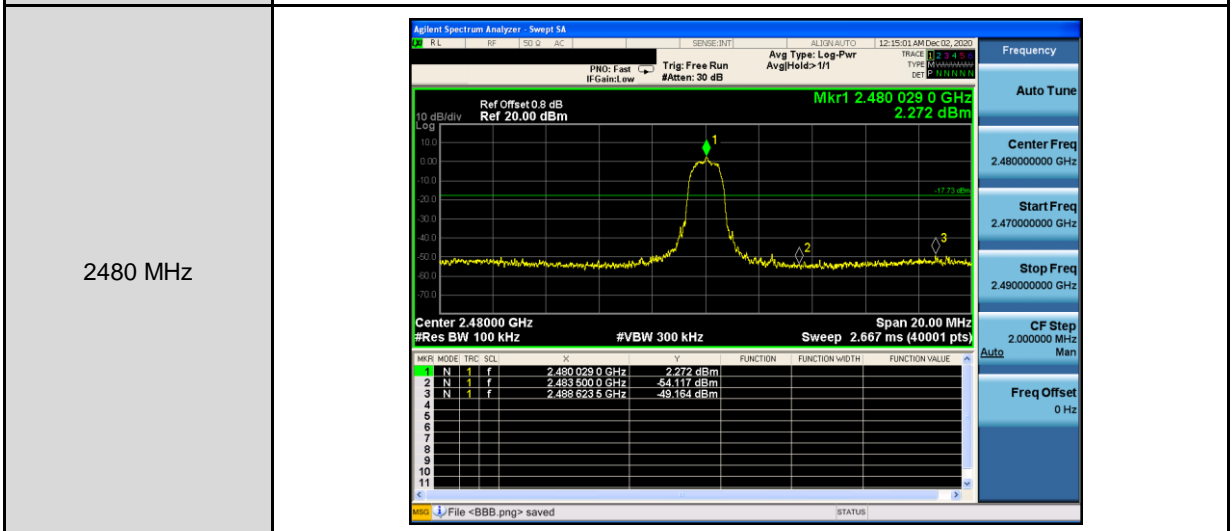
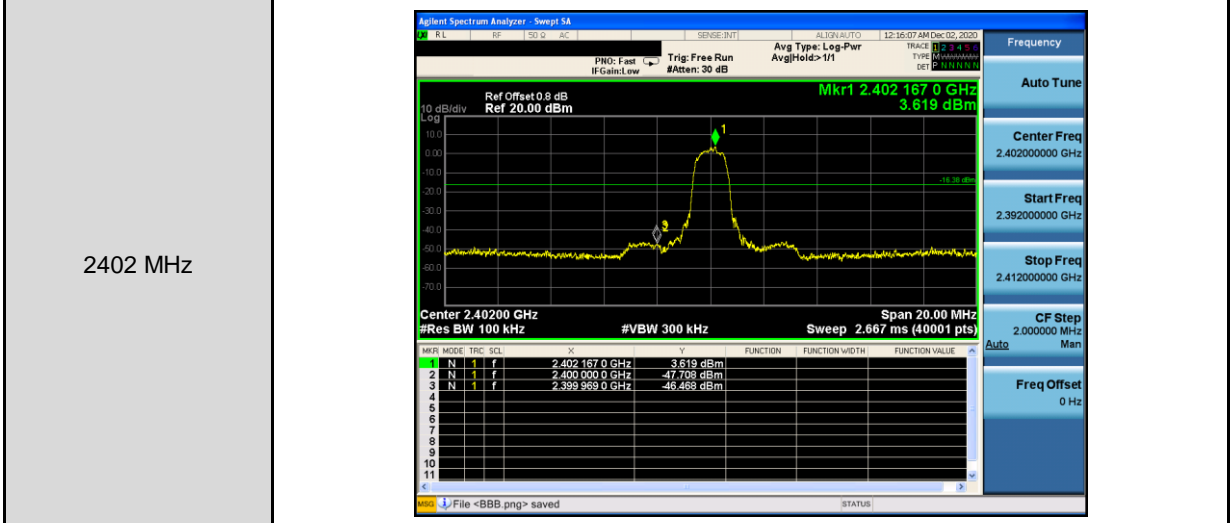

Mode 3: 8DPSK Continuous TX mode _ Un-hopping

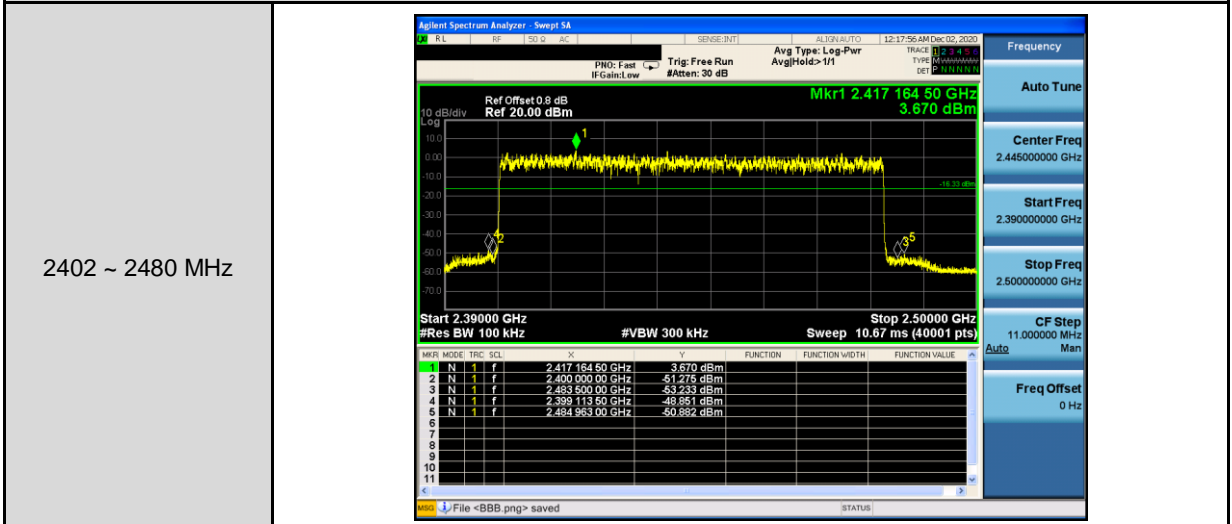

Annex B. Radiated Emission Measurement

Below 1 GHz

Standard:	FCC Part 15.247	Test Distance:	3 m
Test item:	Radiated Emission		
Frequency:	2402 MHz		
Mode:	Mode 3		
Ant.Polar.:	Horizontal		

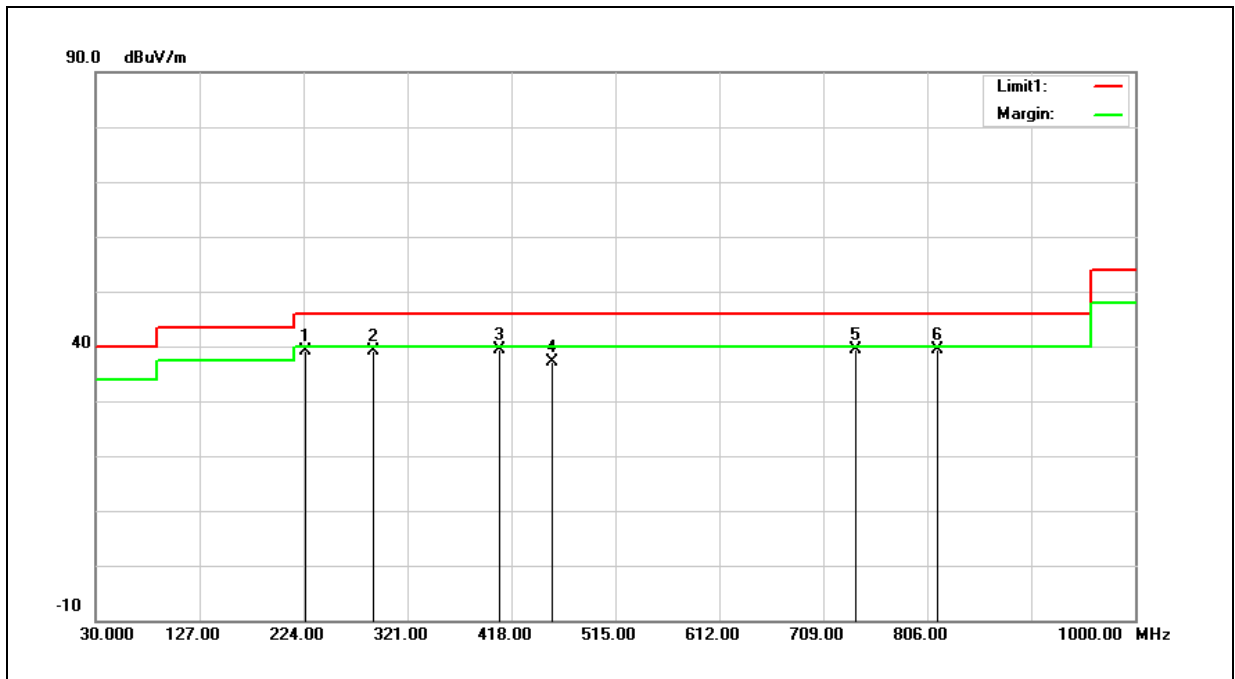

No.	Frequency (MHz)	Reading (dBuV)	Correct Factor (dB/m)	Result (dBuV/m)	Limit (dBuV/m)	Margin (dB)	Remark
1	225.9400	65.48	-26.29	39.19	46.00	-6.81	QP
2	288.9900	63.17	-23.93	39.24	46.00	-6.76	QP
3	406.3600	60.58	-21.18	39.40	46.00	-6.60	QP
4	455.8300	57.16	-20.11	37.05	46.00	-8.95	QP
5	739.0700	54.82	-15.40	39.42	46.00	-6.58	QP
6	815.7000	53.67	-14.33	39.34	46.00	-6.66	QP

Note:1.Result (dBuV/m) = Correct Factor (dB/m) + Reading(dBuV).

Example: $39.19 = -26.29 + 65.48$

2.Correction factor (dB/m) = Antenna Factor (dB/m) + Cable loss (dB) – Pre-Amplifier gain (dB).

3. When the peak results are less than average limit, so not need to evaluate the average.



Standard:	FCC Part 15.247	Test Distance:	3 m
Test item:	Radiated Emission		
Frequency:	2402 MHz		
Mode:	Mode 3		
Ant.Polar.:	Vertical		

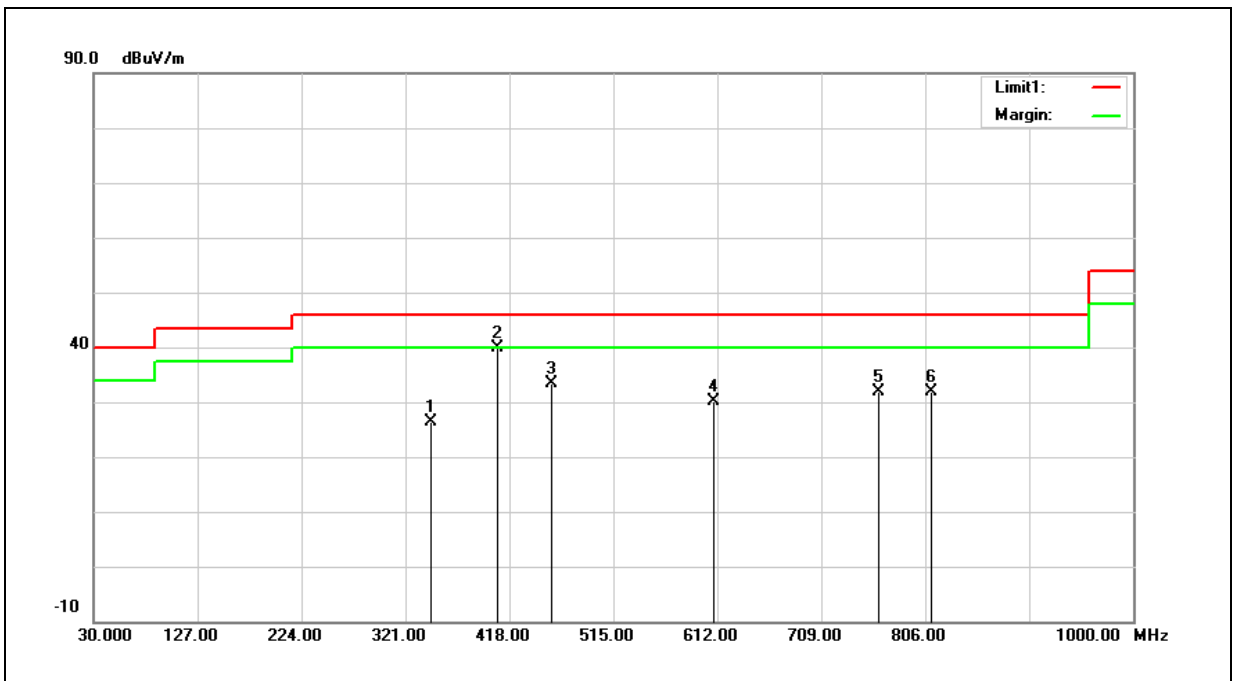

No.	Frequency (MHz)	Reading (dBuV)	Correct Factor (dB/m)	Result (dBuV/m)	Limit (dBuV/m)	Margin (dB)	Remark
1	344.2800	49.02	-22.60	26.42	46.00	-19.58	QP
2	407.3300	61.09	-21.15	39.94	46.00	-6.06	QP
3	456.8000	53.40	-20.10	33.30	46.00	-12.70	QP
4	608.1200	47.06	-17.04	30.02	46.00	-15.98	QP
5	762.3500	47.03	-15.05	31.98	46.00	-14.02	QP
6	811.8200	46.17	-14.37	31.80	46.00	-14.20	QP

Note:1.Result (dBuV/m) = Correct Factor (dB/m) + Reading(dBuV).

Example: 26.42 = -22.60 + 49.02

2.Correction factor (dB/m) = Antenna Factor (dB/m) + Cable loss (dB) – Pre-Amplifier gain (dB).

3. When the peak results are less than average limit, so not need to evaluate the average.

Harmonic

Above 1 GHz

Standard:	FCC Part 15.247	Test Distance:	3 m
Test item:	Harmonic		
Frequency:	2402 MHz		
Mode:	Mode 1		
Ant.Polar.:	Horizontal		

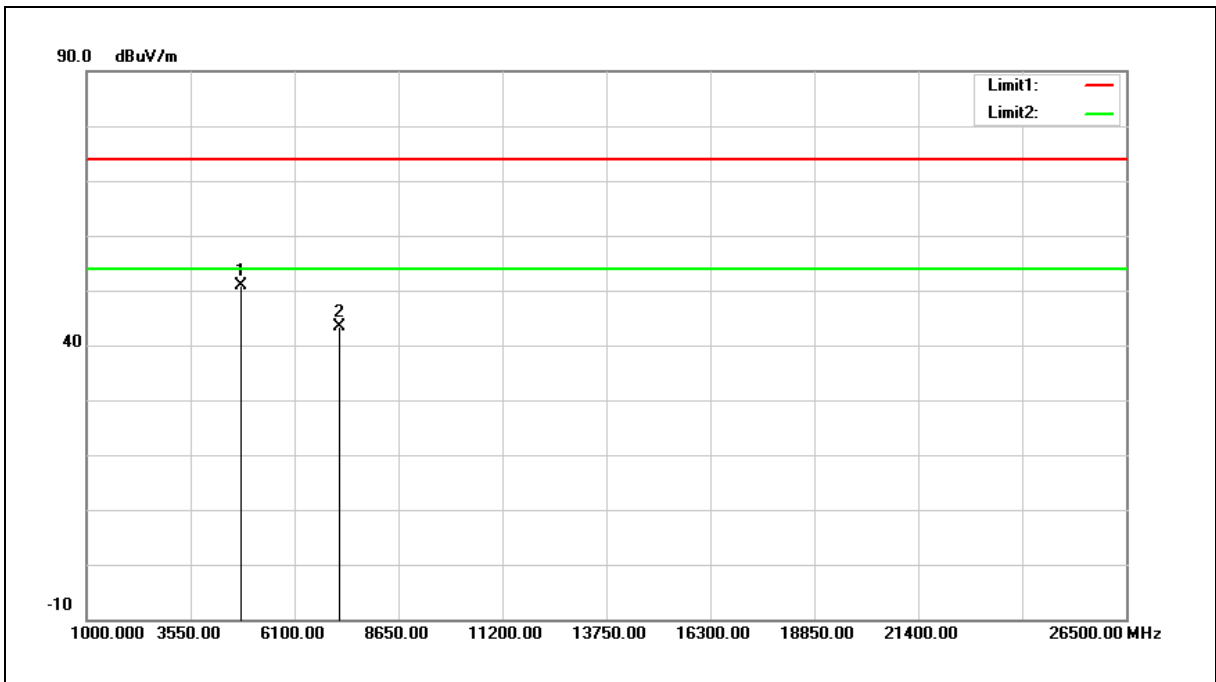

No.	Frequency (MHz)	Reading (dBuV)	Correct Factor (dB/m)	Result (dBuV/m)	Limit (dBuV/m)	Margin (dB)	Remark
1	4804.000	52.28	-1.30	50.98	74.00	-23.02	peak
2	7206.000	37.58	5.74	43.32	74.00	-30.68	peak

Note: 1. Result (dBuV/m) = Correct Factor (dB/m) + Reading (dBuV).

Example: $50.98 = -1.30 + 52.28$

2. Correction factor (dB/m) = Antenna Factor (dB/m) + Cable loss (dB) – Pre-Amplifier gain (dB).

3. When the peak results are less than average limit, so not need to evaluate the average.



Standard:	FCC Part 15.247	Test Distance:	3 m
Test item:	Harmonic		
Frequency:	2402 MHz		
Mode:	Mode 1		
Ant.Polar.:	Vertical		

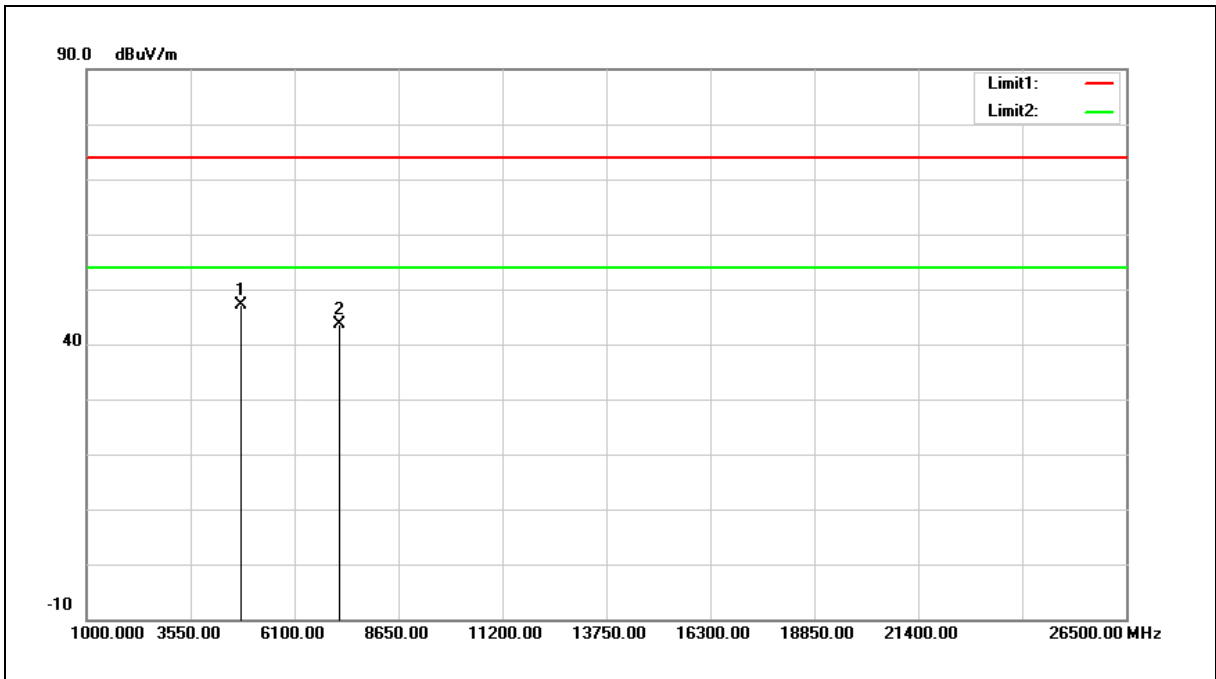

No.	Frequency (MHz)	Reading (dBuV)	Correct Factor (dB/m)	Result (dBuV/m)	Limit (dBuV/m)	Margin (dB)	Remark
1	4804.000	48.50	-1.30	47.20	74.00	-26.80	peak
2	7206.000	37.80	5.74	43.54	74.00	-30.46	peak

Note: 1. Result (dBuV/m) = Correct Factor (dB/m) + Reading (dBuV).

Example: $47.20 = -1.30 + 48.50$

2. Correction factor (dB/m) = Antenna Factor (dB/m) + Cable loss (dB) – Pre-Amplifier gain (dB).

3. When the peak results are less than average limit, so not need to evaluate the average.



Standard:	FCC Part 15.247	Test Distance:	3 m
Test item:	Harmonic		
Frequency:	2441 MHz		
Mode:	Mode 1		
Ant.Polar.:	Horizontal		

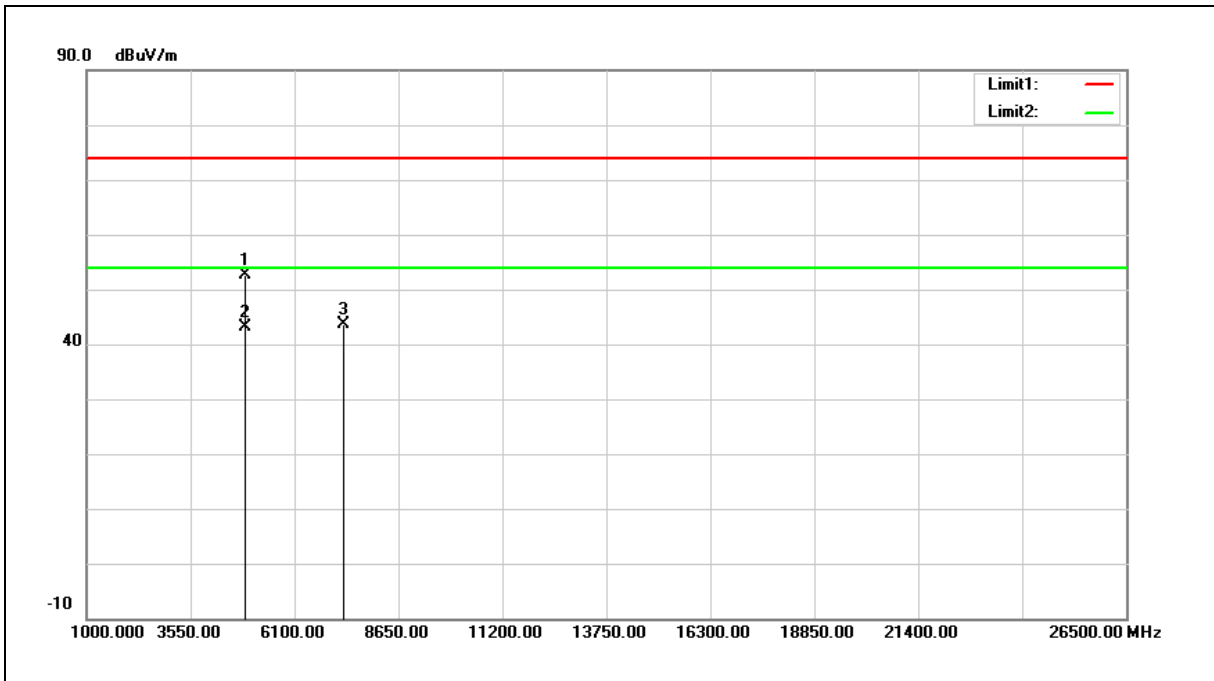

No.	Frequency (MHz)	Reading (dBuV)	Correct Factor (dB/m)	Result (dBuV/m)	Limit (dBuV/m)	Margin (dB)	Remark
1	4882.000	53.70	-1.10	52.60	74.00	-21.40	peak
2	4882.000	44.15	-1.10	43.05	54.00	-10.95	AVG
3	7323.000	37.56	6.15	43.71	74.00	-30.29	peak

Note:1.Result (dBuV/m) = Correct Factor (dB/m) + Reading(dBuV).

2.Correction factor (dB/m) = Antenna Factor (dB/m) + Cable loss (dB) – Pre-Amplifier gain (dB).

3.When the peak results are less than average limit, so not need to evaluate the average.



Standard:	FCC Part 15.247	Test Distance:	3 m
Test item:	Harmonic		
Frequency:	2441 MHz		
Mode:	Mode 1		
Ant.Polar.:	Vertical		

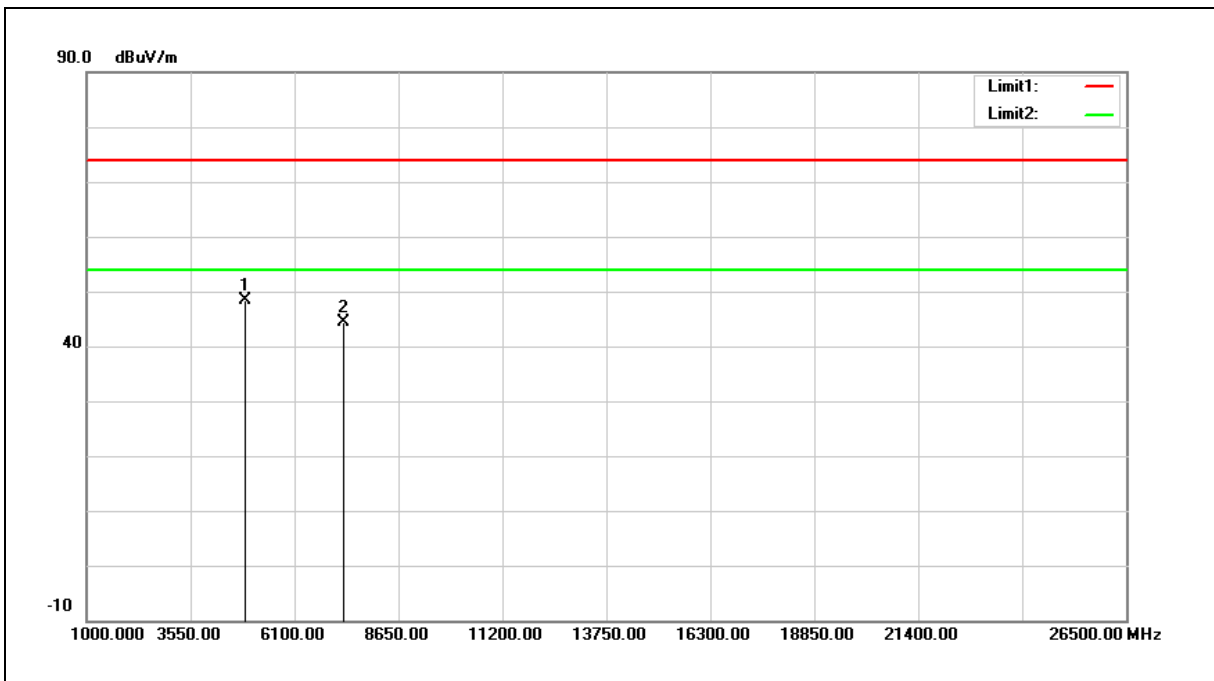

No.	Frequency (MHz)	Reading (dBuV)	Correct Factor (dB/m)	Result (dBuV/m)	Limit (dBuV/m)	Margin (dB)	Remark
1	4882.000	49.53	-1.10	48.43	74.00	-25.57	peak
2	7323.000	38.29	6.15	44.44	74.00	-29.56	peak

- Note:1.Result (dBuV/m) = Correct Factor (dB/m) + Reading(dBuV).
 2.Correction factor (dB/m) = Antenna Factor (dB/m) + Cable loss (dB) – Pre-Amplifier gain (dB).
 3.When the peak results are less than average limit, so not need to evaluate the average.



Standard:	FCC Part 15.247	Test Distance:	3 m
Test item:	Harmonic		
Frequency:	2480 MHz		
Mode:	Mode 1		
Ant.Polar.:	Horizontal		

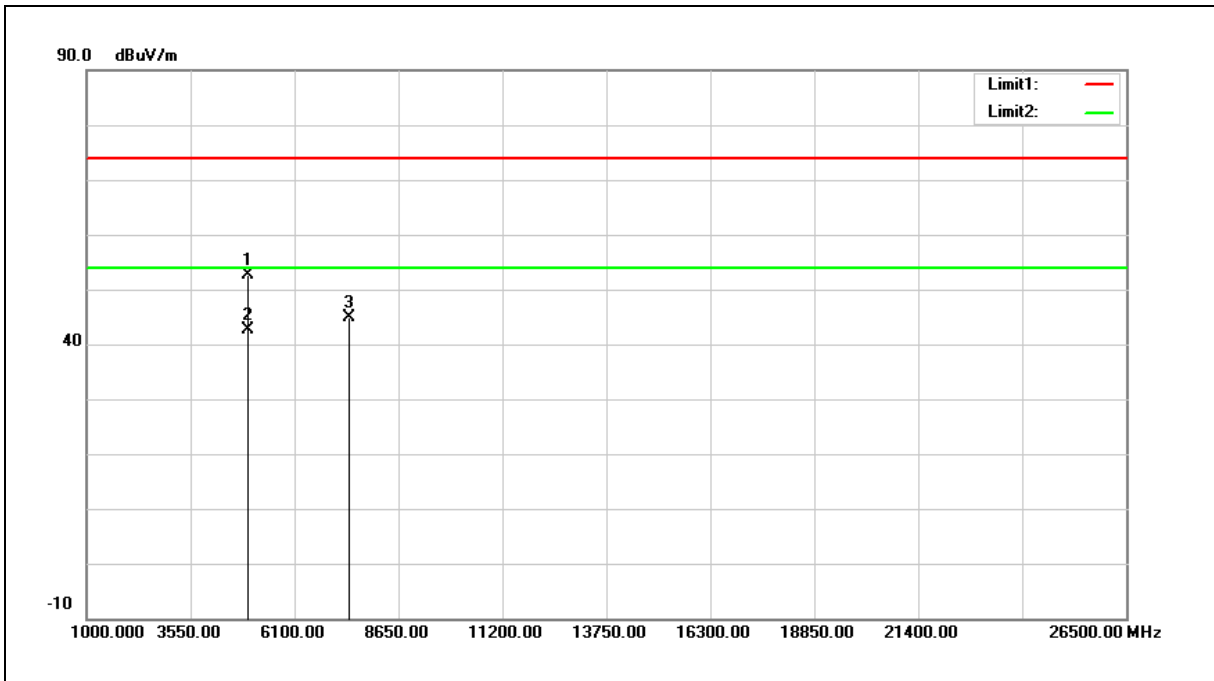

No.	Frequency (MHz)	Reading (dBuV)	Correct Factor (dB/m)	Result (dBuV/m)	Limit (dBuV/m)	Margin (dB)	Remark
1	4960.000	53.48	-0.88	52.60	74.00	-21.40	peak
2	4960.000	43.47	-0.88	42.59	54.00	-11.41	AVG
3	7440.000	38.22	6.56	44.78	74.00	-29.22	peak

Note:1.Result (dBuV/m) = Correct Factor (dB/m) + Reading(dBuV).

2.Correction factor (dB/m) = Antenna Factor (dB/m) + Cable loss (dB) – Pre-Amplifier gain (dB).

3.When the peak results are less than average limit, so not need to evaluate the average.



Standard:	FCC Part 15.247	Test Distance:	3 m
Test item:	Harmonic		
Frequency:	2480 MHz		
Mode:	Mode 1		
Ant.Polar.:	Vertical		

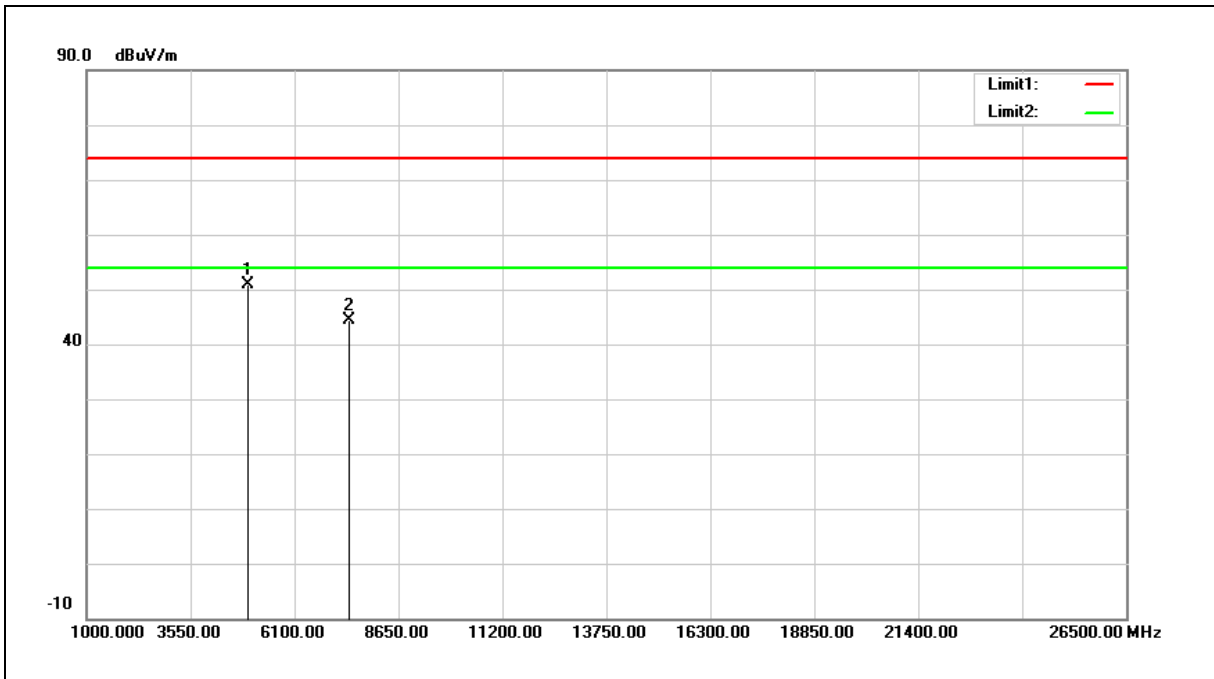

No.	Frequency (MHz)	Reading (dBuV)	Correct Factor (dB/m)	Result (dBuV/m)	Limit (dBuV/m)	Margin (dB)	Remark
1	4960.000	51.80	-0.88	50.92	74.00	-23.08	peak
2	7440.000	37.71	6.56	44.27	74.00	-29.73	peak

- Note:1.Result (dBuV/m) = Correct Factor (dB/m) + Reading(dBuV).
 2.Correction factor (dB/m) = Antenna Factor (dB/m) + Cable loss (dB) – Pre-Amplifier gain (dB).
 3.When the peak results are less than average limit, so not need to evaluate the average.

Standard:	FCC Part 15.247	Test Distance:	3 m
Test item:	Harmonic		
Frequency:	2402 MHz		
Mode:	Mode 3		
Ant.Polar.:	Horizontal		

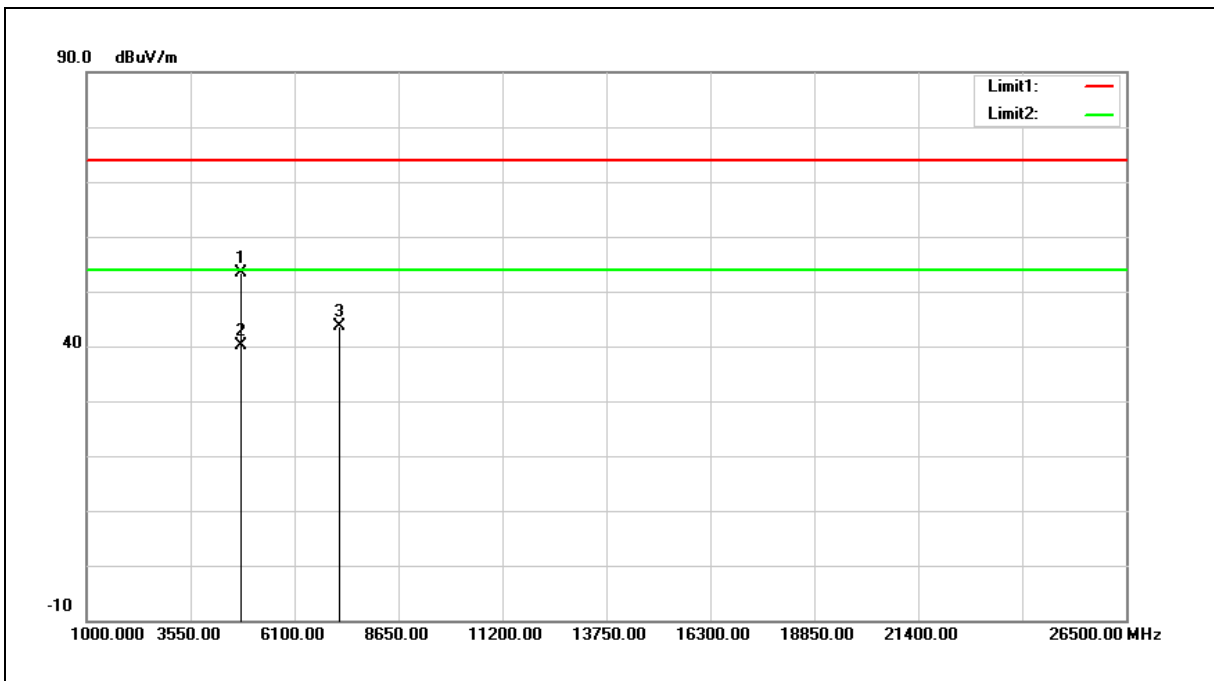

No.	Frequency (MHz)	Reading (dBuV)	Correct Factor (dB/m)	Result (dBuV/m)	Limit (dBuV/m)	Margin (dB)	Remark
1	4804.000	54.57	-1.30	53.27	74.00	-20.73	peak
2	4804.000	41.54	-1.30	40.24	54.00	-13.76	AVG
3	7206.000	37.88	5.74	43.62	74.00	-30.38	peak

Note:1.Result (dBuV/m) = Correct Factor (dB/m) + Reading(dBuV).

2.Correction factor (dB/m) = Antenna Factor (dB/m) + Cable loss (dB) – Pre-Amplifier gain (dB).

3.When the peak results are less than average limit, so not need to evaluate the average.



Standard:	FCC Part 15.247	Test Distance:	3 m
Test item:	Harmonic		
Frequency:	2402 MHz		
Mode:	Mode 3		
Ant.Polar.:	Vertical		

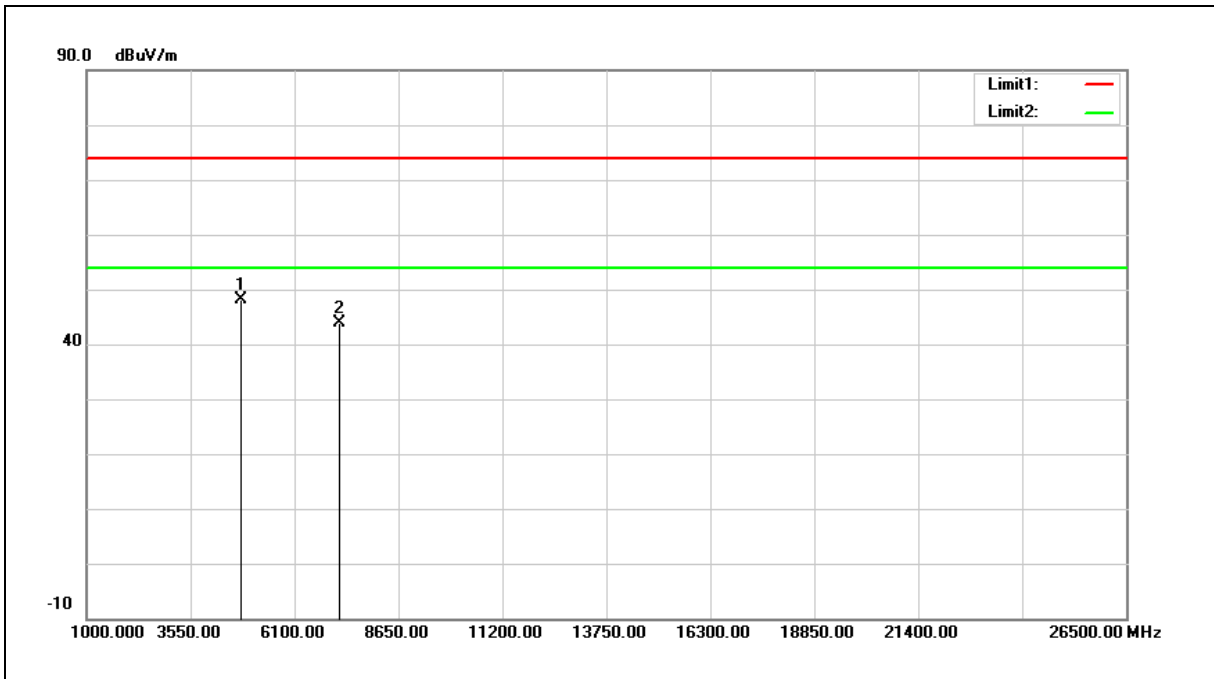

No.	Frequency (MHz)	Reading (dBuV)	Correct Factor (dB/m)	Result (dBuV/m)	Limit (dBuV/m)	Margin (dB)	Remark
1	4804.000	49.46	-1.30	48.16	74.00	-25.84	peak
2	7206.000	38.13	5.74	43.87	74.00	-30.13	peak

- Note:1.Result (dBuV/m) = Correct Factor (dB/m) + Reading(dBuV).
 2.Correction factor (dB/m) = Antenna Factor (dB/m) + Cable loss (dB) – Pre-Amplifier gain (dB).
 3.When the peak results are less than average limit, so not need to evaluate the average.

Standard:	FCC Part 15.247	Test Distance:	3 m
Test item:	Harmonic		
Frequency:	2441 MHz		
Mode:	Mode 3		
Ant.Polar.:	Horizontal		

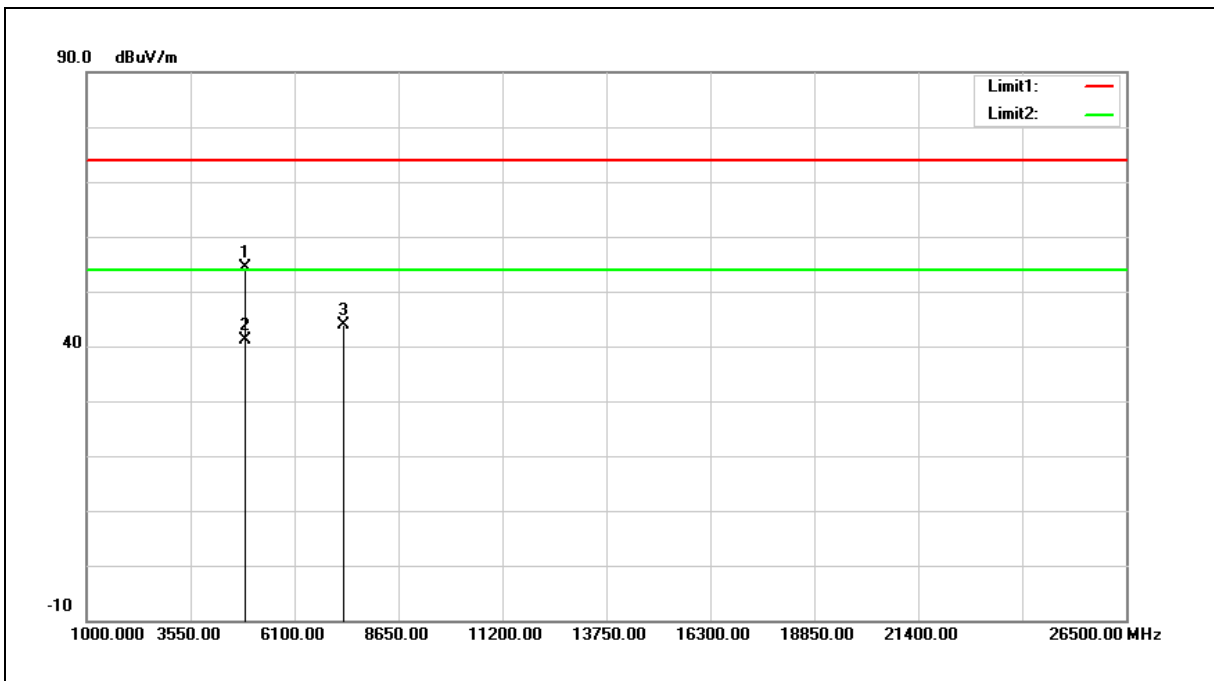

No.	Frequency (MHz)	Reading (dBuV)	Correct Factor (dB/m)	Result (dBuV/m)	Limit (dBuV/m)	Margin (dB)	Remark
1	4882.000	55.39	-1.10	54.29	74.00	-19.71	peak
2	4882.000	42.21	-1.10	41.11	54.00	-12.89	AVG
3	7323.000	37.68	6.15	43.83	74.00	-30.17	peak

Note:1.Result (dBuV/m) = Correct Factor (dB/m) + Reading(dBuV).

2.Correction factor (dB/m) = Antenna Factor (dB/m) + Cable loss (dB) – Pre-Amplifier gain (dB).

3.When the peak results are less than average limit, so not need to evaluate the average.



Standard:	FCC Part 15.247	Test Distance:	3 m
Test item:	Harmonic		
Frequency:	2441 MHz		
Mode:	Mode 3		
Ant.Polar.:	Vertical		

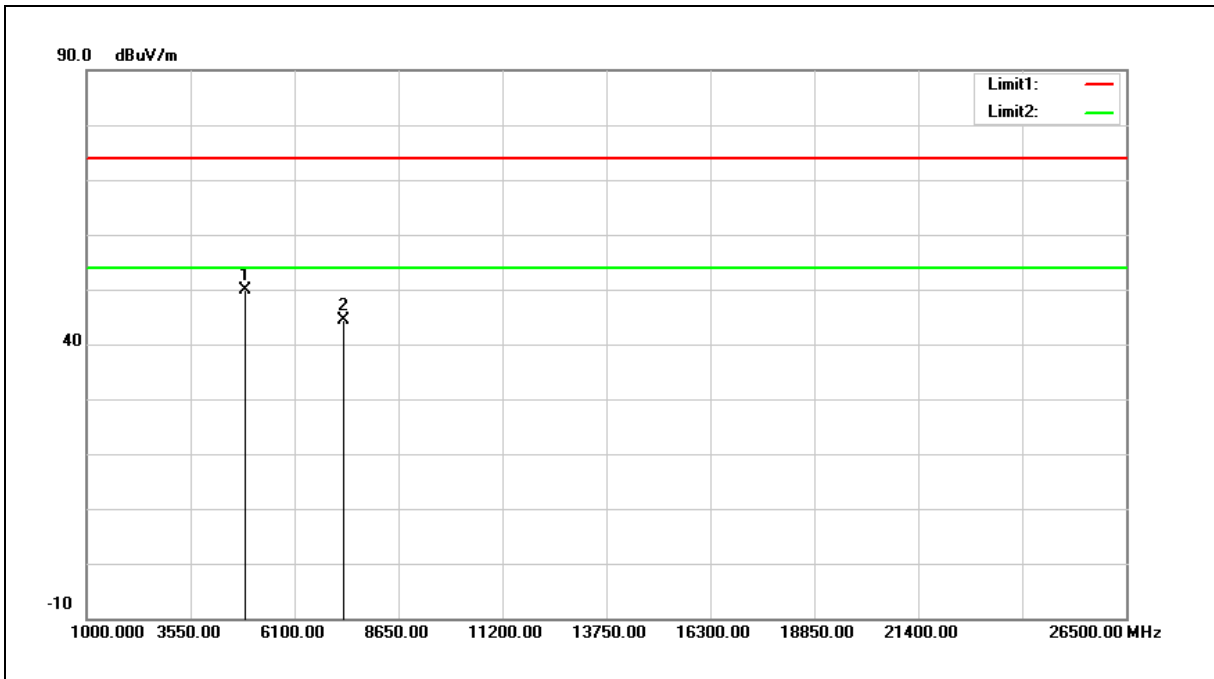

No.	Frequency (MHz)	Reading (dBuV)	Correct Factor (dB/m)	Result (dBuV/m)	Limit (dBuV/m)	Margin (dB)	Remark
1	4882.000	50.87	-1.10	49.77	74.00	-24.23	peak
2	7323.000	38.35	6.15	44.50	74.00	-29.50	peak

- Note: 1. Result (dBuV/m) = Correct Factor (dB/m) + Reading(dBuV).
 2. Correction factor (dB/m) = Antenna Factor (dB/m) + Cable loss (dB) – Pre-Amplifier gain (dB).
 3. When the peak results are less than average limit, so not need to evaluate the average.

Standard:	FCC Part 15.247	Test Distance:	3 m
Test item:	Harmonic		
Frequency:	2480 MHz		
Mode:	Mode 3		
Ant.Polar.:	Horizontal		

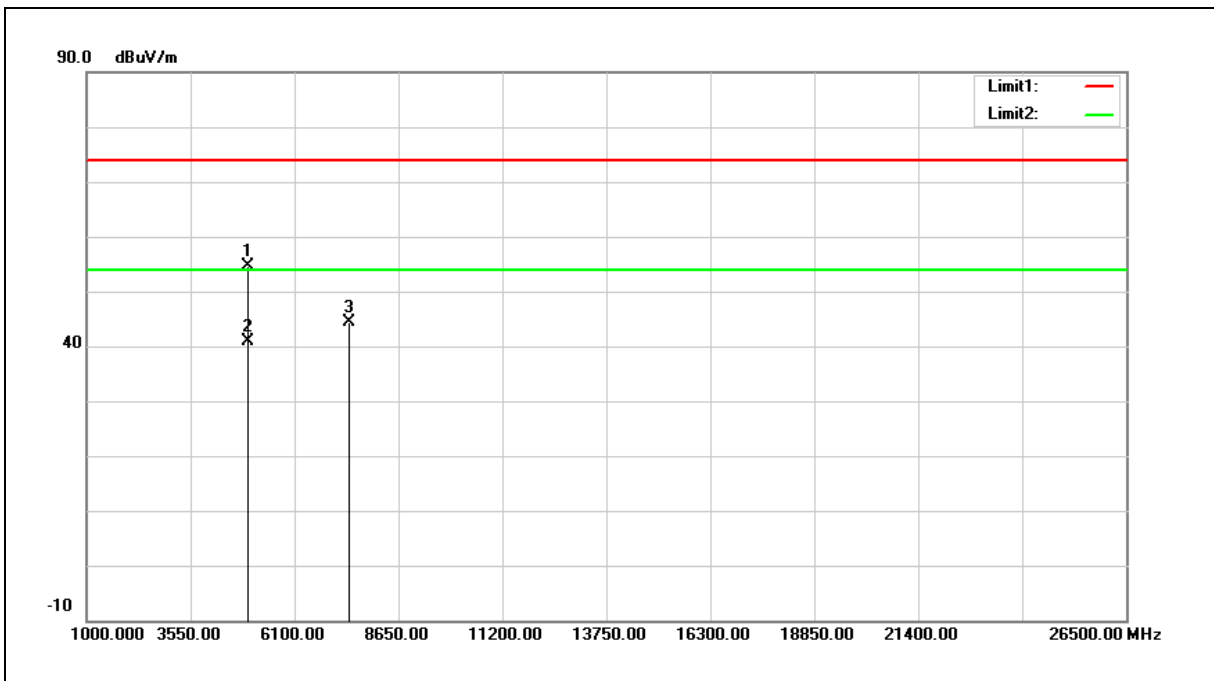

No.	Frequency (MHz)	Reading (dBuV)	Correct Factor (dB/m)	Result (dBuV/m)	Limit (dBuV/m)	Margin (dB)	Remark
1	4960.000	55.59	-0.88	54.71	74.00	-19.29	peak
2	4960.000	41.87	-0.88	40.99	54.00	-13.01	AVG
3	7440.000	37.88	6.56	44.44	74.00	-29.56	peak

Note:1.Result (dBuV/m) = Correct Factor (dB/m) + Reading(dBuV).

2.Correction factor (dB/m) = Antenna Factor (dB/m) + Cable loss (dB) – Pre-Amplifier gain (dB).

3.When the peak results are less than average limit, so not need to evaluate the average.



Standard:	FCC Part 15.247	Test Distance:	3 m
Test item:	Harmonic		
Frequency:	2480 MHz		
Mode:	Mode 3		
Ant.Polar.:	Vertical		

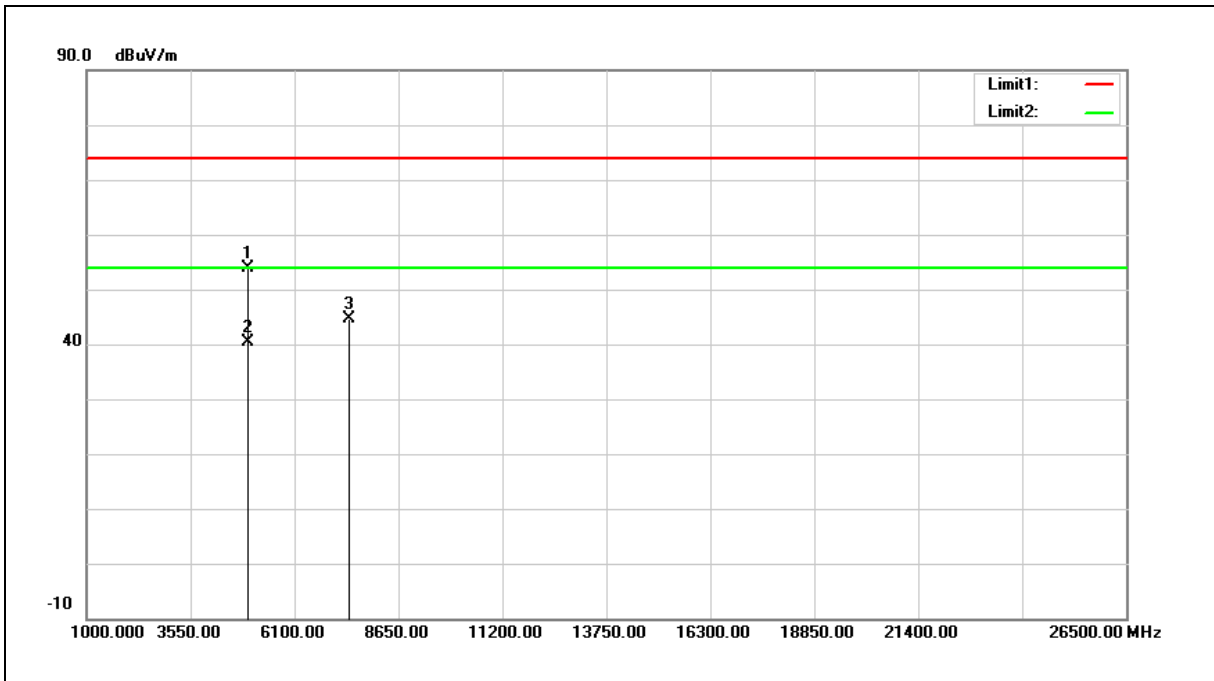

No.	Frequency (MHz)	Reading (dBuV)	Correct Factor (dB/m)	Result (dBuV/m)	Limit (dBuV/m)	Margin (dB)	Remark
1	4960.000	54.81	-0.88	53.93	74.00	-20.07	peak
2	4960.000	41.31	-0.88	40.43	54.00	-13.57	AVG
3	7440.000	38.13	6.56	44.69	74.00	-29.31	peak

Note:1.Result (dBuV/m) = Correct Factor (dB/m) + Reading(dBuV).

2.Correction factor (dB/m) = Antenna Factor (dB/m) + Cable loss (dB) – Pre-Amplifier gain (dB).

3.When the peak results are less than average limit, so not need to evaluate the average.



Band Edge

Standard:	FCC Part 15.247	Test Distance:	3 m
Test item:	Band edge		
Frequency:	2402 MHz		
Mode:	Mode 1		
Ant.Polar.:	Horizontal		

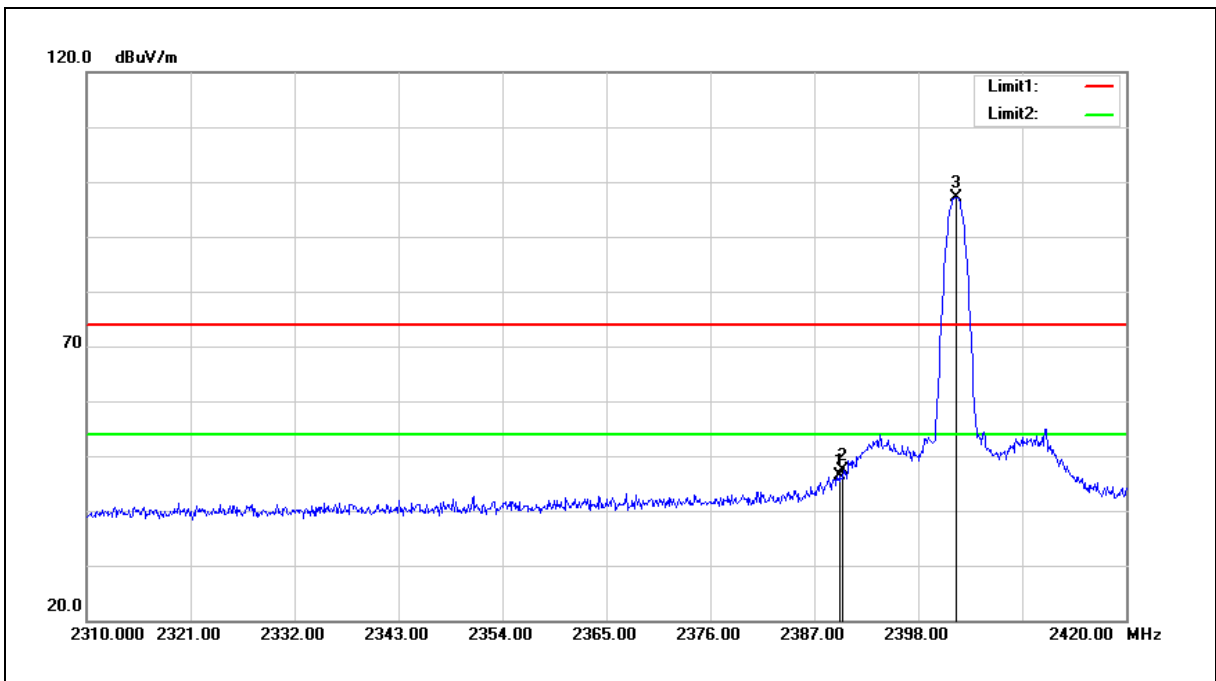

No.	Frequency (MHz)	Reading (dBuV)	Correct Factor (dB/m)	Result (dBuV/m)	Limit (dBuV/m)	Margin (dB)	Remark
1	2389.750	54.13	-7.72	46.41	74.00	-27.59	peak
2	2390.000	55.09	-7.72	47.37	74.00	-26.63	peak
3	2402.070	104.71	-7.66	97.05	--	--	peak

Note:1.Result (dBuV/m) = Correct Factor (dB/m) + Reading(dBuV).

2.Correction factor (dB/m) = Antenna Factor (dB/m) + Cable loss (dB) – Pre-Amplifier gain (dB).

3.When the peak results are less than average limit, so not need to evaluate the average.

Standard:	FCC Part 15.247	Test Distance:	3 m
Test item:	Band edge		
Frequency:	2402 MHz		
Mode:	Mode 1		
Ant.Polar.:	Vertical		

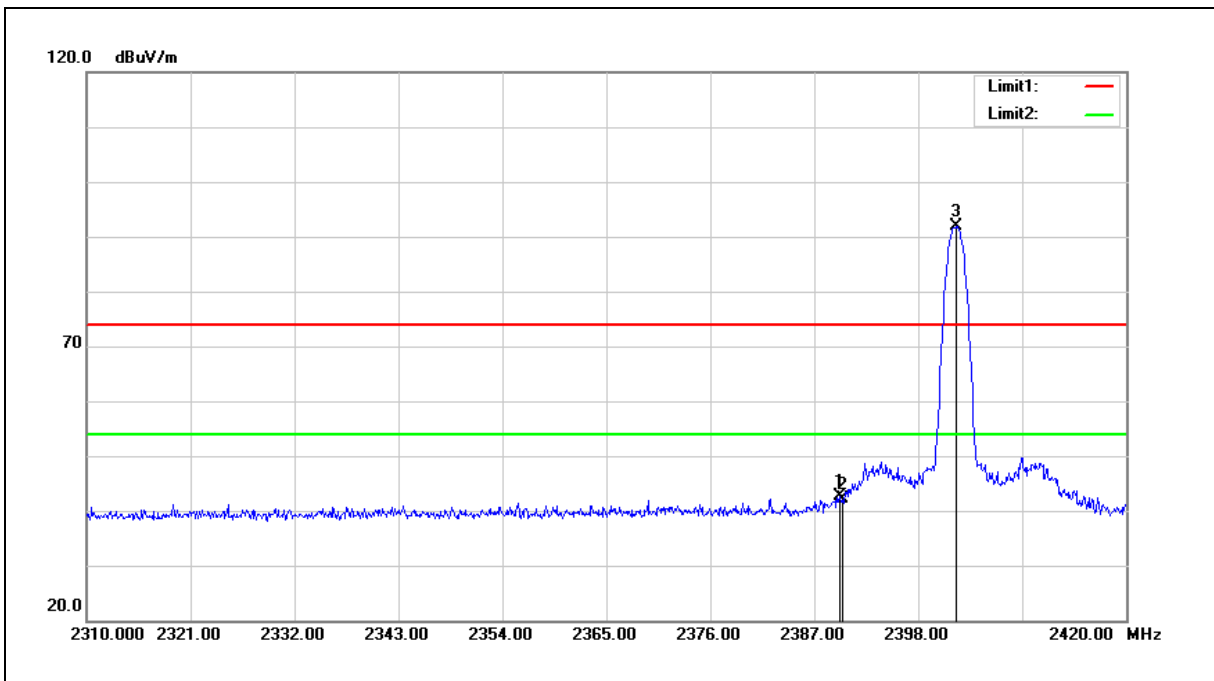

No.	Frequency (MHz)	Reading (dBuV)	Correct Factor (dB/m)	Result (dBuV/m)	Limit (dBuV/m)	Margin (dB)	Remark
1	2389.640	50.46	-7.72	42.74	74.00	-31.26	peak
2	2390.000	49.87	-7.72	42.15	74.00	-31.85	peak
3	2402.070	99.46	-7.66	91.80	--	--	peak

Note:1.Result (dBuV/m) = Correct Factor (dB/m) + Reading(dBuV).

2.Correction factor (dB/m) = Antenna Factor (dB/m) + Cable loss (dB) – Pre-Amplifier gain (dB).

3.When the peak results are less than average limit, so not need to evaluate the average.



Standard:	FCC Part 15.247	Test Distance:	3 m
Test item:	Band edge		
Frequency:	2480 MHz		
Mode:	Mode 1		
Ant.Polar.:	Horizontal		

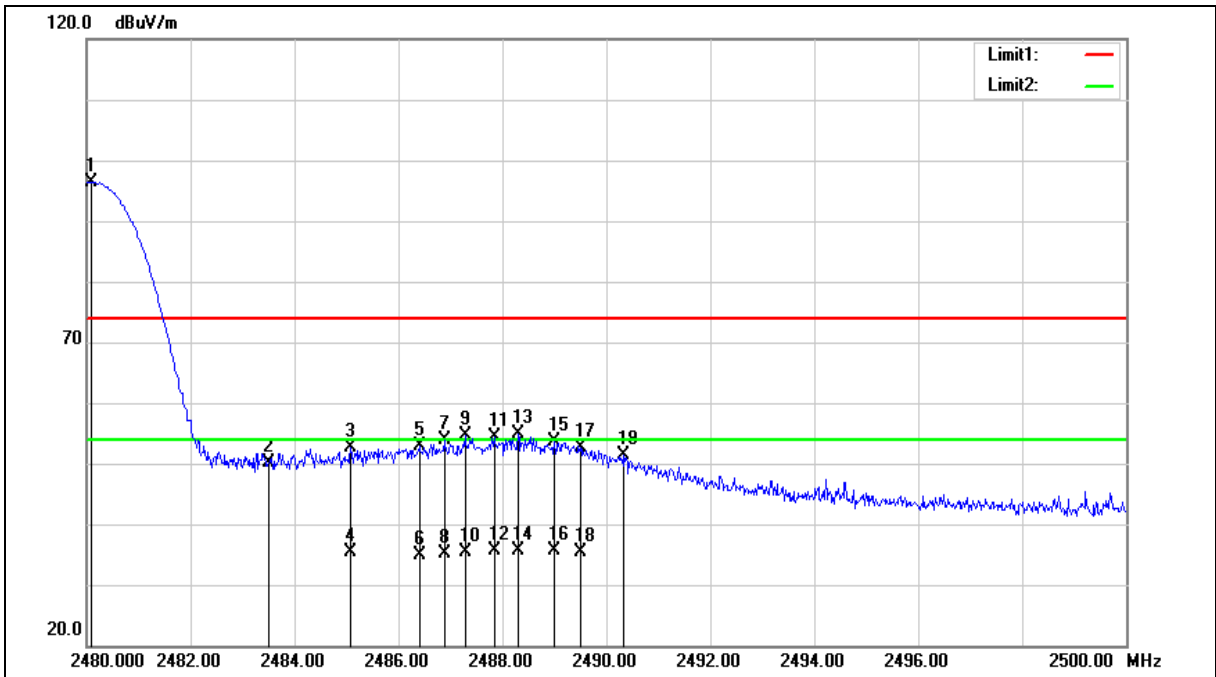



Standard:	FCC Part 15.247	Test Distance:	3 m
Test item:	Band edge		
Frequency:	2480 MHz		
Mode:	Mode 1		
Ant.Polar.:	Horizontal		

No.	Frequency (MHz)	Reading (dBuV)	Correct Factor (dB/m)	Result (dBuV/m)	Limit (dBuV/m)	Margin (dB)	Remark
1	2480.100	103.79	-7.35	96.44	--	--	peak
2	2483.500	57.36	-7.34	50.02	74.00	-23.98	peak
3	2485.080	59.99	-7.33	52.66	74.00	-21.34	peak
4	2485.080	42.77	-7.33	35.44	54.00	-18.56	AVG
5	2486.400	60.16	-7.32	52.84	74.00	-21.16	peak
6	2486.400	42.15	-7.32	34.83	54.00	-19.17	AVG
7	2486.880	61.10	-7.32	53.78	74.00	-20.22	peak
8	2486.880	42.36	-7.32	35.04	54.00	-18.96	AVG
9	2487.280	62.03	-7.32	54.71	74.00	-19.29	peak
10	2487.280	42.78	-7.32	35.46	54.00	-18.54	AVG
11	2487.840	61.64	-7.32	54.32	74.00	-19.68	peak
12	2487.840	42.83	-7.32	35.51	54.00	-18.49	AVG
13	2488.300	62.23	-7.32	54.91	74.00	-19.09	peak
14	2488.300	42.83	-7.32	35.51	54.00	-18.49	AVG
15	2489.000	61.04	-7.31	53.73	74.00	-20.27	peak
16	2489.000	42.82	-7.31	35.51	54.00	-18.49	AVG
17	2489.500	59.87	-7.31	52.56	74.00	-21.44	peak
18	2489.500	42.79	-7.31	35.48	54.00	-18.52	AVG
19	2490.320	58.63	-7.31	51.32	74.00	-22.68	peak

Note:1.Result (dBuV/m) = Correct Factor (dB/m) + Reading(dBuV).

2.Correction factor (dB/m) = Antenna Factor (dB/m) + Cable loss (dB) – Pre-Amplifier gain (dB).

3.When the peak results are less than average limit, so not need to evaluate the average.



Standard:	FCC Part 15.247	Test Distance:	3 m
Test item:	Band edge		
Frequency:	2480 MHz		
Mode:	Mode 1		
Ant.Polar.:	Vertical		

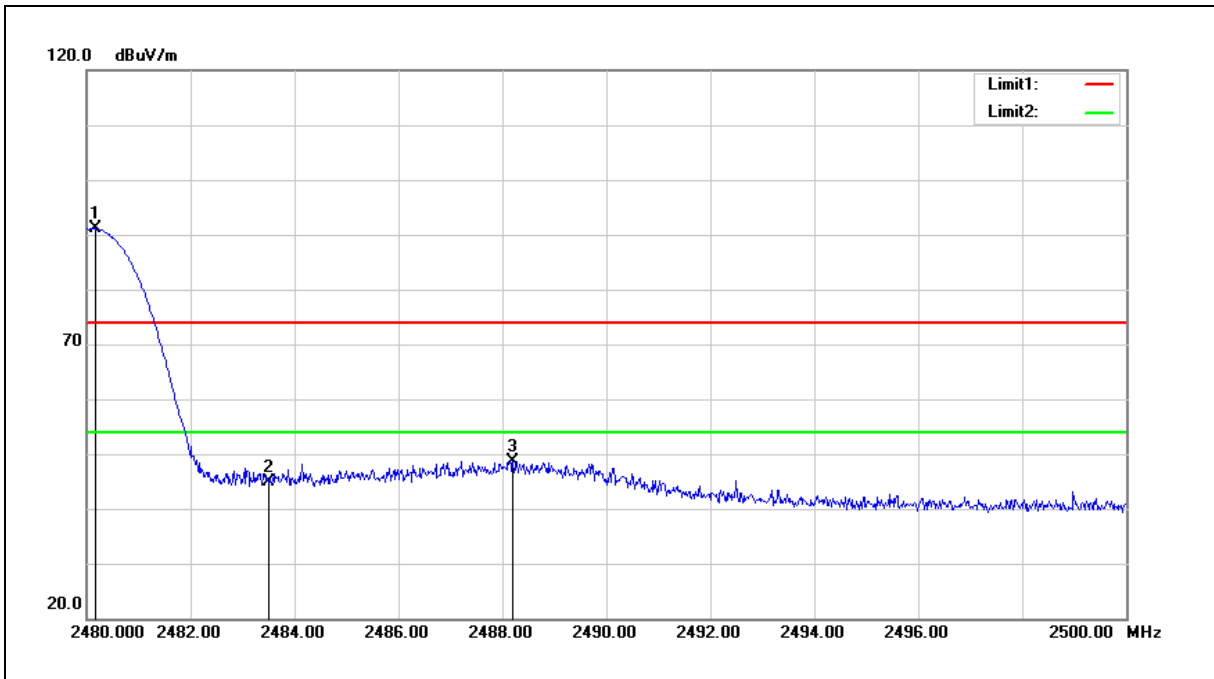

No.	Frequency (MHz)	Reading (dBuV)	Correct Factor (dB/m)	Result (dBuV/m)	Limit (dBuV/m)	Margin (dB)	Remark
1	2480.160	98.45	-7.35	91.10	--	--	peak
2	2483.500	52.19	-7.34	44.85	74.00	-29.15	peak
3	2488.200	55.99	-7.32	48.67	74.00	-25.33	peak

Note:1.Result (dBuV/m) = Correct Factor (dB/m) + Reading(dBuV).

2.Correction factor (dB/m) = Antenna Factor (dB/m) + Cable loss (dB) – Pre-Amplifier gain (dB).

3.When the peak results are less than average limit, so not need to evaluate the average.



Standard:	FCC Part 15.247	Test Distance:	3 m
Test item:	Band edge		
Frequency:	Hopping		
Mode:	Mode 1		
Ant.Polar.:	Horizontal		

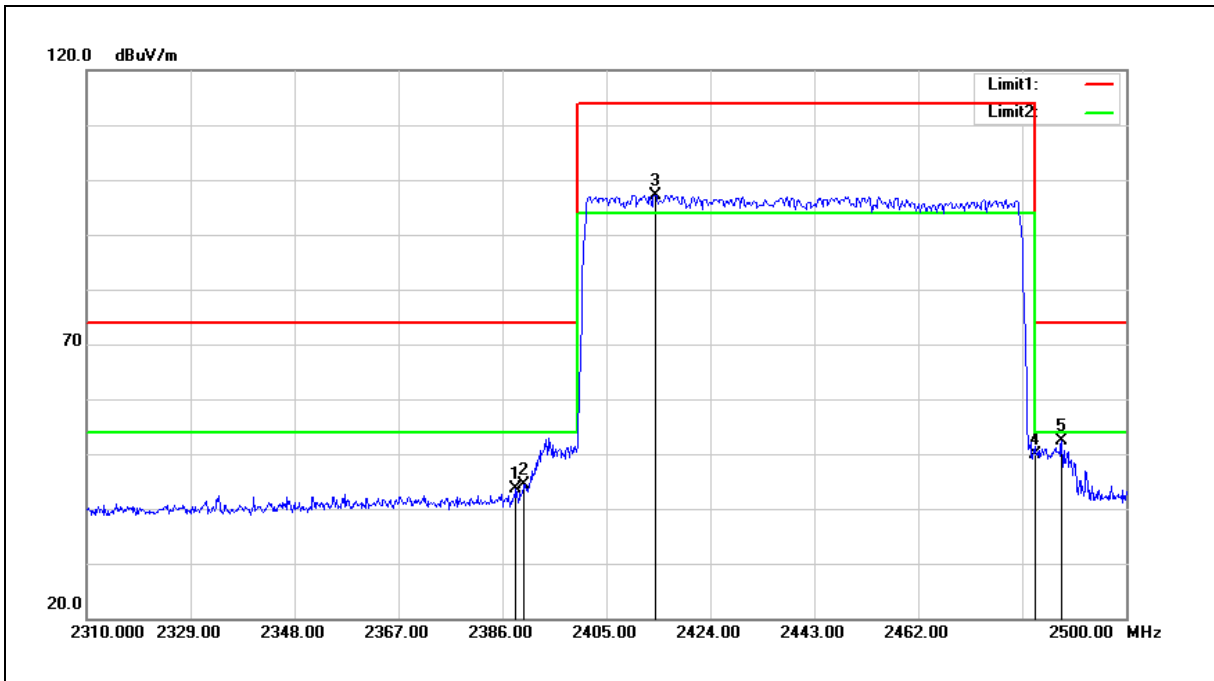

No.	Frequency (MHz)	Reading (dBuV)	Correct Factor (dB/m)	Result (dBuV/m)	Limit (dBuV/m)	Margin (dB)	Remark
1	2388.470	51.31	-7.72	43.59	74.00	-30.41	peak
2	2390.000	52.20	-7.72	44.48	74.00	-29.52	peak
3	2413.930	104.85	-7.62	97.23	--	--	peak
4	2483.500	57.19	-7.34	49.85	74.00	-24.15	peak
5	2488.220	59.58	-7.32	52.26	74.00	-21.74	peak

Note:1.Result (dBuV/m) = Correct Factor (dB/m) + Reading(dBuV).

2.Correction factor (dB/m) = Antenna Factor (dB/m) + Cable loss (dB) – Pre-Amplifier gain (dB).

3.When the peak results are less than average limit, so not need to evaluate the average.



Standard:	FCC Part 15.247	Test Distance:	3 m
Test item:	Band edge		
Frequency:	Hopping		
Mode:	Mode 1		
Ant.Polar.:	Vertical		

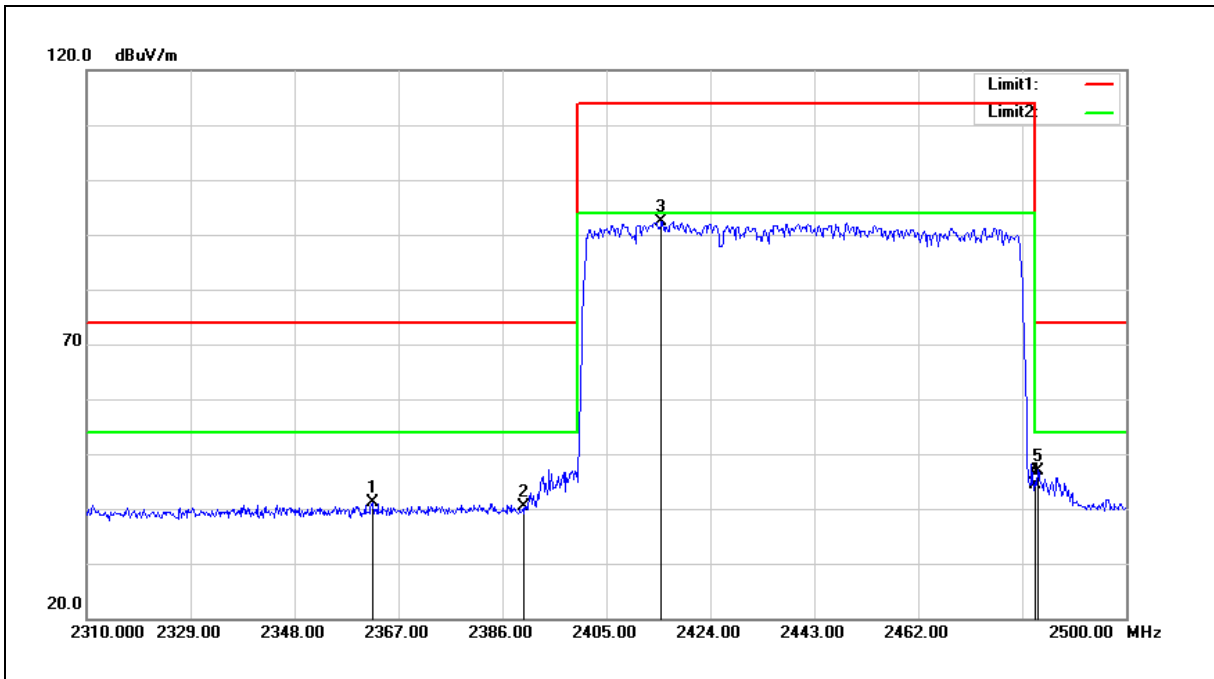

No.	Frequency (MHz)	Reading (dBuV)	Correct Factor (dB/m)	Result (dBuV/m)	Limit (dBuV/m)	Margin (dB)	Remark
1	2362.250	49.01	-7.83	41.18	74.00	-32.82	peak
2	2390.000	48.05	-7.72	40.33	74.00	-33.67	peak
3	2415.070	99.98	-7.61	92.37	--	--	peak
4	2483.500	51.61	-7.34	44.27	74.00	-29.73	peak
5	2483.850	54.34	-7.34	47.00	74.00	-27.00	peak

Note:1.Result (dBuV/m) = Correct Factor (dB/m) + Reading(dBuV).

2.Correction factor (dB/m) = Antenna Factor (dB/m) + Cable loss (dB) – Pre-Amplifier gain (dB).

3.When the peak results are less than average limit, so not need to evaluate the average.



Standard:	FCC Part 15.247	Test Distance:	3 m
Test item:	Band edge		
Frequency:	2402 MHz		
Mode:	Mode 3		
Ant.Polar.:	Horizontal		

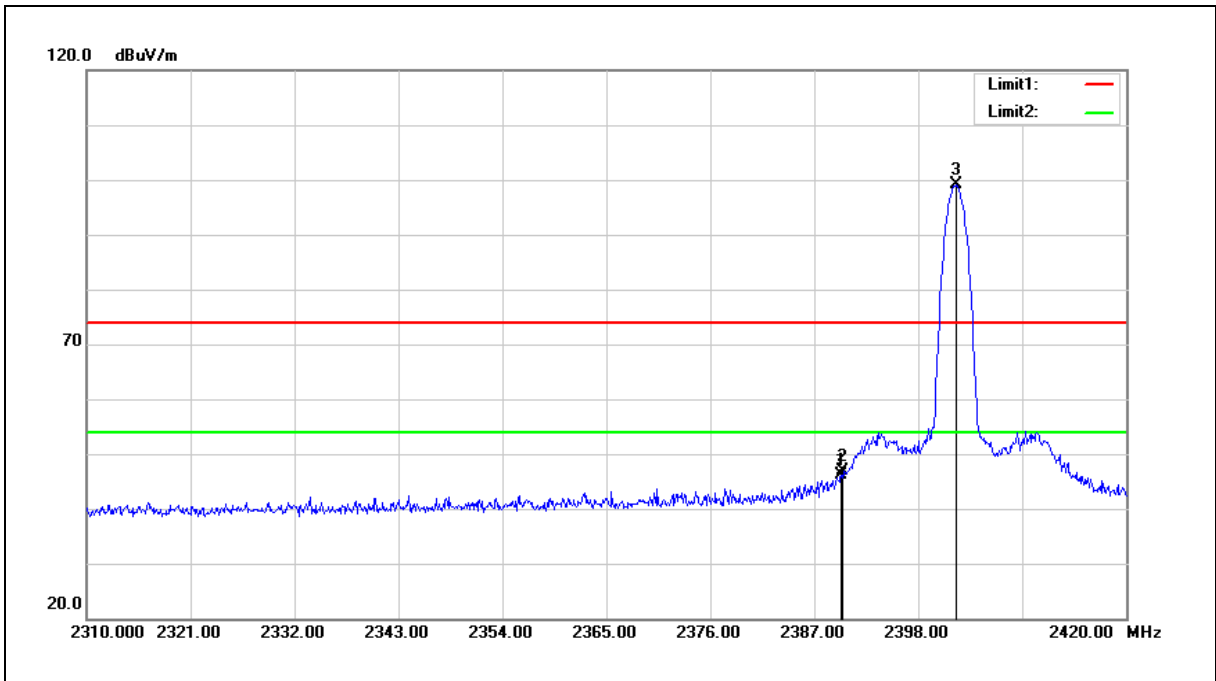

No.	Frequency (MHz)	Reading (dBuV)	Correct Factor (dB/m)	Result (dBuV/m)	Limit (dBuV/m)	Margin (dB)	Remark
1	2389.860	53.89	-7.72	46.17	74.00	-27.83	peak
2	2390.000	54.59	-7.72	46.87	74.00	-27.13	peak
3	2402.070	106.75	-7.66	99.09	--	--	peak

Note:1.Result (dBuV/m) = Correct Factor (dB/m) + Reading(dBuV).

2.Correction factor (dB/m) = Antenna Factor (dB/m) + Cable loss (dB) – Pre-Amplifier gain (dB).

3.When the peak results are less than average limit, so not need to evaluate the average.



Standard:	FCC Part 15.247	Test Distance:	3 m
Test item:	Band edge		
Frequency:	2402 MHz		
Mode:	Mode 3		
Ant.Polar.:	Vertical		

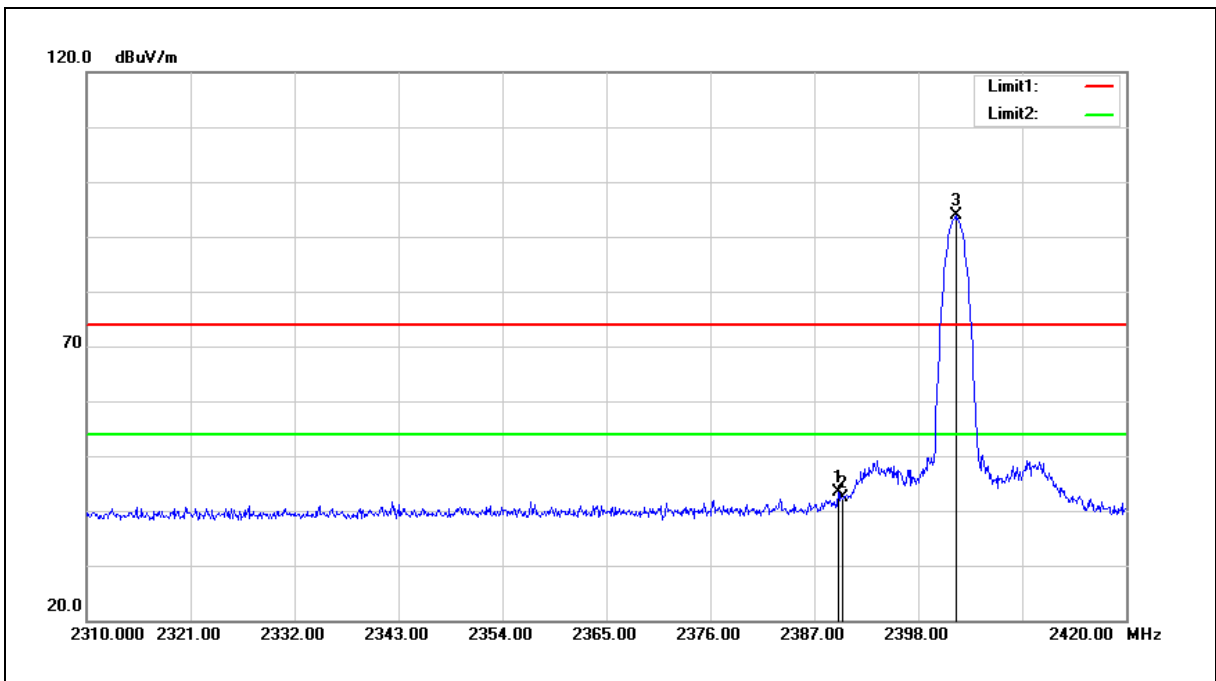

No.	Frequency (MHz)	Reading (dBuV)	Correct Factor (dB/m)	Result (dBuV/m)	Limit (dBuV/m)	Margin (dB)	Remark
1	2389.530	50.98	-7.72	43.26	74.00	-30.74	peak
2	2390.000	50.09	-7.72	42.37	74.00	-31.63	peak
3	2401.960	101.48	-7.66	93.82	--	--	peak

Note:1.Result (dBuV/m) = Correct Factor (dB/m) + Reading(dBuV).

2.Correction factor (dB/m) = Antenna Factor (dB/m) + Cable loss (dB) – Pre-Amplifier gain (dB).

3.When the peak results are less than average limit, so not need to evaluate the average.



Standard:	FCC Part 15.247	Test Distance:	3 m
Test item:	Band edge		
Frequency:	2480 MHz		
Mode:	Mode 3		
Ant.Polar.:	Horizontal		

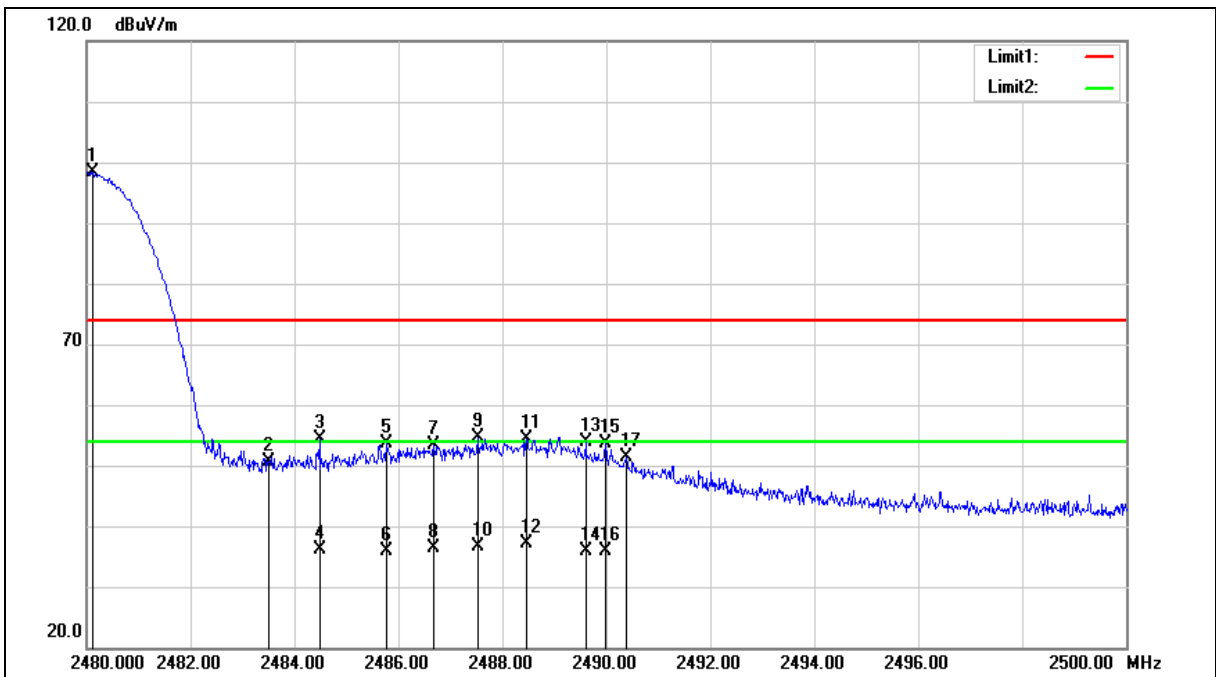



Standard:	FCC Part 15.247	Test Distance:	3 m
Test item:	Band edge		
Frequency:	2480 MHz		
Mode:	Mode 3		
Ant.Polar.:	Horizontal		

No.	Frequency (MHz)	Reading (dBuV)	Correct Factor (dB/m)	Result (dBuV/m)	Limit (dBuV/m)	Margin (dB)	Remark
1	2480.120	105.72	-7.35	98.37	--	--	peak
2	2483.500	57.86	-7.34	50.52	74.00	-23.48	peak
3	2484.480	61.76	-7.34	54.42	74.00	-19.58	peak
4	2484.480	43.40	-7.34	36.06	54.00	-17.94	AVG
5	2485.760	61.05	-7.32	53.73	74.00	-20.27	peak
6	2485.760	43.22	-7.32	35.90	54.00	-18.10	AVG
7	2486.680	60.60	-7.32	53.28	74.00	-20.72	peak
8	2486.680	43.59	-7.32	36.27	54.00	-17.73	AVG
9	2487.520	61.92	-7.32	54.60	74.00	-19.40	peak
10	2487.520	44.03	-7.32	36.71	54.00	-17.29	AVG
11	2488.460	61.59	-7.31	54.28	74.00	-19.72	peak
12	2488.460	44.35	-7.31	37.04	54.00	-16.96	AVG
13	2489.600	61.08	-7.31	53.77	74.00	-20.23	peak
14	2489.600	43.13	-7.31	35.82	54.00	-18.18	AVG
15	2489.980	61.04	-7.31	53.73	74.00	-20.27	peak
16	2489.980	43.15	-7.31	35.84	54.00	-18.16	AVG
17	2490.380	58.70	-7.31	51.39	74.00	-22.61	peak

Note:1.Result (dBuV/m) = Correct Factor (dB/m) + Reading(dBuV).

2.Correction factor (dB/m) = Antenna Factor (dB/m) + Cable loss (dB) – Pre-Amplifier gain (dB).

3.When the peak results are less than average limit, so not need to evaluate the average.



Standard:	FCC Part 15.247	Test Distance:	3 m
Test item:	Band edge		
Frequency:	2480 MHz		
Mode:	Mode 3		
Ant.Polar.:	Vertical		

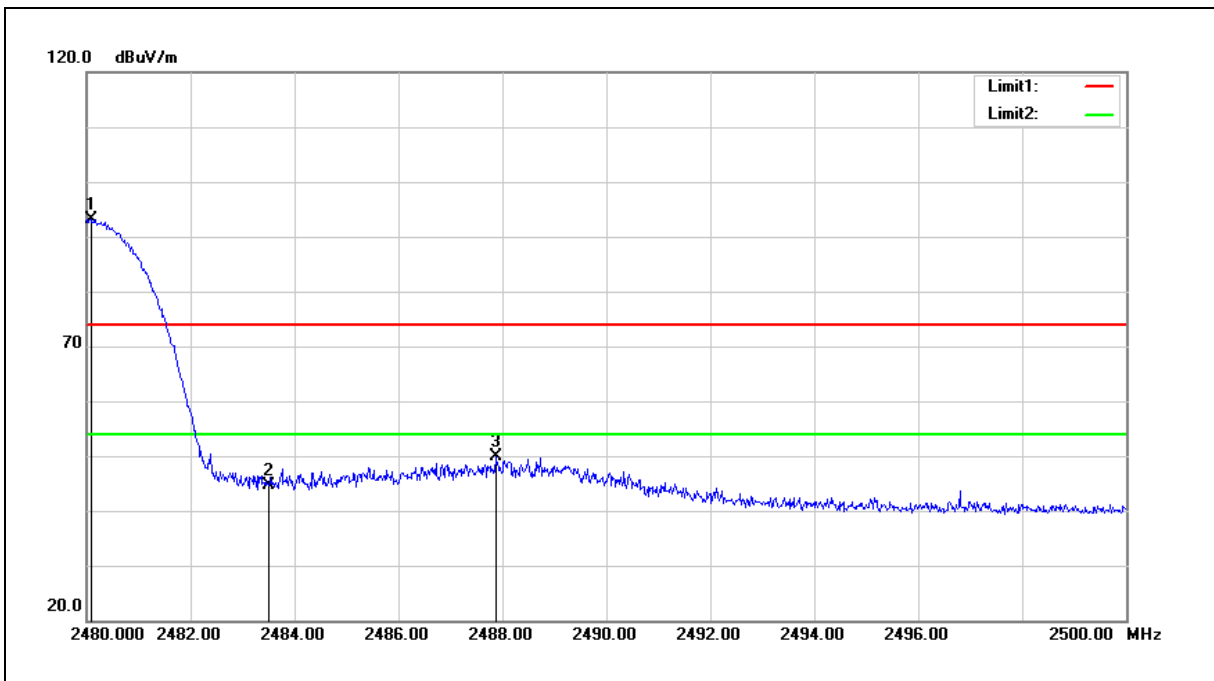

No.	Frequency (MHz)	Reading (dBuV)	Correct Factor (dB/m)	Result (dBuV/m)	Limit (dBuV/m)	Margin (dB)	Remark
1	2480.080	100.52	-7.35	93.17	--	--	peak
2	2483.500	51.96	-7.34	44.62	74.00	-29.38	peak
3	2487.880	57.19	-7.32	49.87	74.00	-24.13	peak

Note:1.Result (dBuV/m) = Correct Factor (dB/m) + Reading(dBuV).

2.Correction factor (dB/m) = Antenna Factor (dB/m) + Cable loss (dB) – Pre-Amplifier gain (dB).

3.When the peak results are less than average limit, so not need to evaluate the average.



Standard:	FCC Part 15.247	Test Distance:	3 m
Test item:	Band edge		
Frequency:	Hopping		
Mode:	Mode 3		
Ant.Polar.:	Horizontal		

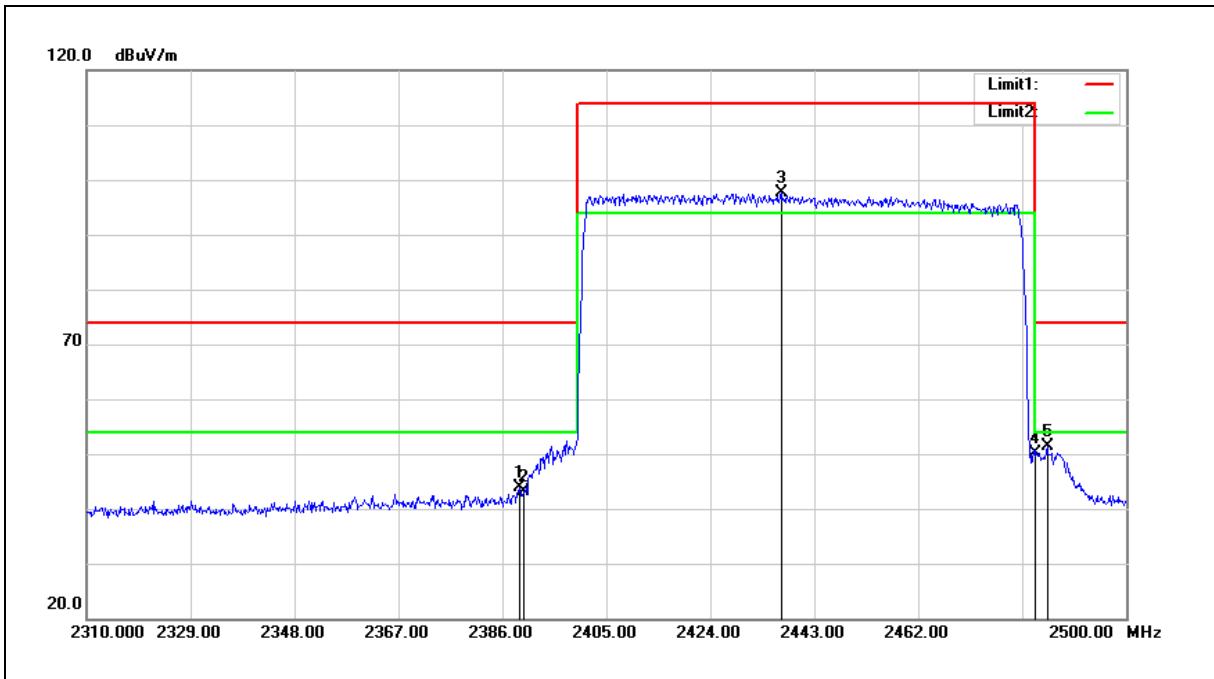

No.	Frequency (MHz)	Reading (dBuV)	Correct Factor (dB/m)	Result (dBuV/m)	Limit (dBuV/m)	Margin (dB)	Remark
1	2389.230	51.51	-7.72	43.79	74.00	-30.21	peak
2	2390.000	50.74	-7.72	43.02	74.00	-30.98	peak
3	2436.920	105.21	-7.53	97.68	--	--	peak
4	2483.500	57.39	-7.34	50.05	74.00	-23.95	peak
5	2485.560	58.60	-7.32	51.28	74.00	-22.72	peak

Note:1.Result (dBuV/m) = Correct Factor (dB/m) + Reading(dBuV).

2.Correction factor (dB/m) = Antenna Factor (dB/m) + Cable loss (dB) – Pre-Amplifier gain (dB).

3.When the peak results are less than average limit, so not need to evaluate the average.



Standard:	FCC Part 15.247	Test Distance:	3 m
Test item:	Band edge		
Frequency:	Hopping		
Mode:	Mode 3		
Ant.Polar.:	Vertical		

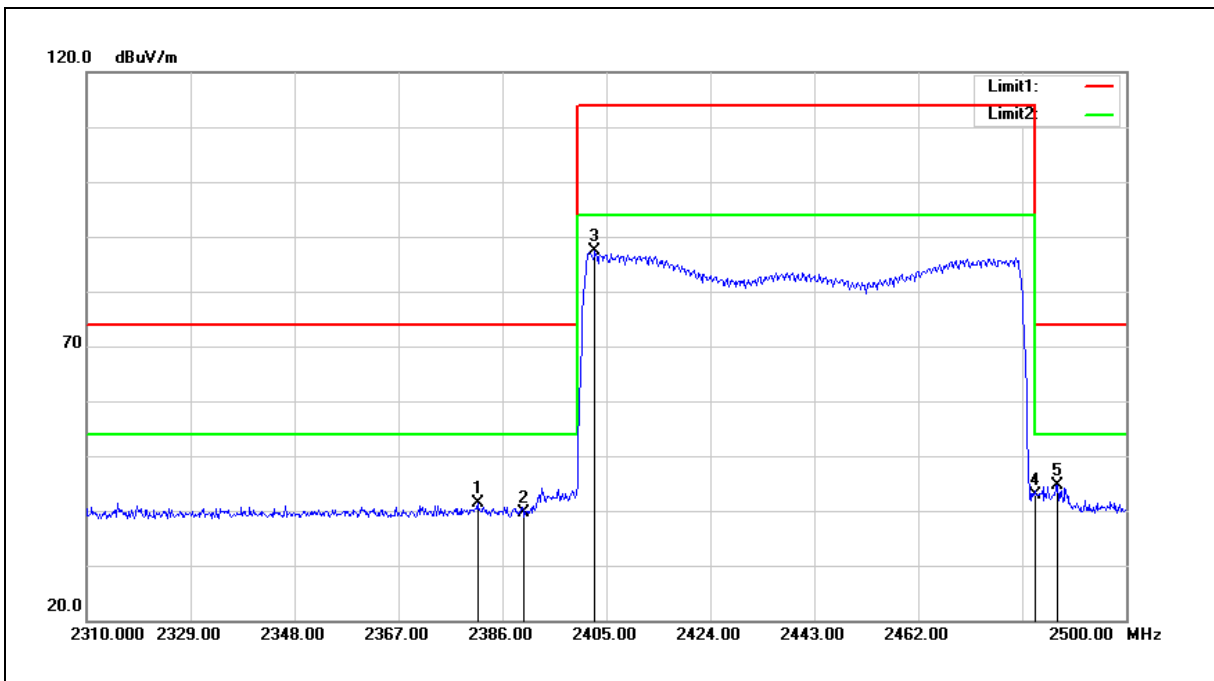

No.	Frequency (MHz)	Reading (dBuV)	Correct Factor (dB/m)	Result (dBuV/m)	Limit (dBuV/m)	Margin (dB)	Remark
1	2381.440	49.19	-7.76	41.43	74.00	-32.57	peak
2	2390.000	47.42	-7.72	39.70	74.00	-34.30	peak
3	2402.910	95.08	-7.66	87.42	--	--	peak
4	2483.500	50.32	-7.34	42.98	74.00	-31.02	peak
5	2487.460	52.00	-7.32	44.68	74.00	-29.32	peak

Note:1.Result (dBuV/m) = Correct Factor (dB/m) + Reading(dBuV).

2.Correction factor (dB/m) = Antenna Factor (dB/m) + Cable loss (dB) – Pre-Amplifier gain (dB).

3.When the peak results are less than average limit, so not need to evaluate the average.

---END---