



CTC Laboratories, Inc.

1-2/F., Building 2, Jiaquan Building, Guanlan High-Tech Park, Shenzhen, Guangdong, China
Tel: +86-755- 27521059 Fax: +86-755- 27521011 Http://www.sz-ctc.org.cn

TEST REPORT

Report No.: **CTC20201416E06**

FCC ID.....: **2AWAA-RS2**

Applicant.....: **ZHEJIANG DALI TECHNOLOGY CO., LTD**

Address.....: NO639 Binkang Road, Hangzhou, P.R.CHINA 310053

Manufacturer.....: ZHEJIANG DALI TECHNOLOGY CO.,LTD

Address.....: NO639 Binkang Road, Hangzhou, P.R.CHINA 310053

Product Name.....: **Thermal Imaging Riflescopes**

Trade Mark.....: N/A

Model/Type reference.....: RS225-384

Listed Model(s): RS225-240

Standard.....: **FCC CFR Title 47 Part 15 Subpart C Section 15.247**

Date of receipt of test sample...: Sep. 08, 2020

Date of testing.....: Sep. 09, 2020 to Sep. 23, 2020

Date of issue.....: Sep. 24, 2020

Result.....: **PASS**

Compiled by:		
(Printed name+signature)	Terry Su	<i>Terry Su</i>
Supervised by:		
(Printed name+signature)	Miller Ma	<i>Miller Ma</i>
Approved by:		
(Printed name+signature)	Walter Chen	<i>Walter Chen</i>

Testing Laboratory Name.....: **CTC Laboratories, Inc.**

Address.....: 1-2/F., Building 2, Jiaquan Building, Guanlan High-Tech Park, Shenzhen, Guangdong, China

This test report may be duplicated completely for legal use with the approval of the applicant. It should not be reproduced except in full, without the written approval of our laboratory. The client should not use it to claim product endorsement by CTC. The test results in the report only apply to the tested sample. The test report shall be invalid without all the signatures of testing engineers, reviewer and approver. Any objections must be raised to CTC within 15 days since the date when the report is received. It will not be taken into consideration beyond this limit. The test report merely correspond to the test sample.



Table of Contents

Page

1. TEST SUMMARY..... 3

1.1. TEST STANDARDS.....3

1.2. REPORT VERSION.....3

1.3. TEST DESCRIPTION.....4

1.4. TEST FACILITY5

1.5. MEASUREMENT UNCERTAINTY5

1.6. ENVIRONMENTAL CONDITIONS6

2. GENERAL INFORMATION..... 7

2.1. CLIENT INFORMATION7

2.2. GENERAL DESCRIPTION OF EUT7

2.3. ACCESSORY EQUIPMENT INFORMATION8

2.4. OPERATION STATE.....9

2.5. MEASUREMENT INSTRUMENTS LIST10

3. TEST ITEM AND RESULTS 12

3.1. CONDUCTED EMISSION.....12

3.2. RADIATED EMISSION15

3.3. BAND EDGE EMISSIONS37

3.4. DTS BANDWIDTH.....53

3.5. PEAK OUTPUT POWER58

3.6. POWER SPECTRAL DENSITY60

3.7. DUTY CYCLE65

3.8. ANTENNA REQUIREMENT69



1. TEST SUMMARY

1.1. Test Standards

The tests were performed according to following standards:

[FCC Rules Part 15.247](#): Operation within the bands of 902-928MHz, 2400-2483.5MHz, and 5725-5850MHz.

[RSS 247 Issue 2](#): Standard Specifications for Frequency Hopping Systems (FHSs) and Digital Transmission Systems (DTSS) Operating in the Bands 902-928MHz, 2400-2483.5MHz and 5725-5850MHz.

[ANSI C63.10-2013](#): American National Standard for Testing Unlicensed Wireless Devices.

1.2. Report version

Revised No.	Date of issue	Description
01	Sep. 24, 2020	Original



1.3. Test Description

FCC Part 15 Subpart C (15.247) / RSS 247 Issue 2				
Test Item	Standard Section		Result	Test Engineer
	FCC	IC		
Antenna Requirement	15.203	/	Pass	Rod Luo
Conducted Emission	15.207	RSS-Gen 8.8	Pass	Jon Huang
Band Edge Emissions	15.247(d)	RSS 247 5.5	Pass	Rod Luo
6dB Bandwidth	15.247(a)(2)	RSS 247 5.2 (a)	Pass	Rod Luo
Conducted Max Output Power	15.247(b)(3)	RSS 247 5.4 (d)	Pass	Rod Luo
Power Spectral Density	15.247(e)	RSS 247 5.2 (b)	Pass	Rod Luo
Transmitter Radiated Spurious	15.209&15.247(d)	RSS 247 5.5& RSS-Gen 8.9	Pass	Rod Luo

Note: The measurement uncertainty is not included in the test result.



1.4. Test Facility

CTC Laboratories, Inc.

Add: 1-2/F., Building 2, Jiaquan Building, Guanlan High-Tech Park, Shenzhen, Guangdong, China

Laboratory accreditation

The test facility is recognized, certified, or accredited by the following organizations:

CNAS-Lab Code: L5365

CTC Laboratories, Inc. has been assessed and proved to be in compliance with CNAS-CL01 Accreditation. Criteria for Testing and Calibration Laboratories (identical to ISO/IEC 17025:2017 General Requirements) for the Competence of Testing and Calibration Laboratories.

A2LA-Lab Cert. No.: 4340.01

CTC Laboratories, Inc. EMC Laboratory has been accredited by A2LA for technical competence in the field of electrical testing, and proved to be in compliance with ISO/IEC 17025:2017 General Requirements for the Competence of Testing and Calibration Laboratories and any additional program requirements in the identified field of testing.

Industry Canada (Registration No.: 9783A, CAB Identifier: CN0029)

CTC Laboratories, Inc. EMC Laboratory has been registered by Certification and Engineer Bureau of Industry Canada for the performance of with Registration NO.: 9783A on Jan, 2016.

FCC (Registration No.: 951311, Designation Number CN1208)

CTC Laboratories, Inc. EMC Laboratory has been registered and fully described in a report filed with the (FCC) Federal Communications Commission. The acceptance letter from the FCC is maintained in our files. Registration 951311, Aug 26, 2017.

1.5. Measurement Uncertainty

The data and results referenced in this document are true and accurate. The reader is cautioned that there may be errors within the calibration limits of the equipment and facilities. The measurement uncertainty was calculated for all measurements listed in this test report acc. to TR-100028-01 "Electromagnetic compatibility and Radio spectrum Matters (ERM); Uncertainties in the measurement of mobile radio equipment characteristics; Part 1" and TR-100028-02 "Electromagnetic compatibility and Radio spectrum Matters (ERM); Uncertainties in the measurement of mobile radio equipment characteristics; Part 2" and is documented in the CTC Laboratories, Inc. quality system acc. to DIN EN ISO/IEC 17025. Furthermore, component and process variability of devices similar to that tested may result in additional deviation. The manufacturer has the sole responsibility of continued compliance of the device.

Below is the best measurement capability for CTC Laboratories, Inc.



Test Items	Measurement Uncertainty	Notes
Transmitter power conducted	0.42 dB	(1)
Transmitter power Radiated	2.14 dB	(1)
Conducted spurious emissions 9kHz~40GHz	1.60 dB	(1)
Radiated spurious emissions 9kHz~40GHz	2.20 dB	(1)
Conducted Emissions 9kHz~30MHz	3.08 dB	(1)
Radiated Emissions 30~1000MHz	4.51 dB	(1)
Radiated Emissions 1~18GHz	5.84 dB	(1)
Radiated Emissions 18~40GHz	6.12 dB	(1)
Occupied Bandwidth	-----	(1)

Note (1): This uncertainty represents an expanded uncertainty expressed at approximately the 95% confidence level using a coverage factor of $k=1.96$.

1.6. Environmental conditions

During the measurement the environmental conditions were within the listed ranges:

Temperature:	21°C ~ 27°C
Relative Humidity:	40% ~ 60%
Air Pressure:	101kPa



2. GENERAL INFORMATION

2.1. Client Information

Applicant:	ZHEJIANG DALI TECHNOLOGY CO., LTD
Address:	NO639 Binkang Road, Hangzhou, P.R.CHINA 310053
Manufacturer:	ZHEJIANG DALI TECHNOLOGY CO., LTD
Address:	NO639 Binkang Road, Hangzhou, P.R.CHINA 310053

2.2. General Description of EUT

Product Name:	Thermal Imaging Riflescopes
Trade Mark:	N/A
Model/Type reference:	RS225-384
Listed Model(s):	RS225-240
Model Different:	All these models are identical in the same PCB, layout and electrical circuit, The only difference is sensing resolution.
Power supply:	5Vdc/2A from AC/DC Adapter 3.6Vdc from 5000mAh Li-ion Battery
Adapter Model:	CD122 Input: AC100-240V 50/60Hz 0.5A Max Output: 5Vdc/3A 9Vdc/2A 12Vdc/1.5A
Hardware version:	N/A
Software version:	N/A
WIFI 802.11b/ g/ n(HT20)	
Modulation:	802.11b: DSSS(CCK, DQPSK, DBPSK) 802.11g/n: OFDM(BPSK, QPSK, 16QAM, 64QAM)
Operation frequency:	802.11b/g/n(HT20): 2412MHz~2462MHz
Channel number:	802.11b/g/n(HT20):11channels
Channel separation:	5MHz
Antenna type:	FPC Antenna
Antenna gain:	1.16dBi



2.3. Accessory Equipment information

Equipment Information			
Name	Model	S/N	Manufacturer
Notebook	X220	R9-NCMYL 12/04	Lenovo
Cable Information			
Name	Shielded Type	Ferrite Core	Length
Type-C	Yes	Yes	1.35M
Test Software Information			
Name	/	/	/
/	/	/	/



2.4. Operation state

Operation Frequency List: The EUT has been tested under typical operating condition. The Applicant provides communication tools software to control the EUT for staying in continuous transmitting and receiving mode for testing.

Operation Frequency List:

Channel	Frequency (MHz)
01	2412
02	2417
03	2422
04	2427
05	2432
06	2437
07	2442
08	2447
09	2452
10	2457
11	2462

Note: CH 01~CH 11 for 802.11b/g/n(HT20)

Data Rated

Preliminary tests were performed in different data rate, and found which the below bit rate is worst case mode, so only show data which it is a worst case mode.

Mode	Data rate (worst mode)
802.11b	1Mbps
802.11g	6Mbps
802.11n(HT20)	HT-MCS0

Test mode

For RF test items:
The engineering test program was provided and enabled to make EUT continuous transmit.
For AC power line conducted emissions:
The EUT was set to connect with the WLAN AP under large package sizes transmission.
For Radiated spurious emissions test item:
The engineering test program was provided and enabled to make EUT continuous transmit. The EUT in each of three orthogonal axis emissions had been tested, but only the worst case (X axis) data Recorded in the report.



2.5. Measurement Instruments List

Tonscend JS0806-2 Test system					
Item	Test Equipment	Manufacturer	Model No.	Serial No.	Calibrated until
1	Spectrum Analyzer	Rohde & Schwarz	FSU26	100105	Dec. 27, 2020
2	Spectrum Analyzer	Rohde & Schwarz	FUV40-N	101331	Mar. 15, 2021
3	MXG Vector Signal Generator	Agilent	N5182A	MY47420864	Dec. 27, 2020
4	Signal Generator	Agilent	E8257D	MY46521908	Dec. 27, 2020
5	Power Sensor	Agilent	U2021XA	MY5365004	Dec. 27, 2020
6	Power Sensor	Agilent	U2021XA	MY5365006	Dec. 27, 2020
7	Simultaneous Sampling DAQ	Agilent	U2531A	TW54493510	Dec. 27, 2020
8	Climate Chamber	TABAI	PR-4G	A8708055	Dec. 27, 2020
9	Wideband Radio Communication Tester	Rohde & Schwarz	CMW500	116410	Dec. 27, 2020
10	Climate Chamber	ESPEC	MT3065	/	Dec. 27, 2020
11	300328 v2.2.2 test system	TONSCEND	v2.6	/	/

Radiated Emission and Transmitter spurious emissions					
Item	Test Equipment	Manufacturer	Model No.	Serial No.	Calibrated until
1	EMI Test Receiver	Rohde & Schwarz	ESCI	100658	Dec. 27, 2020
2	High pass filter	micro-tranics	HPM50111	142	Dec. 27, 2020
3	Log-Bicon Antenna	Schwarzbeck	CBL6141A	4180	Dec. 27, 2020
4	Ultra-Broadband Antenna	ShwarzBeck	BBHA9170	25841	Dec. 27, 2020
5	Loop Antenna	LAPLAC	RF300	9138	Dec. 27, 2020
6	Spectrum Analyzer	Rohde & Schwarz	FSU26	100105	Dec. 27, 2020
7	Horn Antenna	Schwarzbeck	BBHA 9120D	647	Dec. 27, 2020
8	Pre-Amplifier	HP	8447D	1937A03050	Dec. 27, 2020
9	Pre-Amplifier	EMCI	EMC051835	980075	Dec. 27, 2020
10	Antenna Mast	UC	UC3000	N/A	N/A
11	Turn Table	UC	UC3000	N/A	N/A
12	Cable Below 1GHz	Schwarzbeck	AK9515E	33155	Dec. 27, 2020
13	Cable Above 1GHz	Hubersuhner	SUCOFLEX 102	DA1580	Dec. 27, 2020
14	Splitter	Mini-Circuit	ZAPD-4	400059	Dec. 27, 2020
15	RF Connection Cable	HUBER+SUHNER	RE-7-FL	N/A	Dec. 27, 2020
16	RF Connection Cable	Chengdu E-Microwave	---	---	Dec. 27, 2020
17	High pass filter	Compliance	BSU-6	34202	Dec. 27, 2020

CTC Laboratories, Inc.

1-2/F., Building 2, Jiaquan Building, Guanlan High-Tech Park, Shenzhen, Guangdong, China

Tel.: (86)755-27521059

Fax: (86)755-27521011

Http://www.sz-ctc.org.cn

中国国家认证认可监督管理委员会
Certification and Accreditation Administration of the People's Republic of ChinaFor anti-fake verification, please visit the official website of Certification and Accreditation Administration of the People's Republic of China: yz.cnca.cn



		Direction systems			
18	Attenuator	Chengdu E-Microwave	EMCAXX-10 RNZ-3	---	Dec. 27, 2020
19	High and low temperature box	ESPEC	MT3065	12114019	Dec. 27, 2020

Conducted Emission					
Item	Test Equipment	Manufacturer	Model No.	Serial No.	Calibrated until
1	LISN	R&S	ENV216	101112	Dec. 27, 2020
2	LISN	R&S	ENV216	101113	Dec. 27, 2020
3	EMI Test Receiver	R&S	ESCI	100658	Dec. 27, 2020

Note:1. The Cal. Interval was one year.

2. The cable loss has calculated in test result which connection between each test instruments.

3. TEST ITEM AND RESULTS

3.1. Conducted Emission

Limit

FCC CFR Title 47 Part 15 Subpart C Section 15.207/ RSS - Gen 8.8:

Frequency range (MHz)	Limit (dBuV)	
	Quasi-peak	Average
0.15-0.5	66 to 56*	56 to 46*
0.5-5	56	46
5-30	60	50

* Decreases with the logarithm of the frequency.

Test Configuration

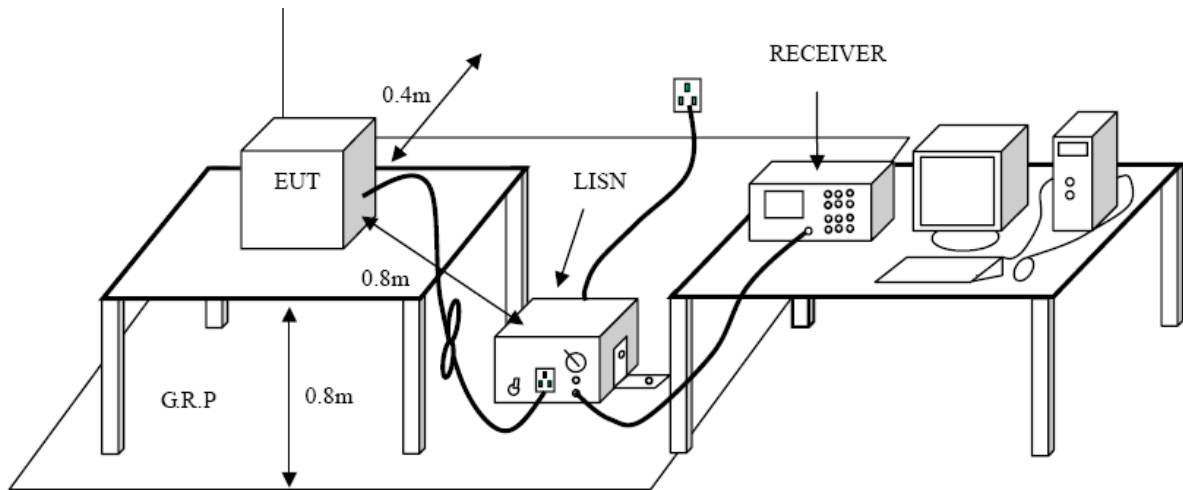

Test Procedure

1. The EUT was setup according to ANSI C63.10:2013 requirements.
2. The EUT was placed on a platform of nominal size, 1 m by 1.5 m, raised 80 cm above the conducting ground plane. The vertical conducting plane was located 40 cm to the rear of the EUT. All other surfaces of EUT were at least 80 cm from any other grounded conducting surface.
3. The EUT and simulators are connected to the main power through a line impedances stabilization network (LISN). The LISN provides a 50ohm /50uH coupling impedance for the measuring equipment. The peripheral devices are also connected to the main power through a LISN. (Please refer to the block diagram of the test setup and photographs)
4. Each current-carrying conductor of the EUT power cord, except the ground (safety) conductor, was individually connected through a LISN to the input power source.
5. The excess length of the power cord between the EUT and the LISN receptacle were folded back and forth at the center of the lead to form a bundle not exceeding 40 cm in length.
6. Conducted Emissions were investigated over the frequency range from 0.15MHz to 30MHz using a receiver bandwidth of 9 kHz.
7. During the above scans, the emissions were maximized by cable manipulation.

**Test Mode:**

Please refer to the clause 2.4.

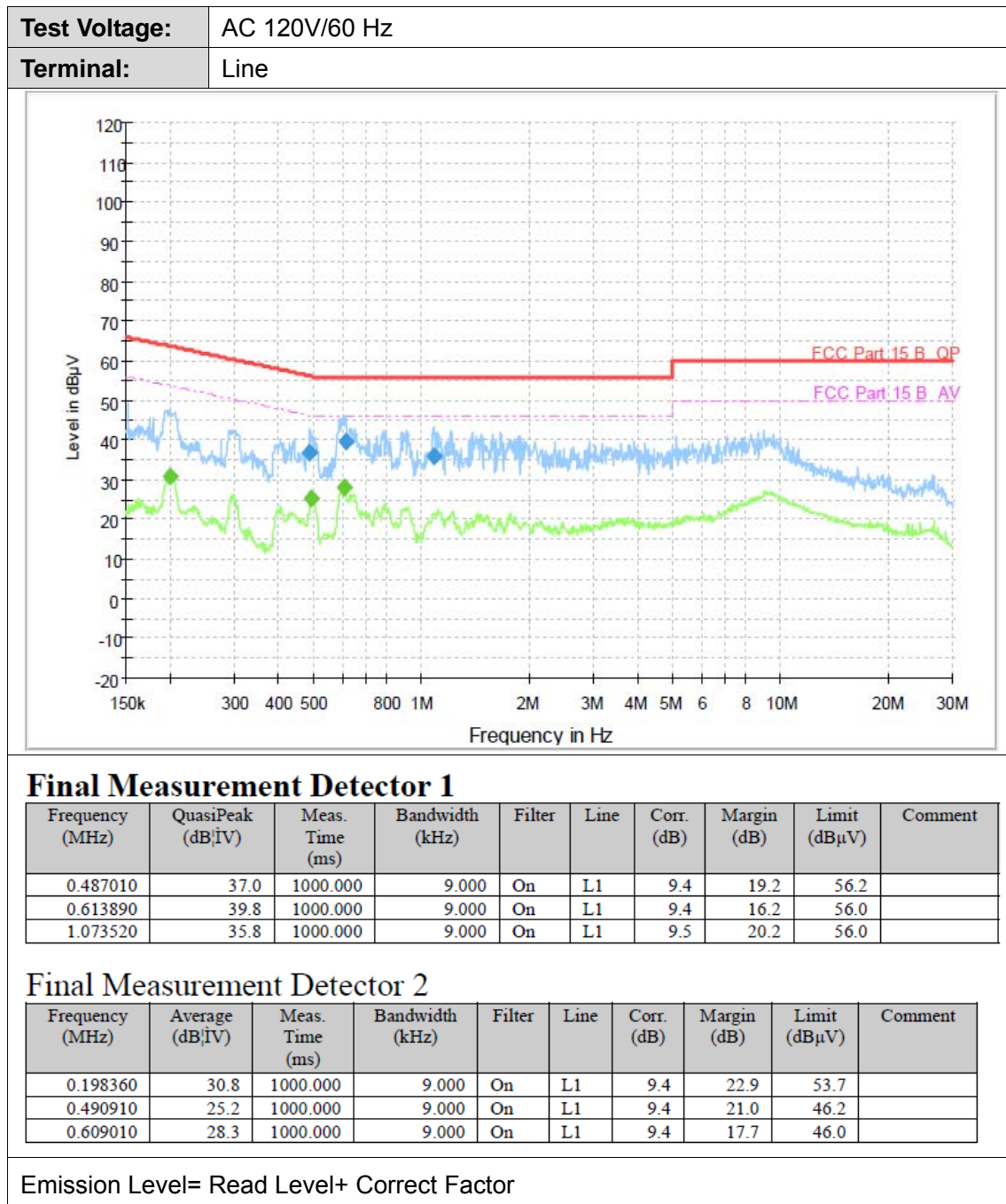
Test Results



Test Voltage:	AC 120V/60 Hz
Terminal:	Neutral

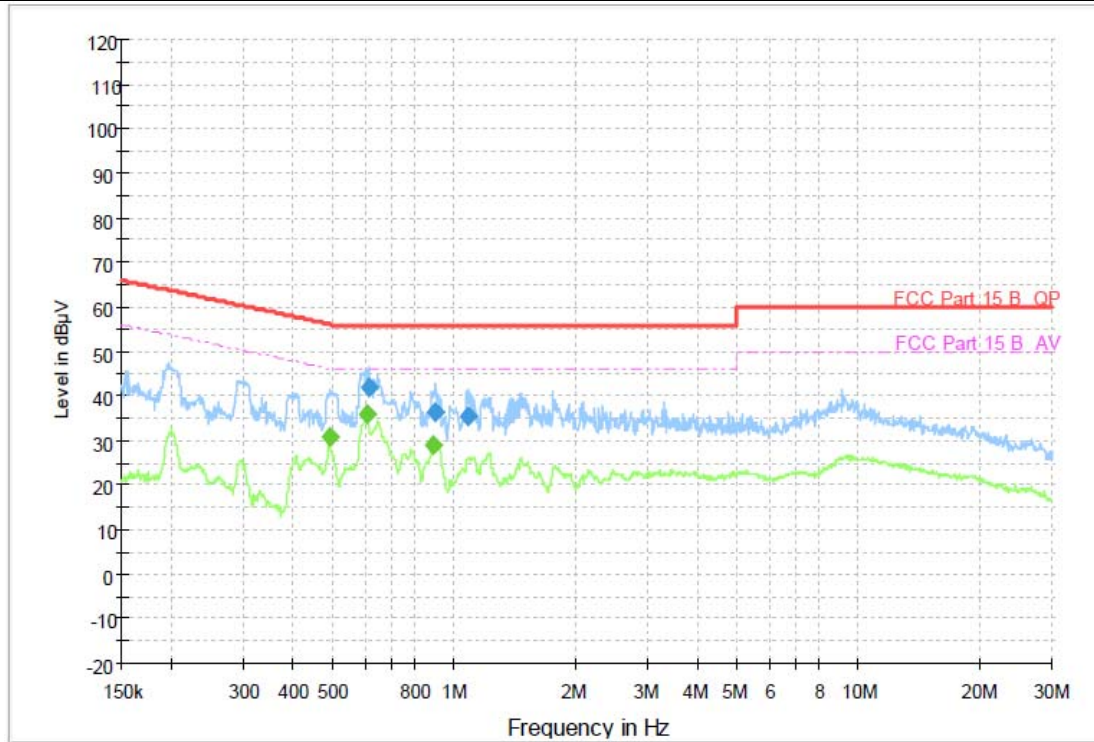

Final Measurement Detector 1

Frequency (MHz)	QuasiPeak (dBµV)	Meas. Time (ms)	Bandwidth (kHz)	Filter	Line	Corr. (dB)	Margin (dB)	Limit (dBµV)	Comment
0.613890	42.0	1000.000	9.000	On	N	9.4	14.0	56.0	
0.897010	36.3	1000.000	9.000	On	N	9.5	19.8	56.0	
1.082130	35.5	1000.000	9.000	On	N	9.5	20.5	56.0	

Final Measurement Detector 2

Frequency (MHz)	Average (dBµV)	Meas. Time (ms)	Bandwidth (kHz)	Filter	Line	Corr. (dB)	Margin (dB)	Limit (dBµV)	Comment
0.490910	30.7	1000.000	9.000	On	N	9.4	15.5	46.2	
0.609010	36.0	1000.000	9.000	On	N	9.4	10.0	46.0	
0.882800	28.9	1000.000	9.000	On	N	9.5	17.1	46.0	

Emission Level= Read Level+ Correct Factor

3.2. Radiated Emission

Limit

FCC CFR Title 47 Part 15 Subpart C Section 15.209/ RSS – Gen 8.9:

Frequency	Limit (dBuV/m @3m)	Value
30 MHz ~ 88 MHz	40.00	Quasi-peak
88 MHz ~ 216 MHz	43.50	Quasi-peak
216 MHz ~ 960 MHz	46.00	Quasi-peak
960 MHz ~ 1 GHz	54.00	Quasi-peak
Above 1 GHz	54.00	Average
	74.00	Peak

Note:

- (1) The tighter limit applies at the band edges.
- (2) Emission Level (dBuV/m)=20log Emission Level (uV/m).

Test Configuration

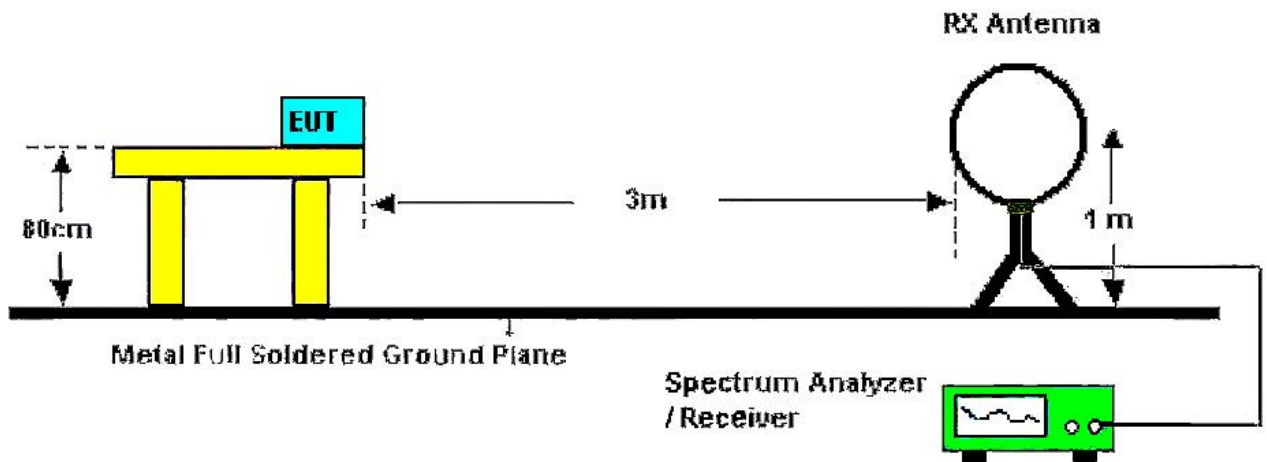

Below 30MHz Test Setup

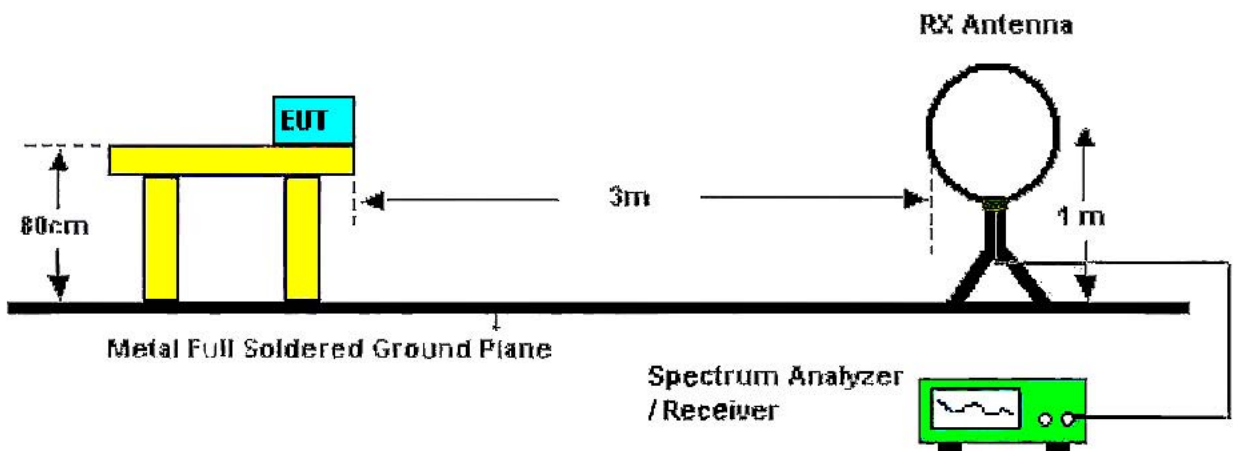

Below 1000MHz Test Setup

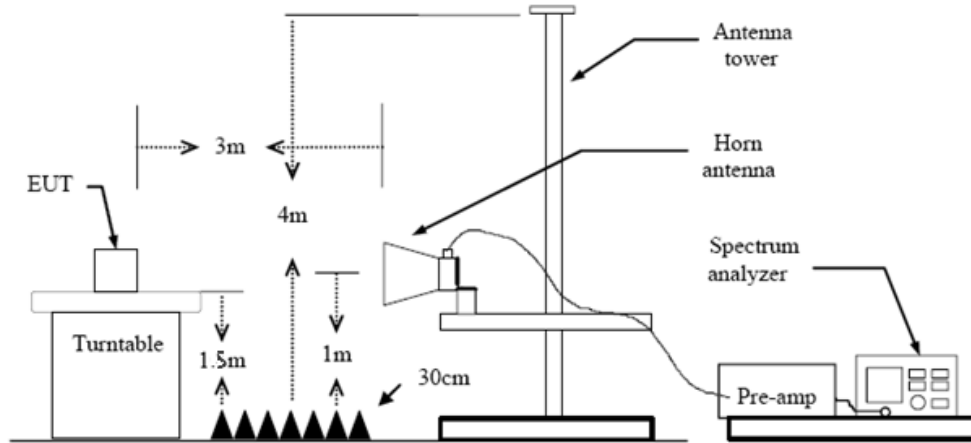

Above 1GHz Test Setup

Test Procedure

1. The EUT was setup and tested according to ANSI C63.10:2013
2. The EUT is placed on a turn table which is 0.8 meter above ground for below 1 GHz, and 1.5 m for above 1 GHz. The turn table is rotated 360 degrees to determine the position of the maximum emission level.
3. The EUT was set 3 meters from the receiving antenna, which was mounted on the top of a variable height antenna tower.
4. For each suspected emission, the EUT was arranged to its worst case and then tune the Antenna tower (from 1 m to 4 m) and turntable (from 0 degree to 360 degrees) to find the maximum reading. A pre-amp and a high pass filter are used for the test in order to get better signal level to comply with the guidelines.
5. Set to the maximum power setting and enable the EUT transmit continuously.
6. Use the following spectrum analyzer settings
 - (1) Span shall wide enough to fully capture the emission being measured;
 - (2) Below 1 GHz:
RBW=120 kHz, VBW=300 kHz, Sweep=auto, Detector function=peak, Trace=max hold;
If the emission level of the EUT measured by the peak detector is 3 dB lower than the applicable limit, the peak emission level will be reported. Otherwise, the emission measurement will be repeated using the quasi-peak detector and reported.
 - (3) From 1 GHz to 10th harmonic:
RBW=1MHz, VBW=3MHz Peak detector for Peak value.
RBW=1MHz, VBW=3MHz RMS detector for Average value.

Test Mode

Please refer to the clause 2.4.

Test Result

9 KHz~30 MHz

From 9 KHz to 30 MHz: Conclusion: PASS

Note: The amplitude of spurious emissions which are attenuated by more than 20dB below the permissible value has no need to be reported.



30MHz-1GHz

Ant. Pol.	Horizontal
Test Mode:	802.11b Mode 2412MHz
Remark:	Only worse case is reported

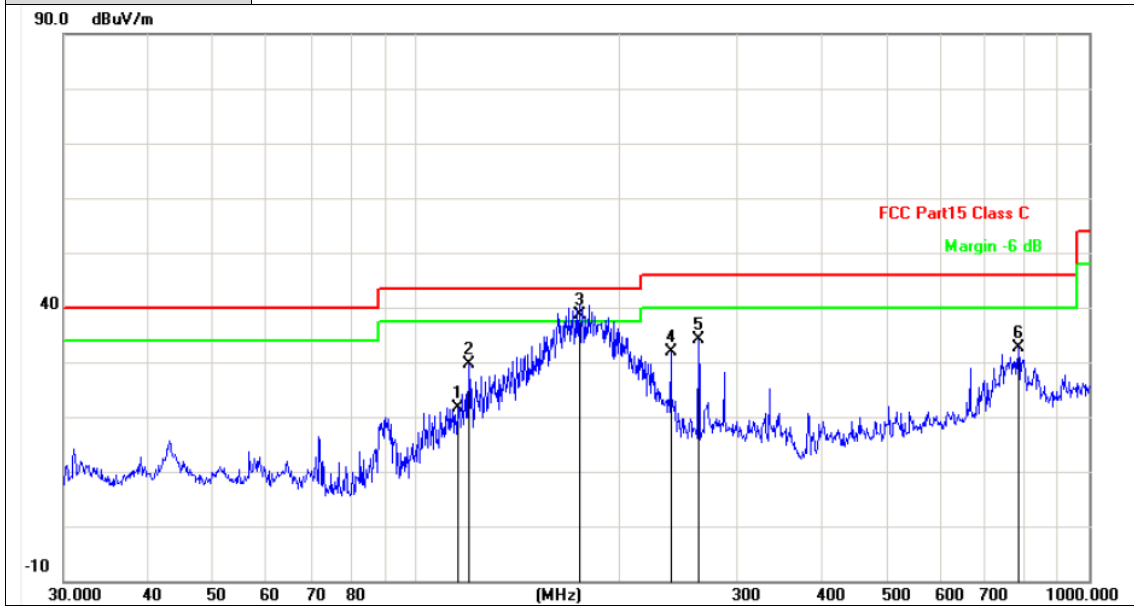

No.	Frequency (MHz)	Factor (dB/m)	Reading (dBuV)	Level (dBuV/m)	Limit (dBuV/m)	Margin (dB)	Detector
1	115.3205	-20.50	42.24	21.74	43.50	-21.76	QP
2	119.8556	-20.06	49.59	29.53	43.50	-13.97	QP
3	175.0368	-19.50	58.08	38.58	43.50	-4.92	QP
4	239.1473	-19.88	51.81	31.93	46.00	-14.07	QP
5	262.8955	-19.01	53.04	34.03	46.00	-11.97	QP
6	785.0935	-7.69	40.22	32.53	46.00	-13.47	QP

Remarks:

- 1. Factor (dB/m) = Antenna Factor (dB/m)+Cable Factor (dB)-Pre-amplifier Factor
- 2. Margin value = Level -Limit value



Ant. Pol.	Vertical
Test Mode:	802.11b Mode 2412MHz
Remark:	Only worse case is reported

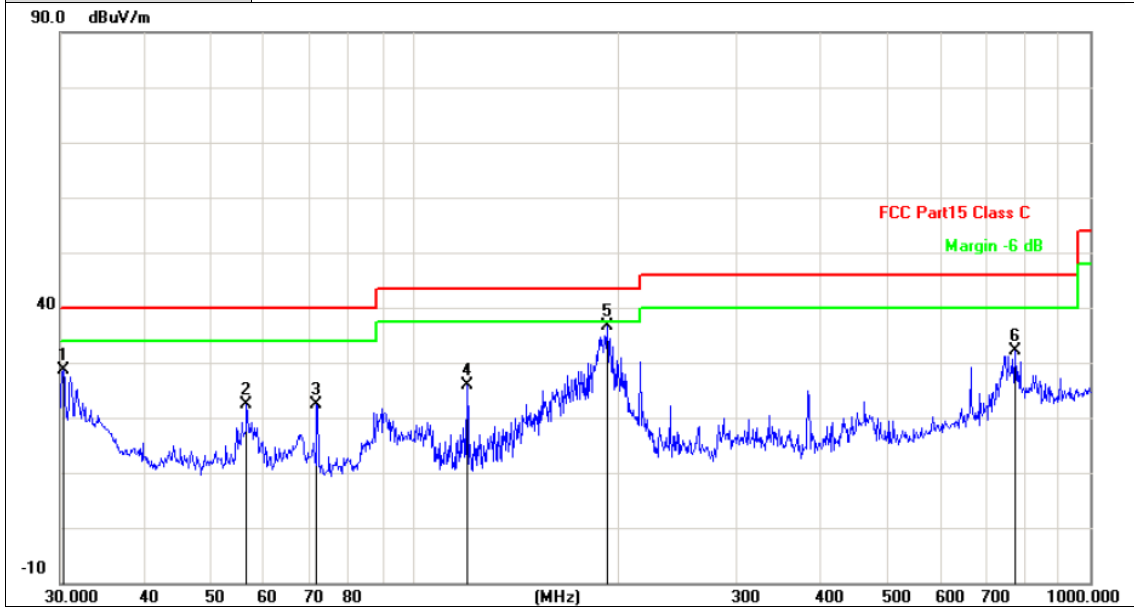

No.	Frequency (MHz)	Factor (dB/m)	Reading (dBuV)	Level (dBuV/m)	Limit (dBuV/m)	Margin (dB)	Detector
1	30.3172	-19.44	47.98	28.54	40.00	-11.46	QP
2	56.5929	-18.97	41.47	22.50	40.00	-17.50	QP
3	71.8320	-20.91	43.32	22.41	40.00	-17.59	QP
4	119.8556	-20.06	45.85	25.79	43.50	-17.71	QP
5	193.0944	-20.97	57.71	36.74	43.50	-6.76	QP
6	774.1584	-7.77	39.90	32.13	46.00	-13.87	QP

Remarks:
 1. Factor (dB/m) = Antenna Factor (dB/m)+Cable Factor (dB)-Pre-amplifier Factor
 2. Margin value = Level -Limit value



Adobe 1GHz

Ant. Pol.	Horizontal
Test Mode:	TX B Mode 2412MHz
Remark:	No report for the emission which more than 10 dB below the prescribed limit.

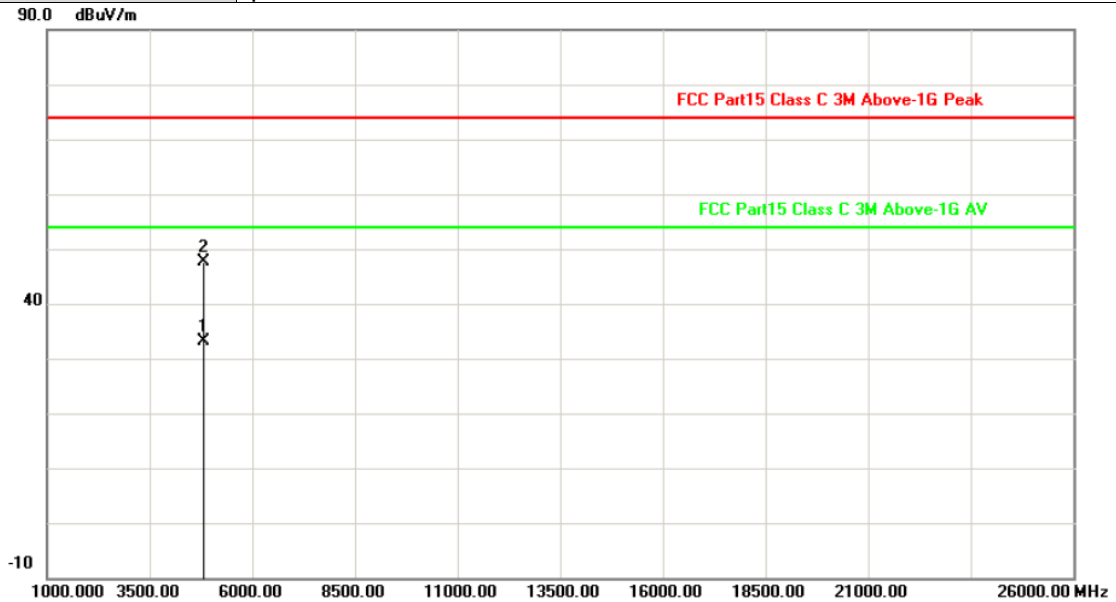

No.	Frequency (MHz)	Factor (dB/m)	Reading (dBuV)	Level (dBuV/m)	Limit (dBuV/m)	Margin (dB)	Detector
1	4824.070	-2.76	35.90	33.14	54.00	-20.86	AVG
2	4824.486	-2.76	50.39	47.63	74.00	-26.37	peak

Remarks:

1. Factor (dB/m) = Antenna Factor (dB/m)+Cable Factor (dB)-Pre-amplifier Factor
2. Margin value = Level -Limit value



Ant. Pol.	Vertical
Test Mode:	TX B Mode 2412MHz
Remark:	No report for the emission which more than 10 dB below the prescribed limit.

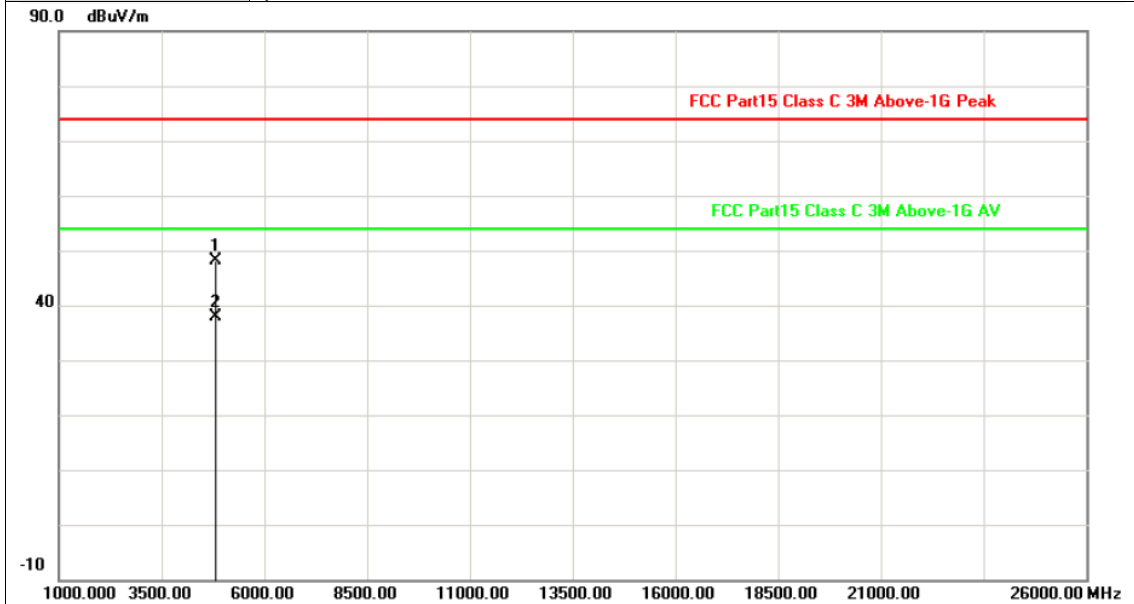

No.	Frequency (MHz)	Factor (dB/m)	Reading (dBuV)	Level (dBuV/m)	Limit (dBuV/m)	Margin (dB)	Detector
1	4824.000	-2.76	50.94	48.18	74.00	-25.82	peak
2	4824.090	-2.76	40.62	37.86	54.00	-16.14	AVG

Remarks:
 1. Factor (dB/m) = Antenna Factor (dB/m)+Cable Factor (dB)-Pre-amplifier Factor
 2. Margin value = Level -Limit value



Ant. Pol.	Horizontal
Test Mode:	TX B Mode 2437MHz
Remark:	No report for the emission which more than 10 dB below the prescribed limit.

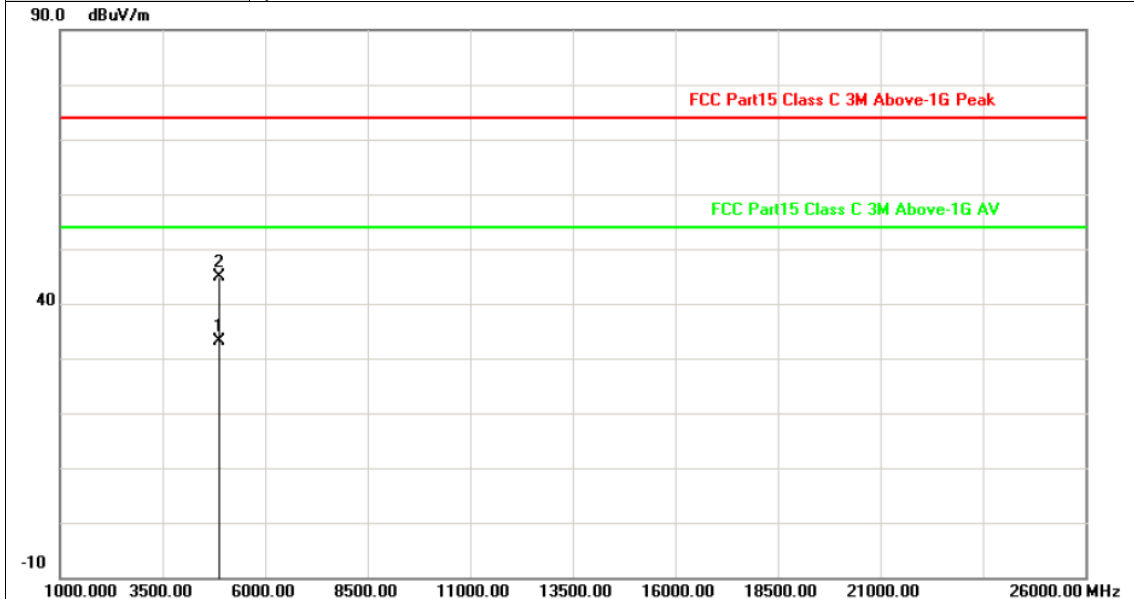

No.	Frequency (MHz)	Factor (dB/m)	Reading (dBuV)	Level (dBuV/m)	Limit (dBuV/m)	Margin (dB)	Detector
1	4874.010	-2.61	35.76	33.15	54.00	-20.85	AVG
2	4874.246	-2.61	47.57	44.96	74.00	-29.04	peak

Remarks:
 1. Factor (dB/m) = Antenna Factor (dB/m)+Cable Factor (dB)-Pre-amplifier Factor
 2. Margin value = Level -Limit value



Ant. Pol.	Vertical
Test Mode:	TX B Mode 2437MHz
Remark:	No report for the emission which more than 10 dB below the prescribed limit.

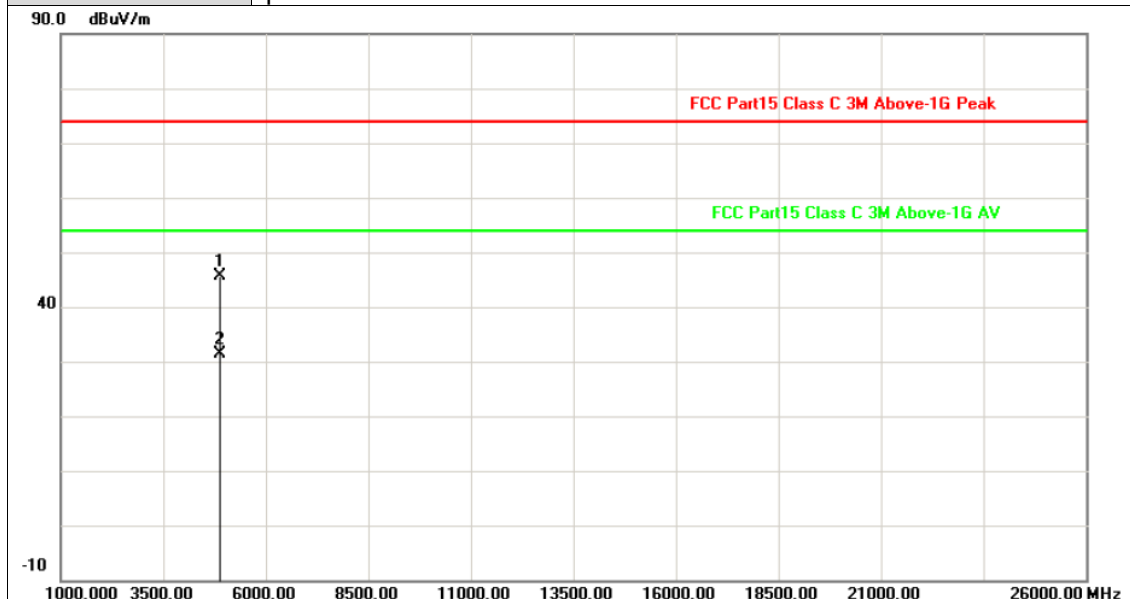

No.	Frequency (MHz)	Factor (dB/m)	Reading (dBuV)	Level (dBuV/m)	Limit (dBuV/m)	Margin (dB)	Detector
1	4873.778	-2.61	48.28	45.67	74.00	-28.33	peak
2	4874.556	-2.61	33.89	31.28	54.00	-22.72	AVG

Remarks:
 1. Factor (dB/m) = Antenna Factor (dB/m)+Cable Factor (dB)-Pre-amplifier Factor
 2. Margin value = Level -Limit value



Ant. Pol.	Horizontal
Test Mode:	TX B Mode 2462MHz
Remark:	No report for the emission which more than 10 dB below the prescribed limit.

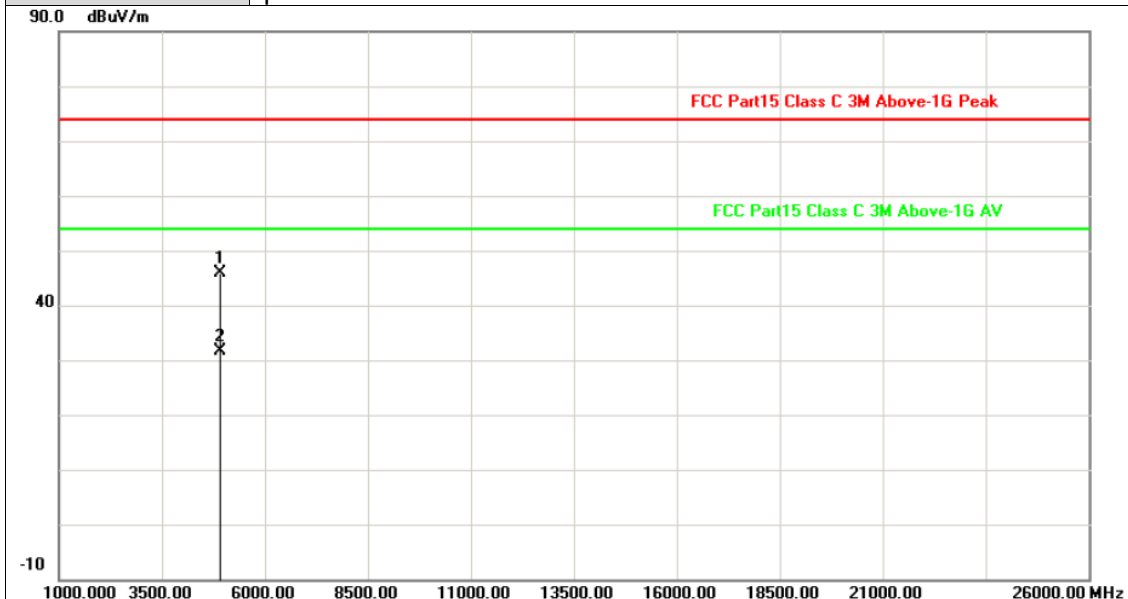

No.	Frequency (MHz)	Factor (dB/m)	Reading (dBuV)	Level (dBuV/m)	Limit (dBuV/m)	Margin (dB)	Detector
1	4923.246	-2.47	48.36	45.89	74.00	-28.11	peak
2	4924.638	-2.47	34.18	31.71	54.00	-22.29	AVG

Remarks:
 1. Factor (dB/m) = Antenna Factor (dB/m)+Cable Factor (dB)-Pre-amplifier Factor
 2. Margin value = Level -Limit value



Ant. Pol.	Vertical
Test Mode:	TX B Mode 2462MHz
Remark:	No report for the emission which more than 10 dB below the prescribed limit.

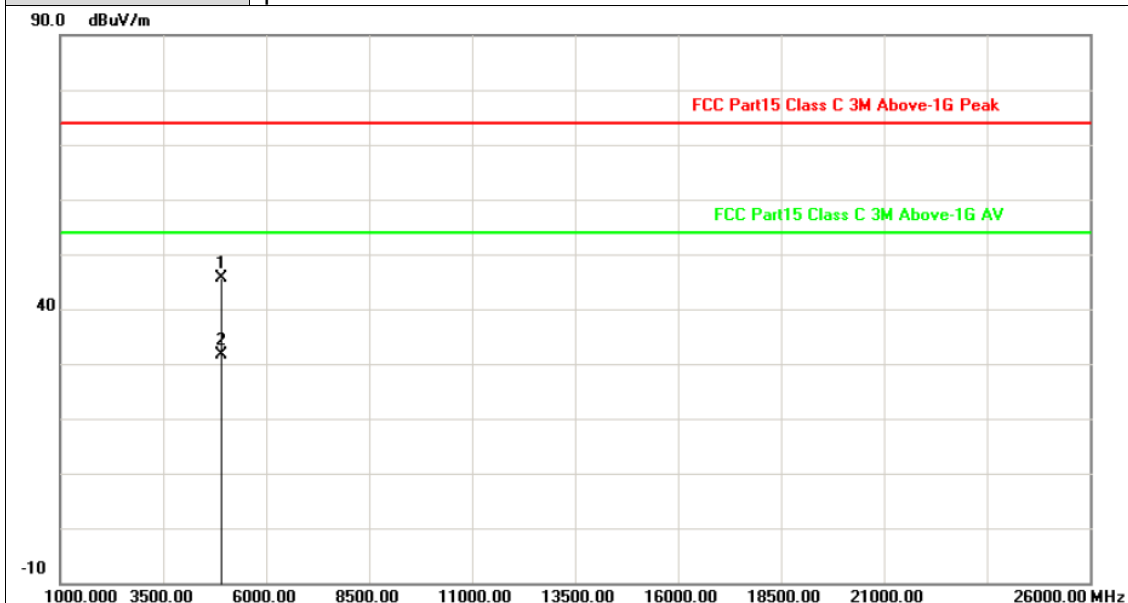

No.	Frequency (MHz)	Factor (dB/m)	Reading (dBuV)	Level (dBuV/m)	Limit (dBuV/m)	Margin (dB)	Detector
1	4923.910	-2.47	48.16	45.69	74.00	-28.31	peak
2	4924.938	-2.47	34.19	31.72	54.00	-22.28	AVG

Remarks:
 1. Factor (dB/m) = Antenna Factor (dB/m)+Cable Factor (dB)-Pre-amplifier Factor
 2. Margin value = Level -Limit value



Ant. Pol.	Horizontal
Test Mode:	TX G Mode 2412MHz
Remark:	No report for the emission which more than 10 dB below the prescribed limit.

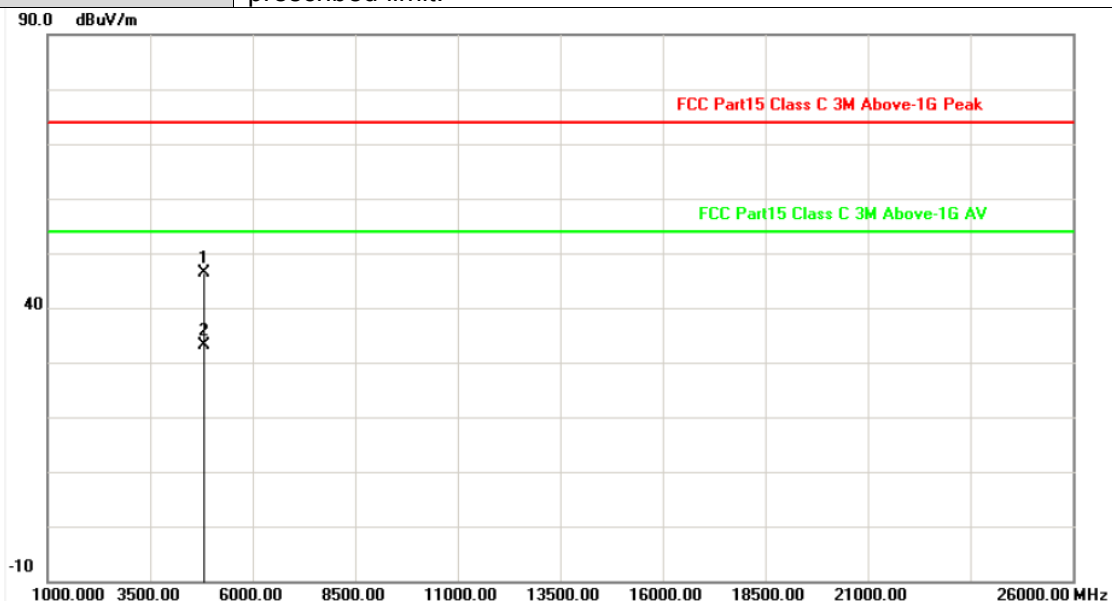

No.	Frequency (MHz)	Factor (dB/m)	Reading (dBuV)	Level (dBuV/m)	Limit (dBuV/m)	Margin (dB)	Detector
1	4823.672	-2.76	49.15	46.39	74.00	-27.61	peak
2	4824.112	-2.76	35.81	33.05	54.00	-20.95	AVG

Remarks:

- 1. Factor (dB/m) = Antenna Factor (dB/m)+Cable Factor (dB)-Pre-amplifier Factor
- 2. Margin value = Level -Limit value





Ant. Pol.	Vertical
Test Mode:	TX G Mode 2412MHz
Remark:	No report for the emission which more than 10 dB below the prescribed limit.

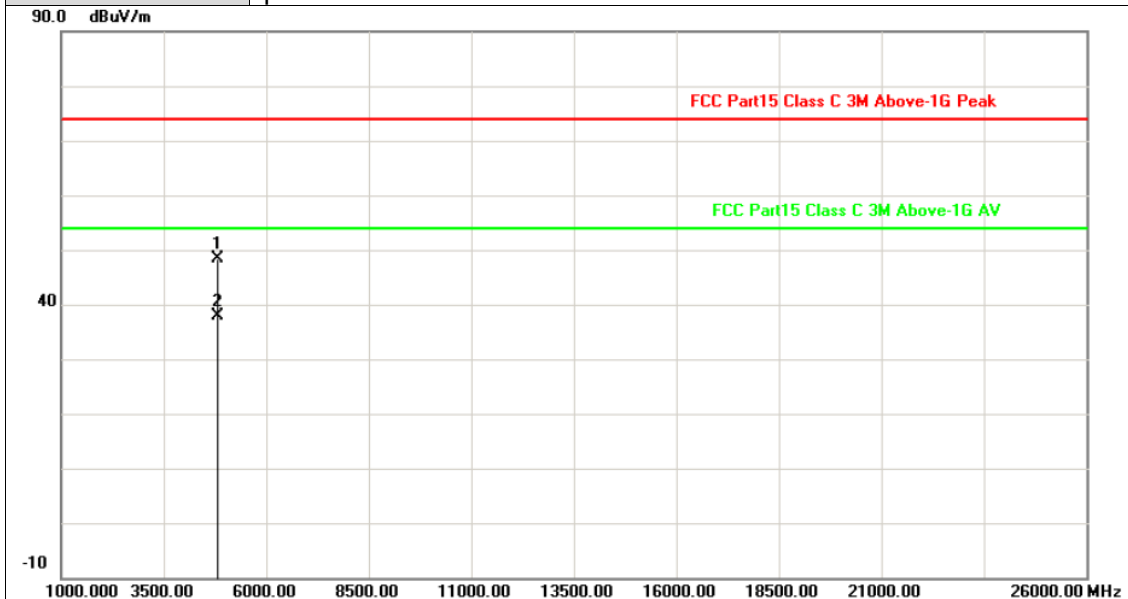

No.	Frequency (MHz)	Factor (dB/m)	Reading (dBuV)	Level (dBuV/m)	Limit (dBuV/m)	Margin (dB)	Detector
1	4823.966	-2.76	51.19	48.43	74.00	-25.57	peak
2	4824.090	-2.76	40.64	37.88	54.00	-16.12	AVG

Remarks:
 1. Factor (dB/m) = Antenna Factor (dB/m)+Cable Factor (dB)-Pre-amplifier Factor
 2. Margin value = Level -Limit value



Ant. Pol.	Horizontal
Test Mode:	TX G Mode 2437MHz
Remark:	No report for the emission which more than 10 dB below the prescribed limit.

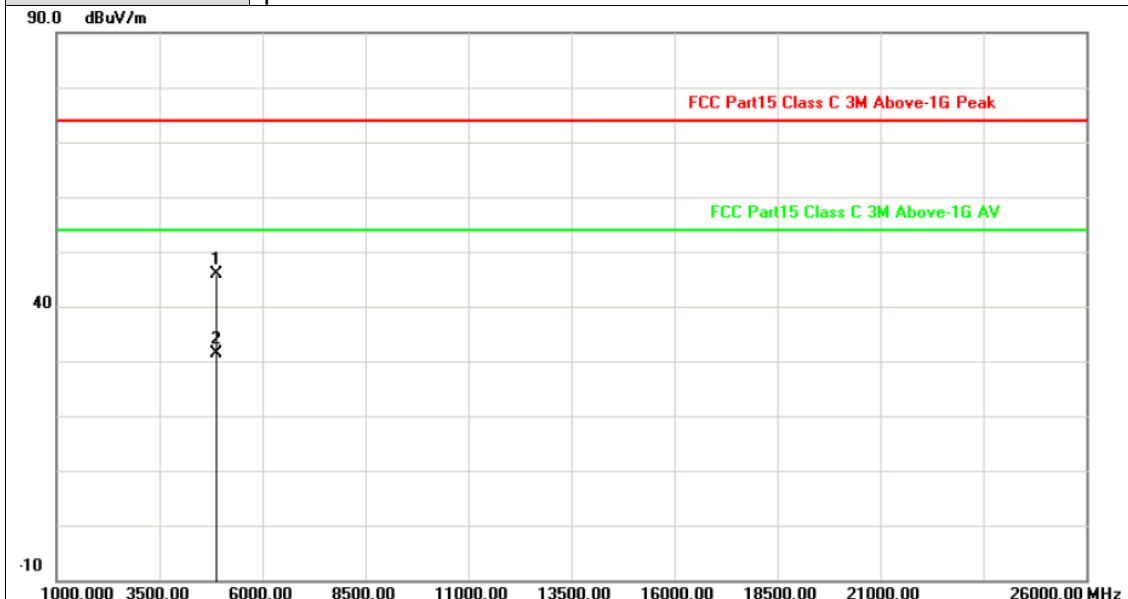

No.	Frequency (MHz)	Factor (dB/m)	Reading (dBuV)	Level (dBuV/m)	Limit (dBuV/m)	Margin (dB)	Detector
1	4874.122	-2.61	48.40	45.79	74.00	-28.21	peak
2	4874.858	-2.61	33.90	31.29	54.00	-22.71	AVG

Remarks:
 1. Factor (dB/m) = Antenna Factor (dB/m)+Cable Factor (dB)-Pre-amplifier Factor
 2. Margin value = Level -Limit value



Ant. Pol.	Vertical
Test Mode:	TX G Mode 2437MHz
Remark:	No report for the emission which more than 10 dB below the prescribed limit.

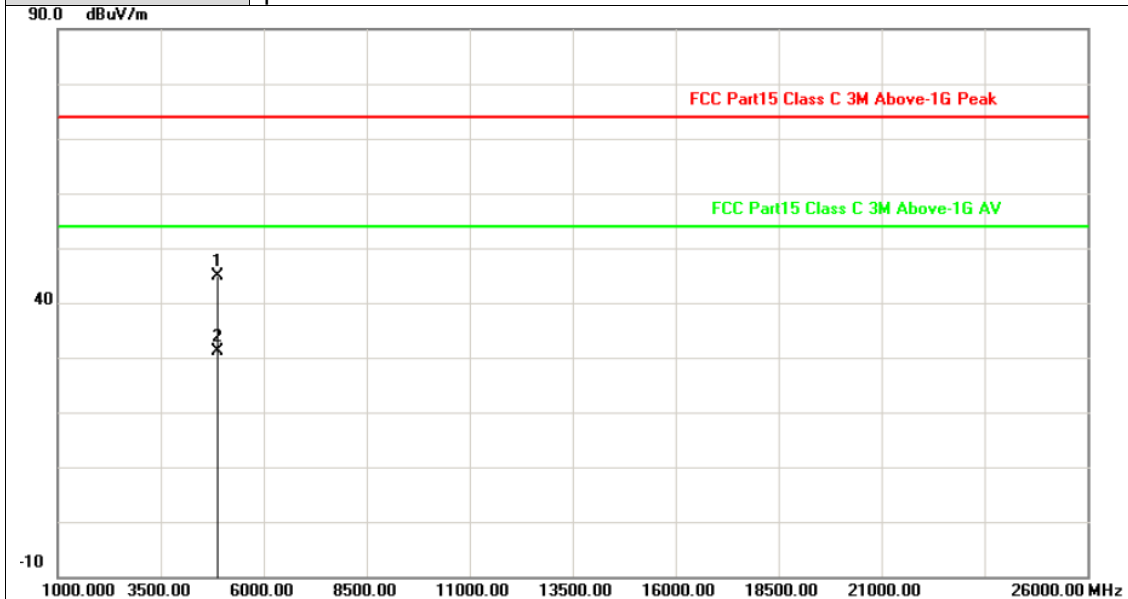

No.	Frequency (MHz)	Factor (dB/m)	Reading (dBuV)	Level (dBuV/m)	Limit (dBuV/m)	Margin (dB)	Detector
1	4873.602	-2.61	47.54	44.93	74.00	-29.07	peak
2	4873.908	-2.61	33.68	31.07	54.00	-22.93	AVG

Remarks:
 1. Factor (dB/m) = Antenna Factor (dB/m)+Cable Factor (dB)-Pre-amplifier Factor
 2. Margin value = Level -Limit value



Ant. Pol.	Horizontal
Test Mode:	TX G Mode 2462MHz
Remark:	No report for the emission which more than 10 dB below the prescribed limit.

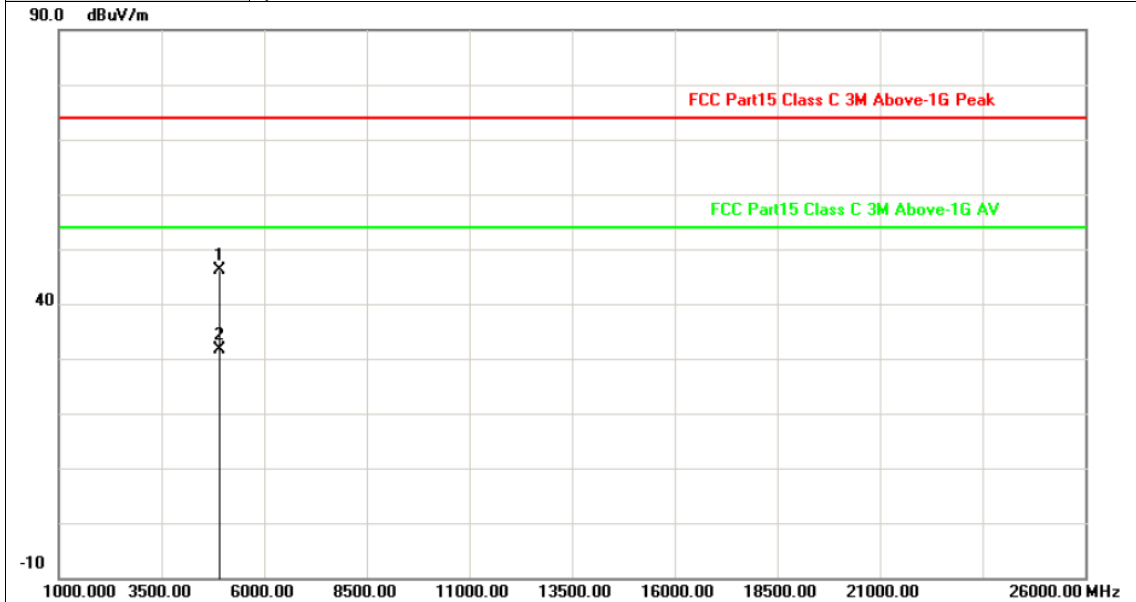

No.	Frequency (MHz)	Factor (dB/m)	Reading (dBuV)	Level (dBuV/m)	Limit (dBuV/m)	Margin (dB)	Detector
1	4923.026	-2.47	48.72	46.25	74.00	-27.75	peak
2	4924.980	-2.47	34.16	31.69	54.00	-22.31	AVG

Remarks:
 1. Factor (dB/m) = Antenna Factor (dB/m)+Cable Factor (dB)-Pre-amplifier Factor
 2. Margin value = Level -Limit value



Ant. Pol.	Vertical
Test Mode:	TX G Mode 2462MHz
Remark:	No report for the emission which more than 10 dB below the prescribed limit.

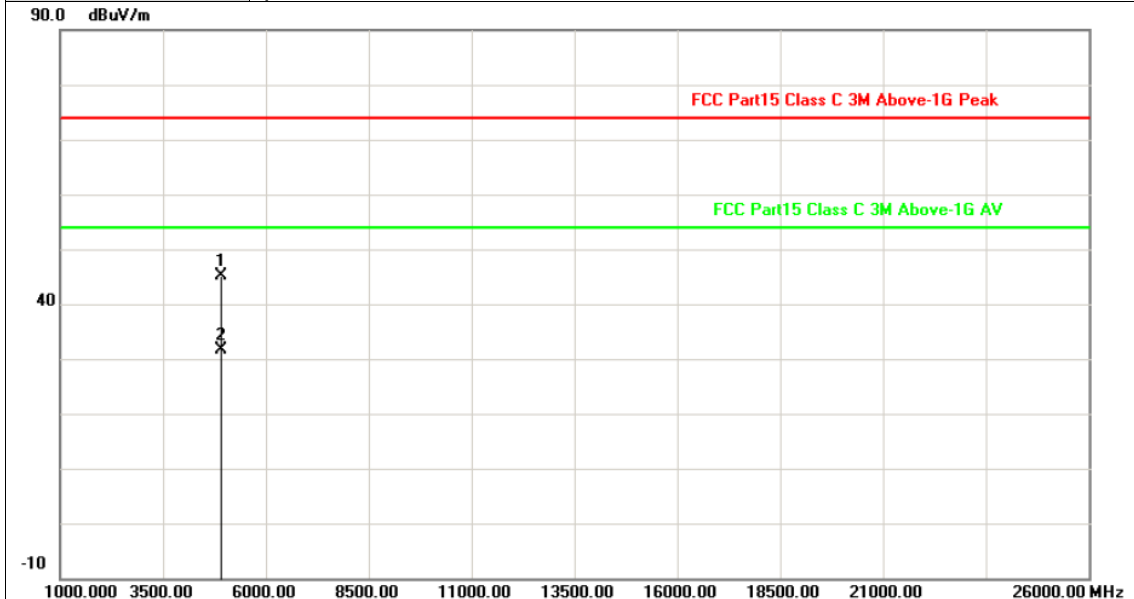

No.	Frequency (MHz)	Factor (dB/m)	Reading (dBuV)	Level (dBuV/m)	Limit (dBuV/m)	Margin (dB)	Detector
1	4923.712	-2.47	47.71	45.24	74.00	-28.76	peak
2	4924.736	-2.47	33.99	31.52	54.00	-22.48	AVG

Remarks:
 1. Factor (dB/m) = Antenna Factor (dB/m)+Cable Factor (dB)-Pre-amplifier Factor
 2. Margin value = Level -Limit value



Ant. Pol.	Horizontal
Test Mode:	TX N20 Mode 2412MHz
Remark:	No report for the emission which more than 10 dB below the prescribed limit.

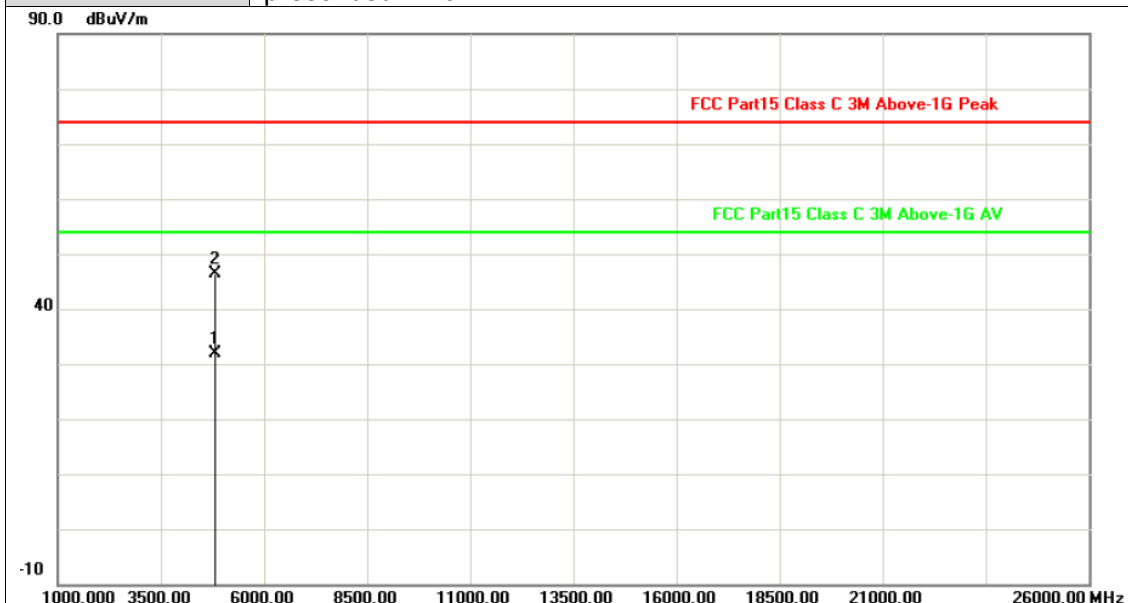

No.	Frequency (MHz)	Factor (dB/m)	Reading (dBuV)	Level (dBuV/m)	Limit (dBuV/m)	Margin (dB)	Detector
1	4824.070	-2.76	34.75	31.99	54.00	-22.01	AVG
2	4824.816	-2.76	49.05	46.29	74.00	-27.71	peak

Remarks:

- Factor (dB/m) = Antenna Factor (dB/m)+Cable Factor (dB)-Pre-amplifier Factor
- Margin value = Level -Limit value



Ant. Pol.	Vertical
Test Mode:	TX N20 Mode 2412MHz
Remark:	No report for the emission which more than 10 dB below the prescribed limit.

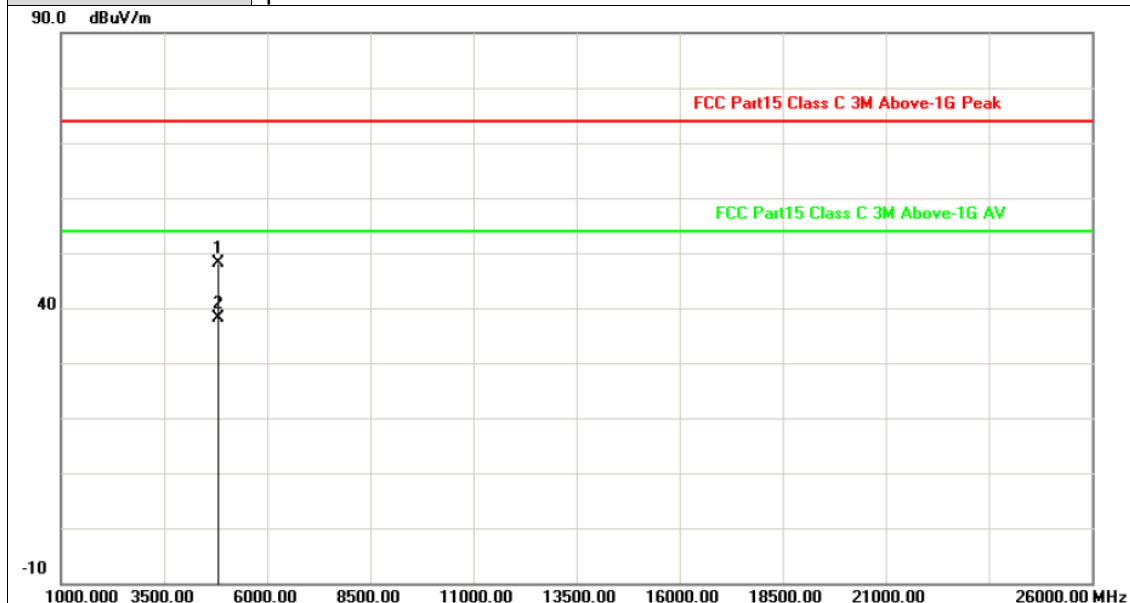

No.	Frequency (MHz)	Factor (dB/m)	Reading (dBuV)	Level (dBuV/m)	Limit (dBuV/m)	Margin (dB)	Detector
1	4823.972	-2.76	50.84	48.08	74.00	-25.92	peak
2	4824.092	-2.76	40.79	38.03	54.00	-15.97	AVG

Remarks:
 1. Factor (dB/m) = Antenna Factor (dB/m)+Cable Factor (dB)-Pre-amplifier Factor
 2. Margin value = Level -Limit value



Ant. Pol.	Horizontal
Test Mode:	TX N20 Mode 2437MHz
Remark:	No report for the emission which more than 10 dB below the prescribed limit.

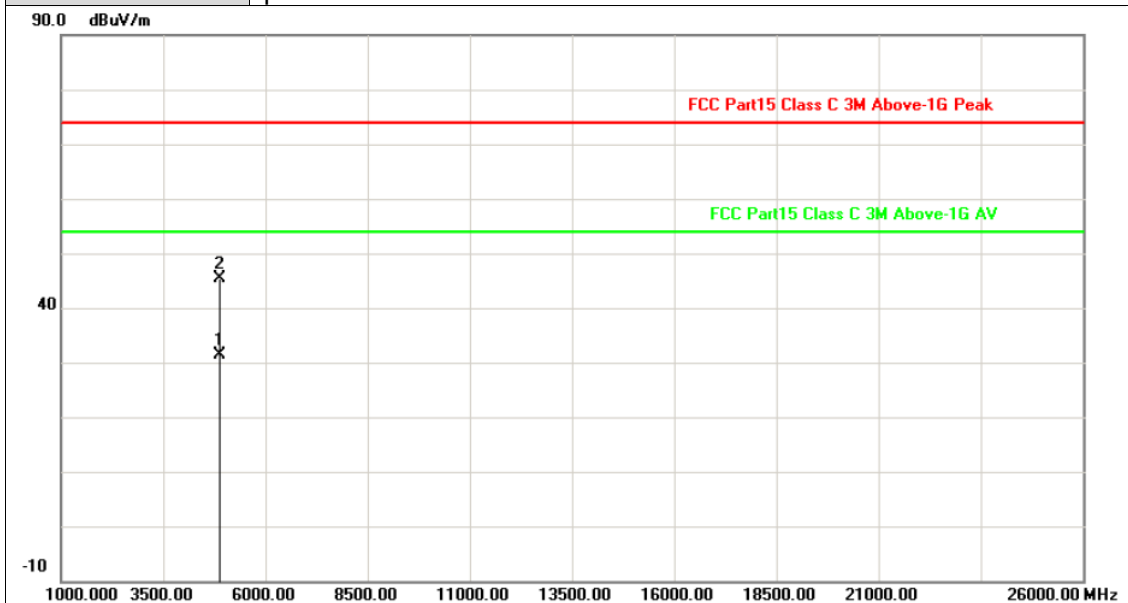

No.	Frequency (MHz)	Factor (dB/m)	Reading (dBuV)	Level (dBuV/m)	Limit (dBuV/m)	Margin (dB)	Detector
1	4873.322	-2.61	33.88	31.27	54.00	-22.73	AVG
2	4874.668	-2.61	47.95	45.34	74.00	-28.66	peak

Remarks:
 1. Factor (dB/m) = Antenna Factor (dB/m)+Cable Factor (dB)-Pre-amplifier Factor
 2. Margin value = Level -Limit value



Ant. Pol.	Vertical
Test Mode:	TX N20 Mode 2437MHz
Remark:	No report for the emission which more than 10 dB below the prescribed limit.

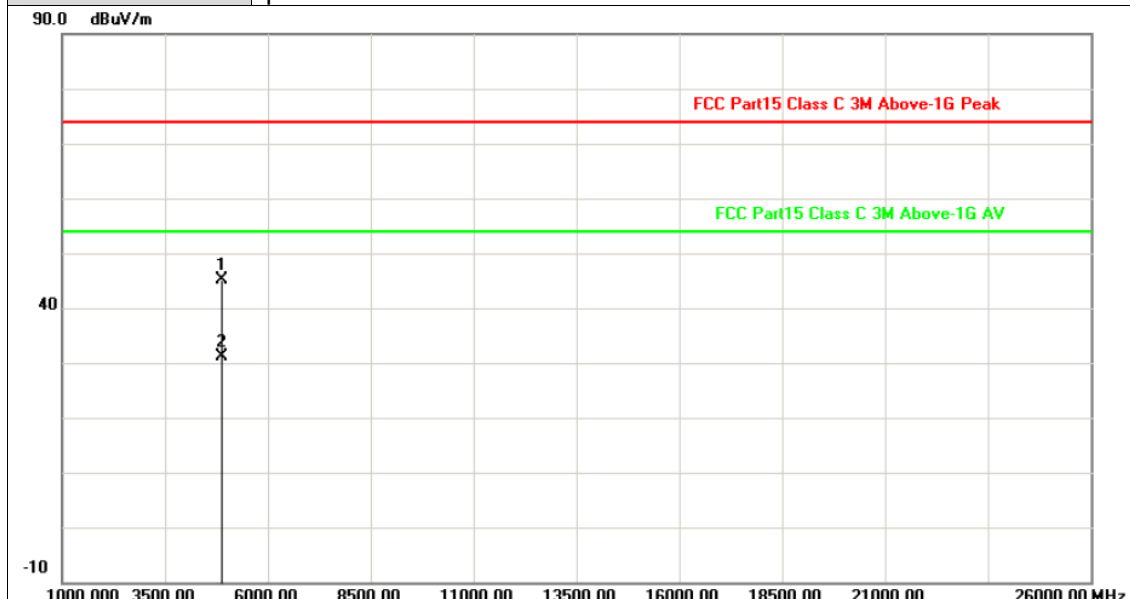

No.	Frequency (MHz)	Factor (dB/m)	Reading (dBuV)	Level (dBuV/m)	Limit (dBuV/m)	Margin (dB)	Detector
1	4873.558	-2.61	47.82	45.21	74.00	-28.79	peak
2	4874.878	-2.61	33.68	31.07	54.00	-22.93	AVG

Remarks:

- Factor (dB/m) = Antenna Factor (dB/m)+Cable Factor (dB)-Pre-amplifier Factor
- Margin value = Level -Limit value



Ant. Pol.	Horizontal
Test Mode:	TX N20 Mode 2462MHz
Remark:	No report for the emission which more than 10 dB below the prescribed limit.

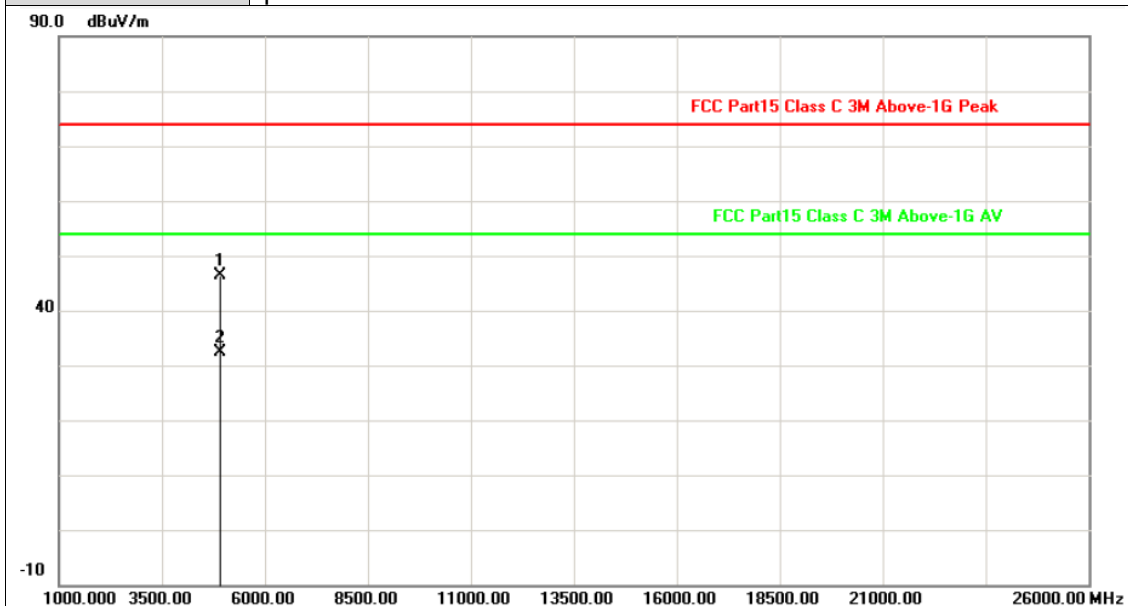

No.	Frequency (MHz)	Factor (dB/m)	Reading (dBuV)	Level (dBuV/m)	Limit (dBuV/m)	Margin (dB)	Detector
1	4924.036	-2.47	48.87	46.40	74.00	-27.60	peak
2	4924.334	-2.47	34.87	32.40	54.00	-21.60	AVG

Remarks:
 1. Factor (dB/m) = Antenna Factor (dB/m)+Cable Factor (dB)-Pre-amplifier Factor
 2. Margin value = Level -Limit value



Ant. Pol.	Vertical
Test Mode:	TX N20 Mode 2462MHz
Remark:	No report for the emission which more than 10 dB below the prescribed limit.

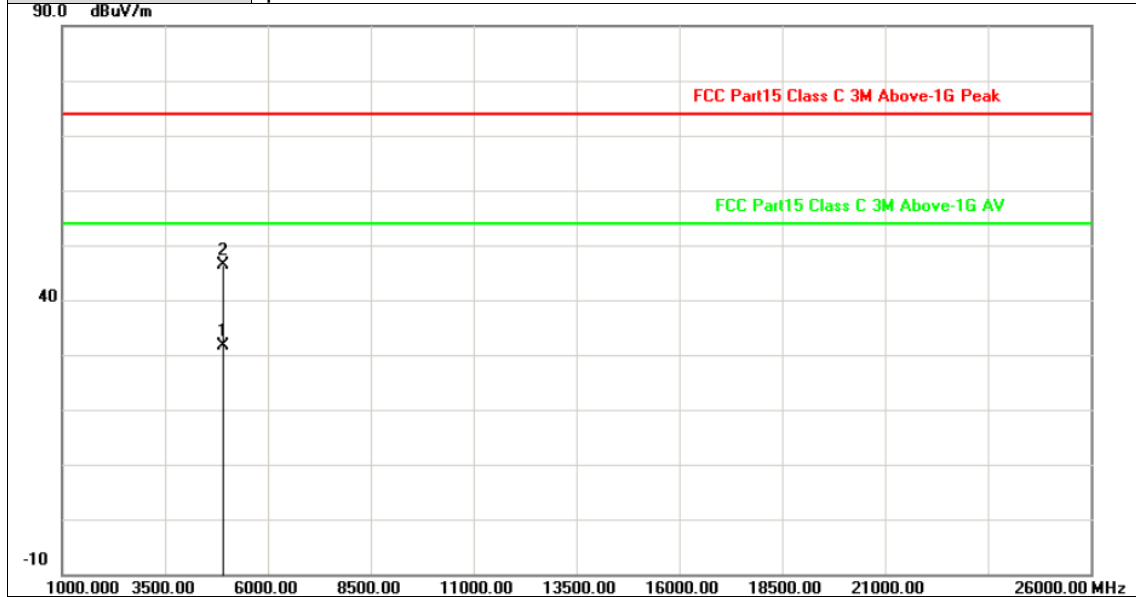

No.	Frequency (MHz)	Factor (dB/m)	Reading (dBuV)	Level (dBuV/m)	Limit (dBuV/m)	Margin (dB)	Detector
1	4924.354	-2.47	34.00	31.53	54.00	-22.47	AVG
2	4924.632	-2.47	48.76	46.29	74.00	-27.71	peak

Remarks:

- 1. Factor (dB/m) = Antenna Factor (dB/m)+Cable Factor (dB)-Pre-amplifier Factor
- 2. Margin value = Level -Limit value

3.3. Band Edge Emissions

Limit

FCC CFR Title 47 Part 15 Subpart C Section 15.247 (d)/ RSS 247 5.5:

Restricted Frequency Band (MHz)	(dBuV/m)(at 3m)	
	Peak	Average
2310 ~2390	74	54
2483.5 ~2500	74	54

Conducted band edge limit: The highest point of the operating frequency waveform down 20dB

Test Configuration

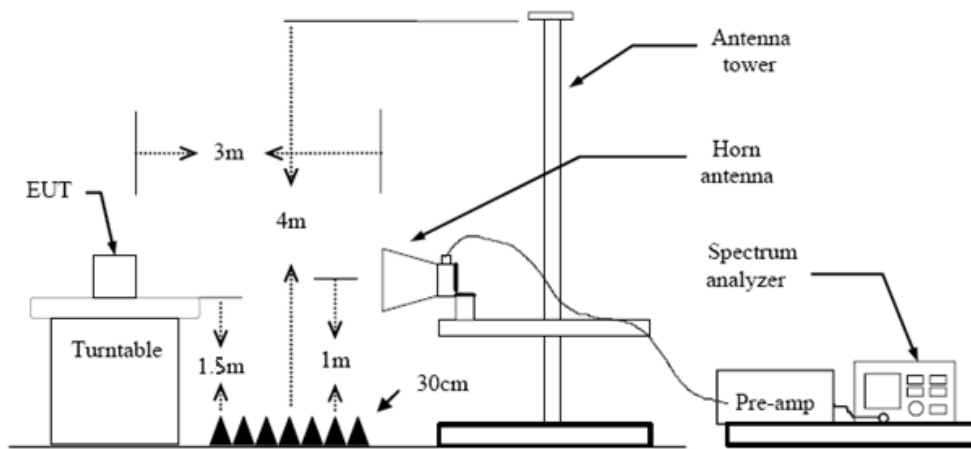

Test Procedure

1. The EUT was setup and tested according to ANSI C63.10:2013 requirements.
2. The EUT is placed on a turn table which is 1.5 meter above ground. The turn table is rotated 360 degrees to determine the position of the maximum emission level.
3. The EUT was positioned such that the distance from antenna to the EUT was 3 meters.
4. The antenna is scanned from 1 meter to 4 meters to find out the maximum emission level. This is repeated for both horizontal and vertical polarization of the antenna. In order to find the maximum emission, all of the interface cables were manipulated according to ANSI C63.10:2013 on radiated measurement.
5. The receiver set as follow:
 RBW=1MHz, VBW=3MHz Peak detector for Peak value.
 RBW=1MHz, VBW see note 1 with Peak Detector for Average Value.

Note 1: For measurements above 1 GHz the resolution bandwidth is set to 1 MHz, then the video bandwidth is set to 3 MHz for peak measurements and 1 MHz resolution bandwidth with 1/T video bandwidth with peak detector for average measurements. For the Duty Cycle please refer to clause 3.7 Duty Cycle.

2: Duty Cycle > 98%, VBW=10Hz.

Test Mode

Please refer to the clause 2.4.

Test Results



(1) Radiation Test

Ant. Pol.	Horizontal																														
Test Mode:	B Mode 2412MHz																														
<table border="1"> <thead> <tr> <th>No.</th> <th>Frequency (MHz)</th> <th>Factor (dB/m)</th> <th>Reading (dBuV)</th> <th>Level (dBuV/m)</th> <th>Limit (dBuV/m)</th> <th>Margin (dB)</th> <th>Detector</th> </tr> </thead> <tbody> <tr> <td>1</td> <td>2390.000</td> <td>31.10</td> <td>19.48</td> <td>50.58</td> <td>74.00</td> <td>-23.42</td> <td>peak</td> </tr> <tr> <td>2</td> <td>2390.000</td> <td>31.10</td> <td>9.74</td> <td>40.84</td> <td>54.00</td> <td>-13.16</td> <td>AVG</td> </tr> </tbody> </table>								No.	Frequency (MHz)	Factor (dB/m)	Reading (dBuV)	Level (dBuV/m)	Limit (dBuV/m)	Margin (dB)	Detector	1	2390.000	31.10	19.48	50.58	74.00	-23.42	peak	2	2390.000	31.10	9.74	40.84	54.00	-13.16	AVG
No.	Frequency (MHz)	Factor (dB/m)	Reading (dBuV)	Level (dBuV/m)	Limit (dBuV/m)	Margin (dB)	Detector																								
1	2390.000	31.10	19.48	50.58	74.00	-23.42	peak																								
2	2390.000	31.10	9.74	40.84	54.00	-13.16	AVG																								
<p>Remarks:</p> <p>1. Factor (dB/m) = Antenna Factor (dB/m)+Cable Factor (dB)-Pre-amplifier Factor</p> <p>2. Margin value = Level -Limit value</p>																															



Ant. Pol.	Vertical
Test Mode:	B Mode 2412MHz

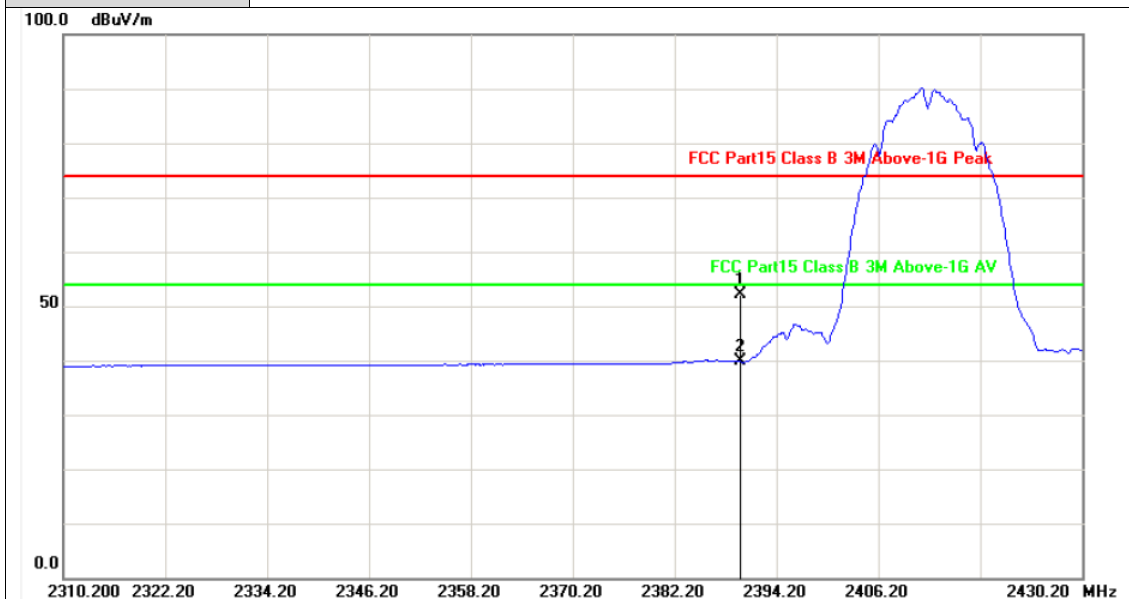

No.	Frequency (MHz)	Factor (dB/m)	Reading (dBuV)	Level (dBuV/m)	Limit (dBuV/m)	Margin (dB)	Detector
1	2390.000	31.10	20.91	52.01	74.00	-21.99	peak
2	2390.000	31.10	8.67	39.77	54.00	-14.23	AVG

Remarks:

- 1. Factor (dB/m) = Antenna Factor (dB/m)+Cable Factor (dB)-Pre-amplifier Factor
- 2. Margin value = Level -Limit value



Ant. Pol.	Horizontal
Test Mode:	B Mode 2462 MHz

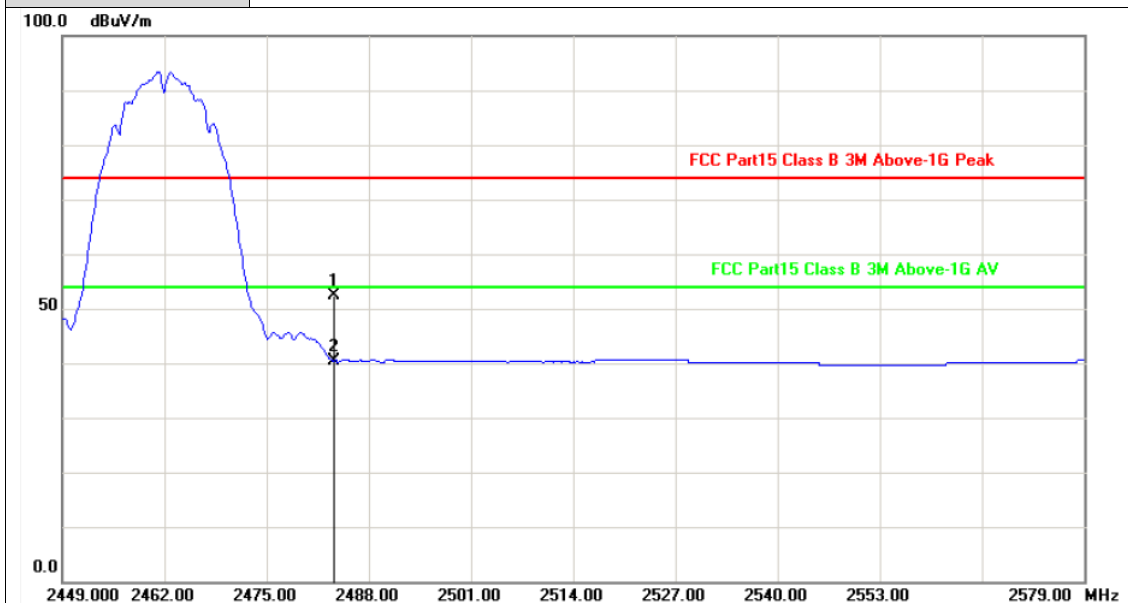

No.	Frequency (MHz)	Factor (dB/m)	Reading (dBuV)	Level (dBuV/m)	Limit (dBuV/m)	Margin (dB)	Detector
1	2483.500	31.50	20.99	52.49	74.00	-21.51	peak
2	2483.500	31.50	8.98	40.48	54.00	-13.52	AVG

Remarks:

- 1. Factor (dB/m) = Antenna Factor (dB/m)+Cable Factor (dB)-Pre-amplifier Factor
- 2. Margin value = Level -Limit value



Ant. Pol.	Vertical
Test Mode:	B Mode 2462 MHz

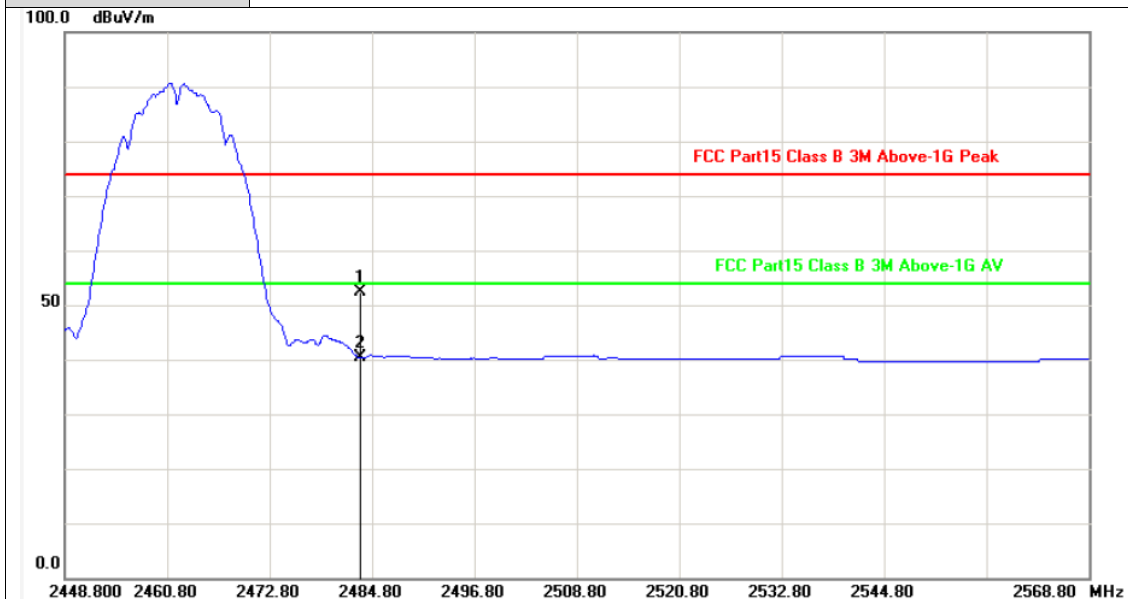

No.	Frequency (MHz)	Factor (dB/m)	Reading (dBuV)	Level (dBuV/m)	Limit (dBuV/m)	Margin (dB)	Detector
1	2483.500	31.50	20.96	52.46	74.00	-21.54	peak
2	2483.500	31.50	8.78	40.28	54.00	-13.72	AVG

Remarks:
 1. Factor (dB/m) = Antenna Factor (dB/m)+Cable Factor (dB)-Pre-amplifier Factor
 2. Margin value = Level -Limit value



Ant. Pol.	Horizontal
Test Mode:	G Mode 2412MHz

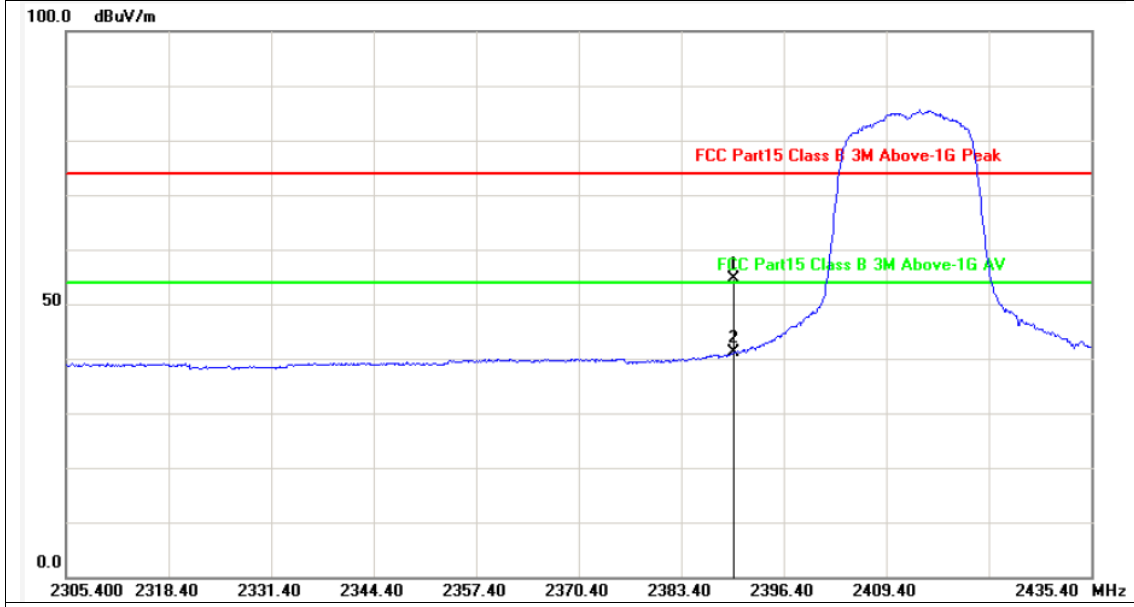

No.	Frequency (MHz)	Factor (dB/m)	Reading (dBuV)	Level (dBuV/m)	Limit (dBuV/m)	Margin (dB)	Detector
1	2390.000	31.10	23.41	54.51	74.00	-19.49	peak
2	2390.000	31.10	9.98	41.08	54.00	-12.92	AVG

Remarks:
 1. Factor (dB/m) = Antenna Factor (dB/m)+Cable Factor (dB)-Pre-amplifier Factor
 2. Margin value = Level -Limit value

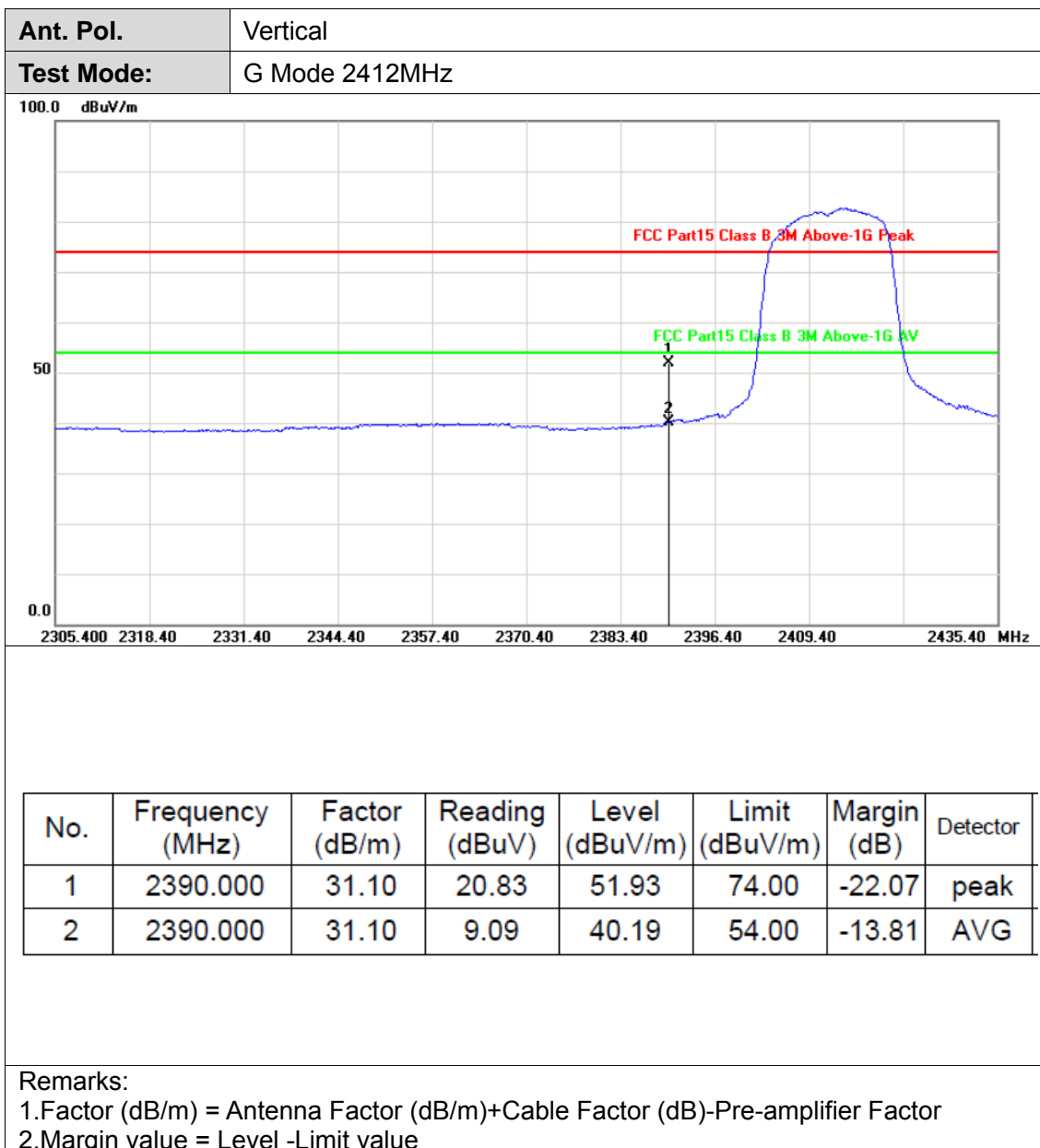



Ant. Pol.	Horizontal
Test Mode:	G Mode 2462MHz

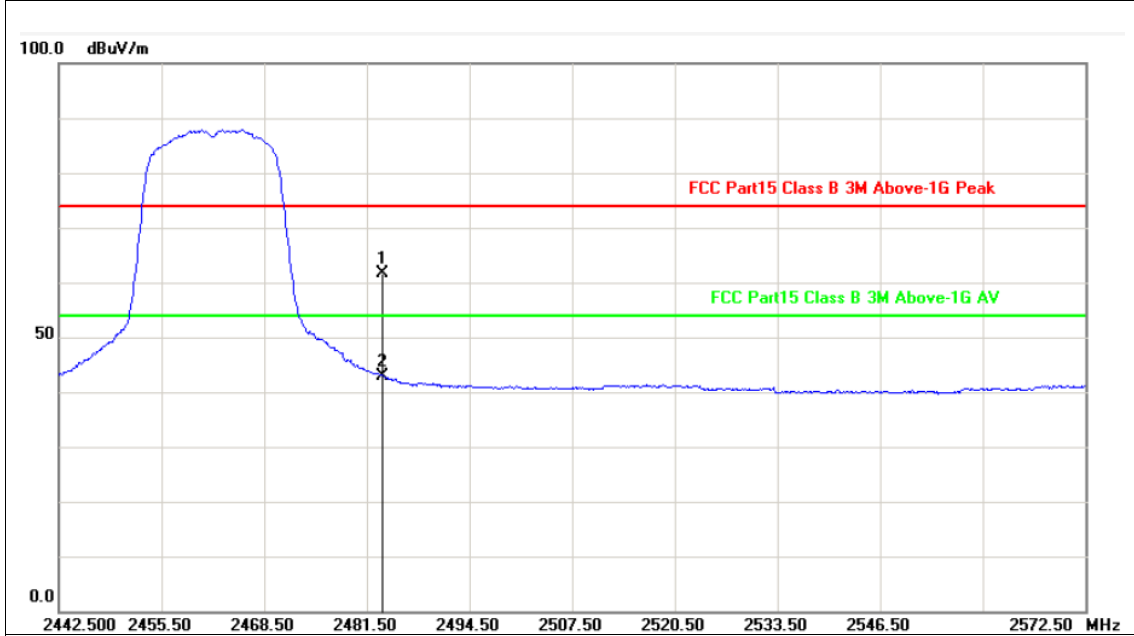

No.	Frequency (MHz)	Factor (dB/m)	Reading (dBuV)	Level (dBuV/m)	Limit (dBuV/m)	Margin (dB)	Detector
1	2483.500	31.50	30.17	61.67	74.00	-12.33	peak
2	2483.500	31.50	11.29	42.79	54.00	-11.21	AVG

Remarks:
 1. Factor (dB/m) = Antenna Factor (dB/m)+Cable Factor (dB)-Pre-amplifier Factor
 2. Margin value = Level -Limit value



Ant. Pol.	Vertical
Test Mode:	G Mode 2462MHz

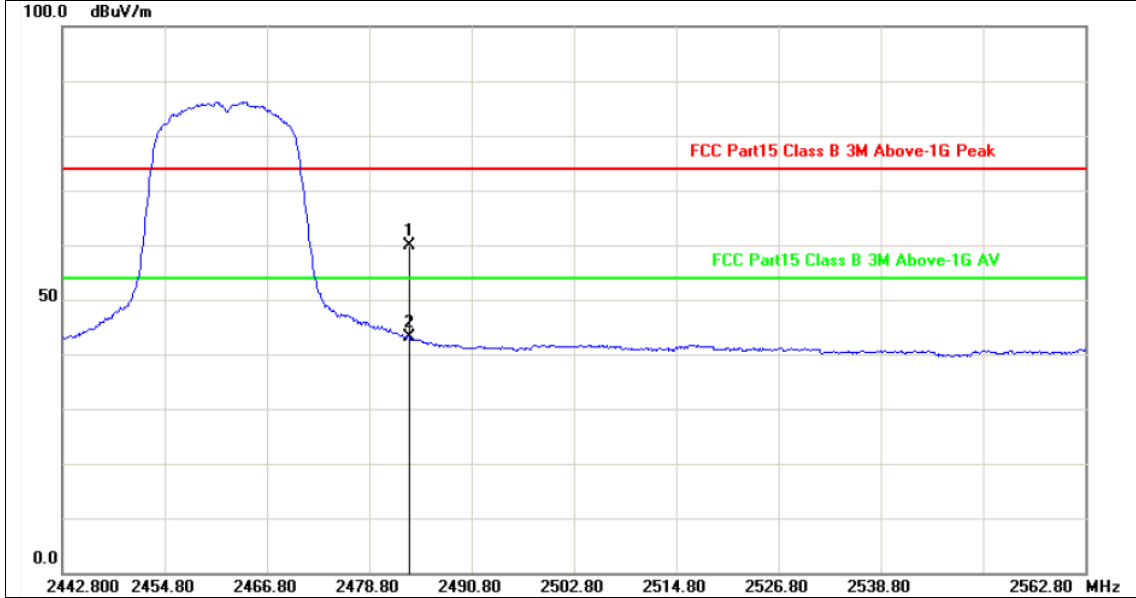

No.	Frequency (MHz)	Factor (dB/m)	Reading (dBuV)	Level (dBuV/m)	Limit (dBuV/m)	Margin (dB)	Detector
1	2483.500	31.50	28.48	59.98	74.00	-14.02	peak
2	2483.500	31.50	11.58	43.08	54.00	-10.92	AVG

Remarks:

- 1. Factor (dB/m) = Antenna Factor (dB/m)+Cable Factor (dB)-Pre-amplifier Factor
- 2. Margin value = Level -Limit value



Ant. Pol.	Horizontal
Test Mode:	N(HT20) Mode 2412MHz

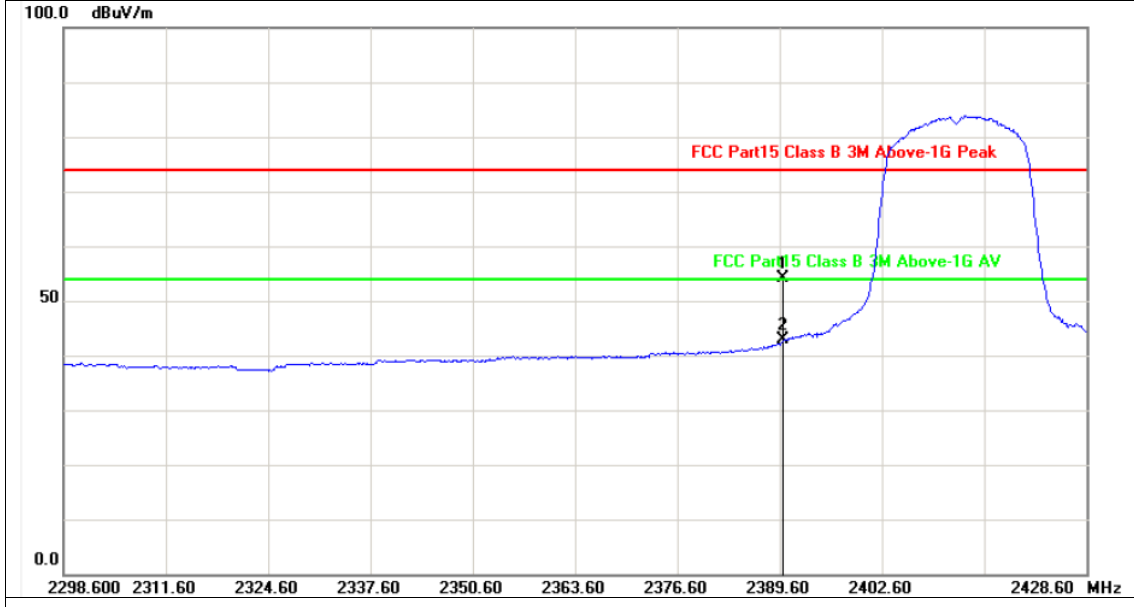

No.	Frequency (MHz)	Factor (dB/m)	Reading (dBuV)	Level (dBuV/m)	Limit (dBuV/m)	Margin (dB)	Detector
1	2390.000	31.10	23.11	54.21	74.00	-19.79	peak
2	2390.000	31.10	11.77	42.87	54.00	-11.13	AVG

Remarks:
 1. Factor (dB/m) = Antenna Factor (dB/m)+Cable Factor (dB)-Pre-amplifier Factor
 2. Margin value = Level -Limit value



Ant. Pol.	Vertical
Test Mode:	N(HT20) Mode 2412MHz

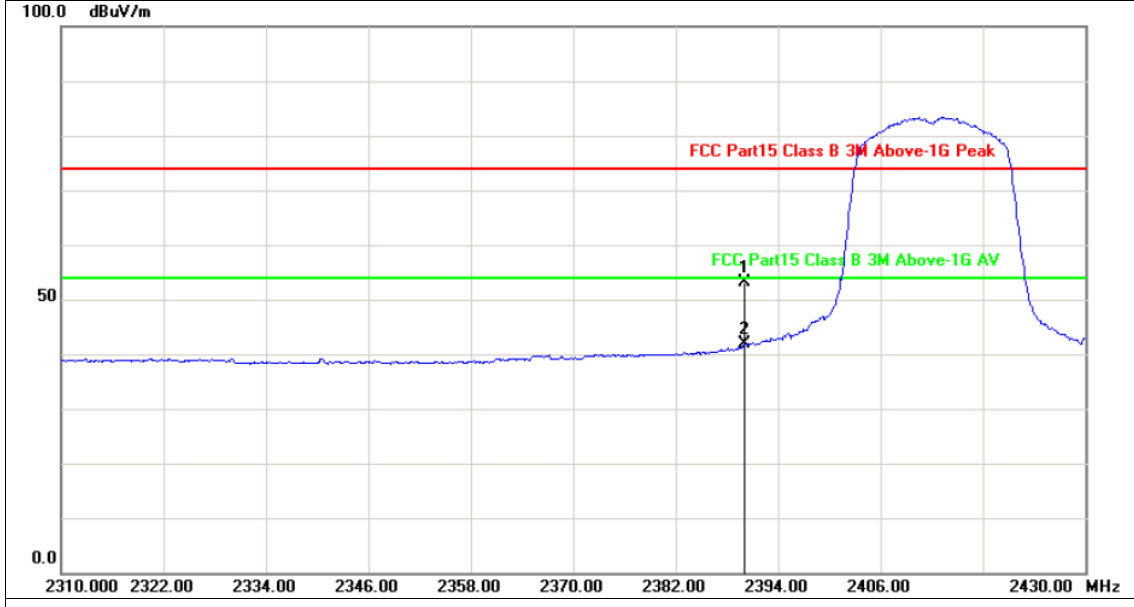

No.	Frequency (MHz)	Factor (dB/m)	Reading (dBuV)	Level (dBuV/m)	Limit (dBuV/m)	Margin (dB)	Detector
1	2390.000	31.10	21.99	53.09	74.00	-20.91	peak
2	2390.000	31.10	10.73	41.83	54.00	-12.17	AVG

Remarks:
 1. Factor (dB/m) = Antenna Factor (dB/m)+Cable Factor (dB)-Pre-amplifier Factor
 2. Margin value = Level -Limit value



Ant. Pol.	Horizontal
Test Mode:	N(HT20) Mode 2462MHz

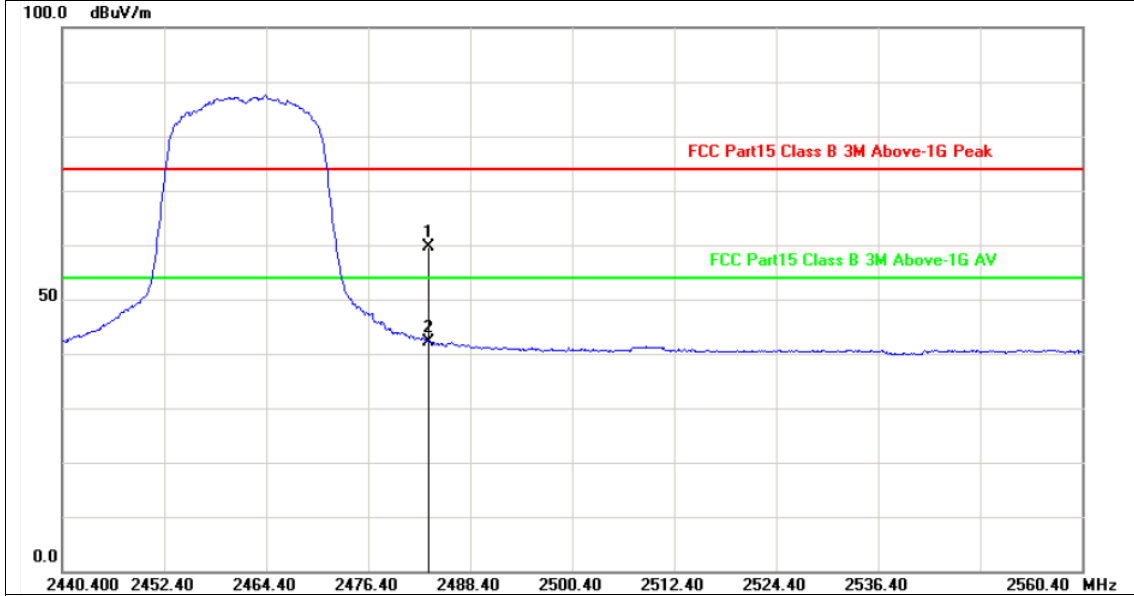

No.	Frequency (MHz)	Factor (dB/m)	Reading (dBuV)	Level (dBuV/m)	Limit (dBuV/m)	Margin (dB)	Detector
1	2483.500	31.50	28.13	59.63	74.00	-14.37	peak
2	2483.500	31.50	10.52	42.02	54.00	-11.98	AVG

Remarks:
 1. Factor (dB/m) = Antenna Factor (dB/m)+Cable Factor (dB)-Pre-amplifier Factor
 2. Margin value = Level -Limit value



Ant. Pol.	Vertical
Test Mode:	N(HT20) Mode 2462MHz

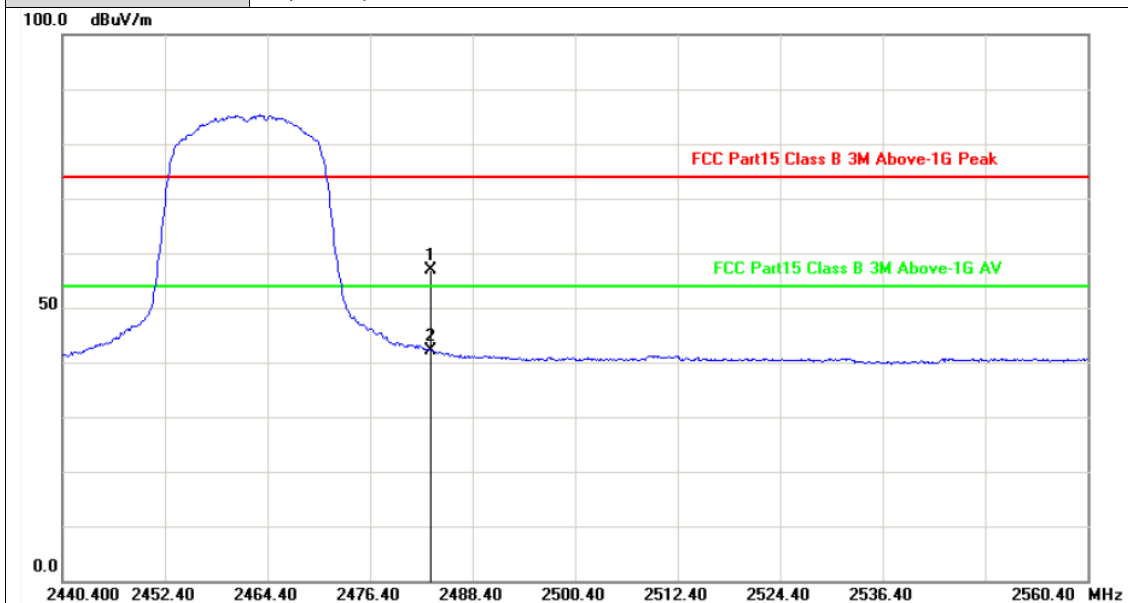

No.	Frequency (MHz)	Factor (dB/m)	Reading (dBuV)	Level (dBuV/m)	Limit (dBuV/m)	Margin (dB)	Detector
1	2483.500	31.50	25.49	56.99	74.00	-17.01	peak
2	2483.500	31.50	10.55	42.05	54.00	-11.95	AVG

Remarks:

- 1. Factor (dB/m) = Antenna Factor (dB/m)+Cable Factor (dB)-Pre-amplifier Factor
- 2. Margin value = Level -Limit value





(2) Conducted Test

Type:		802.11 b	
CH01	<p>Ref 20 dBm *Att 30 dB *RBW 100 kHz Marker 4 [T1] -24.12 dBm *VBW 300 kHz 2.397083333 GHz SWT 15 ms</p> <p>Marker 1 [T1] -4.19 dBm 2.413333333 GHz Marker 2 [T1] -30.56 dBm 2.400000000 GHz Marker 3 [T1] -52.23 dBm 2.390000000 GHz</p> <p>D1 -15.81 dBm</p> <p>SWP 245 of 300</p> <p>Start 2.3 GHz 13 MHz/ Stop 2.43 GHz</p> <p>Date: 20_SEP.2020 10:38:02</p>		
	Mark frequency(MHz)	Value (dBm)	Limit (dBm)
2400.000	-30.56	-15.81	Pass
2390.000	-52.23		
2397.083	-24.12		

Type:		802.11 b	
CH11	<p>Ref 20 dBm *Att 30 dB *RBW 100 kHz Marker 4 [T1] -39.20 dBm *VBW 300 kHz 2.489006410 GHz SWT 15 ms</p> <p>Marker 1 [T1] -4.35 dBm 2.460448718 GHz Marker 2 [T1] -51.44 dBm 2.483500000 GHz Marker 3 [T1] -45.40 dBm 2.500000000 GHz</p> <p>D1 -15.65 dBm</p> <p>SWP 295 of 300</p> <p>Start 2.44 GHz 11 MHz/ Stop 2.55 GHz</p> <p>Date: 20_SEP.2020 11:00:57</p>		
	Mark frequency(MHz)	Value (dBm)	Limit (dBm)
2483.500	-51.44	-15.65	Pass
2500.000	-45.40		
2489.006	-39.20		

CTC Laboratories, Inc.

1-2/F., Building 2, Jiaquan Building, Guanlan High-Tech Park, Shenzhen, Guangdong, China
 Tel.: (86)755-27521059 Fax: (86)755-27521011 Http://www.sz-ctc.org.cn



For anti-fake verification, please visit the official website of Certification and Accreditation Administration of the People's Republic of China : yz.cnca.cn

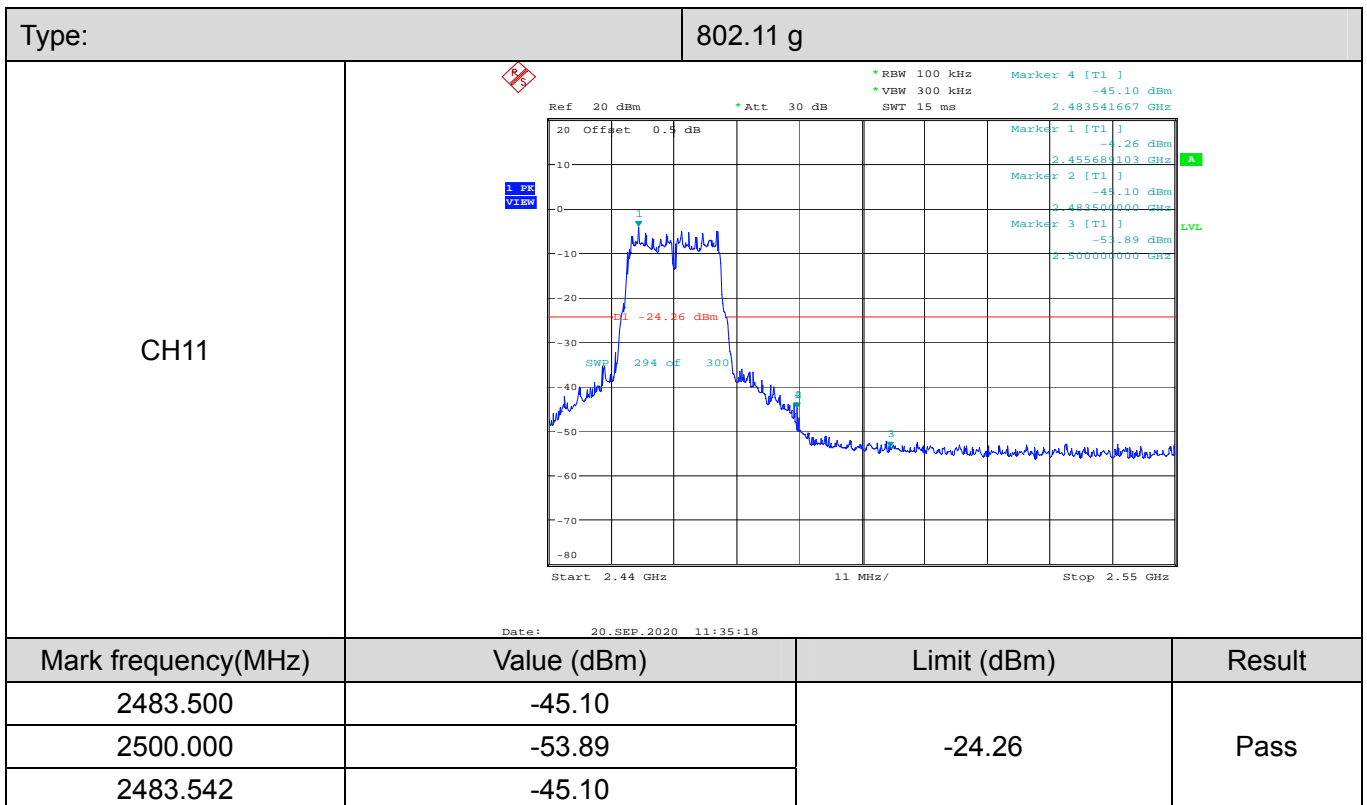
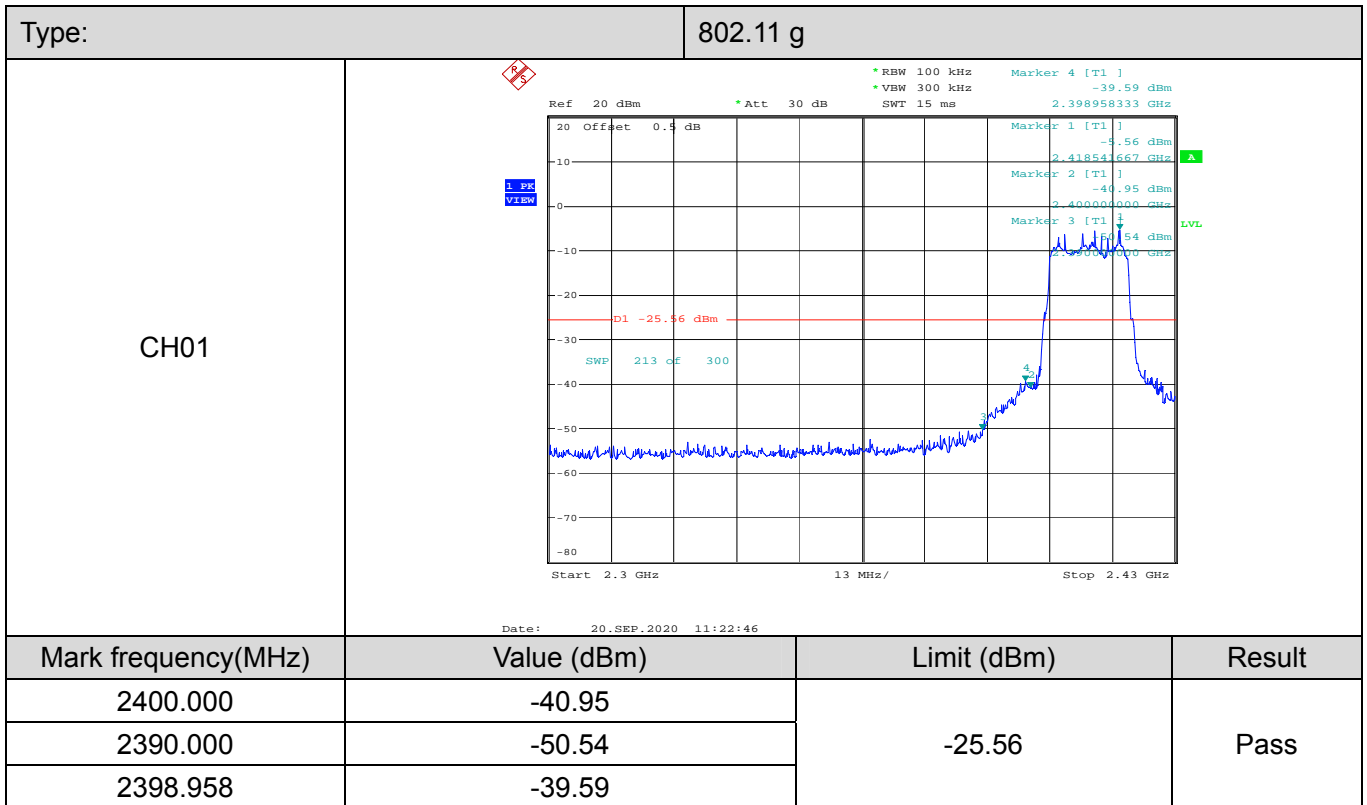

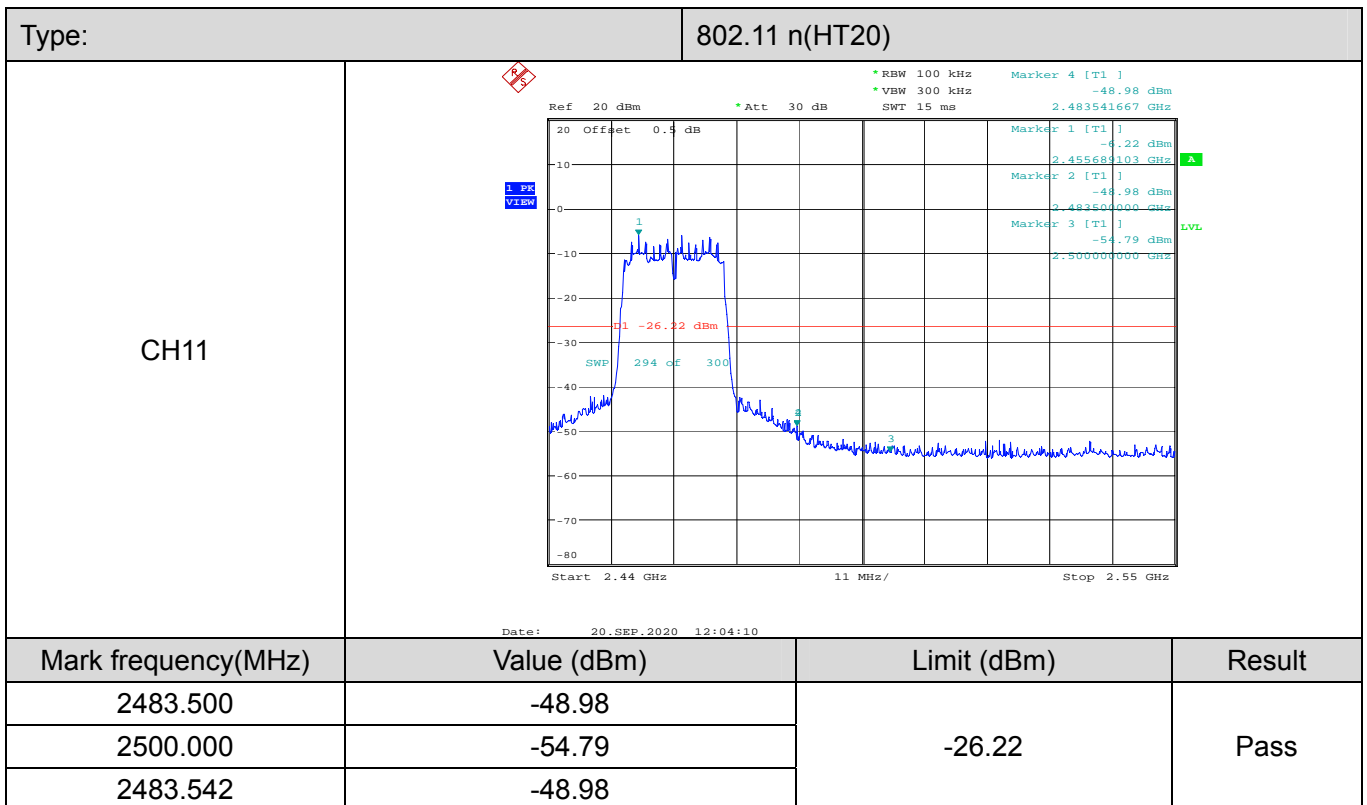
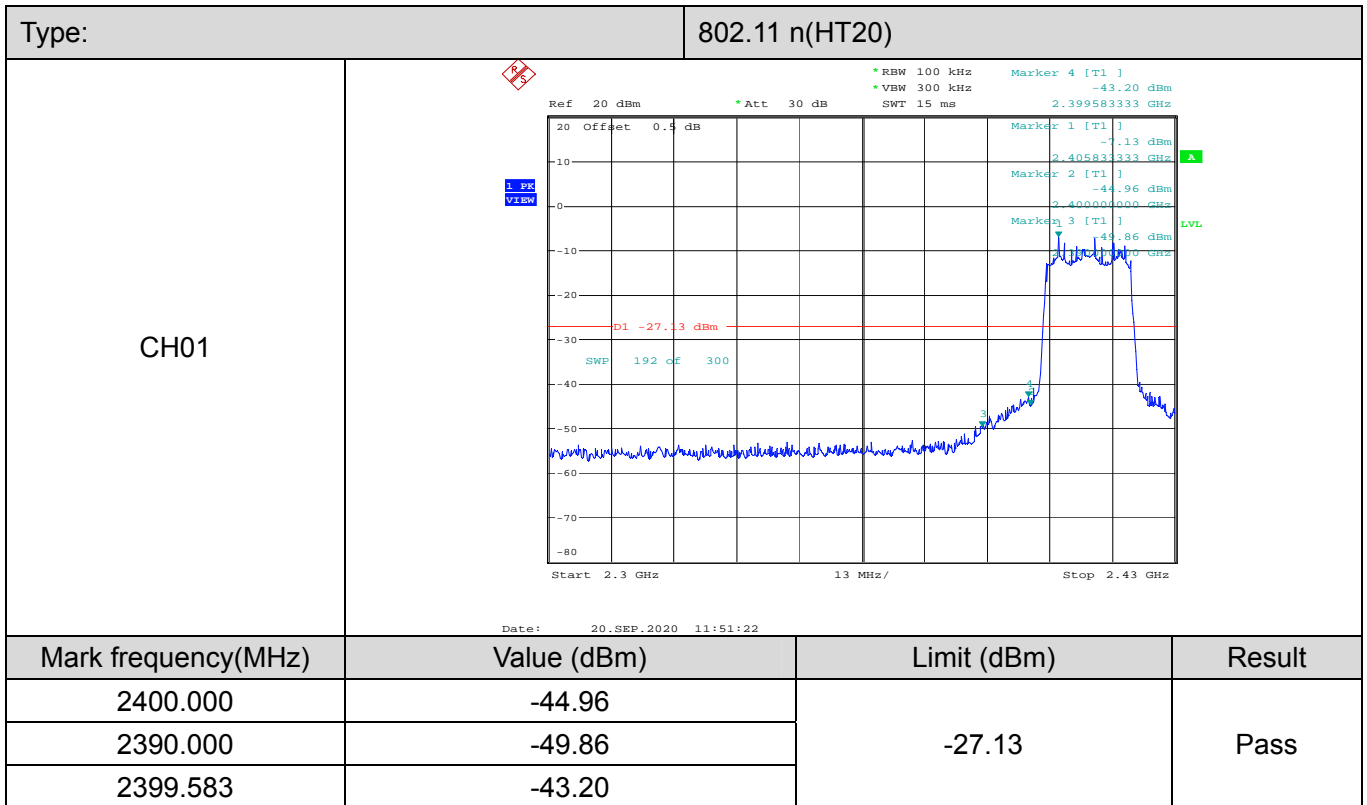

CTC Laboratories, Inc.

1-2/F., Building 2, Jiaquan Building, Guanlan High-Tech Park, Shenzhen, Guangdong, China
Tel.: (86)755-27521059 Fax: (86)755-27521011 Http://www.sz-ctc.org.cn



For anti-fake verification, please visit the official website of Certification and Accreditation Administration of the People's Republic of China : yz.cnca.cn

3.4. DTS Bandwidth

Limit

FCC CFR Title 47 Part 15 Subpart C Section 15.247 (a)(2)/ RSS-247 5.2 a:

Test Item	Limit	Frequency Range(MHz)
DTS Bandwidth	≥ 500 KHz (6dB bandwidth)	2400~2483.5

Test Configuration

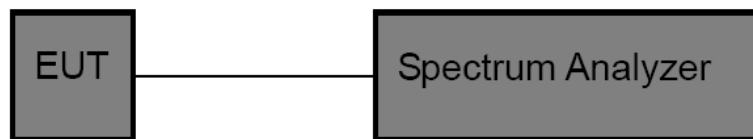

Test Procedure

1. The EUT was directly connected to the spectrum analyzer and antenna output port as show in the block diagram above.
2. DTS Spectrum Setting:
 - (1) Set RBW = 100 kHz.
 - (2) Set the video bandwidth (VBW) ≥ 3 RBW.
 - (3) Detector = Peak.
 - (4) Trace mode = Max hold.
 - (5) Sweep = Auto couple.OCB Spectrum Setting:
 - (1) Set RBW = 1% ~ 5% occupied bandwidth.
 - (2) Set the video bandwidth (VBW) ≥ 3 RBW.
 - (3) Detector = Peak.
 - (4) Trace mode = Max hold.
 - (5) Sweep = Auto couple.

NOTE: The EUT was set to continuously transmitting in each mode and low, Middle and high channel for the test.

Test Mode

Please refer to the clause 2.4.



Test Results

Test Mode	Channel	DTS BW [MHz]	Limit [MHz]	Verdict
802.11b	2412	10.112	≥ 0.5	PASS
	2437	9.600	≥ 0.5	PASS
	2462	10.048	≥ 0.5	PASS
802.11g	2412	15.840	≥ 0.5	PASS
	2437	15.712	≥ 0.5	PASS
	2462	16.352	≥ 0.5	PASS
802.11n(HT20)	2412	15.712	≥ 0.5	PASS
	2437	16.160	≥ 0.5	PASS
	2462	17.216	≥ 0.5	PASS



802.11b_2412

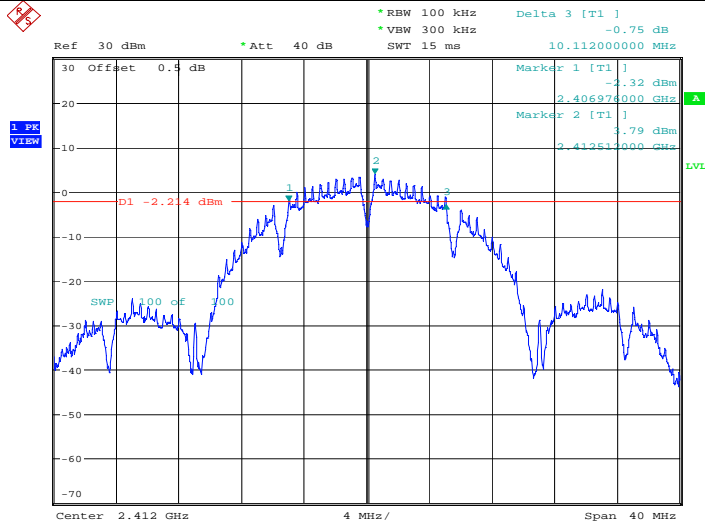

Date: 20.SEP.2020 10:31:42

802.11b_2437

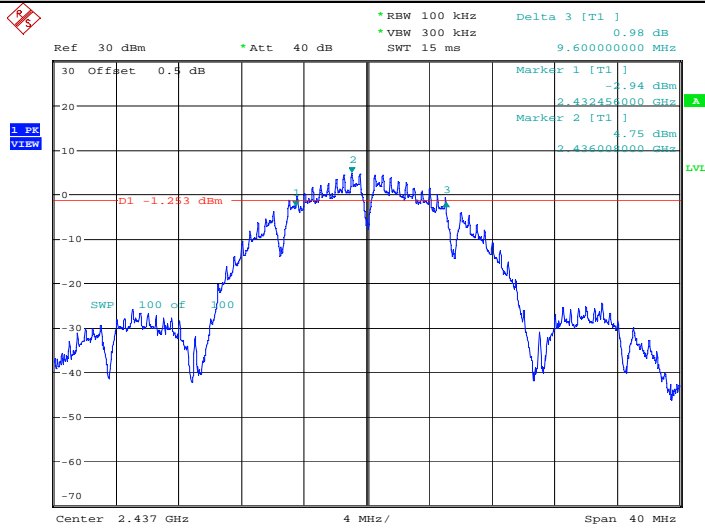

Date: 20.SEP.2020 10:45:11

802.11b_2462

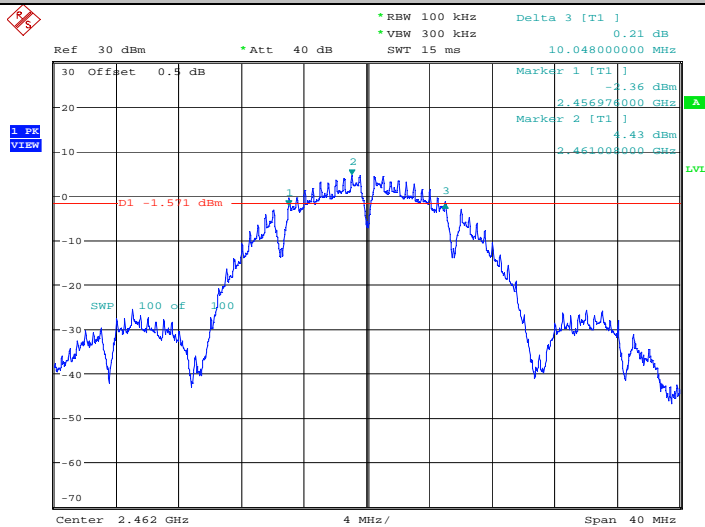

Date: 20.SEP.2020 10:54:37

CTC Laboratories, Inc.

1-2/F., Building 2, Jiaquan Building, Guanlan High-Tech Park, Shenzhen, Guangdong, China
 Tel.: (86)755-27521059 Fax: (86)755-27521011 Http://www.sz-ctc.org.cn



For anti-fake verification, please visit the official website of Certification and Accreditation Administration of the People's Republic of China : yz.cnca.cn



802.11g_2412

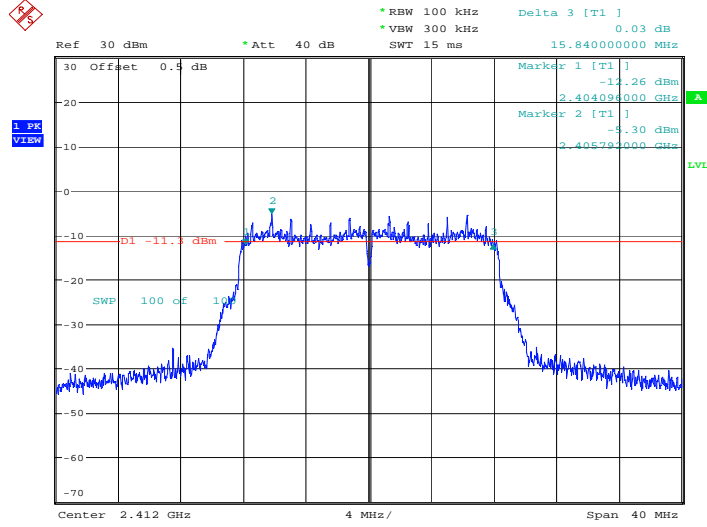

Date: 20_SEP.2020 11:13:31

802.11g_2437

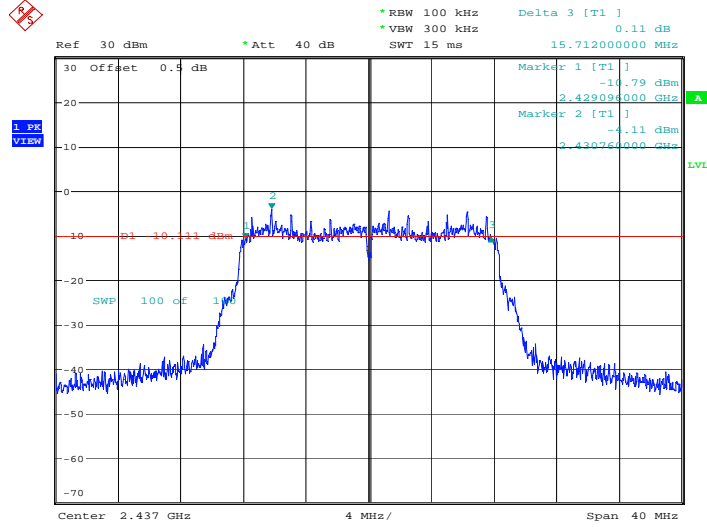

Date: 20_SEP.2020 11:26:35

802.11g_2462

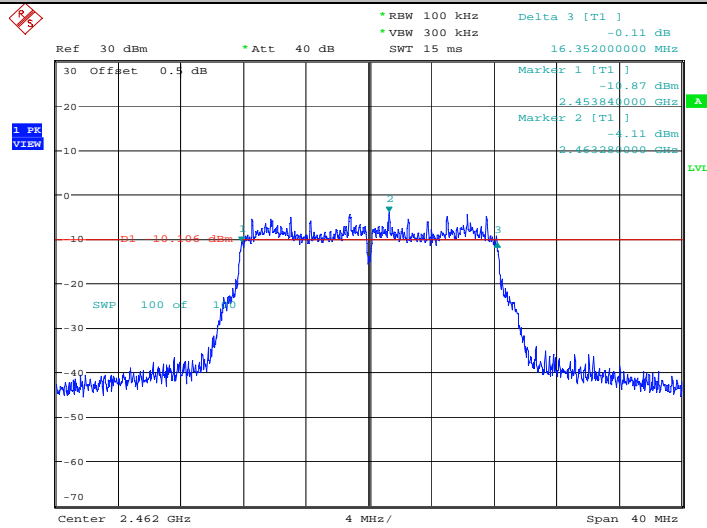

Date: 20_SEP.2020 11:33:03

CTC Laboratories, Inc.

1-2/F., Building 2, Jiaquan Building, Guanlan High-Tech Park, Shenzhen, Guangdong, China
 Tel.: (86)755-27521059 Fax: (86)755-27521011 Http://www.sz-ctc.org.cn



For anti-fake verification, please visit the official website of Certification and Accreditation Administration of the People's Republic of China: yz.cnca.cn



802.11n(HT20)_2412

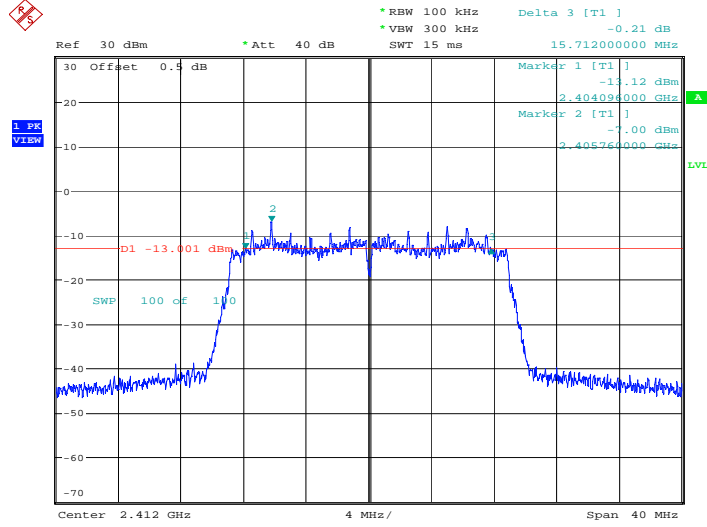

Date: 20_SEP.2020 11:49:08

802.11n(HT20)_2437

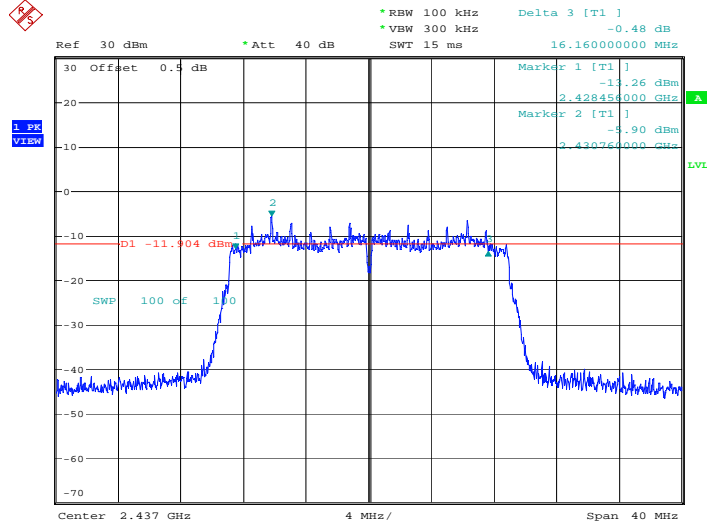

Date: 20_SEP.2020 11:56:08

802.11n(HT20)_2462

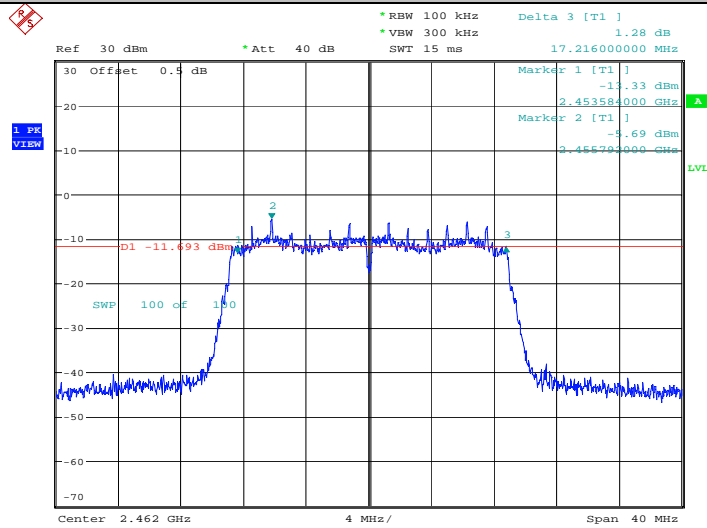

Date: 20_SEP.2020 12:01:52

CTC Laboratories, Inc.

1-2/F., Building 2, Jiaquan Building, Guanlan High-Tech Park, Shenzhen, Guangdong, China
 Tel.: (86)755-27521059 Fax: (86)755-27521011 Http://www.sz-ctc.org.cn



For anti-fake verification, please visit the official website of Certification and Accreditation Administration of the People's Republic of China: yz.cnca.cn



3.5. Peak Output Power

Limit

FCC CFR Title 47 Part 15 Subpart C Section 15.247 (b)(3)/ RSS-247 5.4:

Section	Test Item	Limit	Frequency Range(MHz)
CFR 47 FCC 15.247(b)(3)	Maximum conducted output power	1 Watt or 30dBm	2400~2483.5
ISED RSS-247 5.4 d	EIRP	4 Watt or 36dBm	2400~2483.5

Test Configuration

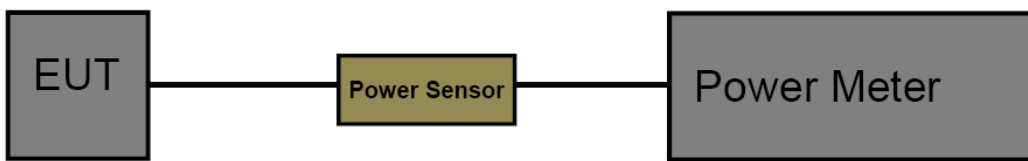

Test Procedure

1. The maximum conducted output power may be measured using a broadband Peak RF power meter.
2. Peak power measurements were performed only when the EUT was transmitting at its maximum power control level using a broadband power meter with a pulse sensor.
3. The power meter implemented triggering and gating capabilities which were set up such that power measurements were recorded only during the ON time of the transmitter.
4. Record the measurement data.

Test Mode

Please refer to the clause 2.3

Test Result



Test Mode	Channel	Result [PK dBm]	Result [AVG dBm]	Limit [dBm]	Verdict
802.11b	2412	15.80	12.85	<=30	PASS
	2437	16.28	13.21	<=30	PASS
	2462	16.62	13.36	<=30	PASS
802.11g	2412	12.63	10.26	<=30	PASS
	2437	13.58	10.69	<=30	PASS
	2462	14.17	11.02	<=30	PASS
802.11n(HT20)	2412	10.23	9.62	<=30	PASS
	2437	11.40	9.84	<=30	PASS
	2462	11.97	9.96	<=30	PASS

Note: Test results increased RF cable loss by 0.5dB.



3.6. Power Spectral Density

Limit

FCC CFR Title 47 Part 15 Subpart C Section 15.247 (e)/ RSS-247 5.2 b:

Test Item	Limit	Frequency Range(MHz)
Power Spectral Density	8dBm(in any 3 kHz)	2400~2483.5

Test Configuration

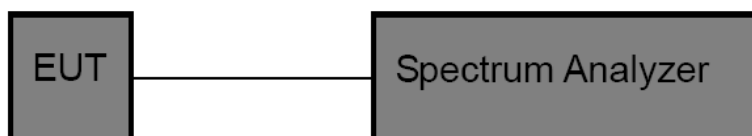

Test Procedure

1. The EUT was directly connected to the spectrum analyzer and antenna output port as show in the block diagram above.
2. The EUT was directly connected to the Spectrum Analyzer and antenna output port as show in the block diagram above. The measurement according to section 10.2 of KDB 558074 D01 DTS Meas Guidance v05r02.
3. Spectrum Setting:
Set analyzer center frequency to DTS channel center frequency.
Set the span to 1.5 times the DTS bandwidth.
Set the RBW to: 3 kHz
Set the VBW to: 10 kHz
Detector: PK
Sweep time: Auto
Allow trace to fully stabilize. Then use the peak marker function to determine the maximum amplitude level.

Test Mode

Please refer to the clause 2.3

**Test Result**

Test Mode	Channel	Result [dBm/3kHz]	Limit [dBm/3kHz]	Verdict
802.11b	2412	-9.72	<=8	PASS
	2437	-8.56	<=8	PASS
	2462	-8.20	<=8	PASS
802.11g	2412	-18.56	<=8	PASS
	2437	-18.92	<=8	PASS
	2462	-18.29	<=8	PASS
802.11n(HT20)	2412	-22.37	<=8	PASS
	2437	-21.21	<=8	PASS
	2462	-20.42	<=8	PASS



802.11b_2412

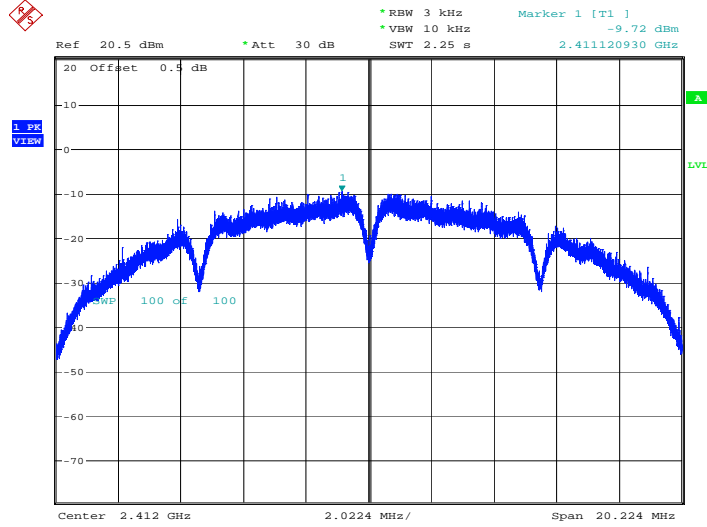

Date: 20.SEP.2020 10:37:42

802.11b_2437

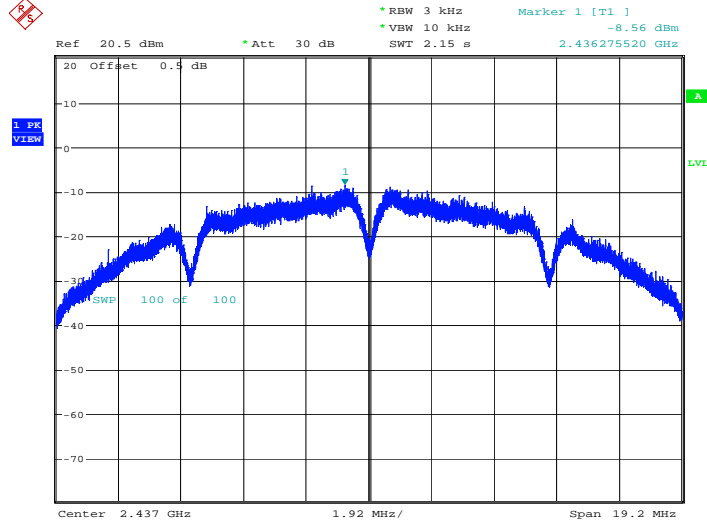

Date: 20.SEP.2020 10:50:58

802.11b_2462

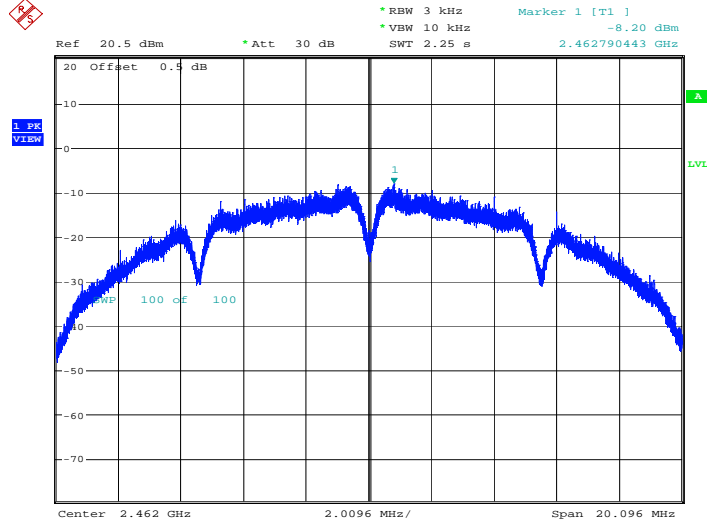

Date: 20.SEP.2020 11:00:37

CTC Laboratories, Inc.

1-2/F., Building 2, Jiaquan Building, Guanlan High-Tech Park, Shenzhen, Guangdong, China
Tel.: (86)755-27521059 Fax: (86)755-27521011 Http://www.sz-ctc.org.cn



For anti-fake verification, please visit the official website of Certification and Accreditation Administration of the People's Republic of China : yz.cnca.cn



802.11g_2412

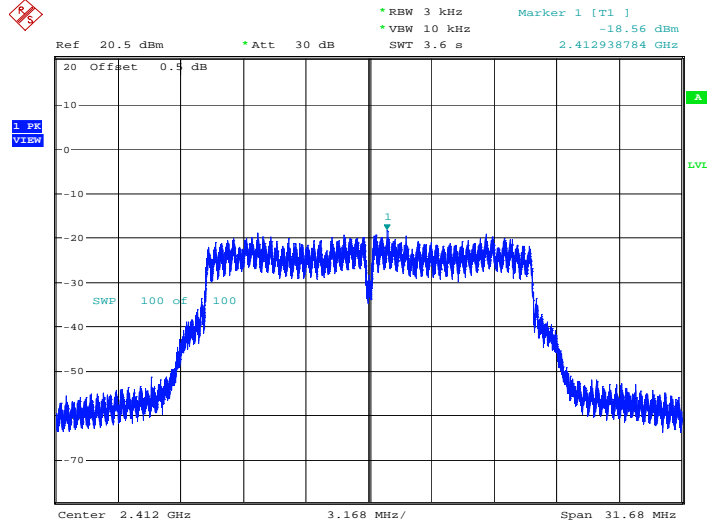

Date: 20.SEP.2020 11:22:26

802.11g_2437

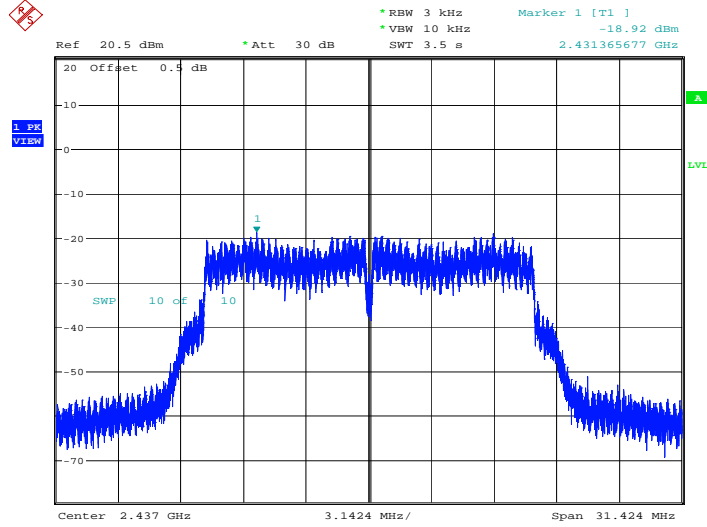

Date: 20.SEP.2020 11:28:28

802.11g_2462

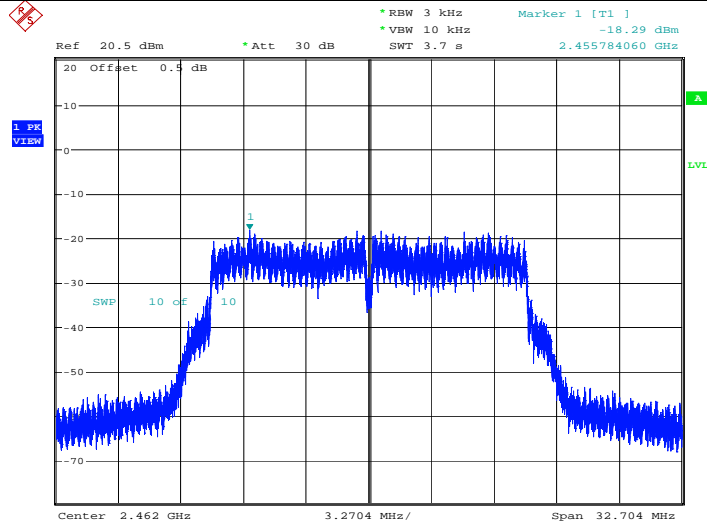

Date: 20.SEP.2020 11:34:59

CTC Laboratories, Inc.

1-2/F., Building 2, Jiaquan Building, Guanlan High-Tech Park, Shenzhen, Guangdong, China
 Tel.: (86)755-27521059 Fax: (86)755-27521011 Http://www.sz-ctc.org.cn



For anti-fake verification, please visit the official website of Certification and Accreditation Administration of the People's Republic of China : yz.cnca.cn



802.11n(HT20)_2412

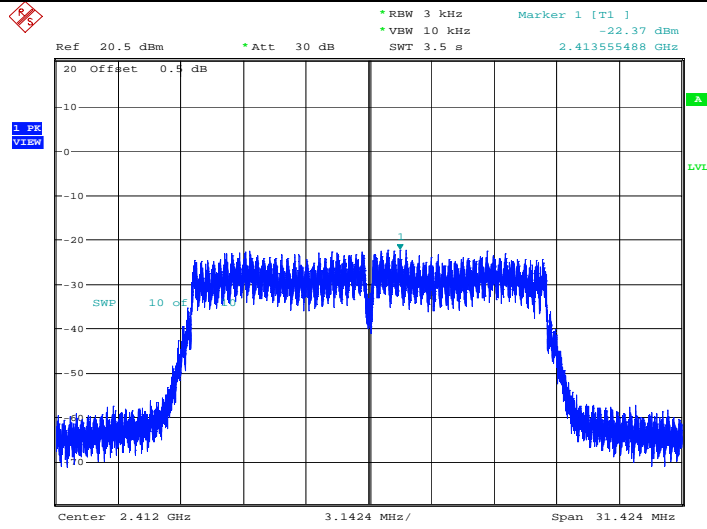

Date: 20_SEP.2020 11:51:02

802.11n(HT20)_2437

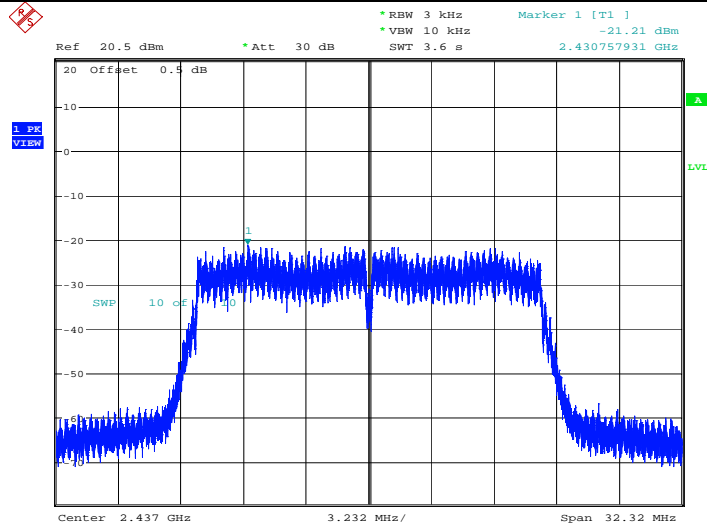

Date: 20_SEP.2020 11:58:02

802.11n(HT20)_2462

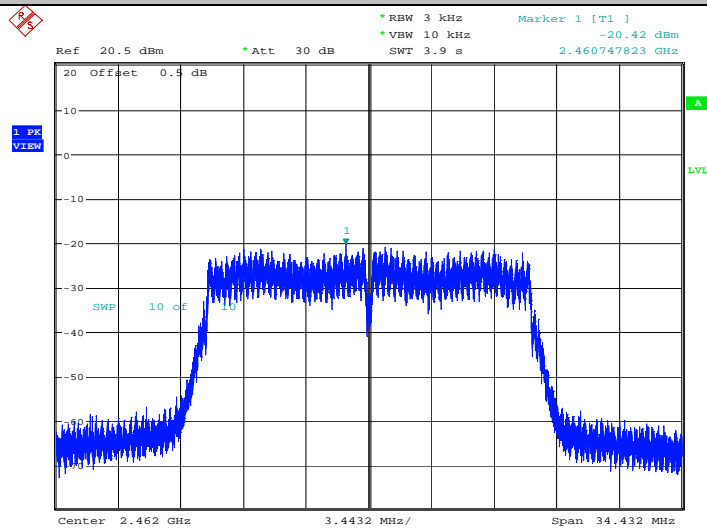

Date: 20_SEP.2020 12:03:51

CTC Laboratories, Inc.

1-2/F., Building 2, Jiaquan Building, Guanlan High-Tech Park, Shenzhen, Guangdong, China
 Tel.: (86)755-27521059 Fax: (86)755-27521011 Http://www.sz-ctc.org.cn



For anti-fake verification, please visit the official website of Certification and Accreditation Administration of the People's Republic of China : yz.cnca.cn



3.7. Duty Cycle

Limit

None, for report purposes only.

Test Configuration

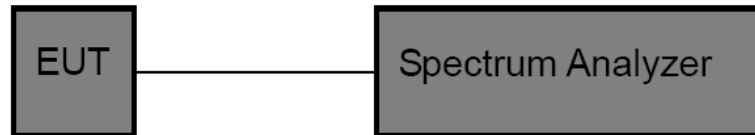

Test Procedure

1. The EUT was directly connected to the spectrum analyzer and antenna output port as show in the block diagram above.
2. The EUT was directly connected to the Spectrum Analyzer and antenna output port as show in the block diagram above. The measurement according to section 10.2 of KDB 558074 D01 DTS Meas Guidance v05r02.
3. Spectrum Setting:
Set analyzer center frequency to DTS channel center frequency.
Set the span to 0Hz
Set the RBW to 10MHz
Set the VBW to 10MHz
Detector: peak
Sweep time: auto
Allow trace to fully stabilize. Then use the peak marker function to determine the maximum amplitude level.

Test Mode

Please refer to the clause 2.3

Test Result

Test Mode	Channel	Transmission Duration [ms]	Transmission Period [ms]	Duty Cycle [%]	1/T Minimum VBW (kHz)	Final setting For VBW (kHz)
802.11b	2412	8.41	8.51	98.80	0.12	0.01
	2437	8.41	8.51	98.80	0.12	0.01
	2462	8.41	8.51	98.80	0.12	0.01
802.11g	2412	1.39	1.50	93.12	0.67	1
	2437	1.39	1.50	93.12	0.67	1
	2462	1.39	1.50	93.12	0.67	1
802.11n(HT20)	2412	1.31	1.41	92.69	0.71	1
	2437	1.31	1.41	92.69	0.71	1
	2462	1.31	1.41	92.69	0.71	1



802.11b_2412

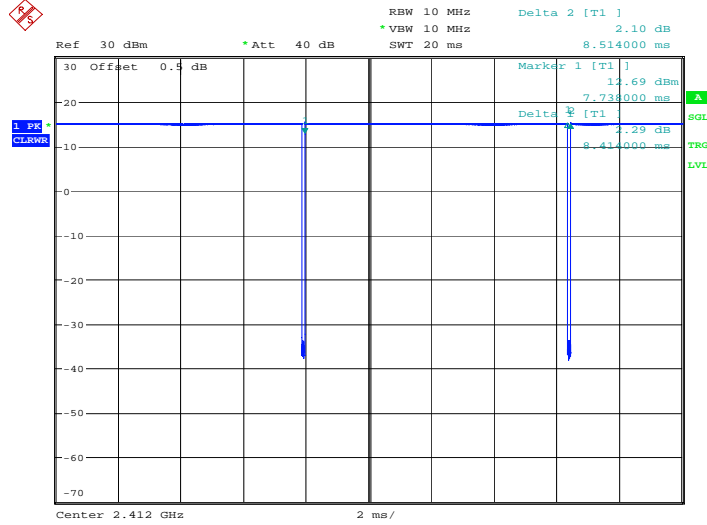

Date: 20_SEP.2020 10:31:15

802.11b_2437

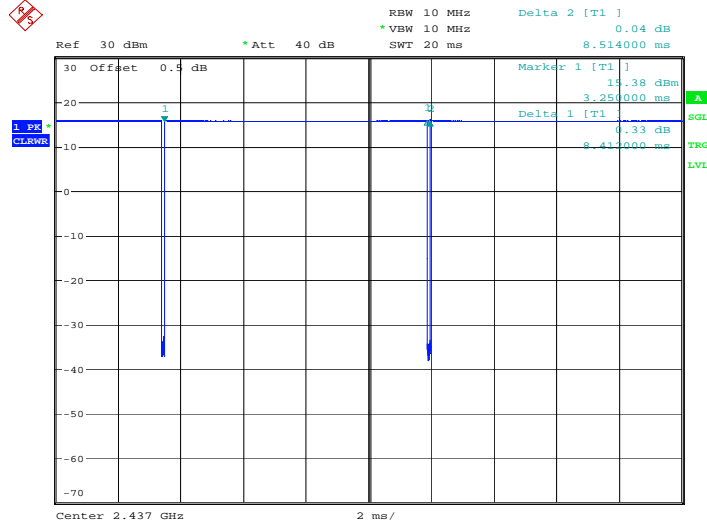

Date: 20_SEP.2020 10:44:44

802.11b_2462

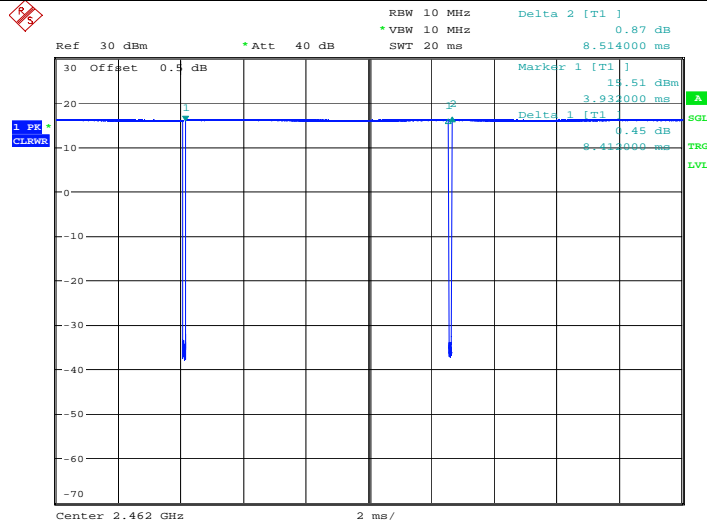

Date: 20_SEP.2020 10:54:11

CTC Laboratories, Inc.

1-2/F., Building 2, Jiaquan Building, Guanlan High-Tech Park, Shenzhen, Guangdong, China
 Tel.: (86)755-27521059 Fax: (86)755-27521011 Http://www.sz-ctc.org.cn



For anti-fake verification, please visit the official website of Certification and Accreditation Administration of the People's Republic of China : yz.cnca.cn

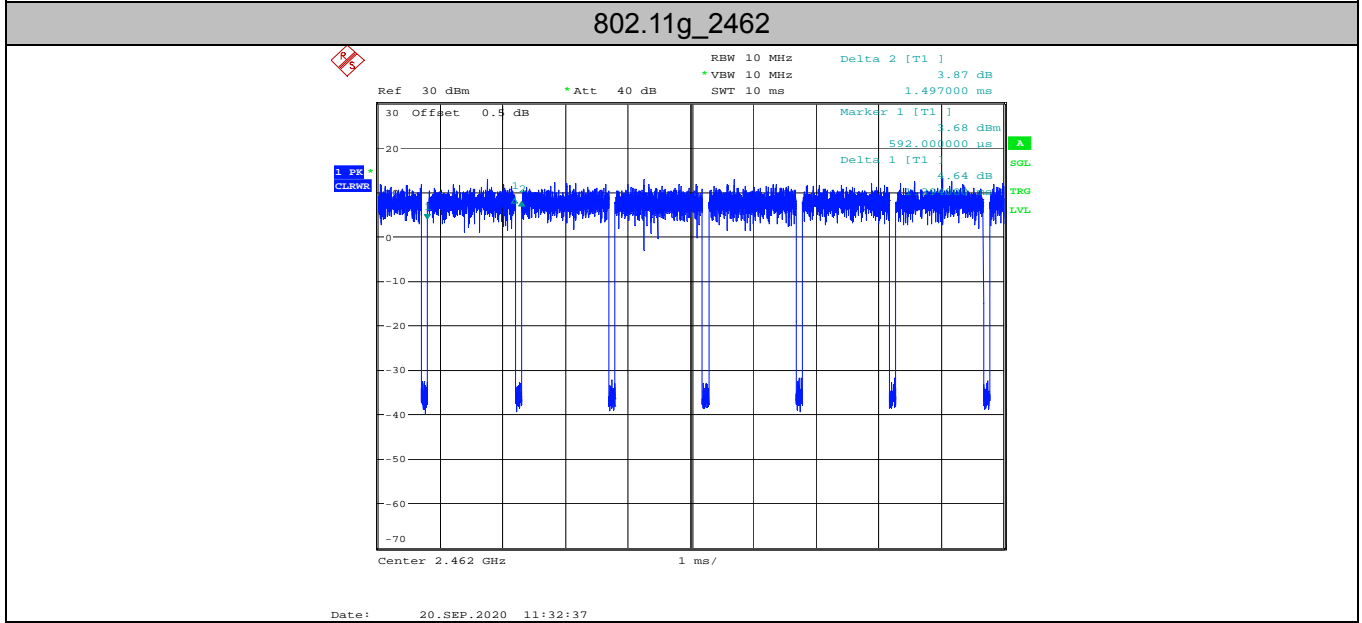
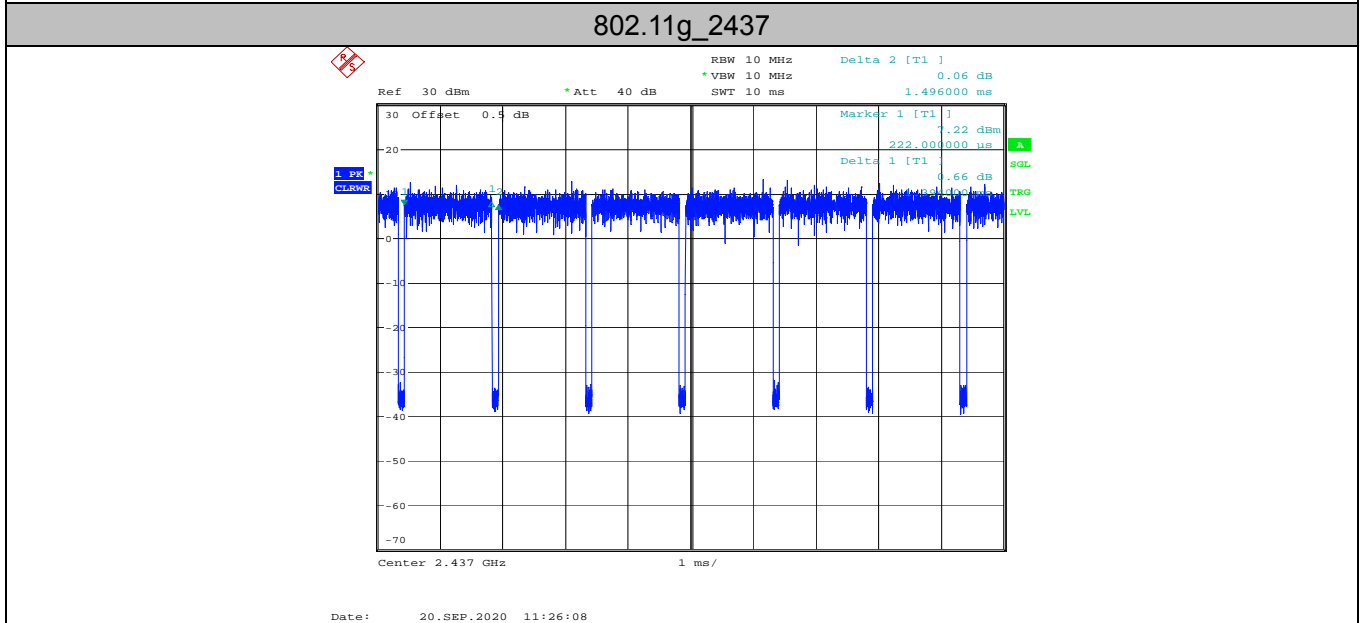
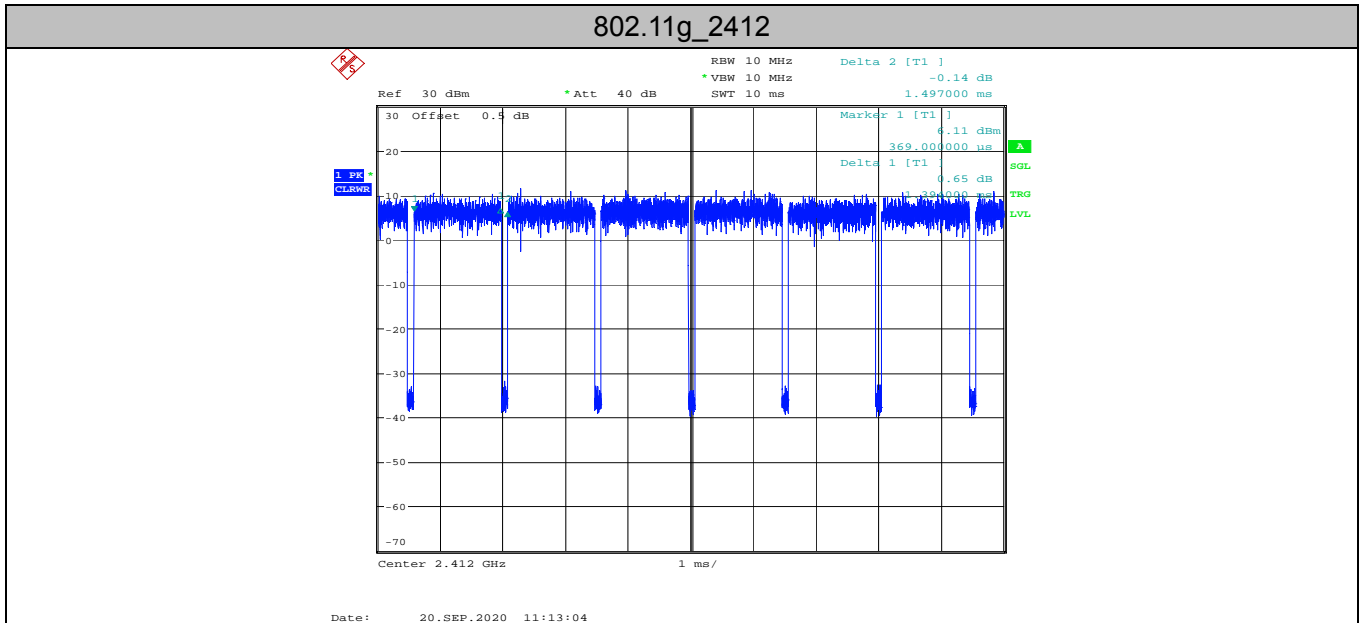

CTC Laboratories, Inc.

1-2/F., Building 2, Jiaquan Building, Guanlan High-Tech Park, Shenzhen, Guangdong, China
 Tel.: (86)755-27521059 Fax: (86)755-27521011 Http://www.sz-ctc.org.cn



For anti-fake verification, please visit the official website of Certification and Accreditation Administration of the People's Republic of China : yz.cnca.cn



802.11n(HT20)_2412

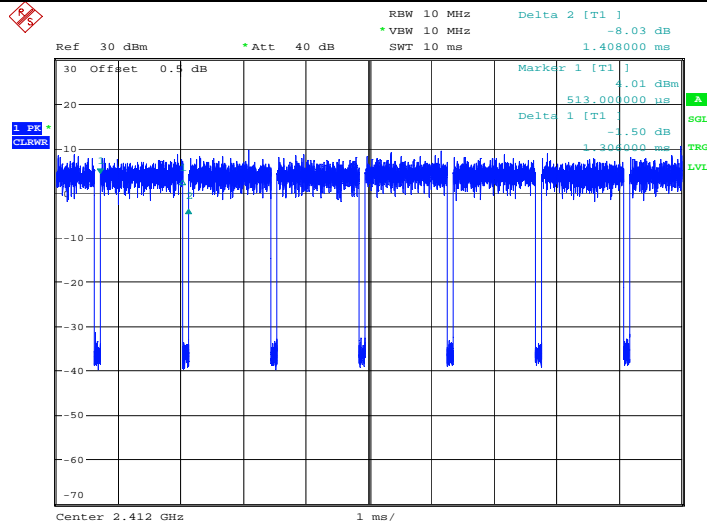

Date: 20_SEP.2020 11:48:42

802.11n(HT20)_2437

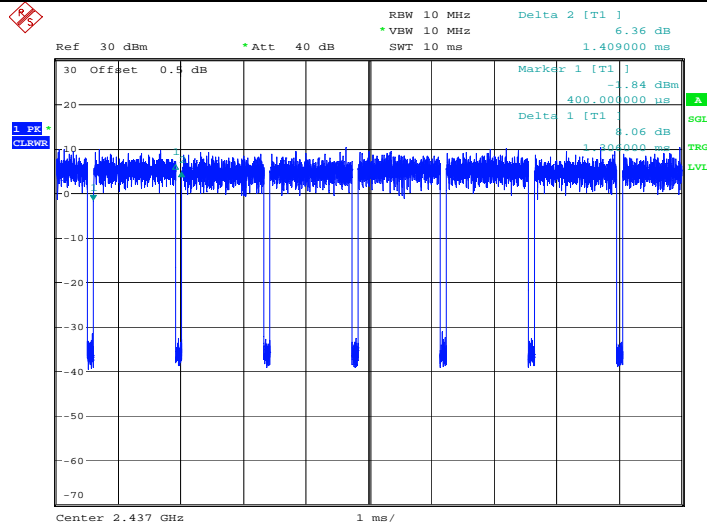

Date: 20_SEP.2020 11:55:41

802.11n(HT20)_2462

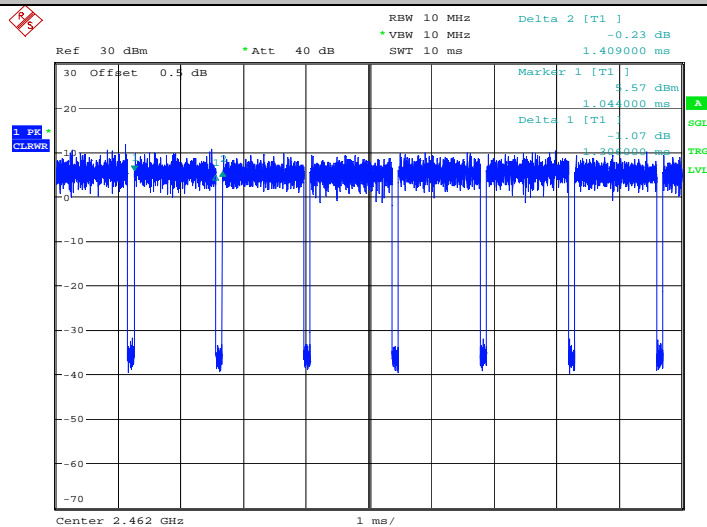

Date: 20_SEP.2020 12:01:26

CTC Laboratories, Inc.

1-2/F., Building 2, Jiaquan Building, Guanlan High-Tech Park, Shenzhen, Guangdong, China
 Tel.: (86)755-27521059 Fax: (86)755-27521011 Http://www.sz-ctc.org.cn



For anti-fake verification, please visit the official website of Certification and Accreditation Administration of the People's Republic of China: yz.cnca.cn



3.8. Antenna requirement

Requirement

FCC CFR Title 47 Part 15 Subpart C Section 15.203:

An intentional radiator shall be designed to ensure that no antenna other than that furnished by the responsible party shall be used with the device. The use of a permanently attached antenna or of antenna that uses a unique coupling to the intentional radiator, the manufacturer may design the unit so that a broken antenna can be replaced by the user, but the use of a standard antenna jack or electrical connector is prohibited.

FCC CFR Title 47 Part 15 Subpart C Section 15.247(c) (1)(i):

(i) Systems operating in the 2400~2483.5 MHz band that is used exclusively for fixed. Point-to-point operations may employ transmitting antennas with directional gain greater than 6dBi provided the maximum conducted output power of the intentional radiator is reduced by 1 dB for every 3 dB that the directional gain of the antenna exceeds 6dBi.

Test Result

The directional gain of the antenna less than 6dBi, please refer to the EUT internal photographs antenna photo.

*****THE END*****