



Shenzhen CTA Testing Technology Co., Ltd.

Room 106, Building 1, Yibaolai Industrial Park, Qiaotou Community, Fuhai Street, Bao'an District, Shenzhen, China

FCC PART 15 SUBPART CTEST REPORT

FCC PART 15.236

Report Reference No.....: CTA22022200201

FCC ID.....: 2AWA2-ALU1

Compiled by

(position+printedname+signature)....: File administrators Kevin Liu

Supervised by

(position+printedname+signature)....: Project Engineer Kevin Liu

Approved by

(position+printedname+signature)....: RF Manager Eric Wang

Date of issue.....: Mar.03, 2022



Testing Laboratory Name: Shenzhen CTA Testing Technology Co., Ltd.

Address.....: Room 106, Building 1, Yibaolai Industrial Park, Qiaotou Community, Fuhai Street, Bao'an District, Shenzhen, China

Applicant's name: Shenzhen Lococo Technology Co., Ltd.

Address: RM602, Bldg A, Huanyuan Tech Park, Baoyuan Road, Baoan Dist, Shenzhen Guangdong, CHINA

Test specification

Standard.....: FCC Part 15.236

Shenzhen CTA Testing Technology Co., Ltd. All rights reserved.

This publication may be reproduced in whole or in part for non-commercial purposes as long as the Shenzhen CTA Testing Technology Co., Ltd. is acknowledged as copyright owner and source of the material. Shenzhen CTA Testing Technology Co., Ltd. takes no responsibility for and will not assume liability for damages resulting from the reader's interpretation of the reproduced material due to its placement and context.

Test item description: **Wireless Lavalier Microphone**

Trade Mark: N/A

Manufacturer: Shenzhen Lococo Technology Co., Ltd.

Model/Type reference.....: ALU1

Listed Models: ALU2,ALU3,ALU4,ALU5,ALU6,ALU7,ALU8,ALU9,AL10,AL11,AL12, AL13,AL14,AL15,AL16,AL17,AL18,AL19,AL20,AL21,AL22,AL23,AL 24,AL25,AL26,AL27,AL28,AL29,AL30

Modulation Type.....: FM

Operation Frequency.....: 570.5MHz-598.5MHz

Rating: DC 3.7V From battery and DC 5V From external circuit

Result.....: **PASS**

Shenzhen CTA Testing Technology Co., Ltd.

Room 106, Building 1, Yibaolai Industrial Park, Qiaotou Community, Fuhai Street, Bao'an District, Shenzhen, China
Tel:+86-755 2322 5875 E-mail:cta@cta-test.cn Web:http://www.cta-test.cn

TEST REPORT

Equipment under Test : Wireless Lavalier Microphone

Model /Type : ALU1

Listed Models : ALU2,ALU3,ALU4,ALU5,ALU6,ALU7,ALU8,ALU9,AL10, AL11,AL12,AL13,AL14,AL15,AL16,AL17,AL18,AL19,AL20, AL21,AL22,AL23,AL24,AL25,AL26,AL27,AL28,AL29,AL30

Model Declaration : PCB board, structure and internal of these model(s) are the same,So no additional models were tested.

Applicant : **Shenzhen Lococo Technology Co., Ltd.**

Address : RM602, Bldg A,Huanyuan Tech Park, Baoyuan Road, Baoan Dist,Shenzhen Guangdong,CHINA

Manufacturer : **Shenzhen Lococo Technology Co., Ltd.**

Address : RM602, Bldg A,Huanyuan Tech Park, Baoyuan Road, Baoan Dist,Shenzhen Guangdong,CHINA

Test Result:	PASS
---------------------	-------------

The test report merely corresponds to the test sample.
 It is not permitted to copy extracts of these test result without the written permission of the test laboratory.

Contents

1	<u>TEST STANDARDS</u>	4
2	<u>SUMMARY</u>	5
2.1	General Remarks	5
2.2	Product Description	5
2.3	Test Sample	錯
	误!未定义书签。	
2.4	Equipment Under Test	5
2.5	Short description of the Equipment under Test (EUT)	5
2.6	EUT operation mode	5
2.7	Block Diagram of Test Setup	6
2.8	Related Submittal(s) / Grant (s)	6
2.9	Modifications	6
3	<u>TEST ENVIRONMENT</u>	7
3.1	Address of the test laboratory	7
3.2	Test Facility	7
3.3	Environmental conditions	7
3.4	Summary of measurement results	7
3.5	Statement of the measurement uncertainty	8
3.6	Equipments Used during the Test	9
4	<u>TEST CONDITIONS AND RESULTS</u>	10
4.1	AC Power Conducted Emission	10
4.2	Maximum Output Power	13
4.3	Occupied Bandwidth	15
4.4	Necessary Bandwidth	17
4.5	Transmitter spurious emissions	19
4.6	Frequency Stability	21
5	<u>TEST SETUP PHOTOS OF THE EUT</u>	23
6	<u>PHOTOS OF THE EUT</u>	24

1 TEST STANDARDS

The tests were performed according to following standards:

[FCC Rules Part 15.236](#): Operation of wireless Wireless Lavalier Microphones in the bands 54-72 MHz, 76-88 MHz, 174-216 MHz, 470-608 MHz and 614-698 MHz.

[ANSI C63.10-2013](#): American National Standard for Testing Unlicensed Wireless Devices

2 SUMMARY

2.1 General Remarks

Date of receipt of test sample	:	Feb. 15, 2022
Testing commenced on	:	Feb. 20, 2022
Testing concluded on	:	Mar. 03, 2022

2.2 Product Description

Product Name:	Wireless Lavalier Microphone
Model/Type reference:	ALU1
Power supply:	DC 3.7V from battery
Hardware version:	N/A
Software version:	N/A
Testing sample ID:	CTA220222002-1# (Engineer sample), CTA220222002 -2#(Normal sample)
Wireless Lavalier Microphone	
Frequency:	570.5MHz-598.5MHz
Nominal channel bandwidth	200KHz
Modulation Type:	FM
Antenna type:	External Antenna
Antenna gain:	0.00 dBi

Note: For more detailed features description, please refer to the manufacturer's specifications or the User's Manual.

2.3 Equipment Under Test

Power supply system utilised

Power supply voltage	:	<input type="radio"/> 230V/ 50 Hz	<input type="radio"/> 120V/60Hz
		<input type="radio"/> 12 V DC	<input type="radio"/> 24 V DC
		<input checked="" type="radio"/> Other (specified in blank below)	

DC 3.7V From Battery and DC 5V From external circuit

2.4 Short description of the Equipment under Test (EUT)

This is a Wireless Lavalier Microphone.

For more details, refer to the user's manual of the EUT.

2.5 EUT operation mode

The EUT has been tested under typical operating condition. The EUT will staying in continuous transmitting when switch to the specific test frequency.

Shenzhen CTA Testing Technology Co., Ltd.

Room 106, Building 1, Yibaolai Industrial Park, Qiaotou Community, Fuhai Street, Bao'an District, Shenzhen, China
Tel:+86-755 2322 5875 E-mail:cta@cta-test.cn Web:http://www.cta-test.cn

Operation Frequency:

Channel	Frequency (MHz)	Channel	Frequency (MHz)
1	570.5	9	586.5
2	572.5	10	588.5
3	574.5	11	590.5
4	576.5	12	592.5
5	578.5	13	594.5
6	580.5	14	596.5
7	582.5	15	598.5
8	584.5		

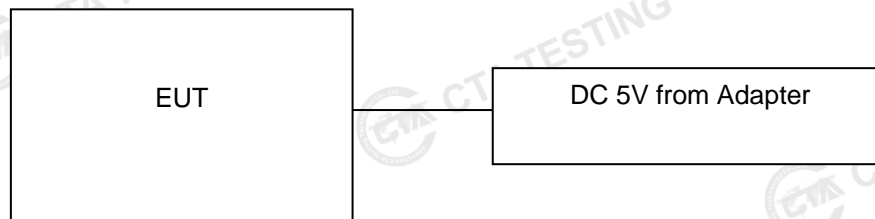
2.6 Block Diagram of Test Setup**2.7 Related Submittal(s) / Grant (s)**

This submittal(s) (test report) is intended for the device filing to comply with Section 15.236 of the FCC Part 15, Subpart C Rules.

2.8 Modifications

No modifications were implemented to meet testing criteria.

3 TEST ENVIRONMENT

3.1 Address of the test laboratory

Shenzhen CTA Testing Technology Co., Ltd.

Room 106, Building 1, Yibaolai Industrial Park, Qiaotou Community, Fuhai Street, Bao'an District, Shenzhen, China

3.2 Test Facility

The test facility is recognized, certified, or accredited by the following organizations:

FCC-Registration No.: 517856 Designation Number: CN1318

Shenzhen CTA Testing Technology Co., Ltd. has been listed on the US Federal Communications Commission list of test facilities recognized to perform electromagnetic emissions measurements.

A2LA-Lab Cert. No.: 6534.01

Shenzhen CTA Testing Technology Co., Ltd. has been listed by American Association for Laboratory Accreditation to perform electromagnetic emission measurement.

The 3m-Semi anechoic test site fulfils CISPR 16-1-4 according to ANSI C63.10 and CISPR 16-1-4:2010.

3.3 Environmental conditions

During the measurement the environmental conditions were within the listed ranges:

Temperature:	15-35 ° C
Humidity:	30-60 %
Atmospheric pressure:	950-1050mbar

3.4 Summary of measurement results

Test Specification clause	Test case	Test result
§15.236(d)	RF Power Output	Compliant
§15.236(f)(2)	Occupied Bandwidth	Compliant
§15.236(g)	Necessary Bandwidth	Compliant
§15.236(g)	Spurious emissions	Compliant
§15.236(f)(3)	Frequency Stability	Compliant
§15.207	Conducted Emissions	Compliant

Remark:

1. The measurement uncertainty is not included in the test result.
2. We tested all test mode and recorded worst case in report

Shenzhen CTA Testing Technology Co., Ltd.

Room 106, Building 1, Yibaolai Industrial Park, Qiaotou Community, Fuhai Street, Bao'an District, Shenzhen, China
Tel:+86-755 2322 5875 E-mail:cta@cta-test.cn Web:http://www.cta-test.cn

3.5 Statement of the measurement uncertainty

The data and results referenced in this document are true and accurate. The reader is cautioned that there may be errors within the calibration limits of the equipment and facilities. The measurement uncertainty was calculated for all measurements listed in this test report acc. to TR-100028-01 "Electromagnetic compatibility and Radio spectrum Matters (ERM);Uncertainties in the measurement of mobile radio equipment characteristics; Part 1" and TR-100028-02 "Electromagnetic compatibility and Radio spectrum Matters (ERM);Uncertainties in the measurement of mobile radio equipment characteristics; Part 2 " and is documented in the Shenzhen CTA Testing Technology Co., Ltd. quality system acc. to DIN EN ISO/IEC 17025. Furthermore, component and process variability of devices similar to that tested may result in additional deviation. The manufacturer has the sole responsibility of continued compliance of the device.

Hereafter the best measurement capability for Shenzhen CTA Testing Technology Co., Ltd. :

Test	Range	Measurement Uncertainty	Notes
Radiated Emission	30~1000MHz	4.10 dB	(1)
Radiated Emission	1~18GHz	4.32 dB	(1)
Radiated Emission	18-40GHz	5.54 dB	(1)
Conducted Disturbance	0.15~30MHz	3.12 dB	(1)

- (1) This uncertainty represents an expanded uncertainty expressed at approximately the 95% confidence level using a coverage factor of $k=2$.

3.6 Equipments Used during the Test

Test Equipment	Manufacturer	Model No.	Equipment No.	Calibration Date	Calibration Due Date
LISN	R&S	ENV216	CTA-308	2021/08/06	2022/08/05
LISN	R&S	ENV216	CTA-314	2021/08/06	2022/08/05
EMI Test Receiver	R&S	ESPI	CTA-307	2021/08/06	2022/08/05
EMI Test Receiver	R&S	ESCI	CTA-306	2021/08/06	2022/08/05
Spectrum Analyzer	Agilent	N9020A	CTA-301	2021/08/06	2022/08/05
Spectrum Analyzer	R&S	FSP	CTA-337	2021/08/06	2022/08/05
Vector Signal generator	Agilent	N5182A	CTA-305	2021/08/06	2022/08/05
Analog Signal Generator	R&S	SML03	CTA-304	2021/08/06	2022/08/05
Universal Radio Communication	CMW500	R&S	CTA-302	2021/08/06	2022/08/05
Temperature and humidity meter	Chigo	ZG-7020	CTA-326	2021/08/06	2022/08/05
Ultra-Broadband Antenna	Schwarzbeck	VULB9163	CTA-310	2021/08/07	2022/08/06
Horn Antenna	Schwarzbeck	BBHA 9120D	CTA-309	2021/08/07	2022/08/06
Loop Antenna	Zhinan	ZN30900C	CTA-311	2021/08/07	2022/08/06
Horn Antenna	Beijing Hangwei Dayang	OBH100400	CTA-336	2021/08/06	2022/08/05
Amplifier	Schwarzbeck	BBV 9745	CTA-312	2021/08/06	2022/08/05
Amplifier	Taiwan chengyi	EMC051845B	CTA-313	2021/08/06	2022/08/05
Directional coupler	NARDA	4226-10	CTA-303	2021/08/06	2022/08/05
High-Pass Filter	XingBo	XBLBQ-GTA18	CTA-402	2021/08/06	2022/08/05
High-Pass Filter	XingBo	XBLBQ-GTA27	CTA-403	2021/08/06	2022/08/05
Automated filter bank	Tonscend	JS0806-F	CTA-404	2021/08/06	2022/08/05
Power Sensor	Agilent	U2021XA	CTA-405	2021/08/06	2022/08/05
Amplifier	Schwarzbeck	BBV9719	CTA-406	2021/08/06	2022/08/05

4 TEST CONDITIONS AND RESULTS

4.1 AC Power Conducted Emission

TEST CONFIGURATION

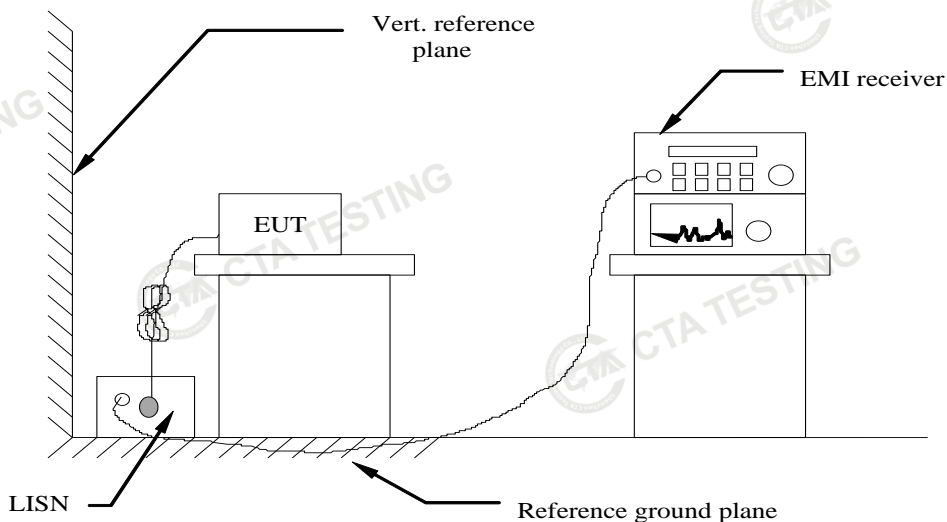

TEST PROCEDURE

- 1 The equipment was set up as per the test configuration to simulate typical actual usage per the user's manual. The EUT is a tabletop system, a wooden table with a height of 0.8 meters is used and is placed on the ground plane as per ANSI C63.10-2013.
- 2 Support equipment, if needed, was placed as per ANSI C63.10-2013
- 3 All I/O cables were positioned to simulate typical actual usage as per ANSI C63.10-2013
- 4 The EUT received DC12V power from adapter, the adapter received AC120V/60Hz and AC 240V/60Hz power through a Line Impedance Stabilization Network (LISN) which supplied power source and was grounded to the ground plane.
- 5 All support equipments received AC power from a second LISN, if any.
- 6 The EUT test program was started. Emissions were measured on each current carrying line of the EUT using a spectrum Analyzer / Receiver connected to the LISN powering the EUT. The LISN has two monitoring points: Line 1 (Hot Side) and Line 2 (Neutral Side). Two scans were taken: one with Line 1 connected to Analyzer / Receiver and Line 2 connected to a 50 ohm load; the second scan had Line 1 connected to a 50 ohm load and Line 2 connected to the Analyzer / Receiver.
- 7 Analyzer / Receiver scanned from 150 KHz to 30MHz for emissions in each of the test modes.
- 8 During the above scans, the emissions were maximized by cable manipulation.

AC Power Conducted Emission Limit

For intentional device, according to § 15.207(a) AC Power Conducted Emission Limits is as following :

Frequency range (MHz)	Limit (dBuV)	
	Quasi-peak	Average
0.15-0.5	66 to 56*	56 to 46*
0.5-5	56	46
5-30	60	50

* Decreases with the logarithm of the frequency.

TEST RESULTS

Remark:

Shenzhen CTA Testing Technology Co., Ltd.

Room 106, Building 1, Yibaolai Industrial Park, Qiaotou Community, Fuhai Street, Bao'an District, Shenzhen, China
 Tel:+86-755 2322 5875 E-mail:cta@cta-test.cn Web:http://www.cta-test.cn

1. All modes of GFSK, $\pi/4$ DQPSK and 8DPSK were test at Low, Middle, and High channel; only the worst result of GFSK Middle Channel was reported as below:
2. Both 120 VAC, 50/60 Hz and 240 VAC, 50/60 Hz power supply have been tested, only the worst result of 120 VAC, 60 Hz was reported as below:

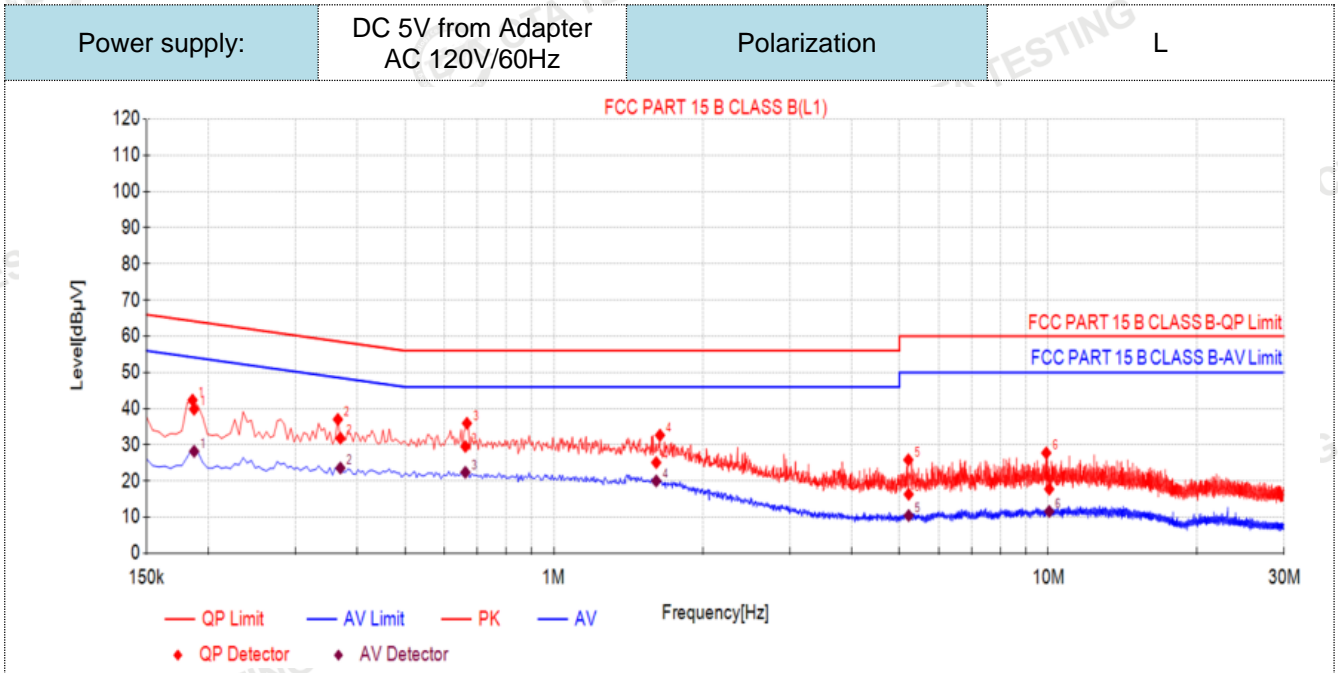

Final Data List

NO.	Freq. [MHz]	Factor [dB]	QP Reading[dB µV]	QP Value [dBµV]	QP Limit [dBµV]	QP Margin [dB]	AV Reading [dBµV]	AV Value [dBµV]	AV Limit [dBµV]	AV Margin [dB]	Verdict
1	0.1874	10.50	29.35	39.85	64.15	24.30	17.70	28.20	54.15	25.95	PASS
2	0.3702	10.50	21.35	31.85	58.50	26.65	13.09	23.59	48.50	24.91	PASS
3	0.6627	10.50	19.04	29.54	56.00	26.46	11.88	22.38	46.00	23.62	PASS
4	1.6113	10.50	14.60	25.10	56.00	30.90	9.51	20.01	46.00	25.99	PASS
5	5.2208	10.50	5.83	16.33	60.00	43.67	-0.04	10.46	50.00	39.54	PASS
6	10.0427	10.50	7.26	17.76	60.00	42.24	1.09	11.59	50.00	38.41	PASS

- Note:1). QP Value (dBµV) = QP Reading (dBµV) + Factor (dB)
 2). Factor (dB) = insertion loss of LISN (dB) + Cable loss (dB)
 3). QPMargin(dB) = QP Limit (dBµV) - QP Value (dBµV)
 4). AVMargin(dB) = AV Limit (dBµV) - AV Value (dBµV)

Power supply:	DC 5V from Adapter AC 120V/60Hz	Polarization	N
---------------	---------------------------------	--------------	---

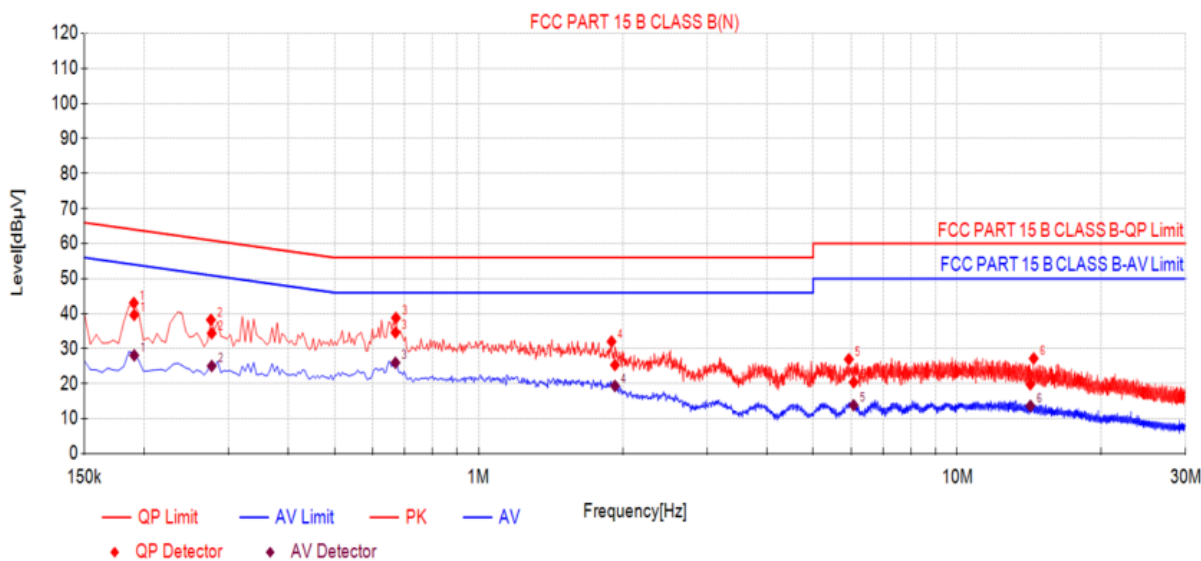

Final Data List											
NO.	Freq. [MHz]	Factor [dB]	QP Reading[dB µV]	QP Value [dBµV]	QP Limit [dBµV]	QP Margin [dB]	AV Reading [dBµV]	AV Value [dBµV]	AV Limit [dBµV]	AV Margin [dB]	Verdict
1	0.1908	10.50	29.14	39.64	64.00	24.36	17.60	28.10	54.00	25.90	PASS
2	0.2771	10.50	23.91	34.41	60.90	26.49	14.55	25.05	50.90	25.85	PASS
3	0.6705	10.50	24.09	34.59	56.00	21.41	15.49	25.99	46.00	20.01	PASS
4	1.9275	10.50	14.84	25.34	56.00	30.66	8.86	19.36	46.00	26.64	PASS
5	6.0759	10.50	9.93	20.43	60.00	39.57	3.34	13.84	50.00	36.16	PASS
6	14.2167	10.50	9.32	19.82	60.00	40.18	3.17	13.67	50.00	36.33	PASS

Note:1).QP Value (dBµV)= QP Reading (dBµV)+ Factor (dB)

2). Factor (dB)=insertion loss of LISN (dB) + Cable loss (dB)

3). QPMargin(dB) = QP Limit (dBµV) - QP Value (dBµV)

4). AVMargin(dB) = AV Limit (dBµV) - AV Value (dBµV)

4.2 Maximum Output Power

Limit

The maximum radiated power shall not exceed the following values:

- (1) In the bands allocated and assigned for broadcast television and in the 600 MHz service band: 50 mW EIRP
- (2) In the 600 MHz guard band and the 600 MHz duplex gap: 20 mW EIRP.

Test Procedure

1. EUT was placed on a 1.5 meter high non-conductive stand at a 3 meter test distance from the receive antenna. A receiving antenna was placed on the antenna mast 3 meters from the EUT for emission measurements. The height of receiving antenna is 1.5m. Detected emissions were maximized at each frequency by rotating the EUT through 360° and adjusting the receiving antenna polarization. The radiated emission measurements of all test transmit frequencies were measured with peak detector.
2. A log-periodic antenna or double-ridged waveguide horn antenna shall be substituted in place of the EUT. The log-periodic antenna will be driven by a signal generator and the level will be adjusted till the same power value on the spectrum analyzer or receiver. The level of the spurious emissions can be calculated through the level of the signal generator, cable loss, the gain of the substitution antenna and the reading of the spectrum analyzer or receiver.
3. The EUT is then put into continuously transmitting mode at its maximum power level during the test. Set Test Receiver or Spectrum RBW=1MHz, VBW=3MHz, And the maximum value of the receiver should be recorded as (P_r).
4. The EUT shall be replaced by a substitution antenna. In the chamber, an substitution antenna for the frequency band of interest is placed at the reference point of the chamber. An RF Signal source for the frequency band of interest is connected to the substitution antenna with a cable that has been constructed to not interfere with the radiation pattern of the antenna. A power (P_{Mea}) is applied to the input of the substitution antenna, and adjust the level of the signal generator output until the value of the receiver reach the previously recorded (P_r). The power of signal source (P_{Mea}) is recorded. The test should be performed by rotating the test item and adjusting the receiving antenna polarization.
5. An amplifier may be connected to the Signal Source output port. And the cable should be connect between the Amplifier and the Substitution Antenna. The cable loss (P_{cl}), the Substitution Antenna Gain (G_a) and the Amplifier Gain (P_{Ag}) should be recorded after test. The measurement results are obtained as described below:

$$\text{Power(EIRP)} = P_{Mea} + P_{Ag} - P_{cl} + G_a$$
6. This value is EIRP since the measurement is calibrated using an antenna of known gain (2.15 dBi) and known input power.
7. ERP can be calculated from EIRP by subtracting the gain of the dipole, $ERP = EIRP - 2.15\text{dBi}$.

Test Configuration

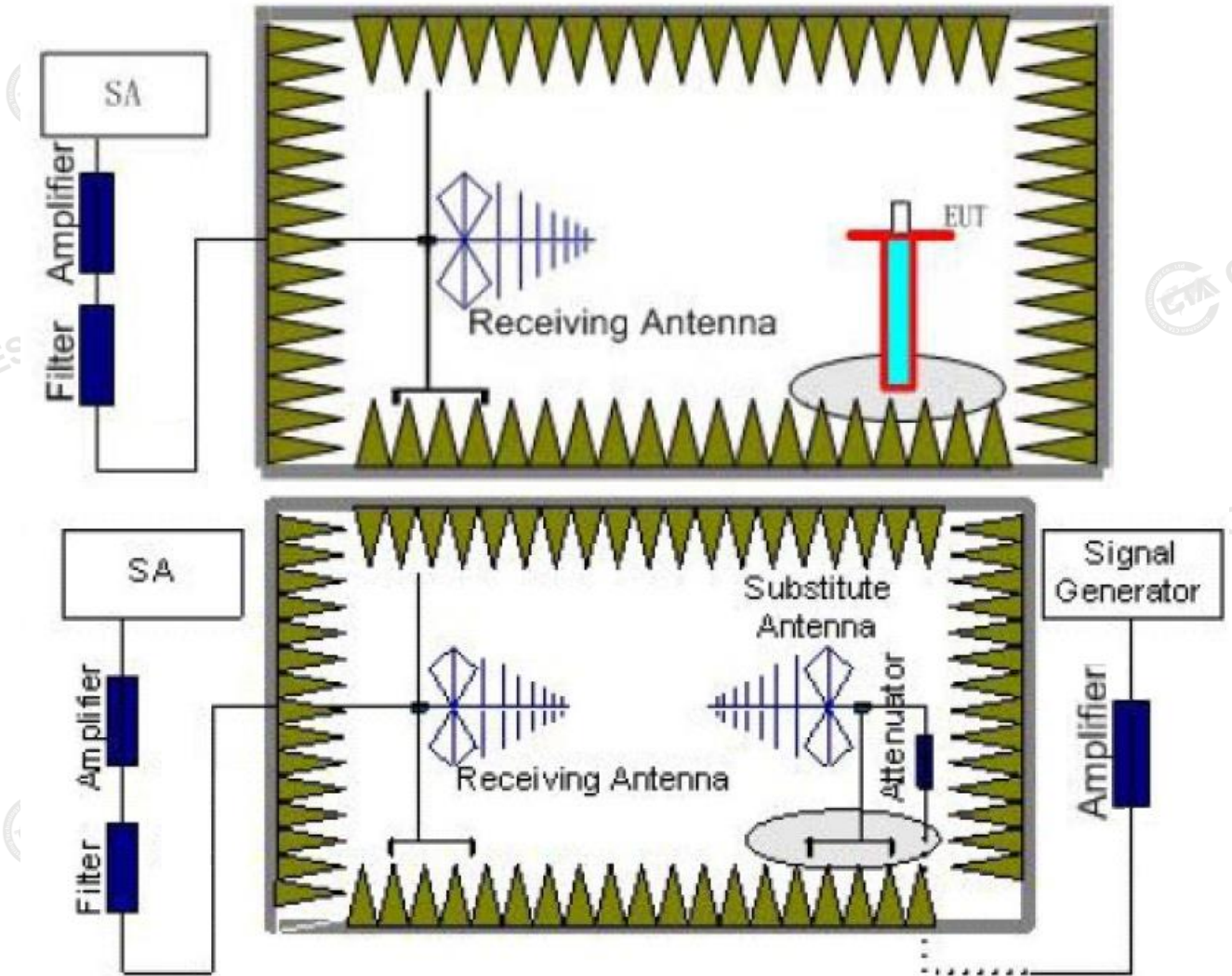

Test Results

Remark;

The field strength of radiation emission was measured in the following position: EUT stand-up position (Z axis), lie-down position (X, Y axis). The data show in this report only with the worst case setup. After exploratory measurement the worst case of H axis and receiver antenna at vertical polarization was reported.

Test Frequency (MHz)	P _{Mea} (dBm)	P _{cl} (dB)	G _a Antenna Gain(dBi)	P _{Ag} (dB)	EIRP (dBm)	EIRP (mW)	FCC Limit (mW)	Polarization
570.5	-27.38	1.57	9.65	26.8	7.5	5.62	50	H
584.5	-27.14	1.57	9.65	26.8	7.74	5.94	50	H
598.5	-27.19	1.57	9.65	26.8	7.69	5.87	50	H

Remark: $EIRP = P_{Mea}(dBm) + P_{Ag}(dB) - P_{cl}(dB) + G_a(dBi)$

4.3 Occupied Bandwidth

Limit

One or more adjacent 25 kHz segments within the assignable frequencies may be combined to form a channel whose maximum bandwidth shall not exceed 200 kHz. The operating bandwidth shall not exceed 200 kHz.

Test Procedure

The transmitter output was connected to the spectrum analyzer through an attenuator. The bandwidth of the fundamental frequency was measured by spectrum analyzer with 3 KHz RBW and 10 KHz VBW.

Test Configuration

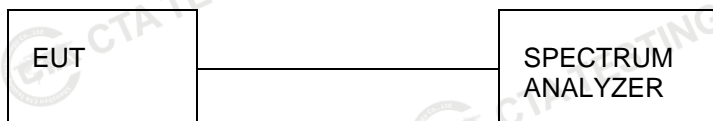

Test Results

Modulation	Frequency (MHz)	99% OBW (KHz)	Limit (KHz)	Result
FM	570.5	61.505	200	Pass
FM	584.5	62.812	200	Pass
FM	598.5	62.006	200	Pass

Plots of Occupied Bandwidth



570.5MHz



584.5MHz



598.5MHz

Shenzhen CTA Testing Technology Co., Ltd.

Room 106, Building 1, Yibaolai Industrial Park, Qiaotou Community, Fuhai Street, Bao'an District, Shenzhen, China
 Tel:+86-755 2322 5875 E-mail:cta@cta-test.cn Web:http://www.cta-test.cn

4.4 Necessary Bandwidth

LIMIT

Emissions within the band from one megahertz below to one megahertz above the carrier frequency shall comply with the emission mask in §8.3 of ETSI EN 300 422-1 V1.4.2 (2011-08) as below:

The transmitter output spectrum shall be within the mask defined in figure below where B is the declared channel bandwidth

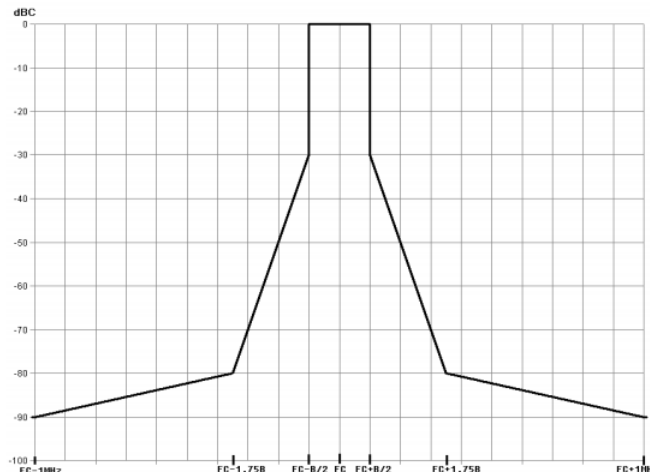

TEST PROCEDURE

1. With the Low Frequency (LF) audio signal generator set to 500 Hz, the audio input level to the EUT shall be Adjusted to 8 dB below the limiting threshold (-8dB limit) as declared by the manufacturer.
2. The corresponding audio output level from the demodulator shall be measured and recorded.
3. The input impedance of the noise meter shall be sufficiently high to avoid more than 0.1 dB changes in input level when the meter is switched between input and output.
4. The audio input level shall be increased by 20 dB, i.e. to 12 dB (lim), and the corresponding change in output level shall be measured.
5. It shall be checked that the audio output level has increased by ≤ 10 dB.
6. If the step 5 is not met, the initial audio input level shall be increased from -8 dB (lim) in 1 dB steps until the above condition is fulfilled, and the input level recorded in the test report. This level replaces the value derived from the manufacturer's declaration and is defined as -8dB (lim).
7. Measure the input level at the transmitter required to give +12 dB (lim) and record the EUT output level test plots by the spectrum analyzer.
8. The transmitter RF output spectrum shall be measured, using a spectrum analyser with the following settings:
 - centre frequency: fc: Transmitter (Tx) nominal frequency;
 - dispersion (Span): fc - 1 MHz to fc + 1 MHz;
 - Resolution BandWidth (RBW): 1 kHz;
 - Video BandWidth (VBW): 1 kHz;
 - detector: Peak hold.

TEST CONFIGURATION

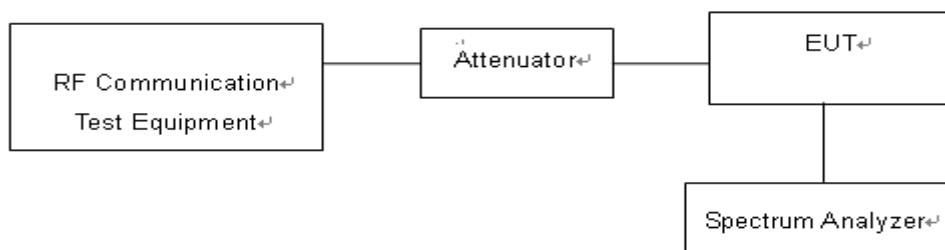

TEST RESULTS

Note:

	Bandwidth(B)	B/2	0.35B
Manufacturer declare	200 KHz	100KHz	70KHz

Plots of Necessary Bandwidth

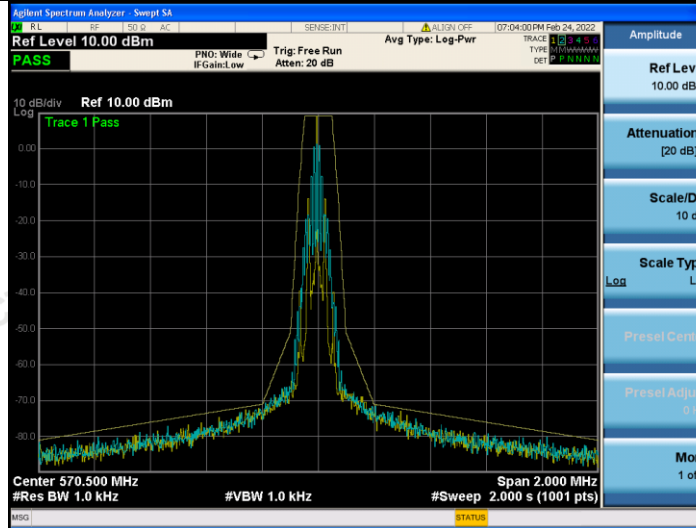

570.5MHz

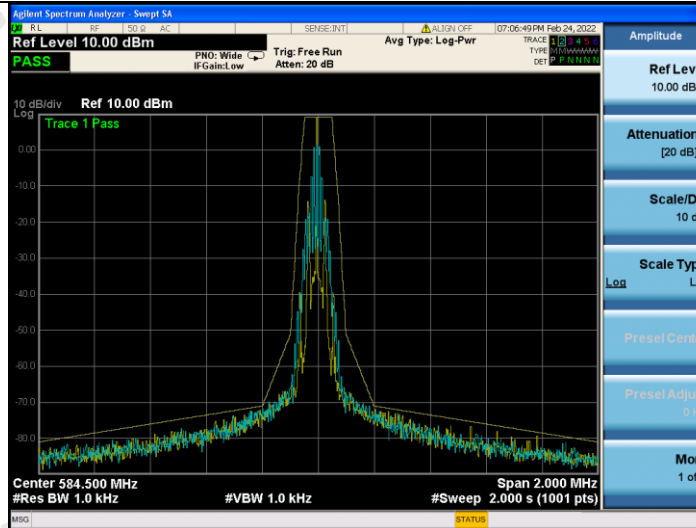

584.5MHz

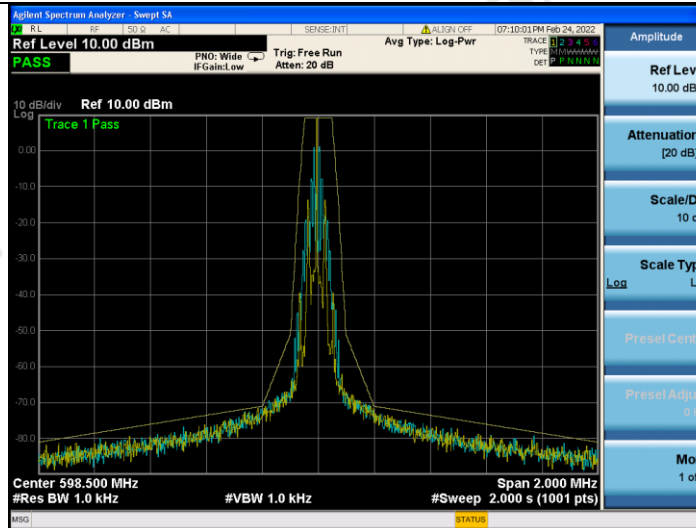

598.5MHz

Shenzhen CTA Testing Technology Co., Ltd.

Room 106, Building 1, Yibaolai Industrial Park, Qiaotou Community, Fuhai Street, Bao'an District, Shenzhen, China
 Tel:+86-755 2322 5875 E-mail:cta@cta-test.cn Web:http://www.cta-test.cn

4.5 Transmitter spurious emissions

Limit

Spurious emissions are emissions outside the frequency range(s) of the equipment. The power of the spurious emissions shall not exceed the limits of table as below:

State	Frequency		
	47 MHz to 74 MHz 87,5 MHz to 137 MHz 174 MHz to 230 MHz 470 MHz to 862 MHz	Other Frequencies below 1 000 MHz	Frequencies above 1 000 MHz
Operation	4 nW	250 nW	1 μ W
Standby	2 nW	2 nW	20 nW

Test Configuration

Effective Radiated Power measurement (30 MHz to 12.75 GHz)

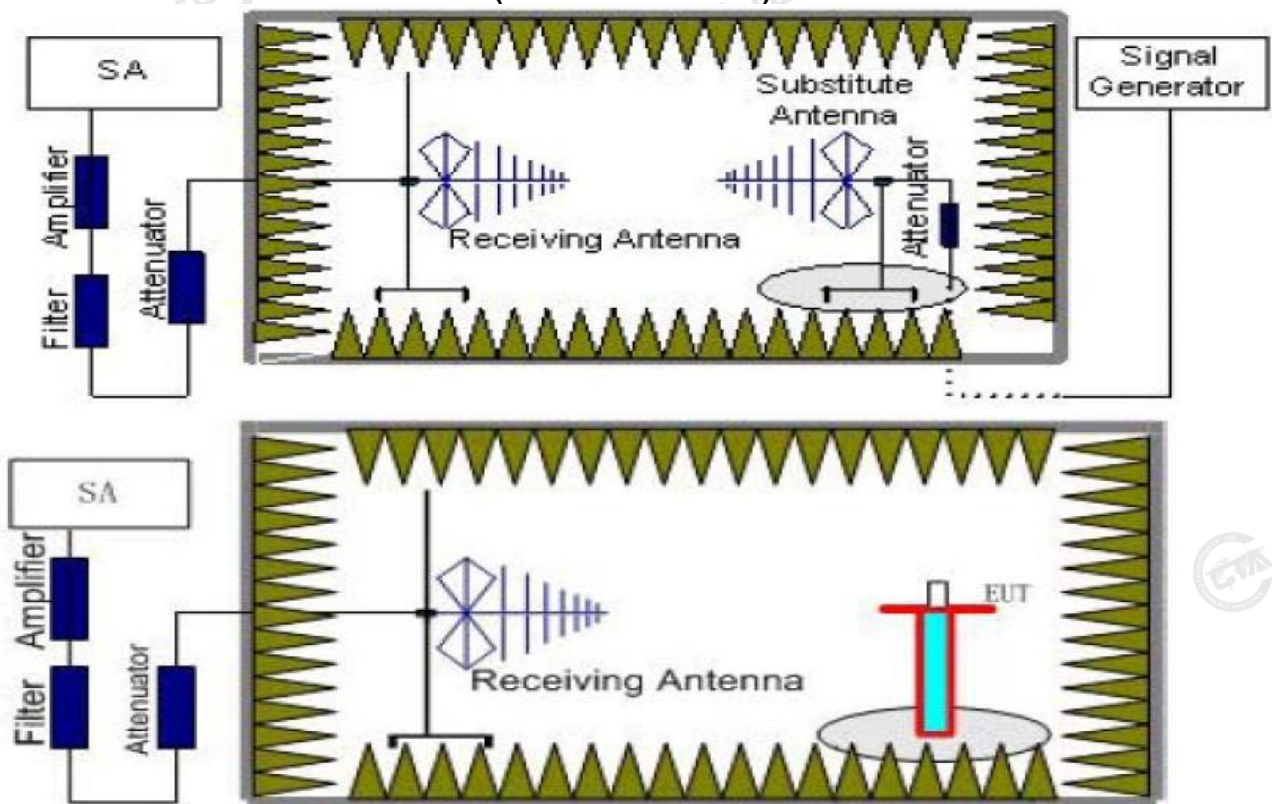

TEST PROCEDURE

1. The EUT was placed on a turntable with 1.5m height.
2. The test distance between the receiving antenna and the EUT is 3 meter, while the receiving (test) antenna is kept at 1.5 meter height.
3. Set EUT in continuous transmitting with maximum output power at test frequency.
4. The table was rotated from 0 to 360 degree to search the highest radiated emission.
5. Repeat step 3 to 4 for each polarization and test channel to find the worst emission level.
6. The results obtained are compared to the limits in order to prove compliance with the requirement.

TEST RESULTS

The test frequency range from 25MHz to 4GHz and recorded worst at below:

Test mode: Tx (570.5MHz)					
Frequency (MHz)	Pol./Ant	Measurement EIRP (dBm)	Limit (dBm)	Margin (dB)	Result
419.47	V	-49.22	-36	13.22	PASS
1141	V	-36.59	-30	6.59	
1711.5	V	-35.30	-30	5.3	
2282	V	-35.80	-30	5.8	
--	V	--	--	--	
416.35	H	-47.97	-36	11.97	
1141	H	-35.94	-30	5.94	
1711.5	H	-32.16	-30	2.16	
2282	H	-37.39	-30	7.39	
--	H	--	--	--	

Test mode: Tx (584.50MHz)					
Frequency (MHz)	Pol./Ant	Measurement EIRP (dBm)	Limit (dBm)	Margin (dB)	Result
378.48	V	-47.93	-36	11.93	PASS
1169	V	-36.88	-30	6.88	
1753.5	V	-40.74	-30	10.74	
2338	V	-41.67	-30	11.67	
--	V	--	--	--	
338.68	H	-51.46	-36	15.46	
1169	H	-34.30	-30	4.3	
1753.5	H	-35.30	-30	5.3	
2338	H	-40.24	-30	10.24	
--	H	--	--	--	

Test mode: Tx (598.50MHz)					
Frequency (MHz)	Pol./Ant	Measurement EIRP (dBm)	Limit (dBm)	Margin (dB)	Result
249.35	V	-51.80	-36	15.8	PASS
1197	V	-35.57	-30	5.57	
1795.5	V	-37.76	-30	7.76	
2394	V	-37.72	-30	7.72	
--	V	--	--	--	
249.31	H	-47.06	-36	11.06	
1197	H	-36.79	-30	6.79	
1795.5	H	-40.88	-30	10.88	
2394	H	-40.08	-30	10.08	
--	H	--	--	--	

Remark:

- The test frequency range from 25MHz to 4GHz, RBW/VBW: 100 KHz/300KHz below 1GHz, RBW/VBW: 1000 KHz/3000KHz above 1GHz.
- "Other emission levels were very low against the limit and not reported.

4.6 Frequency Stability

Limit

The frequency tolerance of the carrier signal shall be maintained within $\pm 0.005\%$ of the operating frequency over a temperature variation of -20 degrees to $+50$ degrees C at normal supply voltage, and for a variation in the primary supply voltage from 85% to 115% of the rated supply voltage at a temperature of 20 degrees C. Battery operated equipment shall be tested using a new battery.

Test Procedure

a) Frequency stability versus environmental temperature

1. Setup as Test Configuration for frequencies measured at ambient temperature if it is within 15°C to 25°C . Otherwise, an environmental chamber set for a temperature of 20°C shall be used.
2. Turn on EUT and set SA center frequency to the right frequency needs to be measured. Then set SA RBW to 3 kHz, VBW to 10kHz and frequency span to 500 kHz. Record this frequency to be a reference.
3. Set the temperature of chamber to 50°C . Allow sufficient time (approximately 30 min) for the temperature of the chamber to stabilize. While maintaining a constant temperature inside the chamber, turn the EUT on and measure the EUT operating frequency.
4. Repeat step 2 with a 10°C decreased per stage until the lowest temperature -20°C is measured, record all measurement frequencies.

b) Frequency stability versus input voltage

1. Setup as Test Configuration for frequencies measured at ambient temperature if it is within 15°C to 25°C . Otherwise, an environmental chamber set for a temperature of 20°C shall be used. Install new batteries in the EUT.
2. Set SA center frequency to the right frequency needs to be measured. Then set SA RBW to 3kHz, VBW to 10kHz and frequency span to 500 kHz. Record this frequency to be a reference.
3. For non hand carried, battery operated device, supply the EUT primary voltage with 85 and 115 percent of the nominal value and record the frequency.

Test Configuration

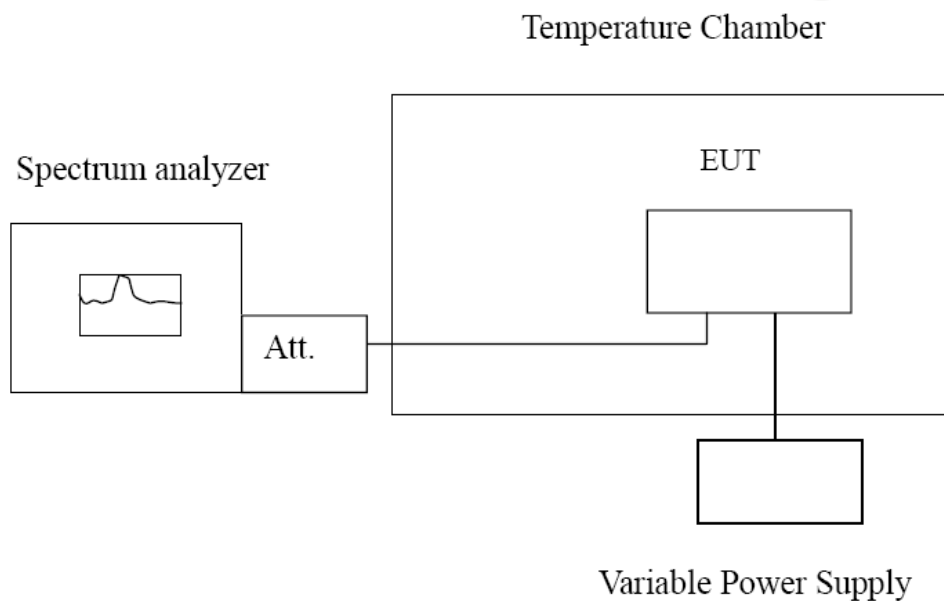

Test Results

Reference Frequency: 570.5MHz					
Voltage (V)	Temperature (°C)	Frequency error (MHz)	Frequency Tolerance (%)	Limit (%)	Result
3.70	-20	0.00082	0.000144%	±0.005	PASS
	-10	0.00071	0.000124%		
	0	0.00064	0.000112%		
	10	0.00053	0.000093%		
	20	0.00075	0.000131%		
	30	0.00061	0.000107%		
	40	0.00086	0.000151%		
	50	0.00075	0.000131%		
4.26	20	0.00081	0.000142%		
3.15	20	0.00061	0.000107%		

Reference Frequency: 584.5MHz					
Voltage (V)	Temperature (°C)	Frequency error (MHz)	Frequency Tolerance (%)	Limit (%)	Result
3.70	-20	0.00074	0.000127%	±0.005	PASS
	-10	0.00065	0.000111%		
	0	0.00063	0.000108%		
	10	0.00054	0.000092%		
	20	0.00073	0.000125%		
	30	0.00066	0.000113%		
	40	0.00072	0.000123%		
	50	0.00081	0.000139%		
4.26	20	0.00063	0.000108%		
3.15	20	0.00073	0.000125%		

Reference Frequency: 598.5MHz					
Voltage (V)	Temperature (°C)	Frequency error (MHz)	Frequency Tolerance (%)	Limit (%)	Result
3.70	-20	0.00072	0.000120%	±0.005	PASS
	-10	0.00066	0.000110%		
	0	0.00071	0.000119%		
	10	0.00063	0.000105%		
	20	0.00075	0.000125%		
	30	0.00073	0.000122%		
	40	0.00065	0.000109%		
	50	0.00064	0.000107%		
4.26	20	0.00062	0.000104%		
3.15	20	0.00059	0.000099%		

5 Test Setup Photos of the EUT

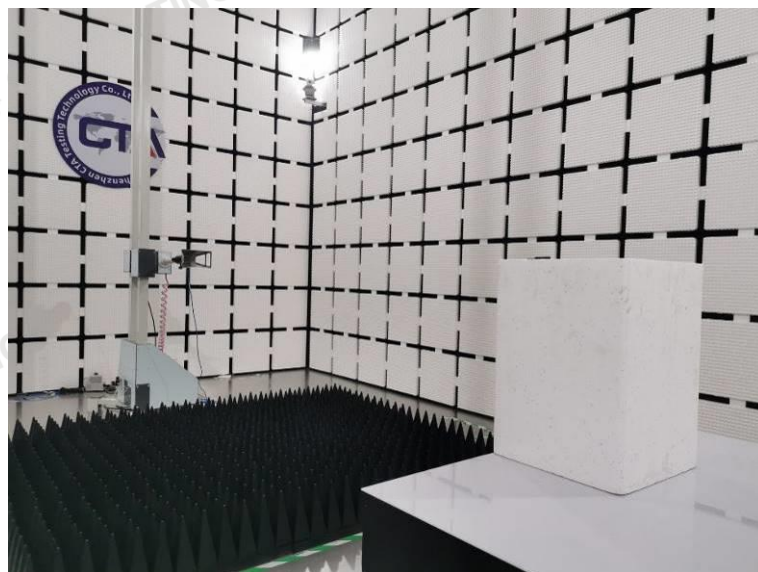
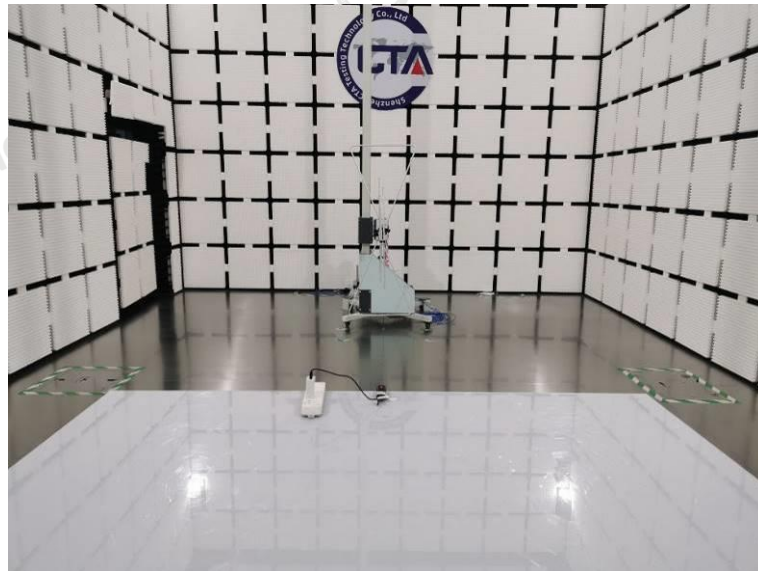

6 Photos of the EUT

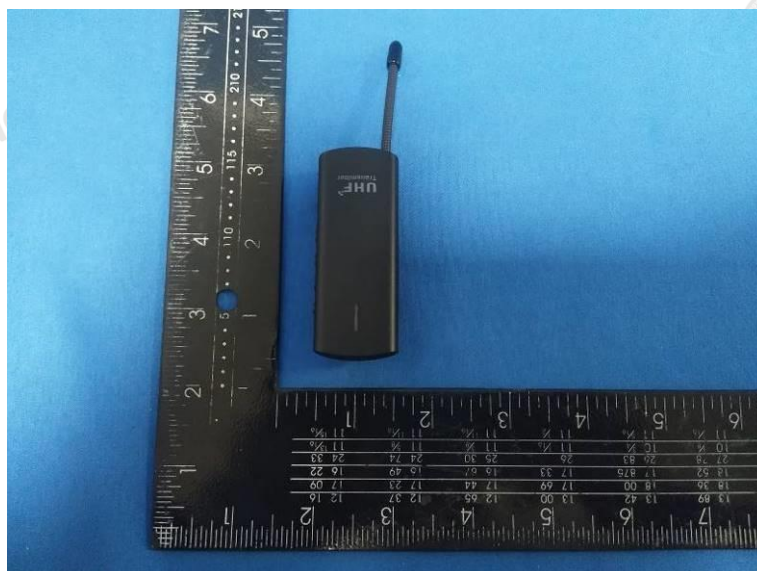
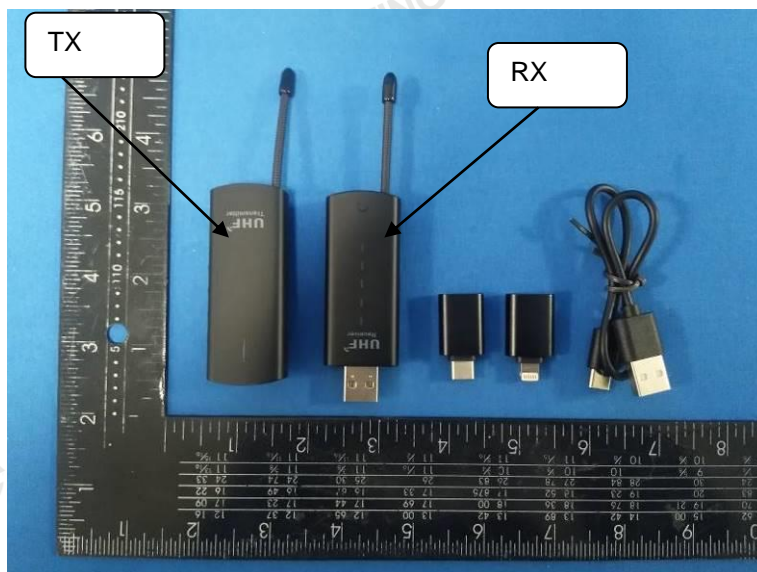

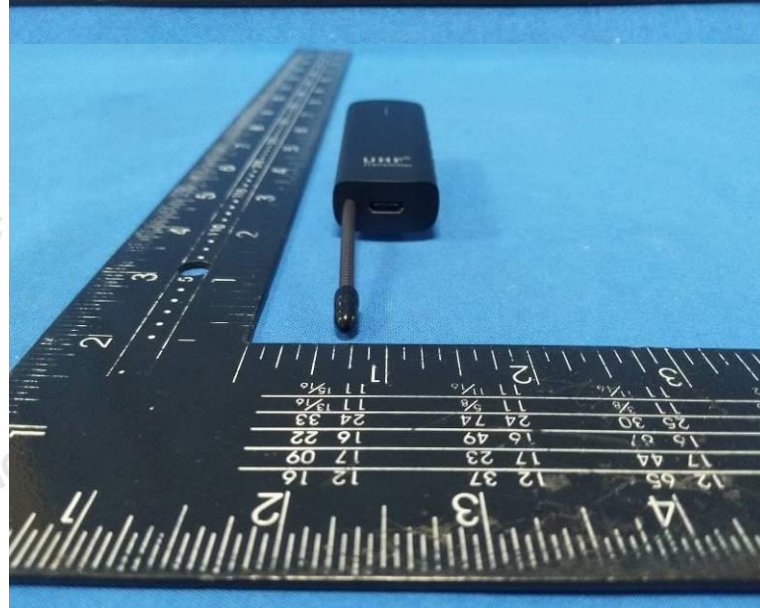
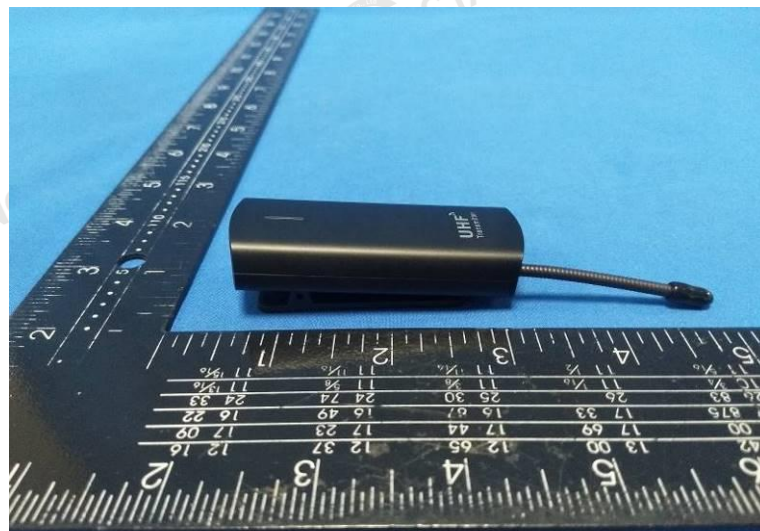
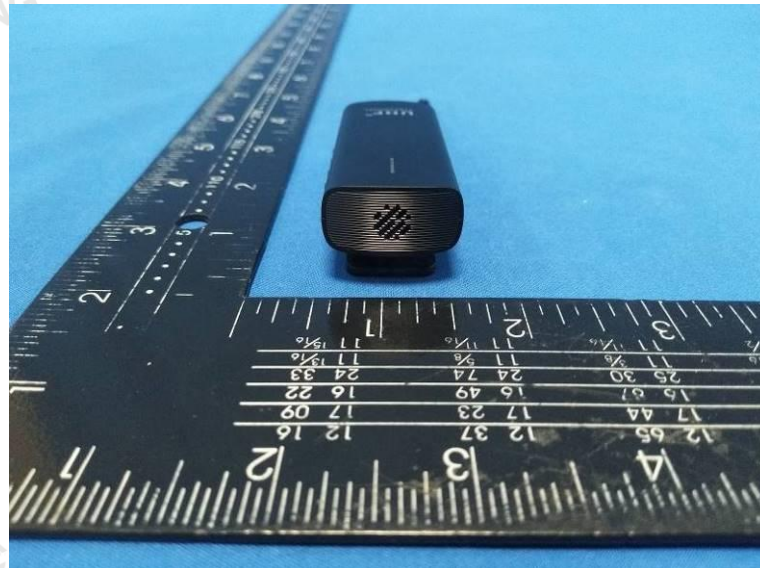



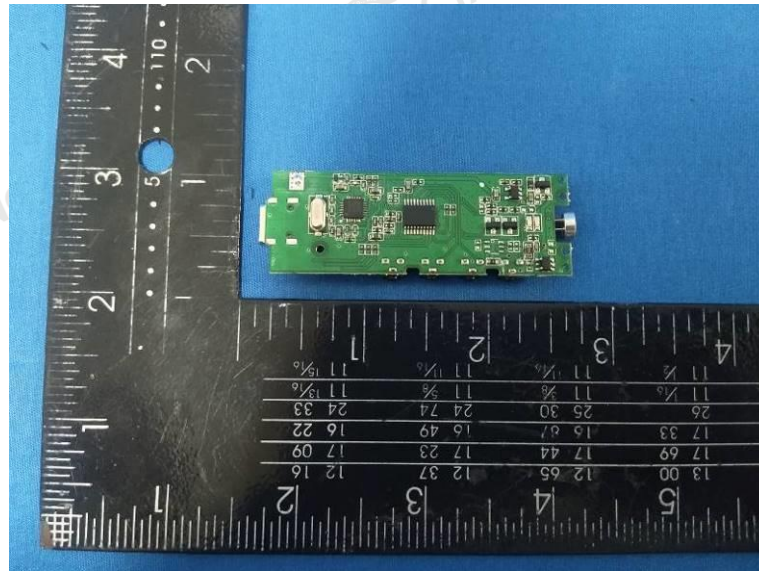
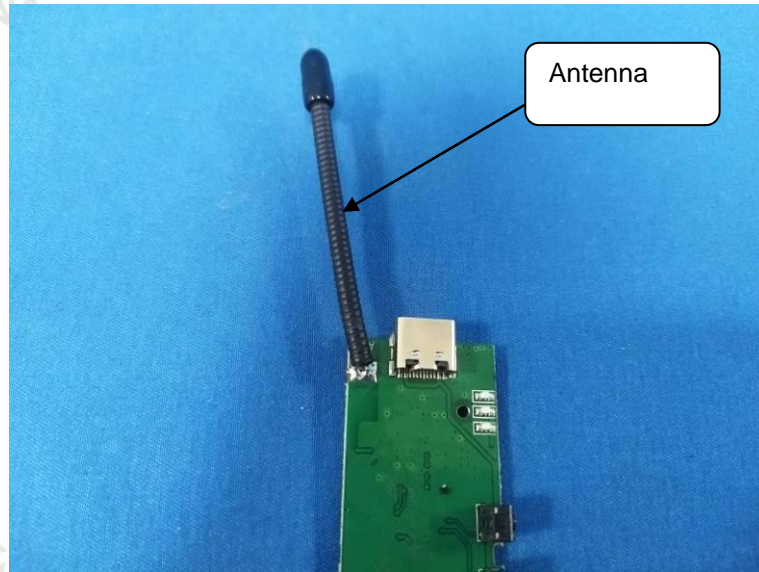

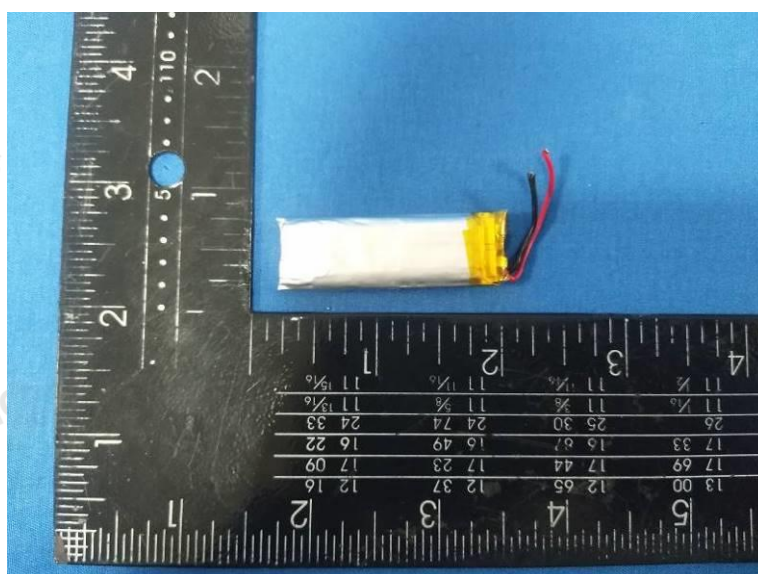
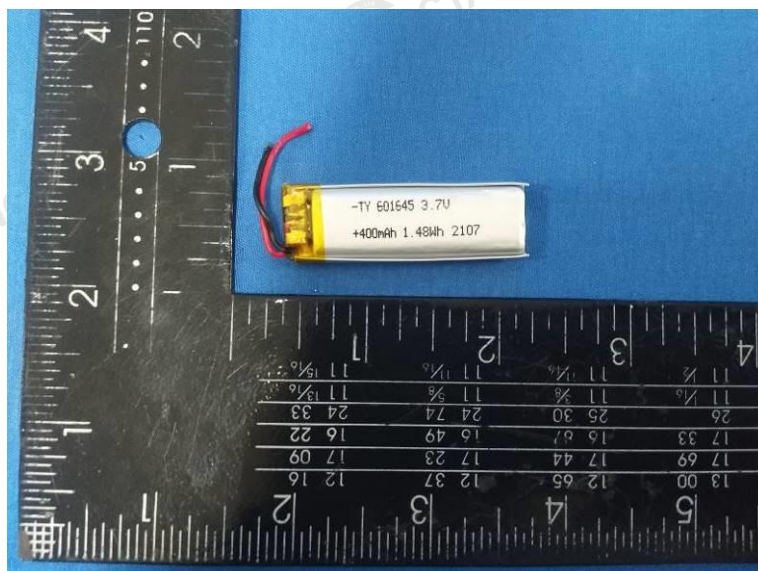
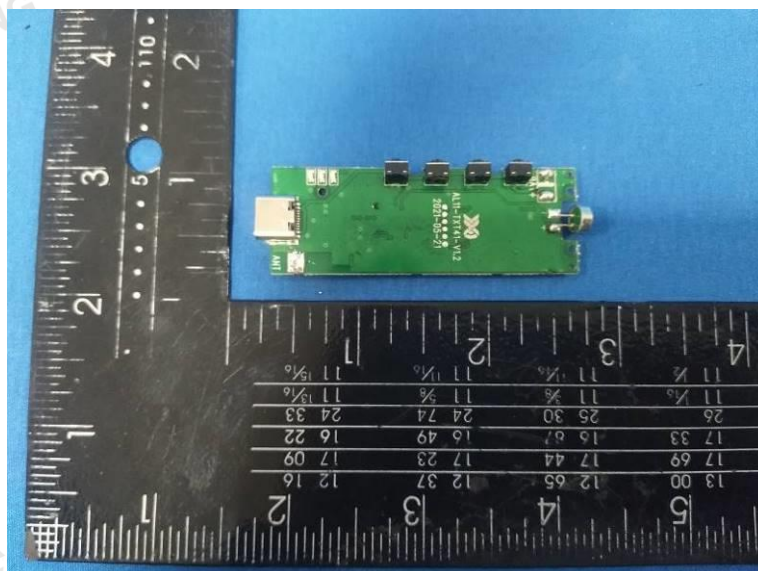

***** End of Report *****

Shenzhen CTA Testing Technology Co., Ltd.

Room 106, Building 1, Yibaolai Industrial Park, Qiaotou Community, Fuhai Street, Bao'an District, Shenzhen, China
Tel:+86-755 2322 5875 E-mail:cta@cta-test.cn Web:http://www.cta-test.cn