



Digital Photo Frame

Dream Plus

Moments Never Fade

User Manual

Table of Contents

AEEZO Dream Plus Frame Overview.....	2
Initial Setup.....	4
Download the Frameo App on Your Phone.....	5
Connecting to a Frame.....	6
Sharing Photos/Videos.....	7
Quick Menu.....	8
Detailed Settings Menu.....	9
My Frame.....	9
Manage Photos.....	10
My Friends.....	11
Display.....	11
Slideshow.....	12
Wi-Fi.....	12
Notifications.....	12
Backup and Restore.....	13
Help & About.....	13
Warranty & Contact Us.....	14

AAEZO Dream Plus Frame Overview

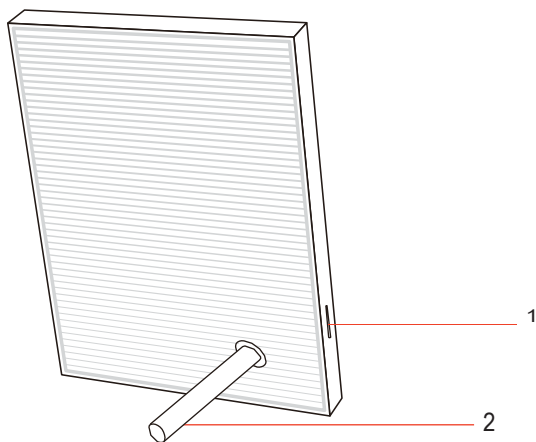

1. SD Card Slot

SD cards can be used to import photos to the frame. Photos can also be exported to a SD card from the frame to make a backup or move to a computer, etc. Note that photos cannot be displayed directly from a SD card. Please ensure that your SD card is using FAT32 or NTFS file system. If not, you can reformat the card to one of these file systems.

2. Integrated Frame Stand & AC Adapter

AEEZO Dream Plus Specifications	
Screen	9.7-inch Touchscreen
Resolution	2048 x 1536 2K IPS FHD display
Wi-Fi	5GHz/2.4GHz
CPU	Quad-core A53 1.8G
GPU	Mali-T760 732MHz
RAM	2G DDR3
Storage*	16G

*Storage specifications refer to capacity before formatting. Actual formatted capacity will be less.

Initial Setup

1. Plug in the power adapter included in the box to turn on the frame.
2. You may need to wait for up to 15 seconds as the Frameo system is loading.
3. Follow the prompts to set up the frame. You can use the touchscreen to navigate through the setup menus.

- 1) First start by selecting a language. This will be used as the system language and in all menus.
- 2) Connect your frame to the internet by selecting a Wi-Fi network and entering the password.
- 3) If a newer version of the Frameo software is available, then you will be prompted with an update dialog. It is recommended that you update your frame immediately if prompted.
- 4) Enter your name and the location where you will place the frame (e.g. “John Smith” and “Living room,” “Kitchen,” or “Office.”) Finally, set the time zone.

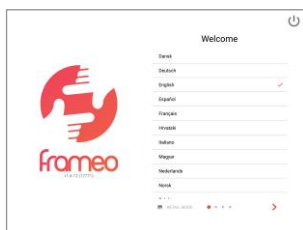

1. Select a language

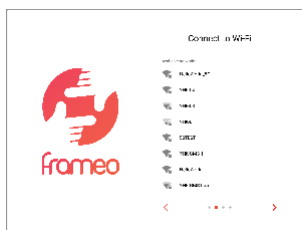

2. Connect to Wi-Fi

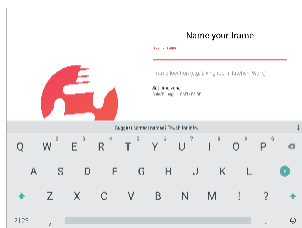
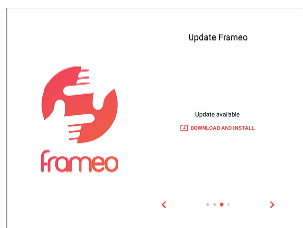

3. Update to the latest version

4. Enter your name

Your frame is now online. You can proceed to link your frame to mobile devices and start sharing photos and videos.

Download the Frameo App on Your Phone

To share your special moments with AEEZO digital photo frames from anywhere in the world, start by downloading the free app Frameo on your mobile device.



Search “Frameo” in the App Store (iOS) or on Google Play (Android) to download Frameo, or scan the QR code below.



Follow the prompts in the app to set up your profile, including your name and profile picture.

Connecting to a Frame

In order to send pictures to an AEEZO frame, you need to connect to the frame using the Frameo App. Follow the steps below to connect.

- 1. Tap the add friend icon  on your frame. A box will appear with a unique code which is valid for 12 hours.
- 2. Now go to the Frameo app on your phone and click the add friend icon  in the top right corner, then enter the code from the frame. Your mobile app is now connected to the frame.
- 3. Share the frame code with your friends or family. They can add the frame and start sharing photos to the frame. There is no limit to the number of mobile users that can connect to the frame.



Download the Frameo app on your phone



Click the add friend icon on your frame



Share the code



Enter the code in the Frameo app



You can now send photos from your phone to the frame

Sharing Photos & Videos from Frameo to an AEEZO Frame

Once you have connected to a frame on the mobile app, you can select photos and videos to share to the frame. If sharing from your gallery, you can send up to 10 photos at a time or send one short video (up to 15 seconds). You can also take photos or video directly in the app.

The Frameo app



Take a photo or video or select one or more from your albums



Choose one or more recipients



Write a caption to send with the image

Quick Menu

Simply tap the screen once, and the quick menu will appear. You can use this menu to adjust/hide the current photo and to access the gallery or other settings.



Gallery

View all photos stored in the frame.

Settings

Enter the detailed settings menu.

Hide photo

Tap this to make the current photo no longer appear in the slideshow. The photo will not be deleted.

Fit to frame

The photo will be fully displayed on the frame in either orientation. Extra background space will be blurred out. This only applies to the current photo.

Fill frame

The photo will be cropped to fully fill the screen in either orientation. (Note: you can set the default display mode for all photos in Settings - Slideshow)

Adjust photo

Adjust which part of the photo is displayed while using fill frame mode.

Detailed Settings Menu

Tap the screen to access the quick menu, then tap the Settings icon  to view detailed settings and options for the frame. In settings, you can personalize your frame to meet your needs.

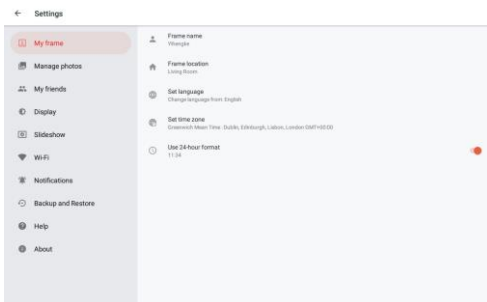

Detailed Settings Menu

My frame

Frame name

Changes the name of your frame. This name will also be seen by friends and family in their list of connected frames in the Frameo app.

Frame location

Changes the listed location of your frame. This location is displayed on your friends' and family's list of connected frames to help distinguish them from each other.

Set language

Sets the system language used throughout your frame.

Set time zone

Sets the time zone that will be used on your frame for features like sleep mode.

Manage photos

Photos stored



Shows total number of photos/videos on the frame and amount of available storage space.

Show/hide photos

Select which photos to hide by clicking them once. Hidden photos will not be displayed in the slideshow, however, they will not be deleted and can always be unhidden for future use.

Use  to hide or show all photos.

Delete photos

Select photos that you want to permanently delete from your frame by clicking them once. Use  to select or deselect all. Then click the trash can icon  in the top right corner to permanently delete.

Import photos

You can import photos from an SD card. Insert the SD card, then select the photos that you want to import to your frame.

Use  to select or deselect all. Then click the import button in the top right corner to start importing. At this time, videos cannot be imported from external storage.

Export photos

You can use an SD card to export all photos from the frame to external storage.

My Friends

This page contains a list of all people that are allowed to send photos to your frame.

Friend settings

Here you can give permission for the friend to share the frame code with others. You can also delete a friend if you no longer want to receive photos from them.

Delete friend

To remove a person from your friends list, tap delete friend. They will no longer have permission to send photos to your frame. You also have the option to delete all photos from this person at the same time.

Add friend

To allow a new person to send you photos, simply tap the add friend button  and share the frame code with that person. They will be added automatically once they connect to the frame through the mobile app.

Display

Brightness level

Adjust the brightness level of the screen.

Sleep mode

Sleep mode allows you to reduce power consumption by automatically turning off and waking up the device at set times. The default setting turns off the screen at 11:00 pm and wakes it up at 7:00 am. You can adjust the start/end time as desired.

Note: Your frame is not powered down while sleep mode is on, so it will not affect your ability to receive photos.

Slideshow

Timer

Define the duration each photo is displayed.

Show caption

Friends can add captions to photos when they share them to the frame. Check this option to display captions in the slideshow. Uncheck to hide captions.

Fill frame

You can choose between two modes as the default way to display photos.

Fill frame: Photos will be cropped to fully fill the screen in either orientation.

Fit to frame: Photos will be fully displayed on the frame in either orientation. Extra background space will be blurred out.

Photo display order

You can choose to display photos ordered by date or shuffled.

Video

You can adjust video volume, turn on/off autoplay, and change video playback mode.

Wi-Fi

Select a Wi-Fi network to connect to. If you are connecting to a network with a captive portal, a web browser icon should appear in top right corner of the screen. Click it to open a browser where you can enter credentials to access the network.

Notifications

Turn on/off notifications for a variety of items and adjust notification volume.

Backup and Restore

Back up frame to external storage

To back up the photos on the frame to a SD card, follow the below steps:

step 1: Insert SD card into the SD card slot.

step 2: Tap the screen and go to “Settings”

step 3: Go to “Backup and Restore”

step 4: Tap “Back up frame to external storage”

When complete, you will see “Last successful backup: (Date & Time)” appear underneath.

Note: Any existing backup on the SD card will be overwritten!

Automatic backup

If checked, your frame will automatically make a backup within 30 hours of you receiving new photos or making changes on your frame.

Reset frame

Removes all data from your frame. This will permanently remove all your photos/videos, friends, and settings.

Help & About

Share anonymous analytics data

Sharing anonymous analytics data helps tremendously with improving the Frameo software. We understand if you do not wish to share this data with us. Set as checked if you wish to help us improve Frameo. Set unchecked to deny the sharing of anonymous analytics data.

Guide

Opens the quick start guide that is shown during initial setup of the frame.

Check for update

Check for available software updates and download/install them on your frame.

Warranty & Contact Us

Thanks for choosing an AEEZO Digital Photo Frame. We provide lifetime customer support and a one-year quality warranty. If you have any questions or problems with our products, feel free to contact us at support@aezotech.com or call +1-866-666-0702. We typically respond within 24 hours. Your satisfaction is our priority.

FCC Statement

Changes or modifications not expressly approved by the party responsible for compliance could void the user's authority to operate the equipment.

This equipment has been tested and found to comply with the limits for a Class B digital device, pursuant to Part 15 of the FCC Rules. These limits are designed to provide reasonable protection against harmful interference in a residential installation. This equipment generates uses and can radiate radio frequency energy and, if not installed and used in accordance with the instructions, may cause harmful interference to radio communications. However, there is no guarantee that interference will not occur in a particular installation. If this equipment does cause harmful interference to radio or television reception, which can be determined by turning the equipment off and on, the user is encouraged to try to correct the interference by one or more of the following measures:

- Reorient or relocate the receiving antenna.
- Increase the separation between the equipment and receiver.
- Connect the equipment into an outlet on a circuit different from that to which the receiver is connected.

-- Consult the dealer or an experienced radio/TV technician for help

This device complies with part 15 of the FCC rules. Operation is subject to the following two conditions (1) this device may not cause harmful interference, and (2) this device must accept any interference received, including interference that may cause undesired operation.

This equipment complies with FCC radiation exposure limits set forth for an uncontrolled environment. This equipment should be installed and operated with minimum distance 20cm between the radiator & your body.