

FCC Part 15E Test Report

FCC ID: 2AW9M-DREAM01

Product Name:	Digital Photo Frame
Trademark:	N/A
Model Name :	Dream 01
Prepared For :	Shenzhen Efercro Electronic Technology Co., Ltd
Address :	510, Building U2, Junxiang U8 Intelligent Manufacturing Industrial Park, Xixiang Street, Baoan District, Shenzhen, Guangdong, China
Prepared By :	Shenzhen BCTC Testing Co., Ltd.
Address :	BCTC Building & 1-2F, East of B Building, Pengzhou Industrial, Fuyuan 1st Road, Qiaotou Community, Fuyong Street, Bao'an District, Shenzhen, China
Test Date:	Jul. 10, 2020 – Jul. 20, 2020
Date of Report :	Jul. 20, 2020
Report No.:	BCTC2007000333-2E

TEST RESULT CERTIFICATION

Applicant's name Shenzhen Efercro Electronic Technology Co., Ltd
Address 510, Building U2, Junxiang U8 Intelligent Manufacturing Industrial Park, Xixiang Street, Baoan District, Shenzhen, Guangdong, China

Manufacture's Name Shenzhen Efercro Electronic Technology Co., Ltd
Address 510, Building U2, Junxiang U8 Intelligent Manufacturing Industrial Park, Xixiang Street, Baoan District, Shenzhen, Guangdong, China

Product description

Product name..... Digital Photo Frame

Trademark N/A

Model and/or type reference Dream 01

Standards FCC Part15 15.407
ANSI C63.10-2013
KDB 789033 D02 v02r01

This device described above has been tested by BCTC, and the test results show that the equipment under test (EUT) is in compliance with the FCC requirements. And it is applicable only to the tested sample identified in the report.

This report shall not be reproduced except in full, without the written approval of BCTC, this document may be altered or revised by BCTC, personal only, and shall be noted in the revision of the document.

Prepared by(Engineer):

Sam zeng

Sam Zeng

Reviewer(Supervisor):

Eric Yang

Eric Yang

Approved(Manager):

Zero Zhou

Zero Zhou



Table of Contents

	Page
1 . SUMMARY OF TEST RESULTS	6
1.1 TEST FACILITY	7
1.2 MEASUREMENT UNCERTAINTY	7
2 . GENERAL INFORMATION	8
3 . EMC EMISSION TEST	14
3.1 CONDUCTED EMISSION MEASUREMENT	14
3.1.1 POWER LINE CONDUCTED EMISSION LIMITS	14
3.1.2 TEST PROCEDURE	15
3.1.3 DEVIATION FROM TEST STANDARD	15
3.1.4 TEST SETUP	15
3.1.5 EUT OPERATING CONDITIONS	15
3.2 RADIATED EMISSION MEASUREMENT	18
3.2.1 APPLICABLE STANDARD	18
3.2.2 CONFORMANCE LIMIT	18
3.2.3 MEASURING INSTRUMENTS	18
3.2.4 TEST CONFIGURATION	19
3.2.5 TEST PROCEDURE	20
3.2.6 TEST RESULTS (9KHZ – 30 MHZ)	21
3.2.7 TEST RESULTS (30MHZ – 1GHZ)	22
3.2.8 TEST RESULTS (1GHZ-40GHZ)	24
4 . POWER SPECTRAL DENSITY TEST	39
4.1 APPLIED PROCEDURES / LIMIT	39
4.2 TEST PROCEDURE	40
4.3 DEVIATION FROM STANDARD	40
4.4 TEST SETUP	40
4.5 EUT OPERATION CONDITIONS	40
4.6 TEST RESULTS	41
5 . 26DB & 6DB& 99% EMISSION BANDWIDTH	49
5.1 APPLIED PROCEDURES / LIMIT	49
5.2 TEST PROCEDURE	49
5.3 EUT OPERATION CONDITIONS	50
5.4 TEST RESULTS	51
6 . MAXIMUM CONDUCTED OUTPUT POWER	69
6.1 PPLIED PROCEDURES / LIMIT	69

Table of Contents

	Page
6.2 DEVIATION FROM STANDARD	71
6.3 TEST SETUP	71
6.4 EUT OPERATION CONDITIONS	71
6.5 TEST RESULTS	72
7 . OUT OF BAND EMISSIONS	74
7.1 APPLICABLE STANDARD	74
7.2 TEST PROCEDURE	74
7.3 DEVIATION FROM STANDARD	74
7.4 TEST SETUP	74
7.5 EUT OPERATION CONDITIONS	74
7.6 TEST RESULTS	75
8.SPURIOUS RF CONDUCTED EMISSIONS	89
8.1CONFORMANCE LIMIT	89
8.2MEASURING INSTRUMENTS	89
8.3TEST SETUP	89
8.4TEST PROCEDURE	89
8.5TEST RESULTS	89
9. FREQUENCY STABILITY MEASUREMENT	104
9.1 LIMIT	104
9.2 TEST PROCEDURES	104
9.3 TEST SETUP LAYOUT	104
9.4 EUT OPERATION DURING TEST	104
9.5 TEST RESULTS	105
10. ANTENNA REQUIREMENT	111
10.1 STANDARD REQUIREMENT	111
10.2 EUT ANTENNA	111
11. EUT TEST PHOTO	112
12. EUT PHOTO	114

Revision History

Report No.	Version	Description	Issued Date
BCTC2007000333-2E	Rev.01	Initial issue of report	Jul. 20, 2020

1. SUMMARY OF TEST RESULTS

Test procedures according to the technical standards:

FCC Part15 (15.407) , Subpart E			
Standard Section	Test Item	Judgment	Remark
15.209(a), 15.407 (b)(1) 15.407 (b)(4) 15.407 (b)(6)	Spurious Radiated Emissions	PASS	
15.207	Conducted Emission	PASS	
15.407 (a)(5) 15.1049	26 dB and 99% Emission Bandwidth	PASS	
15.407(e)	Minimum 6 dB bandwidth	PASS	
15.407 (a)(1) 15.407 (a)(3)	Maximum Conducted Output Power	PASS	
2.1051, 15.407(b)(1) 15.407(b)(4)	Band Edge	PASS	
15.407 (a)(1) 15.407 (a)(3)	Power Spectral Density	PASS	
2.1051, 15.407(b)	Spurious Emissions at Antenna Terminals	PASS	
15.203	Antenna Requirement	PASS	

NOTE:

(1) "N/A" denotes test is not applicable in this Test Report

1.1 TEST FACILITY

Shenzhen BCTC Testing Co., Ltd.

Add. : BCTC Building & 1-2F, East of B Building, Pengzhou Industrial, Fuyuan 1st Road, Qiaotou Community, Fuyong Street, Bao'an District, Shenzhen, China

FCC Test Firm Registration Number: 712850

IC Registered No.: 23583

1.2 MEASUREMENT UNCERTAINTY

The reported uncertainty of measurement $y \pm U$, where expanded uncertainty U is based on a standard uncertainty multiplied by a coverage factor of $k=2$, providing a level of confidence of approximately **95 %**.

No.	Item	Uncertainty
1	3m chamber Radiated spurious emission(30MHz-1GHz)	U=4.3dB
2	3m chamber Radiated spurious emission(1GHz-18GHz)	U=4.5dB
3	3m chamber Radiated spurious emission(18GHz-40GHz)	U=3.34dB
4	Conducted Adjacent channel power	U=1.38dB
5	Conducted output power uncertainty Above 1G	U=1.576dB
6	Conducted output power uncertainty below 1G	U=1.28dB
7	humidity uncertainty	U=5.3%
8	Temperature uncertainty	U=0.59 °C

2. GENERAL INFORMATION

2.1 GENERAL DESCRIPTION OF EUT

Equipment	Digital Photo Frame		
Trade Name	N/A		
Model Name	Dream 01		
Model Difference	N/A		
Product Description	IEEE 802.11 WLAN Mode Supported	<input checked="" type="checkbox"/> 802.11a/n/ac(20MHz channel bandwidth) <input checked="" type="checkbox"/> 802.11n/ac(40MHz channel bandwidth) <input checked="" type="checkbox"/> 802.11ac(80MHz channel bandwidth)	
	Data Rate	802.11a: 6,9,12,18,24,36,48,54Mbps; 802.11n(HT20/HT40):MCS0-MCS15; 802.11ac(VHT20): NSS1, MCS0-MCS8 802.11ac(VHT40/VHT80):NSS1, MCS0-MCS8	
	Modulation	OFDM with BPSK/QPSK/16QAM/64QAM/256QAM for 802.11a/n/ac;	
	Operating Frequency Range	<input checked="" type="checkbox"/> 5180-5240MHz for 802.11a/n(HT20)/ac20; 5190-5230MHz for 802.11n(HT40)/ac40; 5210MHz for 802.11 ac80; <input checked="" type="checkbox"/> 5745-5825 MHz for 802.11a/n(HT20)/ac20; 5755-5795 MHz for 802.11a/n(HT40)/ac40; 5775MHz for 802.11 ac80;	
	Number of Channels	<input checked="" type="checkbox"/> 4 channels for 802.11a/n20/ac20 in the 5180-5240MHz band ; 2 channels for 802.11 n40/ac40 in the 5190-5230MHz band ; 1 channels for 802.11 ac80 in the 5210MHz band ; <input checked="" type="checkbox"/> 5 channels for 802.11a/n20/ac20 in the 5745-5825MHz band ; 2 channels for 802.11 n40/ac40 in the 5755-5795MHz band ; 1 channels for 802.11 ac80 in the 5775MHz band ;	
	Antenna Type	Internal antenna	
	Antenna Gain	2dBi	
	Based on the application, features, or specification exhibited in User's Manual, the EUT is considered as an ITE/Computing Device. More details of EUT technical specification, please refer to the User's Manual.		
	Channel List	Please refer to the Note 2.	
	Type of device	client devices	
Ratings	DC 5 V from adapter		
hardware version	H1.0		
Software version	S1.0		
Connecting I/O Port(s)	Please refer to the User's Manual		

Note:

1. For a more detailed features description, please refer to the manufacturer's specifications or the User's Manual.
2. Frequency and Channel list for 802.11a/n/ac(20MHz) band I (5180-5240MHz):

802.11a/n/ac(20MHz) Carrier Frequency Channel							
Channel	Frequency (MHz)	Channel	Frequency (MHz)	Channel	Frequency (MHz)	Channel	Frequency (MHz)
36	5180	44	5220	-	-	-	-
40	5200	48	5240	-	-	-	-

802.11n /ac(40MHz) Carrier Frequency Channel							
Channel	Frequency (MHz)	Channel	Frequency (MHz)	Channel	Frequency (MHz)	Channel	Frequency (MHz)
38	5190	-	-	-	-	-	-
46	5230	-	-	-	-	-	-

802.11ac (80MHz) Carrier Frequency Channel	
Channel	Frequency (MHz)
42	5210

Frequency and Channel list for 802.11a/n/ac(20 MHz) band IV (5745-5825MHz):

802.11a/n/ac(20 MHz) Carrier Frequency Channel							
Channel	Frequency (MHz)	Channel	Frequency (MHz)	Channel	Frequency (MHz)	Channel	Frequency (MHz)
149	5745	153	5765	157	5785	161	5805
165	5825	-	-	-	-	-	-

802.11n/ac 40MHz Carrier Frequency Channel					
Channel	Frequency (MHz)	Channel	Frequency (MHz)	Channel	Frequency (MHz)
151	5755	159	5795	-	-

802.11ac 80MHz Carrier Frequency Channel	
Channel	Frequency (MHz)
155	5775

The EUT has two types of antenna. The wireless module is 1x1 Wi-Fi support 802.11a / n / ac;

Internal Antenna

Antenna	Antenna Type	Antenna Gain(dBi)
A(main)	Internal antenna	2

2.2 DESCRIPTION OF TEST MODES

Pretest Mode	Description
Mode 1	802.11a / n/ ac 20 CH36/ CH40/ CH 48 802.11a /n/ ac 20 CH149/ CH157/ CH 165
Mode 2	802.11n/ ac40 CH38/ CH 46 802.11n/ ac40 CH 151 / CH 159
Mode 3	802.11 ac80 CH 42/CH 155
Mode 4	802.11a / n/ ac 20 CH36/ CH40/ CH 48 802.11a /n/ ac 20 CH149/ CH157/ CH 165
Mode 5	Link Mode

Conducted Emission	
Final Test Mode	Description
Mode 5	Link Mode

For Radiated Emission	
Final Test Mode	Description
Mode 1	802.11a / n/ ac 20 CH36/ CH40/ CH 48 802.11a /n/ ac 20 CH149/ CH157/ CH 165
Mode 2	802.11n/ ac40 CH38/ CH 46 802.11n/ ac40 CH 151 / CH 159
Mode 3	802.11 ac80 CH 42/CH 155
Mode 4	802.11a / n/ ac 20 CH36/ CH40/ CH 48 802.11a /n/ ac 20 CH149/ CH157/ CH 165

Note:

- (1) The measurements are performed at all Bit Rate of Transmitter, the worst data was reported.

2.3 BLOCK DIGRAM SHOWING THE CONFIGURATION OF SYSTEM TESTED

Conducted Emissions Test

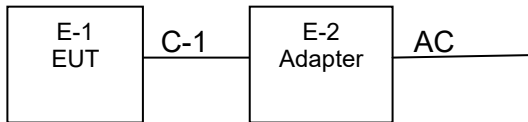

Spurious emissions Test

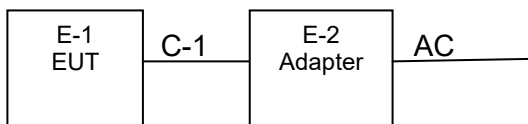

2.4 DESCRIPTION OF SUPPORT UNITS(CONDUCTED MODE)

The EUT has been tested as an independent unit together with other necessary accessories or support units. The following support units or accessories were used to form a representative test configuration during the tests.

No.	Device Type	Brand	Model	Series No.	Data Cable
E-1	Digital Photo Frame	N/A □	Dream 01	N/A	EUT
E-2	Adapter	N/A	JML-050020 0-LW	N/A	Auxiliary

Item	Shielded Type	Ferrite Core	Length	Note
C-1	NO	NO	0.5M	DC cable unshielded

Note:

- (1) The support equipment was authorized by Declaration of Confirmation.
- (2) For detachable type I/O cable should be specified the length in cm in 『Length』 column.

2.5 EQUIPMENTS LIST FOR ALL TEST ITEMS

Radiation Test equipment

Item	Equipment	Manufacturer	Type No.	Serial No.	Last calibration	Calibrated until
1	Spectrum Analyzer (9kHz-26.5GHz)	Agilent	E4407B	MY45109572	Jun. 08, 2020	Jun. 07, 2021
2	Test Receiver (9kHz-7GHz)	R&S	ESR7	101154	Jun. 08, 2020	Jun. 07, 2021
3	Bilog Antenna (30MHz-3GHz)	SCHWARZBE CK	VULB9163	VULB9163-94 2	Jun. 08, 2020	Jun. 07, 2021
4	Horn Antenna (1GHz-18GHz)	SCHWARZBE CK	BBHA9120D	1541	Jun. 10, 2020	Jun. 09, 2021
5	Horn Antenna (18GHz-40GHz)	SCHWARZBE CK	BBHA9170	822	Jun. 10, 2020	Jun. 09, 2021
6	Amplifier (9KHz-6GHz)	SCHWARZBE CK	BBV9744	9744-0037	Jun. 04, 2020	Jun. 03, 2021
7	Amplifier (0.5GHz-18GHz)	SCHWARZBE CK	BBV9718	9718-309	Jun. 04, 2020	Jun. 03, 2021
8	Amplifier (18GHz-40GHz)	MITEQ	TTA1840-35- HG	2034381	Jun. 08, 2020	Jun. 07, 2021
9	Loop Antenna (9KHz-30MHz)	SCHWARZBE CK	FMZB1519B	014	Jun. 08, 2020	Jun. 07, 2021
10	RF cables1 (9kHz-30MHz)	Huber+Suhnar	9kHz-30MHz	B1702988-000 8	Jun. 08, 2020	Jun. 07, 2021
11	RF cables2 (30MHz-1GHz)	Huber+Suhnar	30MHz-1GHz	1486150	Jun. 08, 2020	Jun. 07, 2021
12	RF cables3 (1GHz-40GHz)	Huber+Suhnar	1GHz-40GHz	1607106	Jun. 08, 2020	Jun. 07, 2021
13	Power Metter	Keysight	E4419B	\	Jun. 08, 2020	Jun. 07, 2021
14	Power Sensor (AV)	Keysight	E9 300A	\	Jun. 08, 2020	Jun. 07, 2021
15	Signal Analyzer 20kHz-26.5GHz	KEYSIGHT	N9020A	MY49100060	Jun. 04, 2020	Jun. 03, 2021
16	Spectrum Analyzer 9kHz-40GHz	Agilent	FSP40	100363	Jun. 04, 2020	Jun. 03, 2021
17	D.C. Power Supply	LongWei	TPR-6405D	\	\	\
18	Software	Frad	EZ-EMC	FA-03A2 RE	\	\

Conduction Test equipment

Item	Equipment	Manufacturer	Type No.	Serial No.	Last calibration	Calibrated until
1	Test Receiver	R&S	ESR3	102075	Jun. 08, 2020	Jun. 07, 2021
2	LISN	SCHWARZBEC K	NSLK8127	8127739	Jun. 08, 2020	Jun. 07, 2021
3	LISN	R&S	ENV216	101375	Jun. 04, 2020	Jun. 03, 2021
4	RF cables	Huber+Suhnar	9kHz-30MHz	B1702988-00 08	Jun. 08, 2020	Jun. 07, 2021
5	Software	Frad	EZ-EMC	EMC-CON 3A1	\	\

3. EMC EMISSION TEST

3.1 CONDUCTED EMISSION MEASUREMENT

3.1.1 POWER LINE CONDUCTED EMISSION Limits (Frequency Range 150KHz-30MHz)

FREQUENCY (MHz)	Class B (dBuV)		Standard
	Quasi-peak	Average	
0.15 -0.5	66 - 56 *	56 - 46 *	CISPR
0.50 -5.0	56.00	46.00	CISPR
5.0 -30.0	60.00	50.00	CISPR

0.15 -0.5	66 - 56 *	56 - 46 *	FCC/ RSS-247
0.50 -5.0	56.00	46.00	FCC/ RSS-247
5.0 -30.0	60.00	50.00	FCC/ RSS-247

Note:

- (1) The tighter limit applies at the band edges.
- (2) The limit of " * " marked band means the limitation decreases linearly with the logarithm of the frequency in the range.

The following table is the setting of the receiver

Receiver Parameters	Setting
Attenuation	10 dB
Start Frequency	0.15 MHz
Stop Frequency	30 MHz
IF Bandwidth	9 kHz

3.1.2 TEST PROCEDURE

- The EUT was placed 0.8 meters from the horizontal ground plane with EUT being connected to the power mains through a line impedance stabilization network (LISN). All other support equipments powered from additional LISN(s). The LISN provide 50 Ohm/ 50uH of coupling impedance for the measuring instrument.
- Interconnecting cables that hang closer than 40 cm to the ground plane shall be folded back and forth in the center forming a bundle 30 to 40 cm long.
- I/O cables that are not connected to a peripheral shall be bundled in the center. The end of the cable may be terminated, if required, using the correct terminating impedance. The overall length shall not exceed 1 m.
- LISN at least 80 cm from nearest part of EUT chassis.
- For the actual test configuration, please refer to the related Item –EUT Test Photos.

3.1.3 DEVIATION FROM TEST STANDARD

No deviation

3.1.4 TEST SETUP

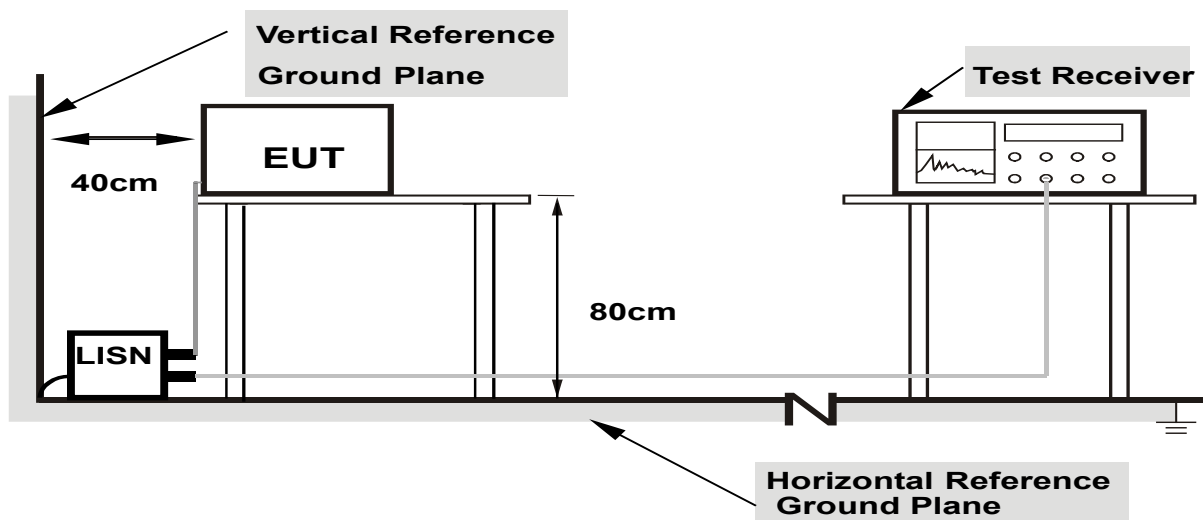

Note: 1.Support units were connected to second LISN.

2.Both of LISNs (AMN) are 80 cm from EUT and at least 80 from other units and other metal planes

3.1.5 EUT OPERATING CONDITIONS

The EUT was configured for testing in a typical fashion (as a customer would normally use it). The EUT has been programmed to continuously transmit during test. This operating condition was tested and used to collect the included data.

We pretest AC 120V and AC 240V, the worst voltage was AC 120V and the data recording in the report.

Temperature :	26 °C	Relative Humidity :	54%
Pressure :	101kPa	Phase :	L
Test Voltage :	AC120V 60Hz	Test Mode :	Mode 5

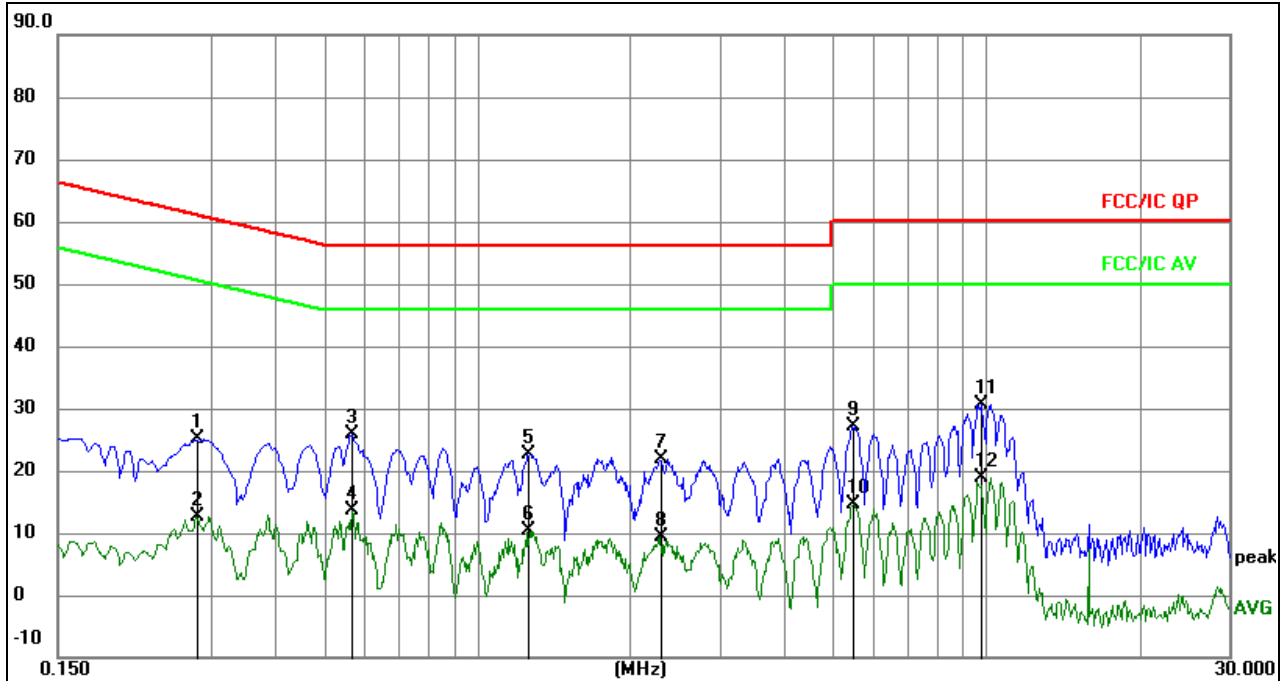

Remark:

1. All readings are Quasi-Peak and Average values.
2. Factor = Insertion Loss + Cable Loss.

No.	Mk.	Freq. MHz	Reading Level	Correct Factor dB	Measure- ment dBuV	Limit dBuV	Over dB	Detector
1		0.2803	15.55	9.56	25.11	60.81	-35.70	QP
2		0.2803	3.02	9.56	12.58	50.81	-38.23	AVG
3		0.5670	15.93	9.86	25.79	56.00	-30.21	QP
4		0.5670	3.79	9.86	13.65	46.00	-32.35	AVG
5		1.2555	13.02	9.58	22.60	56.00	-33.40	QP
6		1.2555	0.82	9.58	10.40	46.00	-35.60	AVG
7		2.2847	12.20	9.61	21.81	56.00	-34.19	QP
8		2.2847	-0.20	9.61	9.41	46.00	-36.59	AVG
9		5.4763	17.32	9.78	27.10	60.00	-32.90	QP
10		5.4763	4.85	9.78	14.63	50.00	-35.37	AVG
11	*	9.7567	20.99	9.69	30.68	60.00	-29.32	QP
12		9.7567	9.14	9.69	18.83	50.00	-31.17	AVG

Temperature :	26 °C	Relative Humidity :	54%
Pressure :	101kPa	Phase :	N
Test Voltage :	AC120V 60Hz	Test Mode :	Mode 5

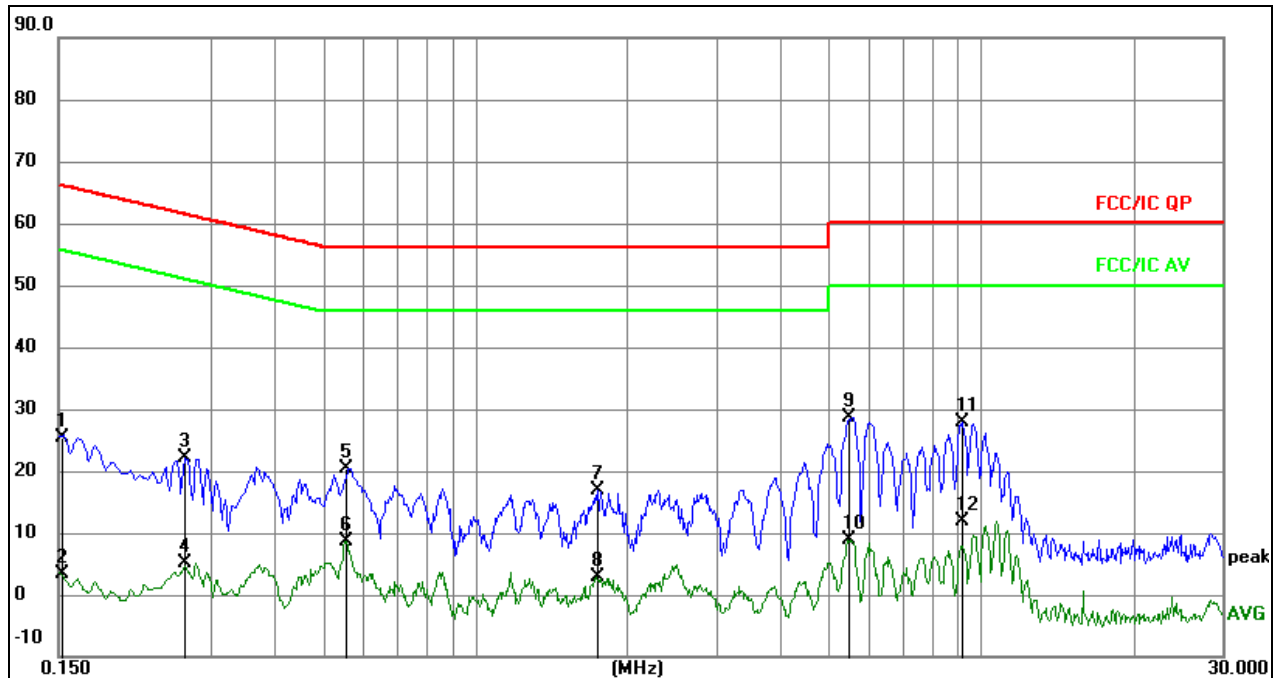

Remark:

1. All readings are Quasi-Peak and Average values.
2. Factor = Insertion Loss + Cable Loss.

No.	Mk.	Freq. MHz	Reading Level	Correct Factor dB	Measure- ment dBuV	Limit dBuV	Over dB	Detector
1		0.1516	15.92	9.52	25.44	65.91	-40.47	QP
2		0.1516	-6.11	9.52	3.41	55.91	-52.50	AVG
3		0.2670	12.59	9.54	22.13	61.21	-39.08	QP
4		0.2670	-4.48	9.54	5.06	51.21	-46.15	AVG
5		0.5550	10.55	9.82	20.37	56.00	-35.63	QP
6		0.5550	-1.27	9.82	8.55	46.00	-37.45	AVG
7		1.7430	7.33	9.58	16.91	56.00	-39.09	QP
8		1.7430	-6.75	9.58	2.83	46.00	-43.17	AVG
9	*	5.4645	18.89	9.78	28.67	60.00	-31.33	QP
10		5.4645	-0.81	9.78	8.97	50.00	-41.03	AVG
11		9.1635	18.20	9.70	27.90	60.00	-32.10	QP
12		9.1635	2.07	9.70	11.77	50.00	-38.23	AVG

3.2 RADIATED EMISSION MEASUREMENT

3.2.1 APPLICABLE STANDARD

According to FCC Part 15.407(d) and 15.209

3.2.2 CONFORMANCE LIMIT

According to FCC Part 15.407(b)(7): radiated emissions which fall in the restricted bands, as defined in §15.205(a), must also comply with the radiated emission limits specified in §15.209(a) (see §15.205(c)).
 According to FCC Part 15.205, Restricted bands

MHz	MHz	MHz	GHz
0.090-0.110	16.42-16.423	399.9-410	4.5-5.15
10.495-0.505	16.69475-16.69525	608-614	5.35-5.46
2.1735-2.1905	16.80425-16.80475	960-1240	7.25-7.75
4.125-4.128	25.5-25.67	1300-1427	8.025-8.5
4.17725-4.17775	37.5-38.25	1435-1626.5	9.0-9.2
4.20725-4.20775	73-74.6	1645.5-1646.5	9.3-9.5
6.215-6.218	74.8-75.2	1660-1710	10.6-12.7
6.26775-6.26825	123-138	2200-2300	14.47-14.5
8.291-8.294	149.9-150.05	2310-2390	15.35-16.2
8.362-8.366	156.52475-156.52525	2483.5-2500	17.7-21.4
8.37625-8.38675	156.7-156.9	2690-2900	22.01-23.12
8.41425-8.41475	162.0125-167.17	3260-3267	23.6-24.0
12.29-12.293	167.72-173.2	3332-3339	31.2-31.8
12.51975-12.52025	240-285	3345.8-3358	36.43-36.5
12.57675-12.57725	322-335.4	3600-4400	(2)
13.36-13.41			

20dBc in any 100 kHz bandwidth outside the operating frequency band. In case the emission fall within the restricted band specified on 15.205(a), then the 15.209(a) limit in the table below has to be followed.

Restricted Frequency(MHz)	Field Strength ($\mu\text{V}/\text{m}$)	Field Strength ($\text{dB}\mu\text{V}/\text{m}$)	Measurement Distance
0.009~0.490	2400/F(KHz)	20 log ($\mu\text{V}/\text{m}$)	300
0.490~1.705	24000/F(KHz)	20 log ($\mu\text{V}/\text{m}$)	30
1.705~30.0	30	29.5	30
30-88	100	40	3
88-216	150	43.5	3
216-960	200	46	3
Above 960	500	54	3

Limits of Radiated Emission Measurement(Above 1000MHz)

Frequency(MHz)	Class B ($\text{dB}\mu\text{V}/\text{m}$) (at 3M)	
	PEAK	AVERAGE
Above 1000	74	54

Remark :1. Emission level in $\text{dB}\mu\text{V}/\text{m}=20 \log (\mu\text{V}/\text{m})$

2. Measurement was performed at an antenna to the closed point of EUT distance of meters.

3. Distance extrapolation factor = $40 \log (\text{Specific distance}/ \text{test distance})(\text{dB})$;

Limit line=Specific limits($\text{dB}\mu\text{V}$) + distance extrapolation factor.

3.2.3 MEASURING INSTRUMENTS

The Measuring equipment is listed in the section 6.3 of this test report.

3.2.4 TEST CONFIGURATION

(a) For radiated emissions below 30MHz

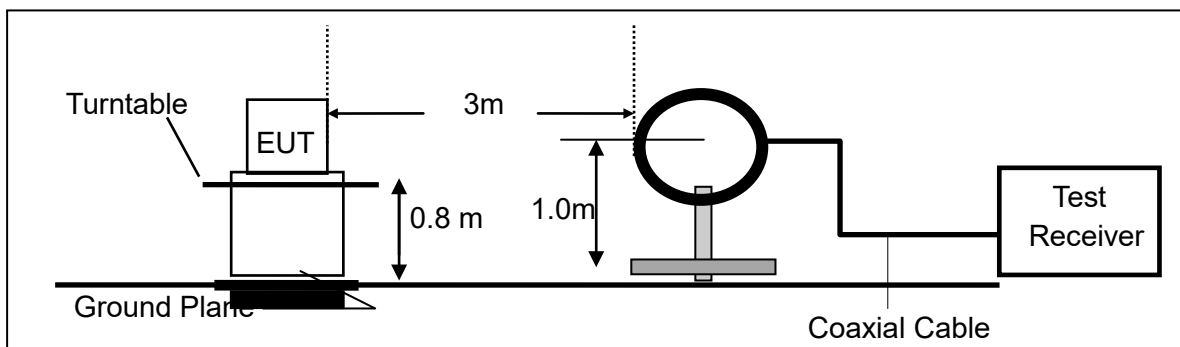

(b) For radiated emissions from 30MHz to 1000MHz

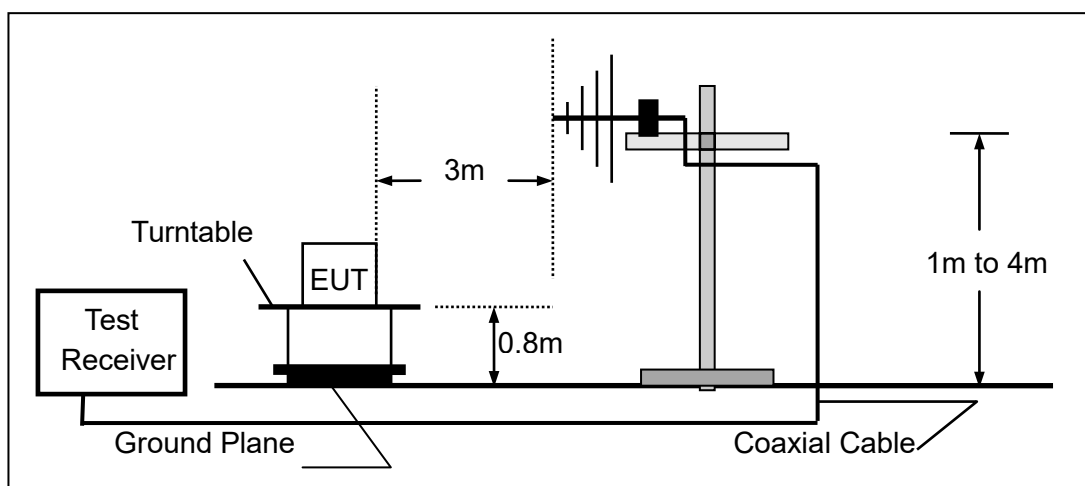

(c) For radiated emissions above 1000MHz

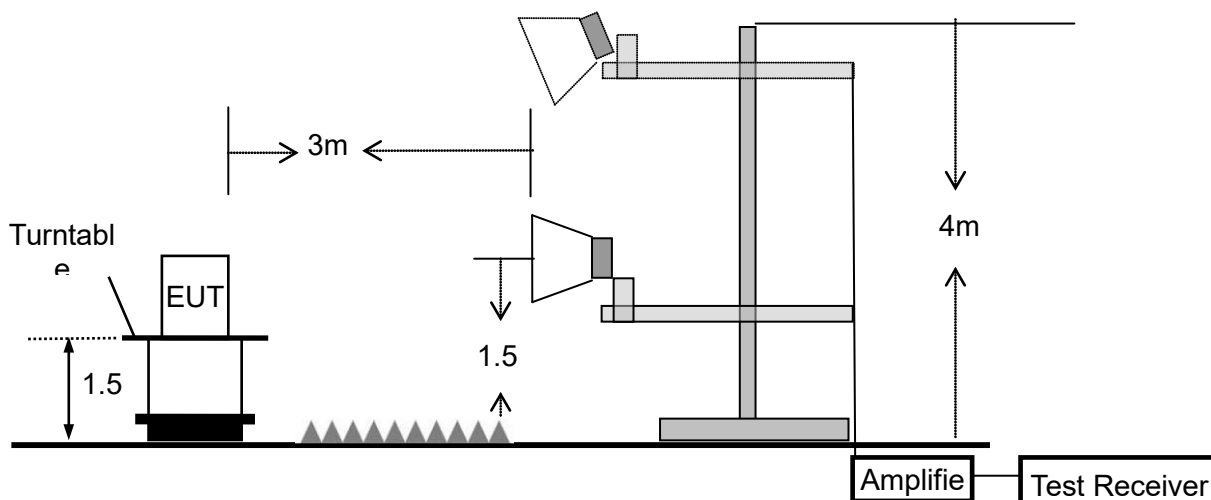

3.2.5 TEST PROCEDURE

The test site semi-anechoic chamber has met the requirement of NSA tolerance 4 dB according to the standards: ANSI C63.10-2013. The test distance is 3m. The setup is according to the requirements in Section 13.1.4.1 of ANSI C63.10-2013 and CAN/CSA-CEI/IEC CISPR 22.

This test is required for any spurious emission that falls in a Restricted Band, as defined in Section 15.205. It must be performed with the highest gain of each type of antenna proposed for use with the EUT.

Use the following spectrum analyzer settings:

Spectrum Parameter	Setting
Attenuation	Auto
Start Frequency	1000 MHz
Stop Frequency	10th carrier harmonic
RB / VB (emission in restricted band)	1 MHz / 1 MHz for Peak, 1 MHz / 10Hz for Average

Receiver Parameter	Setting
Attenuation	Auto
Start ~ Stop Frequency	9kHz~150kHz / RB 200Hz for QP
Start ~ Stop Frequency	150kHz~30MHz / RB 9kHz for QP
Start ~ Stop Frequency	30MHz~1000MHz / RB 120kHz for QP

- The measuring distance of at 3 m shall be used for measurements at frequency up to 1GHz. For frequencies above 1GHz, any suitable measuring distance may be used.
- The EUT was placed on the top of a rotating table 0.8 m for below 1GHz and 1.5m for above 1GHz the ground at a 3 meter. The table was rotated 360 degrees to determine the position of the highest radiation.
- The height of the equipment or of the substitution antenna shall be 0.8 m for below 1GHz and 1.5m for above 1GHz; the height of the test antenna shall vary between 1 m to 4 m. Both horizontal and vertical polarizations of the antenna are set to make the measurement.
- The initial step in collecting conducted emission data is a spectrum analyzer peak detector mode pre-scanning the measurement frequency range. Significant peaks are then marked and then Quasi Peak detector mode re-measured.
- If the Peak Mode measured value compliance with and lower than Quasi Peak Mode Limit, the EUT shall be deemed to meet QP Limits and then no additional QP Mode measurement performed.
- For the actual test configuration, please refer to the related Item –EUT Test Photos.

Note:

Both horizontal and vertical antenna polarities were tested and performed pretest to three orthogonal axis. The worst case emissions were reported

During the radiated emission test, the Spectrum Analyzer was set with the following configurations:

Frequency Band (MHz)	Function	Resolution bandwidth	Video Bandwidth
30 to 1000	QP	120 kHz	300 kHz
Above 1000	Peak	1 MHz	1 MHz
	Average	1 MHz	10 Hz

Note: for the frequency ranges below 30 MHz, a narrower RBW is used for these ranges but the measured value should add a RBW correction factor (RBWCF) where $RBWCF [dB] = 10 \cdot \lg(100 [kHz]/\text{narrower RBW [kHz]})$. , the narrower RBW is 1 kHz and RBWCF is 20 dB for the frequency 9 kHz to 150 kHz, and the narrower RBW is 10 kHz and RBWCF is 10 dB for the frequency 150 kHz to 30 MHz.

3.2.6 TEST RESULTS (9KHZ – 30 MHZ)

Temperature:	26℃	Relative Humidity:	54%
Pressure:	101kPa	Test Voltage :	AC120V
Test Mode :	Mode 5	Polarization :	--

Freq.	Reading	Limit	Margin	State
(MHz)	(dBuV/m)	(dBuV/m)	(dB)	P/F
--	--	--	--	N/A
--	--	--	--	N/A

NOTE:

The amplitude of spurious emissions which are attenuated by more than 20dB below the permissible value has no need to be reported.

Distance extrapolation factor = $40 \log(\text{specific distance}/\text{test distance})$ (dB);

Limit line = specific limits(dBuv) + distance extrapolation factor.

3.2.7 TEST RESULTS (30MHZ – 1GHZ)

Temperature :	26°C	Relative Humidity :	54%
Pressure :	101 kPa	Polarization :	Horizontal
Test Voltage :	AC 120V		
Test Mode :	Mode 5		

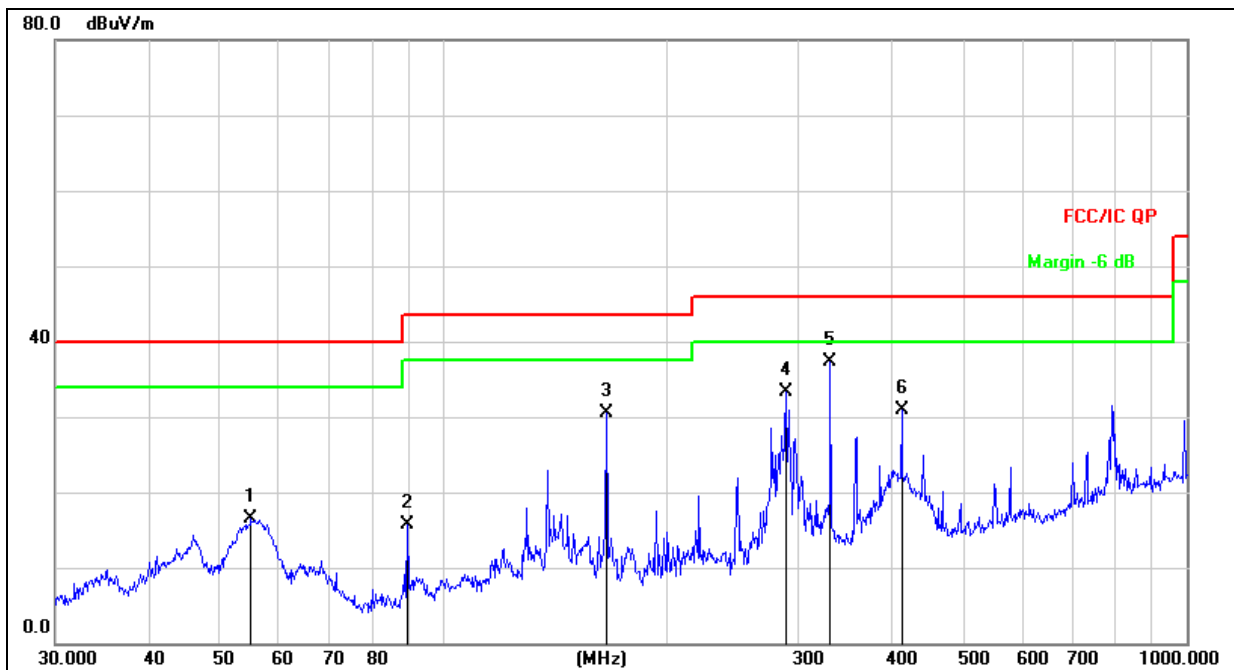

Remark:
 Factor = Antenna Factor + Cable Loss – Pre-amplifier.

No.	Mk.	Freq. MHz	Reading Level dBuV	Correct Factor dB	Measure- ment dBuV/m	Limit dB/m	Over dB	Detector
1		55.0274	31.81	-15.38	16.43	40.00	-23.57	QP
2		89.2764	33.91	-18.27	15.64	43.50	-27.86	QP
3		165.4866	48.99	-18.51	30.48	43.50	-13.02	QP
4		289.0021	47.16	-13.94	33.22	46.00	-12.78	QP
5	*	331.3546	50.08	-12.74	37.34	46.00	-8.66	QP
6		413.2706	41.61	-10.79	30.82	46.00	-15.18	QP

Temperature :	26℃	Relative Humidity :	54%
Pressure :	101kPa	Polarization :	Vertical
Test Voltage :	AC 120V		
Test Mode :	Mode 5		

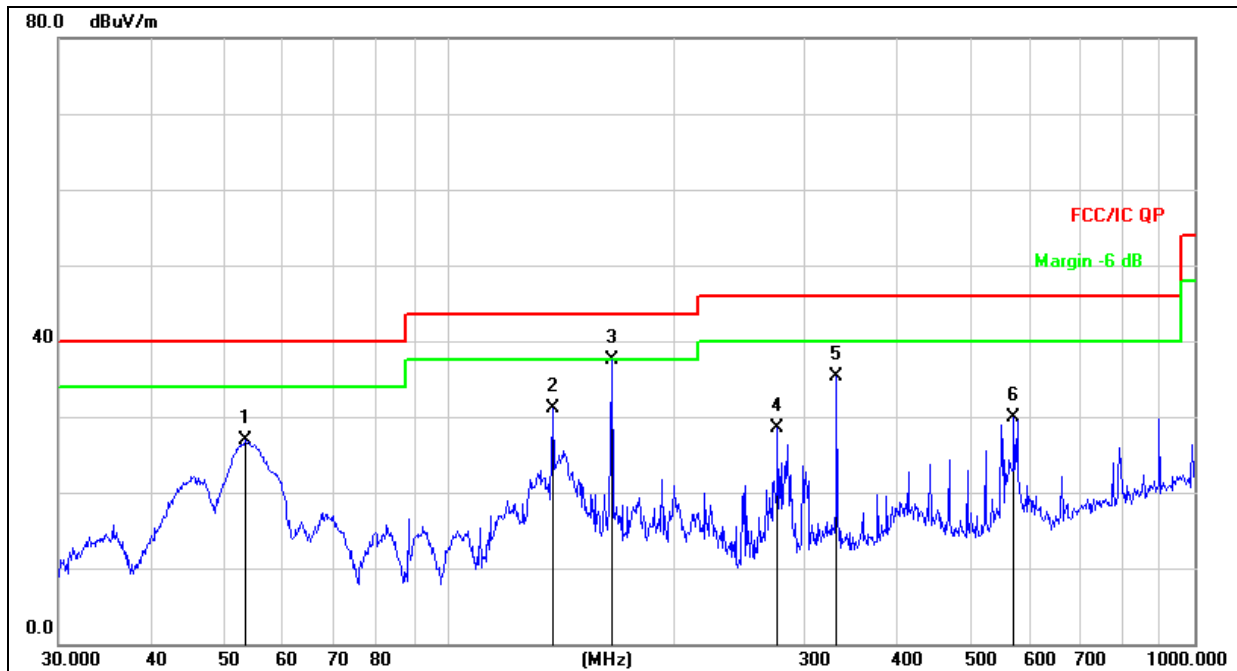

Remark:

Factor = Antenna Factor + Cable Loss – Pre-amplifier.

No.	Mk.	Freq. MHz	Reading Level dBuV	Correct Factor dB	Measure- ment dBuV/m	Limit dB/m	Over dB	Detector
1		53.5052	42.21	-15.22	26.99	40.00	-13.01	QP
2		137.9028	49.76	-18.72	31.04	43.50	-12.46	QP
3	*	165.4866	55.93	-18.51	37.42	43.50	-6.08	QP
4		276.1235	42.79	-14.34	28.45	46.00	-17.55	QP
5		331.3546	48.00	-12.74	35.26	46.00	-10.74	QP
6		572.6144	37.06	-7.16	29.90	46.00	-16.10	QP

3.2.8 TEST RESULTS (1GHz-40GHz)

Test Mode :	TX(5.1G) - 802.11a
-------------	--------------------

Polar	Frequency	Meter Reading	Cable loss	Antenna Factor	Preamp Factor	Emission Level	Limits	Margin	Detector Type
(H/V)	(MHz)	(dBuV)	(dB)	dB/m	(dB)	(dBuV/m)	(dBuV/m)	(dB)	
Low Channel (5180 MHz)-Above 1G									
Vertical	4434.155	62.25	5.94	35.40	44.00	59.59	68.20	-8.61	Pk
Vertical	4434.157	46.56	5.94	35.40	44.00	43.9	54.00	-10.1	AV
Vertical	10360.362	60.45	8.46	39.75	44.50	64.16	68.20	-4.04	Pk
Vertical	10360.362	42.94	8.46	39.75	44.50	46.65	54.00	-7.35	AV
Vertical	15540.196	61.45	10.12	38.80	44.10	66.27	74.00	-7.73	Pk
Vertical	15540.196	37.54	10.12	38.80	42.70	43.76	54.00	-10.24	AV
Horizontal	4434.521	66.53	5.94	35.18	44.00	63.65	68.20	-4.55	Pk
Horizontal	4434.521	44.12	5.94	35.18	44.00	41.24	54.00	-12.76	AV
Horizontal	10360.623	58.93	8.46	38.71	44.50	61.6	68.20	-6.6	Pk
Horizontal	10360.623	41.05	8.46	38.71	44.50	43.72	54.00	-10.28	AV
Horizontal	15540.865	56.93	10.12	38.38	44.10	61.33	74.00	-12.67	Pk
Horizontal	15540.865	38.85	10.12	38.38	44.10	43.25	54.00	-10.75	AV
middle Channel (5200 MHz)-Above 1G									
Vertical	4592.093	60.25	6.48	36.35	44.05	59.03	74.00	-14.97	Pk
Vertical	4592.093	41.97	6.48	36.35	44.05	40.75	54.00	-13.25	AV
Vertical	10400.424	59.63	8.47	37.88	44.51	61.47	68.20	-6.73	Pk
Vertical	10400.424	42.75	8.47	37.88	44.51	44.59	54.00	-9.41	AV
Vertical	15600.218	56.55	10.12	38.8	44.10	61.37	74.00	-12.63	Pk
Vertical	15600.218	36.65	10.12	38.8	42.70	42.87	54.00	-11.13	AV
Horizontal	4592.691	59.86	6.48	36.37	44.05	58.66	74.00	-15.34	Pk
Horizontal	4592.691	43.17	6.48	36.37	44.05	41.97	54.00	-12.03	AV
Horizontal	10400.114	58.85	8.47	38.64	44.50	61.46	68.20	-6.74	Pk
Horizontal	10400.114	42.24	8.47	38.64	44.50	44.85	54.00	-9.15	AV
Horizontal	15600.187	59.86	10.12	38.38	44.10	64.26	74.00	-9.74	Pk
Horizontal	15600.187	38.73	10.12	38.38	44.10	43.13	54.00	-10.87	AV
High Channel (5240 MHz)-Above 1G									
Vertical	4739.246	61.28	7.10	37.24	43.50	62.12	74.00	-11.88	Pk
Vertical	4739.246	44.46	7.10	37.24	43.50	45.3	54.00	-8.7	AV
Vertical	10480.371	60.55	8.46	37.68	44.50	62.19	68.20	-6.01	Pk
Vertical	10480.371	40.34	8.46	37.68	44.50	41.98	54.00	-12.02	AV
Vertical	15720.359	61.75	10.12	38.8	44.10	66.57	74.00	-7.43	Pk
Vertical	15720.359	39.65	10.12	38.8	42.70	45.87	54.00	-8.13	AV
Horizontal	4739.352	62.28	7.10	37.24	43.50	63.12	74.00	-10.88	Pk
Horizontal	4739.352	43.24	7.10	37.24	43.50	44.08	54.00	-9.92	AV
Horizontal	10480.111	62.53	8.46	38.57	44.50	65.06	68.20	-3.14	Pk
Horizontal	10480.111	43.36	8.46	38.57	44.50	45.89	54.00	-8.11	AV
Horizontal	15720.357	60.75	10.12	38.38	44.10	65.15	74.00	-8.85	Pk
Horizontal	15720.357	42.26	10.12	38.38	44.10	46.66	54.00	-7.34	AV

Note: "The amplitude of spurious emissions that are attenuated by more than 20dB below the permissible value

has no need to be reported.

Emission level (dBuV/m) = 20 log Emission level (uV/m).

Corrected Reading: Antenna Factor + Cable Loss + Read Level - Preamp Factor = Level.

Test Mode :	TX(5.1G) - 802.11 n20
-------------	-----------------------

Polar	Frequency	Meter Reading	Cable loss	Antenna Factor	Preamp Factor	Emission Level	Limits	Margin	Detector Type
(H/V)	(MHz)	(dBuV)	(dB)	dB/m	(dB)	(dBuV/m)	(dBuV/m)	(dB)	
Low Channel (5180 MHz)-Above 1G									
Vertical	4434.157	62.29	5.94	35.40	44.00	59.63	68.20	-8.57	Pk
Vertical	4434.157	46.55	5.94	35.40	44.00	43.89	54.00	-10.11	AV
Vertical	10360.362	60.45	8.46	39.75	44.50	64.16	68.20	-4.04	Pk
Vertical	10360.362	42.87	8.46	39.75	44.50	46.58	54.00	-7.42	AV
Vertical	15540.196	61.63	10.12	38.80	44.10	66.45	74.00	-7.55	Pk
Vertical	15540.196	37.58	10.12	38.80	42.70	43.8	54.00	-10.2	AV
Horizontal	4434.521	66.54	5.94	35.18	44.00	63.66	68.20	-4.54	Pk
Horizontal	4434.521	44.18	5.94	35.18	44.00	41.3	54.00	-12.7	AV
Horizontal	10360.623	58.57	8.46	38.71	44.50	61.24	68.20	-6.96	Pk
Horizontal	10360.623	41.07	8.46	38.71	44.50	43.74	54.00	-10.26	AV
Horizontal	15540.865	56.58	10.12	38.38	44.10	60.98	74.00	-13.02	Pk
Horizontal	15540.865	38.62	10.12	38.38	44.10	43.02	54.00	-10.98	AV
middle Channel (5200 MHz)-Above 1G									
Vertical	4592.093	60.63	6.48	36.35	44.05	59.41	74.00	-14.59	Pk
Vertical	4592.093	41.57	6.48	36.35	44.05	40.35	54.00	-13.65	AV
Vertical	10400.324	59.65	8.47	37.88	44.51	61.49	68.20	-6.71	Pk
Vertical	10400.324	42.72	8.47	37.88	44.51	44.56	54.00	-9.44	AV
Vertical	15600.413	56.55	10.12	38.8	44.10	61.37	74.00	-12.63	Pk
Vertical	15600.413	36.65	10.12	38.8	42.70	42.87	54.00	-11.13	AV
Horizontal	4592.691	59.87	6.48	36.37	44.05	58.67	74.00	-15.33	Pk
Horizontal	4592.691	43.16	6.48	36.37	44.05	41.96	54.00	-12.04	AV
Horizontal	10400.236	58.85	8.47	38.64	44.50	61.46	68.20	-6.74	Pk
Horizontal	10400.236	42.25	8.47	38.64	44.50	44.86	54.00	-9.14	AV
Horizontal	15600.318	59.81	10.12	38.38	44.10	64.21	74.00	-9.79	Pk
Horizontal	15600.318	38.75	10.12	38.38	44.10	43.15	54.00	-10.85	AV
High Channel (5240 MHz)-Above 1G									
Vertical	4739.246	61.26	7.10	37.24	43.50	62.1	74.00	-11.9	Pk
Vertical	4739.246	44.45	7.10	37.24	43.50	45.29	54.00	-8.71	AV
Vertical	10480.476	60.57	8.46	37.68	44.50	62.21	68.20	-5.99	Pk
Vertical	10480.476	40.38	8.46	37.68	44.50	42.02	54.00	-11.98	AV
Vertical	15720.347	61.75	10.12	38.8	44.10	66.57	74.00	-7.43	Pk
Vertical	15720.347	39.66	10.12	38.8	42.70	45.88	54.00	-8.12	AV
Horizontal	4739.352	62.28	7.10	37.24	43.50	63.12	74.00	-10.88	Pk
Horizontal	4739.352	43.26	7.10	37.24	43.50	44.1	54.00	-9.9	AV
Horizontal	10480.176	62.55	8.46	38.57	44.50	65.08	68.20	-3.12	Pk
Horizontal	10480.176	43.36	8.46	38.57	44.50	45.89	54.00	-8.11	AV
Horizontal	15720.374	60.74	10.12	38.38	44.10	65.14	74.00	-8.86	Pk
Horizontal	15720.374	42.26	10.12	38.38	44.10	46.66	54.00	-7.34	AV

Note: The amplitude of spurious emissions that are attenuated by more than 20dB below the permissible value has no need to be reported.

Emission level (dBuV/m) = 20 log Emission level (uV/m).

Corrected Reading: Antenna Factor + Cable Loss + Read Level - Preamp Factor = Level.

Test Mode :	TX(5.1G) - 802.11 AC20
-------------	------------------------

Polar	Frequency	Meter Reading	Cable loss	Antenna Factor	Preamp Factor	Emission Level	Limits	Margin	Detector Type
(H/V)	(MHz)	(dBuV)	(dB)	dB/m	(dB)	(dBuV/m)	(dBuV/m)	(dB)	
Low Channel (5180 MHz)-Above 1G									
Vertical	4434.157	62.25	5.94	35.40	44.00	59.59	68.20	-8.61	Pk
Vertical	4434.157	46.56	5.94	35.40	44.00	43.9	54.00	-10.1	AV
Vertical	10360.358	60.45	8.46	39.75	44.50	64.16	68.20	-4.04	Pk
Vertical	10360.358	42.91	8.46	39.75	44.50	46.62	54.00	-7.38	AV
Vertical	15540.173	61.47	10.12	38.80	44.10	66.29	74.00	-7.71	Pk
Vertical	15540.173	37.5	10.12	38.80	42.70	43.72	54.00	-10.28	AV
Horizontal	4434.517	66.56	5.94	35.18	44.00	63.68	68.20	-4.52	Pk
Horizontal	4434.517	44.12	5.94	35.18	44.00	41.24	54.00	-12.76	AV
Horizontal	10360.642	58.36	8.46	38.71	44.50	61.03	68.20	-7.17	Pk
Horizontal	10360.642	41.09	8.46	38.71	44.50	43.76	54.00	-10.24	AV
Horizontal	15540.865	56.95	10.12	38.38	44.10	61.35	74.00	-12.65	Pk
Horizontal	15540.865	38.87	10.12	38.38	44.10	43.27	54.00	-10.73	AV
middle Channel (5200 MHz)-Above 1G									
Vertical	4592.093	60.26	6.48	36.35	44.05	59.04	74.00	-14.96	Pk
Vertical	4592.093	41.91	6.48	36.35	44.05	40.69	54.00	-13.31	AV
Vertical	10400.485	59.66	8.47	37.88	44.51	61.5	68.20	-6.7	Pk
Vertical	10400.485	42.78	8.47	37.88	44.51	44.62	54.00	-9.38	AV
Vertical	15600.275	56.56	10.12	38.8	44.10	61.38	74.00	-12.62	Pk
Vertical	15600.275	36.65	10.12	38.8	42.70	42.87	54.00	-11.13	AV
Horizontal	4592.691	59.88	6.48	36.37	44.05	58.68	74.00	-15.32	Pk
Horizontal	4592.691	43.13	6.48	36.37	44.05	41.93	54.00	-12.07	AV
Horizontal	10400.136	58.53	8.47	38.64	44.50	61.14	68.20	-7.06	Pk
Horizontal	10400.136	42.26	8.47	38.64	44.50	44.87	54.00	-9.13	AV
Horizontal	15600.187	59.85	10.12	38.38	44.10	64.25	74.00	-9.75	Pk
Horizontal	15600.187	38.74	10.12	38.38	44.10	43.14	54.00	-10.86	AV
High Channel (5240 MHz)-Above 1G									
Vertical	4739.246	61.25	7.10	37.24	43.50	62.09	74.00	-11.91	Pk
Vertical	4739.246	44.45	7.10	37.24	43.50	45.29	54.00	-8.71	AV
Vertical	10480.341	60.54	8.46	37.68	44.50	62.18	68.20	-6.02	Pk
Vertical	10480.341	40.36	8.46	37.68	44.50	42	54.00	-12	AV
Vertical	15720.359	61.73	10.12	38.8	44.10	66.55	74.00	-7.45	Pk
Vertical	15720.359	39.62	10.12	38.8	42.70	45.84	54.00	-8.16	AV
Horizontal	4739.374	62.26	7.10	37.24	43.50	63.1	74.00	-10.9	Pk
Horizontal	4739.374	43.28	7.10	37.24	43.50	44.12	54.00	-9.88	AV
Horizontal	10480.222	62.56	8.46	38.57	44.50	65.09	68.20	-3.11	Pk
Horizontal	10480.222	43.35	8.46	38.57	44.50	45.88	54.00	-8.12	AV
Horizontal	15720.357	60.72	10.12	38.38	44.10	65.12	74.00	-8.88	Pk
Horizontal	15720.357	42.26	10.12	38.38	44.10	46.66	54.00	-7.34	AV

Note: The amplitude of spurious emissions that are attenuated by more than 20dB below the permissible value

has no need to be reported.

Emission level (dBuV/m) = 20 log Emission level (uV/m).

Corrected Reading: Antenna Factor + Cable Loss + Read Level - Preamp Factor = Level.

Test Mode :	TX (5.8G) -- 802.11a
-------------	----------------------

Polar	Frequency	Meter Reading	Cable loss	Antenna Factor	Preamp Factor	Emission Level	Limits	Margin	Detector Type
(H/V)	(MHz)	(dBuV)	(dB)	dB/m	(dB)	(dBuV/m)	(dBuV/m)	(dB)	
Low Channel (5745 MHz)-Above 1G									
Vertical	4679.195	59.95	5.94	35.40	44.00	57.29	74.00	-16.71	Pk
Vertical	4679.195	39.66	5.94	35.40	44.00	37	54.00	-17	AV
Vertical	11490.364	59.57	8.46	39.75	44.50	63.28	74.00	-10.72	Pk
Vertical	11490.364	42.16	8.46	39.75	44.50	45.87	54.00	-8.13	AV
Vertical	17235.101	55.55	10.12	38.80	44.10	60.37	68.20	-7.83	Pk
Vertical	17235.101	38.63	10.12	38.80	42.70	44.85	54.00	-9.15	AV
Horizontal	4679.332	57.91	5.94	35.18	44.00	55.03	74.00	-18.97	Pk
Horizontal	4679.332	44.55	5.94	35.18	44.00	41.67	54.00	-12.33	AV
Horizontal	11490.164	56.62	8.46	38.71	44.50	59.29	74.00	-14.71	Pk
Horizontal	11490.164	40.19	8.46	38.71	44.50	42.86	54.00	-11.14	AV
Horizontal	17235.196	58.64	10.12	38.38	44.10	63.04	68.20	-5.16	Pk
Horizontal	17235.196	42.25	10.12	38.38	44.10	46.65	54.00	-7.35	AV
middle Channel (5785 MHz)-Above 1G									
Vertical	4592.228	59.81	6.48	36.35	44.05	58.59	74.00	-15.41	Pk
Vertical	4592.228	43.35	6.48	36.35	44.05	42.13	54.00	-11.87	AV
Vertical	11570.203	61.13	8.47	37.88	44.51	62.97	74.00	-11.03	Pk
Vertical	11570.203	43.21	8.47	37.88	44.51	45.05	54.00	-8.95	AV
Vertical	17355.147	59.52	10.12	38.8	44.10	64.34	68.20	-3.86	Pk
Vertical	17355.147	40.19	10.12	38.8	42.70	46.41	54.00	-7.59	AV
Horizontal	4592.526	58.65	6.48	36.37	44.05	57.45	74.00	-16.55	Pk
Horizontal	4592.526	54.65	6.48	36.37	44.05	53.45	54.00	-0.55	AV
Horizontal	11570.123	38.67	8.47	38.64	44.50	41.28	74.00	-32.72	Pk
Horizontal	11570.123	42.28	8.47	38.64	44.50	44.89	54.00	-9.11	AV
Horizontal	17355.269	57.55	10.12	38.38	44.10	61.95	68.20	-6.25	Pk
Horizontal	17355.269	42.26	10.12	38.38	44.10	46.66	54.00	-7.34	AV
High Channel (5825 MHz)-Above 1G									
Vertical	6039.199	57.61	7.10	37.24	43.50	58.45	68.20	-9.75	Pk
Vertical	6039.199	42.25	7.10	37.24	43.50	43.09	54.00	-10.91	AV
Vertical	11650.562	58.94	8.46	37.68	44.50	60.58	74.00	-13.42	Pk
Vertical	11650.562	41.16	8.46	37.68	44.50	42.8	54.00	-11.2	AV
Vertical	17475.128	58.52	10.12	38.8	44.10	63.34	68.20	-4.86	Pk
Vertical	17475.128	40.35	10.12	38.8	42.70	46.57	54.00	-7.43	AV
Horizontal	6039.232	59.91	7.10	37.24	43.50	60.75	68.20	-7.45	Pk
Horizontal	6039.232	43.39	7.10	37.24	43.50	44.23	54.00	-9.77	AV
Horizontal	11650.319	52.26	8.46	38.57	44.50	54.79	74.00	-19.21	Pk
Horizontal	11650.319	40.15	8.46	38.57	44.50	42.68	54.00	-11.32	AV
Horizontal	17475.062	57.71	10.12	38.38	44.10	62.11	68.20	-6.09	Pk
Horizontal	17475.062	40.32	10.12	38.38	44.10	44.72	54.00	-9.28	AV

Note: ". The amplitude of spurious emissions that are attenuated by more than 20dB below the permissible value has no need to be reported.

Emission level (dBuV/m) = 20 log Emission level (uV/m).

Corrected Reading: Antenna Factor + Cable Loss + Read Level - Preamp Factor = Level.

Test Mode :	TX (5.8G) -- 802.11n20
-------------	------------------------

Polar	Frequency	Meter Reading	Cable loss	Antenna Factor	Preamp Factor	Emission Level	Limits	Margin	Detector Type
(H/V)	(MHz)	(dBuV)	(dB)	dB/m	(dB)	(dBuV/m)	(dBuV/m)	(dB)	
Low Channel (5745 MHz)-Above 1G									
Vertical	4679.195	59.92	5.94	35.40	44.00	57.26	74.00	-16.74	Pk
Vertical	4679.195	39.63	5.94	35.40	44.00	36.97	54.00	-17.03	AV
Vertical	11490.345	59.53	8.46	39.75	44.50	63.24	74.00	-10.76	Pk
Vertical	11490.345	42.15	8.46	39.75	44.50	45.86	54.00	-8.14	AV
Vertical	17235.112	55.55	10.12	38.80	44.10	60.37	68.20	-7.83	Pk
Vertical	17235.112	38.66	10.12	38.80	42.70	44.88	54.00	-9.12	AV
Horizontal	4679.332	57.92	5.94	35.18	44.00	55.04	74.00	-18.96	Pk
Horizontal	4679.332	44.55	5.94	35.18	44.00	41.67	54.00	-12.33	AV
Horizontal	11490.153	56.64	8.46	38.71	44.50	59.31	74.00	-14.69	Pk
Horizontal	11490.153	40.12	8.46	38.71	44.50	42.79	54.00	-11.21	AV
Horizontal	17235.174	58.68	10.12	38.38	44.10	63.08	68.20	-5.12	Pk
Horizontal	17235.174	42.22	10.12	38.38	44.10	46.62	54.00	-7.38	AV
middle Channel (5785 MHz)-Above 1G									
Vertical	4592.228	59.87	6.48	36.35	44.05	58.65	74.00	-15.35	Pk
Vertical	4592.228	43.36	6.48	36.35	44.05	42.14	54.00	-11.86	AV
Vertical	11570.214	61.15	8.47	37.88	44.51	62.99	74.00	-11.01	Pk
Vertical	11570.214	43.29	8.47	37.88	44.51	45.13	54.00	-8.87	AV
Vertical	17355.131	59.55	10.12	38.8	44.10	64.37	68.20	-3.83	Pk
Vertical	17355.131	40.17	10.12	38.8	42.70	46.39	54.00	-7.61	AV
Horizontal	4592.526	58.64	6.48	36.37	44.05	57.44	74.00	-16.56	Pk
Horizontal	4592.526	43.37	6.48	36.37	44.05	42.17	54.00	-11.83	AV
Horizontal	11570.141	60.08	8.47	38.64	44.50	62.69	74.00	-11.31	Pk
Horizontal	11570.141	42.24	8.47	38.64	44.50	44.85	54.00	-9.15	AV
Horizontal	17355.243	5	10.12	38.38	44.10	9.4	68.20	-58.8	Pk
Horizontal	17355.243	42.26	10.12	38.38	44.10	46.66	54.00	-7.34	AV
High Channel (5825 MHz)-Above 1G									
Vertical	6039.199	57.61	7.10	37.24	43.50	58.45	68.20	-9.75	Pk
Vertical	6039.199	42.22	7.10	37.24	43.50	43.06	54.00	-10.94	AV
Vertical	11650.545	58.91	8.46	37.68	44.50	60.55	74.00	-13.45	Pk
Vertical	11650.545	41.15	8.46	37.68	44.50	42.79	54.00	-11.21	AV
Vertical	17475.135	58.51	10.12	38.8	44.10	63.33	68.20	-4.87	Pk
Vertical	17475.135	40.31	10.12	38.8	42.70	46.53	54.00	-7.47	AV
Horizontal	6039.232	59.91	7.10	37.24	43.50	60.75	68.20	-7.45	Pk
Horizontal	6039.232	43.35	7.10	37.24	43.50	44.19	54.00	-9.81	AV
Horizontal	11650.317	52.27	8.46	38.57	44.50	54.8	74.00	-19.2	Pk
Horizontal	11650.317	40.15	8.46	38.57	44.50	42.68	54.00	-11.32	AV
Horizontal	17475.065	57.76	10.12	38.38	44.10	62.16	68.20	-6.04	Pk
Horizontal	17475.065	40.32	10.12	38.38	44.10	44.72	54.00	-9.28	AV

Note: The amplitude of spurious emissions that are attenuated by more than 20dB below the permissible value

has no need to be reported.

Emission level (dBuV/m) = 20 log Emission level (uV/m).

Corrected Reading: Antenna Factor + Cable Loss + Read Level - Preamp Factor = Level.

Test Mode :	TX (5.8G) -- 802.11ac20
-------------	-------------------------

Polar	Frequency	Meter Reading	Cable loss	Antenna Factor	Preamp Factor	Emission Level	Limits	Margin	Detector Type
(H/V)	(MHz)	(dBuV)	(dB)	dB/m	(dB)	(dBuV/m)	(dBuV/m)	(dB)	
Low Channel (5745 MHz)-Above 1G									
Vertical	4679.195	59.65	5.94	35.40	44.00	56.99	74.00	-17.01	Pk
Vertical	4679.195	39.63	5.94	35.40	44.00	36.97	54.00	-17.03	AV
Vertical	11490.362	59.55	8.46	39.75	44.50	63.26	74.00	-10.74	Pk
Vertical	11490.362	42.15	8.46	39.75	44.50	45.86	54.00	-8.14	AV
Vertical	17235.102	55.57	10.12	38.80	44.10	60.39	68.20	-7.81	Pk
Vertical	17235.102	38.61	10.12	38.80	42.70	44.83	54.00	-9.17	AV
Horizontal	4679.332	57.93	5.94	35.18	44.00	55.05	74.00	-18.95	Pk
Horizontal	4679.332	44.55	5.94	35.18	44.00	41.67	54.00	-12.33	AV
Horizontal	11490.163	56.64	8.46	38.71	44.50	59.31	74.00	-14.69	Pk
Horizontal	11490.163	40.16	8.46	38.71	44.50	42.83	54.00	-11.17	AV
Horizontal	17235.195	58.65	10.12	38.38	44.10	63.05	68.20	-5.15	Pk
Horizontal	17235.195	42.28	10.12	38.38	44.10	46.68	54.00	-7.32	AV
middle Channel (5785 MHz)-Above 1G									
Vertical	4592.228	59.81	6.48	36.35	44.05	58.59	74.00	-15.41	Pk
Vertical	4592.228	43.36	6.48	36.35	44.05	42.14	54.00	-11.86	AV
Vertical	11570.208	61.15	8.47	37.88	44.51	62.99	74.00	-11.01	Pk
Vertical	11570.208	43.26	8.47	37.88	44.51	45.1	54.00	-8.9	AV
Vertical	17355.142	59.55	10.12	38.8	44.10	64.37	68.20	-3.83	Pk
Vertical	17355.142	42.26	10.12	38.8	42.70	48.48	54.00	-5.52	AV
Horizontal	4592.526	58.65	6.48	36.37	44.05	57.45	74.00	-16.55	Pk
Horizontal	4592.526	43.39	6.48	36.37	44.05	42.19	54.00	-11.81	AV
Horizontal	11570.124	60.08	8.47	38.64	44.50	62.69	74.00	-11.31	Pk
Horizontal	11570.124	42.22	8.47	38.64	44.50	44.83	54.00	-9.17	AV
Horizontal	17355.268	57.56	10.12	38.38	44.10	61.96	68.20	-6.24	Pk
Horizontal	17355.268	42.25	10.12	38.38	44.10	46.65	54.00	-7.35	AV
High Channel (5825 MHz)-Above 1G									
Vertical	6039.199	57.26	7.10	37.24	43.50	58.1	68.20	-10.1	Pk
Vertical	6039.199	42.36	7.10	37.24	43.50	43.2	54.00	-10.8	AV
Vertical	11650.563	58.57	8.46	37.68	44.50	60.21	74.00	-13.79	Pk
Vertical	11650.563	41.18	8.46	37.68	44.50	42.82	54.00	-11.18	AV
Vertical	17475.124	58.53	10.12	38.8	44.10	63.35	68.20	-4.85	Pk
Vertical	17475.124	40.36	10.12	38.8	42.70	46.58	54.00	-7.42	AV
Horizontal	6039.232	59.19	7.10	37.24	43.50	60.03	68.20	-8.17	Pk
Horizontal	6039.232	43.36	7.10	37.24	43.50	44.2	54.00	-9.8	AV
Horizontal	11650.315	52.22	8.46	38.57	44.50	54.75	74.00	-19.25	Pk
Horizontal	11650.315	40.13	8.46	38.57	44.50	42.66	54.00	-11.34	AV
Horizontal	17475.067	57.75	10.12	38.38	44.10	62.15	68.20	-6.05	Pk
Horizontal	17475.067	40.36	10.12	38.38	44.10	44.76	54.00	-9.24	AV

Note: The amplitude of spurious emissions that are attenuated by more than 20dB below the permissible value

has no need to be reported.

Emission level (dBuV/m) = 20 log Emission level (uV/m).

Corrected Reading: Antenna Factor + Cable Loss + Read Level - Preamp Factor = Level.

Duty cycle

A20-5180MHz

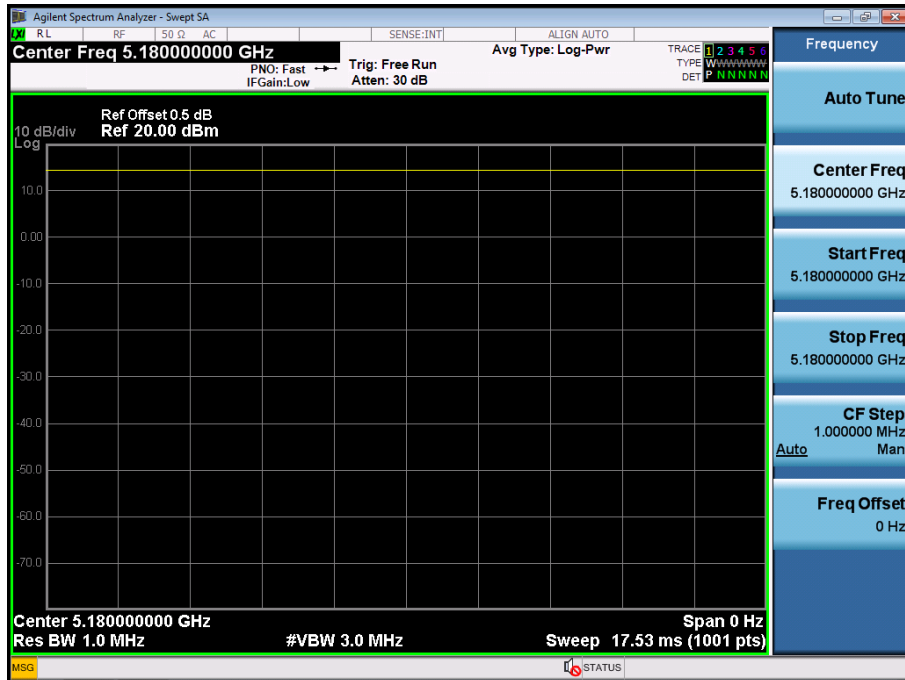

n20-5200MHz

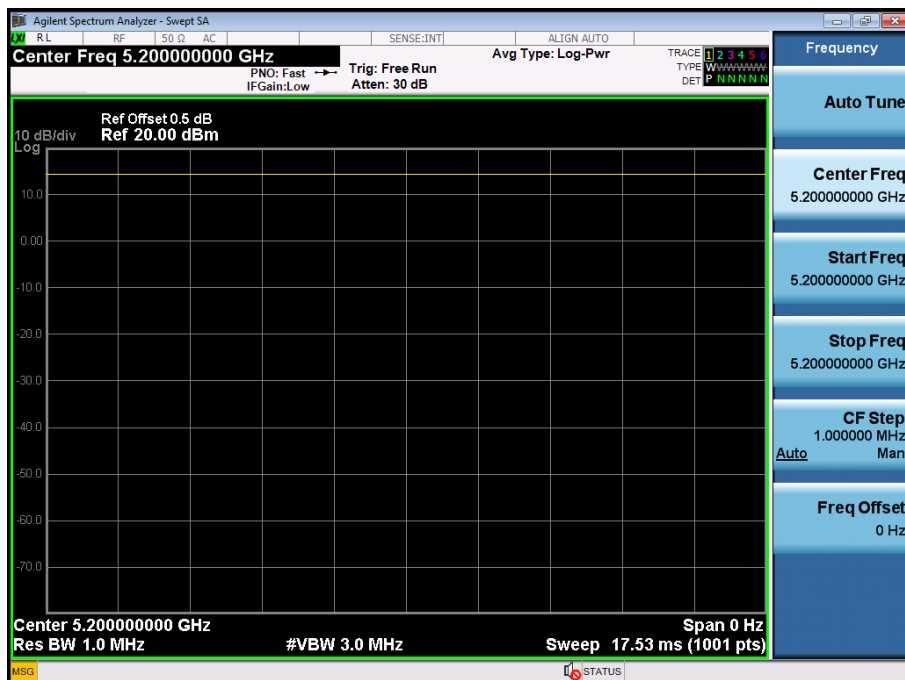

AC20-5240MHz

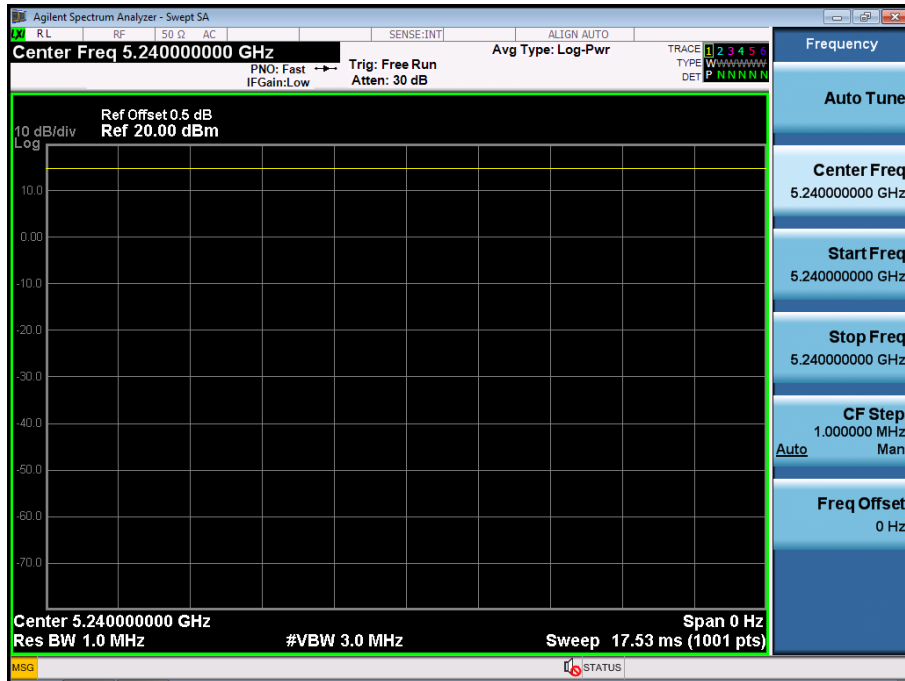

A20-5745MHz

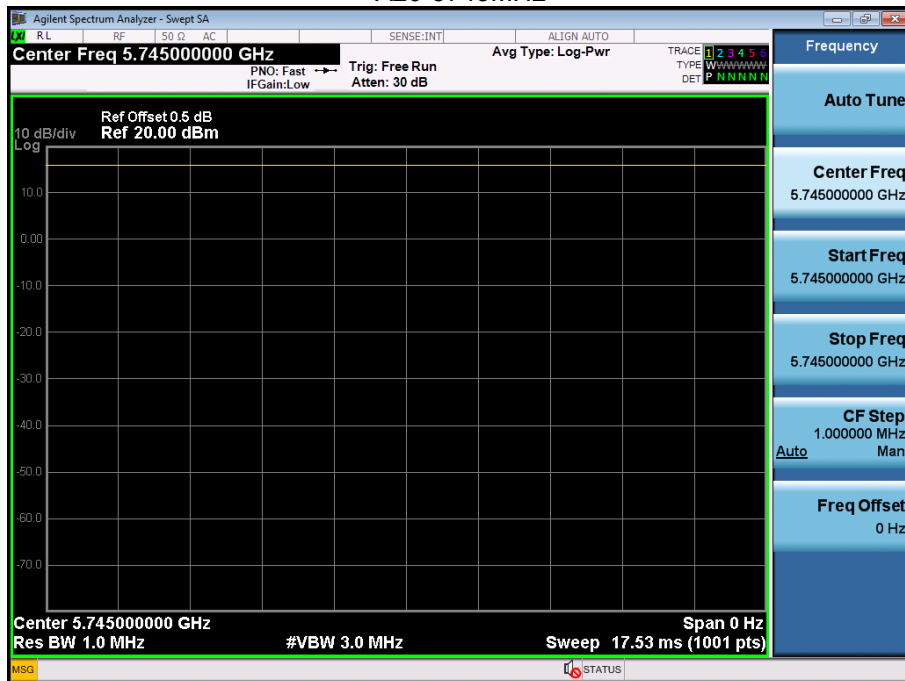

n20-5785MHz

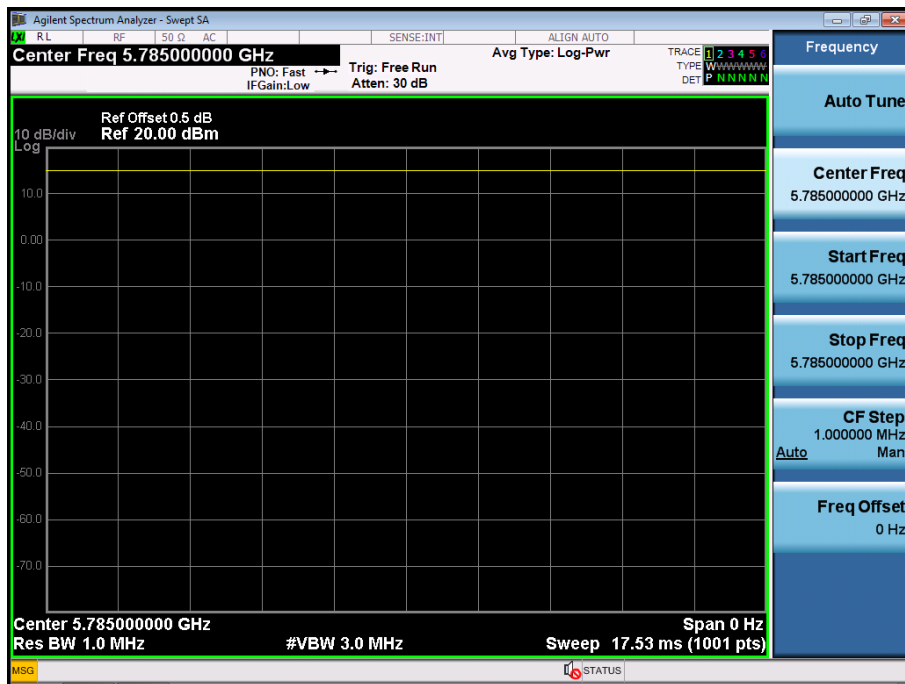

ac20-5825MHz

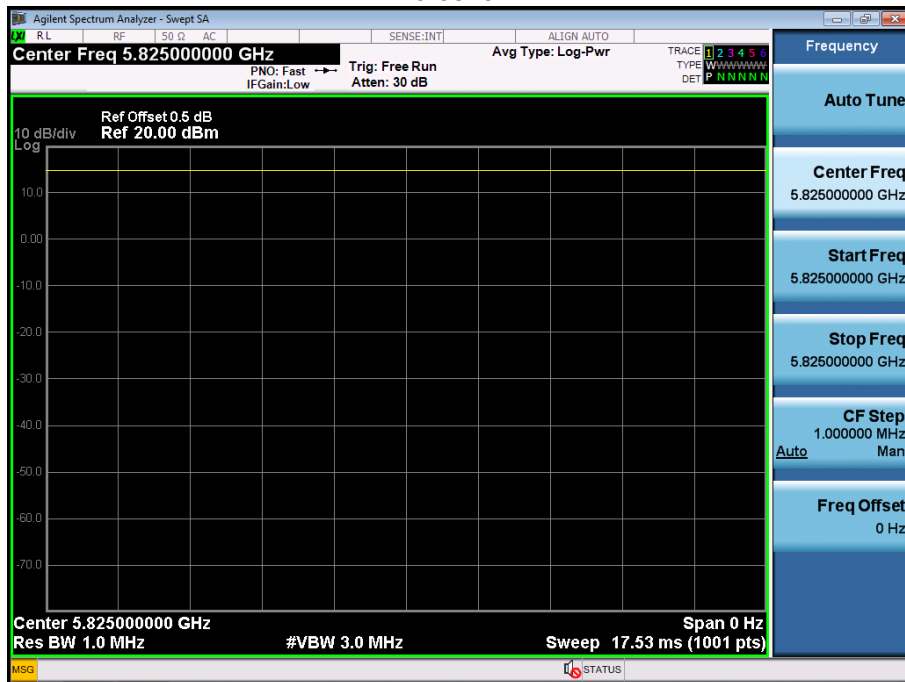

4. POWER SPECTRAL DENSITY TEST

4.1 APPLIED PROCEDURES / LIMIT

According to FCC §15.407(a)(3)

For the band 5.15-5.25 GHz,

(i) For an outdoor access point operating in the band 5.15-5.25 GHz, the maximum power spectral density shall not exceed 17 dBm in any 1 megahertz band. If transmitting antennas of directional gain greater than 6 dBi are used, both the maximum conducted output power and the maximum power spectral density shall be reduced by the amount in dB that the directional gain of the antenna exceeds 6 dBi. The maximum e.i.r.p. at any elevation angle above 30 degrees as measured from the horizon must not exceed 125 mW (21 dBm).

(ii) For an indoor access point operating in the band 5.15-5.25 GHz, the maximum power spectral density shall not exceed 17 dBm in any 1 megahertz band. If transmitting antennas of directional gain greater than 6 dBi are used, both the maximum conducted output power and the maximum power spectral density shall be reduced by the amount in dB that the directional gain of the antenna exceeds 6 dBi.

(iii) For fixed point-to-point access points operating in the band 5.15-5.25 GHz, the maximum power spectral density shall not exceed 17 dBm in any 1 megahertz band. Fixed point-to-point U-NII devices may employ antennas with directional gain up to 23 dBi without any corresponding reduction in the maximum conducted output power or maximum power spectral density. For fixed point-to-point transmitters that employ a directional antenna gain greater than 23 dBi, a 1 dB reduction in maximum conducted output power and maximum power spectral density is required for each 1 dB of antenna gain in excess of 23 dBi. Fixed, point-to-point operations exclude the use of point-to-multipoint systems, omnidirectional applications, and multiple colocated transmitters transmitting the same information. The operator of the U-NII device, or if the equipment is professionally installed, the installer, is responsible for ensuring that systems employing high gain directional antennas are used exclusively for fixed, point-to-point operations.

(iv) For client devices in the 5.15-5.25 GHz band, the maximum power spectral density shall not exceed 11 dBm in any 1 megahertz band. If transmitting antennas of directional gain greater than 6 dBi are used, both the maximum conducted output power and the maximum power spectral density shall be reduced by the amount in dB that the directional gain of the antenna exceeds 6 dBi.

For the band 5.725-5.85 GHz

(3) For the band 5.725-5.85 GHz, the maximum power spectral density shall not exceed 30 dBm in any 500-kHz band. If transmitting antennas of directional gain greater than 6 dBi are used, both the maximum conducted output power and the maximum power spectral density shall be reduced by the amount in dB that the directional gain of the antenna exceeds 6 dBi.

4.2 TEST PROCEDURE

For devices operating in the bands 5.15-5.25 GHz, 5.25-5.35 GHz, and 5.47-5.725 GHz, the above procedures make use of 1 MHz RBW to satisfy directly the 1 MHz reference bandwidth specified in § 15.407(a)(5). For devices operating in the band 5.725-5.85 GHz, the rules specify a measurement bandwidth of 500 kHz. Many spectrum analyzers do not have 500 kHz RBW, thus a narrower RBW may need to be used. The rules permit the use of a RBWs less than 1 MHz, or 500 kHz, “provided that the measured power is integrated over the full reference bandwidth” to show the total power over the specified measurement bandwidth (i.e., 1 MHz, or 500 kHz). If measurements are performed using a reduced resolution bandwidth (< 1 MHz, or < 500 kHz) and integrated over 1 MHz, or 500 KHz bandwidth, the following adjustments to the procedures apply:

- a) Set $RBW \geq 1/T$, where T is defined in section II.B.I.a).
- b) Set $VBW \geq 3 RBW$.
- c) If measurement bandwidth of Maximum PSD is specified in 500 kHz, add $10\log(500\text{kHz}/RBW)$ to the measured result, whereas RBW (< 500 KHz) is the reduced resolution bandwidth of the spectrum analyzer set during measurement.
- d) If measurement bandwidth of Maximum PSD is specified in 1 MHz, add $10\log(1\text{MHz}/RBW)$ to the measured result, whereas RBW (< 1 MHz) is the reduced resolution bandwidth of spectrum analyzer set during measurement.
- e) Care must be taken to ensure that the measurements are performed during a period of continuous transmission or are corrected upward for duty cycle.

Note: As a practical matter, it is recommended to use reduced RBW of 100 KHz for the sections 5.c) and 5.d) above, since RBW=100 KHZ is available on nearly all spectrum analyzers.

4.3 DEVIATION FROM STANDARD

No deviation.

4.4 TEST SETUP

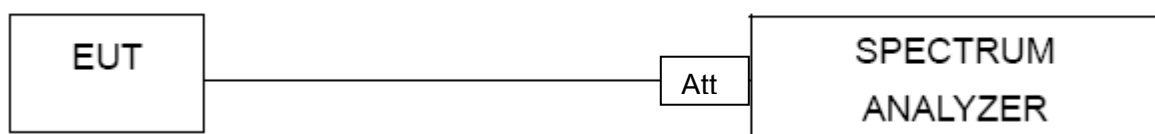

4.5 EUT OPERATION CONDITIONS

The EUT tested system was configured as the statements of 2.1 Unless otherwise a special operating condition is specified in the follows during the testing.

4.6 TEST RESULTS

Temperature :	26 °C	Relative Humidity :	54%
Pressure :	101kPa	Test Voltage :	AC120V
Test Mode :	TX Frequency U-NII-1 (5180-5240MHz)		

Mode	Frequency	Measured Power Density (dBm/MHz)	Limit (dBm/MHz)	Result
802.11 a	5180 MHz	-2.369	11	PASS
	5200 MHz	-3.660	11	PASS
	5240 MHz	-2.438	11	PASS
802.11 n20	5180 MHz	-2.247	11	PASS
	5200 MHz	-2.336	11	PASS
	5240 MHz	-1.563	11	PASS
802.11 n40	5190 MHz	-3.825	11	PASS
	5230 MHz	-2.855	11	PASS
802.11 AC20	5180 MHz	-2.114	11	PASS
	5200 MHz	-2.357	11	PASS
	5240 MHz	-1.742	11	PASS
802.11 AC40	5190 MHz	-3.617	11	PASS
	5230 MHz	-2.568	11	PASS
802.11 AC80	5210 MHz	-3.882	11	PASS

(802.11a) PSD plot on channel 36

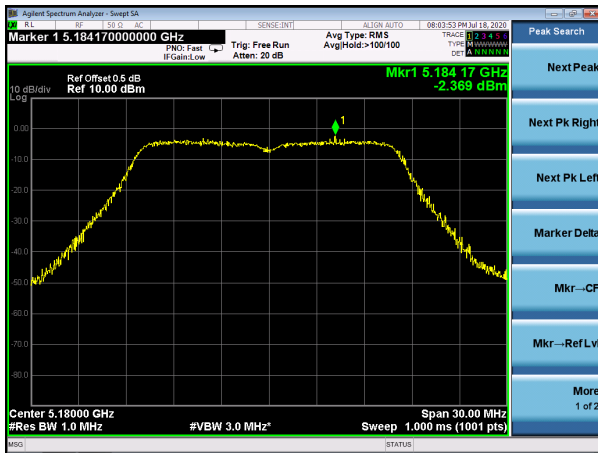

(802.11n20) PSD plot on channel 36



(802.11a) PSD plot on channel 40



(802.11n20) PSD plot on channel 40

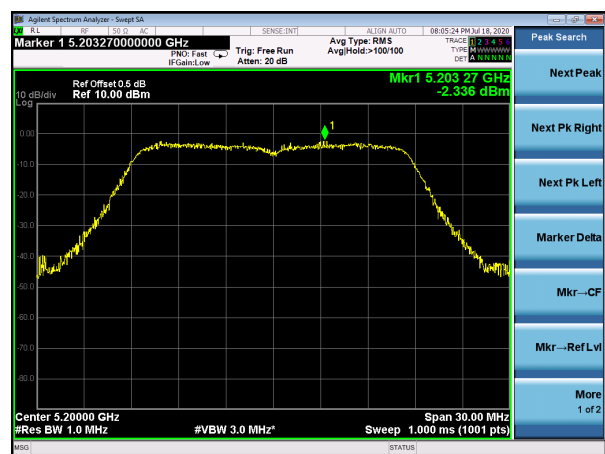

(802.11a) PSD plot on channel 48

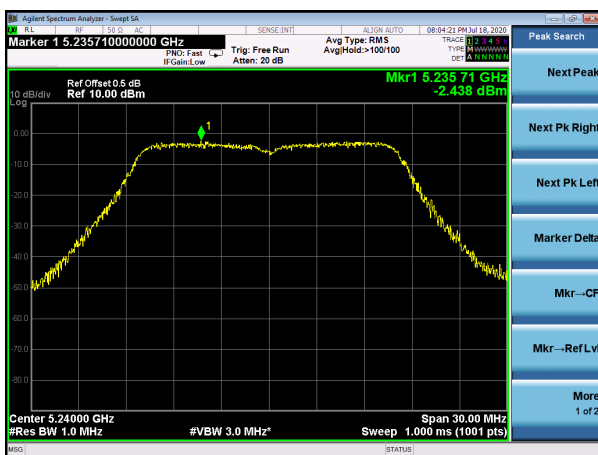

(802.11n20) PSD plot on channel 48

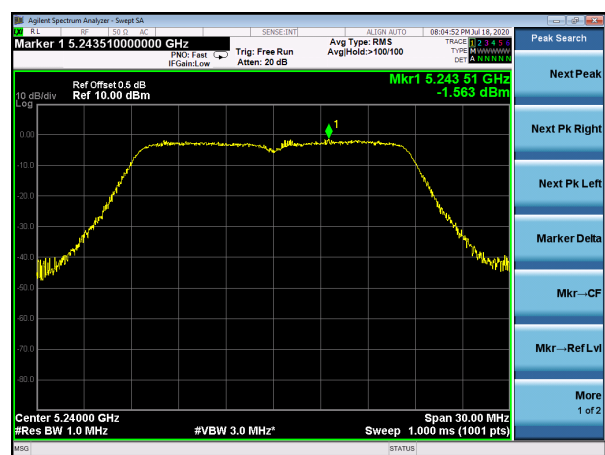

(802.11n40) PSD plot on channel 38

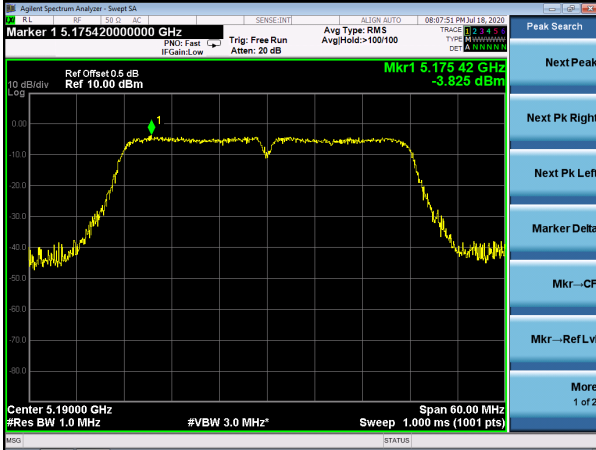

(802.11ac20) PSD plot on channel 36

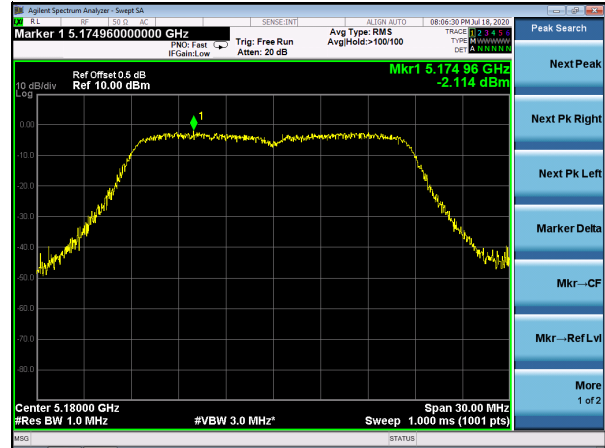

(802.11n40) PSD plot on channel 46

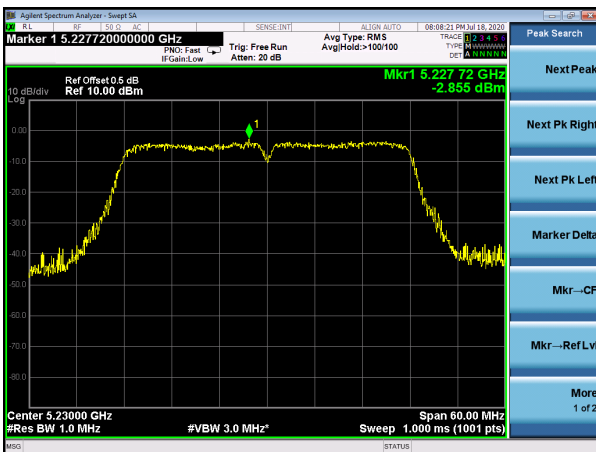

(802.11ac20) PSD plot on channel 40

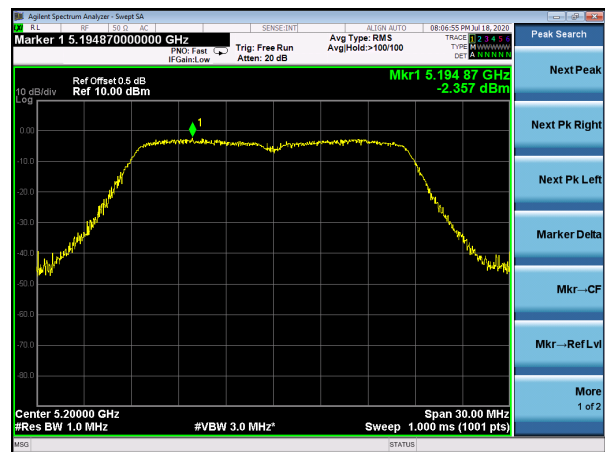

(802.11ac20) PSD plot on channel 48

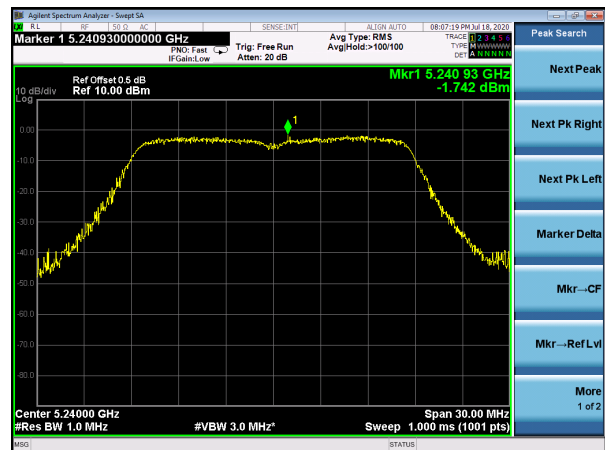

(802.11ac40) PSD plot on channel 38



(802.11ac80) PSD plot on channel 42

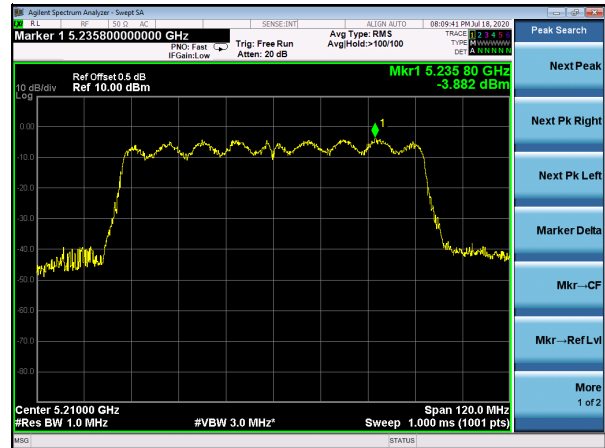

(802.11ac40) PSD plot on channel 46

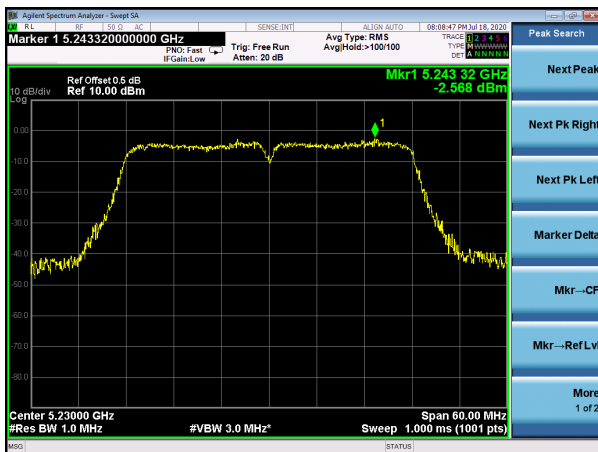

Temperature :	26 °C	Relative Humidity :	54%
Pressure :	101kPa	Test Voltage :	AC120V
Test Mode :	TX Frequency U-NII-3 (5745-5825MHz)		

Mode	Frequency	Measured Power Density (dBm/500kHz)	Limit (dBm/500kHz)	Result
802.11 a	5745 MHz	-3.841	30	PASS
	5785 MHz	-3.627	30	PASS
	5825 MHz	-3.813	30	PASS
802.11 n20	5745 MHz	-3.332	30	PASS
	5785 MHz	-3.071	30	PASS
	5825 MHz	-3.120	30	PASS
802.11 n40	5755 MHz	-5.882	30	PASS
	5795 MHz	-5.480	30	PASS
802.11 AC20	5745 MHz	-3.726	30	PASS
	5785 MHz	-3.466	30	PASS
	5825 MHz	-3.744	30	PASS
802.11 AC40	5755 MHz	-5.000	30	PASS
	5795 MHz	-4.634	30	PASS
802.11 AC80	5775 MHz	-6.022	30	PASS

(802.11a) PSD plot on channel 149

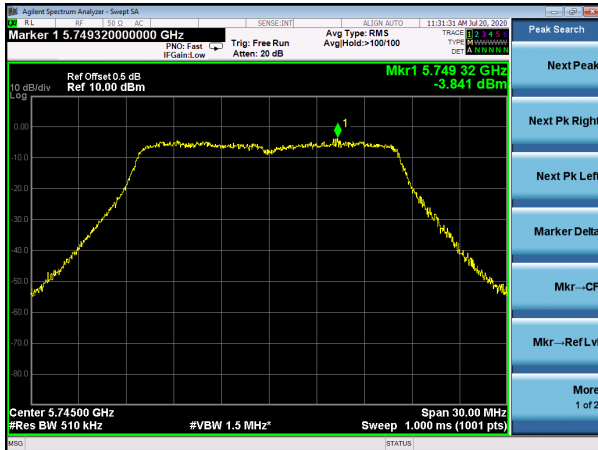

(802.11n20) PSD plot on channel 149



(802.11a) PSD plot on channel 157



(802.11n20) PSD plot on channel 157

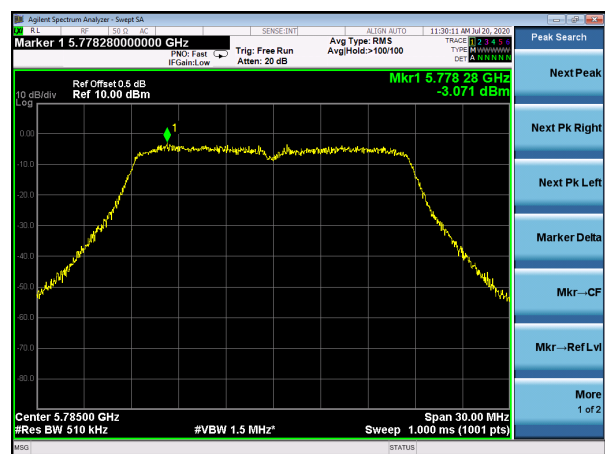

(802.11a) PSD plot on channel 165

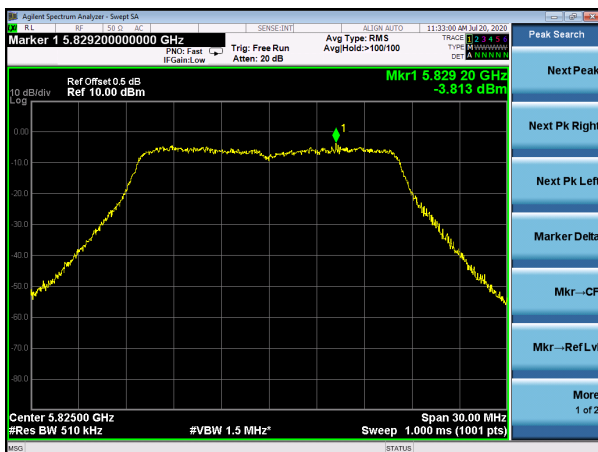

(802.11n20) PSD plot on channel 165

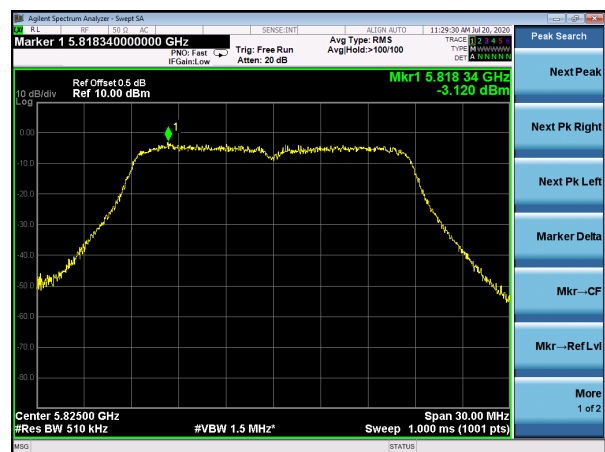

(802.11n40) PSD plot on channel 151

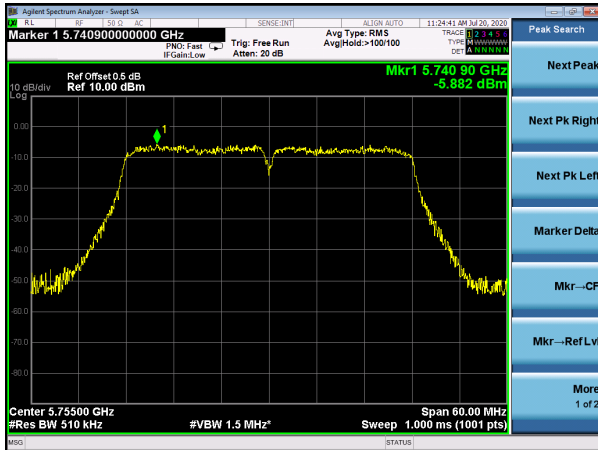

(802.11ac20) PSD plot on channel 149



(802.11n40) PSD plot on channel 159



(802.11ac20) PSD plot on channel 157

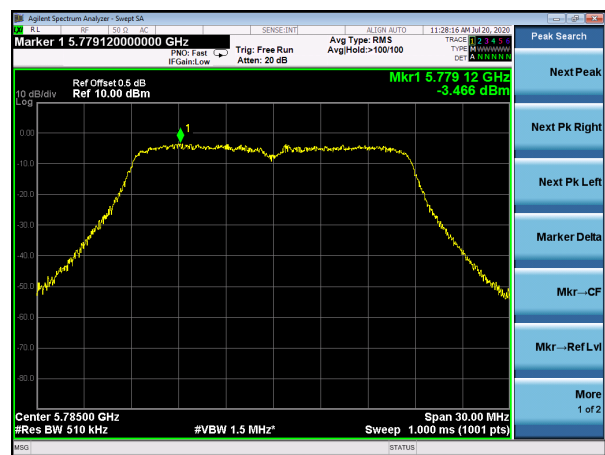

(802.11ac20) PSD plot on channel 165

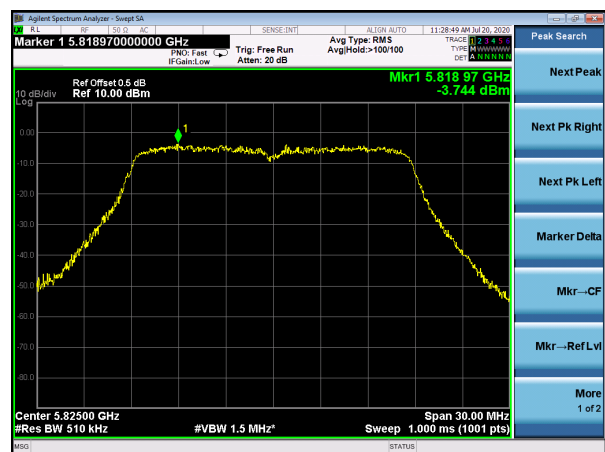

(802.11ac40) PSD plot on channel 151

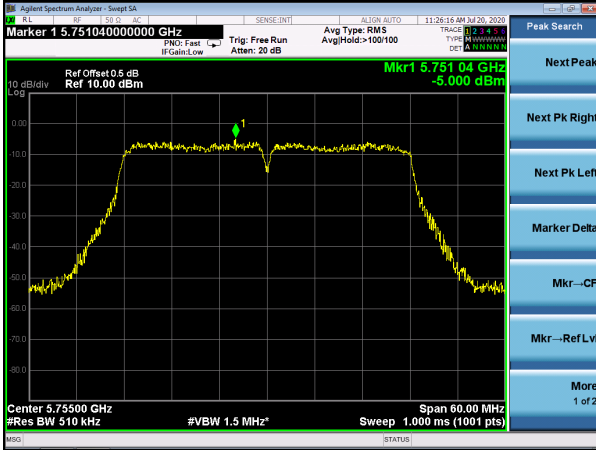

(802.11ac80) PSD plot on channel 155



(802.11ac40) PSD plot on channel 159



5. 26DB & 6DB& 99% EMISSION BANDWIDTH

5.1 APPLIED PROCEDURES / LIMIT

The maximum power spectral density is measured as a conducted emission by direct connection of a calibrated test instrument to the equipment under test. If the device cannot be connected directly, alternative techniques acceptable to the Commission may be used. Measurements in the 5.725-5.85 GHz band are made over a reference bandwidth of 500 kHz or the 26 dB emission bandwidth of the device, whichever is less. Measurements in the 5.15-5.25 GHz, 5.25-5.35 GHz, and the 5.47-5.725 GHz bands are made over a bandwidth of 1 MHz or the 26 dB emission bandwidth of the device, whichever is less. A narrower resolution bandwidth can be used, provided that the measured power is integrated over the full reference bandwidth.

5.2 TEST PROCEDURE

- a) Set RBW = approximately 1% of the emission bandwidth.
- b) Set the VBW > RBW.
- c) Detector = Peak.
- d) Trace mode = max hold.
- e) Measure the maximum width of the emission that is 26 dB down from the maximum of the emission. Compare this with the RBW setting of the analyzer. Readjust RBW and repeat measurement as needed until the RBW/EBW ratio is approximately 1%.

The following procedure shall be used for measuring (99 %) power bandwidth:

1. Set center frequency to the nominal EUT channel center frequency.
2. Set span = 1.5 times to 5.0 times the OBW.
3. Set RBW = 1 % to 5 % of the OBW
4. Set VBW $\geq 3 \cdot$ RBW
5. Video averaging is not permitted. Where practical, a sample detection and single sweep mode shall be used. Otherwise, peak detection and max hold mode (until the trace stabilizes) shall be used.
6. Use the 99 % power bandwidth function of the instrument (if available).
7. If the instrument does not have a 99 % power bandwidth function, the trace data points are recovered and directly summed in power units. The recovered amplitude data points, beginning at the lowest frequency, are placed in a running sum until 0.5 % of the total is reached; that frequency is recorded as the lower frequency. The process is repeated until 99.5 % of the total is reached; that frequency is recorded as the upper frequency. The 99% occupied bandwidth is the difference between these two frequencies.

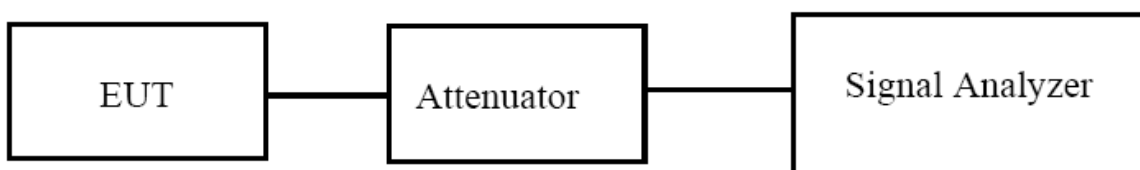

5.3 EUT OPERATION CONDITIONS

The EUT tested system was configured as the statements of 2.4 Unless otherwise a special operating condition is specified in the follows during the testing.

5.4 TEST RESULTS

Temperature :	26 °C	Relative Humidity :	54%
Pressure :	101kPa	Test Voltage :	AC120V
Test Mode :	TX Frequency U-NII-1 (5180-5240MHz)		

Mode	Channel	Frequency (MHz)	99% bandwidth(MHz)	26dB bandwidth (MHz)	Result
			Antenna A	Antenna A	
802.11a	CH36	5180	16.622	20.61	Pass
	CH40	5200	16.616	20.74	Pass
	CH48	5240	16.667	20.54	Pass
802.11 n20	CH36	5180	17.652	20.93	Pass
	CH40	5200	17.678	21.12	Pass
	CH48	5240	17.643	21.10	Pass
802.11 n40	CH 38	5190	36.627	43.28	Pass
	CH 46	5230	36.745	43.52	Pass
802.11 AC20	CH36	5180	17.642	21.26	Pass
	CH40	5200	17.677	21.14	Pass
	CH48	5240	17.673	21.14	Pass
802.11 AC40	CH 38	5190	36.621	43.07	Pass
	CH 46	5230	36.683	43.29	Pass
802.11 AC80	CH 42	5210	75.474	82.74	Pass

Test plot

(802.11a) -26dB&99%Bandwidth plot on channel 36

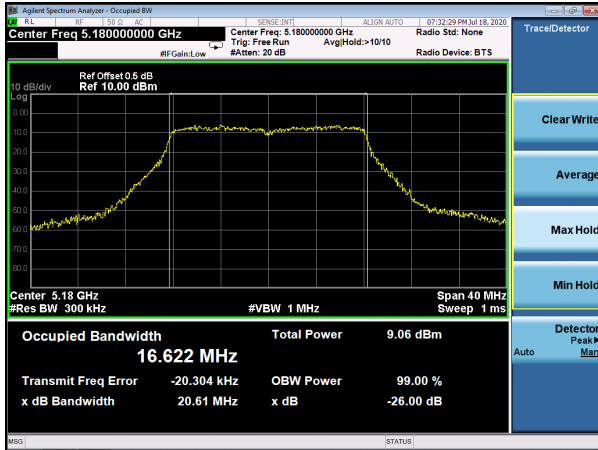

(802.11 n20) -26dB&99%Bandwidth plot on channel 36

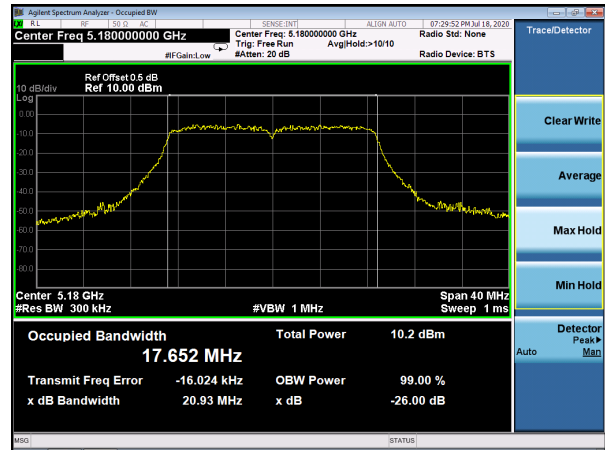

(802.11a) -26dB&99%Bandwidth plot on channel 40

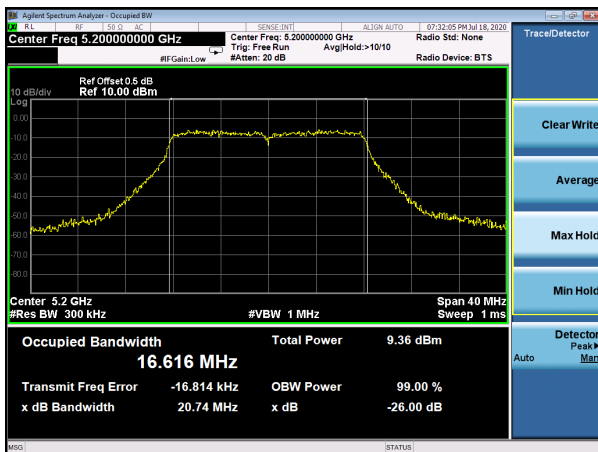

(802.11 n20) -26dB&99%Bandwidth plot on channel 40

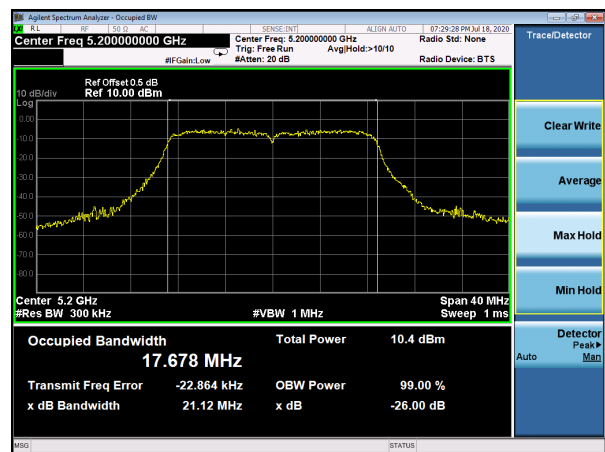

(802.11a) -26dB&99%Bandwidth plot on channel 48

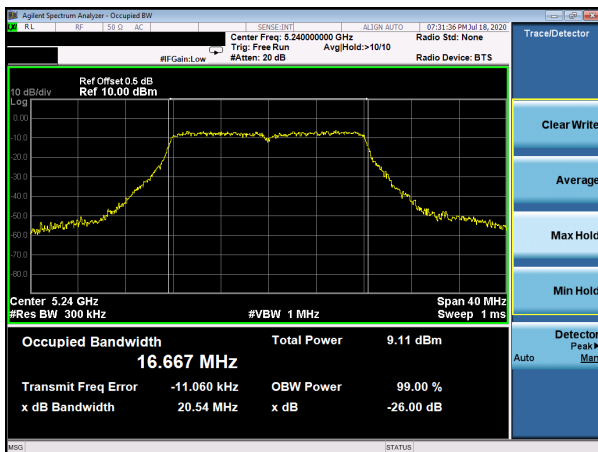

(802.11 n20) -26dB&99%Bandwidth plot on channel 48

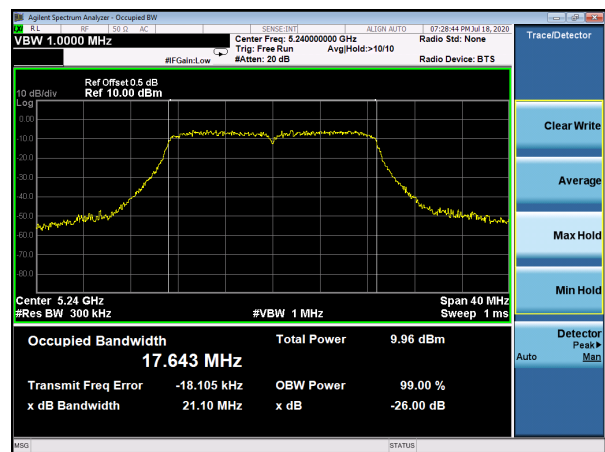

Test plot

(802.11 n40) -26dB&99%Bandwidth plot on channel 38

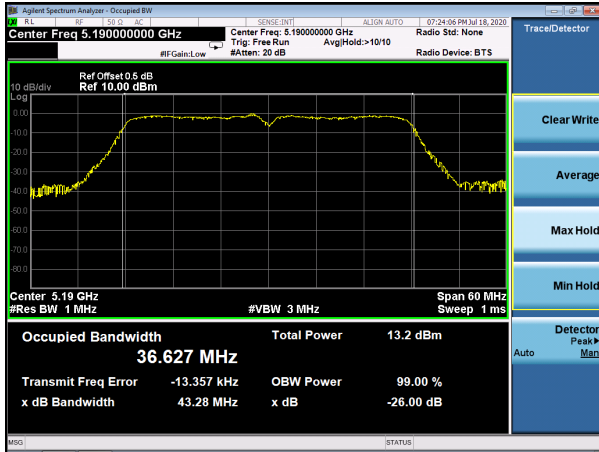

(802.11 AC20) -26dB&99%Bandwidth plot on channel 36

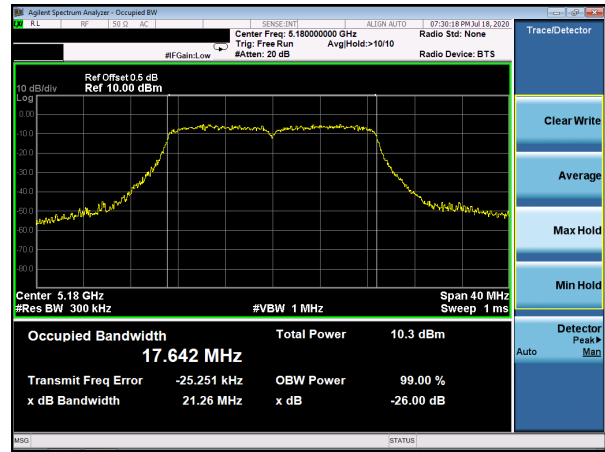

(802.11 n40) -26dB&99%Bandwidth plot on channel 46

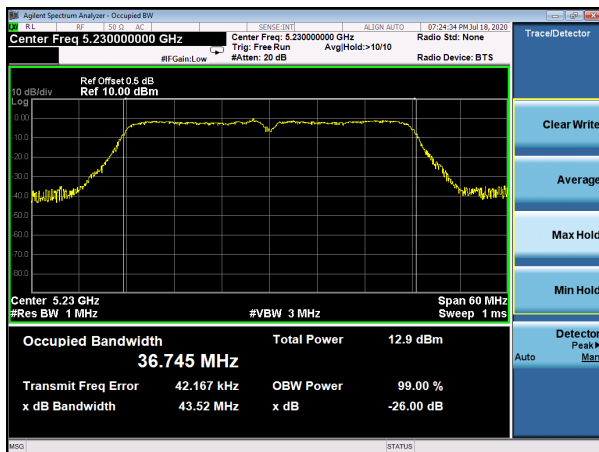

(802.11 AC20) -26dB&99%Bandwidth plot on channel 40

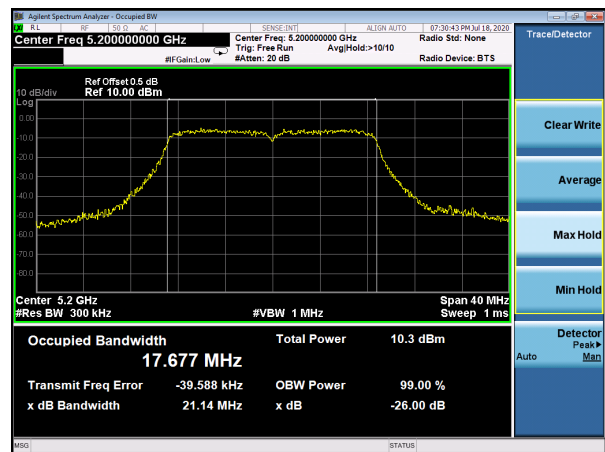

(802.11 AC20) -26dB&99%Bandwidth plot on channel 48

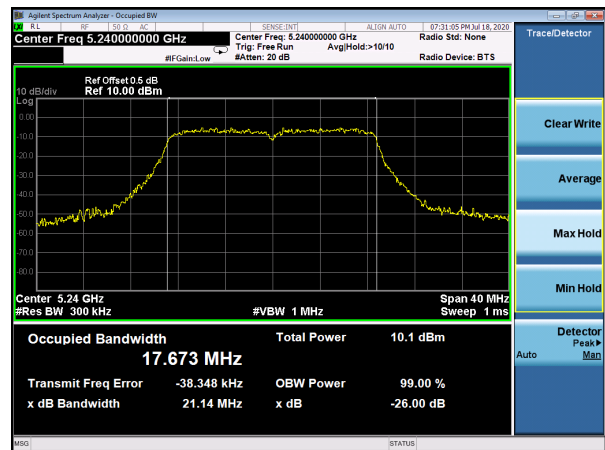

Test plot

(802.11 AC40) -26dB&99%Bandwidth plot on channel 38

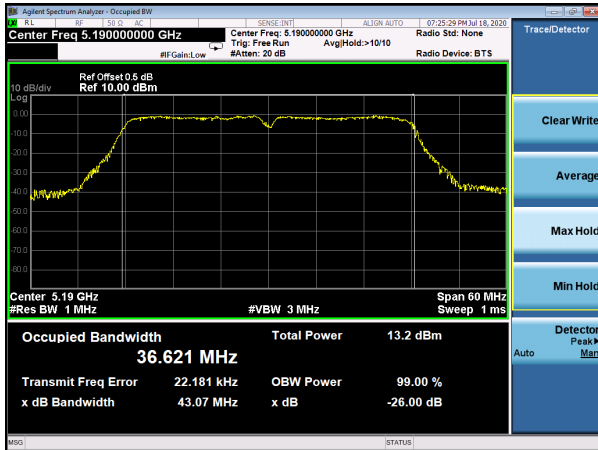

(802.11 AC80) -26dB&99%Bandwidth plot on channel 42

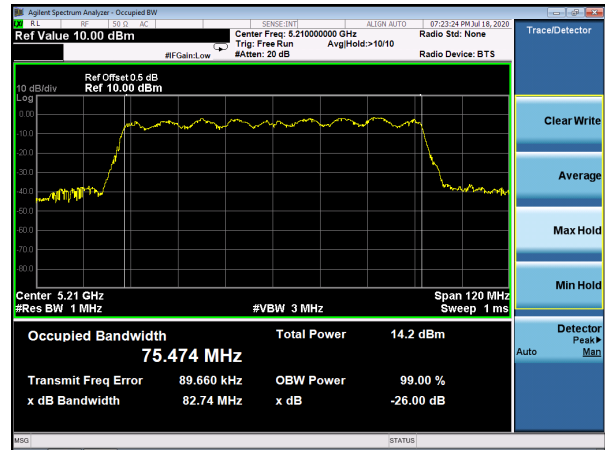

(802.11 AC40) -26dB&99%Bandwidth plot on channel 46

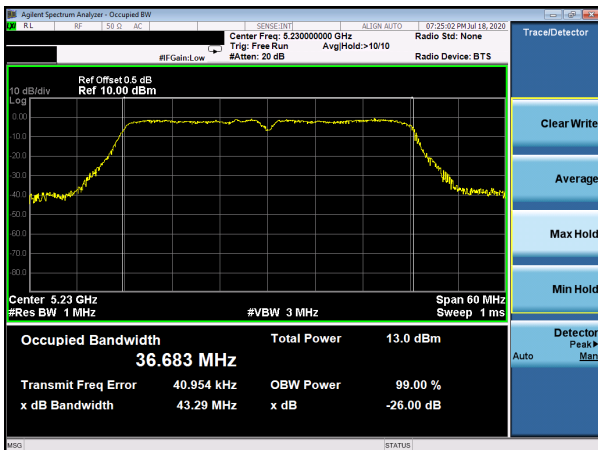

Temperature :	26 °C	Relative Humidity :	54%
Pressure :	101kPa	Test Voltage :	AC120V
Test Mode :	TX Frequency U-NII-3 (5745-5825MHz)		

Mode	Channel	Frequency (MHz)	99% bandwidth(MHz)	6dB bandwidth (MHz)	Result
802.11a	CH149	5745	16.651	16.34	Pass
	CH157	5785	16.656	16.09	Pass
	CH165	5825	16.664	16.33	Pass
802.11 n20	CH149	5745	17.654	16.86	Pass
	CH157	5785	17.653	16.83	Pass
	CH165	5825	17.644	16.83	Pass
802.11 n40	CH151	5755	36.660	35.50	Pass
	CH159	5795	36.514	35.52	Pass
802.11 AC20	CH149	5745	17.656	16.90	Pass
	CH157	5785	17.667	16.66	Pass
	CH165	5825	17.663	16.89	Pass
802.11 AC40	CH151	5755	36.582	35.24	Pass
	CH159	5795	36.704	35.50	Pass
802.11 AC80	CH155	5775	75.380	75.25	Pass

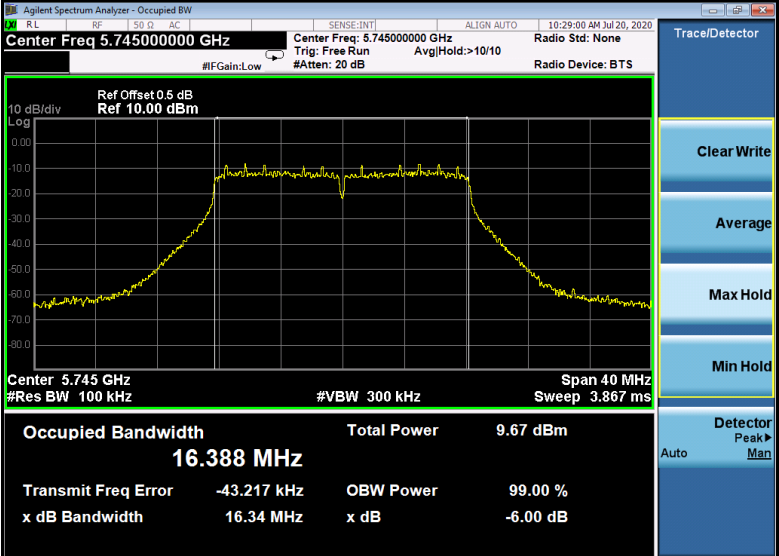
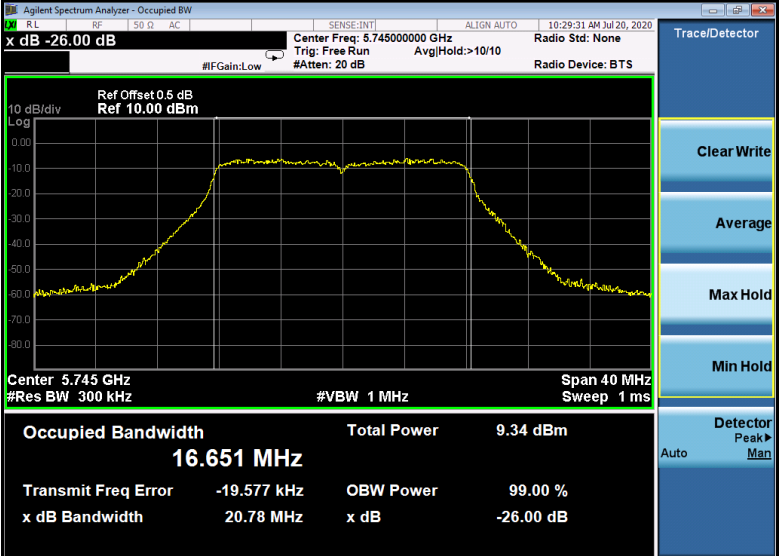
Mode:	802.11a-HT20
<p>5745MHz 6dB bandwidth</p>	 <p>Agilent Spectrum Analyzer - Occupied BW</p> <p>Center Freq 5.74500000 GHz</p> <p>Ref Offset 0.5 dB Ref 10.00 dBm</p> <p>Occupied Bandwidth 16.388 MHz</p> <p>Total Power 9.67 dBm</p> <p>Transmit Freq Error -43.217 kHz</p> <p>x dB Bandwidth 16.34 MHz</p> <p>OBW Power 99.00 %</p> <p>x dB -6.00 dB</p>
<p>5745MHz 99% bandwidth</p>	 <p>Agilent Spectrum Analyzer - Occupied BW</p> <p>Center Freq 5.745 GHz</p> <p>Ref Offset 0.5 dB Ref 10.00 dBm</p> <p>x dB -26.00 dB</p> <p>Occupied Bandwidth 16.651 MHz</p> <p>Total Power 9.34 dBm</p> <p>Transmit Freq Error -19.577 kHz</p> <p>x dB Bandwidth 20.78 MHz</p> <p>OBW Power 99.00 %</p> <p>x dB -26.00 dB</p>

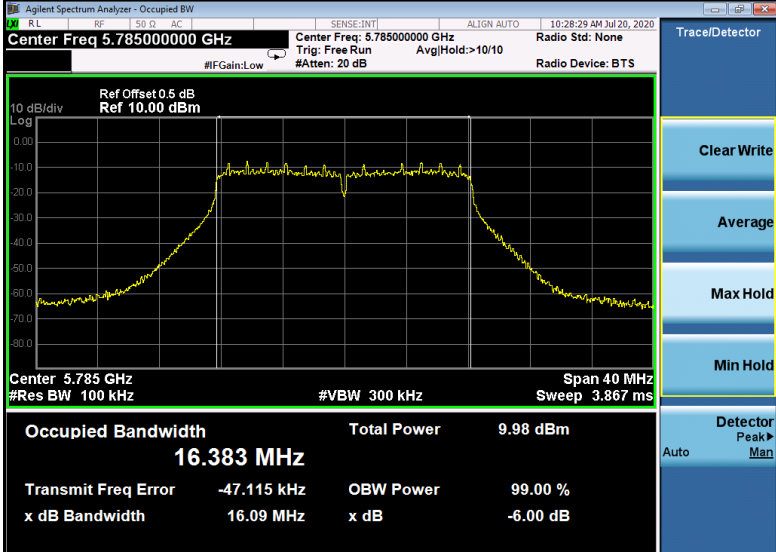
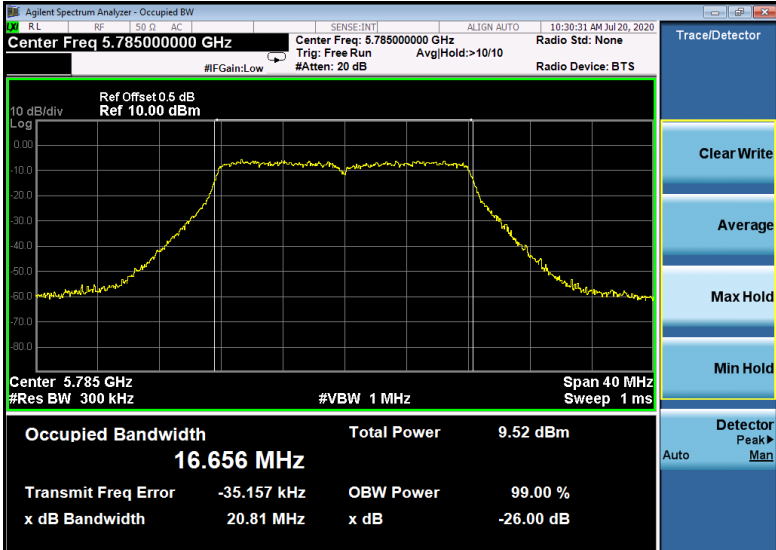
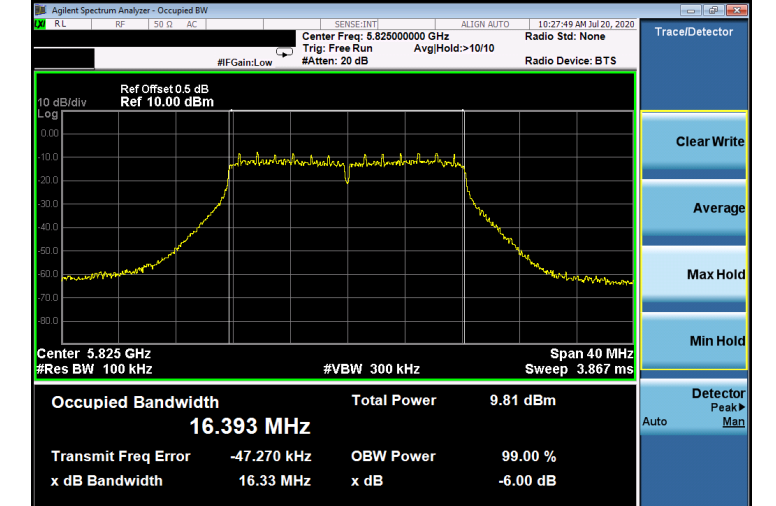
<p>5785MHz 6dB bandwidth</p>	 <p>Agilent Spectrum Analyzer - Occupied BW Center Freq 5.785000000 GHz #Res BW 100 kHz #VBW 300 kHz Span 40 MHz Sweep 3.867 ms Total Power 9.98 dBm Occupied Bandwidth 16.383 MHz Transmit Freq Error -47.115 kHz x dB Bandwidth 16.09 MHz</p>
<p>5785MHz 99% bandwidth</p>	 <p>Agilent Spectrum Analyzer - Occupied BW Center Freq 5.785000000 GHz #Res BW 300 kHz #VBW 1 MHz Span 40 MHz Sweep 1 ms Total Power 9.52 dBm Occupied Bandwidth 16.656 MHz Transmit Freq Error -35.157 kHz x dB Bandwidth 20.81 MHz</p>
<p>5825MHz 6dB bandwidth</p>	 <p>Agilent Spectrum Analyzer - Occupied BW Center Freq 5.825000000 GHz #Res BW 100 kHz #VBW 300 kHz Span 40 MHz Sweep 3.867 ms Total Power 9.81 dBm Occupied Bandwidth 16.393 MHz Transmit Freq Error -47.270 kHz x dB Bandwidth 16.33 MHz</p>

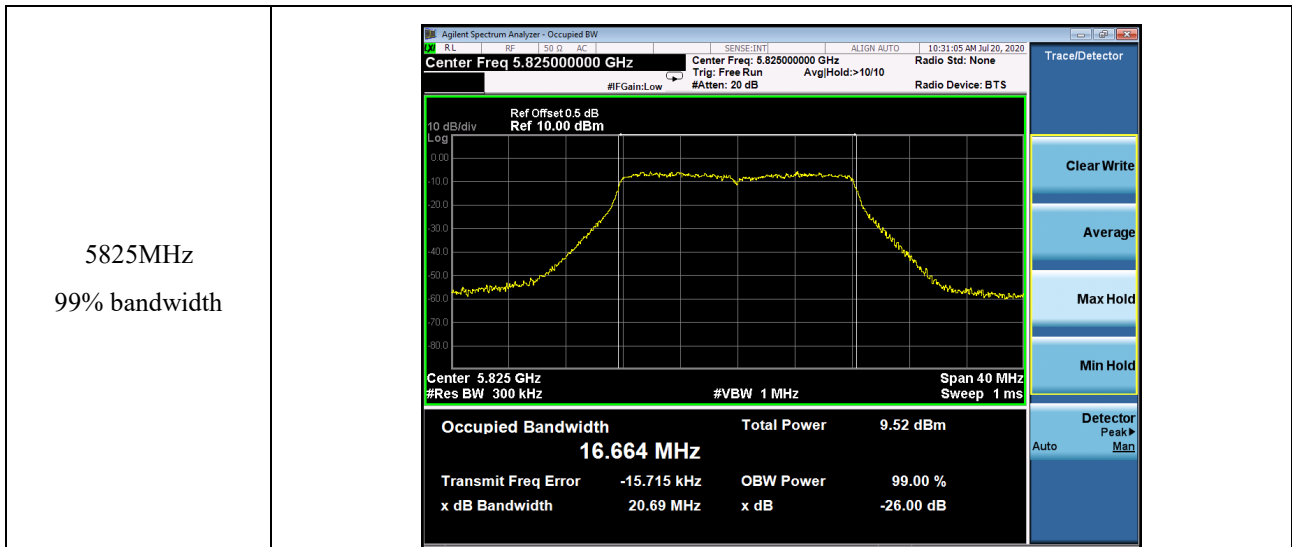

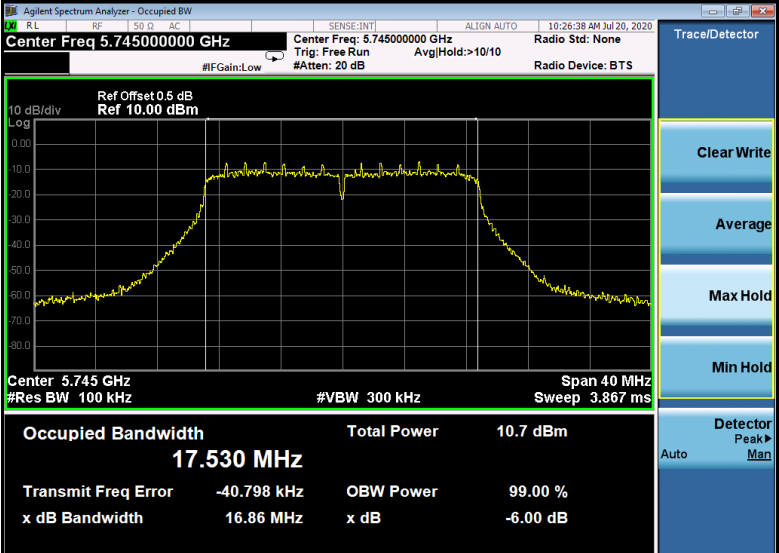
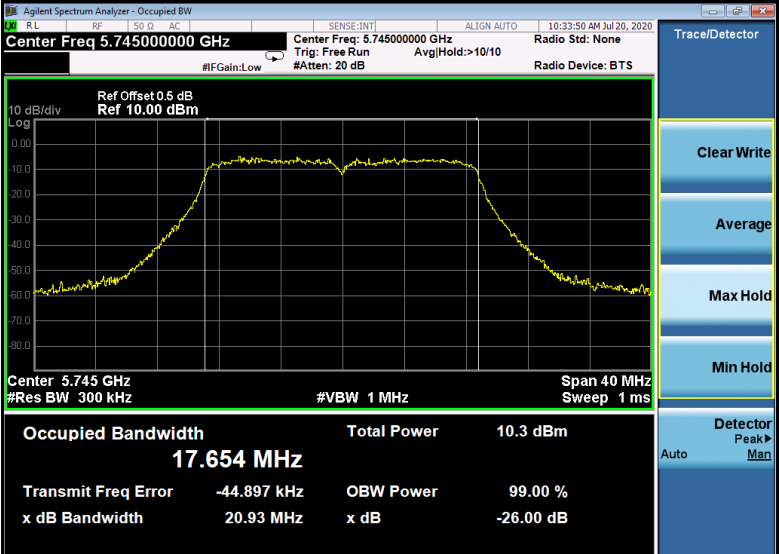
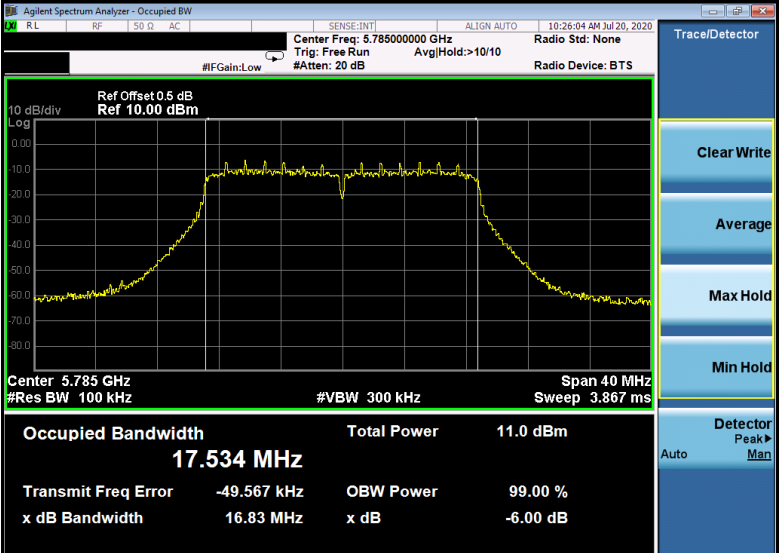
Mode:	802.11n-HT20
<p>5745MHz 6dB bandwidth</p>	 <p>Agilent Spectrum Analyzer - Occupied BW</p> <p>Center Freq: 5.74500000 GHz</p> <p>Ref Offset: 0.5 dB, Ref: 10.00 dBm</p> <p>Occupied Bandwidth: 17.530 MHz</p> <p>Total Power: 10.7 dBm</p> <p>Transmit Freq Error: -40.798 kHz</p> <p>OBW Power: 99.00 %</p> <p>x dB Bandwidth: 16.86 MHz</p>
<p>5745MHz 99% bandwidth</p>	 <p>Agilent Spectrum Analyzer - Occupied BW</p> <p>Center Freq: 5.74500000 GHz</p> <p>Ref Offset: 0.5 dB, Ref: 10.00 dBm</p> <p>Occupied Bandwidth: 17.654 MHz</p> <p>Total Power: 10.3 dBm</p> <p>Transmit Freq Error: -44.897 kHz</p> <p>OBW Power: 99.00 %</p> <p>x dB Bandwidth: 20.93 MHz</p>
<p>5785MHz 6dB bandwidth</p>	 <p>Agilent Spectrum Analyzer - Occupied BW</p> <p>Center Freq: 5.78500000 GHz</p> <p>Ref Offset: 0.5 dB, Ref: 10.00 dBm</p> <p>Occupied Bandwidth: 17.534 MHz</p> <p>Total Power: 11.0 dBm</p> <p>Transmit Freq Error: -49.567 kHz</p> <p>OBW Power: 99.00 %</p> <p>x dB Bandwidth: 16.83 MHz</p>

<p>5785MHz 99% bandwidth</p>	<p>Agilent Spectrum Analyzer - Occupied BW</p> <p>Center Freq 5.785000000 GHz Center Freq: 5.785000000 GHz Radio Std: None</p> <p>Trig: Free Run Avg/Hold: >10/10</p> <p>#IFGain: Low #Atten: 20 dB Radio Device: BTS</p> <p>Ref Offset 0.5 dB Ref 10.00 dBm</p> <p>Center 5.785 GHz #Res BW 300 kHz #VBW 1 MHz Span 40 MHz Sweep 1 ms</p> <table border="1"> <tr> <td>Occupied Bandwidth</td> <td>Total Power</td> <td>10.5 dBm</td> </tr> <tr> <td>17.653 MHz</td> <td></td> <td></td> </tr> <tr> <td>Transmit Freq Error</td> <td>OBW Power</td> <td>99.00 %</td> </tr> <tr> <td>-50.883 kHz</td> <td></td> <td></td> </tr> <tr> <td>x dB Bandwidth</td> <td>x dB</td> <td>-26.00 dB</td> </tr> <tr> <td>20.95 MHz</td> <td></td> <td></td> </tr> </table>	Occupied Bandwidth	Total Power	10.5 dBm	17.653 MHz			Transmit Freq Error	OBW Power	99.00 %	-50.883 kHz			x dB Bandwidth	x dB	-26.00 dB	20.95 MHz		
Occupied Bandwidth	Total Power	10.5 dBm																	
17.653 MHz																			
Transmit Freq Error	OBW Power	99.00 %																	
-50.883 kHz																			
x dB Bandwidth	x dB	-26.00 dB																	
20.95 MHz																			
<p>5825MHz 6dB bandwidth</p>	<p>Agilent Spectrum Analyzer - Occupied BW</p> <p>Center Freq 5.825000000 GHz Center Freq: 5.825000000 GHz Radio Std: None</p> <p>Trig: Free Run Avg/Hold: >10/10</p> <p>#IFGain: Low #Atten: 20 dB Radio Device: BTS</p> <p>Ref Offset 0.5 dB Ref 10.00 dBm</p> <p>Center 5.825 GHz #Res BW 100 kHz #VBW 300 kHz Span 40 MHz Sweep 3.867 ms</p> <table border="1"> <tr> <td>Occupied Bandwidth</td> <td>Total Power</td> <td>10.6 dBm</td> </tr> <tr> <td>17.546 MHz</td> <td></td> <td></td> </tr> <tr> <td>Transmit Freq Error</td> <td>OBW Power</td> <td>99.00 %</td> </tr> <tr> <td>-44.679 kHz</td> <td></td> <td></td> </tr> <tr> <td>x dB Bandwidth</td> <td>x dB</td> <td>-6.00 dB</td> </tr> <tr> <td>16.83 MHz</td> <td></td> <td></td> </tr> </table>	Occupied Bandwidth	Total Power	10.6 dBm	17.546 MHz			Transmit Freq Error	OBW Power	99.00 %	-44.679 kHz			x dB Bandwidth	x dB	-6.00 dB	16.83 MHz		
Occupied Bandwidth	Total Power	10.6 dBm																	
17.546 MHz																			
Transmit Freq Error	OBW Power	99.00 %																	
-44.679 kHz																			
x dB Bandwidth	x dB	-6.00 dB																	
16.83 MHz																			
<p>5825MHz 99% bandwidth</p>	<p>Agilent Spectrum Analyzer - Occupied BW</p> <p>Center Freq 5.825000000 GHz Center Freq: 5.825000000 GHz Radio Std: None</p> <p>Trig: Free Run Avg/Hold: >10/10</p> <p>#IFGain: Low #Atten: 20 dB Radio Device: BTS</p> <p>Ref Offset 0.5 dB Ref 10.00 dBm</p> <p>Center 5.825 GHz #Res BW 300 kHz #VBW 1 MHz Span 40 MHz Sweep 1 ms</p> <table border="1"> <tr> <td>Occupied Bandwidth</td> <td>Total Power</td> <td>10.1 dBm</td> </tr> <tr> <td>17.644 MHz</td> <td></td> <td></td> </tr> <tr> <td>Transmit Freq Error</td> <td>OBW Power</td> <td>99.00 %</td> </tr> <tr> <td>-45.743 kHz</td> <td></td> <td></td> </tr> <tr> <td>x dB Bandwidth</td> <td>x dB</td> <td>-26.00 dB</td> </tr> <tr> <td>20.98 MHz</td> <td></td> <td></td> </tr> </table>	Occupied Bandwidth	Total Power	10.1 dBm	17.644 MHz			Transmit Freq Error	OBW Power	99.00 %	-45.743 kHz			x dB Bandwidth	x dB	-26.00 dB	20.98 MHz		
Occupied Bandwidth	Total Power	10.1 dBm																	
17.644 MHz																			
Transmit Freq Error	OBW Power	99.00 %																	
-45.743 kHz																			
x dB Bandwidth	x dB	-26.00 dB																	
20.98 MHz																			