



FCC Part 15C Test Report

FCC ID: 2AW9M-DREAM01

Product Name:	Digital Photo Frame
Trademark:	N/A
Model Name :	Dream 01
Prepared For :	Shenzhen Efercro Electronic Technology Co., Ltd
Address :	510, Building U2, Junxiang U8 Intelligent Manufacturing Industrial Park, Xixiang Street, Baoan District, Shenzhen, Guangdong, China
Prepared By :	Shenzhen BCTC Testing Co., Ltd.
Address :	BCTC Building & 1-2F, East of B Building, Pengzhou Industrial, Fuyuan 1st Road, Qiaotou Community, Fuyong Street, Bao'an District, Shenzhen, China
Test Date:	Jul. 10, 2020 – Jul. 20, 2020
Date of Report :	Jul. 20, 2020
Report No.:	BCTC2007000333-1E

TEST RESULT CERTIFICATION

Applicant's name Shenzhen Efercro Electronic Technology Co., Ltd
Address 510, Building U2, Junxiang U8 Intelligent Manufacturing Industrial Park, Xixiang Street, Baoan District, Shenzhen, Guangdong, China

Manufacture's Name Shenzhen Efercro Electronic Technology Co., Ltd
Address 510, Building U2, Junxiang U8 Intelligent Manufacturing Industrial Park, Xixiang Street, Baoan District, Shenzhen, Guangdong, China

Product description

Product name Digital Photo Frame

Trademark N/A

Model and/or type reference Dream 01

Standards FCC Part15.247
ANSI C63.10:2013
KDB 558074

This device described above has been tested by BCTC, and the test results show that the equipment under test (EUT) is in compliance with the FCC requirements. And it is applicable only to the tested sample identified in the report.

This report shall not be reproduced except in full, without the written approval of BCTC, this document may be altered or revised by BCTC, personal only, and shall be noted in the revision of the document.

Prepared by(Engineer):

Sam zeng

Sam Zeng

Reviewer(Supervisor):

Eric Yang

Eric Yang

Approved(Manager):

Zero Zhou

Zero Zhou





Table of Contents	Page
1 . SUMMARY OF TEST RESULTS	5
1.1 TEST FACILITY	6
1.2 MEASUREMENT UNCERTAINTY	6
2 . GENERAL INFORMATION	7
2.1 GENERAL DESCRIPTION OF EUT	7
2.2 DESCRIPTION OF TEST MODES	8
2.3 BLOCK DIGRAM SHOWING THE CONFIGURATION OF SYSTEM TESTED	8
2.4 DESCRIPTION OF SUPPORT UNITS(CONDUCTED MODE)	9
2.5 EQUIPMENTS LIST FOR ALL TEST ITEMS	10
3 . EMC EMISSION TEST	12
3.1 CONDUCTED EMISSION MEASUREMENT	12
3.1.1 POWER LINE CONDUCTED EMISSION LIMITS	12
3.1.2 TEST PROCEDURE	12
3.1.3 DEVIATION FROM TEST STANDARD	12
3.1.4 TEST SETUP	13
3.1.5 EUT OPERATING CONDITIONS	13
3.1.6 TEST RESULTS	14
3.2 RADIATED EMISSION MEASUREMENT	16
3.2.1 RADIATED EMISSION LIMITS	16
3.2.2 TEST PROCEDURE	17
3.2.3 DEVIATION FROM TEST STANDARD	17
3.2.4 TEST SETUP	17
3.2.5 EUT OPERATING CONDITIONS	18
3.2.6 TEST RESULTS (BETWEEN 9KHZ – 30 MHZ)	19
3.2.7 TEST RESULTS (BETWEEN 30MHZ – 1GHZ)	20
3.2.8 TEST RESULTS (1GHZ~25GHZ)	22
3.3 RADIATED BAND EMISSION MEASUREMENT	25
3.3.1 TEST REQUIREMENT:	25
3.3.2 TEST PROCEDURE	25
3.3.3 DEVIATION FROM TEST STANDARD	26
3.3.4 TEST SETUP	26
3.3.5 EUT OPERATING CONDITIONS	26
4 . POWER SPECTRAL DENSITY TEST	28
4.1 APPLIED PROCEDURES / LIMIT	28
4.1.1 TEST PROCEDURE	28



Table of Contents	Page
4.1.2 DEVIATION FROM STANDARD	28
4.1.3 TEST SETUP	28
4.1.4 EUT OPERATION CONDITIONS	28
4.1.5 TEST RESULTS	29
5 . BANDWIDTH TEST	35
5.1 APPLIED PROCEDURES / LIMIT	35
5.1.1 TEST PROCEDURE	35
5.1.2 DEVIATION FROM STANDARD	35
5.1.3 TEST SETUP	35
5.1.4 EUT OPERATION CONDITIONS	35
5.1.5 TEST RESULTS	36
6 . PEAK OUTPUT POWER TEST	42
6.1 APPLIED PROCEDURES/LIMIT	42
6.1.1 TEST PROCEDURE	42
6.1.2 DEVIATION FROM STANDARD	42
6.1.3 TEST SETUP	42
6.1.4 EUT OPERATION CONDITIONS	42
6.1.5 TEST RESULTS	43
7 . 100 KHZ BANDWIDTH OF FREQUENCY BAND EDGE	44
7.1 APPLICABLE STANDARD	44
7.2 TEST PROCEDURE	44
7.3 DEVIATION FROM STANDARD	44
7.4 TEST SETUP	44
7.5 EUT OPERATION CONDITIONS	44
7.6 TEST RESULTS	44
8 . DUTY CYCLE OF TEST SIGNAL	51
8.1 STANDARD REQUIREMENT	51
8.2 FORMULA:	51
9 . ANTENNA REQUIREMENT	53
9.1 STANDARD REQUIREMENT	53
9.2 EUT ANTENNA	53
10 . EUT TEST PHOTO	54
11 . EUT PHOTO	56



1. SUMMARY OF TEST RESULTS

Test procedures according to the technical standards:

FCC Part15 (15.247) , Subpart C			
Standard Section	Test Item	Judgment	Remark
15.207	Conducted Emission	PASS	
15.247 (a)(2)	6dB Bandwidth	PASS	
15.247 (b)	Peak Output Power	PASS	
15.247 (d)	Radiated Spurious Emission	PASS	
15.247 (e)	Power Spectral Density	PASS	
15.205	Restricted Band of Operation	PASS	
15.247 (d)	Band Edge (Out of Band Emissions)	PASS	
15.203	Antenna Requirement	PASS	

NOTE:

(1) "N/A" denotes test is not applicable in this Test Report



1.1 TEST FACILITY

Shenzhen BCTC Testing Co., Ltd.
 Add. : BCTC Building & 1-2F, East of B Building, Pengzhou Industrial, Fuyuan 1st Road,
 Qiaotou Community, Fuyong Street, Bao'an District, Shenzhen, China
 FCC Test Firm Registration Number: 712850
 IC Registered No.: 23583

1.2 MEASUREMENT UNCERTAINTY

The reported uncertainty of measurement $y \pm U$, where expanded uncertainty U is based on a standard uncertainty multiplied by a coverage factor of $k=2$, providing a level of confidence of approximately **95 %**.

No.	Item	Uncertainty
1	3m chamber Radiated spurious emission(30MHz-1GHz)	U=4.3dB
2	3m chamber Radiated spurious emission(1GHz-18GHz)	U=4.5dB
3	3m chamber Radiated spurious emission(18GHz-40GHz)	U=3.34dB
4	Conducted Adjacent channel power	U=1.38dB
5	Conducted output power uncertainty Above 1G	U=1.576dB
6	Conducted output power uncertainty below 1G	U=1.28dB
7	humidity uncertainty	U=5.3%
8	Temperature uncertainty	U=0.59 °C



2. GENERAL INFORMATION

2.1 GENERAL DESCRIPTION OF EUT

Equipment	Digital Photo Frame	
Trade Name	N/A	
Model Name	Dream 01	
Model Difference	N/A	
Product Description	Operation Frequency:	802.11b/g/n20MHz:2412~2462 MHz
	Modulation Type:	WIFI: OFDM/DSSS
	Bit Rate of Transmitter	802.11b:11/5.5/2/1 Mbps 802.11g:54/48/36/24/18/12/9/6Mbps 802.11n Up to 75Mbps
	Number Of Channel	802.11b/g/n20MHz:11 CH
	Antenna Designation:	Please see Note 3.
Channel List	Please refer to the Note 2.	
Ratings	DC 5 V from adapter	
Connecting I/O Port(s)	Please refer to the User's Manual	

Note:

1. For a more detailed features description, please refer to the manufacturer's specifications or the User's Manual.



2.

Channel List for 802.11b/g/n(20)							
Channel	Frequency (MHz)	Channel	Frequency (MHz)	Channel	Frequency (MHz)	Channel	Frequency (MHz)
01	2412	04	2427	07	2442	10	2457
02	2417	05	2432	08	2447	11	2462
03	2422	06	2437	09	2452		

2.

Table for Internal antenna

Ant.	Brand	Model Name	Antenna Type	Gain (dBi)	NOTE
1	N/A	Butterfly	Internal antenna	2	

2.2 DESCRIPTION OF TEST MODES

Pretest Mode	Description
Mode 1	802.11b CH1/ CH6/ CH11
Mode 2	802.11g CH1/ CH6/ CH11
Mode 3	802.11n20 CH1/ CH6/ CH11
Mode 4	Link Mode

Conducted Emission	
Final Test Mode	Description
Mode 4	Link Mode

For Radiated Emission	
Final Test Mode	Description
Mode 1	802.11b CH1/ CH6/ CH11
Mode 2	802.11g CH1/ CH6/ CH11
Mode 3	802.11n20 CH1/ CH6/ CH11

Note:

(1) The measurements are performed at all Bit Rate of Transmitter, the worst data was reported.

2.3 BLOCK DIGRAM SHOWING THE CONFIGURATION OF SYSTEM TESTED

Conducted Emissions Test

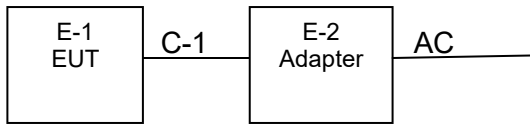

Spurious emissions Test

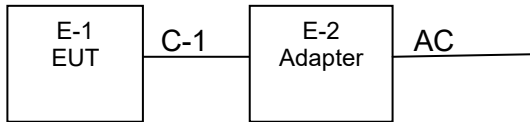

2.4 DESCRIPTION OF SUPPORT UNITS(CONDUCTED MODE)

The EUT has been tested as an independent unit together with other necessary accessories or support units. The following support units or accessories were used to form a representative test configuration during the tests.

No.	Device Type	Brand	Model	Series No.	Data Cable
E-1	Digital Photo Frame	N/A □	Dream 01	N/A	EUT
E-2	Adapter	N/A	JML-050020 0-LW	N/A	Auxiliary

Item	Shielded Type	Ferrite Core	Length	Note
C-1	NO	NO	0.5M	DC cable unshielded

Note:

- (1) The support equipment was authorized by Declaration of Confirmation.
- (2) For detachable type I/O cable should be specified the length in cm in 『Length』 column.



2.5 EQUIPMENTS LIST FOR ALL TEST ITEMS

Radiation Test equipment

Item	Equipment	Manufacturer	Type No.	Serial No.	Last calibration	Calibrated until
1	Spectrum Analyzer (9kHz-26.5GHz)	Agilent	E4407B	MY45109572	Jun. 08, 2020	Jun. 07, 2021
2	Test Receiver (9kHz-7GHz)	R&S	ESR7	101154	Jun. 08, 2020	Jun. 07, 2021
3	Bilog Antenna (30MHz-3GHz)	SCHWARZBECK	VULB9163	VULB9163-942	Jun. 08, 2020	Jun. 07, 2021
4	Horn Antenna (1GHz-18GHz)	SCHWARZBECK	BBHA9120D	1541	Jun. 10, 2020	Jun. 09, 2021
5	Horn Antenna (18GHz-40GHz)	SCHWARZBECK	BBHA9170	822	Jun. 10, 2020	Jun. 09, 2021
6	Amplifier (9KHz-6GHz)	SCHWARZBECK	BBV9744	9744-0037	Jun. 04, 2020	Jun. 03, 2021
7	Amplifier (0.5GHz-18GHz)	SCHWARZBECK	BBV9718	9718-309	Jun. 04, 2020	Jun. 03, 2021
8	Amplifier (18GHz-40GHz)	MITEQ	TTA1840-35-HG	2034381	Jun. 08, 2020	Jun. 07, 2021
9	Loop Antenna (9KHz-30MHz)	SCHWARZBECK	FMZB1519B	014	Jun. 08, 2020	Jun. 07, 2021
10	RF cables1 (9kHz-30MHz)	Huber+Suhnar	9kHz-30MHz	B1702988-0008	Jun. 08, 2020	Jun. 07, 2021
11	RF cables2 (30MHz-1GHz)	Huber+Suhnar	30MHz-1GHz	1486150	Jun. 08, 2020	Jun. 07, 2021
12	RF cables3 (1GHz-40GHz)	Huber+Suhnar	1GHz-40GHz	1607106	Jun. 08, 2020	Jun. 07, 2021
13	Power Metter	Keysight	E4419B	\	Jun. 08, 2020	Jun. 07, 2021
14	Power Sensor (AV)	Keysight	E9 300A	\	Jun. 08, 2020	Jun. 07, 2021
15	Signal Analyzer 20kHz-26.5GHz	KEYSIGHT	N9020A	MY49100060	Jun. 04, 2020	Jun. 03, 2021
16	Spectrum Analyzer 9kHz-40GHz	Agilent	FSP40	100363	Jun. 04, 2020	Jun. 03, 2021
17	D.C. Power Supply	LongWei	TPR-6405D	\	\	\
18	Software	Frad	EZ-EMC	FA-03A2 RE	\	\



Conduction Test equipment

Item	Equipment	Manufacturer	Type No.	Serial No.	Last calibration	Calibrated until
1	Test Receiver	R&S	ESR3	102075	Jun. 08, 2020	Jun. 07, 2021
2	LISN	SCHWARZBEC K	NSLK8127	8127739	Jun. 08, 2020	Jun. 07, 2021
3	LISN	R&S	ENV216	101375	Jun. 04, 2020	Jun. 03, 2021
4	RF cables	Huber+Suhnar	9kHz-30MHz	B1702988-00 08	Jun. 08, 2020	Jun. 07, 2021
5	Software	Frad	EZ-EMC	EMC-CON 3A1	\	\

3. EMC EMISSION TEST

3.1 CONDUCTED EMISSION MEASUREMENT

3.1.1 POWER LINE CONDUCTED EMISSION Limits (Frequency Range 150KHz-30MHz)

FREQUENCY (MHz)	Limit (dBuV)		Standard
	Quasi-peak	Average	
0.15 -0.5	66 - 56 *	56 - 46 *	FCC
0.50 -5.0	56.00	46.00	FCC
5.0 -30.0	60.00	50.00	FCC

Note:

- (1) The tighter limit applies at the band edges.
- (2) The limit of " * " marked band means the limitation decreases linearly with the logarithm of the frequency in the range.

The following table is the setting of the receiver

Receiver Parameters	Setting
Attenuation	10 dB
Start Frequency	0.15 MHz
Stop Frequency	30 MHz
IF Bandwidth	9 kHz

3.1.2 TEST PROCEDURE

- a. The EUT was placed 0.8 meters from the horizontal ground plane with EUT being connected to the power mains through a line impedance stabilization network (LISN). All other support equipments powered from additional LISN(s). The LISN provide 50 Ohm/ 50uH of coupling impedance for the measuring instrument.
- b. Interconnecting cables that hang closer than 40 cm to the ground plane shall be folded back and forth in the center forming a bundle 30 to 40 cm long.
- c. I/O cables that are not connected to a peripheral shall be bundled in the center. The end of the cable may be terminated, if required, using the correct terminating impedance. The overall length shall not exceed 1 m.
- d. LISN at least 80 cm from nearest part of EUT chassis.
- e. For the actual test configuration, please refer to the related Item –EUT Test Photos.

3.1.3 DEVIATION FROM TEST STANDARD

No deviation

3.1.4 TEST SETUP

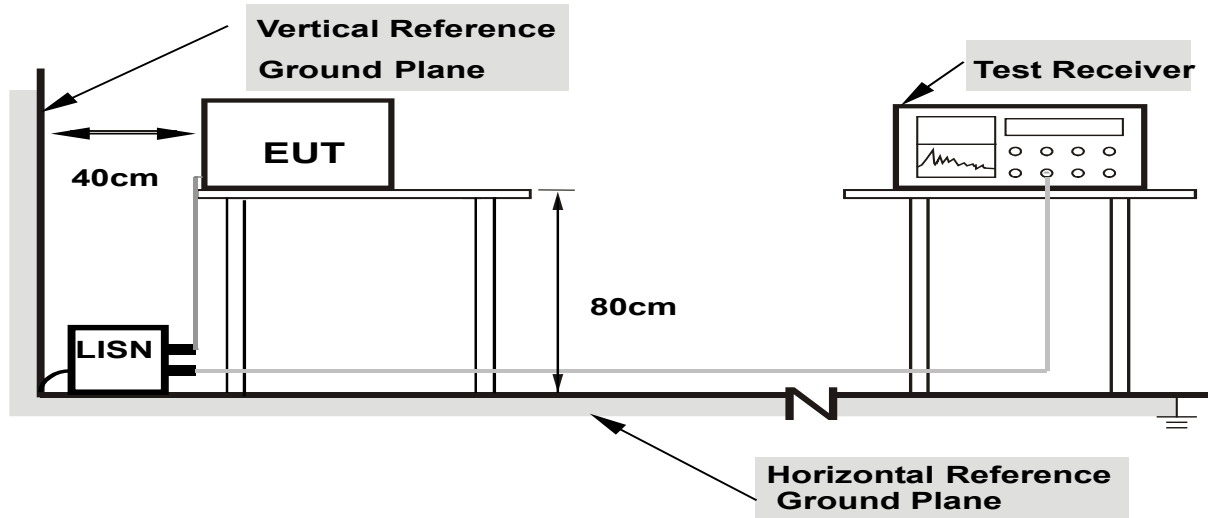

- Note: 1.Support units were connected to second LISN.**
2.Both of LISNs (AMN) are 80 cm from EUT and at least 80 from other units and other metal planes

3.1.5 EUT OPERATING CONDITIONS

The EUT was configured for testing in a typical fashion (as a customer would normally use it). The EUT has been programmed to continuously transmit during test. This operating condition was tested and used to collect the included data.

We pretest AC 120V and AC 240V, the worst voltage was AC 120V and the data recording in the report.



3.1.6 TEST RESULTS

This EUT is powered by the battery only, this test item is not applicable.

Temperature :	26 °C	Relative Humidity :	54%
Pressure :	101kPa	Phase :	L
Test Voltage :	AC 120V/60Hz	Test Mode :	Mode 4

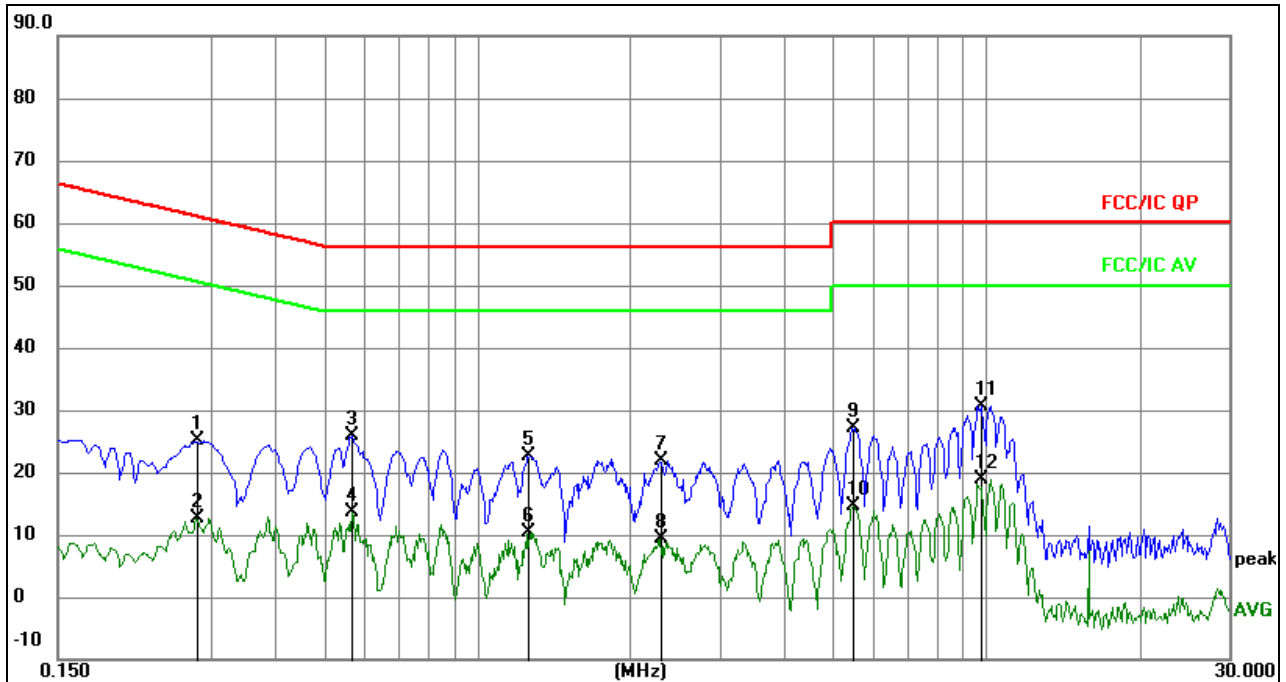

Remark:

1. All readings are Quasi-Peak and Average values.
2. Factor = Insertion Loss + Cable Loss.

No.	Mk.	Freq. MHz	Reading Level	Correct Factor dB	Measure- ment dBuV	Limit dBuV	Over dB	Detector
1		0.2803	15.55	9.56	25.11	60.81	-35.70	QP
2		0.2803	3.02	9.56	12.58	50.81	-38.23	AVG
3		0.5670	15.93	9.86	25.79	56.00	-30.21	QP
4		0.5670	3.79	9.86	13.65	46.00	-32.35	AVG
5		1.2555	13.02	9.58	22.60	56.00	-33.40	QP
6		1.2555	0.82	9.58	10.40	46.00	-35.60	AVG
7		2.2847	12.20	9.61	21.81	56.00	-34.19	QP
8		2.2847	-0.20	9.61	9.41	46.00	-36.59	AVG
9		5.4763	17.32	9.78	27.10	60.00	-32.90	QP
10		5.4763	4.85	9.78	14.63	50.00	-35.37	AVG
11	*	9.7567	20.99	9.69	30.68	60.00	-29.32	QP
12		9.7567	9.14	9.69	18.83	50.00	-31.17	AVG



Temperature :	26 °C	Relative Humidity :	54%
Pressure :	101kPa	Phase :	N
Test Voltage :	AC 120V/60Hz	Test Mode :	Mode 4

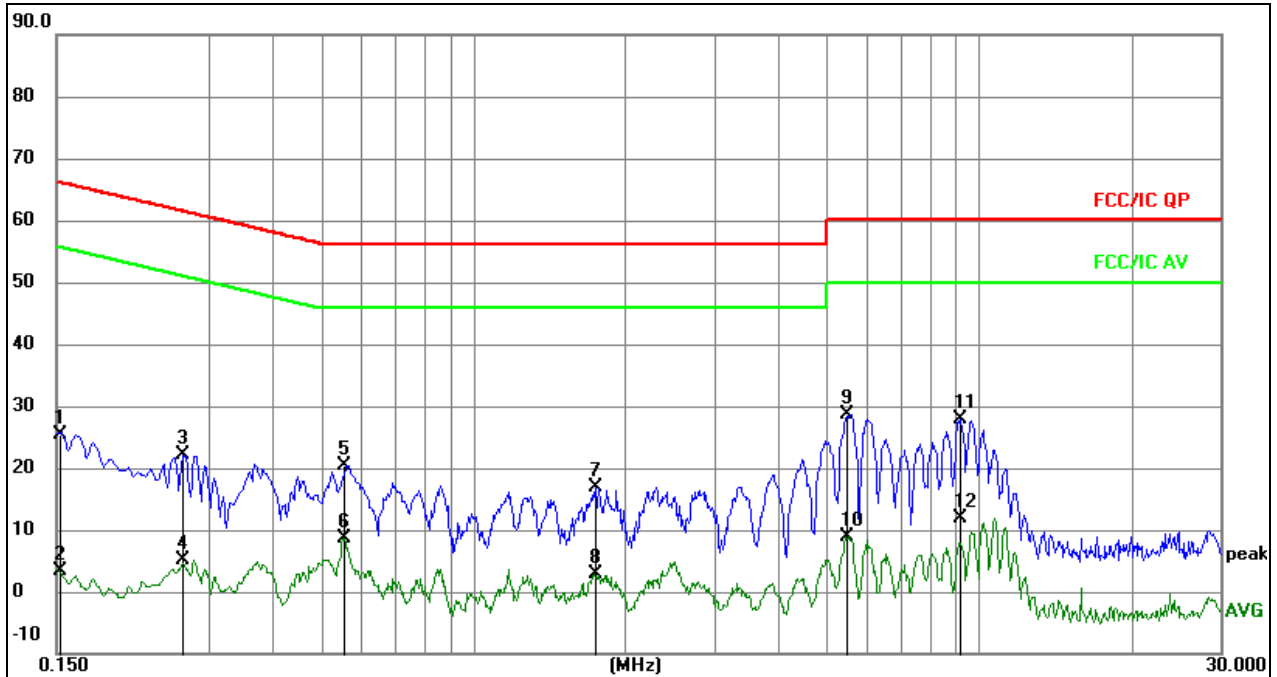

Remark:

1. All readings are Quasi-Peak and Average values.
2. Factor = Insertion Loss + Cable Loss.

No.	Mk.	Freq. MHz	Reading Level	Correct Factor dB	Measure- ment dBuV	Limit dBuV	Over dB	Detector
1		0.1516	15.92	9.52	25.44	65.91	-40.47	QP
2		0.1516	-6.11	9.52	3.41	55.91	-52.50	AVG
3		0.2670	12.59	9.54	22.13	61.21	-39.08	QP
4		0.2670	-4.48	9.54	5.06	51.21	-46.15	AVG
5		0.5550	10.55	9.82	20.37	56.00	-35.63	QP
6		0.5550	-1.27	9.82	8.55	46.00	-37.45	AVG
7		1.7430	7.33	9.58	16.91	56.00	-39.09	QP
8		1.7430	-6.75	9.58	2.83	46.00	-43.17	AVG
9	*	5.4645	18.89	9.78	28.67	60.00	-31.33	QP
10		5.4645	-0.81	9.78	8.97	50.00	-41.03	AVG
11		9.1635	18.20	9.70	27.90	60.00	-32.10	QP
12		9.1635	2.07	9.70	11.77	50.00	-38.23	AVG



3.2 RADIATED EMISSION MEASUREMENT

3.2.1 RADIATED EMISSION LIMITS (Frequency Range 9kHz-1000MHz)

20dBc in any 100 kHz bandwidth outside the operating frequency band. In case the emission fall within the restricted band specified on 15.205(a), then the 15.209(a) limit in the table below has to be followed.

Frequencies (MHz)	Field Strength (micorvolts/meter)	Measurement Distance (meters)
0.009~0.490	2400/F(KHz)	300
0.490~1.705	24000/F(KHz)	30
1.705~30.0	30	30
30~88	100	3
88~216	150	3
216~960	200	3
Above 960	500	3

LIMITS OF RADIATED EMISSION MEASUREMENT (Above 1000MHz)

FREQUENCY (MHz)	Limit (dBuV/m) (at 3M)	
	PEAK	AVERAGE
Above 1000	74	54

Notes:

- (1) The limit for radiated test was performed according to FCC PART 15C.
- (2) The tighter limit applies at the band edges.
- (3) Emission level (dBuV/m)=20log Emission level (uV/m).

Spectrum Parameter	Setting
Attenuation	Auto
Start Frequency	1000 MHz
Stop Frequency	25GHz
RB / VB (emission in restricted band)	1 MHz / 1 MHz for Peak, 1 MHz / 10Hz for Average

Receiver Parameter	Setting
Attenuation	Auto
Start ~ Stop Frequency	9kHz~150kHz / RB 200Hz for QP
Start ~ Stop Frequency	150kHz~30MHz / RB 9kHz for QP
Start ~ Stop Frequency	30MHz~1000MHz / RB 120kHz for QP

3.2.2 TEST PROCEDURE

Below 1GHz test procedure as below:

- a. The EUT was placed on the top of a rotating table 0.8 meters above the ground at a 3 meter semi-anechoic chamber. The table was rotated 360 degrees to determine the position of the highest radiation.
- b. The EUT was set 3 meters away from the interference-receiving antenna, which was mounted on the top of a variable-height antenna tower.
- c. The antenna height is varied from one meter to four meters above the ground to determine the maximum value of the field strength. Both horizontal and vertical polarizations of the antenna are set to make the measurement.
- d. For each suspected emission, the EUT was arranged to its worst case and then the antenna was tuned to heights from 1 meter to 4 meters (for the test frequency of below 30MHz, the antenna was tuned to heights 1 meter) and the rotatable table was turned from 0 degrees to 360 degrees to find the maximum reading.
- e. The test-receiver system was set to Peak Detect Function and Specified Bandwidth with Maximum Hold Mode.
- f. If the emission level of the EUT in peak mode was 10dB lower than the limit specified, then testing could be stopped and the peak values of the EUT would be reported. Otherwise the emissions that did not have 10dB margin would be re-tested one by one using peak, quasi-peak or average method as specified and then reported in a data sheet.

Above 1GHz test procedure as below:

- g. Different between above is the test site, change from Semi- Anechoic Chamber to fully Anechoic Chamber and change form table 0.8 metre to 1.5 metre(Above 18GHz the distance is 1 meter and table is 1.5 metre).
- h. Test the EUT in the lowest channel ,the middle channel ,the Highest channel

Note:

Both horizontal and vertical antenna polarities were tested and performed pretest to three orthogonal axis. The worst case emissions were reported

3.2.3 DEVIATION FROM TEST STANDARD

No deviation

3.2.4 TEST SETUP

(A) Radiated Emission Test-Up Frequency Below 30MHz

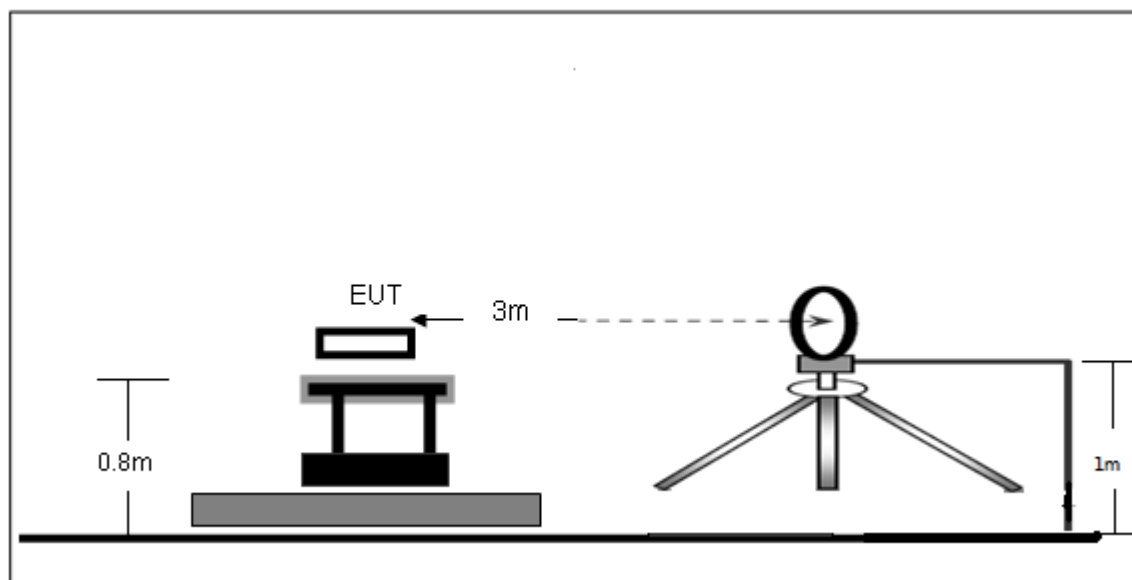

(B) Radiated Emission Test-Up Frequency 30MHz~1GHz

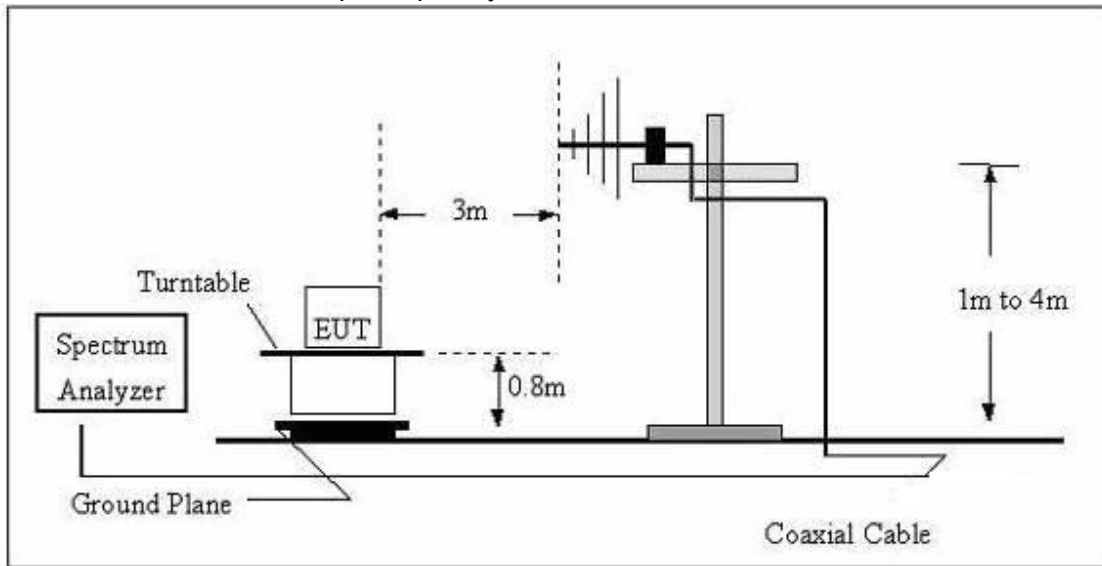

(C) Radiated Emission Test-Up Frequency Above 1GHz

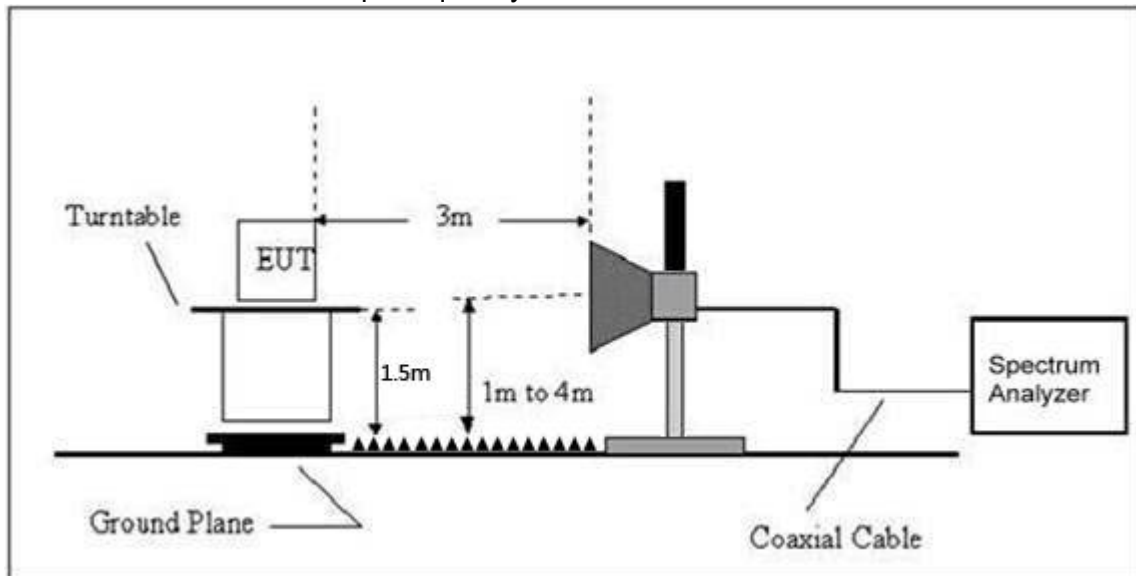

3.2.5 EUT OPERATING CONDITIONS

The EUT tested system was configured as the statements of 2.4 Unless otherwise a special operating condition is specified in the follows during the testing.



3.2.6 TEST RESULTS (BETWEEN 9KHZ – 30 MHZ)

Temperature:	26°C	Relative Humidity:	54%
Pressure:	101kPa	Test Voltage :	AC120V/60Hz
Test Mode :	Mode 4	Polarization :	--

Freq.	Reading	Limit	Margin	State
(MHz)	(dBuV/m)	(dBuV/m)	(dB)	P/F
--	--	--	--	PASS
--	--	--	--	PASS

NOTE:

The amplitude of spurious emissions which are attenuated by more than 20dB below the permissible value has no need to be reported.

Distance extrapolation factor = $40 \log(\text{specific distance}/\text{test distance})(\text{dB})$;

Limit line = specific limits(dBuv) + distance extrapolation factor.



3.2.7 TEST RESULTS (BETWEEN 30MHZ – 1GHZ)

Temperature :	26°C	Relative Humidity :	54%
Pressure :	101 kPa	Polarization :	Horizontal
Test Voltage :	AC120V/60Hz	Test Mode :	Mode 4

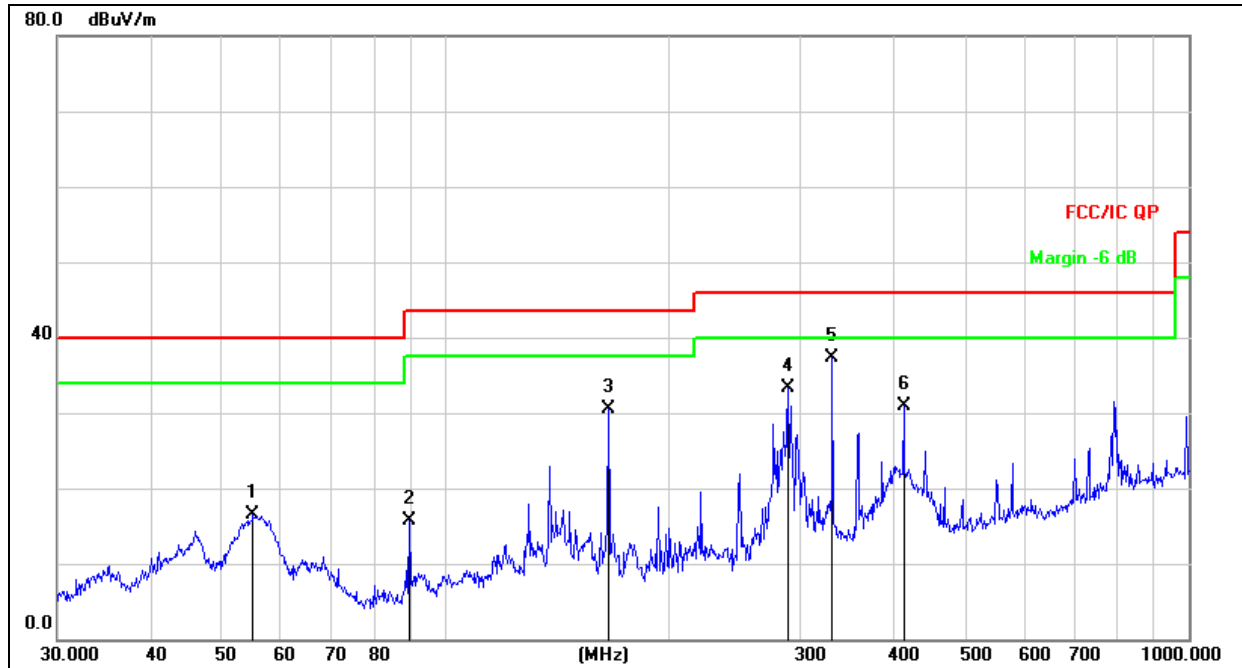

Remark:
Factor = Antenna Factor + Cable Loss – Pre-amplifier.

No.	Mk.	Freq. MHz	Reading Level dBuV	Correct Factor dB	Measure- ment dBuV/m	Limit dB/m	Over dB	Detector
1		55.0274	31.81	-15.38	16.43	40.00	-23.57	QP
2		89.2764	33.91	-18.27	15.64	43.50	-27.86	QP
3		165.4866	48.99	-18.51	30.48	43.50	-13.02	QP
4		289.0021	47.16	-13.94	33.22	46.00	-12.78	QP
5	*	331.3546	50.08	-12.74	37.34	46.00	-8.66	QP
6		413.2706	41.61	-10.79	30.82	46.00	-15.18	QP



Temperature :	26°C	Relative Humidity :	54%
Pressure :	101kPa	Polarization :	Vertical
Test Voltage :	AC120V/60Hz	Test Mode :	Mode 4

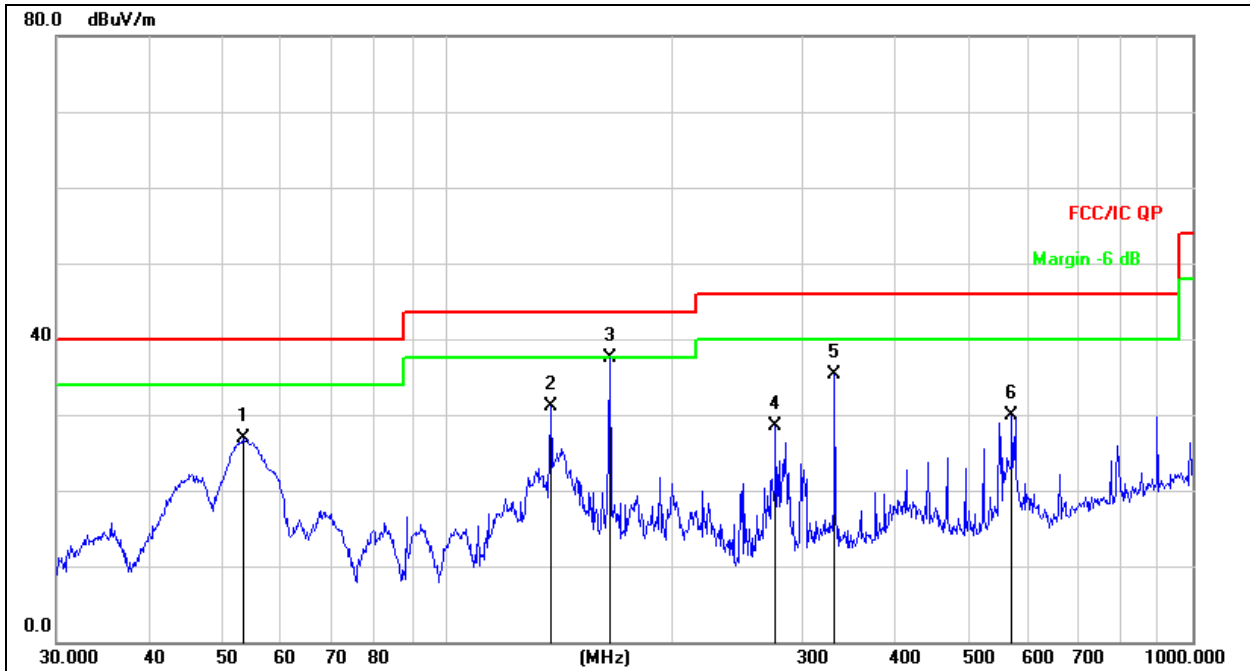

Remark:
Factor = Antenna Factor + Cable Loss – Pre-amplifier.

No.	Mk.	Freq. MHz	Reading Level dBuV	Correct Factor dB	Measure- ment dBuV/m	Limit dB/m	Over dB	Detector
1		53.5052	42.21	-15.22	26.99	40.00	-13.01	QP
2		137.9028	49.76	-18.72	31.04	43.50	-12.46	QP
3	*	165.4866	55.93	-18.51	37.42	43.50	-6.08	QP
4		276.1235	42.79	-14.34	28.45	46.00	-17.55	QP
5		331.3546	48.00	-12.74	35.26	46.00	-10.74	QP
6		572.6144	37.06	-7.16	29.90	46.00	-16.10	QP



3.2.8 TEST RESULTS (1GHZ~25GHZ)

802.11b

Polar (H/V)	Frequency	Meter Reading	Pre-amplifier	Cable Loss	Antenna Factor	Emission Level	Limits	Margin	Detector Type
	(MHz)	(dBuV)	(dB)	(dB)	(dB)	(dBuV/m)	(dBuV/m)	(dB)	
Low Channel:2412MHz									
V	4824.00	66.52	39.55	7.85	25.66	60.48	74.00	-13.52	PK
V	4824.00	52.28	39.55	7.85	25.66	46.24	54.00	-7.76	AV
V	7236.00	66.61	38.33	7.52	24.55	60.35	74.00	-13.65	PK
V	7236.00	50.36	38.33	7.52	24.55	44.10	54.00	-9.90	AV
H	4824.00	66.06	39.55	7.85	25.66	60.02	74.00	-13.98	PK
H	4824.00	47.50	39.55	7.85	25.66	41.46	54.00	-12.54	AV
H	7236.00	65.11	38.33	7.52	24.55	58.85	74.00	-15.15	PK
H	7236.00	49.07	38.33	7.52	24.55	42.81	54.00	-11.19	AV

Polar (H/V)	Frequency	Meter Reading	Pre-amplifier	Cable Loss	Antenna Factor	Emission Level	Limits	Margin	Detector Type
	(MHz)	(dBuV)	(dB)	(dB)	(dB)	(dBuV/m)	(dBuV/m)	(dB)	
Middle Channel:2437MHz									
V	4874.00	67.78	38.89	7.57	25.45	61.91	74.00	-12.09	Pk
V	4874.00	51.00	38.89	7.57	25.45	45.13	54.00	-8.87	AV
V	7311.00	67.35	38.78	7.35	24.54	60.46	74.00	-13.54	Pk
V	7311.00	50.57	38.78	7.35	24.54	43.68	54.00	-10.32	AV
H	4874.00	67.49	38.89	7.57	25.45	61.62	74.00	-12.38	Pk
H	4874.00	48.24	38.89	7.57	25.45	42.37	54.00	-11.63	AV
H	7311.00	67.49	38.78	7.35	24.54	60.60	74.00	-13.40	Pk
H	7311.00	46.76	38.78	7.35	24.54	39.87	54.00	-14.13	AV

Polar (H/V)	Frequency	Meter Reading	Pre-amplifier	Cable Loss	Antenna Factor	Emission Level	Limits	Margin	Detector Type
	(MHz)	(dBuV)	(dB)	(dB)	(dB)	(dBuV/m)	(dBuV/m)	(dB)	
High Channel: 2462MHz									
V	4924.00	69.20	38.75	7.46	25.41	63.32	74.00	-10.68	PK
V	4924.00	49.93	38.75	7.46	25.41	44.05	54.00	-9.95	AV
V	7386.00	69.23	38.65	7.22	24.52	62.32	74.00	-11.68	PK
V	7386.00	48.59	38.65	7.22	24.52	41.68	54.00	-12.32	AV
H	4924.00	67.28	38.75	7.46	25.41	61.40	74.00	-12.60	PK
H	4924.00	46.84	38.75	7.46	25.41	40.96	54.00	-13.04	AV
H	7386.00	69.12	38.65	7.22	24.52	62.21	74.00	-11.79	PK
H	7386.00	46.77	38.65	7.22	24.52	39.86	54.00	-14.14	AV

Remark:

1. Emission Level = Meter Reading + Antenna Factor + Cable Loss – Pre-amplifier,

Margin= Emission Level - Limit

2. If peak below the average limit, the average emission was no test.

3. The amplitude of spurious emissions which are attenuated by more than 20dB below the permissible value has no need to be reported.



802.11g

Polar (H/V)	Frequency	Meter Reading	Pre-amplifier	Cable Loss	Antenna Factor	Emission Level	Limits	Margin	Detector Type
	(MHz)	(dBuV)	(dB)	(dB)	(dB)	(dBuV/m)	(dBuV/m)	(dB)	
Low Channel:2412MHz									
V	4824.00	65.35	39.55	7.85	25.66	59.31	74.00	-14.69	PK
V	4824.00	50.98	39.55	7.85	25.66	44.94	54.00	-9.06	AV
V	7236.00	66.04	38.33	7.52	24.55	59.78	74.00	-14.22	PK
V	7236.00	48.53	38.33	7.52	24.55	42.27	54.00	-11.73	AV
H	4824.00	63.88	39.55	7.85	25.66	57.84	74.00	-16.16	PK
H	4824.00	46.94	39.55	7.85	25.66	40.90	54.00	-13.10	AV
H	7236.00	65.91	38.33	7.52	24.55	59.65	74.00	-14.35	PK
H	7236.00	46.27	38.33	7.52	24.55	40.01	54.00	-13.99	AV

Polar (H/V)	Frequency	Meter Reading	Pre-amplifier	Cable Loss	Antenna Factor	Emission Level	Limits	Margin	Detector Type
	(MHz)	(dBuV)	(dB)	(dB)	(dB)	(dBuV/m)	(dBuV/m)	(dB)	
Middle Channel:2437MHz									
V	4874.00	64.72	38.89	7.57	25.45	58.85	74.00	-15.15	PK
V	4874.00	50.89	38.89	7.57	25.45	45.02	54.00	-8.98	AV
V	7311.00	66.03	38.78	7.35	24.54	59.14	74.00	-14.86	PK
V	7311.00	49.35	38.78	7.35	24.54	42.46	54.00	-11.54	AV
H	4874.00	62.83	38.89	7.57	25.45	56.96	74.00	-17.04	PK
H	4874.00	46.36	38.89	7.57	25.45	40.49	54.00	-13.51	AV
H	7311.00	64.93	38.78	7.35	24.54	58.04	74.00	-15.96	PK
H	7311.00	45.41	38.78	7.35	24.54	38.52	54.00	-15.48	AV

Polar (H/V)	Frequency	Meter Reading	Pre-amplifier	Cable Loss	Antenna Factor	Emission Level	Limits	Margin	Detector Type
	(MHz)	(dBuV)	(dB)	(dB)	(dB)	(dBuV/m)	(dBuV/m)	(dB)	
High Channel: 2462MHz									
V	4924.00	64.53	38.75	7.46	25.41	58.65	74.00	-15.35	PK
V	4924.00	50.81	38.75	7.46	25.41	44.93	54.00	-9.07	AV
V	7386.00	63.26	38.65	7.22	24.52	56.35	74.00	-17.65	PK
V	7386.00	48.78	38.65	7.22	24.52	41.87	54.00	-12.13	AV
H	4924.00	64.47	38.75	7.46	25.41	58.59	74.00	-15.41	PK
H	4924.00	48.29	38.75	7.46	25.41	42.41	54.00	-11.59	AV
H	7386.00	64.77	38.65	7.22	24.52	57.86	74.00	-16.14	PK
H	7386.00	47.50	38.65	7.22	24.52	40.59	54.00	-13.41	AV

Remark:

1. Emission Level = Meter Reading + Antenna Factor + Cable Loss – Pre-amplifier,

Margin= Emission Level - Limit

2. If peak below the average limit, the average emission was no test.

3. The amplitude of spurious emissions which are attenuated by more than 20dB below the permissible value has no need to be reported.



802.11n(20MHz)

Polar (H/V)	Frequency	Meter Reading	Pre-amplifier	Cable Loss	Antenna Factor	Emission Level	Limits	Margin	Detector Type
	(MHz)	(dBuV)	(dB)	(dB)	(dB)	(dBuV/m)	(dBuV/m)	(dB)	
Low Channel:2412MHz									
V	4824.00	63.16	39.55	7.85	25.66	57.12	74.00	-16.88	PK
V	4824.00	49.02	39.55	7.85	25.66	42.98	54.00	-11.02	AV
V	7236.00	62.83	38.33	7.52	24.55	56.57	74.00	-17.43	PK
V	7236.00	46.16	38.33	7.52	24.55	39.90	54.00	-14.10	AV
H	4824.00	63.16	39.55	7.85	25.66	57.12	74.00	-16.88	PK
H	4824.00	45.90	39.55	7.85	25.66	39.86	54.00	-14.14	AV
H	7236.00	63.08	38.33	7.52	24.55	56.82	74.00	-17.18	PK
H	7236.00	43.43	38.33	7.52	24.55	37.17	54.00	-16.83	AV

Polar (H/V)	Frequency	Meter Reading	Pre-amplifier	Cable Loss	Antenna Factor	Emission Level	Limits	Margin	Detector Type
	(MHz)	(dBuV)	(dB)	(dB)	(dB)	(dBuV/m)	(dBuV/m)	(dB)	
Middle Channel:2437MHz									
V	4874.00	63.80	38.89	7.57	25.45	57.93	74.00	-16.07	PK
V	4874.00	50.08	38.89	7.57	25.45	44.21	54.00	-9.79	AV
V	7311.00	62.70	38.78	7.35	24.54	55.81	74.00	-18.19	PK
V	7311.00	48.37	38.78	7.35	24.54	41.48	54.00	-12.52	AV
H	4874.00	64.68	38.89	7.57	25.45	58.81	74.00	-15.19	PK
H	4874.00	47.32	38.89	7.57	25.45	41.45	54.00	-12.55	AV
H	7311.00	62.10	38.78	7.35	24.54	55.21	74.00	-18.79	PK
H	7311.00	46.39	38.78	7.35	24.54	39.50	54.00	-14.50	AV

Polar (H/V)	Frequency	Meter Reading	Pre-amplifier	Cable Loss	Antenna Factor	Emission Level	Limits	Margin	Detector Type
	(MHz)	(dBuV)	(dB)	(dB)	(dB)	(dBuV/m)	(dBuV/m)	(dB)	
High Channel: 2462MHz									
V	4924.00	63.90	38.75	7.46	25.41	58.02	74.00	-15.98	PK
V	4924.00	49.51	38.75	7.46	25.41	43.63	54.00	-10.37	AV
V	7386.00	63.03	38.65	7.22	24.52	56.12	74.00	-17.88	PK
V	7386.00	48.30	38.65	7.22	24.52	41.39	54.00	-12.61	AV
H	4924.00	64.01	38.75	7.46	25.41	58.13	74.00	-15.87	PK
H	4924.00	46.96	38.75	7.46	25.41	41.08	54.00	-12.92	AV
H	7386.00	62.58	38.65	7.22	24.52	55.67	74.00	-18.33	PK
H	7386.00	43.55	38.65	7.22	24.52	36.64	54.00	-17.36	AV

Remark:

1. Emission Level = Meter Reading + Antenna Factor + Cable Loss – Pre-amplifier,

Margin= Emission Level - Limit

2. If peak below the average limit, the average emission was no test.

3. The amplitude of spurious emissions which are attenuated by more than 20dB below the permissible value has no need to be reported.



3.3 RADIATED BAND EMISSION MEASUREMENT

3.3.1 TEST REQUIREMENT:

FCC Part15 C Section 15.209 and 15.205

LIMITS OF RADIATED EMISSION MEASUREMENT (Above 1000MHz)

FREQUENCY (MHz)	Class B (dBuV/m) (at 3M)	
	PEAK	AVERAGE
Above 1000	74	54

Notes:

- (1) The limit for radiated test was performed according to FCC PART 15C.
- (2) The tighter limit applies at the band edges.
- (3) Emission level (dBuV/m)=20log Emission level (uV/m).

Spectrum Parameter	Setting
Attenuation	Auto
Start Frequency	2300MHz
Stop Frequency	2520
RB / VB (emission in restricted band)	1 MHz / 1 MHz for Peak, 1 MHz / 10Hz for Average

3.3.2 TEST PROCEDURE

Above 1GHz test procedure as below:

- a. 1. The EUT was placed on the top of a rotating table 1.5 meters above the ground at a 3 meter camber. The table was rotated 360 degrees to determine the position of the highest radiation.
- b. The EUT was set 3 meters away from the interference-receiving antenna, which was mounted on the top of a variable-height antenna tower.
- c. The antenna height is varied from one meter to four meters above the ground to determine the maximum value of the field strength. Both horizontal and vertical polarizations of the antenna are set to make the measurement.
- d. For each suspected emission, the EUT was arranged to its worst case and then the antenna was tuned to heights from 1 meter to 4 meters and the rota table was turned from 0 degrees to 360 degrees to find the maximum reading.
- e. The test-receiver system was set to Peak Detect Function and Specified Bandwidth with Maximum Hold Mode.
- f. If the emission level of the EUT in peak mode was 10dB lower than the limit specified, then testing could be stopped and the peak values of the EUT would be reported. Otherwise the emissions that did not have 10dB margin would be re-tested one by one using peak, quasi-peak or average method as specified and then reported in a data sheet.
- g. Test the EUT in the lowest channel, the Highest channel

Note:

Both horizontal and vertical antenna polarities were tested and performed pretest to three orthogonal axis. The worst case emissions were reported

3.3.3 DEVIATION FROM TEST STANDARD

No deviation

3.3.4 TEST SETUP

Radiated Emission Test-Up Frequency Above 1GHz

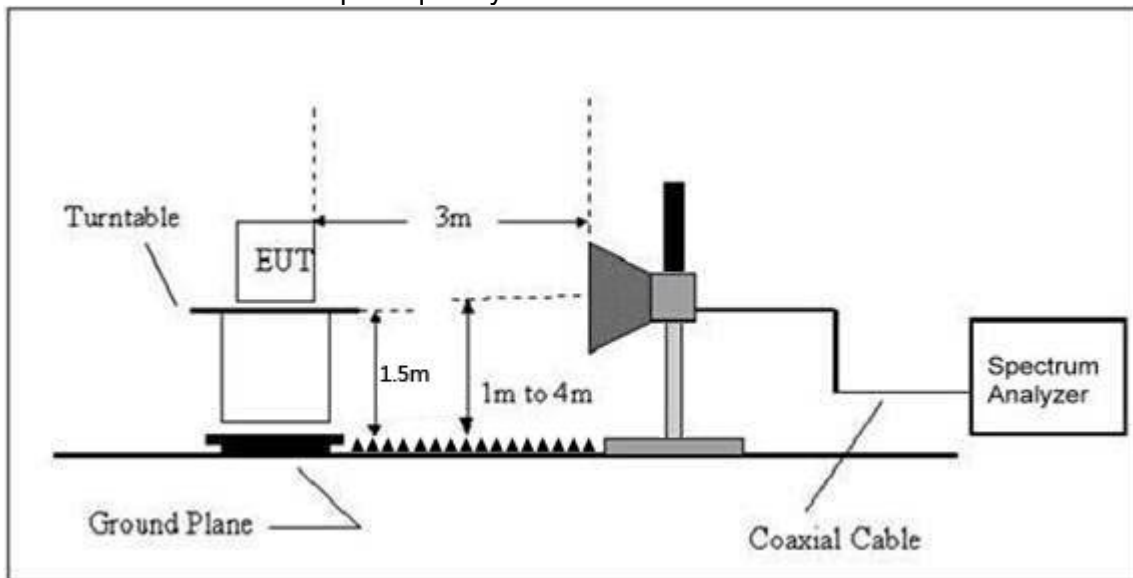

3.3.5 EUT OPERATING CONDITIONS

The EUT tested system was configured as the statements of 2.3 Unless otherwise a special operating condition is specified in the follows during the testing.



3.3.6 TEST RESULT

	Polar (H/V)	Frequency (MHz)	Meter Reading (dBuV)	Pre-amplifier (dB)	Cable Loss (dB)	Antenna Factor (dB/m)	Emission level (dBuV/m)	Limits (dBuV/m)		Result	
							PK	PK	AV		
802.11b	Low Channel 2412MHz										
	H	2390.00	60.48	38.06	7.42	20.15	49.99	74.00	54.00	PASS	
	H	2400.00	60.30	38.06	7.42	20.15	49.81	74.00	54.00	PASS	
	V	2390.00	61.37	38.06	7.42	20.15	50.88	74.00	54.00	PASS	
	V	2400.00	60.08	38.06	7.42	20.15	49.59	74.00	54.00	PASS	
	High Channel 2462MHz										
	H	2483.50	62.09	38.17	7.45	20.54	51.91	74.00	54.00	PASS	
	H	2485.50	58.19	38.17	7.45	20.54	48.01	74.00	54.00	PASS	
	V	2483.50	58.33	38.20	7.45	20.54	48.12	74.00	54.00	PASS	
	V	2485.50	61.43	38.20	7.45	20.54	51.22	74.00	54.00	PASS	
	802.11g	Low Channel 2412MHz									
		H	2390.00	59.30	38.06	7.42	20.15	48.81	74.00	54.00	PASS
H		2400.00	58.81	38.06	7.42	20.15	48.32	74.00	54.00	PASS	
V		2390.00	60.74	38.06	7.42	20.15	50.25	74.00	54.00	PASS	
V		2400.00	59.53	38.06	7.42	20.15	49.04	74.00	54.00	PASS	
High Channel 2462MHz											
H		2483.50	61.27	38.17	7.45	20.54	51.09	74.00	54.00	PASS	
H		2485.50	58.27	38.17	7.45	20.54	48.09	74.00	54.00	PASS	
V		2483.50	58.83	38.20	7.45	20.54	48.62	74.00	54.00	PASS	
V		2485.50	60.09	38.20	7.45	20.54	49.88	74.00	54.00	PASS	
802.11n20		Low Channel 2412MHz									
		H	2390.00	60.00	38.06	7.42	20.15	49.51	74.00	54.00	PASS
	H	2400.00	58.32	38.06	7.42	20.15	47.83	74.00	54.00	PASS	
	V	2390.00	60.58	38.06	7.42	20.15	50.09	74.00	54.00	PASS	
	V	2400.00	57.85	38.06	7.42	20.15	47.36	74.00	54.00	PASS	
	High Channel 2462MHz										
	H	2483.50	61.73	38.17	7.45	20.54	51.55	74.00	54.00	PASS	
	H	2485.50	56.79	38.17	7.45	20.54	46.61	74.00	54.00	PASS	
	V	2483.50	57.54	38.20	7.45	20.54	47.33	74.00	54.00	PASS	
	V	2485.50	61.03	38.20	7.45	20.54	50.82	74.00	54.00	PASS	

Remark:

1. Emission Level = Meter Reading + Antenna Factor + Cable Loss – Pre-amplifier, Margin= Emission Level - Limit
2. If the PK measured levels comply with average limit, then the average level were deemed to comply with average limit.

4. POWER SPECTRAL DENSITY TEST

4.1 APPLIED PROCEDURES / LIMIT

FCC Part15 (15.247) , Subpart C				
Section	Test Item	Limit	Frequency Range (MHz)	Result
15.247	Power Spectral Density	8 dBm (in any 3KHz)	2400-2483.5	PASS

4.1.1 TEST PROCEDURE

1. Set analyzer center frequency to DTS channel center frequency.
2. Set the span to 1.5 times the DTS bandwidth.
3. Set the RBW to: $3 \text{ kHz} \leq \text{RBW} \leq 100 \text{ kHz}$.
4. Set the VBW $\geq 3 \times \text{RBW}$.
5. Detector = peak.
6. Sweep time = auto couple.
7. Trace mode = max hold.
8. Allow trace to fully stabilize.
9. Use the peak marker function to determine the maximum amplitude level within the RBW.
10. If measured value exceeds limit, reduce RBW (no less than 3 kHz) and repeat.

4.1.2 DEVIATION FROM STANDARD

No deviation.

4.1.3 TEST SETUP

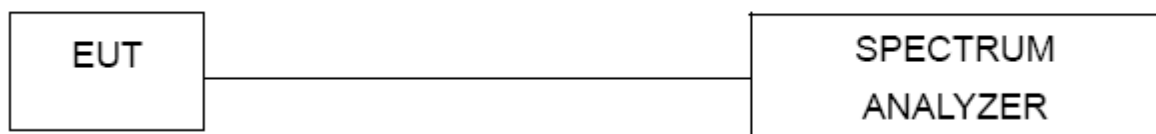

4.1.4 EUT OPERATION CONDITIONS

The EUT tested system was configured as the statements of 2.1 Unless otherwise a special operating condition is specified in the follows during the testing.

Note: Power Spectral Density(dBm)=Reading+Cable Loss

4.1.5 TEST RESULTS

Temperature :	26°C	Relative Humidity :	54%
Pressure :	101kPa	Test Voltage :	AC120V/60Hz
Test Mode :	TX b Mode		

Frequency	Power Spectral Density(dBm/3k Hz)	Limit (dBm/3kHz)	Result
2412 MHz	-14.775	8	PASS
2437 MHz	-14.191	8	PASS
2462 MHz	-13.842	8	PASS

TX CH01





TX CH06



TX CH11





Temperature :	26°C	Relative Humidity :	54%
Pressure :	101kPa	Test Voltage :	AC120V/60Hz
Test Mode :	TX g Mode		

Frequency	Power Spectral Density(dBm/3k Hz)	Limit (dBm/3kHz)	Result
2412 MHz	-19.535	8	PASS
2437 MHz	-18.787	8	PASS
2462 MHz	-18.755	8	PASS

TX CH01

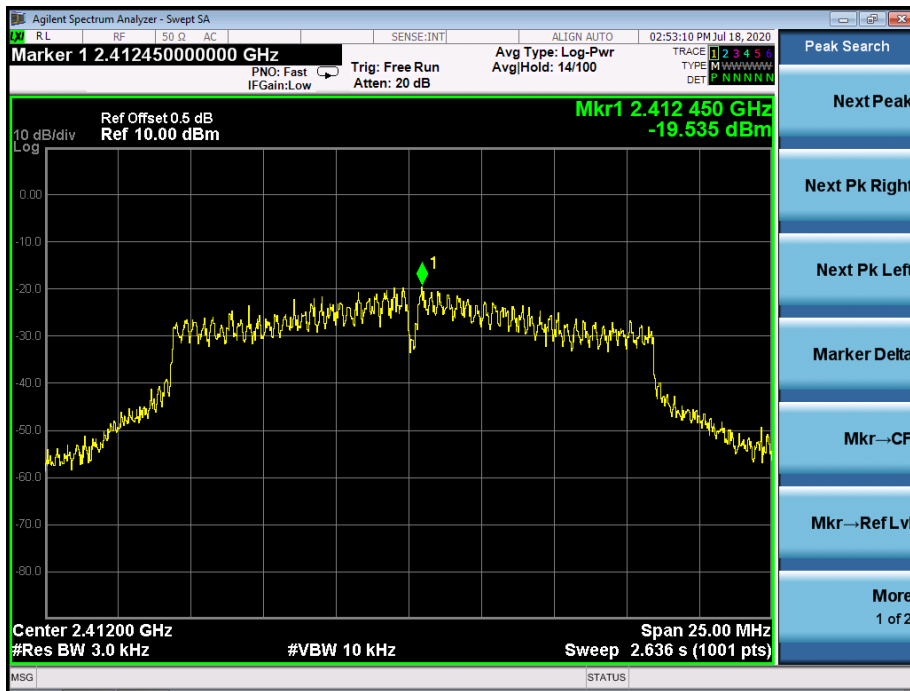



TX CH06

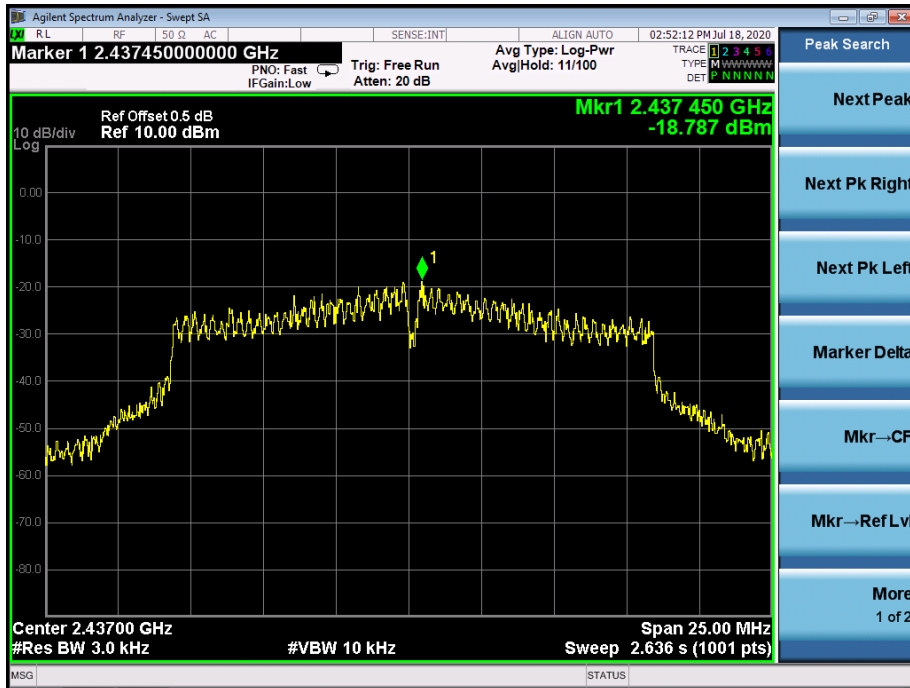

TX CH11

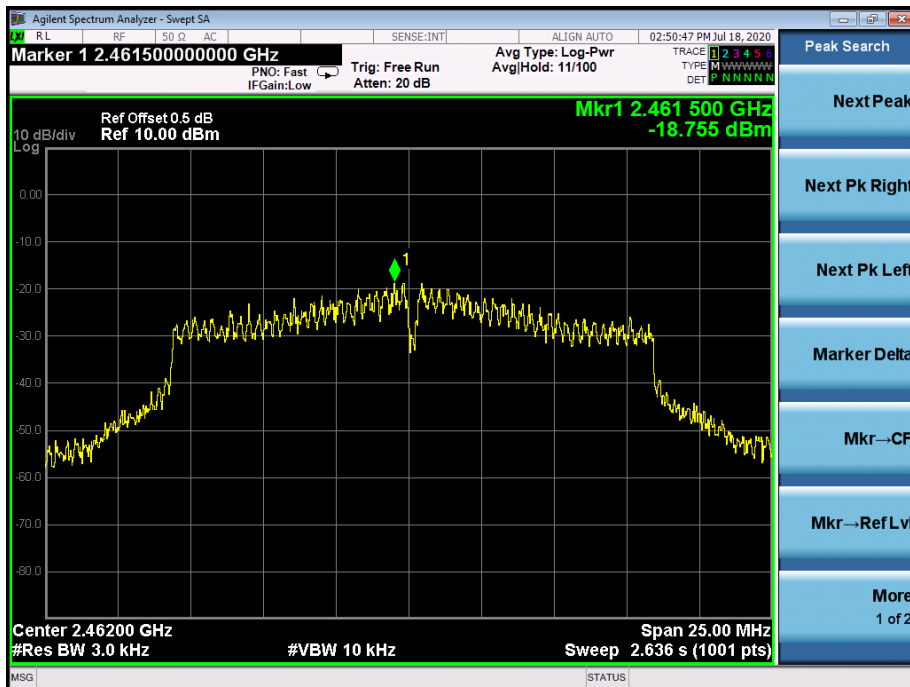



Temperature :	26°C	Relative Humidity :	54%
Pressure :	101kPa	Test Voltage :	AC120V/60Hz
Test Mode :	TX n Mode(20M)		

Frequency	Power Spectral Density(dBm/3k Hz)	Limit (dBm/3kHz)	Result
2412 MHz	-19.692	8	PASS
2437 MHz	-19.716	8	PASS
2462 MHz	-19.406	8	PASS

TX CH01

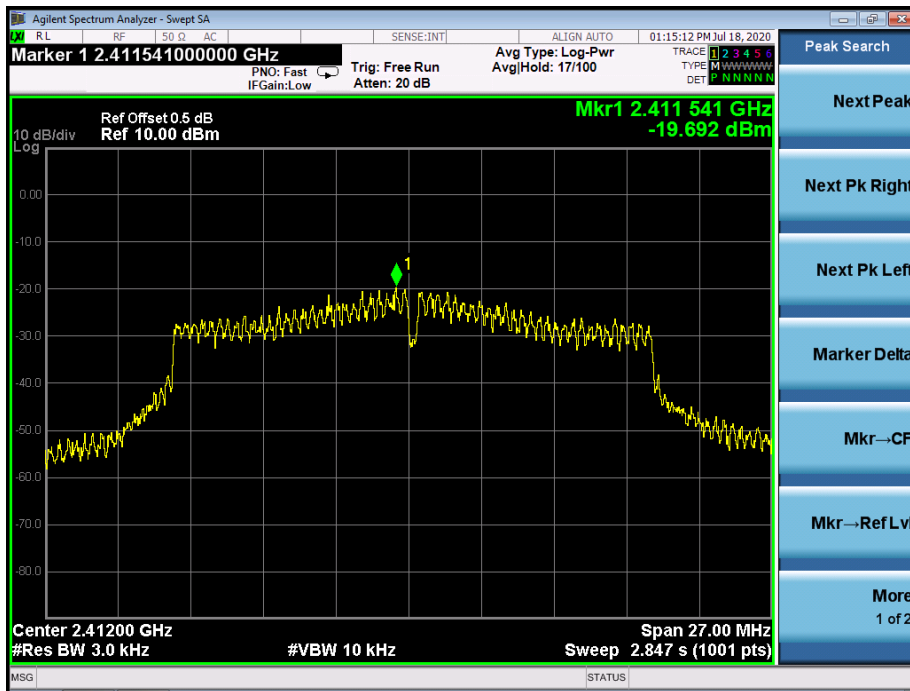



TX CH06

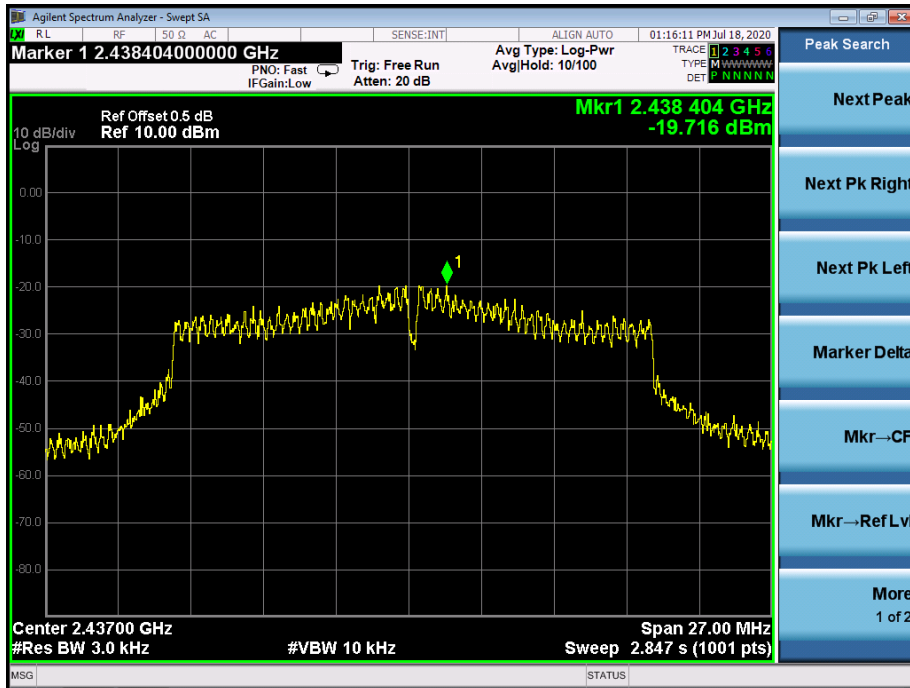

TX CH11

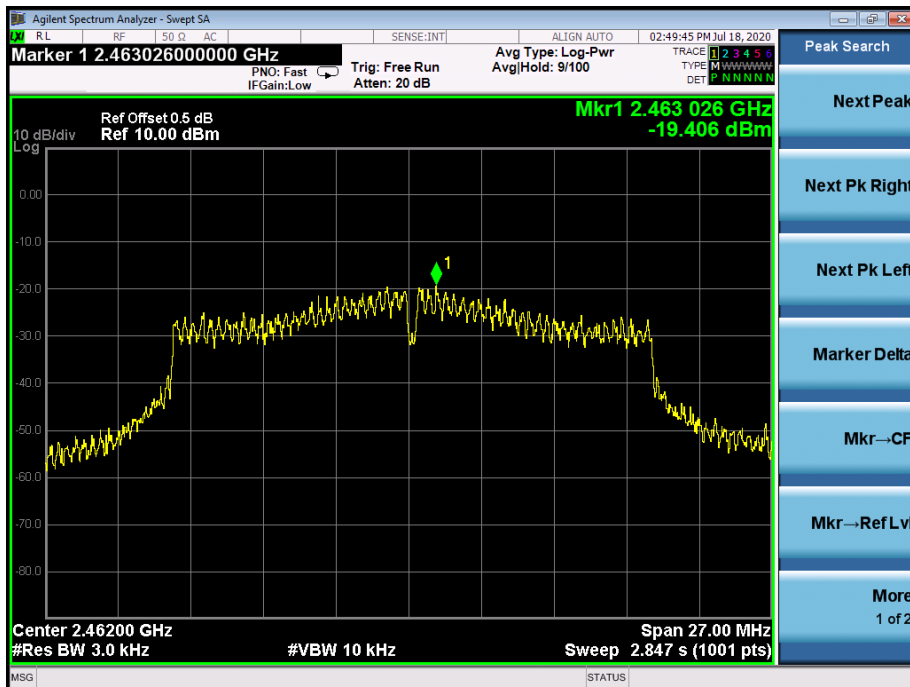

5. BANDWIDTH TEST

5.1 APPLIED PROCEDURES / LIMIT

FCC Part15 (15.247) , Subpart C				
Section	Test Item	Limit	Frequency Range (MHz)	Result
15.247(a)(2)	Bandwidth	$\geq 500\text{KHz}$ (6dB bandwidth)	2400-2483.5	PASS

5.1.1 TEST PROCEDURE

1. Set RBW = 100 kHz.
2. Set the video bandwidth (VBW) $\geq 3 \times$ RBW.
3. Detector = Peak.
4. Trace mode = max hold.
5. Sweep = auto couple.
6. Allow the trace to stabilize.
7. Measure the maximum width of the emission that is constrained by the frequencies associated with the two outermost amplitude points (upper and lower frequencies) that are attenuated by 6 dB relative to the maximum level measured in the fundamental emission.

5.1.2 DEVIATION FROM STANDARD

No deviation.

5.1.3 TEST SETUP

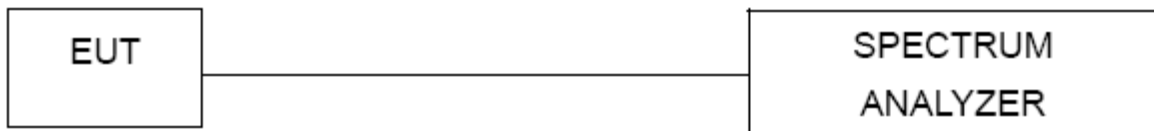

5.1.4 EUT OPERATION CONDITIONS

The EUT tested system was configured as the statements of 2.4 Unless otherwise a special operating condition is specified in the follows during the testing.

5.1.5 TEST RESULTS

Temperature :	26°C	Relative Humidity :	54%
Pressure :	101kPa	Test Voltage :	AC120V/60Hz
Test Mode :	TX b Mode		

Frequency (MHz)	6dB bandwidth (MHz)	Limit (kHz)	Result
2412	8.066	500	Pass
2437	8.058	500	Pass
2462	8.091	500	Pass

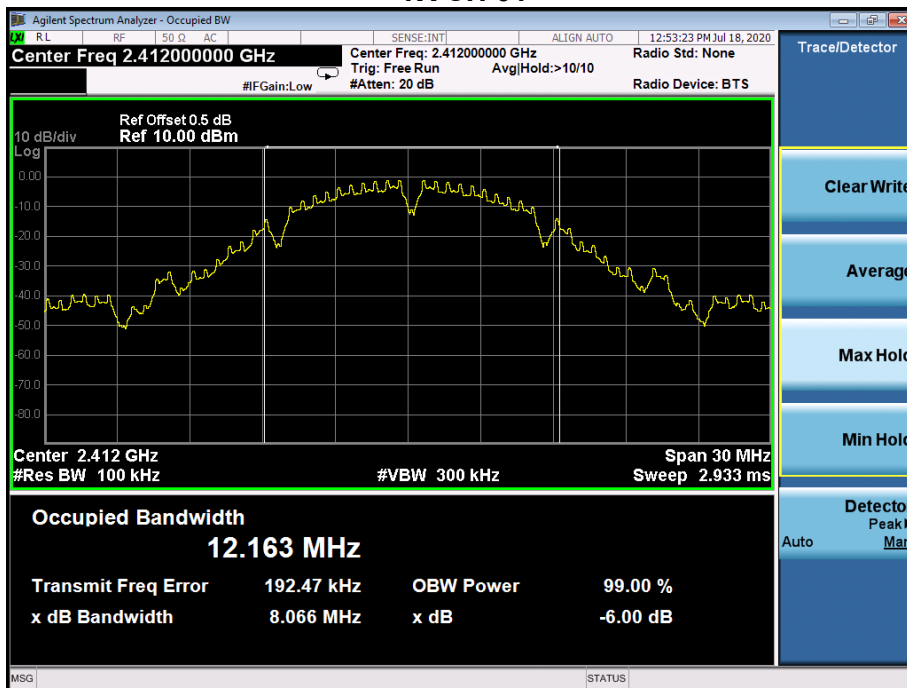
TX CH 01



TX CH 06

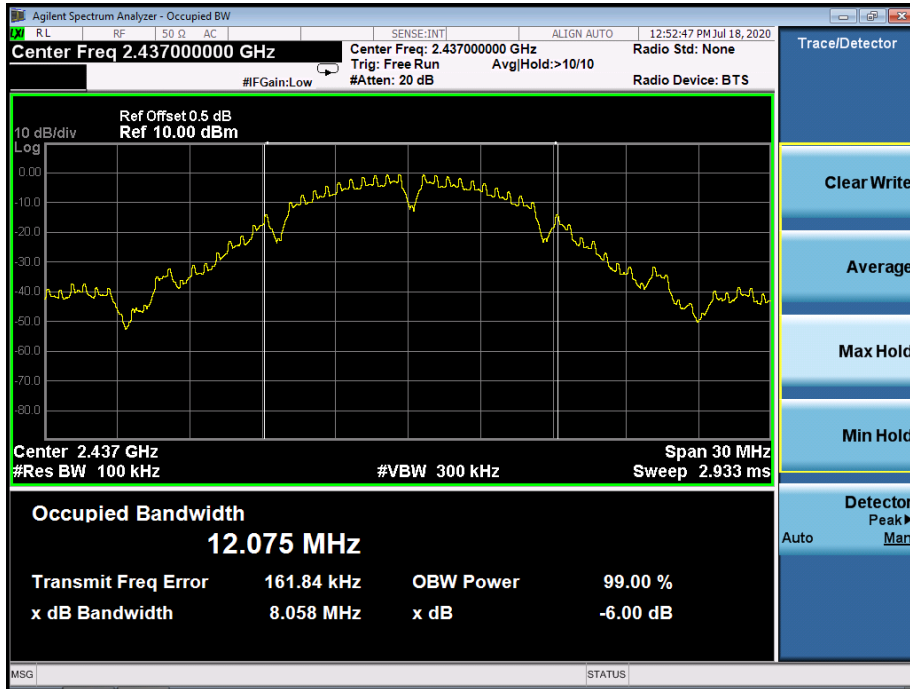

TX CH 11

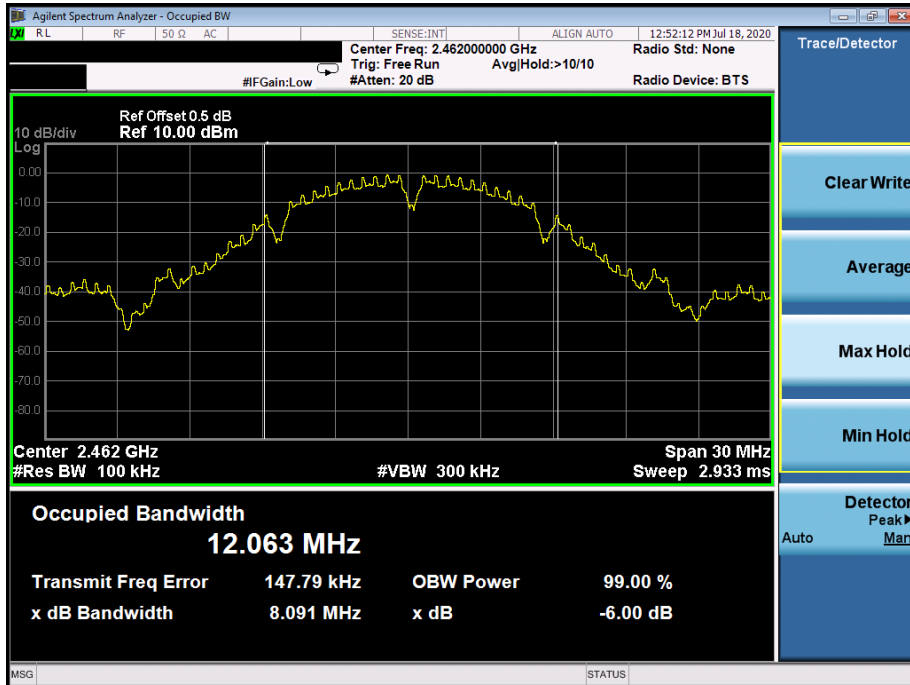



Temperature :	26°C	Relative Humidity :	54%
Pressure :	101kPa	Test Voltage :	AC120V/60Hz
Test Mode :	TX g Mode		

Frequency (MHz)	6dB bandwidth (MHz)	Limit (kHz)	Result
2412	15.21	500	Pass
2437	15.22	500	Pass
2462	15.21	500	Pass

TX CH 01

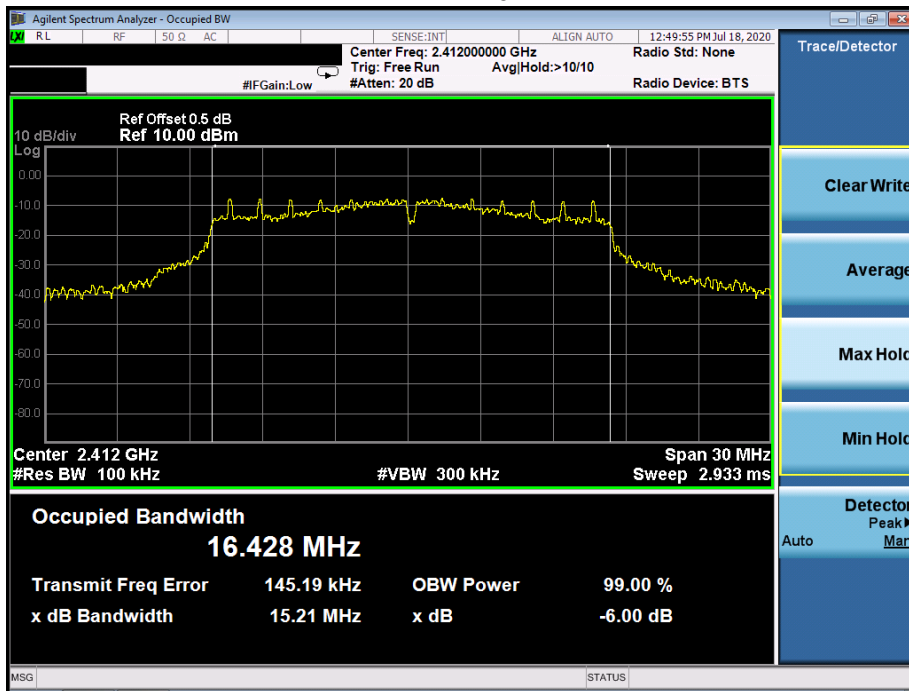



TX CH 06

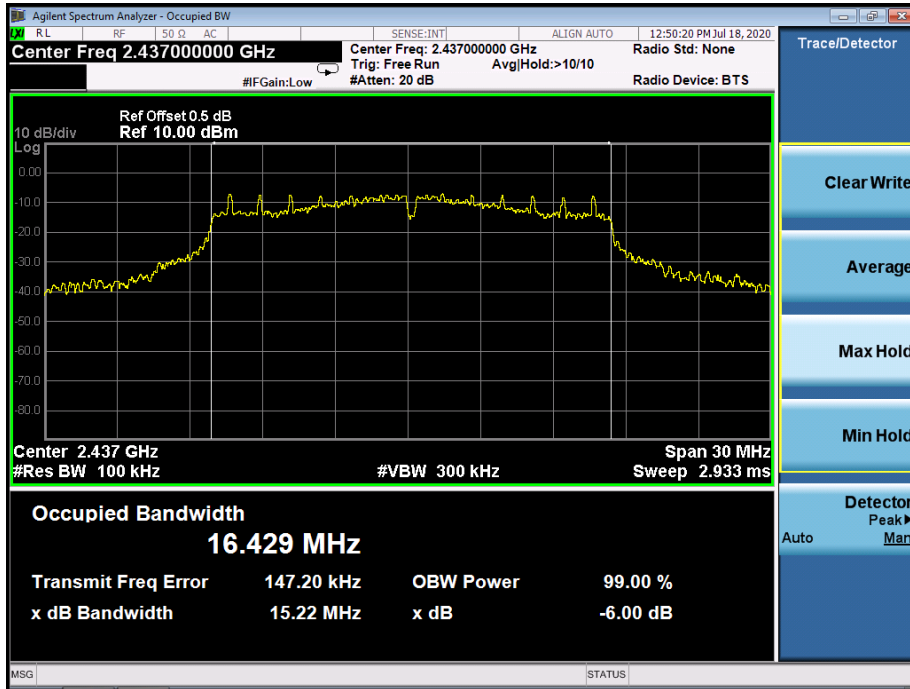

TX CH 11

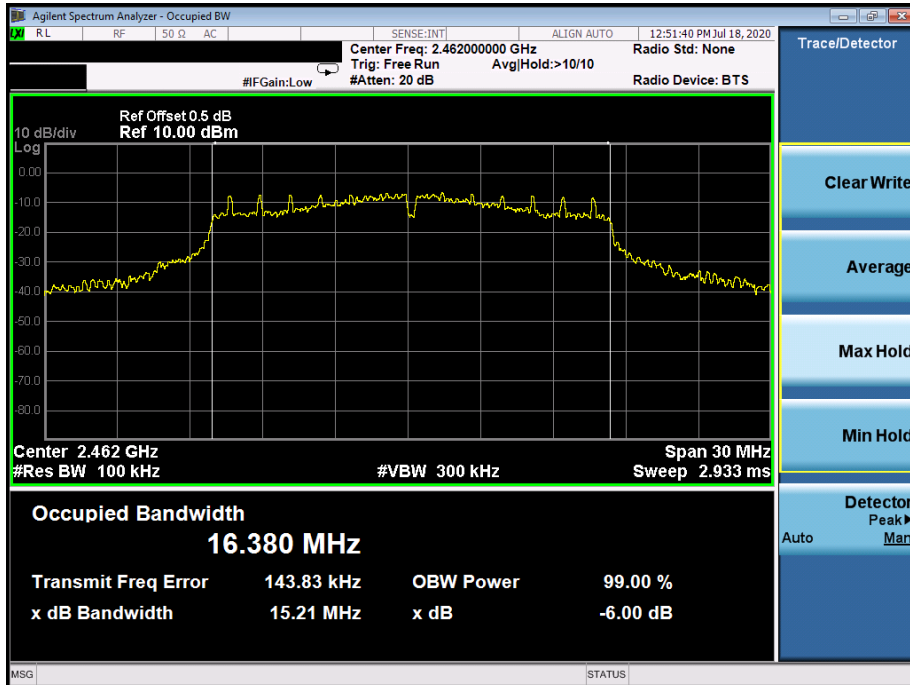



Temperature :	26°C	Relative Humidity :	54%
Pressure :	101kPa	Test Voltage :	AC120V/60Hz
Test Mode :	TX n Mode(20M)		

Frequency (MHz)	6dB bandwidth (MHz)	Limit (kHz)	Result
2412	15.22	500	Pass
2437	15.22	500	Pass
2462	15.21	500	Pass

TX CH 01

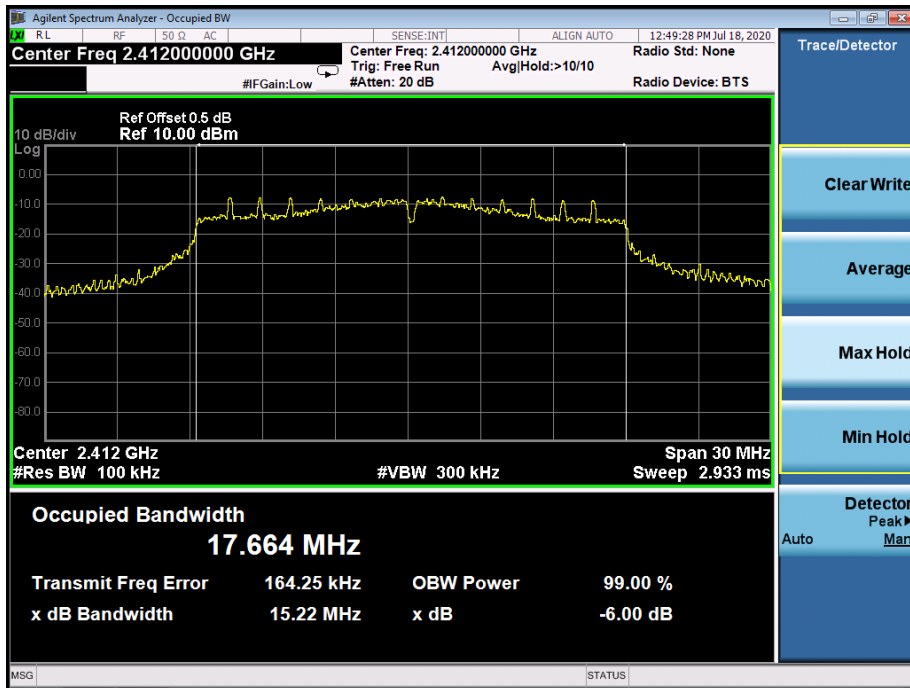



TX CH 06

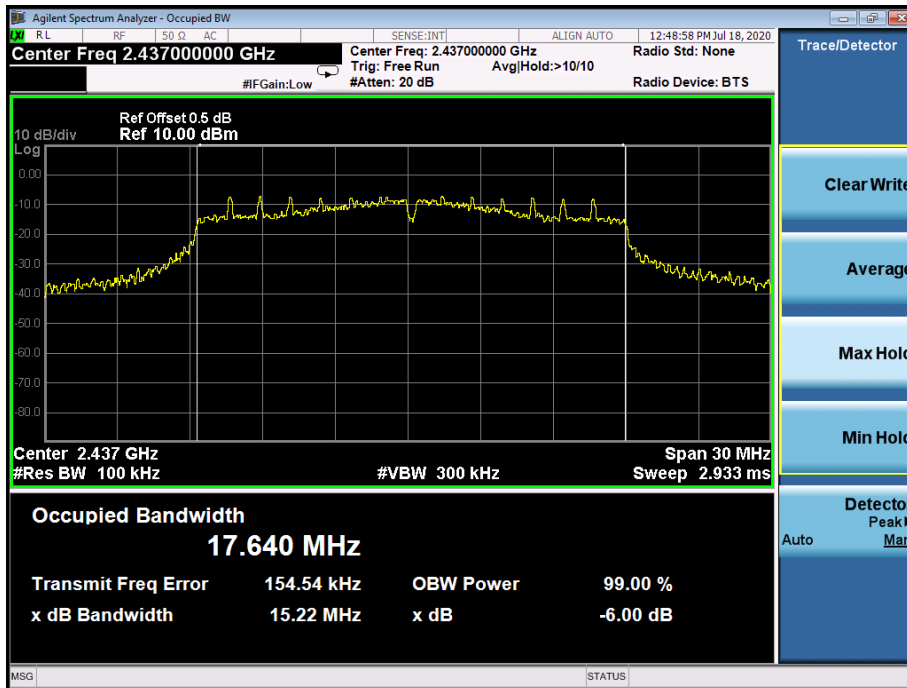

TX CH 11

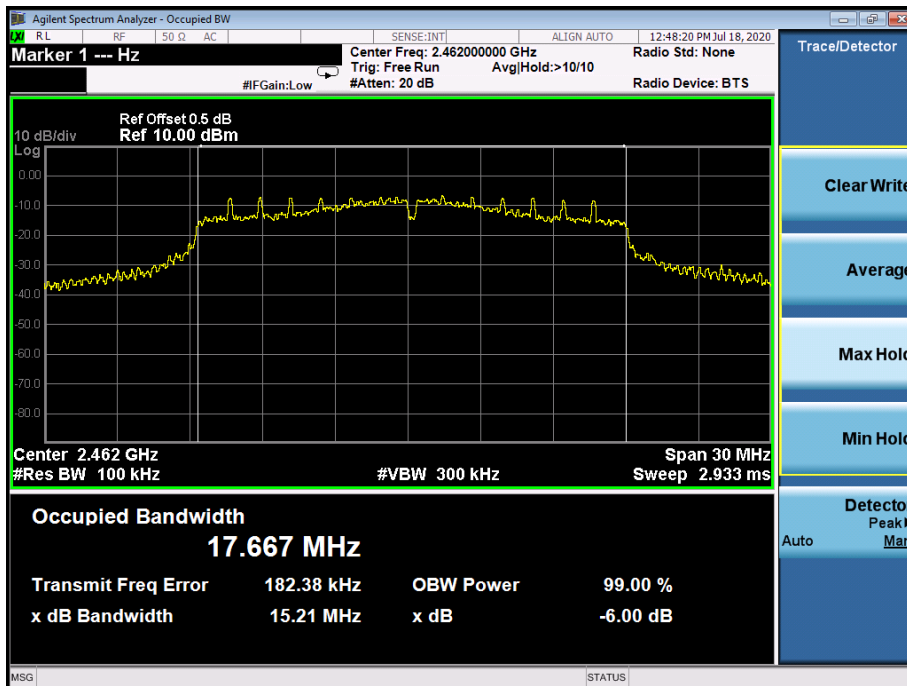



6. PEAK OUTPUT POWER TEST

6.1 APPLIED PROCEDURES/LIMIT

FCC Part15 (15.247) , Subpart C				
Section	Test Item	Limit	Frequency Range (MHz)	Result
15.247(b)(3)	Peak Output Power	1 watt or 30dBm	2400-2483.5	PASS

6.1.1 TEST PROCEDURE

- a. The EUT was directly connected to the Power meter

6.1.2 DEVIATION FROM STANDARD

No deviation.

6.1.3 TEST SETUP



6.1.4 EUT OPERATION CONDITIONS

The EUT tested system was configured as the statements of 2.4 Unless otherwise a special operating condition is specified in the follows during the testing.



6.1.5 TEST RESULTS

Temperature :	26°C	Relative Humidity :	54%
Pressure :	101kPa	Test Voltage :	AC120V/60Hz

	Frequency	Maximum Conducted Output Power(PK)	LIMIT
	(MHz)	(dBm)	dBm
802.11b	2412	9.24	30
	2437	9.10	30
	2462	9.23	30
802.11g	2412	7.18	30
	2437	7.60	30
	2462	7.85	30
802.11n20	2412	6.40	30
	2437	6.85	30
	2462	7.13	30

7. 100 KHZ BANDWIDTH OF FREQUENCY BAND EDGE

7.1 APPLICABLE STANDARD

in any 100 kHz bandwidth outside the frequency bands in which the spread spectrum intentional radiator is operating, the radio frequency power that is produced by the intentional radiator shall be at least 20dB below that in the 100kHz bandwidth within the band that contains the highest level of the desired power, In addition, radiated emissions which fall in the restricted bands, as defined in§15.205(a), must also comply with the radiated emission limits specified in15.209(a).

7.2 TEST PROCEDURE

Using the following spectrum analyzer setting:

- a) Set the RBW = 100KHz.
- b) Set the VBW = 300KHz.
- c) Sweep time = auto couple.
- d) Detector function = peak.
- e) Trace mode = max hold.
- f) Allow trace to fully stabilize.

7.3 DEVIATION FROM STANDARD

No deviation.

7.4 TEST SETUP

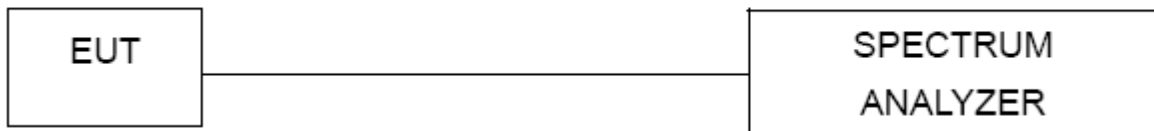

7.5 EUT OPERATION CONDITIONS

The EUT tested system was configured as the statements of 2.4 Unless otherwise a special operating condition is specified in the follows during the testing.

7.6 TEST RESULTS



802.11b: Band Edge, Left Side

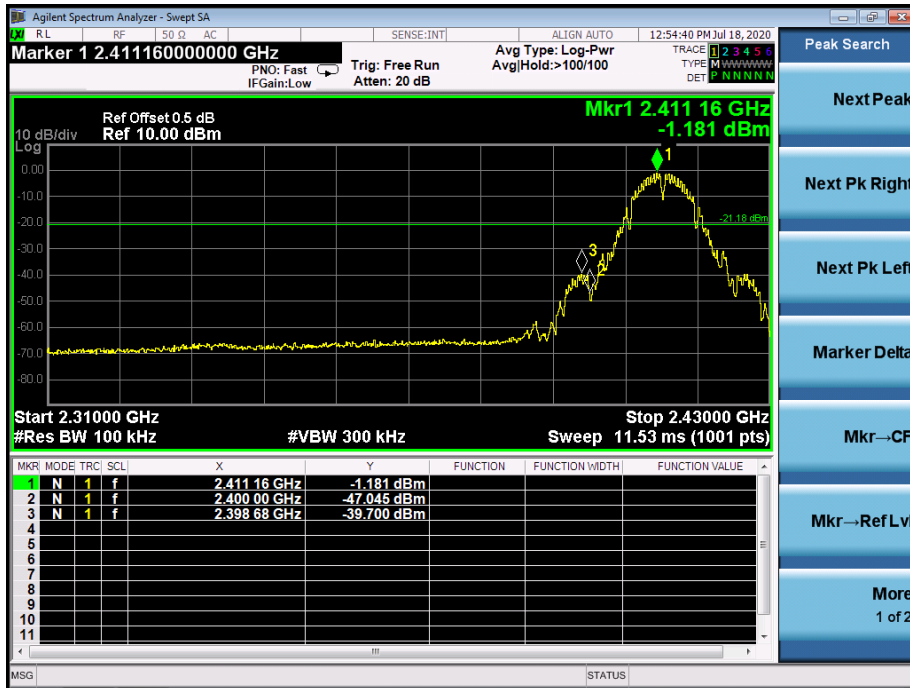

802.11b: Band Edge, Right Side





802.11g: Band Edge, Left Side



802.11g: Band Edge, Right Side





802.11n-HT20: Band Edge, Left Side



802.11n-HT20: Band Edge, Right Side





CONDUCTED EMISSION MEASUREMENT

802.11b

Low Channel 2412MHz

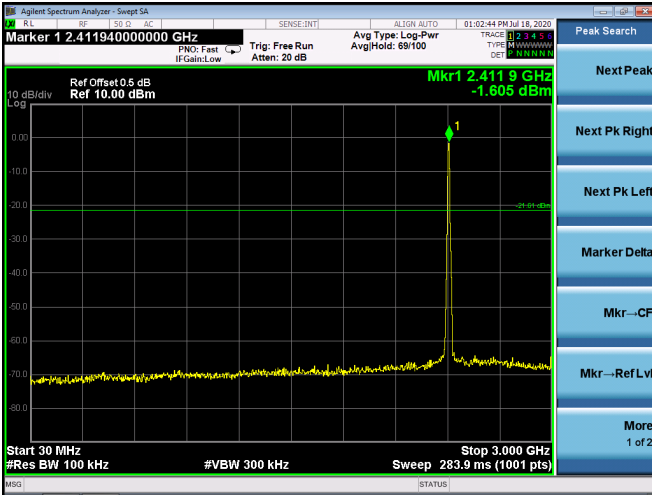

Middle Channel 2437MHz

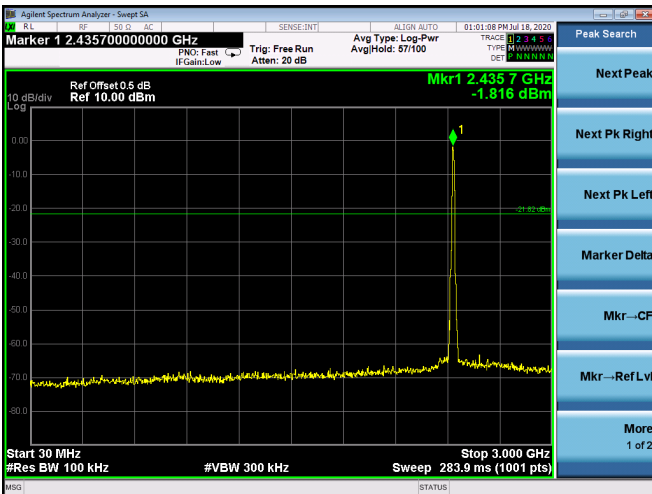

High Channel 2462MHz

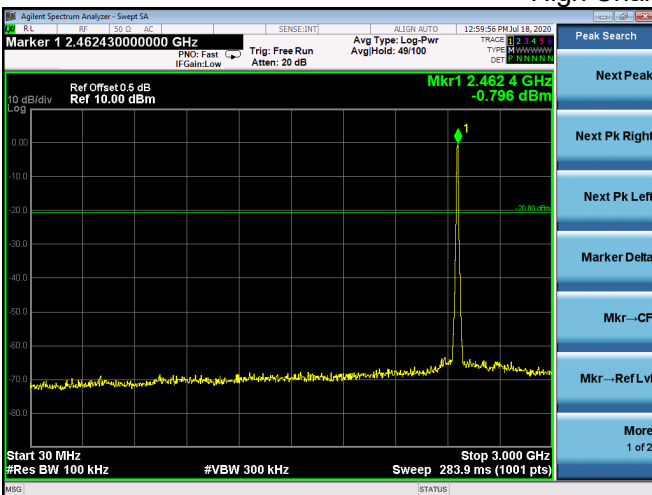

802.11g

Low Channel 2412MHz

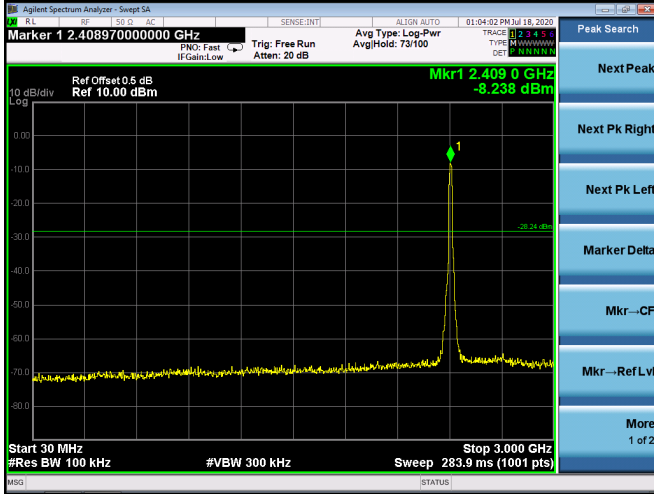

Middle Channel 2437MHz

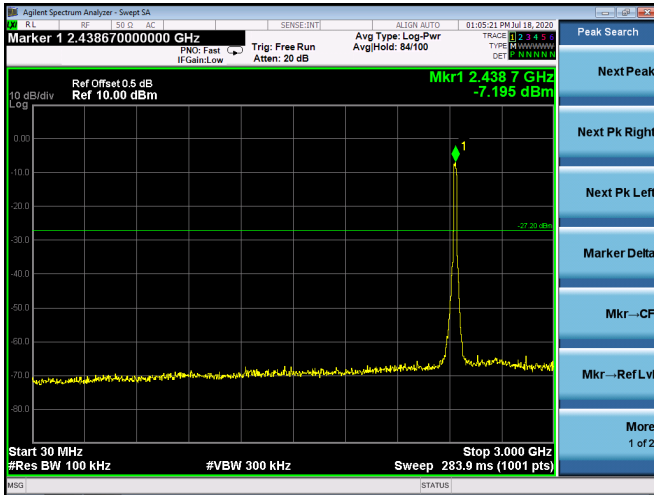

High Channel 2462MHz

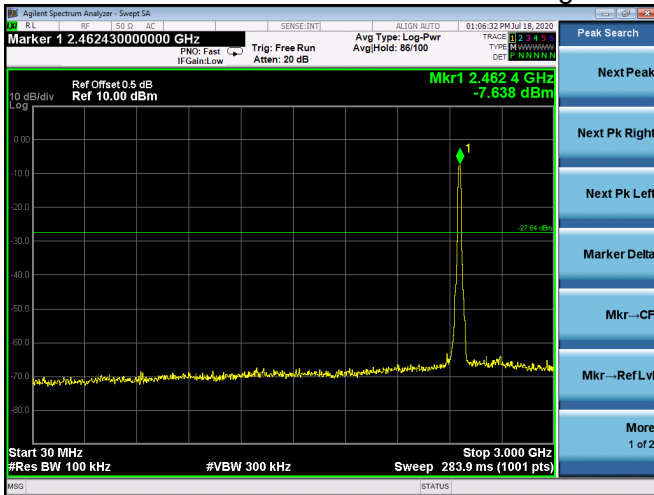

802.11n20

Low Channel 2412MHz

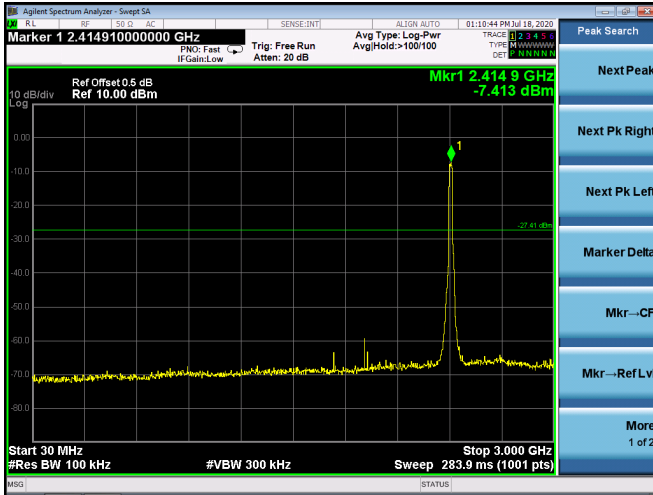

Middle Channel 2437MHz

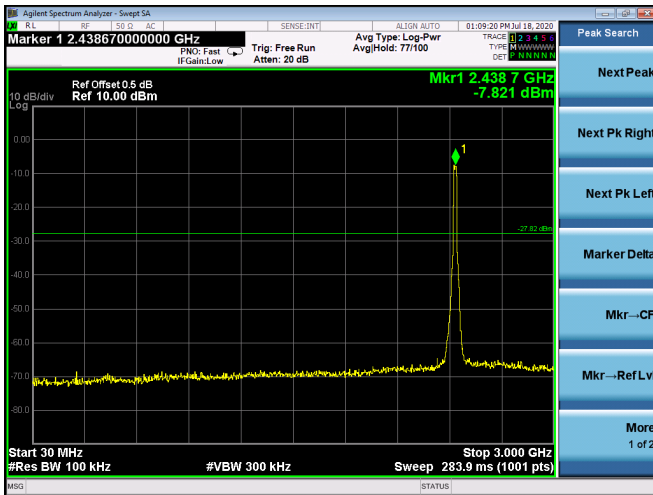

High Channel 2462MHz

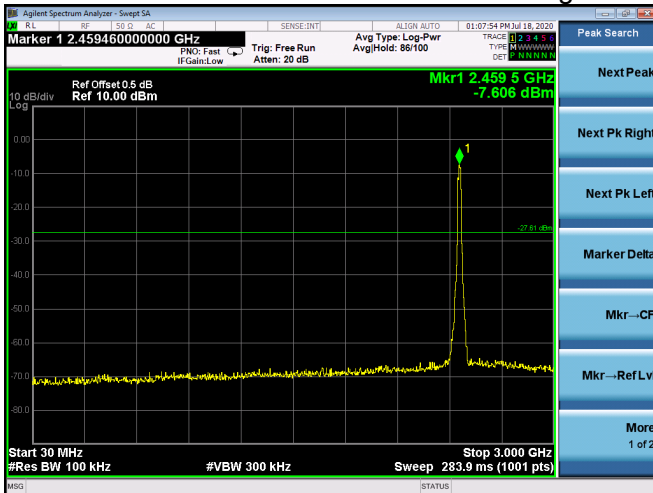

8. DUTY CYCLE OF TEST SIGNAL

8.1 STANDARD REQUIREMENT

Pre-analysis Check: While conducting average power measurement, duty cycle of each mode shall be checked to ensure its duty cycle in order to compensate for the loss due to insufficient ratio of duty cycle.

All duty cycle is pre-scanned, and result as obtained below shows only the most representative ones where duty cycle is conducted as the given transmission with given virtual operation that expresses the percentage.

8.2 FORMULA:

$$\text{Duty Cycle} = \text{Ton} / (\text{Ton} + \text{Toff})$$

Measurement Procedure:

1. Set span = Zero
2. RBW = 8MHz
3. VBW = 8MHz,
4. Detector = Peak

Duty Cycle:

	Duty Cycle	Duty Fator (dB)
802.11b	1	0
802.11g	1	0
802.11n(HT20)	1	0

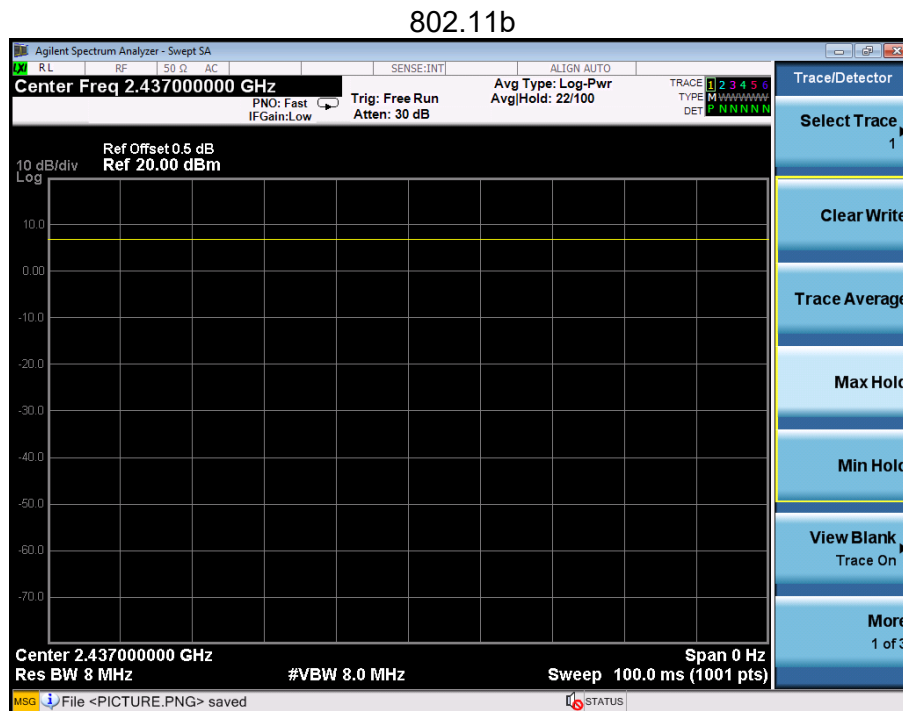



802.11g

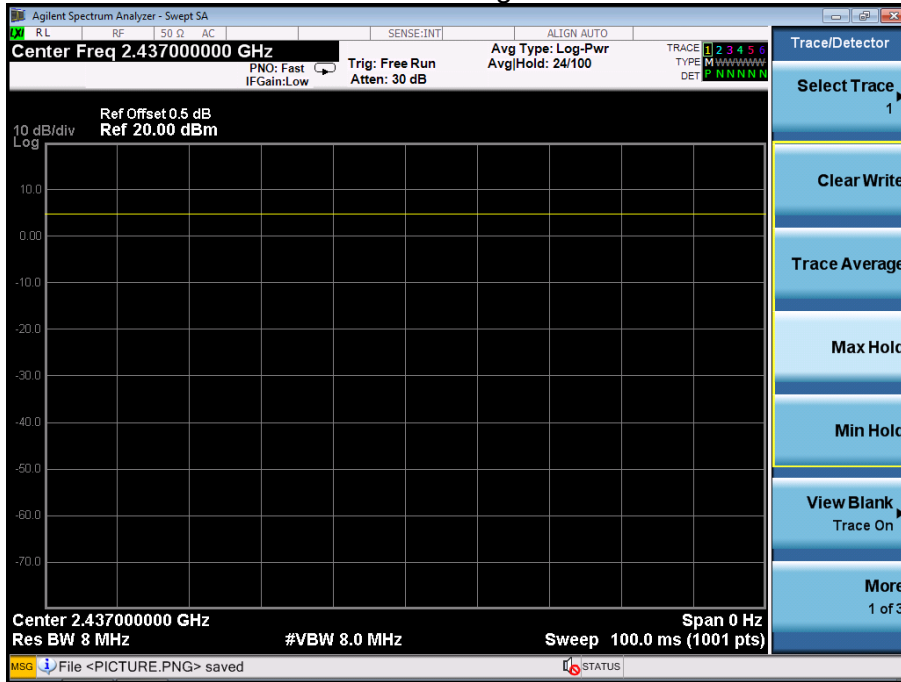

802.11n(HT20)

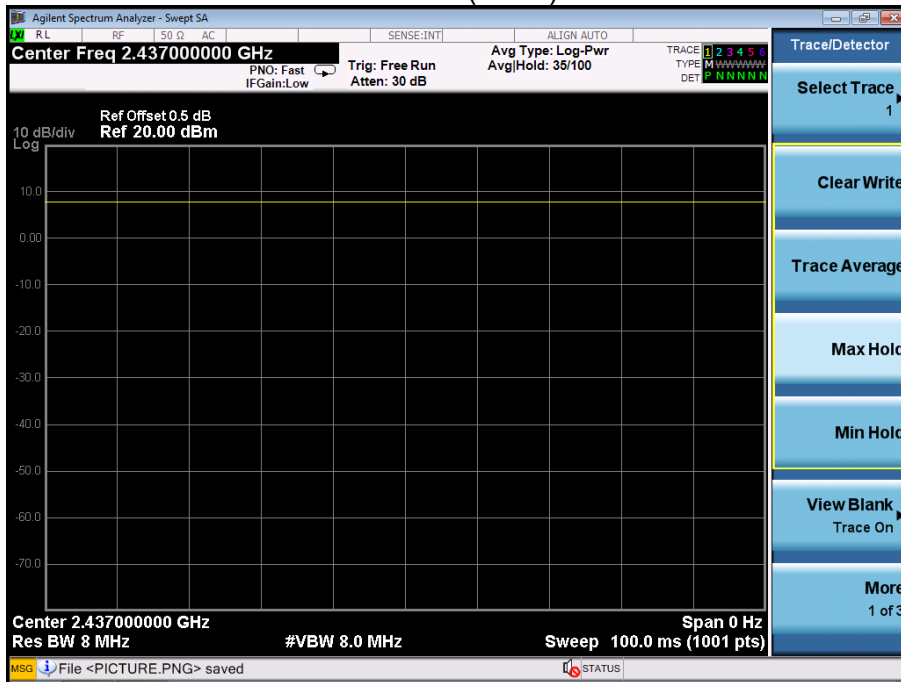



9. ANTENNA REQUIREMENT

9.1 STANDARD REQUIREMENT

15.203 requirement: For intentional device, according to 15.203: an intentional radiator shall be designed to ensure that no antenna other than that furnished by the responsible party shall be used with the device.

9.2 EUT ANTENNA

The EUT antenna is Internal antenna, It comply with the standard requirement.



10. EUT TEST PHOTO

Conducted Measurement Photos



Radiated Measurement Photos



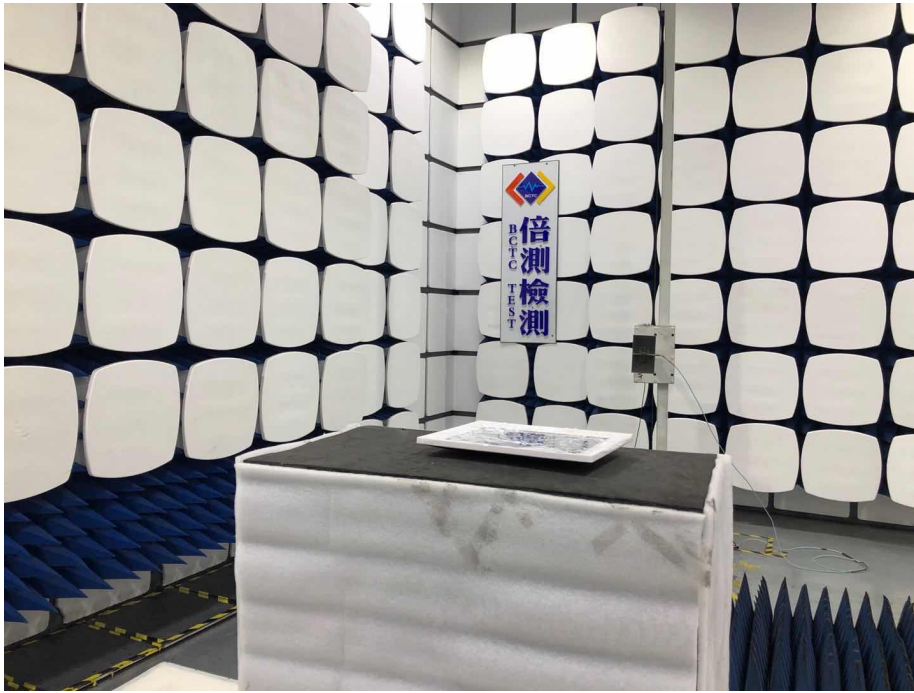

i



11. EUT PHOTO

EUT Photo 1

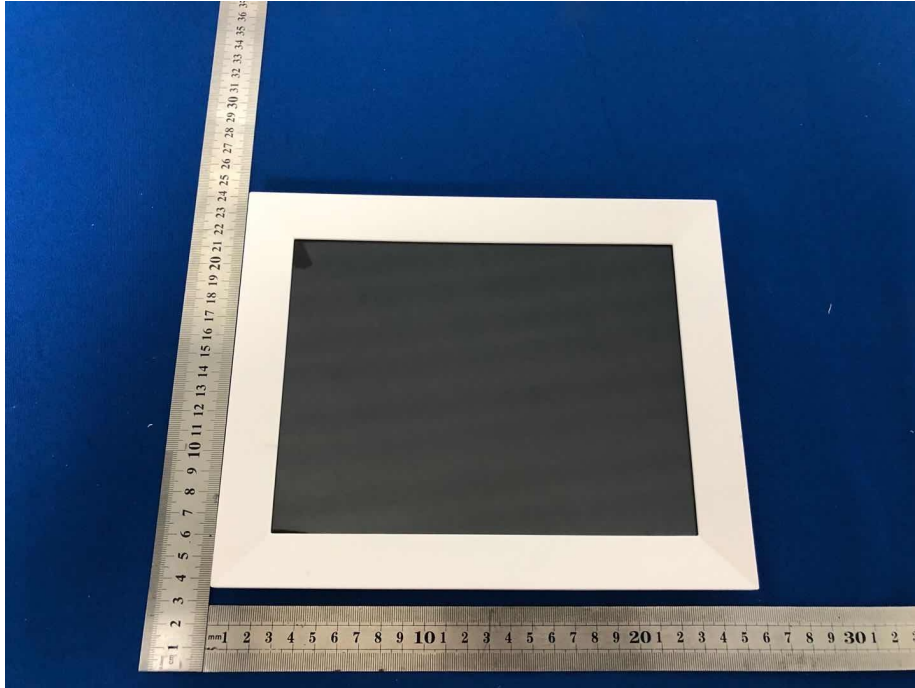

EUT Photo 2

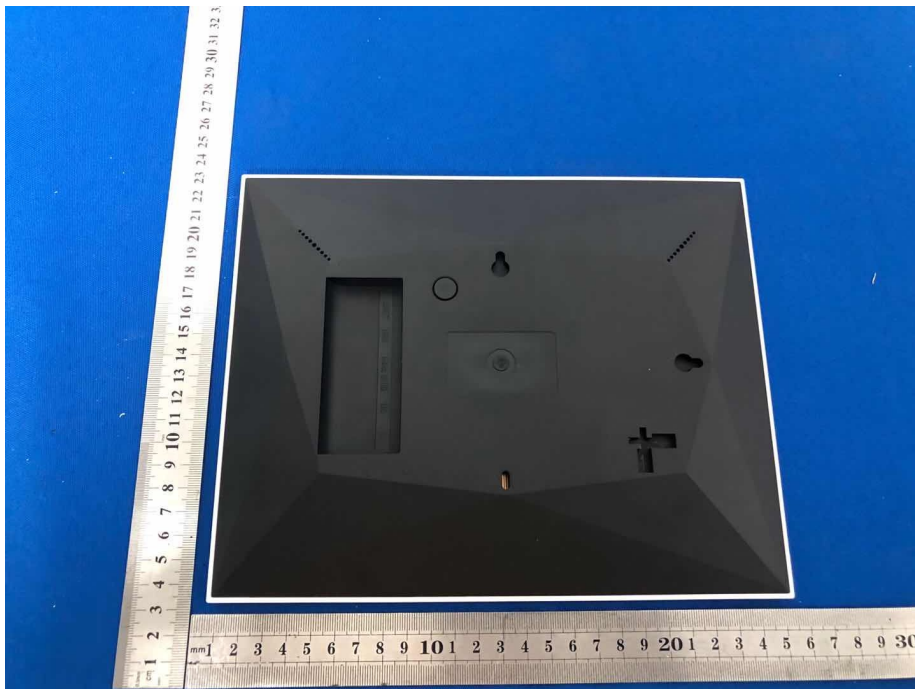

***** END OF REPORT *****

