



Shenzhen Global Test Service Co.,Ltd.

No.7-101 and 8A-104, Building 7 and 8, DCC Cultural and Creative Garden, No.98, Pingxin North Road, Shangmugu Community, Pinghu Street, Longgang District, Shenzhen, Guangdong

FCC PART 15 SUBPART C TEST REPORT

FCC PART 15.247

Report Reference No.....: GTS20210713004-1-5

FCC ID.....: 2AW9I-LPT04

Compiled by

(position+printed name+signature)..: File administrators Peter Xiao

Supervised by

(position+printed name+signature)..: Test Engineer Oliver Ou



Approved by

(position+printed name+signature)..: Manager Simon Hu

Date of issue.....: Jul.29, 2021

Representative Laboratory Name.: Shenzhen Global Test Service Co.,Ltd.

Address: No.7-101 and 8A-104, Building 7 and 8, DCC Cultural and Creative Garden, No.98, Pingxin North Road, Shangmugu Community, Pinghu Street, Longgang District, Shenzhen, Guangdong, China

Applicant's name.....: SOUND INNOVATION CO., LIMITED

Address: RM 1902 EASEY COMM BLDG, 253-261, HENNESSY ROAD, WANCHAI, HONGKONG, CHINA

Test specification: ANSI C63.10-2013

Standard: **FCC Part 15.247: Operation within the bands 902-928 MHz, 2400-2483.5 MHz and 5725-5850 MHz**

TRF Originator.....: Shenzhen Global Test Service Co.,Ltd.

Master TRF.....: Dated 2014-12

Shenzhen Global Test Service Co.,Ltd. All rights reserved.

This publication may be reproduced in whole or in part for non-commercial purposes as long as the Shenzhen Global Test Service Co.,Ltd. is acknowledged as copyright owner and source of the material. Shenzhen Global Test Service Co.,Ltd. takes no responsibility for and will not assume liability for damages resulting from the reader's interpretation of the reproduced material due to its placement and context.

Test item description: Hybrid ANC TWS

Trade Mark: LYPERTEK

Manufacturer: SOUND INNOVATION CO., LIMITED

Model/Type reference: LPT04

List Models: Z5, Z5 ANC, LPT04BK, LPT04GY, LPT04WH

Modulation Type.....: GFSK,π/4-DQPSK,8DPSK

Operation Frequency.....: From 2402MHz to 2480MHz

Hardware Version: v1.0

Software Version: v1.0

Rating: DC 3.7V by battery
Recharged by DC 5.0V

Result: **PASS**

Contents

1. TEST STANDARDS	4
2. SUMMARY	5
2.1. General Remarks	5
2.2. Product Description	5
2.3. Equipment Under Test	6
2.4. Short description of the Equipment under Test (EUT)	6
2.5. EUT operation mode	6
2.6. Block Diagram of Test Setup	7
2.7. Related Submittal(s) / Grant (s)	7
2.8. EUT Exercise Software	7
2.9. Special Accessories	7
2.10. External I/O Cable	7
2.11. Modifications	7
3. TEST ENVIRONMENT	8
3.1. Address of the test laboratory	8
3.2. Test Facility	8
3.3. Environmental conditions	8
3.4. Statement of the measurement uncertainty	8
3.5. Summary of measurement results	9
3.6. Equipments Used during the Test	10
4. TEST CONDITIONS AND RESULTS	11
4.1. AC Power Conducted Emission	11
4.2. Radiated Emission	13
4.3. Maximum Peak Output Power	18
4.4. 20dB Bandwidth	19
4.5. Frequency Separation	22
4.6. Band Edge Compliance of RF Emission	24
4.7. Number of hopping frequency	29
4.8. Time Of Occupancy(Dwell Time)	30
4.9. Pseudorandom Frequency Hopping Sequence	33
4.10. Antenna Requirement	34
5. TEST SETUP PHOTOS OF THE EUT	35
6. EXTERNAL AND INTERNAL PHOTOS OF THE EUT	37

1. TEST STANDARDS

The tests were performed according to following standards:

[FCC Rules Part 15.247](#): Frequency Hopping, Direct Spread Spectrum and Hybrid Systems that are in operation within the bands of 902-928 MHz, 2400-2483.5 MHz, and 5725-5850 MHz.

[ANSI C63.10-2013](#): American National Standard for Testing Unlicensed Wireless Devices

[KDB558074 D01 15.247 Meas Guidance v05r02](#): Digital Transmission Systems (DTS) and Frequency Hopping measurement procedures

2. SUMMARY

2.1. General Remarks

Date of receipt of test sample	:	Jul.13, 2021
	:	
Testing commenced on	:	Jul.13, 2021
	:	
Testing concluded on	:	Jul.29, 2021

2.2. Product Description

Product Name:	Hybrid ANC TWS
Trade Mark:	LYPEPTEK
Model/Type reference:	LPT04
List Model:	Z5, Z5 ANC, LPT04BK, LPT04GY, LPT04WH
Model Declaration	PCB board, structure and internal of these model(s) are the same, Only the model name different , So no additional models were tested.
Power supply:	DC 3.7V by battery Recharged by DC 5.0V
Hardware Version	v1.0
Software Version	v1.0
Sample ID	GTS20210713004-1-1# & GTS20210713004-1-2#
Bluetooth	
Frequency Range	2402MHz ~ 2480MHz
Channel Number	79 channels for Bluetooth (DSS)
Channel Spacing	1MHz for Bluetooth (DSS)
Modulation Type	GFSK, $\pi/4$ -DQPSK, 8DPSK for Bluetooth (DSS)
Antenna Description	Internal Antenna, 0.3dBi(Max.)

2.3. Equipment Under Test

Power supply system utilised

Power supply voltage	:	<input type="radio"/> 230V / 50 Hz	<input type="radio"/> 120V / 60Hz
		<input type="radio"/> 12 V DC	<input type="radio"/> 24 V DC
		<input checked="" type="radio"/> Other (specified in blank below)	

DC 3.7V

2.4. Short description of the Equipment under Test (EUT)

This is a Hybrid ANC TWS .

For more details, refer to the user’s manual of the EUT.

2.5. EUT operation mode

The Applicant provides communication tools software to control the EUT for staying in continuous transmitting (Duty Cycle more than 98%) and receiving mode for testing .There are 79 channels provided to the EUT. Channel 00/39/78 was selected to test.

Mode of Operations	Frequency Range (MHz)	Data Rate (Mbps)
(BDR/EDR)	2402	1/2/3
	2441	1/2/3
	2480	1/2/3
For Conducted Emission		
Test Mode		TX Mode
For Radiated Emission		
Test Mode		TX Mode

Channel	Frequency(MHz)	Channel	Frequency(MHz)
00	2402	40	2442
01	2403	41	2443
02	2404	42	2444
--	--	--	--
--	--	--	--
38	2440	78	2480
39	2441		

AC conducted emission pre-test at both at AC 120V/60Hz and AC 240V/60Hz modes, recorded worst case.

Worst-case mode and channel used for 150 KHz-30 MHz power line conducted emissions was the mode and channel with the highest output power that was determined to be TX (1Mbps).

Worst-case mode and channel used for 9 KHz-1000 MHz radiated emissions was the mode and channel with the highest output power, that was determined to be TX(1Mbps-MCH).

2.6. Block Diagram of Test Setup



2.7. Related Submittal(s) / Grant (s)

This submittal(s) (test report) is intended for **FCC ID: 2AW9I-LPT04** filing to comply with Section 15.247 of the FCC Part 15, Subpart C Rules.

2.8. EUT Exercise Software

The system was configured for testing in a continuous transmits condition and change test channels by software (InstallBlueSuiteCda_3_3_3_604.exe) provided by application.

2.9. Special Accessories

Manufacturer	Description	Model	Serial Number	Certificate
Shenzhen Huajin Electronics Co., Ltd.	Adapter	HJ-FC013K2-CCC	--	SDOC

Note: The Adapter is only used for auxiliary testing.

2.10. External I/O Cable

I/O Port Description	Quantity	Cable
DC IN Port	1	N/A

2.11. Modifications

No modifications were implemented to meet testing criteria.

3. TEST ENVIRONMENT

3.1. Address of the test laboratory

Shenzhen Global Test Service Co.,Ltd.

No.7-101 and 8A-104, Building 7 and 8, DCC Cultural and Creative Garden, No.98, Pingxin North Road, Shangmugu Community, Pinghu Street, Longgang District, Shenzhen, Guangdong,China.

3.2. Test Facility

The test facility is recognized, certified, or accredited by the following organizations:

CNAS (No. CNAS L8169)

Shenzhen Global Test Service Co., Ltd. has been assessed and proved to be in compliance with CNAS-CL01 Accreditation Criteria for Testing and Calibration Laboratories (identical to ISO/IEC 17025: 2019 General Requirements) for the Competence of Testing and Calibration Laboratories.

A2LA (Certificate No. 4758.01)

Shenzhen Global Test Service Co., Ltd. has been assessed by the American Association for Laboratory Accreditation (A2LA). Certificate No. 4758.01.

Industry Canada Registration Number. is 24189.

FCC Designation Number is CN1234.

FCC Registered Test Site Number is165725.

3.3. Environmental conditions

During the measurement the environmental conditions were within the listed ranges:

Temperature:	15-35 ° C
Humidity:	30-60 %
Atmospheric pressure:	950-1050mbar

3.4. Statement of the measurement uncertainty

The data and results referenced in this document are true and accurate. The reader is cautioned that there may be errors within the calibration limits of the equipment and facilities. The measurement uncertainty was calculated for all measurements listed in this test report acc. to CISPR 16 - 4 „Specification for radio disturbance and immunity measuring apparatus and methods – Part 4: Uncertainty in EMC Measurements“ and is documented in the Shenzhen Global Test Service Co.,Ltd. quality system acc. to DIN EN ISO/IEC 17025. Furthermore, component and process variability of devices similar to that tested may result in additional deviation. The manufacturer has the sole responsibility of continued compliance of the device.

Hereafter the best measurement capability for Shenzhen GTS laboratory is reported:

Test	Range	Measurement Uncertainty	Notes
Radiated Emission	30~1000MHz	4.10 dB	(1)
Radiated Emission	1~18GHz	4.32 dB	(1)
Radiated Emission	18-40GHz	5.54 dB	(1)
Conducted Disturbance	0.15~30MHz	3.12 dB	(1)

This uncertainty represents an expanded uncertainty expressed at approximately the 95% confidence level using a coverage factor of k=2.

3.5. Summary of measurement results

Applied Standard: FCC Part 15 Subpart C				
FCC Rules	Description of Test	Test Sample	Result	Remark
§15.247(b)(1)	Maximum Conducted Output Power	GTS20210713004-1-1#	Compliant	Note 1
§15.247(c)	Frequency Separation	GTS20210713004-1-1#	Compliant	Note 1
§15.247(c)	99% and 20 dB Bandwidth	GTS20210713004-1-1#	Compliant	Note 1
§15.247(a)(1)(ii)	Number of Hopping Frequency	GTS20210713004-1-1#	Compliant	Note 1
§15.247(a)(1)(iii)	Time Of Occupancy (Dwell Time)	GTS20210713004-1-1#	Compliant	Note 1
§15.209, §15.205	Conducted Spurious Emissions and Band Edges Test	GTS20210713004-1-1#	Compliant	Note 1
§15.209, §15.247(d)	Radiated Spurious Emissions	GTS20210713004-1-1# GTS20210713004-1-2#	Compliant	Note 1
§15.205	Emissions at Restricted Band	GTS20210713004-1-1# GTS20210713004-1-2#	Compliant	Note 1
§15.207(a)	AC Conducted Emissions	GTS20210713004-1-2#	Compliant	Note 1
§15.203 §15.247(c)	Antenna Requirements	GTS20210713004-1-1#	Compliant	Note 1
§15.247(i)§2.1093	RF Exposure	/	Compliant	Note 2

Remark:

1. The measurement uncertainty is not included in the test result.
2. NA = Not Applicable; NP = Not Performed
3. Note 1 – Test results inside test report;
4. Note 2 – Test results in other test report (SAR Report).
5. We tested all test mode and recorded worst case in report

3.6. Equipments Used during the Test

Test Equipment	Manufacturer	Model No.	Serial No.	Calibration Date	Calibration Due Date
LISN	CYBERTEK	EM5040A	E1850400105	2021/07/23	2022/07/22
LISN	R&S	ESH2-Z5	893606/008	2021/07/23	2022/07/22
EMI Test Receiver	R&S	ESPI3	101841-cd	2021/07/23	2022/07/22
EMI Test Receiver	R&S	ESCI7	101102	2020/09/20	2021/09/19
Spectrum Analyzer	Agilent	N9020A	MY48010425	2020/09/20	2021/09/19
Spectrum Analyzer	R&S	FSV40	100019	2021/07/23	2022/07/22
Vector Signal generator	Agilent	N5181A	MY49060502	2021/07/23	2022/07/22
Signal generator	Agilent	N5182A	3610AO1069	2020/09/20	2021/09/19
Climate Chamber	ESPEC	EL-10KA	A20120523	2020/09/20	2021/09/19
Controller	EM Electronics	Controller EM 1000	N/A	N/A	N/A
Horn Antenna	Schwarzbeck	BBHA 9120D	01622	2020/11/08	2021/11/07
Active Loop Antenna	Beijing Da Ze Technology Co.,Ltd.	ZN30900C	15006	2020/10/11	2021/10/10
Bilog Antenna	Schwarzbeck	VULB9163	000976	2021/07/23	2022/07/22
Broadband Horn Antenna	SCHWARZBECK	BBHA 9170	791	2020/11/08	2021/11/07
Amplifier	Schwarzbeck	BBV 9743	#202	2021/07/23	2022/07/22
Amplifier	Schwarzbeck	BBV9179	9719-025	2021/07/23	2022/07/22
Amplifier	EMCI	EMC051845B	980355	2021/07/23	2022/07/22
Temperature/Humidity Meter	Gangxing	CTH-608	02	2021/07/23	2022/07/22
High-Pass Filter	K&L	9SH10-2700/X12750-O/O	KL142031	2021/07/23	2022/07/22
High-Pass Filter	K&L	41H10-1375/U12750-O/O	KL142032	2021/07/23	2022/07/22
RF Cable(below 1GHz)	HUBER+SUHNER	RG214	RE01	2021/07/23	2022/07/22
RF Cable(above 1GHz)	HUBER+SUHNER	RG214	RE02	2021/07/23	2022/07/22
Data acquisition card	Agilent	U2531A	TW53323507	2021/07/23	2022/07/22
Power Sensor	Agilent	U2021XA	MY5365004	2021/07/23	2022/07/22
Test Control Unit	Tonscend	JS0806-1	178060067	2021/07/23	2022/07/22
Automated filter bank	Tonscend	JS0806-F	19F8060177	2021/07/23	2022/07/22
EMI Test Software	Tonscend	JS1120-1	Ver 2.6.8.0518	/	/
EMI Test Software	Tonscend	JS1120-3	Ver 2.5.77.0418	/	/
EMI Test Software	Tonscend	JS32-CE	Ver 2.5	/	/
EMI Test Software	Tonscend	JS32-RE	Ver 2.5.1.8	/	/

Note: The Cal.Interval was one year.

4. TEST CONDITIONS AND RESULTS

4.1. AC Power Conducted Emission

TEST CONFIGURATION

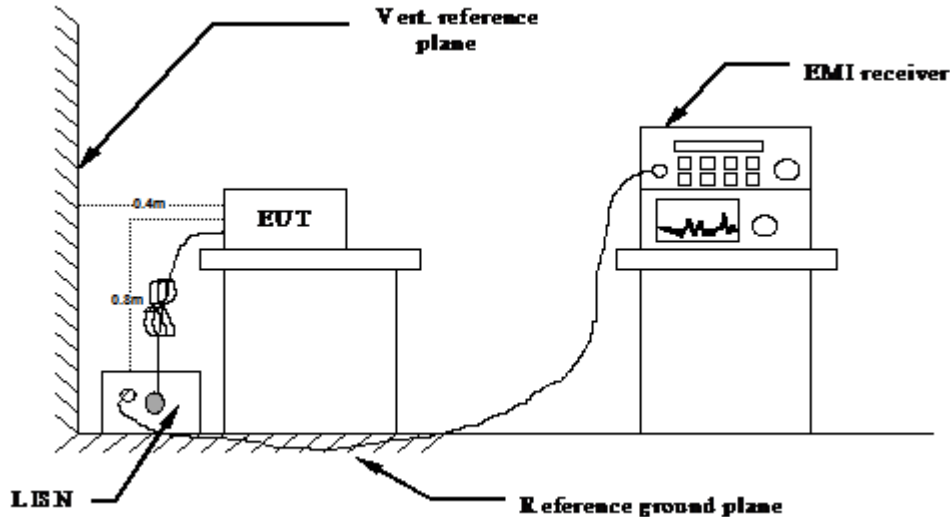

TEST PROCEDURE

- 1 The equipment was set up as per the test configuration to simulate typical actual usage per the user's manual. The EUT is a tabletop system, a wooden table with a height of 0.8 meters is used and is placed on the ground plane as per ANSI C63.10-2013.
- 2 Support equipment, if needed, was placed as per ANSI C63.10-2013.
- 3 All I/O cables were positioned to simulate typical actual usage as per ANSI C63.10-2013.
- 4 The EUT received DC 5V power, the adapter received AC120V/60Hz or AC 240V/60Hz power through a Line Impedance Stabilization Network (LISN) which supplied power source and was grounded to the ground plane.
- 6 The EUT test program was started. Emissions were measured on each current carrying line of the EUT using a spectrum Analyzer / Receiver connected to the LISN powering the EUT. The LISN has two monitoring points: Line 1 (Hot Side) and Line 2 (Neutral Side). Two scans were taken: one with Line 1 connected to Analyzer / Receiver and Line 2 connected to a 50 ohm load; the second scan had Line 1 connected to a 50 ohm load and Line 2 connected to the Analyzer / Receiver.
- 7 Analyzer / Receiver scanned from 150 KHz to 30MHz for emissions in each of the test modes.
- 8 During the above scans, the emissions were maximized by cable manipulation.

AC Power Conducted Emission Limit

For intentional device, according to § 15.207(a) AC Power Conducted Emission Limits is as following :

Frequency range (MHz)	Limit (dBuV)	
	Quasi-peak	Average
0.15-0.5	66 to 56*	56 to 46*
0.5-5	56	46
5-30	60	50

* Decreases with the logarithm of the frequency.

TEST RESULTS

Remark: We measured Conducted Emission at GFSK, $\pi/4$ -DQPSK and 8DPSK mode in AC 120V/60Hz and AC 240V/50Hz, the worst case was recorded(GFSK 1Mbps-MCH) .

Temperature	24.2°C	Humidity	54.2%
Test Engineer	Oliver Ou	Configurations	BT

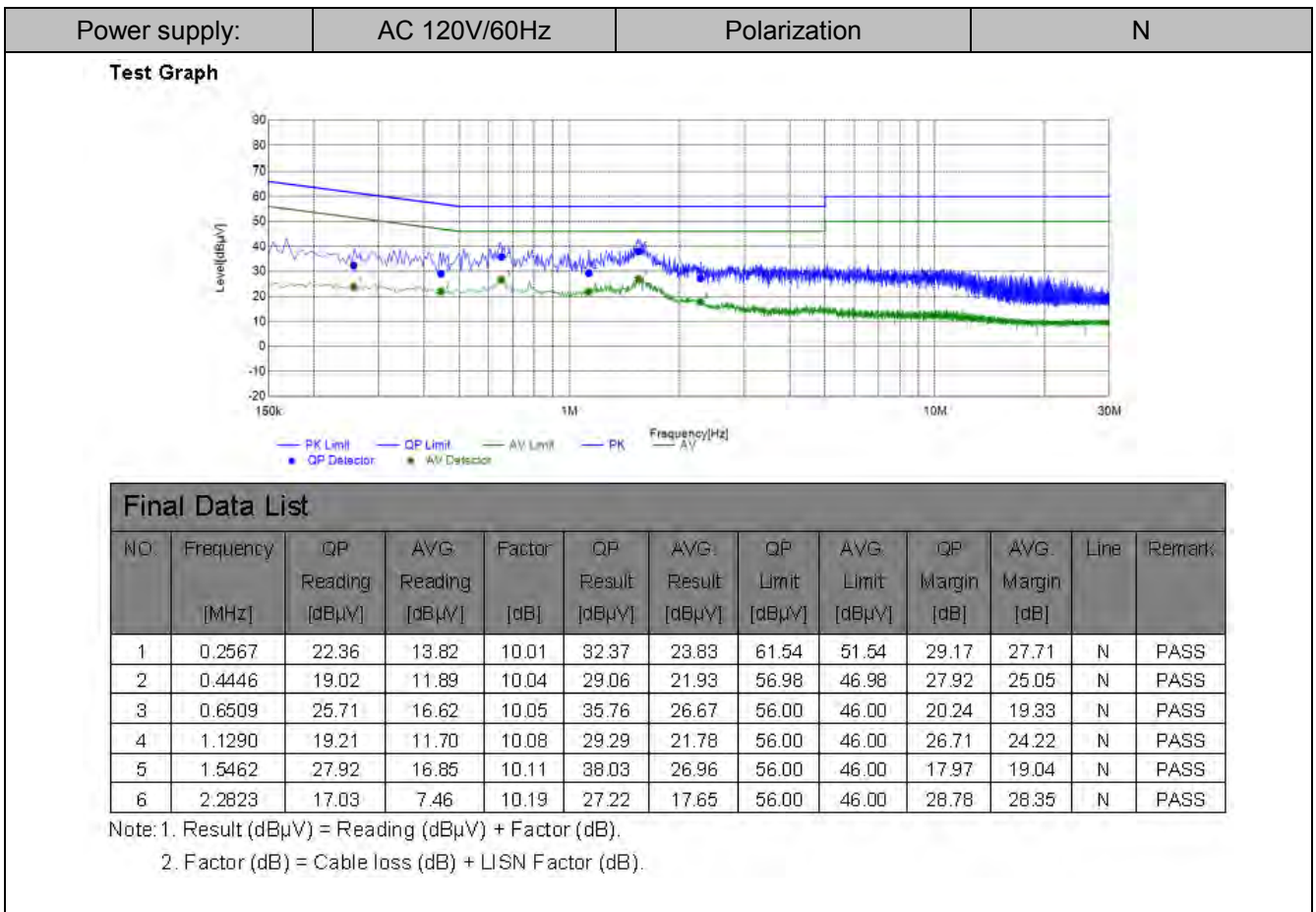
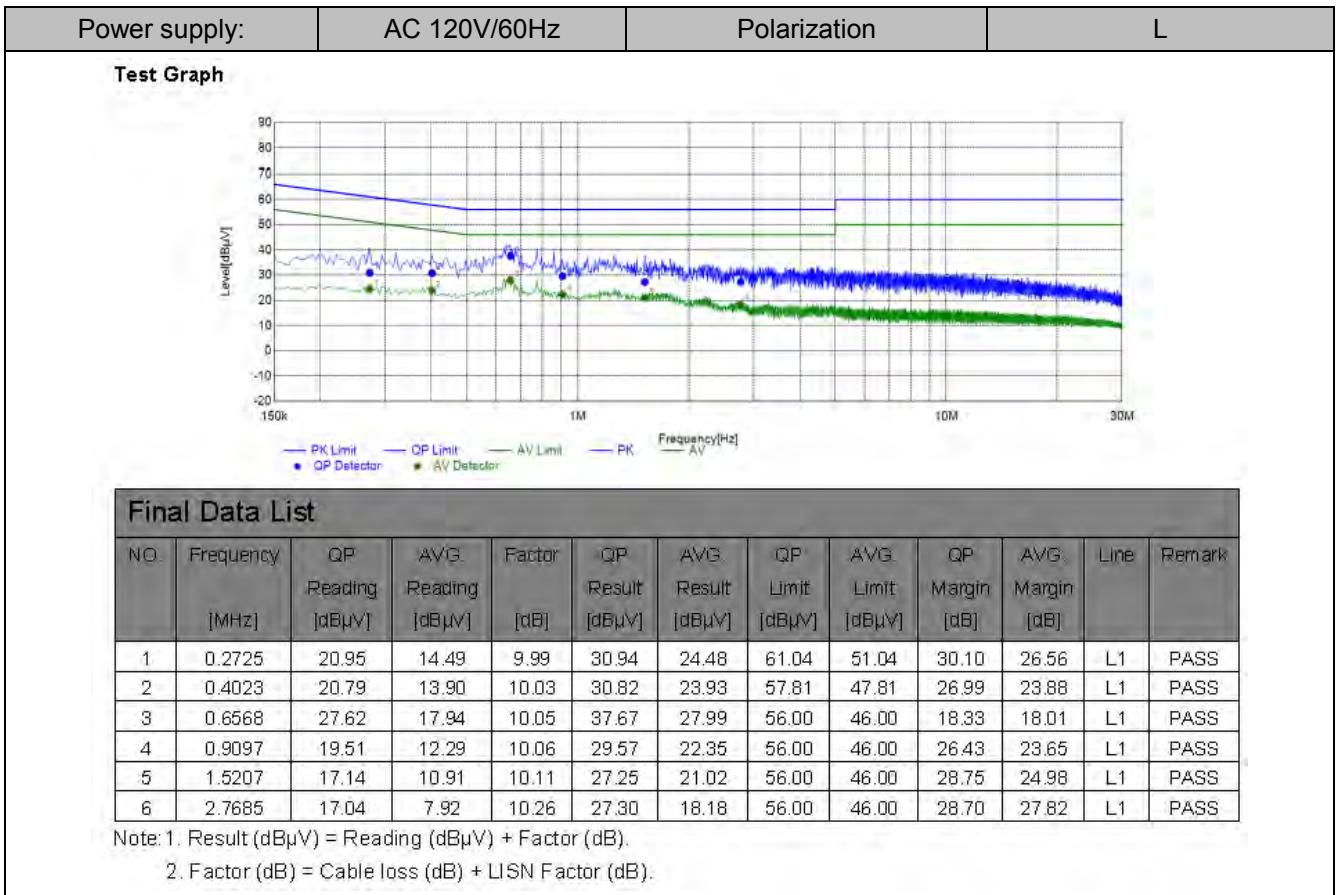

4.2. Radiated Emission

TEST CONFIGURATION

Frequency range 9 KHz – 30MHz

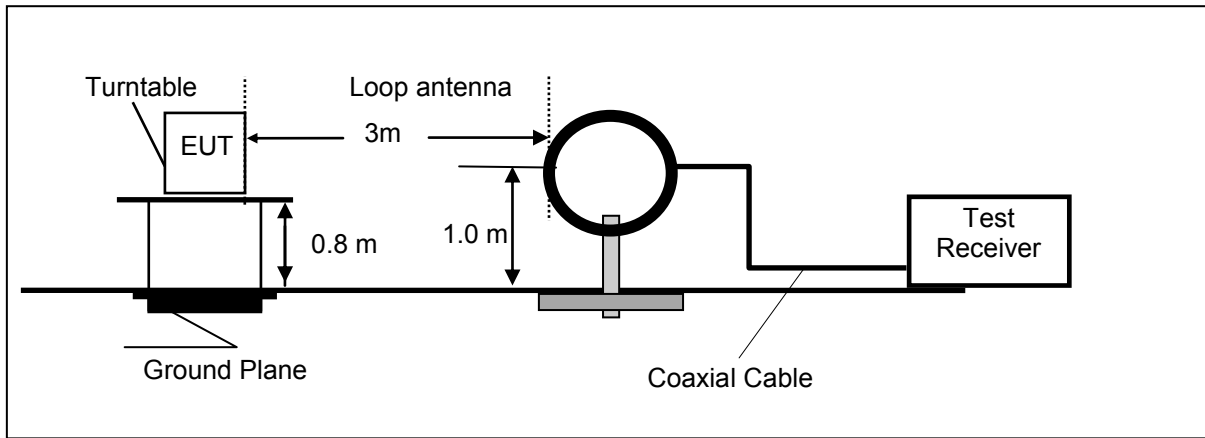

Frequency range 30MHz – 1000MHz

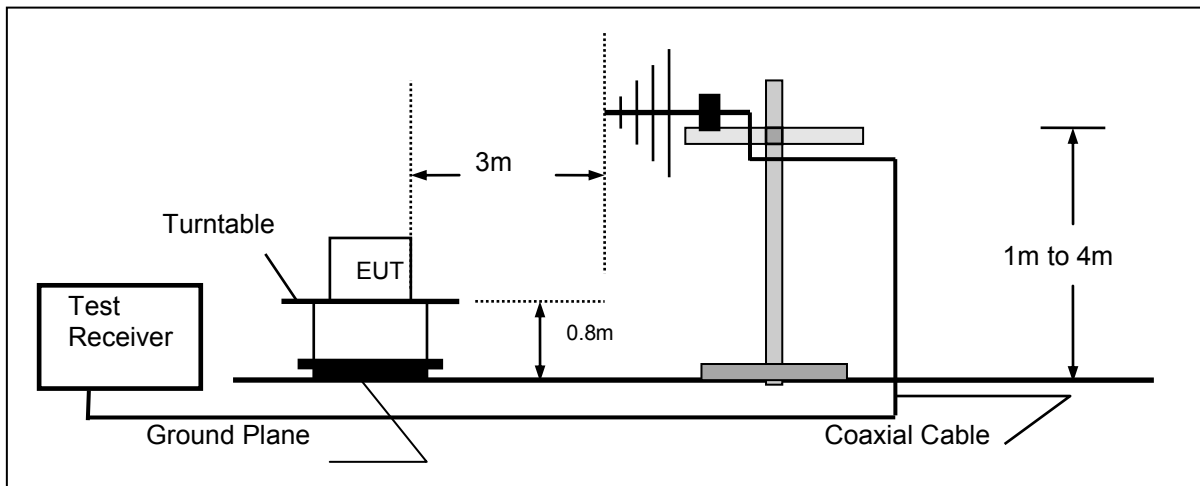

Frequency range above 1GHz-25GHz

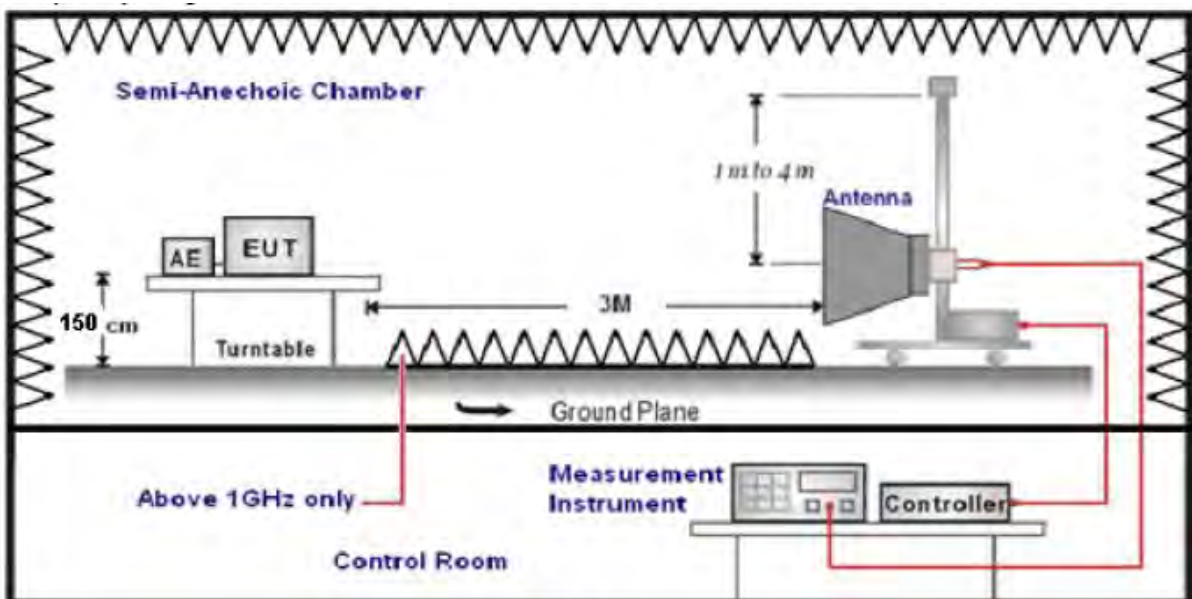

TEST PROCEDURE

1. The EUT was placed on a turn table which is 0.8m above ground plane when testing frequency range 9 KHz –1GHz;the EUT was placed on a turn table which is 1.5m above ground plane when testing frequency range 1GHz – 25GHz.
2. Maximum procedure was performed by raising the receiving antenna from 1m to 4m and rotating the turn table from 0°C to 360°C to acquire the highest emissions from EUT.
3. And also, each emission was to be maximized by changing the polarization of receiving antenna both horizontal and vertical.
4. Repeat above procedures until all frequency measurements have been completed.
5. The EUT minimum operation frequency was 32.768KHz and maximum operation frequency was 2480MHz.so radiated emission test frequency band from 9KHz to 25GHz.
6. The distance between test antenna and EUT as following table states:

Test Frequency range	Test Antenna Type	Test Distance
9KHz-30MHz	Active Loop Antenna	3
30MHz-1GHz	Ultra-Broadband Antenna	3
1GHz-18GHz	Double Ridged Horn Antenna	3
18GHz-25GHz	Horn Antenna	1

7. Setting test receiver/spectrum as following table states:

Test Frequency range	Test Receiver/Spectrum Setting	Detector
9KHz-150KHz	RBW=200Hz/VBW=3KHz, Sweep time=Auto	QP
150KHz-30MHz	RBW=9KHz/VBW=100KHz, Sweep time=Auto	QP
30MHz-1GHz	RBW=120KHz/VBW=1000KHz, Sweep time=Auto	QP
1GHz-40GHz	Peak Value: RBW=1MHz/VBW=3MHz, Sweep time=Auto Average Value: RBW=1MHz/VBW=10Hz, Sweep time=Auto	Peak

Field Strength Calculation

The field strength is calculated by adding the Antenna Factor and Cable Factor and subtracting the Amplifier Gain and Duty Cycle Correction Factor(if any) from the measured reading. The basic equation with a sample calculation is as follows:

$$FS = RA + AF + CL - AG$$

Where FS = Field Strength	CL = Cable Attenuation Factor (Cable Loss)
RA = Reading Amplitude	AG = Amplifier Gain
AF = Antenna Factor	

$$Transd=AF +CL-AG$$

RADIATION LIMIT

For intentional device, according to § 15.209(a), the general requirement of field strength of radiated emission from intentional radiators at a distance of 3 meters shall not exceed the following table. According to § 15.247(d), in any 100kHz bandwidth outside the frequency band in which the EUT is operating, the radio frequency power that is produced by the intentional radiator shall be at least 20dB below that in the100kHz bandwidth within the band that contains the highest level of desired power.

The pre-test have done for the EUT in three axes and found the worst emission at position shown in test setup photos.

Frequency (MHz)	Distance (Meters)	Radiated (dBµV/m)	Radiated (µV/m)
0.009-0.49	3	20log(2400/F(KHz))+40log(300/3)	2400/F(KHz)
0.49-1.705	3	20log(24000/F(KHz))+ 40log(30/3)	24000/F(KHz)
1.705-30	3	20log(30)+ 40log(30/3)	30
30-88	3	40.0	100
88-216	3	43.5	150
216-960	3	46.0	200
Above 960	3	54.0	500

TEST RESULTS

Remark: We measured Radiated Emission at GFSK, π/4-DQPSK and 8DPSK mode from 30MHz to 25GHz and recorded worst case at GFSK(1Mbps-MCH) mode.

Temperature	24.1 °C	Humidity	53.8%
Test Engineer	Oliver Ou	Configurations	BT

For 30MHz-1GHz

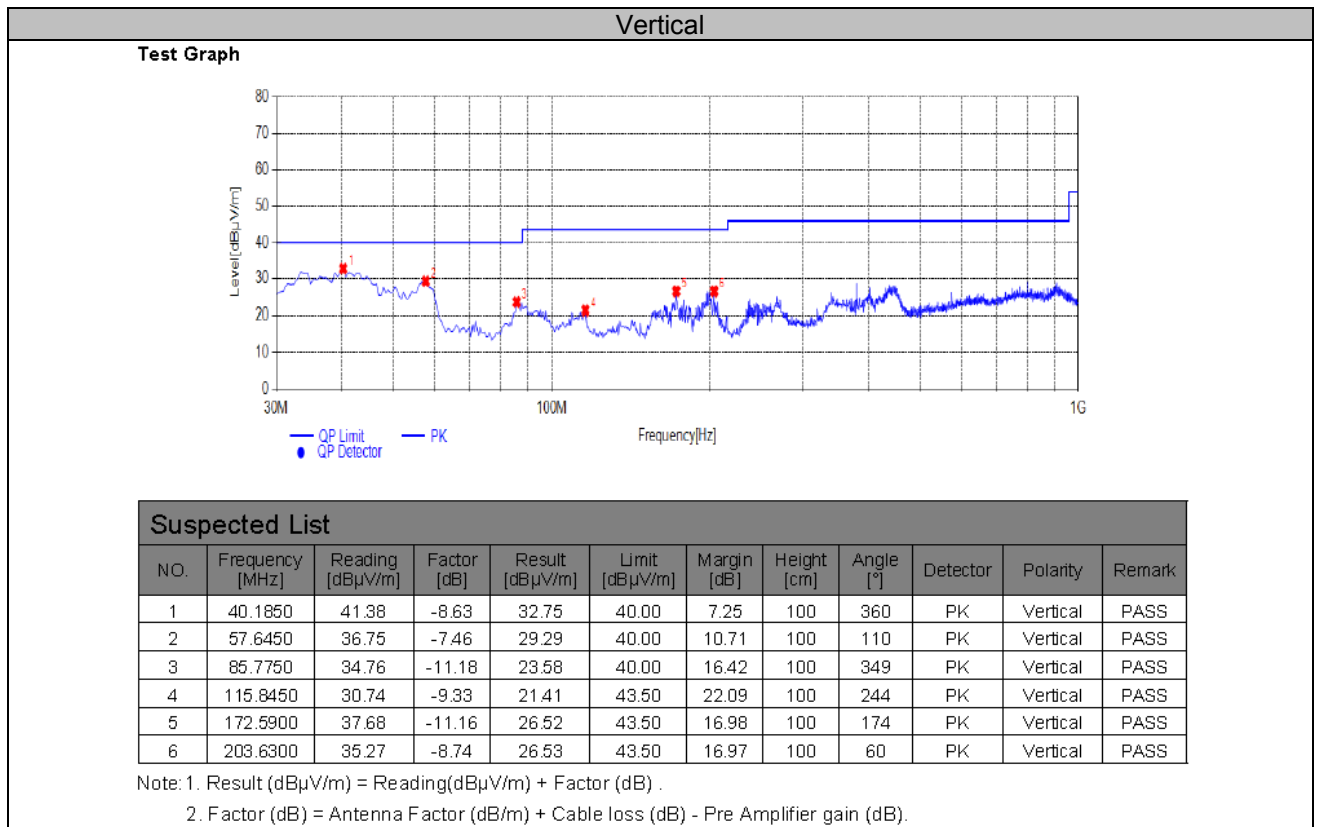
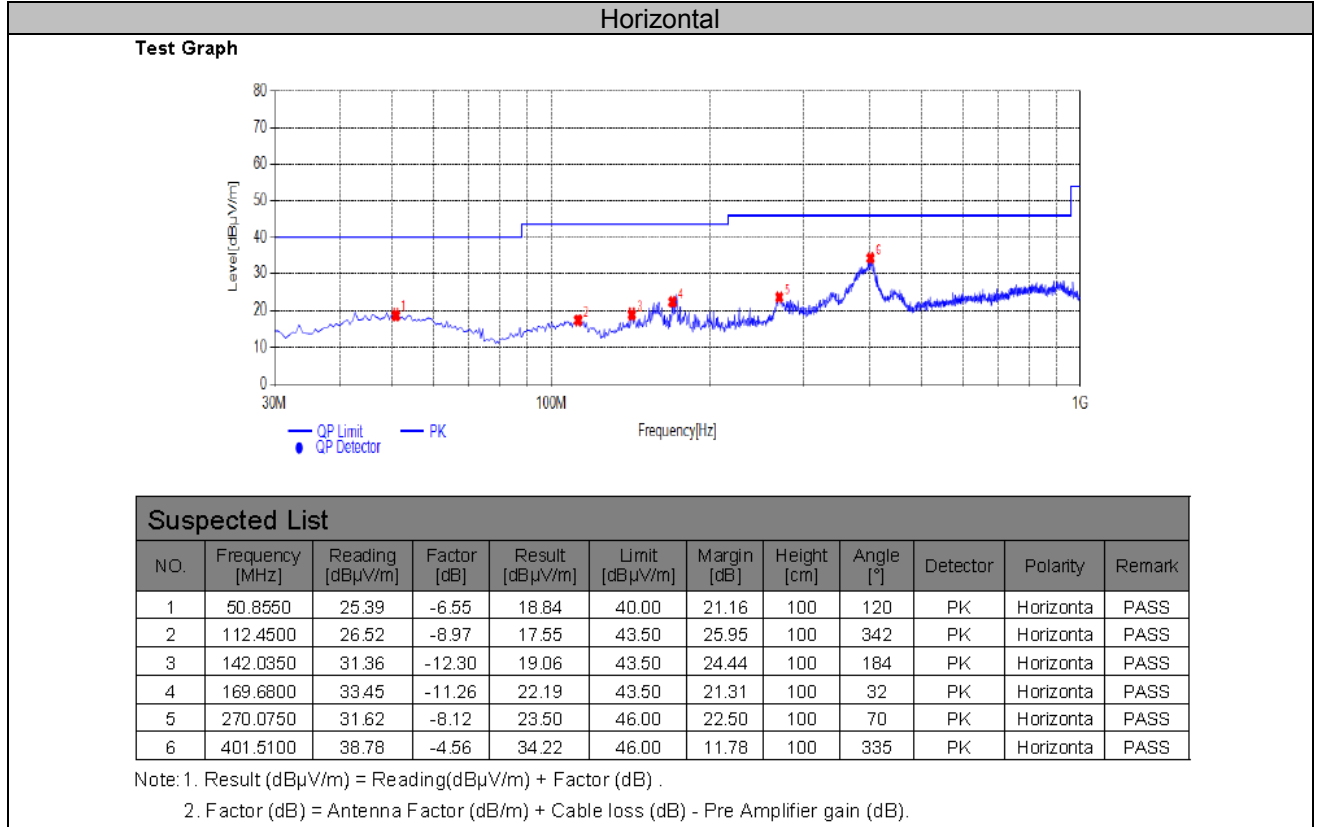

For 1GHz to 25GHz

GFSK /Channel 0 / 2402 MHz

Freq. MHz	Reading dBuV	Ant. Fac. dB/m	Pre. Fac. dB	Cab. Loss dB	Measured dBuV/m	Limit dBuV/m	Margin dB	Remark	Pol.
4804.00	50.29	32.44	30.25	7.95	60.43	74.00	-13.57	Peak	Horizontal
4804.00	36.31	32.44	30.25	7.95	46.45	54.00	-7.55	Average	Horizontal
4804.00	53.38	32.44	30.25	7.95	63.52	74.00	-10.48	Peak	Vertical
4804.00	36.28	32.44	30.25	7.95	46.42	54.00	-7.58	Average	Vertical

Channel 39 / 2441 MHz

Freq. MHz	Reading dBuV	Ant. Fac. dB/m	Pre. Fac. dB	Cab. Loss dB	Measured dBuV/m	Limit dBuV/m	Margin dB	Remark	Pol.
4882.00	49.04	32.52	30.31	8.12	59.37	74.00	-14.63	Peak	Horizontal
4882.00	37.09	32.52	30.31	8.12	47.42	54.00	-6.58	Average	Horizontal
4882.00	52.55	32.52	30.31	8.12	62.88	74.00	-11.12	Peak	Vertical
4882.00	36.08	32.52	30.31	8.12	46.41	54.00	-7.59	Average	Vertical

Channel 78 / 2480 MHz

Freq. MHz	Reading dBuV	Ant. Fac. dB/m	Pre. Fac. dB	Cab. Loss dB	Measured dBuV/m	Limit dBuV/m	Margin dB	Remark	Pol.
4960.00	50.50	32.68	30.27	7.88	60.79	74.00	-13.21	Peak	Horizontal
4960.00	36.43	32.68	30.27	7.88	46.72	54.00	-7.28	Average	Horizontal
4960.00	49.47	32.68	30.27	7.88	59.76	74.00	-14.24	Peak	Vertical
4960.00	31.51	32.68	30.27	7.88	41.80	54.00	-12.20	Average	Vertical

 $\pi/4$ -DQPSK /Channel 0 / 2402 MHz

Freq. MHz	Reading dBuV	Ant. Fac. dB/m	Pre. Fac. dB	Cab. Loss dB	Measured dBuV/m	Limit dBuV/m	Margin dB	Remark	Pol.
4804.00	50.19	32.44	30.25	7.95	60.33	74.00	-13.67	Peak	Horizontal
4804.00	35.25	32.44	30.25	7.95	45.39	54.00	-8.61	Average	Horizontal
4804.00	54.31	32.44	30.25	7.95	64.45	74.00	-9.55	Peak	Vertical
4804.00	34.89	32.44	30.25	7.95	45.03	54.00	-8.97	Average	Vertical

Channel 39 / 2441 MHz

Freq. MHz	Reading dBuV	Ant. Fac. dB/m	Pre. Fac. dB	Cab. Loss dB	Measured dBuV/m	Limit dBuV/m	Margin dB	Remark	Pol.
4882.00	50.27	32.52	30.31	8.12	60.60	74.00	-13.40	Peak	Horizontal
4882.00	37.20	32.52	30.31	8.12	47.53	54.00	-6.47	Average	Horizontal
4882.00	52.76	32.52	30.31	8.12	63.09	74.00	-10.91	Peak	Vertical
4882.00	35.04	32.52	30.31	8.12	45.37	54.00	-8.63	Average	Vertical

Channel 78 / 2480 MHz

Freq. MHz	Reading dBuV	Ant. Fac. dB/m	Pre. Fac. dB	Cab. Loss dB	Measured dBuV/m	Limit dBuV/m	Margin dB	Remark	Pol.
4960.00	50.98	32.68	30.27	7.88	61.27	74.00	-12.73	Peak	Horizontal
4960.00	36.21	32.68	30.27	7.88	46.50	54.00	-7.50	Average	Horizontal
4960.00	48.86	32.68	30.27	7.88	59.15	74.00	-14.85	Peak	Vertical
4960.00	32.22	32.68	30.27	7.88	42.51	54.00	-11.49	Average	Vertical

8-DPSK /Channel 0 / 2402 MHz

Freq. MHz	Reading dBuV	Ant. Fac. dB/m	Pre. Fac. dB	Cab. Loss dB	Measured dBuV/m	Limit dBuV/m	Margin dB	Remark	Pol.
4804.00	50.31	32.44	30.25	7.95	60.45	74.00	-13.55	Peak	Horizontal
4804.00	35.71	32.44	30.25	7.95	45.85	54.00	-8.15	Average	Horizontal
4804.00	53.16	32.44	30.25	7.95	63.30	74.00	-10.70	Peak	Vertical
4804.00	35.74	32.44	30.25	7.95	45.88	54.00	-8.12	Average	Vertical

Channel 39 / 2441 MHz

Freq. MHz	Reading dBuV	Ant. Fac. dB/m	Pre. Fac. dB	Cab. Loss dB	Measured dBuV/m	Limit dBuV/m	Margin dB	Remark	Pol.
4882.00	50.89	32.52	30.31	8.12	61.22	74.00	-12.78	Peak	Horizontal
4882.00	36.19	32.52	30.31	8.12	46.52	54.00	-7.48	Average	Horizontal
4882.00	52.52	32.52	30.31	8.12	62.85	74.00	-11.15	Peak	Vertical
4882.00	36.07	32.52	30.31	8.12	46.40	54.00	-7.60	Average	Vertical

Channel 78 / 2480 MHz

Freq. MHz	Reading dBuV	Ant. Fac. dB/m	Pre. Fac. dB	Cab. Loss dB	Measured dBuV/m	Limit dBuV/m	Margin dB	Remark	Pol.
4960.00	50.32	32.68	30.27	7.88	60.61	74.00	-13.39	Peak	Horizontal
4960.00	35.12	32.68	30.27	7.88	45.41	54.00	-8.59	Average	Horizontal
4960.00	49.46	32.68	30.27	7.88	59.75	74.00	-14.25	Peak	Vertical
4960.00	32.43	32.68	30.27	7.88	42.72	54.00	-11.28	Average	Vertical

Notes:

- 1). Measuring frequencies from 9 KHz~10th harmonic or 26.5GHz (which is less), No emission found between lowest internal used/generated frequency to 30MHz.
- 2). Radiated emissions measured in frequency range from 9 KHz~10th harmonic or 26.5GHz (which is less) were made with an instrument using Peak detector mode.
- 3). Data of measurement within this frequency range shown " --- " in the table above means the reading of emissions are attenuated more than 20dB below the permissible limits or the field strength is too small to be measured.
- 4). Measured= Reading- Pre. Fac.+ Ant. Fac.+ Cab. Loss
- 5). Margin = Measured- Limit

4.3. Maximum Peak Output Power

TEST CONFIGURATION

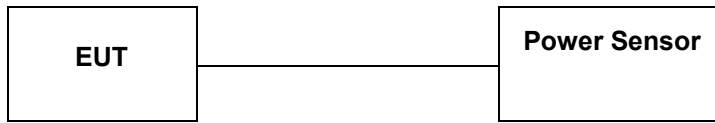

TEST PROCEDURE

According to ANSI C63.10:2013 Maximum peak conducted output power for HFSS devices:
 The maximum peak conducted output power may be measured using a broadband peak RF power meter. The power meter shall have a video bandwidth that is greater than or equal to the HFSS bandwidth and shall utilize a fast-responding diode detector.
 The maximum Average conducted output power may be measured using a wideband RF power meter with a thermocouple derector or equivalent. The power meter shall have a video bandwidth that is greater than or equal to the HFSS bandwidth and shall utilize a fast-responding diode detector.

LIMIT

For frequency hopping systems operating in the 2400–2483.5 MHz band employing at least 75 non-overlapping hopping channels, and all frequency hopping systems in the 5725–5850 MHz band: 1 watt. For all other frequency hopping systems in the 2400–2483.5 MHz band: 0.125 watts.

TEST RESULTS

Temperature	24.2°C	Humidity	54.9%
Test Engineer	Oliver Ou	Configurations	BT

Modulation	Channel	Peak Output power (dBm)	Limit (dBm)	Result
GFSK	00	5.86	30	Pass
	39	5.73		
	78	5.78		
π/4-DQPSK	00	4.61	21	Pass
	39	4.16		
	78	4.86		
8DPSK	00	4.31	21	Pass
	39	4.78		
	78	4.35		

Note: The test results including the cable lose.

4.4. 20dB Bandwidth

TEST CONFIGURATION

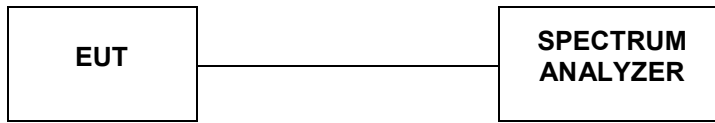

TEST PROCEDURE

The transmitter output was connected to the spectrum analyzer through an attenuator. The bandwidth of the fundamental frequency was measured by spectrum analyzer with RBW=30KHz and VBW=100KHz. The 20dB bandwidth is defined as the total spectrum the power of which is higher than peak power minus 20dB.

LIMIT

For frequency hopping systems operating in the 2400MHz-2483.5MHz no limit for 20dB bandwidth.

TEST RESULTS

Temperature	24.2°C	Humidity	54.9%
Test Engineer	Oliver Ou	Configurations	BT

Modulation	Frequency	20dB Bandwidth (MHz)	Result
GFSK	2402 MHz	0.933	PASS
	2441 MHz	0.954	PASS
	2480 MHz	0.954	PASS
π/4-DQPSK	2402 MHz	1.326	PASS
	2441 MHz	1.326	PASS
	2480 MHz	1.293	PASS
8-DPSK	2402 MHz	1.275	PASS
	2441 MHz	1.266	PASS
	2480 MHz	1.278	PASS

Test plot as follows:



8-DPSK

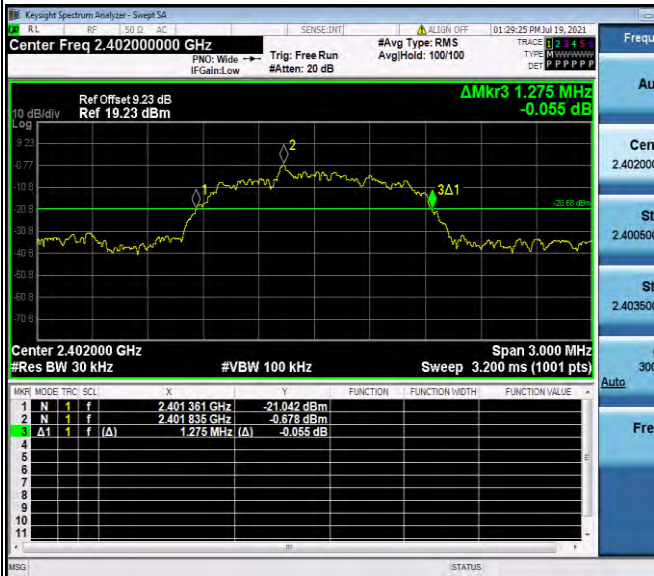

CH00

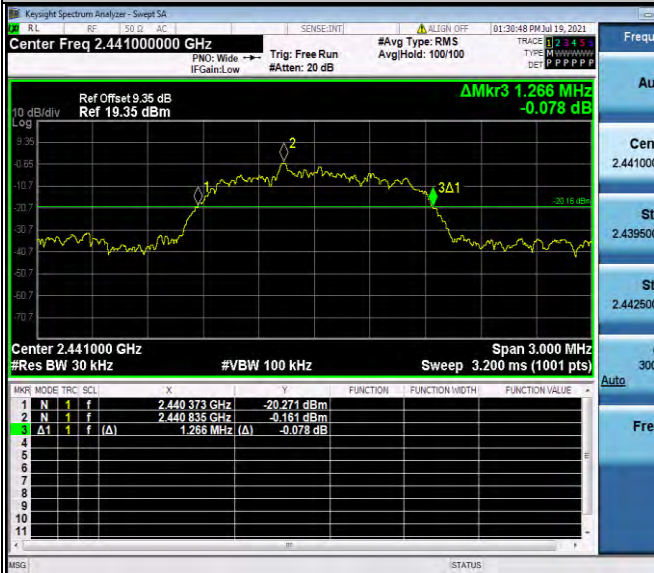

CH39



CH78

4.5. Frequency Separation

TEST CONFIGURATION

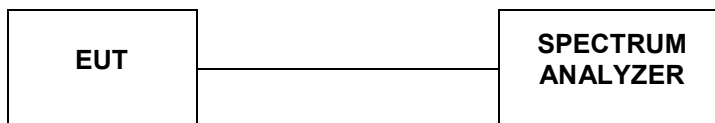

TEST PROCEDURE

The transmitter output was connected to the spectrum analyzer through an attenuator. The bandwidth of the fundamental frequency was measured by spectrum analyzer with RBW=100KHz and VBW=300KHz.

LIMIT

According to 15.247(a)(1), frequency hopping systems shall have hopping channel carrier frequencies separated by minimum of 25KHz or the $\frac{2}{3} \times 20\text{dB}$ bandwidth of the hopping channel, whichever is greater.

TEST RESULTS

Temperature	24.2°C	Humidity	54.9%
Test Engineer	Oliver Ou	Configurations	BT

Modulation	Channel	Ch. Separation (MHz)	Limit (MHz)	Result
GFSK	Hopping	0.980	≥ 0.954	Complies
$\pi/4$ -DQPSK	Hopping	0.978	≥ 0.884	Complies
8-DPSK	Hopping	1.004	≥ 0.852	Complies

Ch. Separation Limits: $> \frac{2}{3}$ of 20dB bandwidth



4.6. Band Edge Compliance of RF Emission

TEST REQUIREMENT

In any 100 kHz bandwidth outside the frequency band in which the spread spectrum or digitally modulated intentional radiator is operating, the radio frequency power that is produced by the intentional radiator shall be at least 20 dB below that in the 100 kHz bandwidth within the band that contains the highest level of the desired power, based on either an RF conducted or a radiated measurement, provided the transmitter demonstrates compliance with the peak conducted power limits. If the transmitter complies with the conducted power limits based on the use of RMS averaging over a time interval, as permitted under paragraph (b)(3) of this section, the attenuation required under this paragraph shall be 30 dB instead of 20 dB. Attenuation below the general limits specified in §15.209(a) is not required. In addition, radiated emissions which fall in the restricted bands, as defined in §15.205(a), must also comply with the radiated emission limits specified in §15.209(a) (see §15.205(c)).

TEST CONFIGURATION

For Radiated

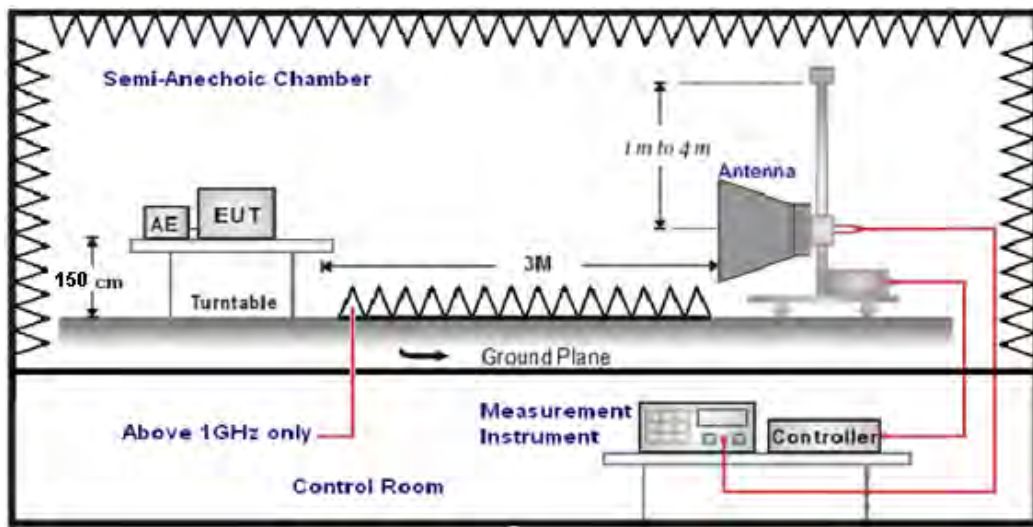

For Conducted

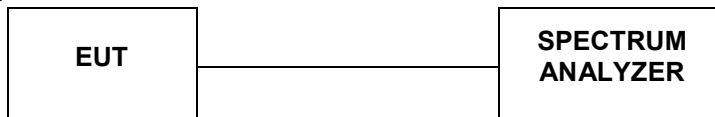

TEST PROCEDURE

1. The EUT was placed on a turn table which is 1.5m above ground plane.
2. Maximum procedure was performed by raising the receiving antenna from 1m to 4m and rotating the turn table from 0° to 360° to acquire the highest emissions from EUT.
3. And also, each emission was to be maximized by changing the polarization of receiving antenna both horizontal and vertical.
4. Repeat above procedures until all frequency measurements have been completed..
5. The distance between test antenna and EUT was 3 meter:
6. Setting test receiver/spectrum as following table states:

Test Frequency range	Test Receiver/Spectrum Setting	Detector
1GHz-40GHz	Peak Value: RBW=1MHz/VBW=3MHz, Sweep time=Auto Average Value: RBW=1MHz/VBW=10Hz, Sweep time=Auto	Peak

LIMIT

Below -20dB of the highest emission level in operating band.
Radiated emissions which fall in the restricted bands, as defined in § 15.205(a), must also comply with the radiated emission limits specified in § 15.209(a)

TEST RESULTS

Remark: we measured all conditions(DH1,DH3,DH5) and recorded worst case at DH5.

4.6.1 For Radiated Bandedge Measurement

Remark: we tested radiated bandedge at both hopping and no-hopping modes,recorded worst case at no-hopping mode

Temperature	23.8°C	Humidity	53.7%
Test Engineer	Oliver Ou	Configurations	BT

GFSK

Frequency(MHz):			2402			Polarity:			HORIZONTAL		
Frequency (MHz)	Emission Level (dBuV/m)		Limit (dBuV/m)	Margin (dB)	Antenna Height (m)	Table Angle (Degree)	Raw Value (dBuV)	Antenna Factor (dB/m)	Cable Factor (dB)	Pre-amplifier	Correction Factor (dB/m)
2390.00	45.37	PK	74	-28.63	1	177	50.68	27.49	3.32	36.12	-5.31
2390.00	34.47	AV	54	-19.53	1	177	39.78	27.49	3.32	36.12	-5.31
Frequency(MHz):			2402			Polarity:			VERTICAL		
Frequency (MHz)	Emission Level (dBuV/m)		Limit (dBuV/m)	Margin (dB)	Antenna Height (m)	Table Angle (Degree)	Raw Value (dBuV)	Antenna Factor (dB/m)	Cable Factor (dB)	Pre-amplifier	Correction Factor (dB/m)
2390.00	45.87	PK	74	-28.13	1	235	51.18	27.49	3.32	36.12	-5.31
2390.00	34.11	AV	54	-19.89	1	235	39.42	27.49	3.32	36.12	-5.31
Frequency(MHz):			2480			Polarity:			HORIZONTAL		
Frequency (MHz)	Emission Level (dBuV/m)		Limit (dBuV/m)	Margin (dB)	Antenna Height (m)	Table Angle (Degree)	Raw Value (dBuV)	Antenna Factor (dB/m)	Cable Factor (dB)	Pre-amplifier	Correction Factor (dB/m)
2483.50	48.29	PK	74	-25.71	1	163	54.01	27.45	3.38	36.55	-5.72
2483.50	36.44	AV	54	-17.56	1	163	42.16	27.45	3.38	36.55	-5.72
Frequency(MHz):			2480			Polarity:			VERTICAL		
Frequency (MHz)	Emission Level (dBuV/m)		Limit (dBuV/m)	Margin (dB)	Antenna Height (m)	Table Angle (Degree)	Raw Value (dBuV)	Antenna Factor (dB/m)	Cable Factor (dB)	Pre-amplifier	Correction Factor (dB/m)
2483.50	49.30	PK	74	-24.70	1	57	55.02	27.45	3.38	36.55	-5.72
2483.50	35.58	AV	54	-18.42	1	57	41.30	27.45	3.38	36.55	-5.72

REMARKS:

1. Emission level (dBuV/m) =Raw Value (dBuV)+Correction Factor (dB/m)
2. Correction Factor (dB/m) = Antenna Factor (dB/m)+Cable Factor (dB)-Pre-amplifier Factor
3. Margin value = Limit value- Emission level.
4. -- Mean the PK detector measured value is below average limit.
5. The other emission levels were very low against the limit.

4.6.2 For Conducted Bandedge Measurement

Temperature	24.2°C	Humidity	54.9%
Test Engineer	Oliver Ou	Configurations	BT

Band-edge for RF conducted emissions
GFSK

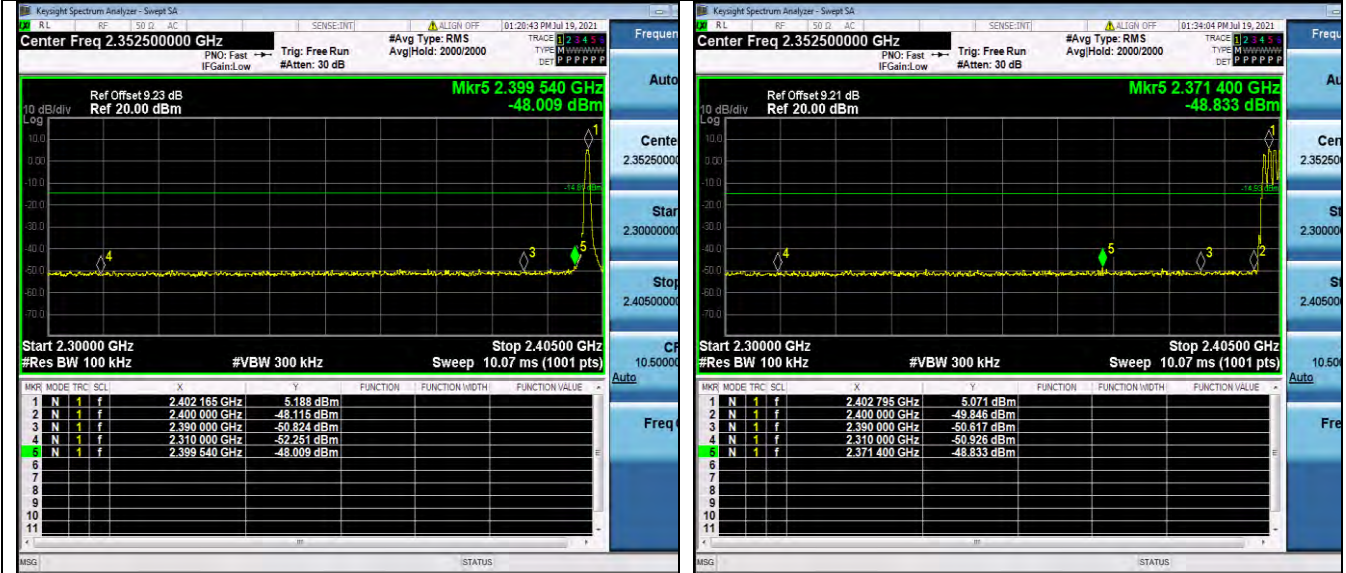

Channel 0 / 2402 MHz – Non-Hopping

Channel 0 / 2402 MHz – Hopping

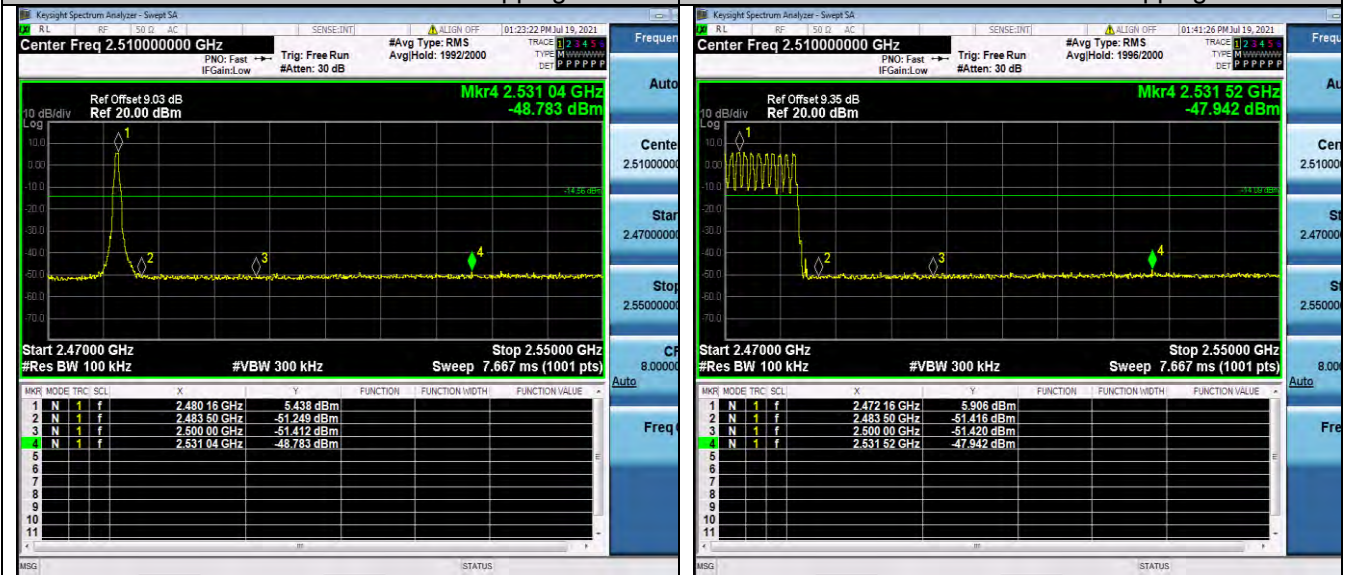

Channel 78 / 2480 MHz – Non-Hopping

Channel 78 / 2480 MHz – Hopping

Band-edge for RF conducted emissions
 $\pi/4$ -DQPSK

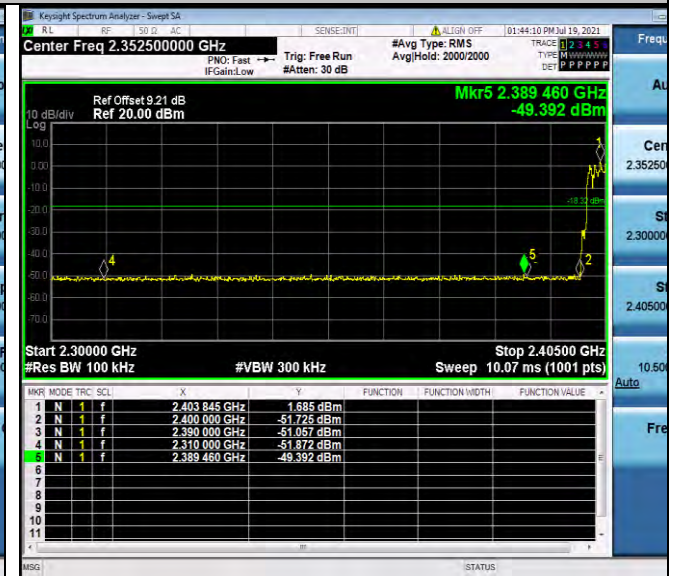
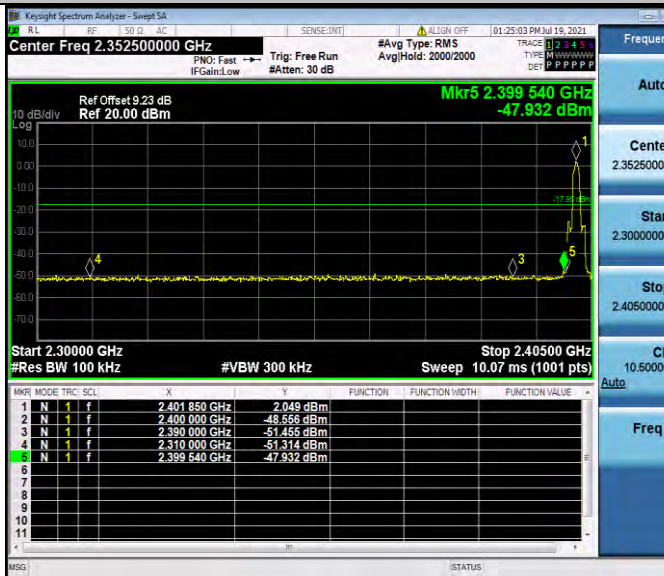

Channel 0 / 2402 MHz – Non-Hopping

Channel 0 / 2402 MHz – Hopping

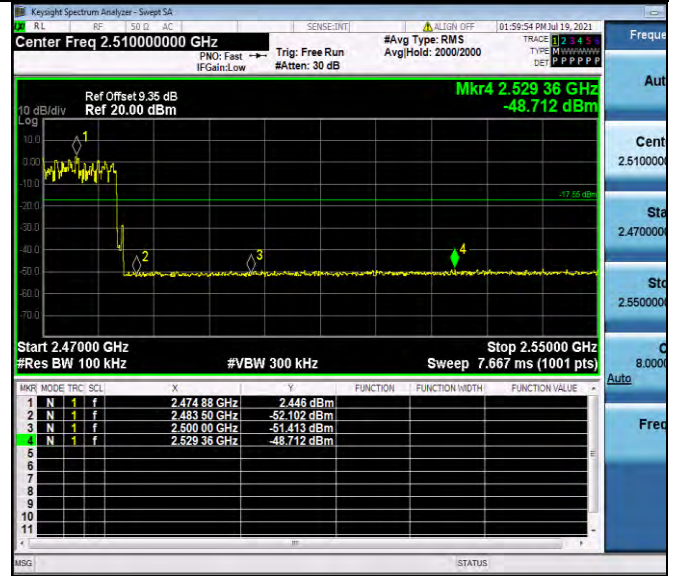
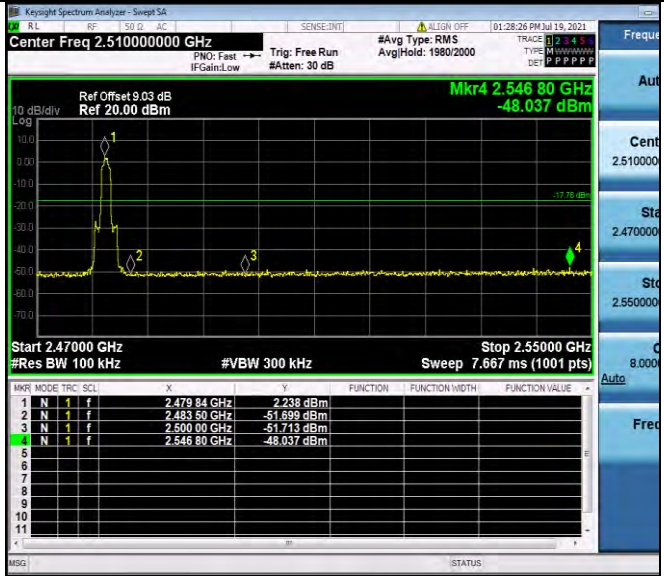

Channel 78 / 2480 MHz – Non-Hopping

Channel 78 / 2480 MHz – Hopping

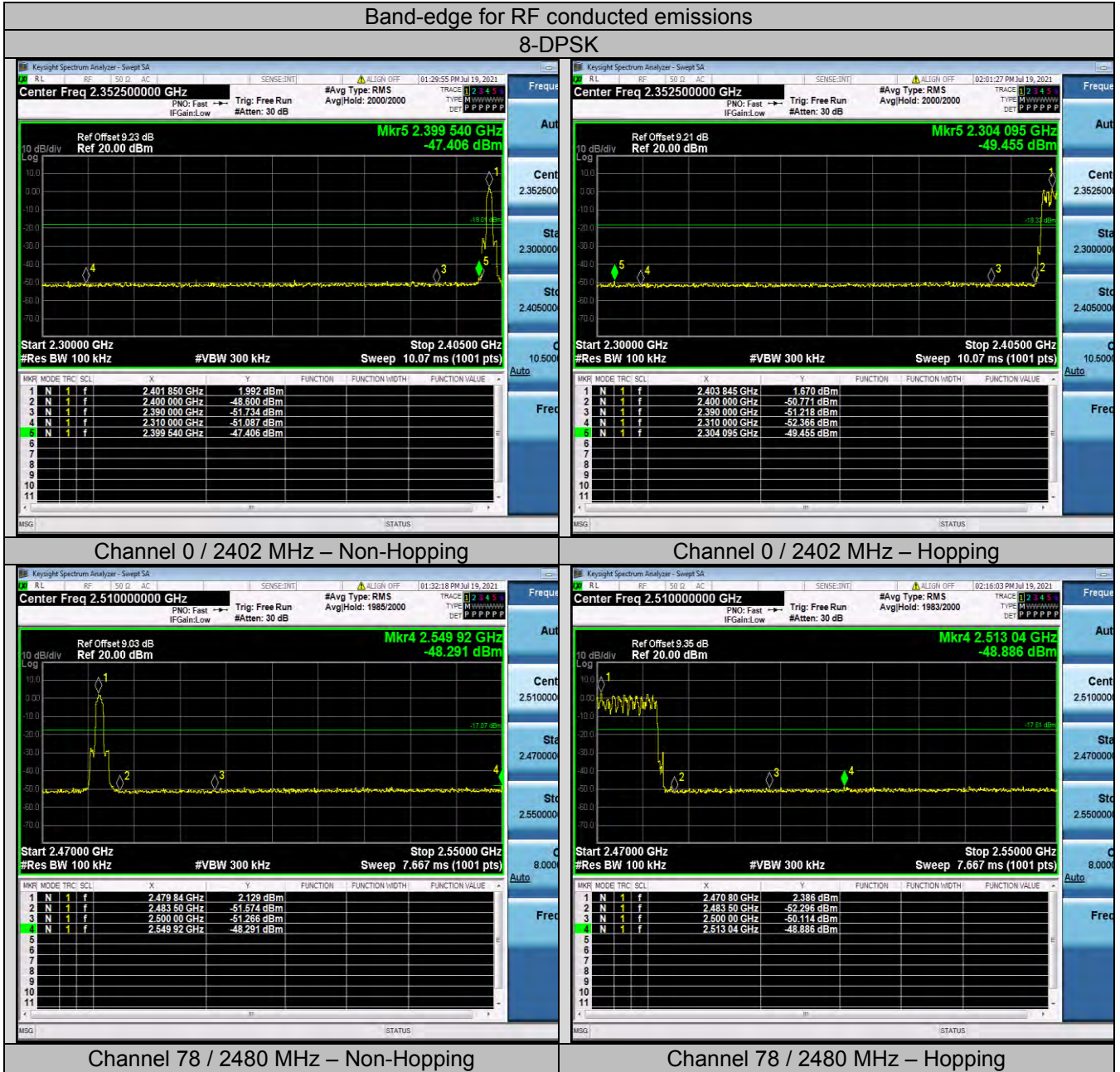

NOTE: Hopping enabled and disabled have evaluated, and the worst data was reported.

4.7. Number of hopping frequency

TEST CONFIGURATION

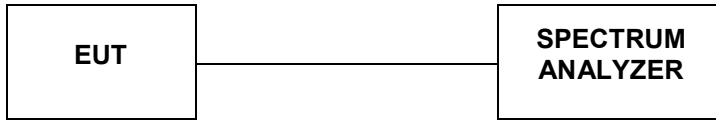

TEST PROCEDURE

The transmitter output was connected to the spectrum analyzer through an attenuator. Set spectrum analyzer start 2400MHz to 2483.5MHz with RBW=100KHz and VBW=300KHz.

LIMIT

Frequency hopping systems in the 2400–2483.5MHz band shall use at least 15 channels.

Temperature	24.2°C	Humidity	54.9%
Test Engineer	Oliver Ou	Configurations	BT

Modulation	Number of Hopping Channel	Limit	Result
GFSK	79	≥15	Pass
$\pi/4$ -DQPSK	79	≥15	Pass
8DPSK	79	≥15	Pass

Number of hopping frequency

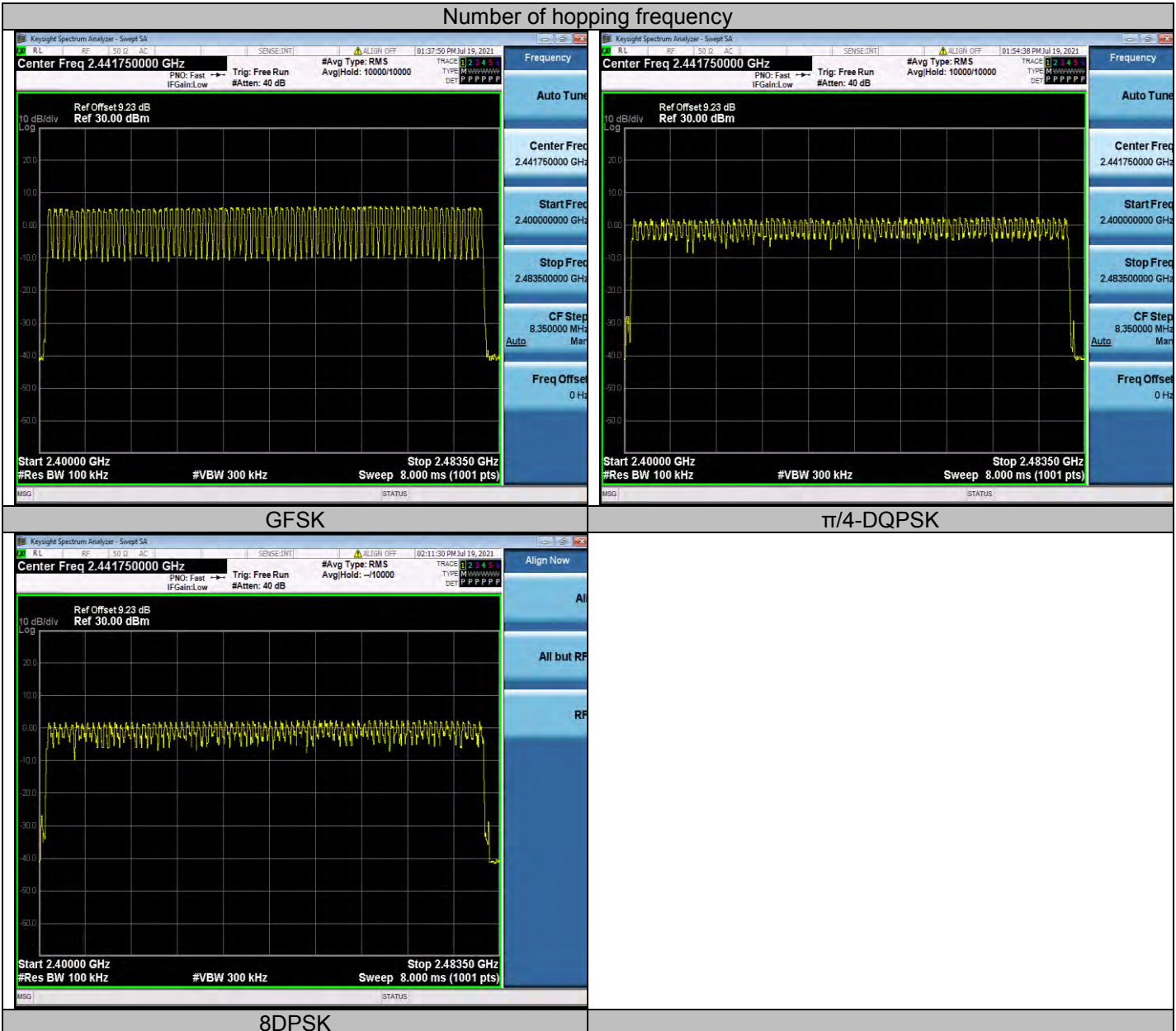

4.8. Time Of Occupancy(Dwell Time)

TEST CONFIGURATION

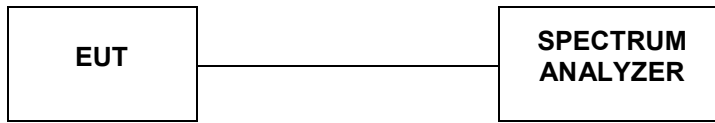

TEST PROCEDURE

The transmitter output was connected to the spectrum analyzer through an attenuator. Set center frequency of spectrum analyzer=operating frequency with RBW=1MHz and VBW=3MHz,Span=0Hz.

LIMIT

The average time of occupancy on any channel shall not be greater than 0.4 seconds within a pe-riod of 0.4 seconds multiplied by the number of hopping channels employed.

TEST RESULTS

Temperature	24.2°C	Humidity	54.9%
Test Engineer	Oliver Ou	Configurations	BT

Modulation	Data Packet	Frequency	Pulse Duration	Dwell Time	Limits
			(ms)	(s)	(s)
GFSK	DH1	2441 MHz	0.37	0.12	0.40
	DH3	2441 MHz	1.63	0.26	0.40
	DH5	2441 MHz	2.88	0.31	0.40
π/4-DQPSK	2DH1	2441 MHz	0.38	0.12	0.40
	2DH3	2441 MHz	1.63	0.26	0.40
	2DH5	2441 MHz	2.88	0.31	0.40
8-DPSK	3DH1	2441 MHz	0.38	0.12	0.40
	3DH3	2441 MHz	1.63	0.26	0.40
	3DH5	2441 MHz	2.88	0.31	0.40

The Dwell Time=Burst Width*Total Hops. The detailed calculations are showed as follows:
 The duration for dwell time calculation: $0.4[s]*\text{hopping number}=0.4[s]*79[\text{ch}]=31.6[s*\text{ch}]$;
 The burst width [ms/hop/ch], which is directly measured, refers to the duration on one channel hop.
 The hops per second for all channels: The selected EUT Conf uses a slot type of 5-Tx&1-Rx and a hopping rate of 1600 [ch*hop/s] for all channels. So the final hopping rate for all channels is $1600/6=266.67 [\text{ch}*\text{hop}/\text{s}]$
 The hops per second on one channel: $266.67 [\text{ch}*\text{hops}/\text{s}]/79 [\text{ch}]=3.38 [\text{hop}/\text{s}]$;
 The total hops for all channels within the dwell time calculation duration: $3.38 [\text{hop}/\text{s}]*31.6[s*\text{ch}]=106.67 [\text{hop}*\text{ch}]$;
 The dwell time for all channels hopping: $106.67 [\text{hop}*\text{ch}]*\text{Burst Width} [\text{ms}/\text{hop}/\text{ch}]$.

Remark:

1. Test results including cable loss;
2. Measured at difference Packet Type for each mode and recorded worst case for each mode.
3. Dwell Time Calculate formula:
 DH1 Dwell time=Pulse Time (ms) × (1600 ÷ 2 ÷ 79) ×31.6 Second
 DH3: Dwell time=Pulse Time (ms) × (1600 ÷ 4 ÷ 79) ×31.6 Second
 DH5: Dwell time=Pulse Time (ms) × (1600 ÷ 6 ÷ 79) ×31.6 Second

Test plot as follows:

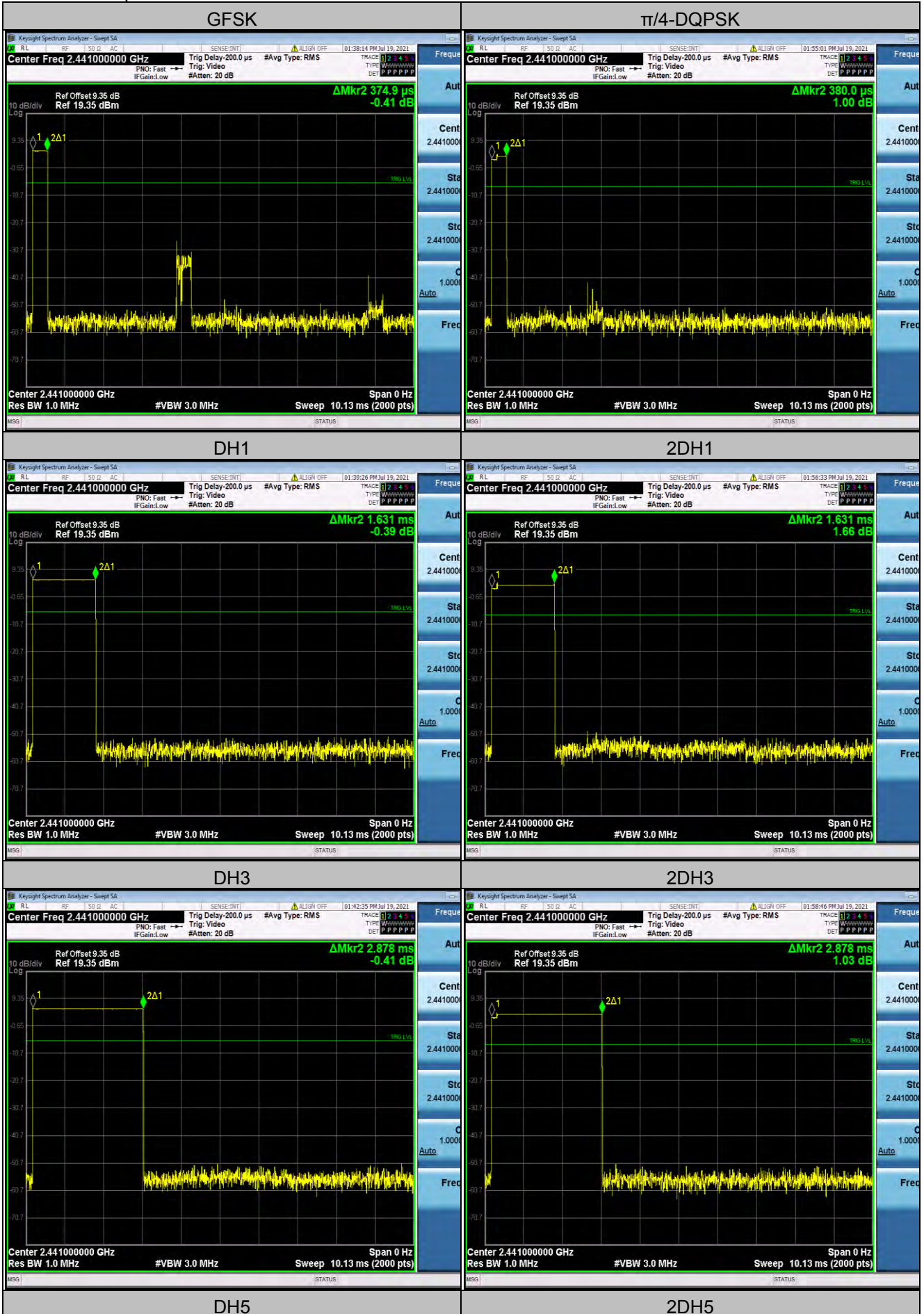

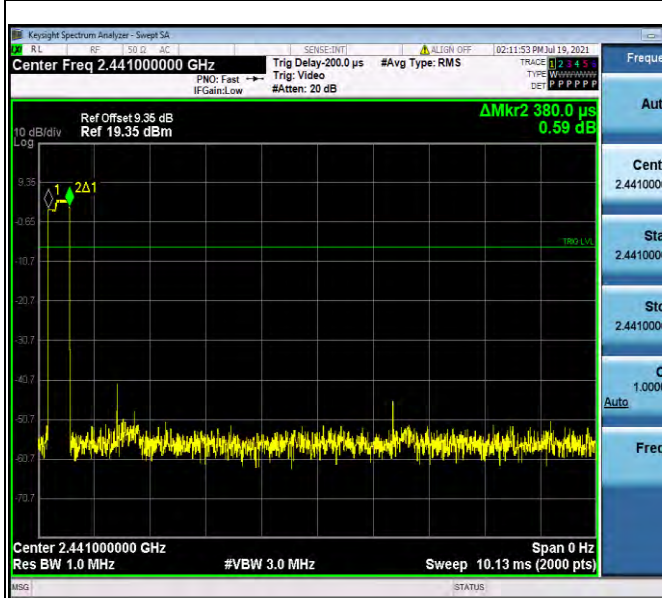
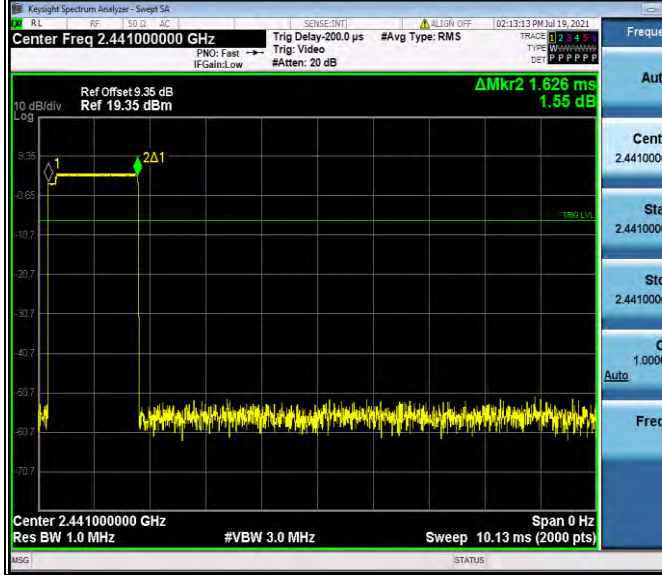
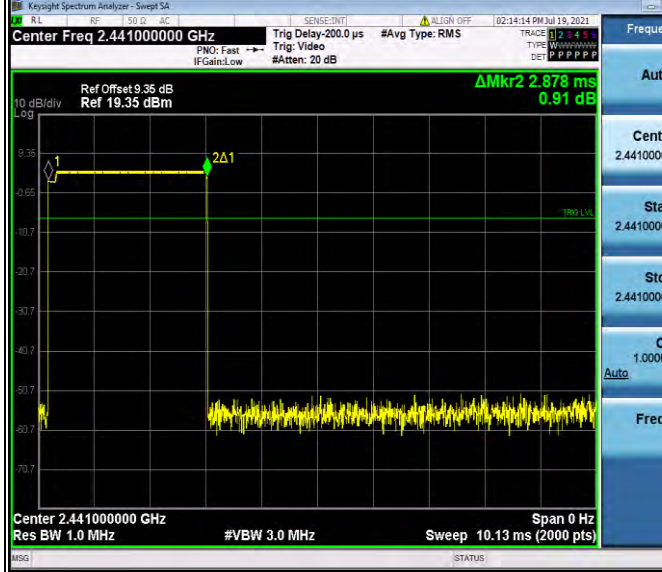
8-DPSK	
 <p>Center Freq 2.441000000 GHz Ref Offset 9.35 dB Ref 19.35 dBm ΔMkr2 380.0 μs 0.59 dB Center 2.441000000 GHz Res BW 1.0 MHz #VBW 3.0 MHz Sweep 10.13 ms (2000 pts)</p>	
3DH1	
 <p>Center Freq 2.441000000 GHz Ref Offset 9.35 dB Ref 19.35 dBm ΔMkr2 1.626 ms 1.55 dB Center 2.441000000 GHz Res BW 1.0 MHz #VBW 3.0 MHz Sweep 10.13 ms (2000 pts)</p>	
3DH3	
 <p>Center Freq 2.441000000 GHz Ref Offset 9.35 dB Ref 19.35 dBm ΔMkr2 2.878 ms 0.91 dB Center 2.441000000 GHz Res BW 1.0 MHz #VBW 3.0 MHz Sweep 10.13 ms (2000 pts)</p>	
3DH5	

4.9. Pseudorandom Frequency Hopping Sequence

TEST APPLICABLE

For 47 CFR Part 15C section 15.247 (a)(1) requirement:

Frequency hopping systems shall have hopping channel carrier frequencies separated by a minimum of 25 kHz or the 20 dB bandwidth of the hopping channel, whichever is greater. Alternatively, frequency hopping systems operating in the 2400–2483.5 MHz band may have hopping channel carrier frequencies that are separated by 25 kHz or two-thirds of the 20 dB bandwidth of the hopping channel, whichever is greater, provided the systems operate with an output power no greater than 125 mW. The system shall hop to channel frequencies that are selected at the system hopping rate from a pseudo randomly ordered list of hopping frequencies. Each frequency must be used equally on the average by each transmitter. The system receivers shall have input bandwidths that match the hopping channel bandwidths of their corresponding transmitters and shall shift frequencies in synchronization with the transmitted signals.

EUT Pseudorandom Frequency Hopping Sequence Requirement

The pseudorandom frequency hopping sequence may be generated in a nine-stage shift register whose 5th and 9th stage outputs are added in a modulo-two addition stage. And the result is fed back to the input of the first stage. The sequence begins with the first one of 9 consecutive ones, for example: the shift register is initialized with nine ones.

- Number of shift register stages:9
- Length of pseudo-random sequence:29-1=511 bits
- Longest sequence of zeros:8(non-inverted signal)

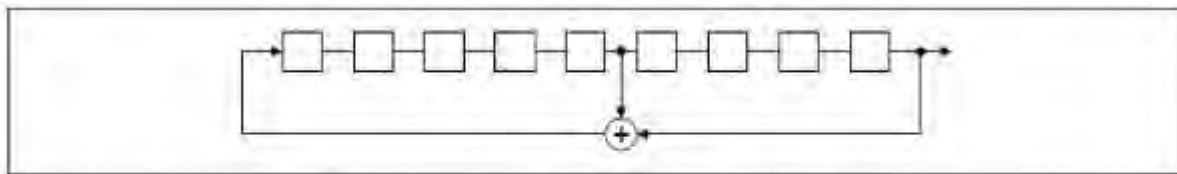

Linear Feedback Shift Register for Generation of the PRBS sequence

An example of pseudorandom frequency hopping sequence as follows:

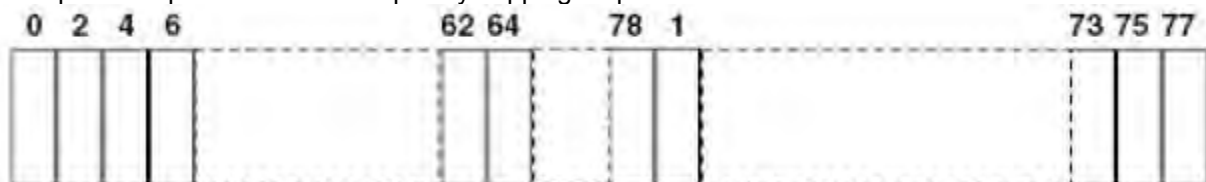

Each frequency used equally one the average by each transmitter. The system receiver have input bandwidths that match the hopping channel bandwidths of their corresponding transmitter and shift frequencies in synchronization with the transmitted signals.

4.10. Antenna Requirement

Standard Applicable

For intentional device, according to FCC 47 CFR Section 15.203, an intentional radiator shall be designed to ensure that no antenna other than that furnished by the responsible party shall be used with the device.

And according to FCC 47 CFR Section 15.247 (c), if transmitting antennas of directional gain greater than 6dBi are used, the power shall be reduced by the amount in dB that the directional gain of the antenna exceeds 6dBi.

Test Result

The antenna used for this product is Internal Antenna and that no antenna other than that furnished by the responsible party shall be used with the device, the maximum peak gain of the transmit antenna is only 0.3dBi.

Reference to the **Internal photos**.

5. TEST SETUP PHOTOS OF THE EUT

Photo of Radiated Emissions Measurement



Fig. 1



Fig. 2

Photo of Conducted Emission Measurement



Fig. 3

6. EXTERNAL AND INTERNAL PHOTOS OF THE EUT



Fig. 1



Fig. 2



Fig. 3



Fig. 4



Fig. 5



Fig. 6

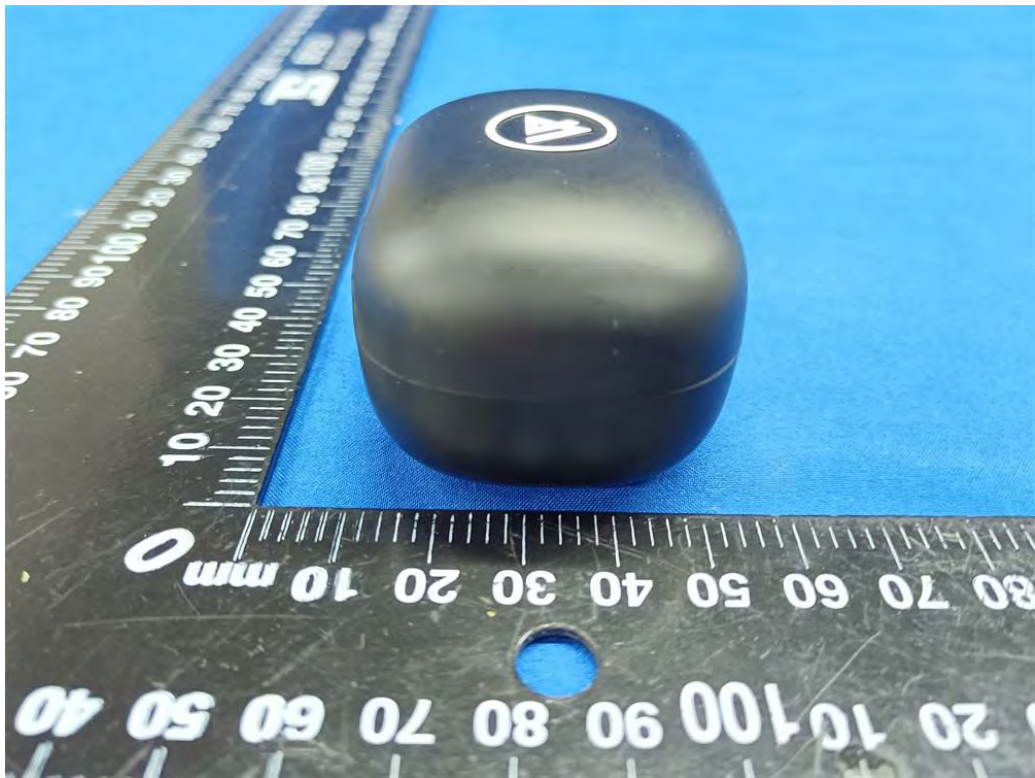

Fig. 7



Fig. 8



Fig. 9

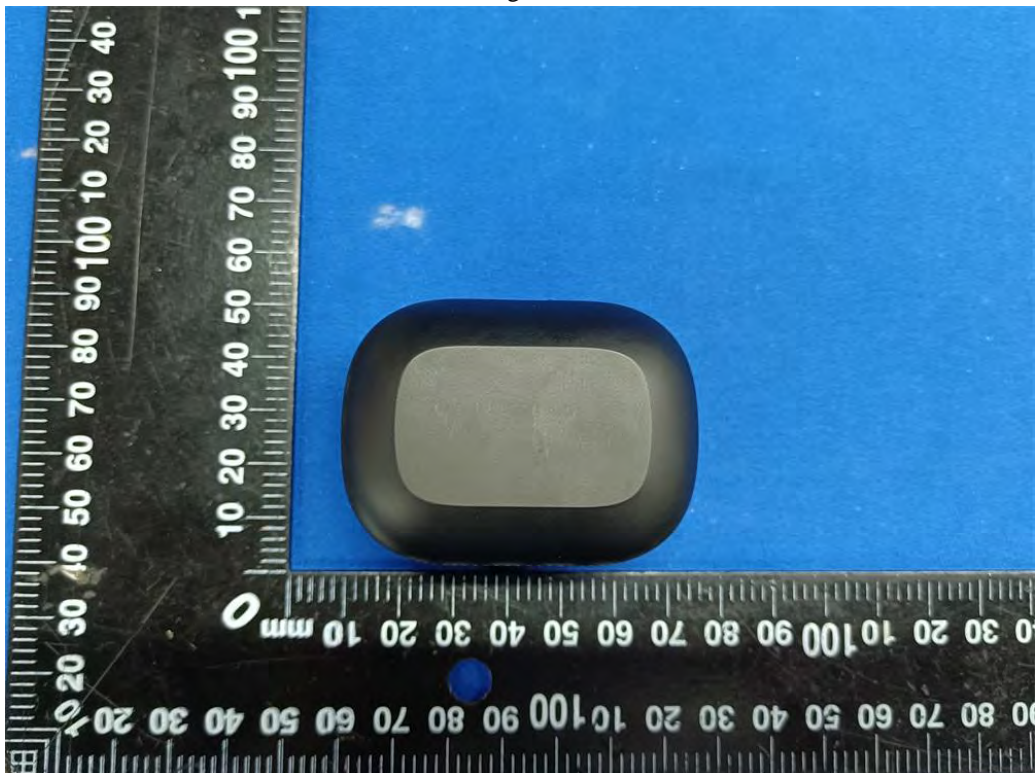

Fig. 10



Fig. 11

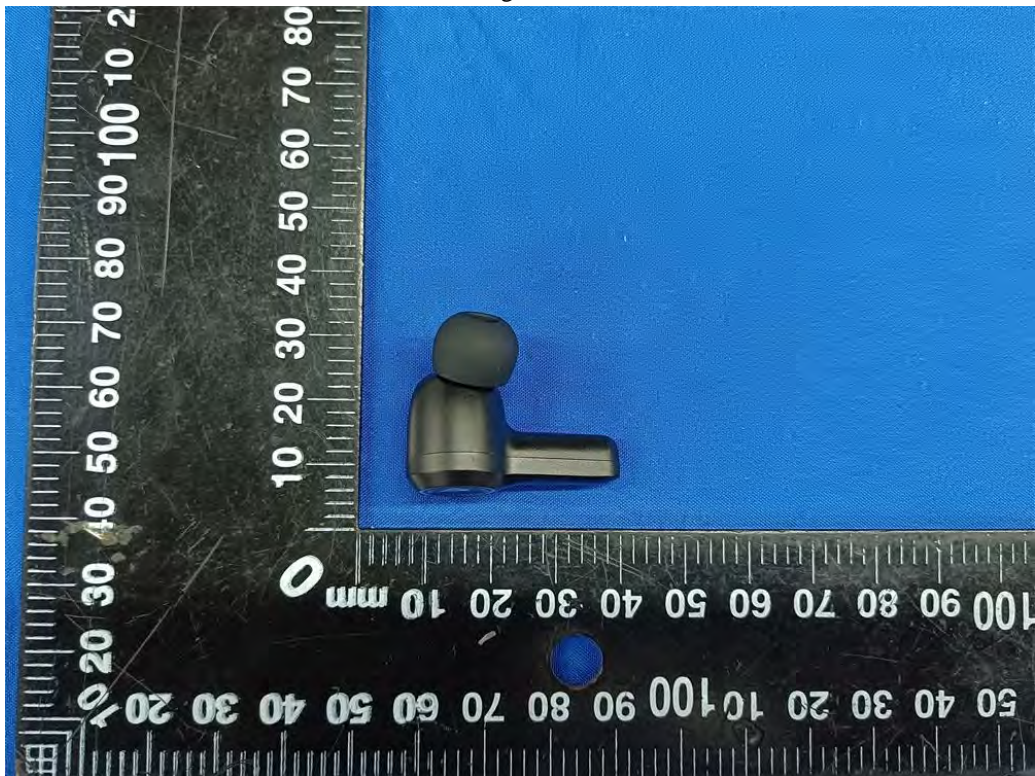

Fig. 12

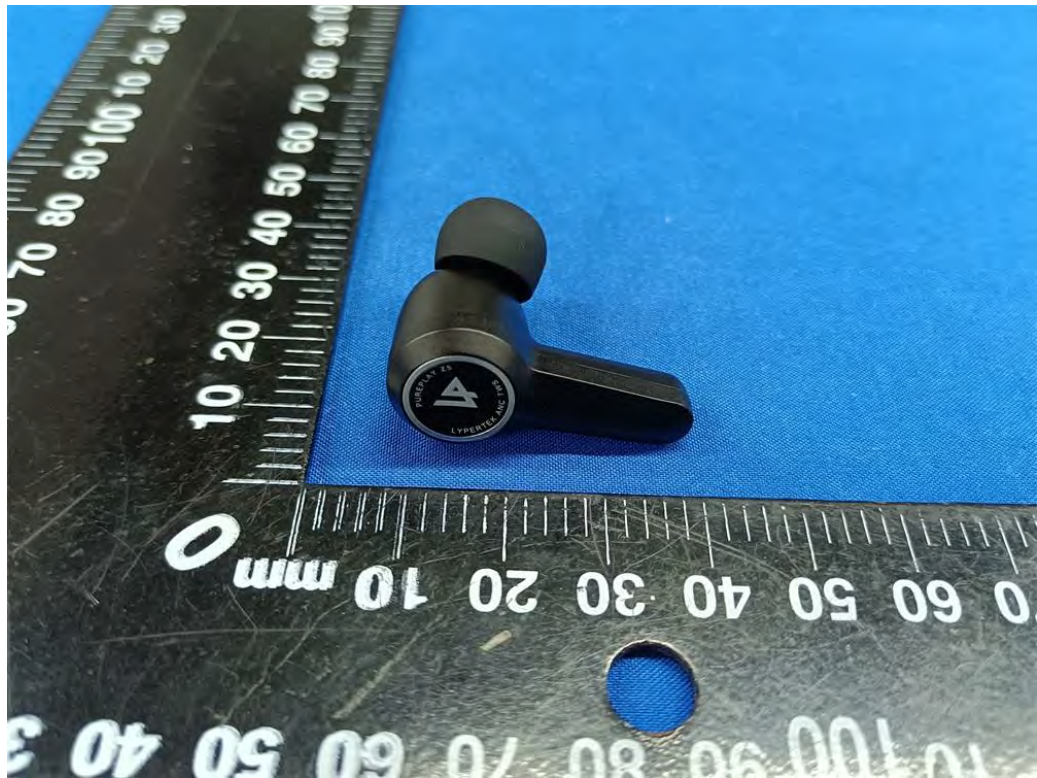

Fig. 13



Fig. 14



Fig. 15



Fig. 16



Fig. 17



Fig. 18



Fig. 19



Fig. 20

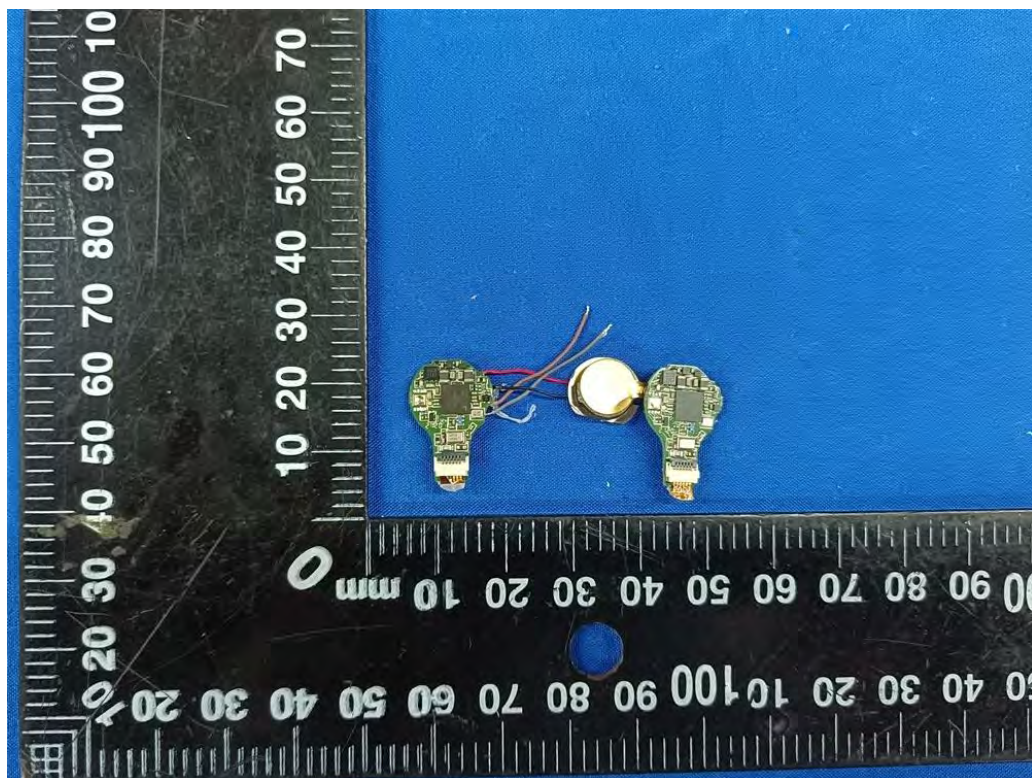

Fig. 21

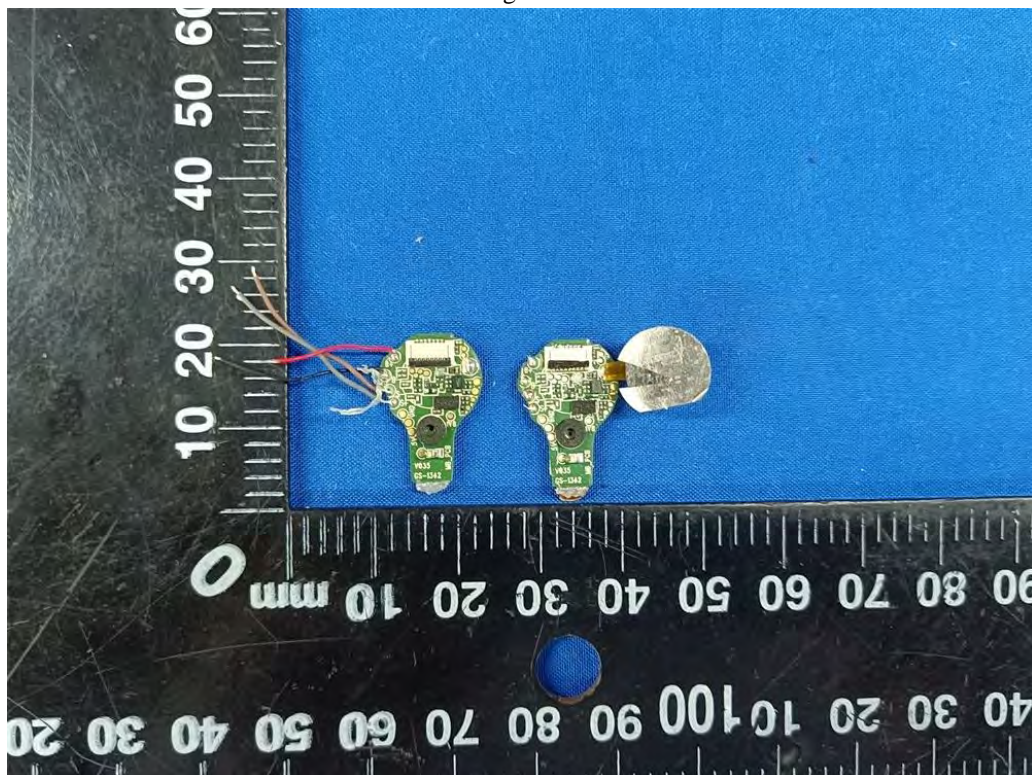

Fig. 22

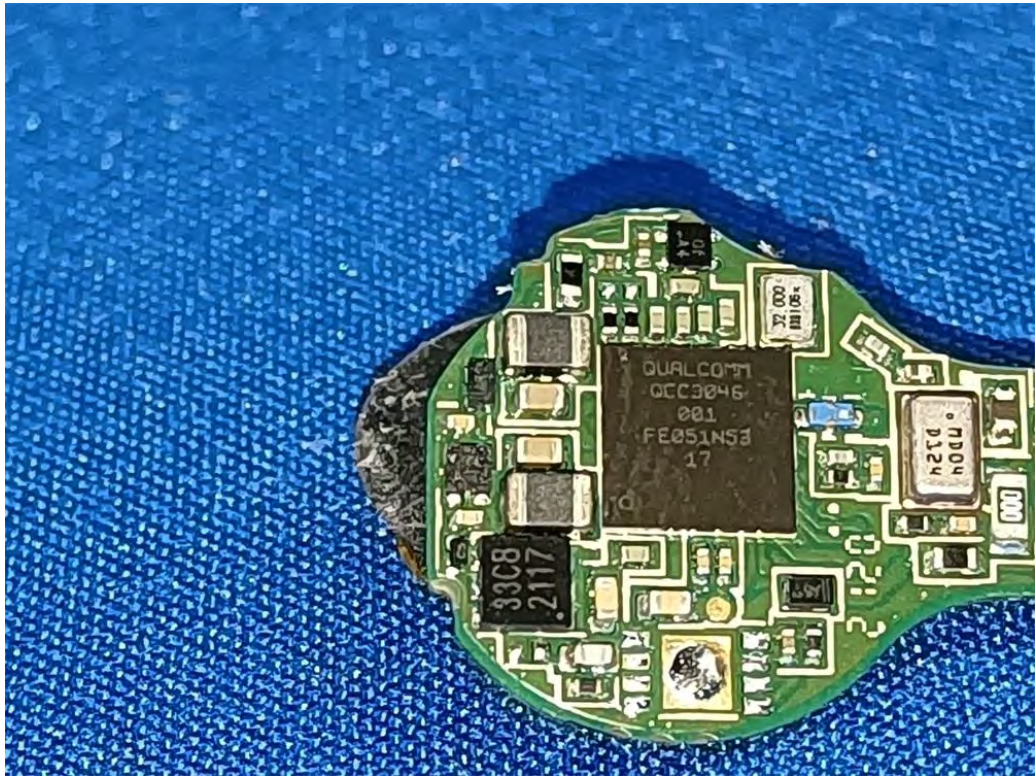

Fig. 23

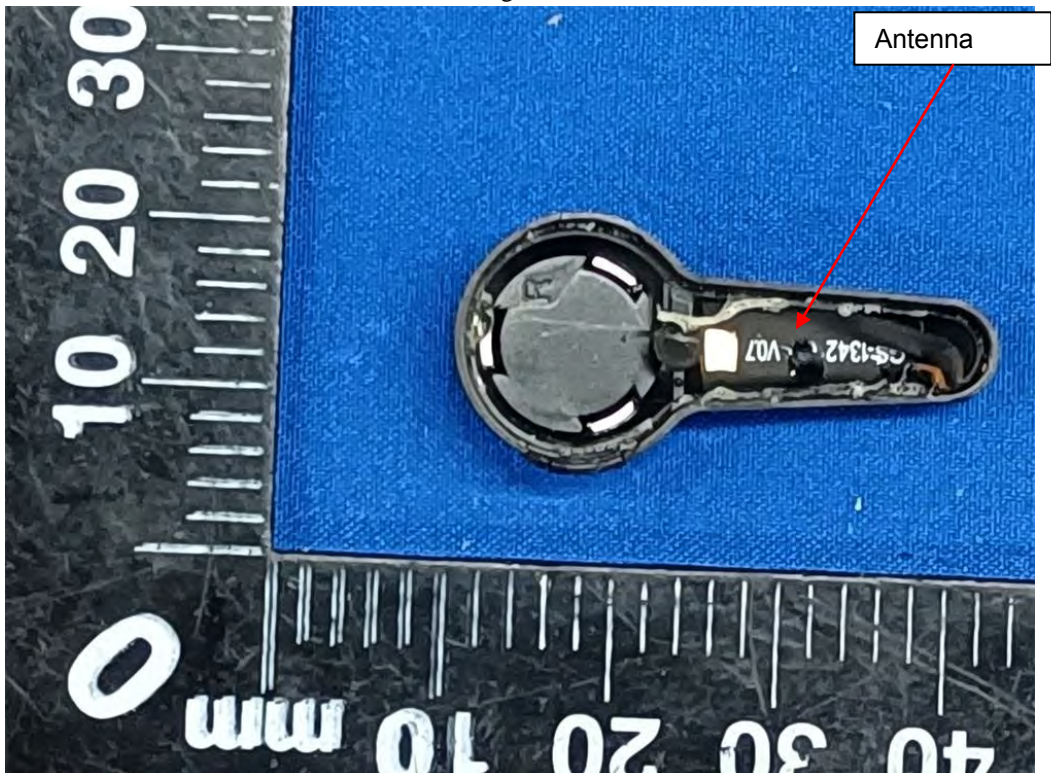

Fig. 24

.....End of Report.....