

TEST REPORT

Product Name: Wireless Charger Table Light
FCC ID: 2AW95LM459
Trademark: N/A
Model Number: LM459
Prepared For: SPRING SUNSHINE TECHNOLOGY CO., LIMITED
Address: FLAT/RM 01-04, 24/F, FU FAI COMMERCIAL CENTRE, 27 HILLIER STREET, SHEUNG WAN, HK
Manufacturer: SPRING SUNSHINE TECHNOLOGY CO., LIMITED
Address: FLAT/RM 01-04, 24/F, FU FAI COMMERCIAL CENTRE, 27 HILLIER STREET, SHEUNG WAN, HK
Prepared By: Shenzhen CTB Testing Technology Co., Ltd.
Address: Floor 1&2, Building A, No. 26 of Xinhe Road, Xinqiao Community, Xinqiao Street, Baoan District, Shenzhen, Guangdong China
Sample Received Date: Feb. 17, 2022
Sample tested Date: Feb. 17, 2022 to Feb. 24, 2022
Issue Date: Feb. 24, 2022
Report No.: CTB220223025RFX
Test Standards: FCC Part 15 C
Test Results: PASS
Remark: This is wireless charger radio test report.

Compiled by:

Arron Liu

Arron Liu

Reviewed by:

Bin Mei

Bin Mei

Approved by:



Rita Xiao / Director

The test report is effective only with both signature and specialized stamp. This result(s) shown in this report refer only to the sample(s) tested. Without written approval of Shenzhen CTB Testing Technology Co., Ltd. this report can't be reproduced except in full. The tested sample(s) and the sample information are provided by the client.

TABLE OF CONTENTS

1.GENERAL INFORMATION	3
1.1. Report information.....	3
1.2. Measurement Uncertainty.....	3
1.3. Test Facility.....	3
1.4. Test Uncertainty.....	4
2.PRODUCT DESCRIPTION	5
2.1. EUT Description.....	5
2.2. Block Diagram of EUT Configuration.....	5
2.3. Test Conditions.....	5
2.4. Description Of Support Units (Conducted Mode).....	6
3.TEST RESULTS SUMMARY	6
4.TEST EQUIPMENT USED.....	7
4.1. MEASUREMENT INSTRUMENTS LIST.....	7
5.CONDUCTED EMISSION TEST.....	9
5.1. Block Diagram of Test Setup.....	9
5.2. Test Standard.....	9
5.3. Conducted Emission Limit.....	9
5.4. EUT Configuration on Test.....	9
5.5. Operating Condition of EUT.....	10
5.6. Test Procedure.....	10
5.7. Test Result.....	10
6.RADIATED EMISSION MEASUREMENT	13
6.1. Block Diagram of Test Setup.....	13
6.2. Test Standard.....	14
6.3. EMI Test Receiver Setup.....	14
6.4. Test Procedure.....	14
6.5. Test Result.....	14
7.OCCUPIED BANDWIDTH	18
7.1. Block Diagram of Test Setup.....	18
7.2. Rules and specifications.....	18
7.3. Test Procedure.....	18
7.4. Test Result.....	18
8.EUT TEST PHOTOS.....	20
9.EUT PHOTOS.....	22

1. GENERAL INFORMATION

1.1. Report information

- 1.1.1. This report is not a certificate of quality; it only applies to the sample of the specific product/equipment given at the time of its testing. The results are not used to indicate or imply that they are application to the similar items. In addition, such results must not be used to indicate or imply that CTB approves recommends or endorses the manufacture, supplier or use of such product/equipment, or that CTB in any way guarantees the later performance of the product/equipment.
- 1.1.2. The sample/s mentioned in this report is/are supplied by Applicant, CTB therefore assumes no responsibility for the accuracy of information on the brand name, model number, origin of manufacture or any information supplied.
- 1.1.3. Additional copies of the report are available to the Applicant at an additional fee. No third part can obtain a copy of this report through CTB, unless the applicant has authorized CTB in writing to do so.

1.2. Measurement Uncertainty

Available upon request.

1.3. Test Facility

Site Description
Name of Firm : Shenzhen CTB Testing Technology Co., Ltd.
Site Location : Floor 1&2, Building A, No. 26 of Xinxhe Road,
Xinqiao Community, Xinqiao Street, Baoan
District, Shenzhen, Guangdong China

1.4. Test Uncertainty

Item	Uncertainty
Occupancy bandwidth	54.3kHz
Conducted output power Above 1G	0.9dB
Conducted output power below 1G	0.9dB
Power Spectral Density , Conduction	0.9dB
Conduction spurious emissions	2.0dB
Out of band emission	2.0dB
3m chamber Radiated spurious emission(9KHz-30MHz)	3m chamber Radiated spurious emission(9KHz-30MHz)
3m chamber Radiated spurious emission(30MHz-1GHz)	3m chamber Radiated spurious emission(30MHz-1GHz)
3m chamber Radiated spurious emission(1GHz-18GHz)	3m chamber Radiated spurious emission(1GHz-18GHz)
3m chamber Radiated spurious emission(18GHz-40GHz)	3m chamber Radiated spurious emission(18GHz-40GHz)
humidity uncertainty	5.5%
Temperature uncertainty	0.63°C
frequency	1×10 ⁻⁷
Conducted Emission (150KHz-30MHz)	3.2 dB
Radiated Emission(30MHz ~ 1000MHz)	4.8 dB
Radiated Emission(1GHz ~6GHz)	4.9 dB

2. PRODUCT DESCRIPTION

2.1. EUT Description

Description : wireless charging table lamp
Model Number : LM459
Serial Model : N/A
Model : N/A
Difference :
Power Supply INPUT: 9V/2A
OUTPUT: 10W MAX
MAX wireless charger power 10000mW
Work Frequency : 111-205KHz

2.2. Block Diagram of EUT Configuration

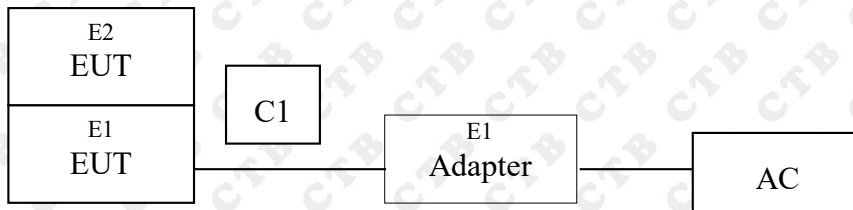

2.3. Test Conditions

Temperature: 23~25°C
Relative Humidity: 55~63 %

2.4. Description Of Support Units (Conducted Mode)

The EUT has been tested as an independent unit together with other necessary accessories or support units. The following support units or accessories were used to form a representative test configuration during the tests.

Item	Equipment	Mfr/Brand	Model/Type No.	Series No.	Note
E1	wireless charging table lamp	N/A	LM459	N/A	EUT
E1	Adapter	N/A	HP18A-09020000-AU	N/A	EUT
E-2	I Phone	N/A	A12	N/A	EUT

Item	Shielded Type	Ferrite Core	Length	Note

Note:

- (1) The support equipment was authorized by Declaration of Confirmation.
- (2) For detachable type I/O cable should be specified the length in cm in 『Length』 column.
- (3) “YES” is means “shielded” “with core”; “NO” is means “unshielded” “without core”.

3. TEST RESULTS SUMMARY

Table 1 Test Results Summary

Section	Test Items	Test Results
15.207	Conducted disturbance	Pass
15.209(a)(f)	Radiated disturbance	Pass
15.215	20 d B Bandwidth	Pass

Remark: “N/A” means “Not applicable.”

4. TEST EQUIPMENT USED

4.1. MEASUREMENT INSTRUMENTS LIST

Item	Equipment	Manufacturer	Type No.	Serial No.	Last calibration	Calibrated until
1	Spectrum Analyzer	Agilent	N9020A	MY52090073	2020.09.27	2022.08.05
2	Power Sensor	Agilent	U2021XA	MY56120032	2020.09.27	2022.08.05
3	Power Sensor	Agilent	U2021XA	MY56120034	2020.09.27	2022.08.05
4	Communication test set	R&S	CMW500	108058	2020.09.27	2022.08.05
5	Spectrum Analyzer	R&S	FSP40	100550	2020.09.27	2022.08.05
6	Signal Generator	Agilent	N5181A	MY49060920	2020.09.27	2022.08.16
7	Signal Generator	Agilent	N5182A	MY47420195	2020.09.27	2022.08.05
8	Communication test set	Agilent	E5515C	MY50102567	2020.09.27	2022.08.16
9	band rejection filter	Shenxiang	MSF2400-24 83.5MS-1154	20181015001	2020.09.27	2022.08.05
10	band rejection filter	Shenxiang	MSF5150-58 50MS-1155	20181015001	2020.09.27	2022.08.05
11	band rejection filter	Xingbo	XBLBQ-DZA 120	190821-1-1	2020.09.27	2022.08.05
12	BT&WI-FI Automatic test software	Microwave	MTS8310	Ver. 2.0.0.0	\	\
13	Rohde & Schwarz SFU Broadcast Test System	R&S	SFU	101017	2020.09.27	2022.08.05
14	Temperature humidity chamber	Hongjing	TH-80CH	DG-15174	2020.09.27	2022.08.05
15	234G Automatic test software	Microwave	MTS8200	Ver. 2.0.0.0	\	\
16	966 chamber	C.R.T.	966 Room	966	2020.09.27	2024.08.11
17	Receiver	R&S	ESPI	100362	2020.09.27	2022.08.05
18	Amplifier	HP	8447E	2945A02747	2020.09.27	2022.08.05
19	Amplifier	Agilent	8449B	3008A01838	2020.09.27	2022.08.05
20	TRILOG Broadband Antenna	Schwarzbeck	VULB 9168	00869	2020.09.27	2022.08.07
21	Horn Antenna	Schwarzbeck	BBHA9120D	1911	2020.09.27	2022.08.08
22	Software	Fala	EZ-EMC	FA-03A2 RE	\	\
23	3-Loop Antenna	Daze	ZN30401	17014	2020.09.27	2022.08.05

24	loop antenna	ZHINAN	ZN30900A	/	2020.09.27	2022.08.05
25	Horn antenna	A/H/System	SAS-574	588	2020.09.27	2022.08.05
26	Amplifier	AEROFLEX	/	S/N/ 097	2020.09.27	2022.08.05

Conducted emissions Test					
Equipment	Manufacturer	Model#	Serial#	Last Cal.	Next Cal.
AMN	ROHDE&SCHW ARZ	ESH3-Z5	100318	2020.09.27	2022.08.05
Pulse limiter	ROHDE&SCHW ARZ	ESH3Z2	357881052	2020.09.27	2022.08.05
EMI TEST RECEIVER	ROHDE&SCHW ARZ	ESCS30	834115/006	2020.09.27	2022.08.05
Coaxial cable	ZDECL	Z302S	18091804	2020.09.27	2022.08.05
ISN	TESEQ	NTFM815 8	183	2020.09.27	2022.08.05
EMI TEST RECEIVER	ROHDE&SCHW ARZ	ESCI	100428/003	2020.09.27	2022.08.05
Software	Fala	EZ-EMC	EMC-CON 3A1.1	\	\

Equipment	Manufacturer	Model No.	Serial No.	Last Cal.	Next Cal.
Double Ridged Broadband Horn Antenna	Schwarzbeck	BBHA 9120D	1911	2020.09.27	2022.08.08
TRILOG Broadband Antenna	Schwarzbeck	VULB 9168	869	2020.09.27	2022.08.05
Amplifier	Agilent	8449B	3008A01838	2020.09.27	2022.08.05
Amplifier	HP	8447E	2945A02747	2020.09.27	2022.08.05
EMI TEST RECEIVER	ROHDE&SCHWARZ	ESPI7	100362	2020.09.27	2022.08.05
Coaxial cable	ETS	RFC-SNS-100-NMS-80 NI	/	2020.09.27	2022.08.05
Coaxial cable	ETS	RFC-SNS-100-NMS-20 NI	/	2020.09.27	2022.08.05
Coaxial cable	ETS	RFC-SNS-100-SMS-20 NI	/	2020.09.27	2022.08.05
Coaxial cable	ETS	RFC-NNS-100-NMS-300 NI	/	2020.09.27	2022.08.05
Communication test set	Agilent	E5515C	MY50102567	2020.09.27	2022.08.16
Communication test set	R&S	CMW500	108058	2020.09.27	2022.08.05
EZ-EMC	Frad	EMC-con3A1.1	/	/	/

5. CONDUCTED EMISSION TEST

5.1. Block Diagram of Test Setup

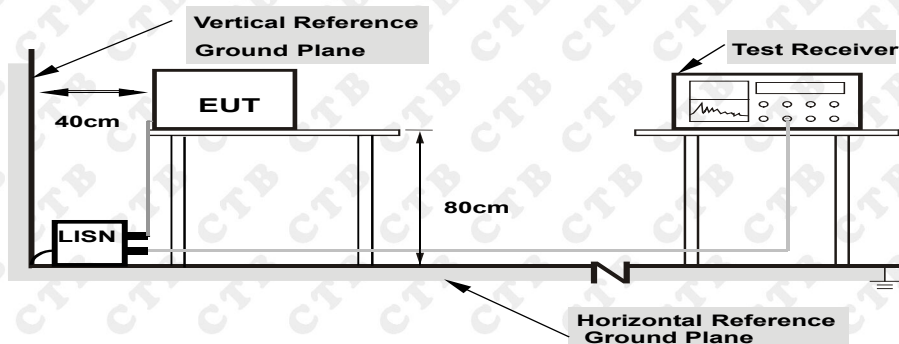

Note: 1. Support units were connected to second LISN.
2. Both of LISNs (AMN) are 80 cm from EUT and at least 80 from other units and other metal planes

The setup of EUT is according with per ANSI C63.10-2013 measurement procedure. The specification used was with the FCC Part 15.207 limits.

5.2. Test Standard

FCC§15.207

5.3. Conducted Emission Limit

Frequency MHz	Limits dB(μ V)	
	Quasi-peak Level	Average Level
0.15 ~ 0.50	66 ~ 56*	56 ~ 46*
0.50 ~ 5.00	56	46
5.00 ~ 30.00	60	50

Notes: 1. *Decreasing linearly with logarithm of frequency.

5.4. EUT Configuration on Test

The following equipments are installed on conducted emission test to meet FCC Part 15.207 requirement and operating in a manner, which tends to maximize its emission characteristics in a normal application.

5.5. Operating Condition of EUT

5.5.1. Setup the EUT and simulators as shown in Section 5.1.

5.5.2. Turn on the power of all equipments.

5.5.3. Let the EUT work in test modes (EUT Working) and test it.

5.6. Test Procedure

The EUT is put on a table of non-conducting material that is 80cm high. The vertical conducting wall of shielding is located 40cm to the rear of the EUT. The power line of the EUT is connected to the AC mains through a Artificial Mains Network (A.M.N.). A EMI test receiver (R&S Test Receiver ESHS30) is used to test the emissions form both sides of AC line. The bandwidth of EMI test receiver is set at 9kHz.

The bandwidth of the test receiver (R&S Test Receiver ESHS30) is set at 10kHz.

We pretest AC 120V and AC 240V, the worst voltage was AC 120V and the data recording in the report.

5.7. Test Result

PASS

Please refer to the following pages.

Temperature:	26 °C	Relative Humidity:	54%
Pressure:	1010hPa	Phase :	L
Test Voltage :	AC 120V/60Hz	Test Mode:	Normal Link

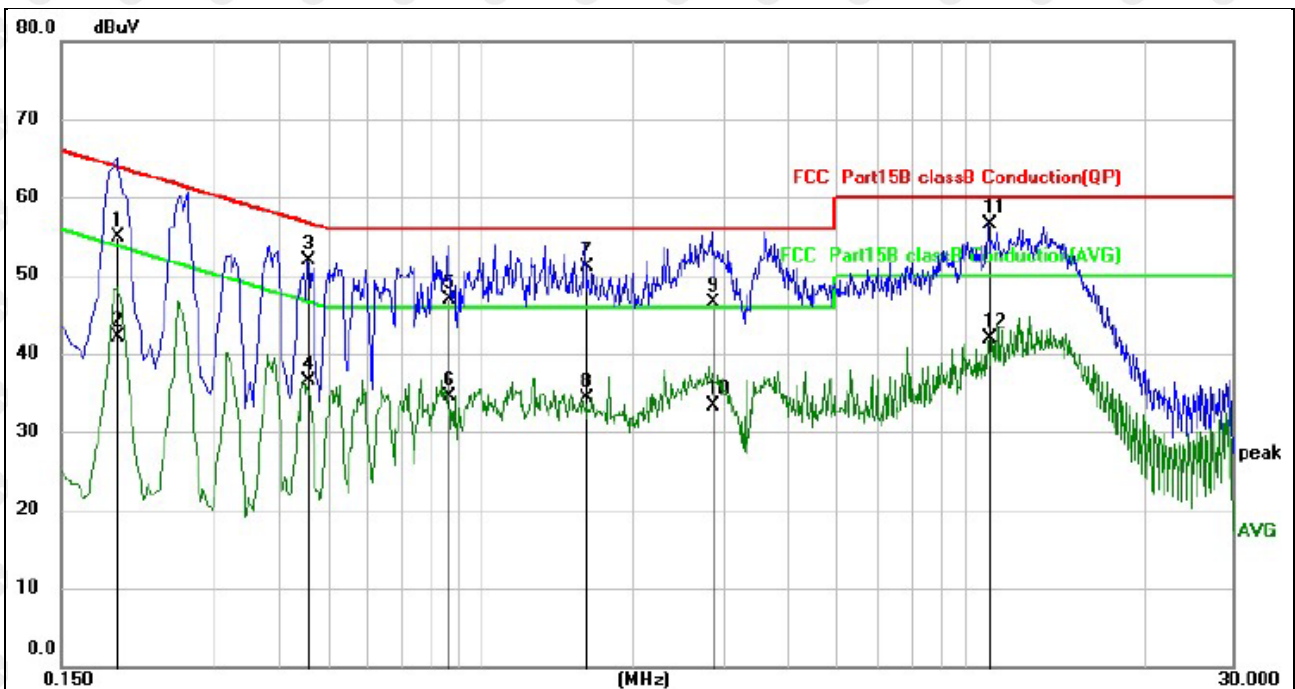

Remark:

1. All readings are Quasi-Peak and Average values.
2. Factor = Insertion Loss + Cable Loss.

No.	Mk.	Freq.	Reading Level	Correct Factor	Measurement	Limit	Margin	Detector
		MHz	dBuV	dB	dBuV	dBuV	dB	
1		0.1940	44.21	10.69	54.90	63.86	-8.96	QP
2		0.1940	31.38	10.69	42.07	53.86	-11.79	AVG
3		0.4580	41.39	10.54	51.93	56.73	-4.80	QP
4		0.4580	26.01	10.54	36.55	46.73	-10.18	AVG
5		0.8620	36.33	10.59	46.92	56.00	-9.08	QP
6		0.8620	23.90	10.59	34.49	46.00	-11.51	AVG
7		1.6060	40.48	10.62	51.10	56.00	-4.90	QP
8		1.6060	23.63	10.62	34.25	46.00	-11.75	AVG
9		2.8540	35.96	10.63	46.59	56.00	-9.41	QP
10		2.8540	22.60	10.63	33.23	46.00	-12.77	AVG
11	*	9.9540	45.72	10.82	56.54	60.00	-3.46	QP
12		9.9540	31.01	10.82	41.83	50.00	-8.17	AVG

Temperature:	26 °C	Relative Humidity:	54%
Pressure:	1010hPa	Phase :	N
Test Voltage :	AC 120V/60Hz	Test Mode:	Normal Link

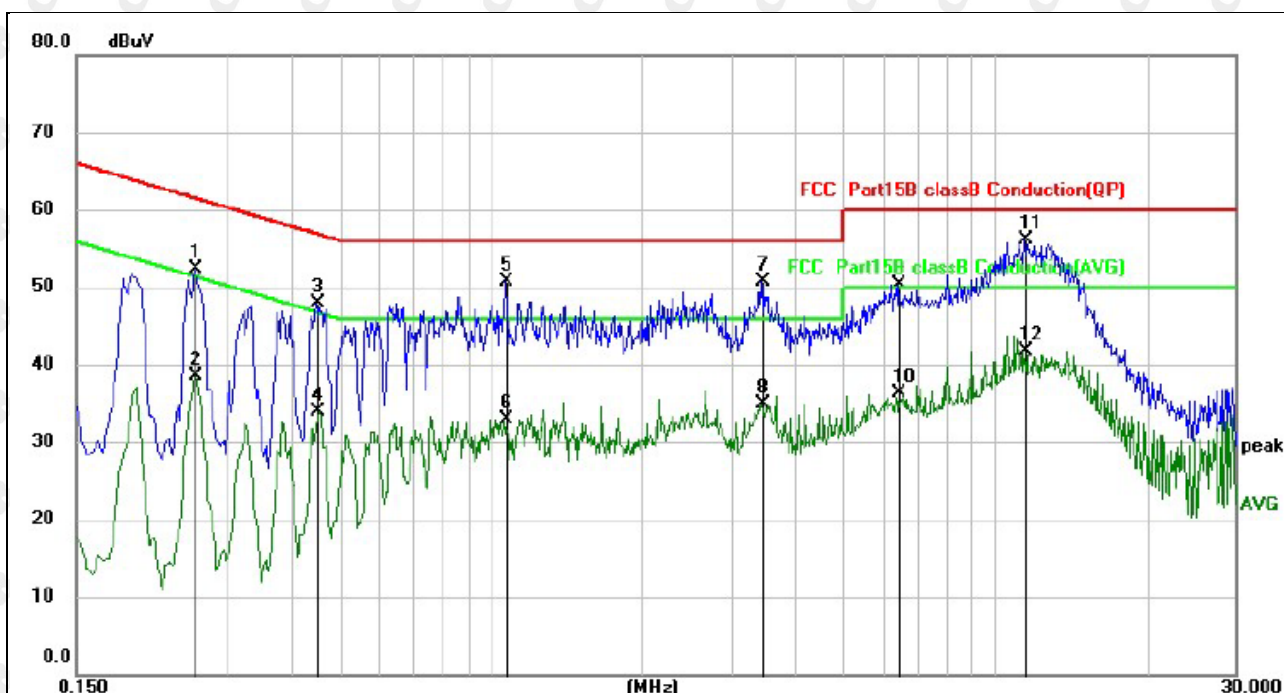

Remark:

1. All readings are Quasi-Peak and Average values.
2. Factor = Insertion Loss + Cable Loss.

No.	Mk.	Freq. MHz	Reading Level dBuV	Correct Factor dB	Measure- ment dBuV	Limit dBuV	Margin dB	Detector
1		0.2580	41.57	10.66	52.23	61.50	-9.27	QP
2		0.2580	27.92	10.66	38.58	51.50	-12.92	AVG
3		0.4500	37.45	10.55	48.00	56.88	-8.88	QP
4		0.4500	23.44	10.55	33.99	46.88	-12.89	AVG
5		1.0660	40.01	10.62	50.63	56.00	-5.37	QP
6		1.0660	22.37	10.62	32.99	46.00	-13.01	AVG
7		3.4380	40.06	10.64	50.70	56.00	-5.30	QP
8		3.4380	24.35	10.64	34.99	46.00	-11.01	AVG
9		6.4220	39.68	10.70	50.38	60.00	-9.62	QP
10		6.4220	25.68	10.70	36.38	50.00	-13.62	AVG
11	*	11.4580	45.29	10.84	56.13	60.00	-3.87	QP
12		11.4580	30.89	10.84	41.73	50.00	-8.27	AVG

6. RADIATED EMISSION MEASUREMENT

6.1. Block Diagram of Test Setup

6.1.1. Block Diagram of connection between the EUT and the simulators

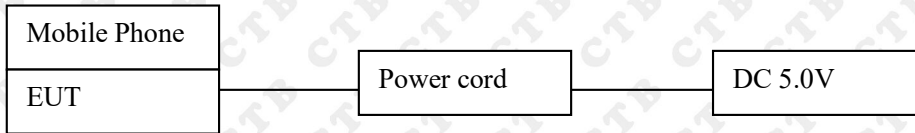

6.1.2. Anechoic Chamber Test Setup Diagram

(A) Radiated Emission Test-Up Frequency Below 30MHz

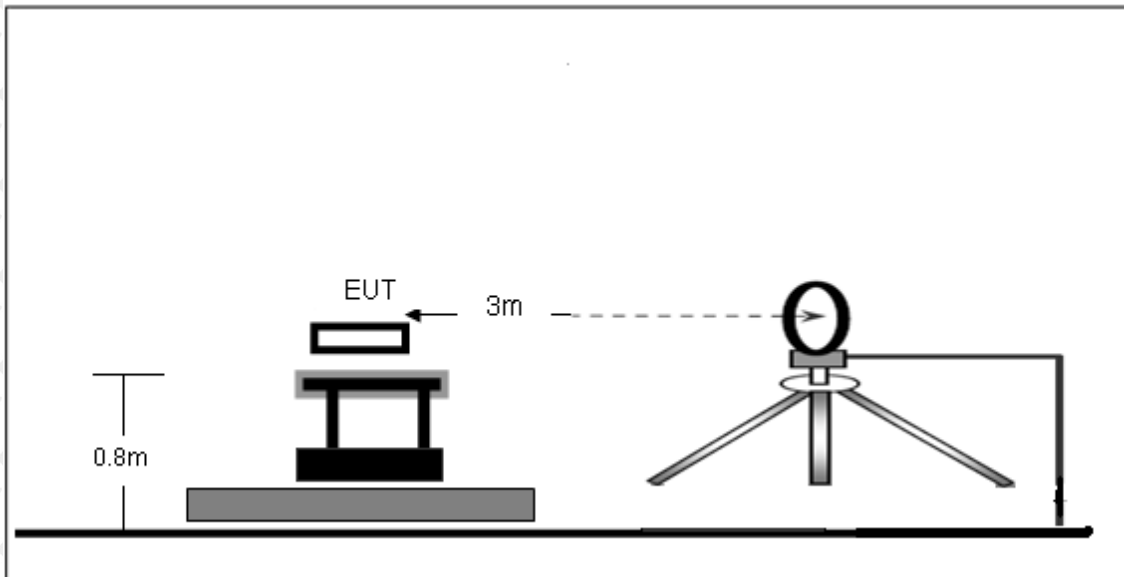

(B) Radiated Emission Test-Up Frequency 30MHz~1GHz

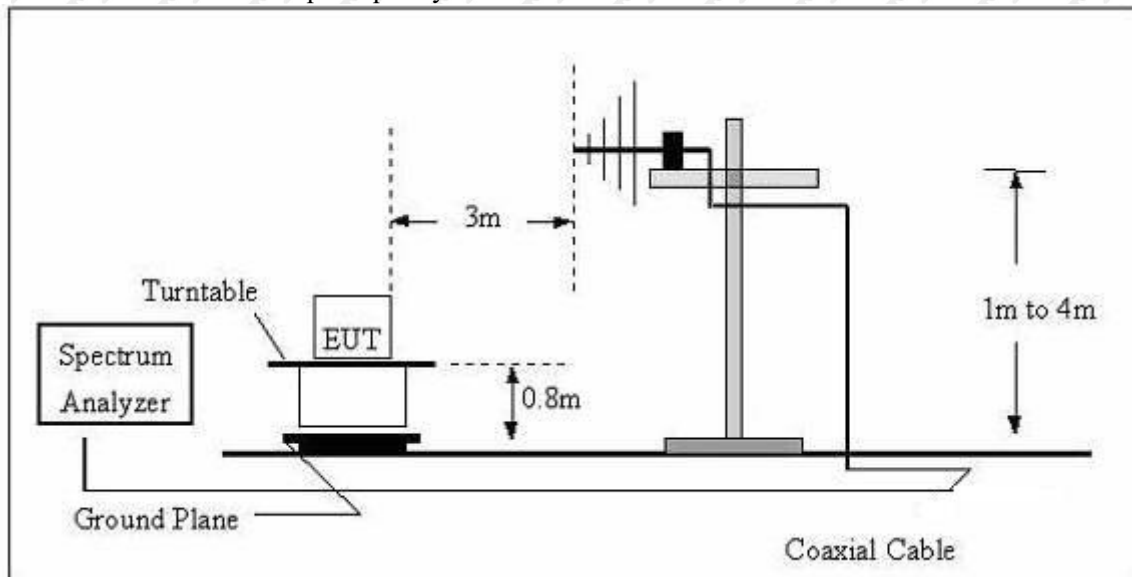

The radiated emission tests were performed in the 3 meters chamber test site, using the setup accordance with the ANSI C63.10-2013. The specification used was the FCC 15.209 and FCC 15.205 limits.

6.2. Test Standard

FCC §15.209; §15.205

6.3. EMI Test Receiver Setup

The system was investigated from 9kHz to1GHz.

During the radiated emission test, the EMI test receiver setup was set with the following configurations:

Frequency Range	RBW	Video B/W	Detector
9 kHz – 150 kHz	200 kHz	1 kHz	QP
150 kHz – 30MHz	9kHz	30kHz	QP
30 MHz – 1000 MHz	120 kHz	300 kHz	QP

Note: For the frequency bands 9-90 kHz and 110-490 kHz, the test was based on average detector.

6.4. Test Procedure

The EUT is placed on a turn table which is 0.8 meter above ground. The turn table can rotate 360 degrees to determine the position of the maximum emission level. The EUT is set 3 meters away from the receiving antenna which is mounted on a antenna tower. The antenna can move up and down between 1 to 4 meters to find out the maximum emission level. Broadband antenna (calibrated by dipole antenna) are used as a receiving antenna. Both horizontal and vertical polarization of the antenna are set on measurement.

6.5. Test Result

PASS

Please refer to the following pages.

9kHz-30MHz

Temperature:	26 °C	Relative Humidity:	54%
Pressure:	1010 hPa	Polarization :	Horizontal
Test Voltage :	AC120V/60Hz	Test Mode :	10W

Freq. (MHz)	Detector Mode (PK/QP/AV)	Reading (dBuV)	Factor (dB)	Actual FS (dBuV/m)	Limits 3m (dBuV/m)	Margin (dBuV/m)
0.113	PEAK	51.13	20.47	71.6	106.5	-34.9
0.338	PEAK	45.66	20.23	65.89	97.0	-31.11
0.566	PEAK	38.46	20.01	58.47	72.5	-14.03
0.802	PEAK	31.87	19.95	51.82	69.5	-17.68
1.134	PEAK	27.45	19.87	47.32	69.5	-22.18
2.354	PEAK	26.87	19.78	46.65	69.5	-22.85

Note:

Pre-scan in the all of mode, the worst case in of was recorded.

Factor = antenna factor + cable loss – pre-amplifier.

Margin = Limit - Emission Level.

30MHz-1GHz

Temperature:	26 °C	Relative Humidity:	54%
Pressure:	1010 hPa	Polarization :	Horizontal
Test Voltage :	AC120V/60Hz	Test Mode :	10W

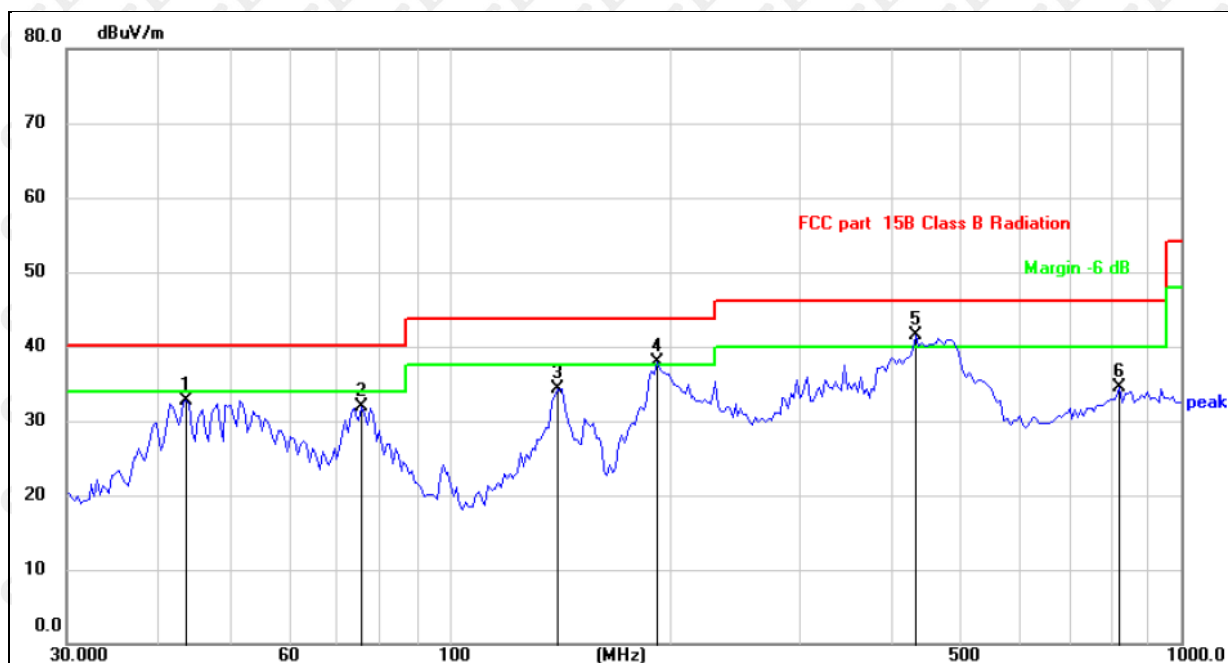

Remark:

Factor = Antenna Factor + Cable Loss – Pre-amplifier, Margin = Measurement– Limit.

No.	Mk.	Freq.	Reading Level	Correct Factor	Measurement	Limit	Over	Detector
		MHz	dBuV	dB	dBuV/m	dB/m	dB	
1		43.7351	38.03	-5.41	32.62	40.00	-7.38	QP
2		75.9772	41.00	-9.02	31.98	40.00	-8.02	QP
3		140.3420	39.70	-5.44	34.26	43.50	-9.24	QP
4	!	192.4183	46.05	-8.13	37.92	43.50	-5.58	QP
5	*	434.8267	42.43	-0.85	41.58	46.00	-4.42	QP
6		824.5968	28.51	6.07	34.58	46.00	-11.42	QP

Temperature:	26 °C	Relative Humidity:	54%
Pressure:	1010 hPa	Polarization :	Vertical
Test Voltage :	AC120V/60Hz	Test Mode :	10W

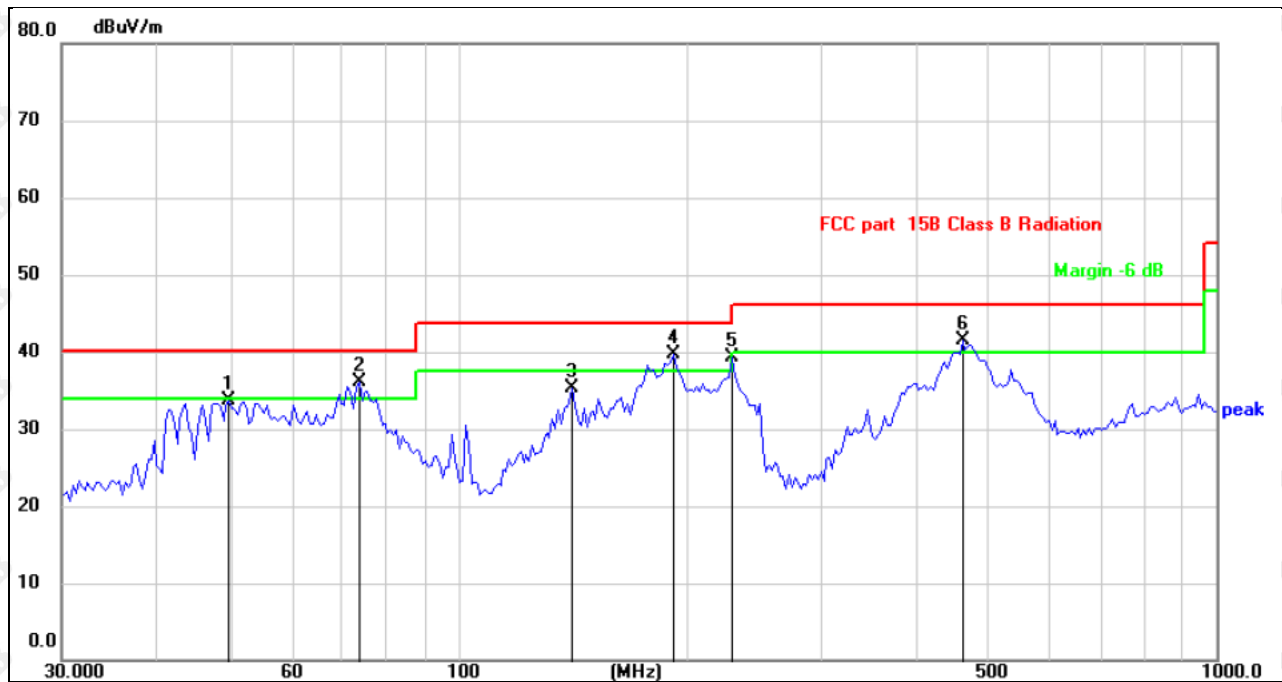

Remark:

Factor = Antenna Factor + Cable Loss – Pre-amplifier, Margin = Measurement– Limit.

No.	Mk.	Freq. MHz	Reading Level dBuV	Correct Factor dB	Measure- ment dBuV/m	Limit dB/m	Over dB	Detector
1		49.8813	39.27	-5.64	33.63	40.00	-6.37	QP
2	!	74.0052	44.68	-8.66	36.02	40.00	-3.98	QP
3		141.5776	40.80	-5.45	35.35	43.50	-8.15	QP
4	*	192.4183	47.78	-8.13	39.65	43.50	-3.85	QP
5	!	229.2930	45.32	-5.95	39.37	43.50	-4.13	QP
6	!	462.3455	41.66	-0.19	41.47	46.00	-4.53	QP

7. OCCUPIED BANDWIDTH

7.1. Block Diagram of Test Setup

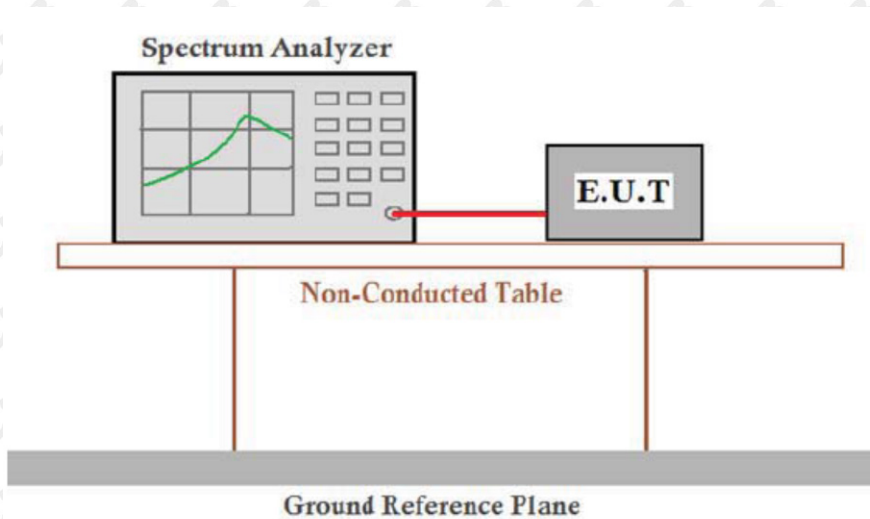

7.2. Rules and specifications

CFR 47 Part 15.215(c)
ANSI C63.10-2013

7.3. Test Procedure

Intentional radiators operating under the alternative provisions to the general emission limits, as contained in §§15.217 through 15.257 and in subpart E of this part, must be designed to ensure that 20dB bandwidth of the emission, or whatever bandwidth may otherwise be specified in the specific rule section under which the equip compliance with the 20dB attenuation specification may base on measurement at the intentional radiator's antenna output terminal unless the intentional radiator uses a permanently attached antenna, in which case compliance shall be demonstrated by measuring the radiated emissions.

7.4. Test Result

PASS

Mode	Freq (KHz)	20dB Bandwidth (Hz)	Limit (Hz)	Conclusion
Tx Mode	140.6	305	/	PASS

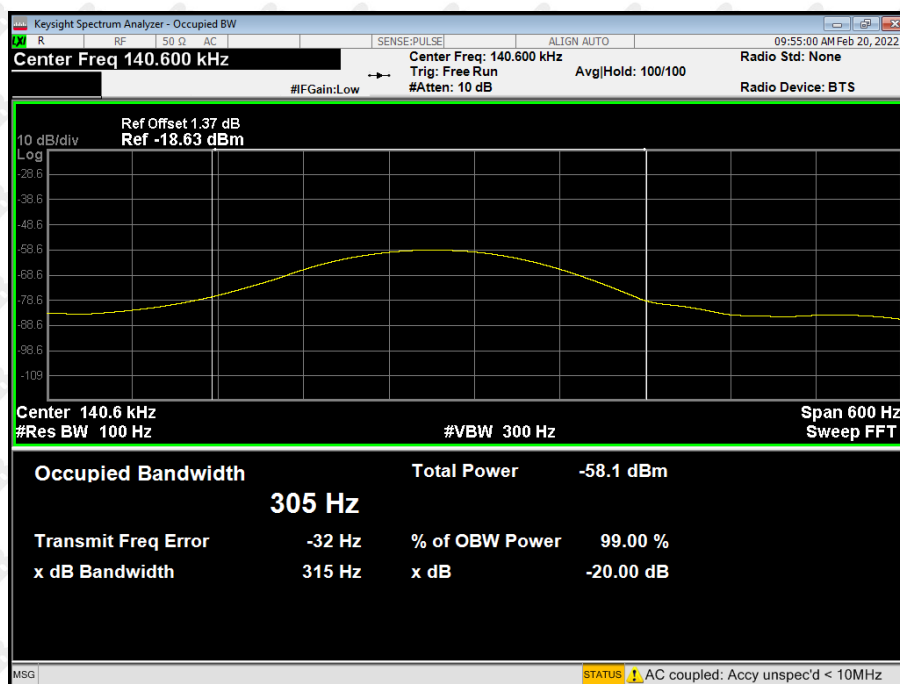

8. EUT TEST PHOTOS

Conducted Measurement Photos



30MHz-1GHz

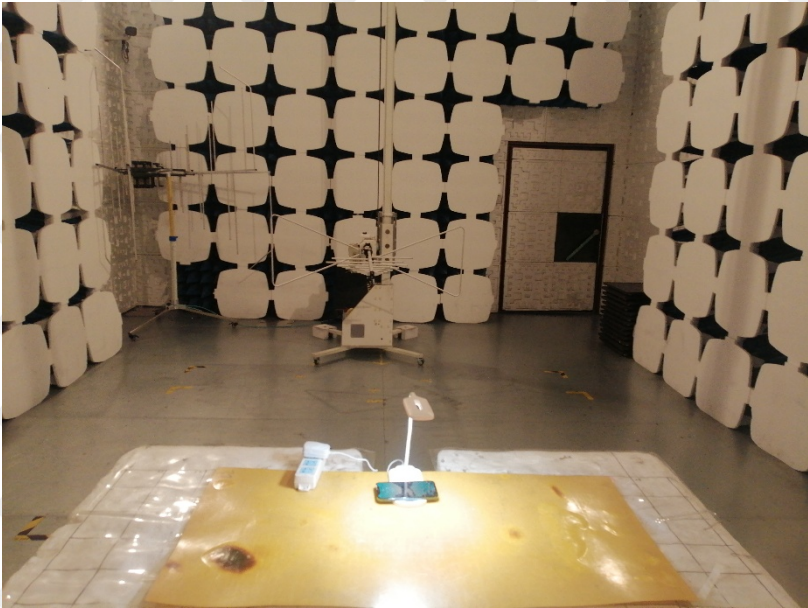

9KHz-30MHz

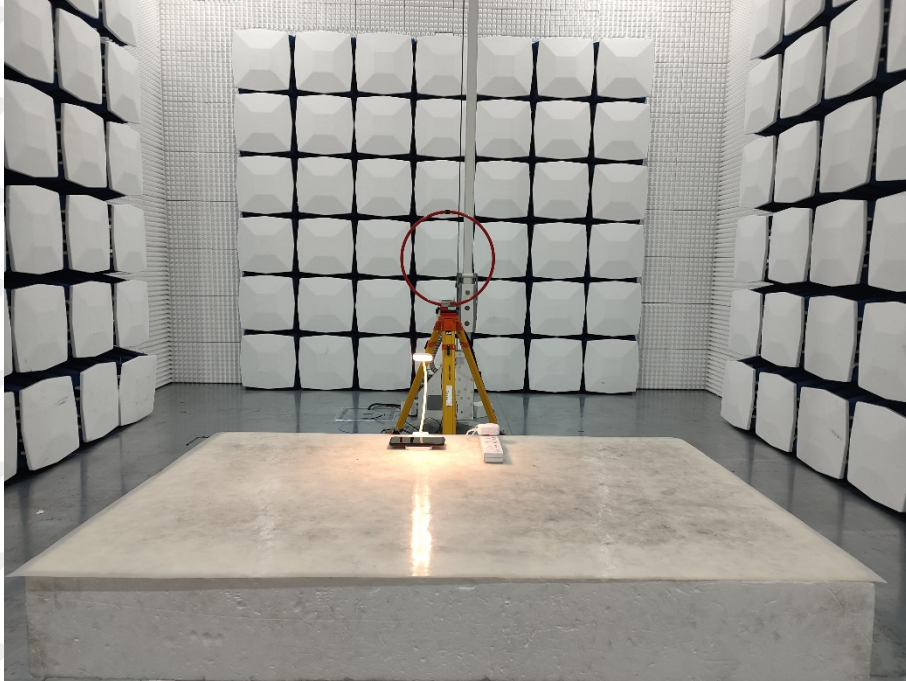

9. EUT PHOTOS

EUT 1

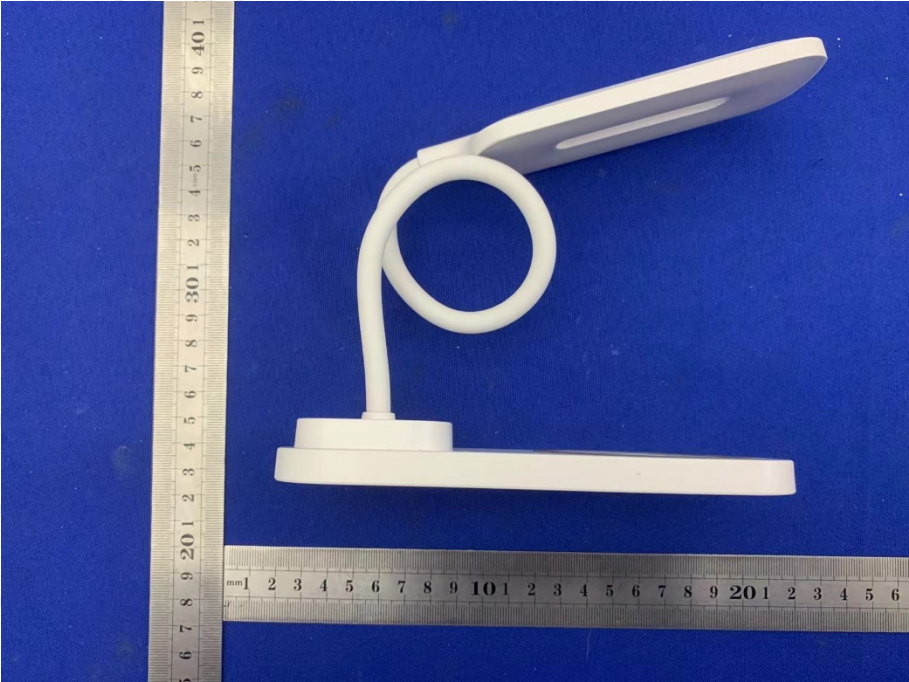

EUT 2



***** END OF REPORT *****