



FCC TEST REPORT

**Test report
On Behalf of
Qualvision Technology Co., Ltd.
For
CCTV Camera
Model No.: WNIP-2LTAW-BS-U, WM-CAM-WAWNP2L**

FCC ID: 2AW8U-WNIP-2LTAWBSU

Prepared for : Qualvision Technology Co., Ltd.
4F-5F, Bldg B, No.37, ZhenXing Road, LiYuHe Industrial Park, LouCun, GongMing,
ShenZhen, 518107, China

Prepared By : Shenzhen HUAKE Testing Technology Co., Ltd.
1F, B2 Building, Junfeng Zhongcheng Zhizao Innovation Park, Fuhai Street,
Bao'an District, Shenzhen City, China

Date of Test: Sep. 02, 2020 ~Sep. 09, 2020

Date of Report: Sep. 09, 2020

Report Number: HK2008072502-E



TEST RESULT CERTIFICATION

Applicant's name: Qualvision Technology Co., Ltd.
Address: 4F-5F, Bldg B, No.37, ZhenXing Road, LiYuHe Industrial Park,
LouCun, GongMing, ShenZhen, 518107, China
Manufacture's Name.....: PT. ADI PRATAMA INDONESIA
Address: JL. STPI CURUG KM 0.5 KP. POS BITUNG RT. 003/003 DESA
KADUJAY A KEC. CURUG KABUPATEN TANGERANG 15810,
Indonesia

Product description

Trade Mark: Night Owl
Product name.....: CCTV Camera
Model and/or type reference : WNIP-2LTAW-BS-U, WM-CAM-WAWNP2L

Standards: FCC Rules and Regulations Part 15 Subpart C Section 15.247
ANSI C63.10: 2013

This publication may be reproduced in whole or in part for non-commercial purposes as long as the Shenzhen HUAK Testing Technology Co., Ltd. is acknowledged as copyright owner and source of the material. Shenzhen HUAK Testing Technology Co., Ltd. takes no responsibility for and will not assume liability for damages resulting from the reader's interpretation of the reproduced material due to its placement and context.

Date of Test:
Date (s) of performance of tests: Sep. 02, 2020 ~Sep. 09, 2020
Date of Issue.....: Sep. 09, 2020
Test Result.....: **Pass**

Testing Engineer : 

(Gary Qian)

Technical Manager : 

(Eden Hu)

Authorized Signatory : 

(Jason Zhou)



TABLE OF CONTENTS

| | |
|--|-----------|
| 1. Test Result Summary | 5 |
| 1.1. TEST PROCEDURES AND RESULTS..... | 5 |
| 1.2. TEST FACILITY | 5 |
| 1.3. MEASUREMENT UNCERTAINTY | 6 |
| 2. EUT Description | 7 |
| 2.1. GENERAL DESCRIPTION OF EUT | 7 |
| 2.2. OPERATION OF EUT DURING TESTING | 8 |
| 2.3. DESCRIPTION OF TEST SETUP | 9 |
| 3. General Information..... | 10 |
| 3.1. TEST ENVIRONMENT AND MODE | 10 |
| 3.2. DESCRIPTION OF SUPPORT UNITS | 11 |
| 4. Test Results and Measurement Data | 12 |
| 4.1. CONDUCTED EMISSION | 12 |
| 4.2. MAXIMUM CONDUCTED OUTPUT POWER | 15 |
| 4.3. EMISSION BANDWIDTH..... | 17 |
| 4.4. POWER SPECTRAL DENSITY | 23 |
| 4.5. CONDUCTED BAND EDGE AND SPURIOUS EMISSION MEASUREMENT | 29 |
| 4.6. RADIATED SPURIOUS EMISSION MEASUREMENT | 39 |
| 4.7. ANTENNA REQUIREMENT | 65 |
| 4.8. PHOTOGRAPH OF TEST..... | 66 |
| 4.9. PHOTOS OF THE EUT | 67 |



**** Modified History ****

| Revision | Description | Issued Data | Remark |
|-----------------|-----------------------------|--------------------|---------------|
| Revision 1.0 | Initial Test Report Release | Sep. 09, 2020 | Jason Zhou |
| | | | |
| | | | |



1. Test Result Summary

1.1. TEST PROCEDURES AND RESULTS

| Requirement | CFR 47 Section | Result |
|----------------------------------|---------------------|--------|
| Antenna requirement | §15.203/§15.247 (c) | PASS |
| AC Power Line Conducted Emission | §15.207 | N/A |
| Conducted Peak Output Power | §15.247 (b)(3) | PASS |
| 6dB Emission Bandwidth | §15.247 (a)(2) | PASS |
| Power Spectral Density | §15.247 (e) | PASS |
| Band Edge | §15.247(d) | PASS |
| Spurious Emission | §15.205/§15.209 | PASS |

Note:

1. PASS: Test item meets the requirement.
2. Fail: Test item does not meet the requirement.
3. N/A: Test case does not apply to the test object.
4. The test result judgment is decided by the limit of test standard.

1.2. TEST FACILITY

Test Firm : Shenzhen HUAKE Testing Technology Co., Ltd.

Address : 1F, B2 Building, Junfeng Zhongcheng Zhizao Innovation Park, Fuhai Street, Bao'an District, Shenzhen City, China



1.3. Measurement Uncertainty

The reported uncertainty of measurement $y \pm U$, where expanded uncertainty U is based on a standard uncertainty multiplied by a coverage factor of $k=2$, providing a level of confidence of approximately 95 %.

| No. | Item | MU |
|-----|-------------------------------|-------------------------|
| 1 | Conducted Emission | $\pm 2.71\text{dB}$ |
| 2 | RF power, conducted | $\pm 0.37\text{dB}$ |
| 3 | Spurious emissions, conducted | $\pm 0.11\text{dB}$ |
| 4 | All emissions, radiated(<1G) | $\pm 3.90\text{dB}$ |
| 5 | All emissions, radiated(>1G) | $\pm 4.28\text{dB}$ |
| 6 | Temperature | $\pm 0.1^\circ\text{C}$ |
| 7 | Humidity | $\pm 1.0\%$ |



2. EUT Description

2.1. GENERAL DESCRIPTION OF EUT

| | |
|---------------------|--|
| Equipment | CCTV Camera |
| Model Name | WNIP-2LTAW-BS-U |
| Serial No. | WM-CAM-WAWNP2L |
| Model Difference | All model's the function, software and electric circuit are the same, only with a product model named different. Test sample model: WNIP-2LTAW-BS-U. |
| FCC ID | 2AW8U-WNIP-2LTAWBSU |
| Antenna Type | External Antenna |
| Antenna Gain | 2dBi |
| Operation frequency | 802.11b/g/n 20:2412~2462 MHz 802.11n 40: 2422~2452MHz |
| Number of Channels | 802.11b/g/n20: 11CH 802.11n 40: 7CH |
| Modulation Type | CCK/OFDM/DBPSK/DAPSK |
| Power Source | DC 12V |
| Power Rating | DC 12V |



Carrier Frequency of Channels

| Channel List for 802.11b/802.11g/802.11n (HT20) | | | | | | | |
|---|-----------------|---------|-----------------|---------|-----------------|---------|-----------------|
| Channel | Frequency (MHz) | Channel | Frequency (MHz) | Channel | Frequency (MHz) | Channel | Frequency (MHz) |
| 01 | 2412 | 04 | 2427 | 07 | 2442 | 10 | 2457 |
| 02 | 2417 | 05 | 2432 | 08 | 2447 | 11 | 2462 |
| 03 | 2422 | 06 | 2437 | 09 | 2452 | | |

| Channel List For 802.11n (HT40) | | | | | | | |
|---------------------------------|-----------------|---------|-----------------|---------|-----------------|---------|-----------------|
| Channel | Frequency (MHz) | Channel | Frequency (MHz) | Channel | Frequency (MHz) | Channel | Frequency (MHz) |
| -- | -- | 04 | 2427 | 07 | 2442 | -- | -- |
| -- | -- | 05 | 2432 | 08 | 2447 | -- | -- |
| 03 | 2422 | 06 | 2437 | 09 | 2452 | | |

Note:

In section 15.31(m), regards to the operating frequency range over 10 MHz, the Lowest frequency, the middle frequency, and the highest frequency of channel were selected to perform the test, and the selected channel see below:

2.2. Operation of EUT during testing

Operating Mode

The mode is used: **Transmitting mode for 802.11b/802.11g/802.11n (HT20)**

Low Channel: 2412MHz

Middle Channel: 2437MHz

High Channel: 2462MHz

The mode is used: Transmitting mode for 802.11n (HT40)

Low Channel: 2422MHz

Middle Channel: 2437MHz

High Channel: 2452MHz



2.3. DESCRIPTION OF TEST SETUP

Operation of EUT during radiation below 1GHz testing:

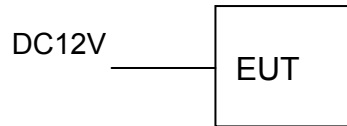

Operation of EUT during Above 1GHz Radiation testing:



The sample was placed (0.8m below 1GHz, 1.5m above 1GHz) above the ground plane of 3m chamber. Measurements in both horizontal and vertical polarities were performed. During the test, each emission was maximized by: having the EUT continuously working, investigated all operating modes, rotated about all 3 axis (X, Y & Z) and considered typical configuration to obtain worst position, manipulating interconnecting cables, rotating the turntable, varying antenna height from 1m to 4m in both horizontal and vertical polarizations. The emissions worst-case are shown in Test Results of the following pages. The worst case is X&Z position



3. General Information

3.1. Test environment and mode

| Operating Environment: | |
|---|--|
| Temperature: | 25.0 °C |
| Humidity: | 56 % RH |
| Atmospheric Pressure: | 1010 mbar |
| Test Mode: | |
| Engineering mode: | Keep the EUT in continuous transmitting by select channel and modulations(The value of duty cycle is 98.46%) |
| The sample was placed (0.8m below 1GHz, 1.5m above 1GHz) above the ground plane of 3m chamber. Measurements in both horizontal and vertical polarities were performed. During the test, each emission was maximized by: having the EUT continuously working, investigated all operating modes, rotated about all 3 axis (X, Y & Z) and considered typical configuration to obtain worst position, manipulating interconnecting cables, rotating the turntable, varying antenna height from 1m to 4m in both horizontal and vertical polarizations. The emissions worst-case are shown in Test Results of the following pages. For the full battery state and The output power to the maximum state. | |

We have verified the construction and function in typical operation. All the test modes were carried out with the EUT in transmitting operation, which was shown in this test report and defined as follows:

Pre-scan all kind of data rate in lowest channel, and found the follow list which it was worst case.

| Mode | Data rate |
|--------------|-----------|
| 802.11b | 1Mbps |
| 802.11g | 6Mbps |
| 802.11n(H20) | 6.5Mbps |
| 802.11n(H40) | 13.5Mbps |

Final Test Mode:

| | |
|---|---|
| Operation mode: | Keep the EUT in continuous transmitting with modulation |
| 1. For WIFI function, the engineering test program was provided and enabled to make EUT continuous transmit/receive. | |
| 2. According to ANSI C63.10 standards, the test results are both the “worst case” and “worst setup” 1Mbps for 802.11b, 6Mbps for 802.11g, 6.5Mbps for 802.11n(H20), 13.5Mbps for 802.11(H40). Duty cycle setting during the transmission is 98.5% with maximum power setting for all modulations. | |



3.2. Description of Support Units

The EUT has been tested as an independent unit together with other necessary accessories or support units. The following support units or accessories were used to form a representative test configuration during the tests.

| Equipment | Model No. | Serial No. | FCC ID | Trade Name |
|-----------|-----------|------------|--------|------------|
| / | / | / | / | / |

Note:

- 1. All the equipment/cables were placed in the worst-case configuration to maximize the emission during the test.*
- 2. Grounding was established in accordance with the manufacturer's requirements and conditions for the intended use.*
- 3. For conducted measurements (Output Power, 6dB Emission Bandwidth, Power Spectral Density, Spurious Emissions), the antenna of EUT is connected to the test equipment via temporary antenna connector, the antenna connector is soldered on the antenna port of EUT, and the temporary antenna connector is listed in the Test Instruments.*



4. Test Results and Measurement Data

4.1. Conducted Emission

Test Specification

| Test Requirement: | FCC Part 15 C Section 15.207 | | | | | | | | | | | | | | |
|--------------------------|---|-----------------------|--------------|--|------------|---------|----------|-----------|-----------|-------|----|----|------|----|----|
| Test Method: | ANSI C63.10:2013 | | | | | | | | | | | | | | |
| Frequency Range: | 150 kHz to 30 MHz | | | | | | | | | | | | | | |
| Receiver setup: | RBW=9 kHz, VBW=30 kHz, Sweep time=auto | | | | | | | | | | | | | | |
| Limits: | <table border="1"> <thead> <tr> <th rowspan="2">Frequency range (MHz)</th> <th colspan="2">Limit (dBuV)</th> </tr> <tr> <th>Quasi-peak</th> <th>Average</th> </tr> </thead> <tbody> <tr> <td>0.15-0.5</td> <td>66 to 56*</td> <td>56 to 46*</td> </tr> <tr> <td>0.5-5</td> <td>56</td> <td>46</td> </tr> <tr> <td>5-30</td> <td>60</td> <td>50</td> </tr> </tbody> </table> | Frequency range (MHz) | Limit (dBuV) | | Quasi-peak | Average | 0.15-0.5 | 66 to 56* | 56 to 46* | 0.5-5 | 56 | 46 | 5-30 | 60 | 50 |
| Frequency range (MHz) | Limit (dBuV) | | | | | | | | | | | | | | |
| | Quasi-peak | Average | | | | | | | | | | | | | |
| 0.15-0.5 | 66 to 56* | 56 to 46* | | | | | | | | | | | | | |
| 0.5-5 | 56 | 46 | | | | | | | | | | | | | |
| 5-30 | 60 | 50 | | | | | | | | | | | | | |
| Test Setup: | <p><i>Remark</i> <i>E.U.T: Equipment Under Test</i> <i>LISN: Line Impedance Stabilization Network</i> <i>Test table height=0.8m</i></p> | | | | | | | | | | | | | | |
| Test Mode: | Charging + transmitting with modulation | | | | | | | | | | | | | | |
| Test Procedure: | <ol style="list-style-type: none"> 1. The E.U.T is connected to the main power through a line impedance stabilization network (L.I.S.N.). This provides a 50ohm/50uH coupling impedance for the measuring equipment. 2. The peripheral devices are also connected to the main power through a LISN that provides a 50ohm/50uH coupling impedance with 50ohm termination. (Please refer to the block diagram of the test setup and photographs). 3. Both sides of A.C. line are checked for maximum conducted interference. In order to find the maximum emission, the relative positions of equipment and all of the interface cables must be changed according to ANSI C63.10: 2013 on conducted measurement. | | | | | | | | | | | | | | |
| Test Result: | N/A | | | | | | | | | | | | | | |

**Test Instruments**

| Conducted Emission Shielding Room Test Site (843) | | | | |
|--|---------------------|-----------------|----------------------|------------------------|
| Equipment | Manufacturer | Model | Serial Number | Calibration Due |
| Receiver | R&S | ESCI 7 | HKE-010 | Dec. 25, 2020 |
| LISN | R&S | ENV216 | HKE-002 | Dec. 25, 2020 |
| Conducted test software | Tonscend | TS+ Rev 2.5.0.0 | HKE-081 | N/A |

Note: The calibration interval of the above test instruments is 12 months and the calibrations are traceable to international system unit (SI).



TEST RESULTS

Not applicable.

Note: EUT power supply by DC Power, so this test item not applicable.



4.2. Maximum Conducted Output Power

Test Specification

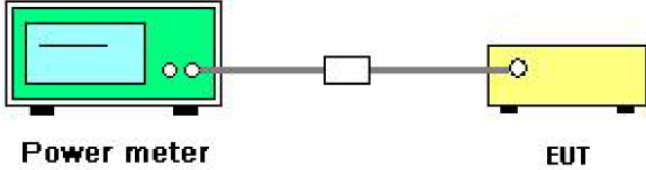
| | |
|--------------------------|---|
| Test Requirement: | FCC Part 15 C Section 15.247 (b)(3) |
| Test Method: | KDB 558074 |
| Limit: | 30dBm |
| Test Setup: |  The diagram illustrates the test setup. On the left is a green Power meter. A cable connects it to a small white attenuator. Another cable connects the attenuator to a yellow EUT (Equipment Under Test) on the right. |
| Test Mode: | Transmitting mode with modulation |
| Test Procedure: | <ol style="list-style-type: none"> 1. The testing follows the Measurement Procedure of FCC KDB No.558074 D01 15.247 Meas Guidance v05r02. 2. The RF output of EUT was connected to the power meter by RF cable and attenuator. The path loss was compensated to the results for each measurement. 3. Set to the maximum power setting and enable the EUT transmit continuously. 4. Measure the Peak output power and record the results in the test report. |
| Test Result: | PASS |

Test Instruments

| RF Test Room | | | | |
|---------------------------|--------------|----------|---------------|-----------------|
| Equipment | Manufacturer | Model | Serial Number | Calibration Due |
| Power meter | Agilent | E4417B | HKE-107 | Dec. 25, 2020 |
| Power Sensor | Agilent | E9327A | HKE-113 | Dec. 25, 2020 |
| RF cable | Times | 1-40G | HKE-034 | Dec. 25, 2020 |
| RF automatic control unit | Tonscend | JS0806-2 | HKE-060 | Dec. 25, 2020 |

Note: The calibration interval of the above test instruments is 12 months and the calibrations are traceable to international system unit (SI).

**Test Data**

| TX 802.11b Mode | | | |
|--------------------------|-----------|-------------------------------------|-------|
| Test Channel | Frequency | Maximum Peak Conducted Output Power | LIMIT |
| | (MHz) | (dBm) | dBm |
| CH01 | 2412 | 15 | 30 |
| CH06 | 2437 | 14.93 | 30 |
| CH11 | 2462 | 14.65 | 30 |
| TX 802.11g Mode | | | |
| CH01 | 2412 | 14.99 | 30 |
| CH06 | 2437 | 13.41 | 30 |
| CH11 | 2462 | 14.63 | 30 |
| TX 802.11n20 Mode | | | |
| CH01 | 2412 | 14.03 | 30 |
| CH06 | 2437 | 13.31 | 30 |
| CH11 | 2462 | 14.45 | 30 |
| TX 802.11n40 Mode | | | |
| CH03 | 2422 | 14.03 | 30 |
| CH06 | 2437 | 12.95 | 30 |
| CH09 | 2452 | 13.12 | 30 |



4.3. Emission Bandwidth

Test Specification

| | |
|--------------------------|--|
| Test Requirement: | FCC Part 15 C Section 15.247 (a)(2) |
| Test Method: | KDB 558074 |
| Limit: | >500kHz |
| Test Setup: |  <p style="text-align: center;">Spectrum Analyzer EUT</p> |
| Test Mode: | Transmitting mode with modulation |
| Test Procedure: | <ol style="list-style-type: none"> 1. The testing follows FCC KDB Publication No.558074 D01 15.247 Meas Guidance v05r02. 2. Set to the maximum power setting and enable the EUT transmit continuously. 3. Make the measurement with the spectrum analyzer's resolution bandwidth (RBW) = 100 kHz. Set the Video bandwidth (VBW) = 300 kHz. In order to make an accurate measurement. The 6dB bandwidth must be greater than 500 kHz. 4. Measure and record the results in the test report. |
| Test Result: | PASS |

Test Instruments

| RF Test Room | | | | |
|----------------------------|--------------|----------|---------------|-----------------|
| Equipment | Manufacturer | Model | Serial Number | Calibration Due |
| Spectrum analyzer | Agilent | N9020A | HKE-048 | Dec. 25, 2020 |
| RF Cable (9KHz-26.5GHz) | Tonscend | 170660 | N/A | Dec. 25, 2020 |
| RF automatic control unit | Tonscend | JS0806-2 | HKE-060 | Dec. 25, 2020 |

Note: The calibration interval of the above test instruments is 12 months and the calibrations are traceable to international system unit (SI).

**Test data**

| Test channel | 6dB Emission Bandwidth (MHz) | | | |
|--------------|------------------------------|---------|--------------|--------------|
| | 802.11b | 802.11g | 802.11n(H20) | 802.11n(H40) |
| Lowest | 8.623 | 16.39 | 17.58 | 35.70 |
| Middle | 9.071 | 16.37 | 17.34 | 35.88 |
| Highest | 8.618 | 16.43 | 17.34 | 36.14 |
| Limit: | >500KHZ | | | |
| Test Result: | PASS | | | |

Test plots as follows:



802.11b Modulation

Lowest channel



Middle channel



Highest channel

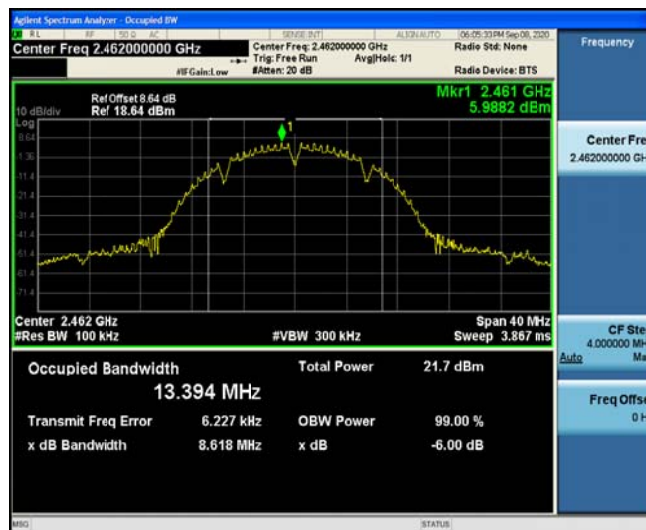



802.11g Modulation

Lowest channel

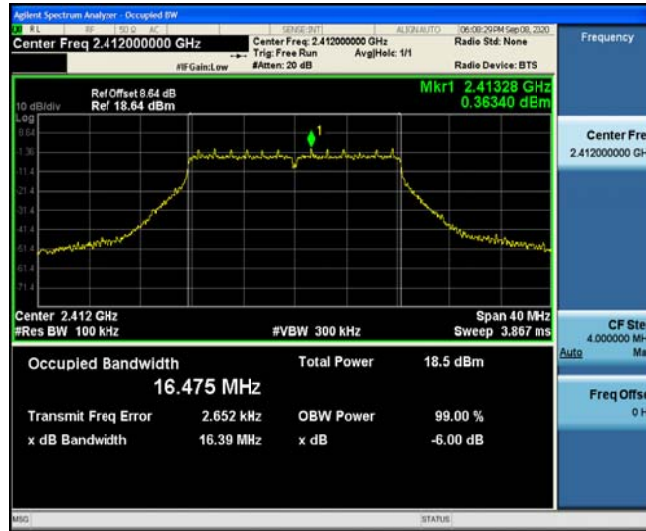

Middle channel

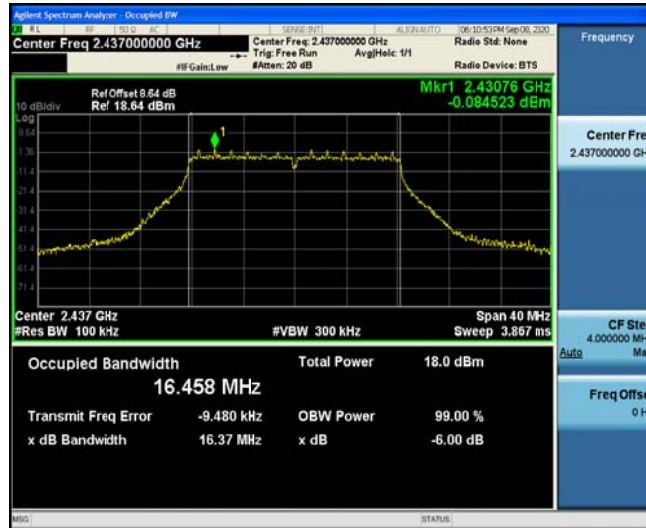

Highest channel





802.11n (HT20) Modulation

Lowest channel



Middle channel

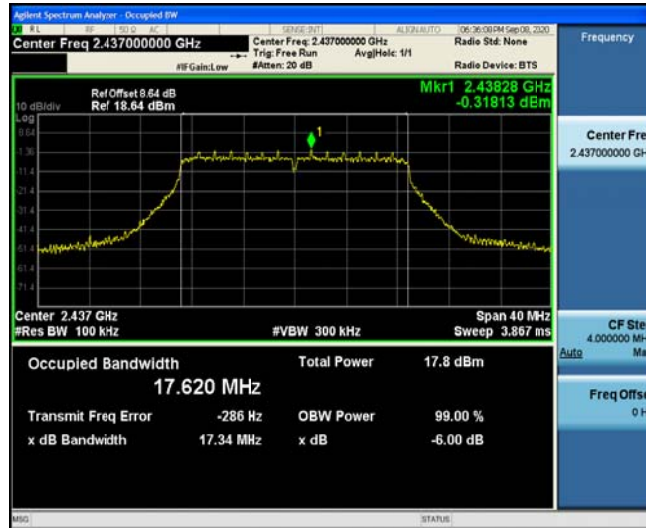

Highest channel





802.11n (HT40) Modulation

Lowest channel



Middle channel



Highest channel





4.4. Power Spectral Density

Test Specification

| | |
|--------------------------|--|
| Test Requirement: | FCC Part 15 C Section 15.247 (e) |
| Test Method: | KDB 558074 |
| Limit: | The average power spectral density shall not be greater than 8dBm in any 3kHz band at any time interval of continuous transmission. |
| Test Setup: |  <p style="text-align: center;">Spectrum Analyzer EUT</p> |
| Test Mode: | Transmitting mode with modulation |
| Test Procedure: | <ol style="list-style-type: none"> 1. The testing follows Measurement procedure 10.2 method PKPSD of FCC KDB Publication No.558074 D01 15.247 Meas Guidance v05r02 2. The RF output of EUT was connected to the spectrum analyzer by RF cable and attenuator. The path loss was compensated to the results for each measurement. 3. Set to the maximum power setting and enable the EUT transmit continuously. 4. Make the measurement with the spectrum analyzer's resolution bandwidth (RBW): $3\text{ kHz} \leq \text{RBW} \leq 100\text{ kHz}$. Video bandwidth $\text{VBW} \geq 3 \times \text{RBW}$. Set the span to at least 1.5 times the OBW. 5. Detector = Peak, Sweep time = auto couple. 6. Employ trace averaging (Peak) mode over a minimum of 100 traces. Use the peak marker function to determine the maximum power level. 6. Measure and record the results in the test report. |
| Test Result: | PASS |

Test Instruments

| RF Test Room | | | | |
|----------------------------|--------------|----------|---------------|-----------------|
| Equipment | Manufacturer | Model | Serial Number | Calibration Due |
| Spectrum analyzer | Agilent | N9020A | HKE-048 | Dec. 25, 2020 |
| RF Cable (9KHz-26.5GHz) | Tonscend | 170660 | N/A | Dec. 25, 2020 |
| RF automatic control unit | Tonscend | JS0806-2 | HKE-060 | Dec. 25, 2020 |

Note: The calibration interval of the above test instruments is 12 months and the calibrations are traceable to international system unit (SI).

**Test data**

| EUT Set Mode | Channel | Result (dBm/30kHz) | Result (dBm/3kHz) |
|--|---------|--------------------|-------------------|
| 802.11b | Lowest | 4.36 | -5.64 |
| | Middle | 3.32 | -6.68 |
| | Highest | 1.23 | -8.77 |
| 802.11g | Lowest | -4.37 | -14.37 |
| | Middle | -5.31 | -15.31 |
| | Highest | -7.46 | -17.46 |
| 802.11n(H20) | Lowest | -5.96 | -15.96 |
| | Middle | -7.78 | -17.78 |
| | Highest | -9.45 | -19.45 |
| 802.11n(H40) | Lowest | -12.16 | -22.16 |
| | Middle | -11.61 | -21.61 |
| | Highest | -13.34 | -23.34 |
| PSD test result (dBm/3kHz)= PSD test result (dBm/30kHz)-10 | | | |
| Limit: 8dBm/3kHz | | | |
| Test Result: | PASS | | |

Test plots as follows:



802.11b Modulation

Lowest channel



Middle channel



Highest channel





802.11g Modulation

Lowest channel

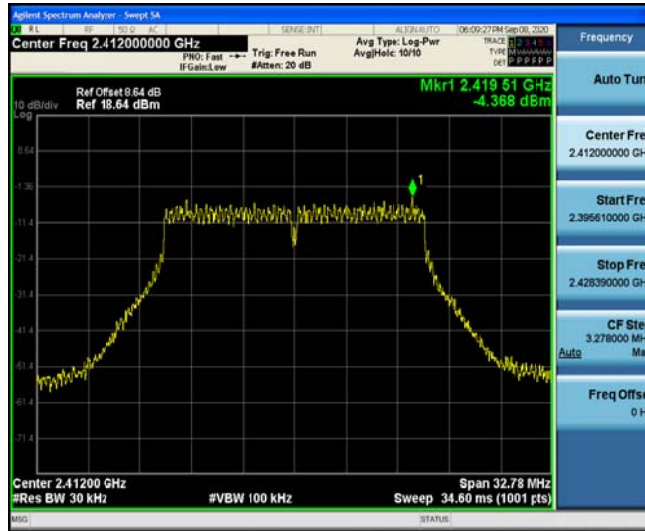

Middle channel



Highest channel





802.11n (HT20) Modulation

Lowest channel

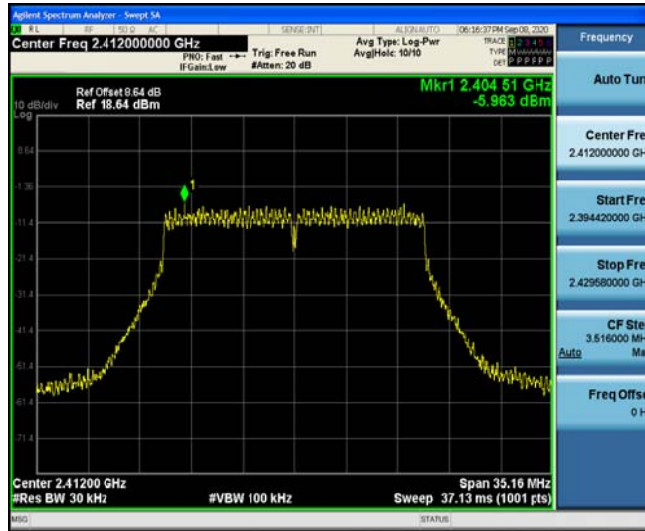

Middle channel



Highest channel

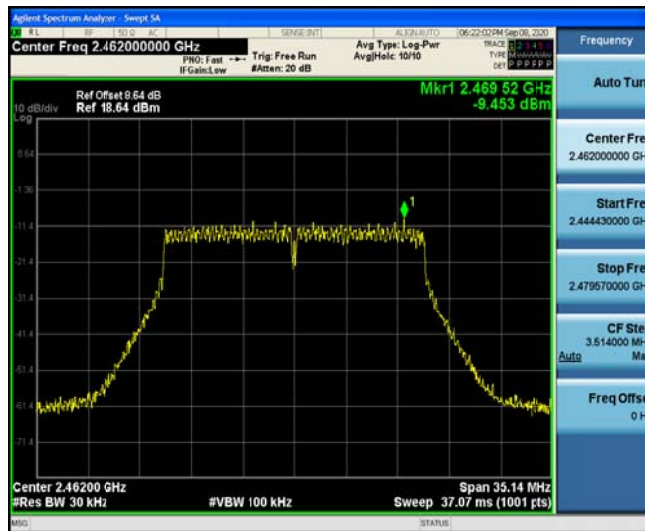



802.11n (HT40) Modulation

Lowest channel



Middle channel



Highest channel



4.5. Conducted Band Edge and Spurious Emission Measurement

Test Specification

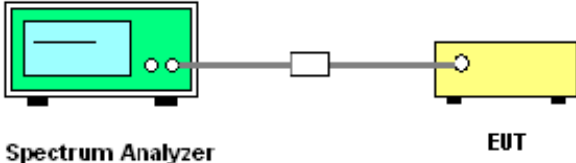
| | |
|--------------------------|--|
| Test Requirement: | FCC Part15 C Section 15.247 (d) |
| Test Method: | KDB558074 |
| Limit: | In any 100 kHz bandwidth outside of the authorized frequency band, the emissions which fall in the non-restricted bands shall be attenuated at least 20 dB / 30dB relative to the maximum PSD level in 100 kHz by RF conducted measurement and radiated emissions which fall in the restricted bands, as defined in Section 15.205(a), must also comply with the radiated emission limits specified in Section 15.209(a). |
| Test Setup: |  <p style="text-align: center;">Spectrum Analyzer EUT</p> |
| Test Mode: | Transmitting mode with modulation |
| Test Procedure: | <ol style="list-style-type: none"> 1. The testing follows FCC KDB Publication No.558074 D01 15.247 Meas Guidance v05r02. 2. The RF output of EUT was connected to the spectrum analyzer by RF cable and attenuator. The path loss was compensated to the results for each measurement. 3. Set to the maximum power setting and enable the EUT transmit continuously. 4. Set RBW = 100 kHz, VBW=300 kHz, Peak Detector. Unwanted Emissions measured in any 100 kHz bandwidth outside of the authorized frequency band shall be attenuated by at least 20 dB relative to the maximum in-band peak PSD level in 100 kHz when maximum peak conducted output power procedure is used. If the transmitter complies with the conducted power limits based on the use of RMS averaging over a time interval, the attenuation required under this paragraph shall be 30 dB instead of 20 dB per 15.247(d). 5. Measure and record the results in the test report. 6. The RF fundamental frequency should be excluded against the limit line in the operating frequency band. |
| Test Result: | PASS |

**Test Instruments**

| RF Test Room | | | | |
|------------------------------|--------------|----------|---------------|-----------------|
| Equipment | Manufacturer | Model | Serial Number | Calibration Due |
| Spectrum analyzer | Agilent | N9020A | HKE-048 | Dec. 25, 2020 |
| Signal generator | Agilent | N5183A | HKE-071 | Dec. 25, 2020 |
| RF Cable (9KHz-26.5GHz) | Tonscend | 170660 | N/A | Dec. 25, 2020 |
| RF automatic control unit | Tonscend | JS0806-2 | HKE-060 | Dec. 25, 2020 |

Note: The calibration interval of the above test instruments is 12 months and the calibrations are traceable to international system unit (SI).



Test Data

802.11b Modulation

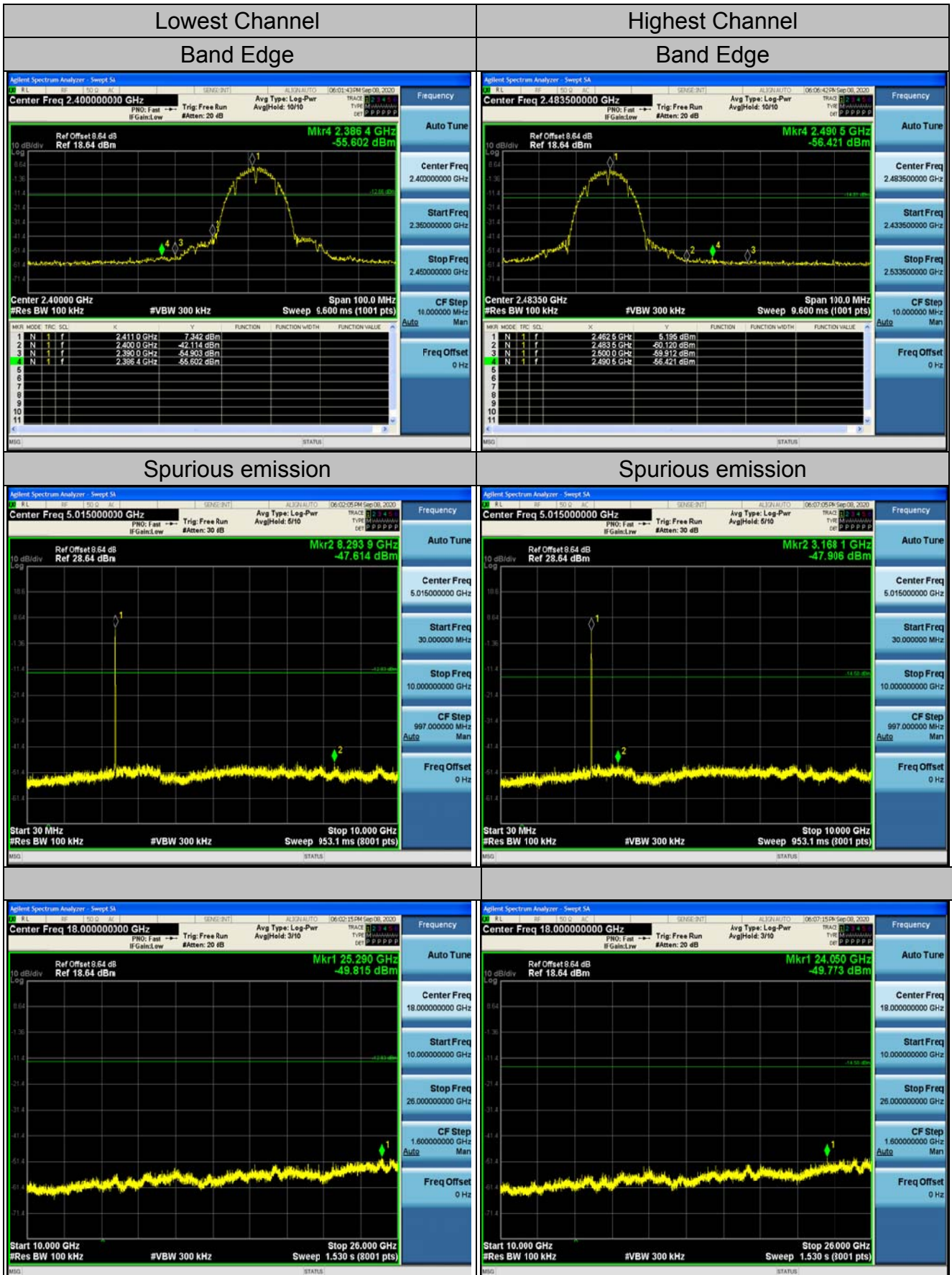



middle Channel Spurious emission

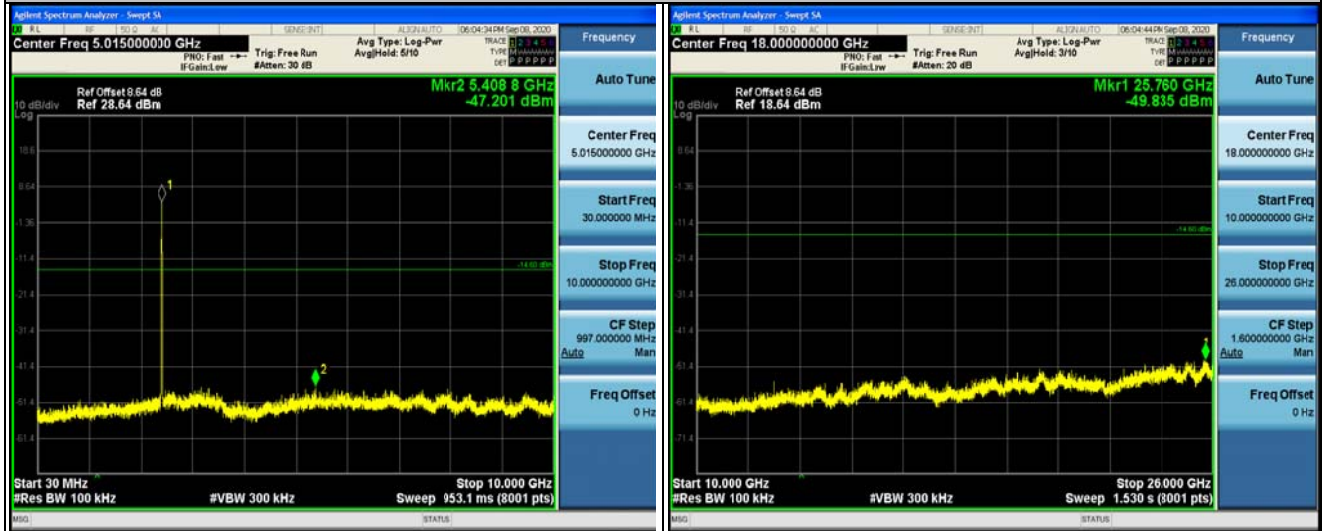



802.11g Modulation

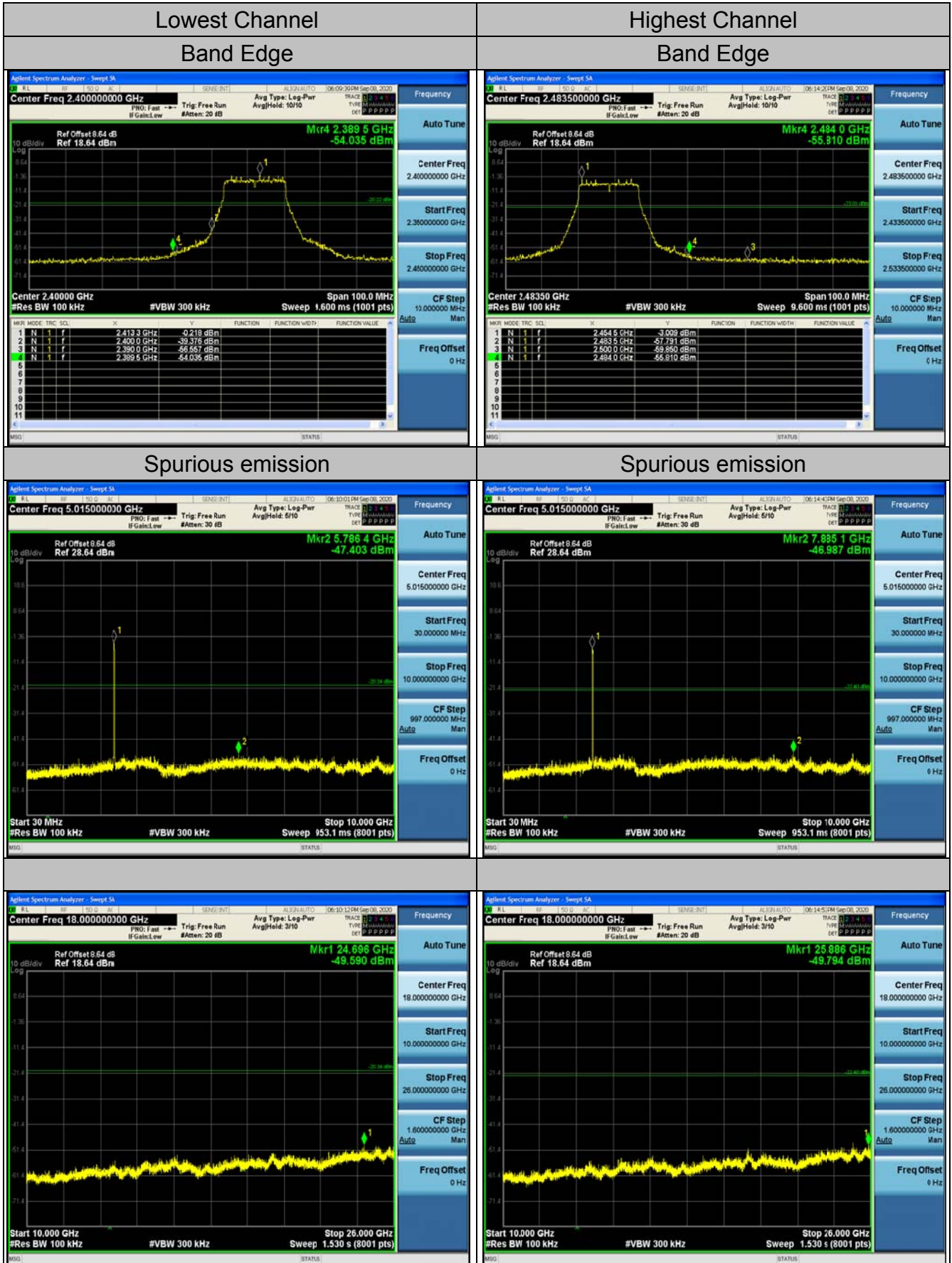



middle Channel Spurious emission

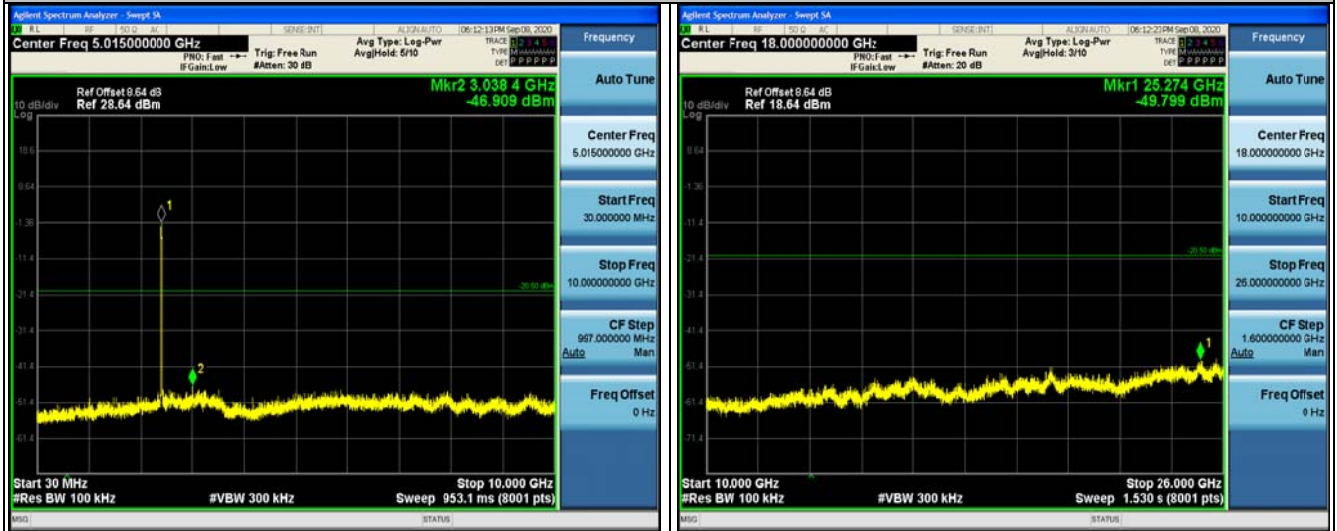



802.11n (HT20) Modulation

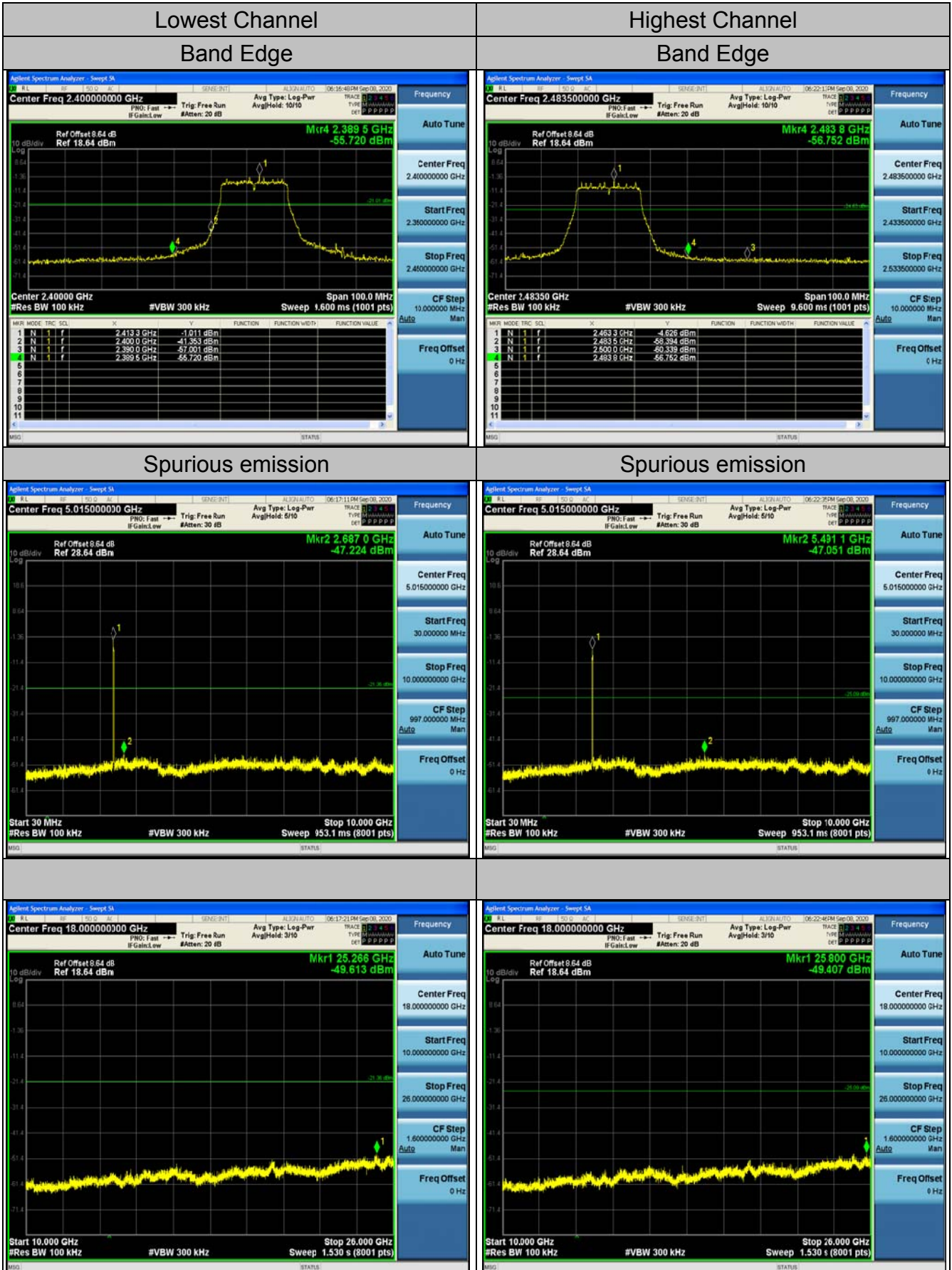



middle Channel
Spurious emission

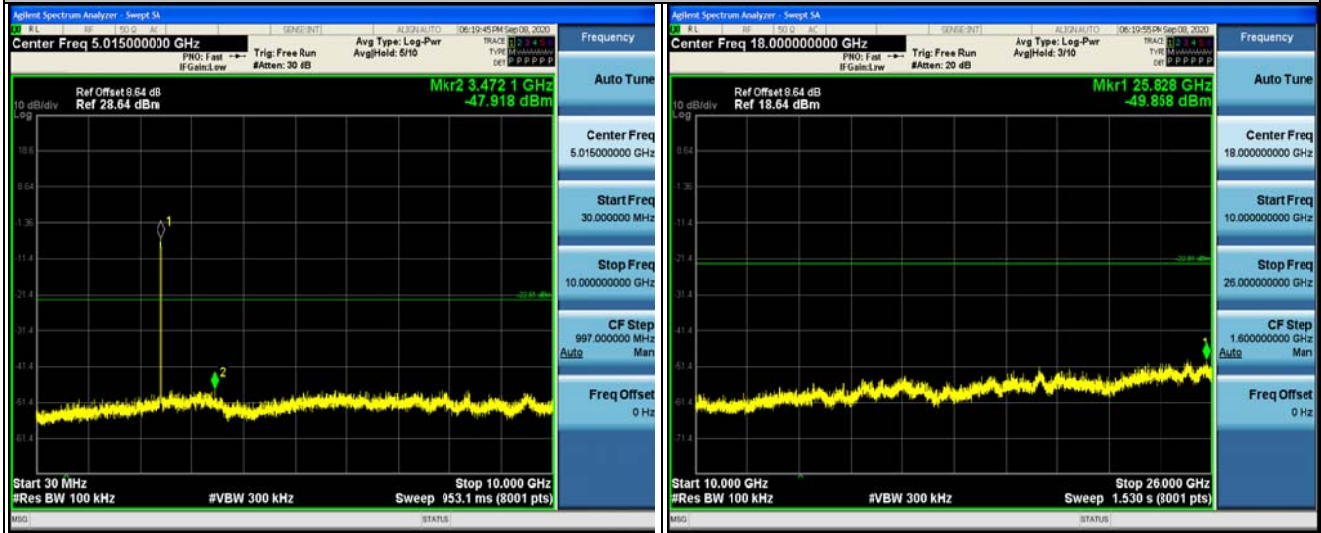



802.11n (HT40) Modulation

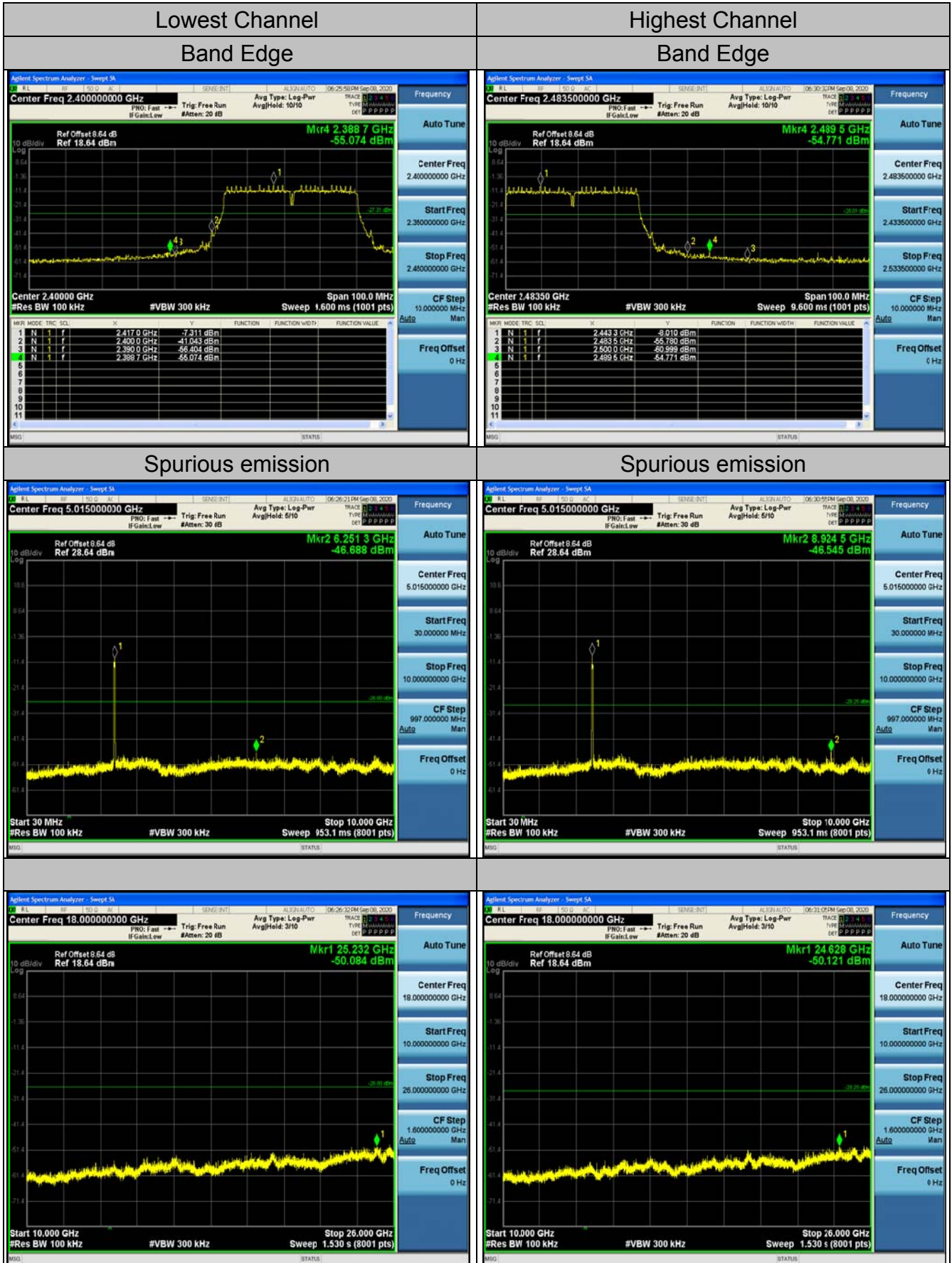



middle Channel Spurious emission

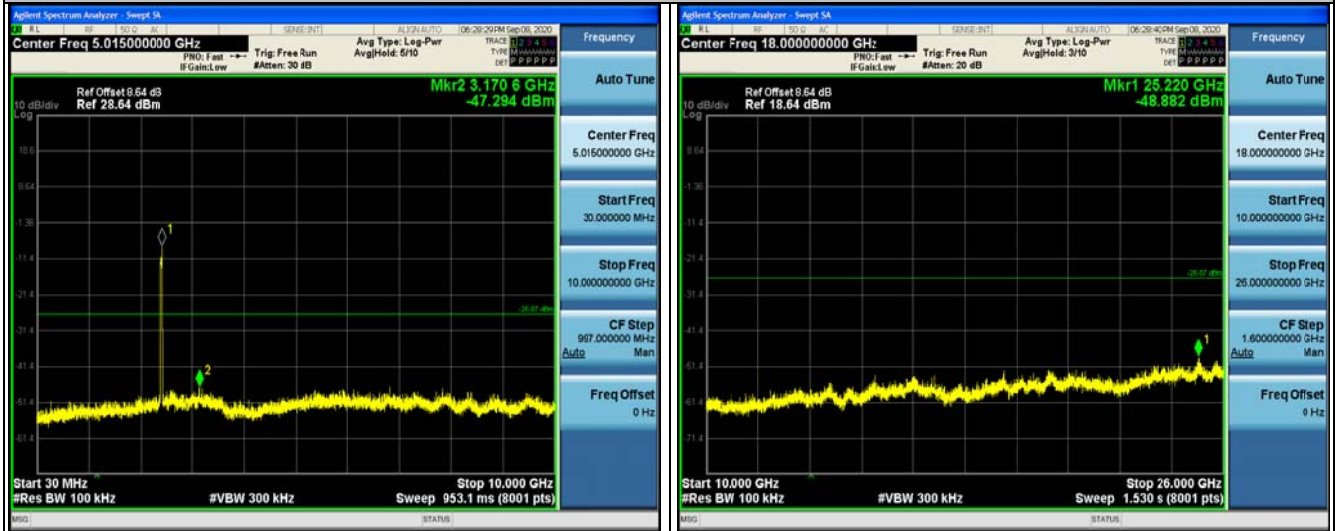

4.6. Radiated Spurious Emission Measurement

Test Specification

| | | | | | | |
|------------------------------|------------------------------------|-----------------------------------|-------------------------------|----------|------------------|--|
| Test Requirement: | FCC Part 15 C Section 15.209 | | | | | |
| Test Method: | ANSI C63.10: 2013 | | | | | |
| Frequency Range: | 9 kHz to 25 GHz | | | | | |
| Measurement Distance: | 3 m | | | | | |
| Antenna Polarization: | Horizontal & Vertical | | | | | |
| Operation mode: | Transmitting mode with modulation | | | | | |
| Receiver Setup: | Frequency | Detector | RBW | VBW | Remark | |
| | 9kHz- 150kHz | Quasi-peak | 200Hz | 1kHz | Quasi-peak Value | |
| | 150kHz- 30MHz | Quasi-peak | 9kHz | 30kHz | Quasi-peak Value | |
| | 30MHz-1GHz | Quasi-peak | 120KHz | 300KHz | Quasi-peak Value | |
| | Above 1GHz | Peak | 1MHz | 3MHz | Peak Value | |
| | | Peak | 1MHz | 10Hz | Average Value | |
| Limit: | Frequency | Field Strength (microvolts/meter) | Measurement Distance (meters) | | | |
| | 0.009-0.490 | 2400/F(KHz) | 300 | | | |
| | 0.490-1.705 | 24000/F(KHz) | 30 | | | |
| | 1.705-30 | 30 | 30 | | | |
| | 30-88 | 100 | 3 | | | |
| | 88-216 | 150 | 3 | | | |
| | 216-960 | 200 | 3 | | | |
| | Above 960 | 500 | 3 | | | |
| | Frequency | Field Strength (microvolts/meter) | Measurement Distance (meters) | Detector | | |
| | Above 1GHz | 500 | 3 | Average | | |
| | 5000 | 3 | Peak | | | |
| Test setup: | For radiated emissions below 30MHz | | | | | |
| | | | | | | |
| | 30MHz to 1GHz | | | | | |

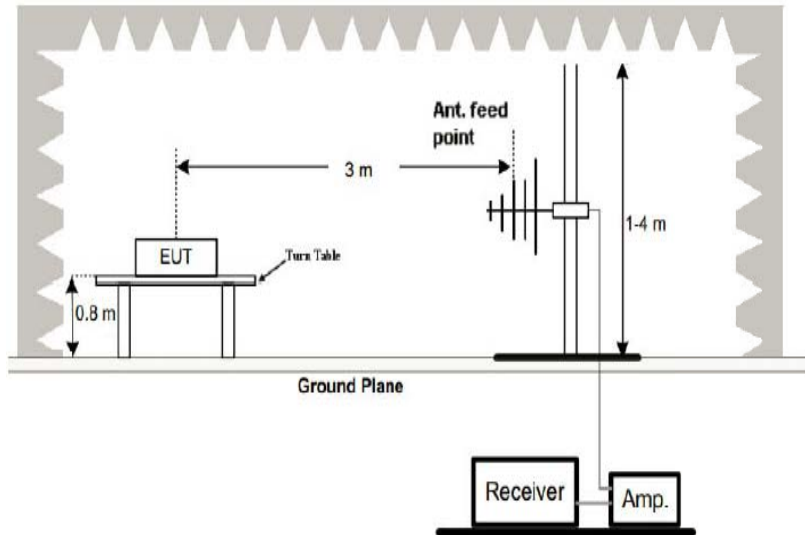

Above 1GHz

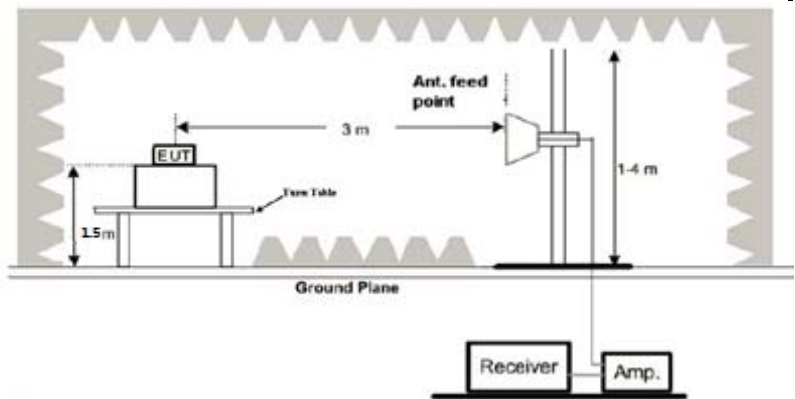

Test Procedure:

1. For the radiated emission test below 1GHz:
 The EUT was placed on a turntable with 0.8 meter above ground. The EUT was set 3 meters from the interference receiving antenna, which was mounted on the top of a variable height antenna tower. The EUT was arranged to its worst case and then tune the antenna tower (from 1 m to 4 m) and turntable (from 0 degree to 360 degrees) to find the maximum reading. A pre-amp and a high PASS filter are used for the test in order to get better signal level.
 For the radiated emission test above 1GHz:
 Place the measurement antenna on a turntable with 1.5 meter above ground, which is away from each area of the EUT determined to be a source of emissions at the specified measurement distance, while keeping the measurement antenna aimed at the source of emissions at each frequency of significant emissions, with polarization oriented for maximum response. The measurement antenna may have to be higher or lower than the EUT, depending on the radiation pattern of the emission and staying aimed at the emission source for receiving the maximum signal. The final



| | |
|----------------------|--|
| | <p>measurement antenna elevation shall be that which maximizes the emissions. The measurement antenna elevation for maximum emissions shall be restricted to a range of heights of from 1 m to 4 m above the ground or reference ground plane.</p> <ol style="list-style-type: none">3. Corrected Reading: Antenna Factor + Cable Loss + Read Level - Preamp Factor = Level4. For measurement below 1GHz, If the emission level of the EUT measured by the peak detector is 3 dB lower than the applicable limit, the peak emission level will be reported. Otherwise, the emission measurement will be repeated using the quasi-peak detector and reported.5. Use the following spectrum analyzer settings:<ol style="list-style-type: none">(1) Span shall wide enough to fully capture the emission being measured;(2) Set RBW=120 kHz for $f < 1$ GHz; $VBW \geq RBW$; Sweep = auto; Detector function = peak; Trace = max hold;(3) Set RBW = 1 MHz, VBW= 3MHz for $f \geq 1$ GHz for peak measurement.For average measurement: VBW = 10 Hz, when duty cycle is no less than 98 percent. $VBW \geq 1/T$, when duty cycle is less than 98 percent where T is the minimum transmission duration over which the transmitter is on and is transmitting at its maximum power control level for the tested mode of operation. |
| Test results: | PASS |

**Test Instruments**

| Radiated Emission Test Site (966) | | | | |
|--|---------------------|--------------------|----------------------|------------------------|
| Name of Equipment | Manufacturer | Model | Serial Number | Calibration Due |
| Receiver | R&S | ESCI-7 | HKE-010 | Dec. 25, 2020 |
| Spectrum analyzer | Agilent | N9020A | HKE-048 | Dec. 25, 2020 |
| Preamplifier | EMCI | EMC051845 SE | HKE-015 | Dec. 25, 2020 |
| Preamplifier | Agilent | 83051A | HKE-016 | Dec. 25, 2020 |
| Loop antenna | Schwarzbeck | FMZB 1519 B | HKE-014 | Dec. 25, 2020 |
| Broadband antenna | Schwarzbeck | VULB 9163 | HKE-012 | Dec. 25, 2020 |
| Horn antenna | Schwarzbeck | 9120D | HKE-013 | Dec. 25, 2020 |
| Antenna Mast | Keleto | CC-A-4M | N/A | N/A |
| Position controller | Taiwan MF | MF7802 | HKE-011 | Dec. 25, 2020 |
| Radiated test software | Tonscend | TS+ Rev 2.5.0.0 | HKE-082 | N/A |
| RF cable (9KHz-1GHz) | Times | 381806-001 | N/A | N/A |
| RF cable | Times | 1-40G | HKE-034 | Dec. 25, 2020 |
| High gain antenna | Schwarzbeck | LB-180400K F | HKE-054 | Dec. 25, 2020 |

Note: The calibration interval of the above test instruments is 12 months and the calibrations are traceable to international system unit (SI).



Test Data

All the test modes completed for test. Only the worst result of reported as below:

Below 1GHz

Horizontal

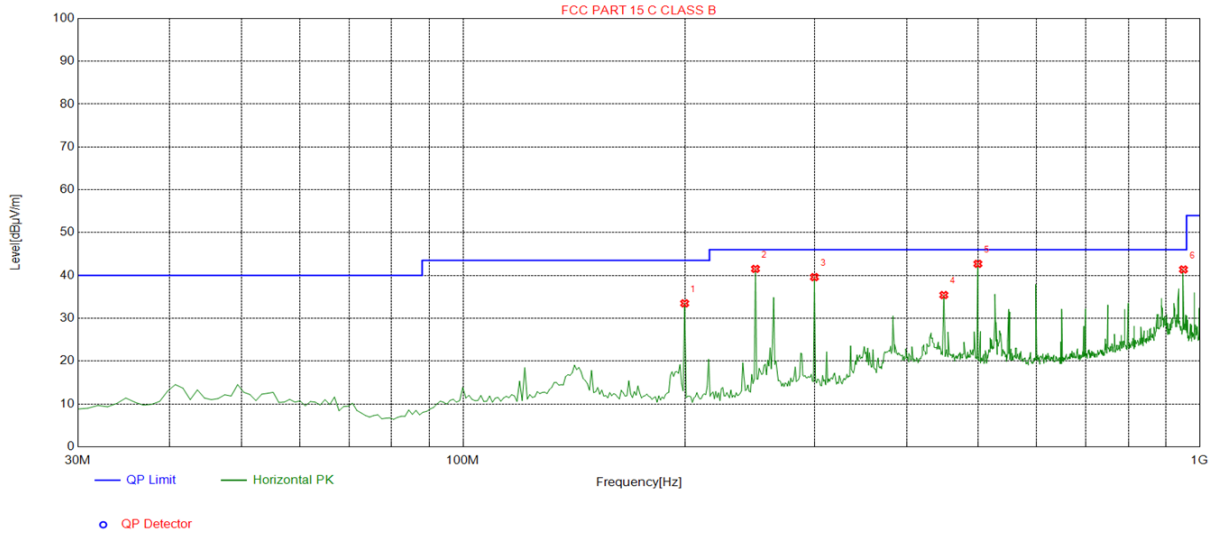

| Suspected List | | | | | | | | | |
|----------------|-------------|-------------|------------------|----------------|----------------|-------------|-------------|-----------|------------|
| NO. | Freq. [MHz] | Factor [dB] | Reading [dBµV/m] | Level [dBµV/m] | Limit [dBµV/m] | Margin [dB] | Height [cm] | Angle [°] | Polarity |
| 1 | 199.9199 | -15.07 | 48.55 | 33.48 | 43.50 | 10.02 | 100 | 194 | Horizontal |
| 2 | 249.4394 | -13.42 | 54.95 | 41.53 | 46.00 | 4.47 | 100 | 88 | Horizontal |
| 3 | 299.9299 | -12.74 | 52.34 | 39.60 | 46.00 | 6.40 | 100 | 278 | Horizontal |
| 4 | 449.4595 | -9.01 | 44.43 | 35.42 | 46.00 | 10.58 | 100 | 336 | Horizontal |
| 5 | 499.9500 | -8.30 | 51.01 | 42.71 | 46.00 | 3.29 | 100 | 336 | Horizontal |
| 6 | 950.4805 | -1.24 | 42.63 | 41.39 | 46.00 | 4.61 | 100 | 304 | Horizontal |

Remark: Factor = Cable loss + Antenna factor – Preamplifier; Level = Reading + Factor; Margin = Limit – Level



Vertical

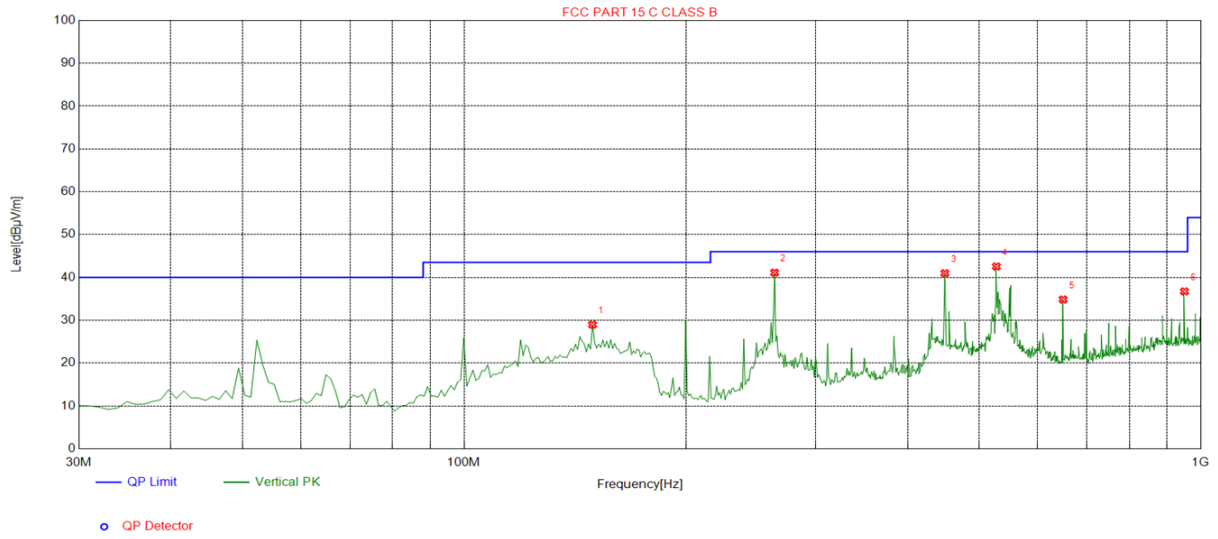

| Suspected List | | | | | | | | | |
|----------------|-------------|-------------|------------------|----------------|----------------|-------------|-------------|-----------|----------|
| NO. | Freq. [MHz] | Factor [dB] | Reading [dBµV/m] | Level [dBµV/m] | Limit [dBµV/m] | Margin [dB] | Height [cm] | Angle [°] | Polarity |
| 1 | 149.4294 | -18.95 | 47.94 | 28.99 | 43.50 | 14.51 | 100 | 204 | Vertical |
| 2 | 264.0040 | -13.58 | 54.70 | 41.12 | 46.00 | 4.88 | 100 | 41 | Vertical |
| 3 | 449.4595 | -9.01 | 49.98 | 40.97 | 46.00 | 5.03 | 100 | 310 | Vertical |
| 4 | 528.1081 | -7.50 | 50.05 | 42.55 | 46.00 | 3.45 | 100 | 348 | Vertical |
| 5 | 650.4505 | -5.79 | 40.63 | 34.84 | 46.00 | 11.16 | 100 | 348 | Vertical |
| 6 | 950.4805 | -1.24 | 37.97 | 36.73 | 46.00 | 9.27 | 100 | 182 | Vertical |

Remark: Factor = Cable loss + Antenna factor – Pre-amplifier; Level = Reading + Factor; Margin = Limit – Level
 Harmonics and Spurious Emissions

Frequency Range (9 kHz-30MHz)

| Frequency (MHz) | Level@3m (dBµV/m) | Limit@3m (dBµV/m) |
|-----------------|-------------------|-------------------|
| -- | -- | -- |
| -- | -- | -- |
| -- | -- | -- |
| -- | -- | -- |

- Note:** 1. Emission Level=Reading+ Cable loss-Antenna factor-Amp factor
 2. The emission levels are 20 dB below the limit value, which are not reported. It is deemed to comply with the requirement

**Above 1GHz****RADIATED EMISSION TEST**

LOW CH1 (802.11b Mode)/2412

Horizontal:

| Frequency (MHz) | Reading Result (dB μ V) | Factor (dB) | Emission Level (dB μ V/m) | Limits (dB μ V/m) | Margin (dB) | Detector Type |
|--------------------|--------------------------------|----------------|----------------------------------|--------------------------|----------------|------------------|
| 4824 | 58.95 | -3.64 | 55.31 | 74 | -18.69 | peak |
| 4824 | 46.72 | -3.64 | 43.08 | 54 | -10.92 | AVG |
| 7236 | 51.26 | -0.95 | 50.31 | 74 | -23.69 | peak |
| 7236 | 41.57 | -0.95 | 40.62 | 54 | -13.38 | AVG |

Remark: Factor = Antenna Factor + Cable Loss – Pre-amplifier.

Vertical:

| Frequency (MHz) | Reading Result (dB μ V) | Factor (dB) | Emission Level (dB μ V/m) | Limits (dB μ V/m) | Margin (dB) | Detector Type |
|--------------------|--------------------------------|----------------|----------------------------------|--------------------------|----------------|------------------|
| 4824 | 61.92 | -3.64 | 58.28 | 74 | -15.72 | peak |
| 4824 | 46.01 | -3.64 | 42.37 | 54 | -11.63 | AVG |
| 7236 | 51.68 | -0.95 | 50.73 | 74 | -23.27 | peak |
| 7236 | 42.33 | -0.95 | 41.38 | 54 | -12.62 | AVG |

Remark: Factor = Antenna Factor + Cable Loss – Pre-amplifier.



MID CH6 (802.11b Mode)/2437

Horizontal:

| Frequency | Reading Result | Factor | Emission Level | Limits | Margin | Detector Type |
|-----------|----------------|--------|----------------|----------------|--------|---------------|
| (MHz) | (dB μ V) | (dB) | (dB μ V/m) | (dB μ V/m) | (dB) | |
| 4874 | 60.61 | -3.51 | 57.1 | 74 | -16.9 | peak |
| 4874 | 43.92 | -3.51 | 40.41 | 54 | -13.59 | AVG |
| 7311 | 55.09 | -0.82 | 54.27 | 74 | -19.73 | peak |
| 7311 | 37.82 | -0.82 | 37 | 54 | -17 | AVG |

Remark: Factor = Antenna Factor + Cable Loss – Pre-amplifier.

Vertical:

| Frequency | Reading Result | Factor | Emission Level | Limits | Margin | Detector Type |
|-----------|----------------|--------|----------------|----------------|--------|---------------|
| (MHz) | (dB μ V) | (dB) | (dB μ V/m) | (dB μ V/m) | (dB) | |
| 4874 | 62.87 | -3.51 | 59.36 | 74 | -14.64 | peak |
| 4874 | 46.8 | -3.51 | 43.29 | 54 | -10.71 | AVG |
| 7311 | 56.92 | -0.82 | 56.1 | 74 | -17.9 | peak |
| 7311 | 41.27 | -0.82 | 40.45 | 54 | -13.55 | AVG |

Remark: Factor = Antenna Factor + Cable Loss – Pre-amplifier.



HIGH CH11 (802.11b Mode)/2462

Horizontal:

| Frequency | Reading Result | Factor | Emission Level | Limits | Margin | Detector Type |
|-----------|----------------|--------|----------------|----------------|--------|---------------|
| (MHz) | (dB μ V) | (dB) | (dB μ V/m) | (dB μ V/m) | (dB) | |
| 4924 | 59.46 | -3.43 | 56.03 | 74 | -17.97 | peak |
| 4924 | 40.24 | -3.43 | 36.81 | 54 | -17.19 | AVG |
| 7386 | 51.64 | -0.75 | 50.89 | 74 | -23.11 | peak |
| 7386 | 41.01 | -0.75 | 40.26 | 54 | -13.74 | AVG |

Remark: Factor = Antenna Factor + Cable Loss – Pre-amplifier.

Vertical:

| Frequency | Reading Result | Factor | Emission Level | Limits | Margin | Detector Type |
|-----------|----------------|--------|----------------|----------------|--------|---------------|
| (MHz) | (dB μ V) | (dB) | (dB μ V/m) | (dB μ V/m) | (dB) | |
| 4924 | 59.47 | -3.43 | 56.04 | 74 | -17.96 | peak |
| 4924 | 45.65 | -3.43 | 42.22 | 54 | -11.78 | AVG |
| 7386 | 50.4 | -0.75 | 49.65 | 74 | -24.35 | peak |
| 7386 | 39.23 | -0.75 | 38.48 | 54 | -15.52 | AVG |

Remark: Factor = Antenna Factor + Cable Loss – Pre-amplifier.

Remark:

- (1) Measuring frequencies from 1 GHz to the 25 GHz.
- (2) "F" denotes fundamental frequency; "H" denotes spurious frequency. "E" denotes band edge frequency.
- (3) * denotes emission frequency which appearing within the Restricted Bands specified in provision of 15.205, then the general radiated emission limits in 15.209 apply.
- (4) The emissions are attenuated more than 20dB below the permissible limits are not recorded in the report.
- (5) The IF bandwidth of EMI Test Receiver between 30MHz to 1GHz was 120KHz, 1 MHz for measuring above 1 GHz, below 30MHz was 10KHz.
- (6) When the test results of Peak Detected below the limits of Average Detected, the Average Detected is not need completed. For example: Top Channel at Fundamental 73.16dBuV/m(PK Value) <93.98(AV Limit), at harmonic 53.20 dBuV/m(PK Value) <54 dBuV/m(AV Limit), the Average Detected not need to completed.



LOW CH1 (802.11g Mode)/2412

Horizontal:

| Frequency | Reading Result | Factor | Emission Level | Limits | Margin | Detector Type |
|-----------|----------------|--------|----------------|----------------|--------|---------------|
| (MHz) | (dB μ V) | (dB) | (dB μ V/m) | (dB μ V/m) | (dB) | |
| 4824 | 60.43 | -3.64 | 56.79 | 74 | -17.21 | peak |
| 4824 | 46.85 | -3.64 | 43.21 | 54 | -10.79 | AVG |
| 7236 | 50.96 | -0.95 | 50.01 | 74 | -23.99 | peak |
| 7236 | 40.37 | -0.95 | 39.42 | 54 | -14.58 | AVG |

Remark: Factor = Antenna Factor + Cable Loss – Pre-amplifier.

Vertical:

| Frequency | Reading Result | Factor | Emission Level | Limits | Margin | Detector Type |
|-----------|----------------|--------|----------------|----------------|--------|---------------|
| (MHz) | (dB μ V) | (dB) | (dB μ V/m) | (dB μ V/m) | (dB) | |
| 4824 | 55.13 | -3.64 | 51.49 | 74 | -22.51 | peak |
| 4824 | 41.59 | -3.64 | 37.95 | 54 | -16.05 | AVG |
| 7236 | 55.37 | -0.95 | 54.42 | 74 | -19.58 | peak |
| 7236 | 42.2 | -0.95 | 41.25 | 54 | -12.75 | AVG |

Remark: Factor = Antenna Factor + Cable Loss – Pre-amplifier.



MID CH6 (802.11g Mode)/2437

Horizontal:

| Frequency | Reading Result | Factor | Emission Level | Limits | Margin | Detector Type |
|-----------|----------------|--------|----------------|----------------|--------|---------------|
| (MHz) | (dB μ V) | (dB) | (dB μ V/m) | (dB μ V/m) | (dB) | |
| 4874 | 57.63 | -3.51 | 54.12 | 74 | -19.88 | peak |
| 4874 | 42.69 | -3.51 | 39.18 | 54 | -14.82 | AVG |
| 7311 | 50.76 | -0.82 | 49.94 | 74 | -24.06 | peak |
| 7311 | 41.54 | -0.82 | 40.72 | 54 | -13.28 | AVG |

Remark: Factor = Antenna Factor + Cable Loss – Pre-amplifier.

Vertical:

| Frequency | Reading Result | Factor | Emission Level | Limits | Margin | Detector Type |
|-----------|----------------|--------|----------------|----------------|--------|---------------|
| (MHz) | (dB μ V) | (dB) | (dB μ V/m) | (dB μ V/m) | (dB) | |
| 4874 | 57.43 | -3.51 | 53.92 | 74 | -20.08 | peak |
| 4874 | 43.44 | -3.51 | 39.93 | 54 | -14.07 | AVG |
| 7311 | 56.34 | -0.82 | 55.52 | 74 | -18.48 | peak |
| 7311 | 39.68 | -0.82 | 38.86 | 54 | -15.14 | AVG |

Remark: Factor = Antenna Factor + Cable Loss – Pre-amplifier.



HIGH CH11 (802.11g Mode)/2462

Horizontal:

| Frequency (MHz) | Reading Result (dB μ V) | Factor (dB) | Emission Level (dB μ V/m) | Limits (dB μ V/m) | Margin (dB) | Detector Type |
|--------------------|--------------------------------|----------------|----------------------------------|--------------------------|----------------|------------------|
| 4924 | 61.11 | -3.43 | 57.68 | 74 | -16.32 | peak |
| 4924 | 43.17 | -3.43 | 39.74 | 54 | -14.26 | AVG |
| 7386 | 53.2 | -0.75 | 52.45 | 74 | -21.55 | peak |
| 7386 | 39.18 | -0.75 | 38.43 | 54 | -15.57 | AVG |

Remark: Factor = Antenna Factor + Cable Loss – Pre-amplifier.

Vertical:

| Frequency (MHz) | Reading Result (dB μ V) | Factor (dB) | Emission Level (dB μ V/m) | Limits (dB μ V/m) | Margin (dB) | Detector Type |
|--------------------|--------------------------------|----------------|----------------------------------|--------------------------|----------------|------------------|
| 4924 | 53.71 | -3.43 | 50.28 | 74 | -23.72 | peak |
| 4924 | 42.93 | -3.43 | 39.5 | 54 | -14.5 | AVG |
| 7386 | 48.77 | -0.75 | 48.02 | 74 | -25.98 | peak |
| 7386 | 36.72 | -0.75 | 35.97 | 54 | -18.03 | AVG |

Remark: Factor = Antenna Factor + Cable Loss – Pre-amplifier.

Remark:

- (1) Measuring frequencies from 1 GHz to the 25 GHz.
- (2) "F" denotes fundamental frequency; "H" denotes spurious frequency. "E" denotes band edge frequency.
- (3) * denotes emission frequency which appearing within the Restricted Bands specified in provision of 15.205, then the general radiated emission limits in 15.209 apply.
- (4) The emissions are attenuated more than 20dB below the permissible limits are not recorded in the report.
- (5) The IF bandwidth of EMI Test Receiver between 30MHz to 1GHz was 120KHz, 1 MHz for measuring above 1 GHz, below 30MHz was 10KHz.
- (6) When the test results of Peak Detected below the limits of Average Detected, the Average Detected is not need completed. For example: Top Channel at Fundamental 73.16dBuV/m(PK Value) <93.98(AV Limit), at harmonic 53.20 dBuV/m(PK Value) <54 dBuV/m(AV Limit), the Average Detected not need to completed.



LOW CH1 (802.11n/H20 Mode)/2412

Horizontal:

| Frequency | Reading Result | Factor | Emission Level | Limits | Margin | Detector Type |
|-----------|----------------|--------|----------------|----------------|--------|---------------|
| (MHz) | (dB μ V) | (dB) | (dB μ V/m) | (dB μ V/m) | (dB) | |
| 4824 | 59.41 | -3.64 | 55.77 | 74 | -18.23 | peak |
| 4824 | 40.05 | -3.64 | 36.41 | 54 | -17.59 | AVG |
| 7236 | 53.46 | -0.95 | 52.51 | 74 | -21.49 | peak |
| 7236 | 38.54 | -0.95 | 37.59 | 54 | -16.41 | AVG |

Remark: Factor = Antenna Factor + Cable Loss – Pre-amplifier.

Vertical:

| Frequency | Reading Result | Factor | Emission Level | Limits | Margin | Detector Type |
|-----------|----------------|--------|----------------|----------------|--------|---------------|
| (MHz) | (dB μ V) | (dB) | (dB μ V/m) | (dB μ V/m) | (dB) | |
| 4824 | 59.91 | -3.64 | 56.27 | 74 | -17.73 | peak |
| 4824 | 45.52 | -3.64 | 41.88 | 54 | -12.12 | AVG |
| 7236 | 49.85 | -0.95 | 48.9 | 74 | -25.1 | peak |
| 7236 | 40.22 | -0.95 | 39.27 | 54 | -14.73 | AVG |

Remark: Factor = Antenna Factor + Cable Loss – Pre-amplifier.



MID CH6 (802.11n/H20 Mode)/2437

Horizontal:

| Frequency | Reading Result | Factor | Emission Level | Limits | Margin | Detector Type |
|-----------|----------------|--------|----------------|----------------|--------|---------------|
| (MHz) | (dB μ V) | (dB) | (dB μ V/m) | (dB μ V/m) | (dB) | |
| 4874 | 56.09 | -3.51 | 52.58 | 74.00 | -21.42 | peak |
| 4874 | 43.32 | -3.51 | 39.81 | 54.00 | -14.19 | AVG |
| 7311 | 51.75 | -0.82 | 50.93 | 74.00 | -23.07 | peak |
| 7311 | 42.54 | -0.82 | 41.72 | 54.00 | -12.28 | AVG |

Remark: Factor = Antenna Factor + Cable Loss – Pre-amplifier.

Vertical:

| Frequency | Reading Result | Factor | Emission Level | Limits | Margin | Detector Type |
|-----------|----------------|--------|----------------|----------------|--------|---------------|
| (MHz) | (dB μ V) | (dB) | (dB μ V/m) | (dB μ V/m) | (dB) | |
| 4874 | 61.92 | -3.51 | 58.41 | 74.00 | -15.59 | peak |
| 4874 | 44.41 | -3.51 | 40.90 | 54.00 | -13.10 | AVG |
| 7311 | 52.30 | -0.82 | 51.48 | 74.00 | -22.52 | peak |
| 7311 | 34.69 | -0.82 | 33.87 | 54.00 | -20.13 | AVG |

Remark: Factor = Antenna Factor + Cable Loss – Pre-amplifier.



HIGH CH11 (802.11n/H20 Mode)/2462

Horizontal:

| Frequency | Reading Result | Factor | Emission Level | Limits | Margin | Detector Type |
|-----------|----------------|--------|----------------|----------------|--------|---------------|
| (MHz) | (dB μ V) | (dB) | (dB μ V/m) | (dB μ V/m) | (dB) | |
| 4924 | 59.78 | -3.43 | 56.35 | 74 | -17.65 | peak |
| 4924 | 43.17 | -3.43 | 39.74 | 54 | -14.26 | AVG |
| 7386 | 51.36 | -0.75 | 50.61 | 74 | -23.39 | peak |
| 7386 | 36.84 | -0.75 | 36.09 | 54 | -17.91 | AVG |

Remark: Factor = Antenna Factor + Cable Loss – Pre-amplifier.

Vertical:

| Frequency | Reading Result | Factor | Emission Level | Limits | Margin | Detector Type |
|-----------|----------------|--------|----------------|----------------|--------|---------------|
| (MHz) | (dB μ V) | (dB) | (dB μ V/m) | (dB μ V/m) | (dB) | |
| 4924 | 58.92 | -3.43 | 55.49 | 74 | -18.51 | peak |
| 4924 | 43.62 | -3.43 | 40.19 | 54 | -13.81 | AVG |
| 7386 | 55.05 | -0.75 | 54.3 | 74 | -19.7 | peak |
| 7386 | 40.41 | -0.75 | 39.66 | 54 | -14.34 | AVG |

Remark: Factor = Antenna Factor + Cable Loss – Pre-amplifier.



LOW CH3 (802.11n/H40 Mode)/2422

Horizontal:

| Frequency | Reading Result | Factor | Emission Level | Limits | Margin | Detector Type |
|-----------|----------------|--------|----------------|----------------|--------|---------------|
| (MHz) | (dB μ V) | (dB) | (dB μ V/m) | (dB μ V/m) | (dB) | |
| 4844 | 62.55 | -3.63 | 58.92 | 74 | -15.08 | peak |
| 4844 | 41.65 | -3.63 | 38.02 | 54 | -15.98 | AVG |
| 7266 | 54.75 | -0.94 | 53.81 | 74 | -20.19 | peak |
| 7266 | 37.6 | -0.94 | 36.66 | 54 | -17.34 | AVG |

Remark: Factor = Antenna Factor + Cable Loss – Pre-amplifier.

Vertical:

| Frequency | Reading Result | Factor | Emission Level | Limits | Margin | Detector Type |
|-----------|----------------|--------|----------------|----------------|--------|---------------|
| (MHz) | (dB μ V) | (dB) | (dB μ V/m) | (dB μ V/m) | (dB) | |
| 4844 | 59.84 | -3.63 | 56.21 | 74 | -17.79 | peak |
| 4844 | 40.06 | -3.63 | 36.43 | 54 | -17.57 | AVG |
| 7266 | 54.86 | -0.94 | 53.92 | 74 | -20.08 | peak |
| 7266 | 33.12 | -0.94 | 32.18 | 54 | -21.82 | AVG |

Remark: Factor = Antenna Factor + Cable Loss – Pre-amplifier.



MID CH6 (802.11n/H40 Mode)/2437

Horizontal:

| Frequency | Reading Result | Factor | Emission Level | Limits | Margin | Detector Type |
|-----------|----------------|--------|----------------|----------------|--------|---------------|
| (MHz) | (dB μ V) | (dB) | (dB μ V/m) | (dB μ V/m) | (dB) | |
| 4874 | 59.13 | -3.51 | 55.62 | 74 | -18.38 | peak |
| 4874 | 38.68 | -3.51 | 35.17 | 54 | -18.83 | AVG |
| 7311 | 54.56 | -0.82 | 53.74 | 74 | -20.26 | peak |
| 7311 | 34.68 | -0.82 | 33.86 | 54 | -20.14 | AVG |

Remark: Factor = Antenna Factor + Cable Loss – Pre-amplifier.

Vertical:

| Frequency | Reading Result | Factor | Emission Level | Limits | Margin | Detector Type |
|-----------|----------------|--------|----------------|----------------|--------|---------------|
| (MHz) | (dB μ V) | (dB) | (dB μ V/m) | (dB μ V/m) | (dB) | |
| 4874 | 59.71 | -3.51 | 56.2 | 74 | -17.8 | peak |
| 4874 | 44.83 | -3.51 | 41.32 | 54 | -12.68 | AVG |
| 7311 | 51.64 | -0.82 | 50.82 | 74 | -23.18 | peak |
| 7311 | 41.20 | -0.82 | 40.38 | 54 | -13.62 | AVG |

Remark: Factor = Antenna Factor + Cable Loss – Pre-amplifier.



HIGH CH9 (802.11n/H40 Mode)/2452

Horizontal:

| Frequency | Reading Result | Factor | Emission Level | Limits | Margin | Detector Type |
|-----------|----------------|--------|----------------|----------------|--------|---------------|
| (MHz) | (dB μ V) | (dB) | (dB μ V/m) | (dB μ V/m) | (dB) | |
| 4904 | 61.24 | -3.43 | 57.81 | 74 | -16.19 | peak |
| 4904 | 44.06 | -3.43 | 40.63 | 54 | -13.37 | AVG |
| 7356 | 51 | -0.75 | 50.25 | 74 | -23.75 | peak |
| 7356 | 37.68 | -0.75 | 36.93 | 54 | -17.07 | AVG |

Remark: Factor = Antenna Factor + Cable Loss – Pre-amplifier.

Vertical:

| Frequency | Reading Result | Factor | Emission Level | Limits | Margin | Detector Type |
|-----------|----------------|--------|----------------|----------------|--------|---------------|
| (MHz) | (dB μ V) | (dB) | (dB μ V/m) | (dB μ V/m) | (dB) | |
| 4904 | 58.07 | -3.43 | 54.64 | 74 | -19.36 | peak |
| 4904 | 39.85 | -3.43 | 36.42 | 54 | -17.58 | AVG |
| 7356 | 53.77 | -0.75 | 53.02 | 74 | -20.98 | peak |
| 7356 | 44.65 | -0.75 | 43.9 | 54 | -10.1 | AVG |

Remark: Factor = Antenna Factor + Cable Loss – Pre-amplifier.

Remark:

- (1) Measuring frequencies from 1 GHz to the 25 GHz.
- (2) "F" denotes fundamental frequency; "H" denotes spurious frequency. "E" denotes band edge frequency.
- (3) * denotes emission frequency which appearing within the Restricted Bands specified in provision of 15.205, then the general radiated emission limits in 15.209 apply.
- (4))The emissions are attenuated more than 20dB below the permissible limits are not recorded in the report.
- (5) The IF bandwidth of EMI Test Receiver between 30MHz to 1GHz was 120KHz, 1 MHz for measuring above 1 GHz, below 30MHz was 10KHz.
- (6) When the test results of Peak Detected below the limits of Average Detected, the Average Detected is not need completed. For example: Top Channel at Fundamental 73.16dBuV/m(PK Value) <93.98(AV Limit), at harmonic 53.20 dBuV/m(PK Value) <54 dBuV/m(AV Limit), the Average Detected not need to completed.

**Test Result of Radiated Spurious at Band edges**

Operation Mode:
802.11b Mode TX CH Low (2412MHz)

Horizontal

| Frequency | Reading Result | Factor | Emission Level | Limits | Margin | Detector Type |
|-----------|----------------|--------|----------------|----------------|--------|---------------|
| (MHz) | (dB μ V) | (dB) | (dB μ V/m) | (dB μ V/m) | (dB) | |
| 2310.00 | 58.42 | -5.81 | 52.61 | 74 | -21.39 | peak |
| 2310.00 | / | -5.81 | / | 54 | / | AVG |
| 2390.00 | 63.56 | -5.84 | 57.72 | 74 | -16.28 | peak |
| 2390.00 | 46.33 | -5.84 | 40.49 | 54 | -13.51 | AVG |

Remark: Factor = Antenna Factor + Cable Loss – Pre-amplifier.

Vertical:

| Frequency | Reading Result | Factor | Emission Level | Limits | Margin | Detector Type |
|-----------|----------------|--------|----------------|----------------|--------|---------------|
| (MHz) | (dB μ V) | (dB) | (dB μ V/m) | (dB μ V/m) | (dB) | |
| 2310.00 | 59.36 | -5.81 | 53.55 | 74 | -20.45 | peak |
| 2310.00 | / | -5.81 | / | 54 | / | AVG |
| 2390.00 | 67.22 | -5.84 | 61.38 | 74 | -12.62 | peak |
| 2390.00 | 46.64 | -5.84 | 40.8 | 54 | -13.2 | AVG |

Remark: Factor = Antenna Factor + Cable Loss – Pre-amplifier.



Operation Mode: TX CH High (2462MHz)

Horizontal

| Frequency | Reading Result | Factor | Emission Level | Limits | Margin | Detector Type |
|---|----------------|--------|----------------|----------------|--------|---------------|
| (MHz) | (dB μ V) | (dB) | (dB μ V/m) | (dB μ V/m) | (dB) | |
| 2483.50 | 59.63 | -5.81 | 53.82 | 74 | -20.18 | peak |
| 2483.50 | / | -5.81 | / | 54 | / | AVG |
| 2500.00 | 58.25 | -6.06 | 52.19 | 74 | -21.81 | peak |
| 2500.00 | / | -6.06 | / | 54 | / | AVG |
| Remark: Factor = Antenna Factor + Cable Loss – Pre-amplifier. | | | | | | |

Vertical:

| Frequency | Reading Result | Factor | Emission Level | Limits | Margin | Detector Type |
|--|----------------|--------|----------------|----------------|--------|---------------|
| (MHz) | (dB μ V) | (dB) | (dB μ V/m) | (dB μ V/m) | (dB) | |
| 2483.50 | 58.63 | -5.81 | 52.82 | 74 | -21.18 | peak |
| 2483.50 | / | -5.81 | / | 54 | / | AVG |
| 2500.00 | 59.33 | -6.06 | 53.27 | 74 | -20.73 | peak |
| 2500.00 | / | -6.06 | / | 54 | / | AVG |
| Remark: Factor = Antenna Factor + Cable Loss – Pre-amplifier. | | | | | | |
| Remark: All the other emissions not reported were too low to read and deemed to comply with FCC limit. | | | | | | |



Operation Mode: 802.11g Mode TX CH Low (2412MHz)

Horizontal

| Frequency | Reading Result | Factor | Emission Level | Limits | Margin | Detector Type |
|-----------|----------------|--------|----------------|----------------|--------|---------------|
| (MHz) | (dB μ V) | (dB) | (dB μ V/m) | (dB μ V/m) | (dB) | |
| 2310.00 | 57.22 | -5.81 | 51.41 | 74 | -22.59 | peak |
| 2310.00 | / | -5.81 | / | 54 | / | AVG |
| 2390.00 | 65.39 | -5.84 | 59.55 | 74 | -14.45 | peak |
| 2390.00 | 49.57 | -5.84 | 43.73 | 54 | -10.27 | AVG |

Remark: Factor = Antenna Factor + Cable Loss – Pre-amplifier.

Vertical:

| Frequency | Reading Result | Factor | Emission Level | Limits | Margin | Detector Type |
|-----------|----------------|--------|----------------|----------------|--------|---------------|
| (MHz) | (dB μ V) | (dB) | (dB μ V/m) | (dB μ V/m) | (dB) | |
| 2310.00 | 59.63 | -5.81 | 53.82 | 74 | -20.18 | peak |
| 2310.00 | / | -5.81 | / | 54 | / | AVG |
| 2390.00 | 64.77 | -5.84 | 58.93 | 74 | -15.07 | peak |
| 2390.00 | 49.32 | -5.84 | 43.48 | 54 | -10.52 | AVG |

Remark: Factor = Antenna Factor + Cable Loss – Pre-amplifier.



Operation Mode: TX CH High (2462MHz)

Horizontal

| Frequency | Reading Result | Factor | Emission Level | Limits | Margin | Detector Type |
|-----------|----------------|--------|----------------|----------------|--------|---------------|
| (MHz) | (dB μ V) | (dB) | (dB μ V/m) | (dB μ V/m) | (dB) | |
| 2483.50 | 58.43 | -5.65 | 52.78 | 74 | -21.22 | peak |
| 2483.50 | / | -5.65 | / | 54 | / | AVG |
| 2500.00 | 58.62 | -5.65 | 52.97 | 74 | -21.03 | peak |
| 2500.00 | / | -5.65 | / | 54 | / | AVG |

Remark: Factor = Antenna Factor + Cable Loss – Pre-amplifier.

Vertical:

| Frequency | Reading Result | Factor | Emission Level | Limits | Margin | Detector Type |
|-----------|----------------|--------|----------------|----------------|--------|---------------|
| (MHz) | (dB μ V) | (dB) | (dB μ V/m) | (dB μ V/m) | (dB) | |
| 2483.50 | 58.43 | -5.65 | 52.78 | 74 | -21.22 | peak |
| 2483.50 | / | -5.65 | / | 54 | / | AVG |
| 2500.00 | 59.27 | -5.65 | 53.62 | 74 | -20.38 | peak |
| 2500.00 | / | -5.65 | / | 54 | / | AVG |

Remark: Factor = Antenna Factor + Cable Loss – Pre-amplifier.

Remark: All the other emissions not reported were too low to read and deemed to comply with FCC limit.



Operation Mode: 802.11n/H20 Mode TX CH Low (2412MHz)

Horizontal

| Frequency | Reading Result | Factor | Emission Level | Limits | Margin | Detector Type |
|-----------|----------------|--------|----------------|----------------|--------|---------------|
| (MHz) | (dB μ V) | (dB) | (dB μ V/m) | (dB μ V/m) | (dB) | |
| 2310.00 | 57.37 | -5.81 | 51.56 | 74 | -22.44 | peak |
| 2310.00 | / | -5.81 | / | 54 | / | AVG |
| 2390.00 | 66.22 | -5.84 | 60.38 | 74 | -13.62 | peak |
| 2390.00 | 46.78 | -5.84 | 40.94 | 54 | -13.06 | AVG |

Remark: Factor = Antenna Factor + Cable Loss – Pre-amplifier.

Vertical:

| Frequency | Reading Result | Factor | Emission Level | Limits | Margin | Detector Type |
|-----------|----------------|--------|----------------|----------------|--------|---------------|
| (MHz) | (dB μ V) | (dB) | (dB μ V/m) | (dB μ V/m) | (dB) | |
| 2310.00 | 59.32 | -5.81 | 53.51 | 74 | -20.49 | peak |
| 2310.00 | / | -5.81 | / | 54 | / | AVG |
| 2390.00 | 65.67 | -5.84 | 59.83 | 74 | -14.17 | peak |
| 2390.00 | 47.78 | -5.84 | 41.94 | 54 | -12.06 | AVG |

Remark: Factor = Antenna Factor + Cable Loss – Pre-amplifier.



Operation Mode: TX CH High (2462MHz)

Horizontal

| Frequency | Reading Result | Factor | Emission Level | Limits | Margin | Detector Type |
|-----------|----------------|--------|----------------|----------------|--------|---------------|
| (MHz) | (dB μ V) | (dB) | (dB μ V/m) | (dB μ V/m) | (dB) | |
| 2483.50 | 59.43 | -5.65 | 53.78 | 74 | -20.22 | peak |
| 2483.50 | / | -5.65 | / | 54 | / | AVG |
| 2500.00 | 57.79 | -5.65 | 52.14 | 74 | -21.86 | peak |
| 2500.00 | / | -5.65 | / | 54 | / | AVG |

Remark: Factor = Antenna Factor + Cable Loss – Pre-amplifier.

Vertical:

| Frequency | Reading Result | Factor | Emission Level | Limits | Margin | Detector Type |
|-----------|----------------|--------|----------------|----------------|--------|---------------|
| (MHz) | (dB μ V) | (dB) | (dB μ V/m) | (dB μ V/m) | (dB) | |
| 2483.50 | 57.54 | -5.65 | 51.89 | 74 | -22.11 | peak |
| 2483.50 | / | -5.65 | / | 54 | / | AVG |
| 2500.00 | 58.66 | -5.65 | 53.01 | 74 | -20.99 | peak |
| 2500.00 | / | -5.65 | / | 54 | / | AVG |

Remark: Factor = Antenna Factor + Cable Loss – Pre-amplifier.

Remark: All the other emissions not reported were too low to read and deemed to comply with FCC limit.



Operation Mode: 802.11n/H40 Mode TX CH Low (2422MHz)

Horizontal

| Frequency | Reading Result | Factor | Emission Level | Limits | Margin | Detector Type |
|-----------|----------------|--------|----------------|----------------|--------|---------------|
| (MHz) | (dB μ V) | (dB) | (dB μ V/m) | (dB μ V/m) | (dB) | |
| 2310.00 | 57.27 | -5.81 | 51.46 | 74 | -22.54 | peak |
| 2310.00 | / | -5.81 | / | 54 | / | AVG |
| 2390.00 | 63.45 | -5.84 | 57.61 | 74 | -16.39 | peak |
| 2390.00 | 49.66 | -5.84 | 43.82 | 54 | -10.18 | AVG |

Remark: Factor = Antenna Factor + Cable Loss – Pre-amplifier.

Vertical:

| Frequency | Reading Result | Factor | Emission Level | Limits | Margin | Detector Type |
|-----------|----------------|--------|----------------|----------------|--------|---------------|
| (MHz) | (dB μ V) | (dB) | (dB μ V/m) | (dB μ V/m) | (dB) | |
| 2310.00 | 56.34 | -5.81 | 50.53 | 74 | -23.47 | peak |
| 2310.00 | / | -5.81 | / | 54 | / | AVG |
| 2390.00 | 64.55 | -5.84 | 58.71 | 74 | -15.29 | peak |
| 2390.00 | 49.23 | -5.84 | 43.39 | 54 | -10.61 | AVG |

Remark: Factor = Antenna Factor + Cable Loss – Pre-amplifier.



Operation Mode: TX CH High (2452MHz)

Horizontal

| Frequency | Reading Result | Factor | Emission Level | Limits | Margin | Detector Type |
|-----------|----------------|--------|----------------|----------------|--------|---------------|
| (MHz) | (dB μ V) | (dB) | (dB μ V/m) | (dB μ V/m) | (dB) | |
| 2483.50 | 57.27 | -5.65 | 51.62 | 74 | -22.38 | peak |
| 2483.50 | / | -5.65 | / | 54 | / | AVG |
| 2500.00 | 58.55 | -5.65 | 52.9 | 74 | -21.1 | peak |
| 2500.00 | / | -5.65 | / | 54 | / | AVG |

Remark: Factor = Antenna Factor + Cable Loss – Pre-amplifier.

Vertical:

| Frequency | Reading Result | Factor | Emission Level | Limits | Margin | Detector Type |
|-----------|----------------|--------|----------------|----------------|--------|---------------|
| (MHz) | (dB μ V) | (dB) | (dB μ V/m) | (dB μ V/m) | (dB) | |
| 2483.50 | 57.43 | -5.65 | 51.78 | 74 | -22.22 | peak |
| 2483.50 | / | -5.65 | / | 54 | / | AVG |
| 2500.00 | 56.37 | -5.65 | 50.72 | 74 | -23.28 | peak |
| 2500.00 | / | -5.65 | / | 54 | / | AVG |

Remark: Factor = Antenna Factor + Cable Loss – Pre-amplifier.

Remark: All the other emissions not reported were too low to read and deemed to comply with FCC limit.



4.7. ANTENNA REQUIREMENT

Standard Applicable

For intentional device, according to FCC 47 CFR Section 15.203, an intentional radiator shall be designed to ensure that no antenna other than that furnished by the responsible party shall be used with the device. And according to FCC 47 CFR Section 15.247, if transmitting antennas of directional gain greater than 6dBi are used, the power shall be reduced by the amount in dB that the directional gain of the antenna exceeds 6dBi.

Refer to statement below for compliance.

The manufacturer may design the unit so that the user can replace a broken antenna, but the use of a standard antenna jack or electrical connector is prohibited. Further, this requirement does not apply to intentional radiators that must be professionally installed.

Antenna Connected Construction

The antenna used in this product is a External Antenna, with non-standard SMA connector, need professional installation, not easy to remove. It conforms to the standard requirements. The directional gains of antenna used for transmitting is 2dBi.

WIFI ANTENNA

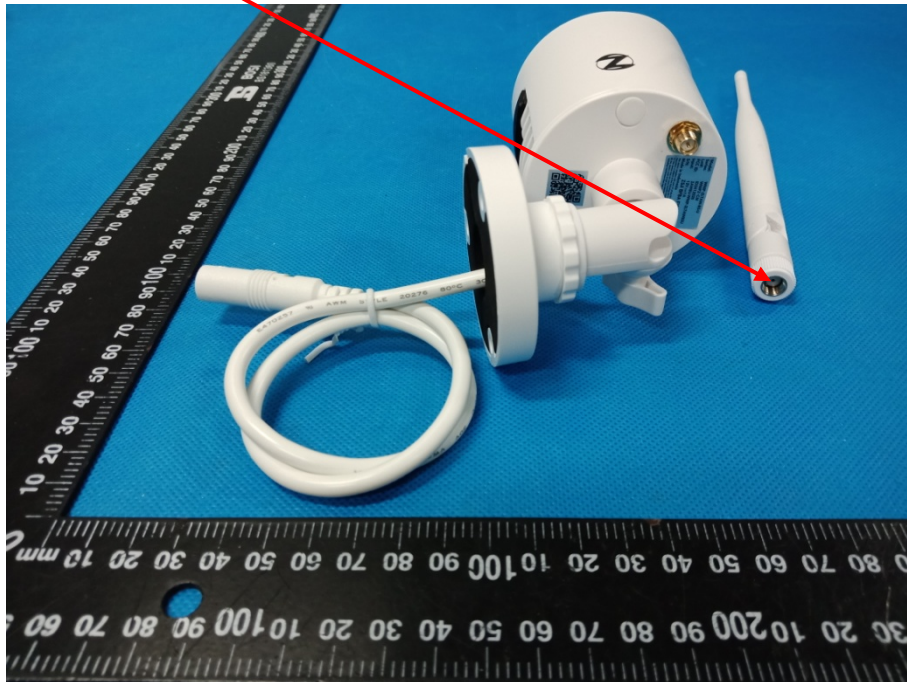

4.8. PHOTOGRAPH OF TEST

Radiated Emission

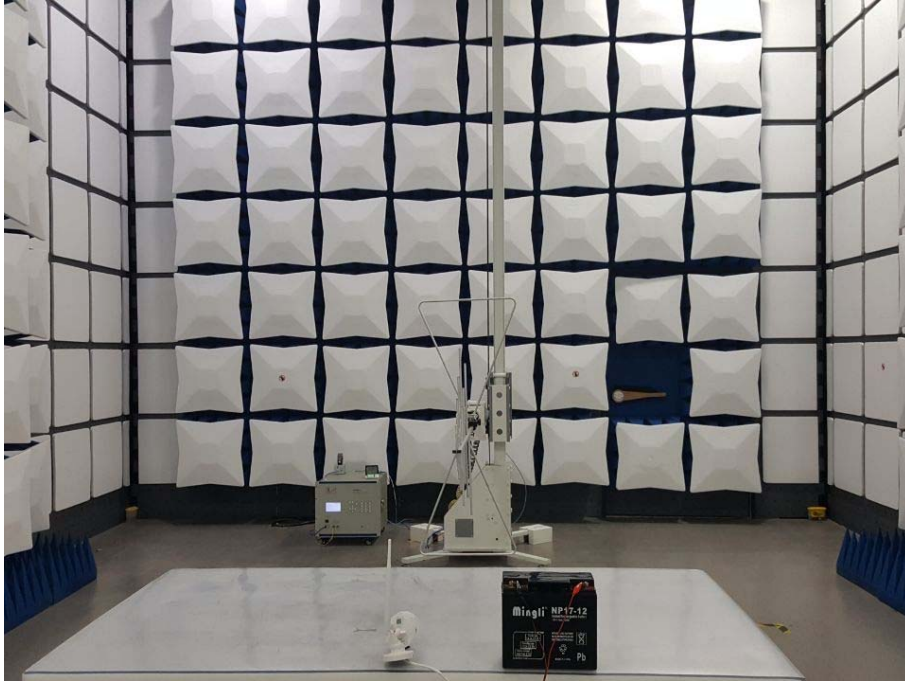



4.9. PHOTOS OF THE EUT

Reference to the reporter : ANNEX A of external photos and ANNEX B of internal photos

-----End of test report-----