



## FCC TEST REPORT

Report No.: STS2201129W03

Issued for

Litum bilgi teknolojileri san. Ve dis tic. A.S

Sevket Ozcelik sok. No29 Alsancak izmir Turkey

<b>Product Name:</b>	430 Collision Warning System
<b>Brand Name:</b>	Litum
<b>Model Name:</b>	430
<b>Series Model:</b>	4300000001, 4300000002, 4300000003
<b>FCC ID:</b>	2AW7W430
<b>IC:</b>	26820-430
<b>Test Standard:</b>	FCC Part 15.249
	RSS 210 Issue 10, Amendment, 2020

Any reproduction of this document must be done in full. No single part of this document may be reproduced without permission from STS, All Test Data Presented in this report is only applicable to presented Test sample.

Shenzhen STS Test Services Co., Ltd.  
A 1/F, Building B, Zhuoke Science Park, No.190 Chongqing Road, HepingShequ  
Fuyong Sub-District, Bao'an District, Shenzhen, Guang Dong, China  
TEL: +86-755 3688 6288 FAX: +86-755 3688 6277 E-mail: sts@stsapp.com

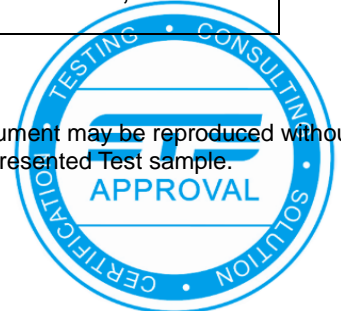



TEST RESULT CERTIFICATION

Applicant's Name .....: Litum bilgi teknolojileri san. Ve dis tic. A.S
Address.....: Sevket Ozcelik sok. No29 Alsancak izmir Turkey
Manufacturer's Name .....: Litum bilgi teknolojileri san. Ve dis tic. A.S
Address.....: Sevket Ozcelik sok. No29 Alsancak izmir Turkey

Product Description

Product Name .....: 430 Collision Warning System
Brand Name .....: Litum
Model Name.....: 430
Series Model .....: 4300000001, 4300000002, 4300000003

Test Standards.....: FCC Part15.249
RSS 210 Issue 10, Amendment, 2020

Test Procedure.....: ANSI C63.10-2013

This device described above has been tested by STS, the test results show that the equipment under test (EUT) is in compliance with the FCC/IC requirements. And it is applicable only to the tested sample identified in the report.

This report shall not be reproduced except in full, without the written approval of STS, this document only be altered or revised by STS, personal only, and shall be noted in the revision of the document.

Date of Test.....:
Date of receipt of test item.....: 22 Feb. 2022
Date of performance of tests ...: 22 Feb. 2022 ~ 03 Mar. 2022
Date of Issue .....: 03 Mar. 2022
Test Result .....: Pass

Testing Engineer : [Signature]

(Chris Chen)

Technical Manager : [Signature]

(Sean she)

Authorized Signatory : [Signature]

(Vita Li)





Table of Contents	Page
<b>1. SUMMARY OF TEST RESULTS</b>	<b>5</b>
1.1 TEST FACTORY	6
1.2 MEASUREMENT UNCERTAINTY	6
<b>2. GENERAL INFORMATION</b>	<b>7</b>
2.1 GENERAL DESCRIPTION OF THE EUT	7
2.2 DESCRIPTION OF THE TEST MODES	8
2.3 TEST SOFTWARE AND POWER LEVEL	8
2.4 BLOCK DIAGRAM SHOWING THE CONFIGURATION OF SYSTEM TESTED	8
2.5 DESCRIPTION OF NECESSARY ACCESSORIES AND SUPPORT UNITS	9
2.6 EQUIPMENTS LIST FOR ALL TEST ITEMS	10
<b>3. EMC EMISSION TEST</b>	<b>12</b>
3.1 CONDUCTED EMISSION MEASUREMENT	12
3.2 RADIATED EMISSION MEASUREMENT	14
<b>4. BANDWIDTH TEST</b>	<b>28</b>
4.1 TEST PROCEDURE	28
4.2 TEST SETUP	28
4.3 EUT OPERATION CONDITIONS	28
4.4 TEST RESULTS	29
<b>5. ANTENNA REQUIREMENT</b>	<b>30</b>
5.1 STANDARD REQUIREMENT	30
5.2 EUT ANTENNA	30
<b>APPENDIX- PHOTOS OF TEST SETUP</b>	<b>31</b>



**Revision History**

Rev.	Issue Date	Report NO.	Effect Page	Contents
00	03 Mar. 2022	STS2201129W03	ALL	Initial Issue





## 1. SUMMARY OF TEST RESULTS

Test procedures according to the technical standards:

<b>FCC Part 15.249 , Subpart C RSS 210 Issue 10</b>			
Standard Section	Test Item	Judgment	Remark
15.207 RSS-Gen Issue 5	Conducted Emission	N/A	
15.203 RSS-Gen Issue 5	Antenna Requirement	Pass	
15.249 RSS 210 Issue 10	Radiated Spurious Emission	Pass	
15.249 RSS 210 Issue 10	Radiated Band Edge Emission	Pass	
15.215 RSS-Gen Issue 5	Occupied Bandwidth	Pass	

### NOTE:

- (1) 'N/A' denotes test is not applicable in this Test Report.
- (2) All tests are according to ANSI C63.10-2013.

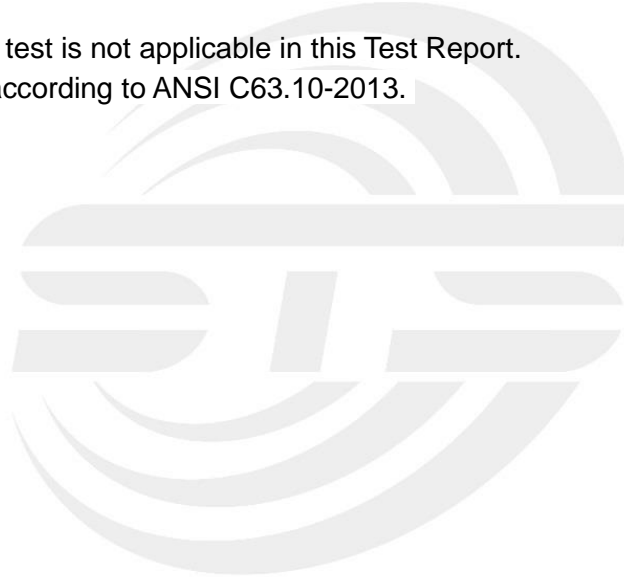



### 1.1 TEST FACTORY

SHENZHEN STS TEST SERVICES CO., LTD

Add. : A 1/F, Building B, Zhuoke Science Park, No.190 Chongqing Road, HepingShequ, Fuyong Sub-District, Bao'an District, Shenzhen, Guang Dong, China

FCC test Firm Registration Number: 625569

IC test Firm Registration Number: 12108A

A2LA Certificate No.: 4338.01

### 1.2 MEASUREMENT UNCERTAINTY

The reported uncertainty of measurement  $y \pm U$ , where expanded uncertainty  $U$  is based on a standard uncertainty multiplied by a coverage factor of  $k=2$ , providing a level of confidence of approximately **95 %**.

No.	Item	Uncertainty
1	RF output power, conducted	$\pm 0.87$ dB
2	Unwanted Emissions, conducted	$\pm 2.895$ dB
3	All emissions, radiated 9K-30MHz	$\pm 3.80$ dB
4	All emissions, radiated 30M-1GHz	$\pm 4.09$ dB
5	All emissions, radiated 1G-6GHz	$\pm 4.92$ dB
6	All emissions, radiated >6G	$\pm 5.49$ dB
7	Conducted Emission (9KHz-30MHz)	$\pm 2.73$ dB



## 2. GENERAL INFORMATION

### 2.1 GENERAL DESCRIPTION OF THE EUT

Product Name/PMN	430 Collision Warning System	
Trade Name	Litum	
Model Name/HVIN	430	
Series Model	4300000001, 4300000002, 4300000003	
Model Difference	Only difference in model name.	
Product Description	The EUT is a 430 Collision Warning System	
	Operation Frequency:	2475MHz
	Modulation Type:	GFSK
	Antenna Designation:	Please refer to the Note 2.
	Antenna Gain(Peak):	2.16dBi
	Based on the application, features, or specification exhibited in User Manual, the EUT is considered as an ITE/Computing Device. More details of EUT technical specification, please refer to the User Manual.	
Rating	Input: 9-30V	
Hardware version number	AFA01-01-02	
Software version number/FVIN	1.15.15.0	
Serial Numbers	4300000003	
Connecting I/O Port(s)	Please refer to the Note 1.	

Note:

- For a more detailed features description, please refer to the manufacturer's specifications or the User Manual.
- Table for Filed Antenna

Ant	Brand	Model Name	Antenna Type	Connector	Gain (dBi)	NOTE
1	Litum	430	PCB	N/A	2.16	Antenna

Note: The antenna information refer the manufacturer provide report, applicable only to the tested sample identified in the report.

## 2.2 DESCRIPTION OF THE TEST MODES

For conducted test items and radiated spurious emissions  
 Each of these EUT operation mode(s) or test configuration mode(s) mentioned below was evaluated respectively.

Pretest Mode	Description	Data/Modulation
Mode 1	TX	GFSK

Note:

(1) All above mode have been measurement, only worst data was reported.

## 2.3 TEST SOFTWARE AND POWER LEVEL

During testing channel & power controlling software provided by the customer was used to control the operating channel as well as the output power level.

RF Function	Type	Mode Or Modulation type	ANT Gain(dBi)	Power Class	Software For Testing
2.4G	2475MHz	GFSK	2.16	Default	Tera Term

## 2.4 BLOCK DIAGRAM SHOWING THE CONFIGURATION OF SYSTEM TESTED

During testing channel & power controlling software provided by the customer was used to control the operating channel as well as the output power level. The RF output power selection is for the setting of RF output power expected by the customer and is going to be fixed on the firmware of the final end product power parameters.

Radiated Spurious Emission Test

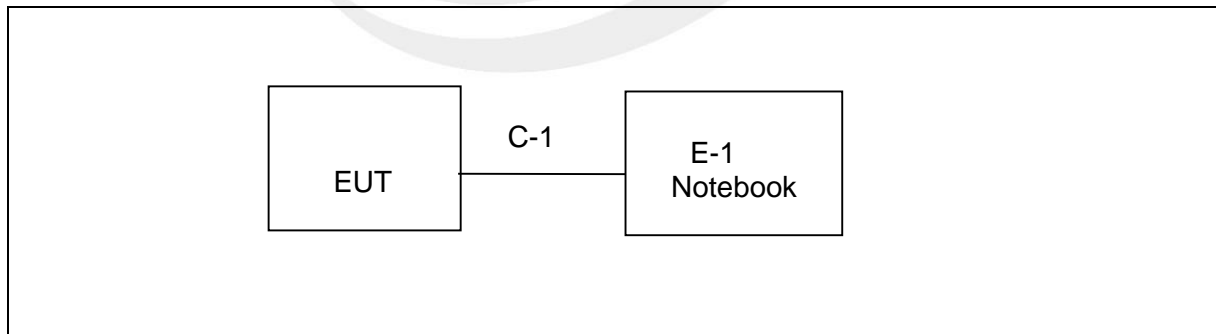





## 2.5 DESCRIPTION OF NECESSARY ACCESSORIES AND SUPPORT UNITS

The EUT has been tested as an independent unit together with other necessary accessories or support units. The following support units or accessories were used to form a representative test configuration during the tests.

### Necessary accessories

Item	Equipment	Mfr/Brand	Model/Type No.	Length	Note
N/A	N/A	N/A	N/A	N/A	N/A

### Support units

Item	Equipment	Mfr/Brand	Model/Type No.	Length	Note
E-1	Notebook	LENOVO	Think Pad E470	N/A	N/A
C-1	USB Cable	N/A	N/A	150cm	NO

#### Note:

- (1) For detachable type I/O cable should be specified the length in cm in 『Length』 column.

## 2.6 EQUIPMENTS LIST FOR ALL TEST ITEMS

### Radiation Test equipment

Kind of Equipment	Manufacturer	Type No.	Serial No.	Last calibration	Calibrated until
Test Receiver	R&S	ESCI	101427	2021.09.30	2022.09.29
Signal Analyzer	R&S	FSV 40-N	101823	2021.09.30	2022.09.29
Active loop Antenna	ZHINAN	ZN30900C	16035	2021.04.11	2023.04.10
Bilog Antenna	TESEQ	CBL6111D	34678	2020.10.12	2022.10.11
Horn Antenna	SCHWARZBECK	BBHA 9120D	02014	2021.10.11	2023.10.10
SHF-EHF Horn Antenna (18G-40GHz)	A-INFO	LB-180400-KF	J211020657	2020.10.12	2022.10.11
Pre-Amplifier(0.1M-3 GHz)	EM	EM330	060665	2021.10.08	2022.10.07
Pre-Amplifier (1G-18GHz)	SKET	LNPA-01018G-45	SK2018080901	2021.09.30	2022.09.29
Pre-Amplifier (18G-40GHz)	SKET	LNPA-1840-50	SK2018101801	2021.09.28	2022.09.27
Temperature & Humidity	HH660	Mieo	N/A	2021.10.09	2022.10.08
turn table	EM	SC100_1	60531	N/A	N/A
Antenna mast	EM	SC100	N/A	N/A	N/A
Test SW	FARAD	EZ-EMC(Ver.STSLAB-03A1 RE)			

### Conduction Test equipment

Kind of Equipment	Manufacturer	Type No.	Serial No.	Last calibration	Calibrated until
Test Receiver	R&S	ESCI	101427	2021.09.30	2022.09.29
LISN	R&S	ENV216	101242	2021.09.30	2022.09.29
LISN	EMCO	3810/2NM	23625	2021.09.30	2022.09.29
Temperature & Humidity	HH660	Mieo	N/A	2021.10.09	2022.10.08
Test SW	FARAD	EZ-EMC(Ver.STSLAB-03A1 CE)			



## RF Connected Test

Kind of Equipment	Manufacturer	Type No.	Serial No.	Last calibration	Calibrated until
Power Sensor	Keysight	U2021XA	MY55520005	2021.09.30	2022.09.29
			MY55520006	2021.09.30	2022.09.29
			MY56120038	2021.09.30	2022.09.29
			MY56280002	2021.09.30	2022.09.29
Signal Analyzer	Agilent	N9020A	MY51110105	2021.03.04	2022.03.03
Temperature & Humidity	HH660	Mieo	N/A	2021.10.09	2022.10.08
Test SW	FARAD	EZ-EMC(Ver.STSLAB-03A1 RE)			





### 3. EMC EMISSION TEST

#### 3.1 CONDUCTED EMISSION MEASUREMENT

##### 3.1.1 POWER LINE CONDUCTED EMISSION LIMITS

The radio frequency voltage that is conducted back onto the AC power line on any frequency or frequencies, within the band 150 kHz to 30 MHz, shall not exceed the limits in the following table.

FREQUENCY (MHz)	Quasi-peak	Average
0.15 -0.5	66 - 56 *	56 - 46 *
0.50 -5.0	56.00	46.00
5.0 -30.0	60.00	50.00

Note:

- (1) The tighter limit applies at the band edges.
- (2) The limit of “\*” marked band means the limitation decreases linearly with the logarithm of the frequency in the range.

The following table is the setting of the receiver

Receiver Parameters	Setting
Attenuation	10 dB
Start Frequency	0.15 MHz
Stop Frequency	30 MHz
IF Bandwidth	9 kHz

3.1.2 TEST PROCEDURE

- a. The EUT is 0.8 m from the horizontal ground plane and 0.4 m from the vertical ground plane with EUT being connected to the power mains through a line impedance stabilization network (LISN). All other support equipments are powered from additional LISN(s). The LISN provides 50 Ohm/ 50uH of coupling impedance for the measuring instrument.
- b. Interconnecting cables that hang closer than 40 cm to the ground plane shall be folded back and forth in the center forming a bundle 30 to 40 cm long.
- c. I/O cables that are not connected to a peripheral shall be bundled in the center. The end of the cable may be terminated, if required, using the correct terminating impedance. The overall length shall not exceed 1 m.
- d. LISN is at least 80 cm from the nearest part of EUT chassis.
- e. For the actual test configuration, please refer to the related Item –EUT Test Photos.

3.1.3 TEST SETUP

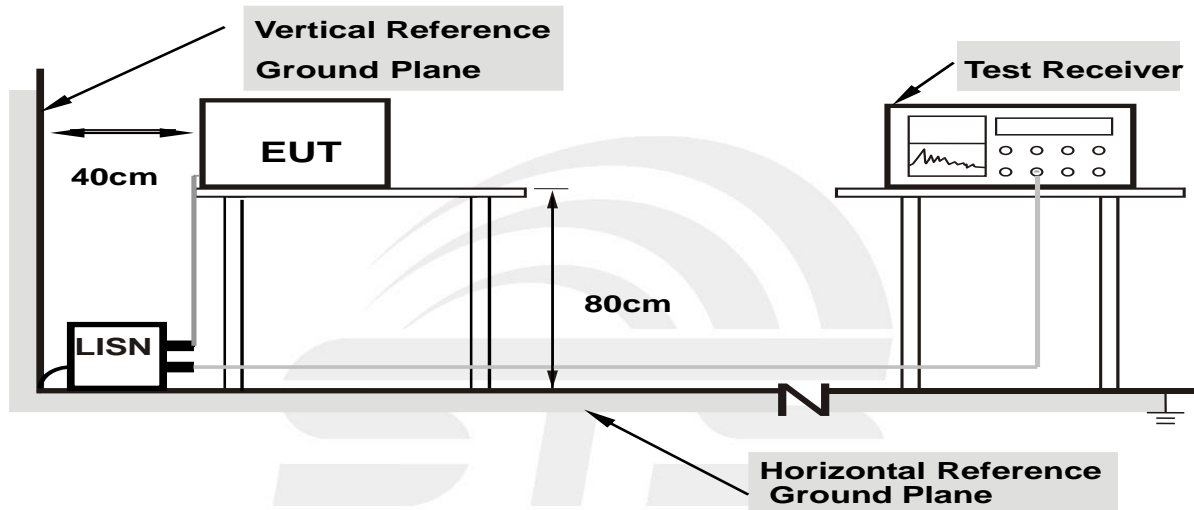

- Note: 1.Support units were connected to second LISN.**  
**2.Both of LISNs (AMN) are 80 cm from EUT and at least 80 cm from other units and other metal planes support.**

3.1.4 EUT OPERATING CONDITIONS

The EUT was configured for testing in a typical fashion (as a customer would normally use it). The EUT has been programmed to continuously transmit during test. This operating condition was tested and used to collect the included data.

3.1.5 TEST RESULT

Temperature:	N/A	Relative Humidity:	N/A
Test Voltage:	N/A	Phase:	L/N
Test Mode:	N/A		

Note: EUT is only power by DC Power, So it is not applicable for this test.



## 3.2 RADIATED EMISSION MEASUREMENT

### 3.2.1 RADIATED EMISSION LIMITS

In any 100 kHz bandwidth outside the operating frequency band. In case the emission fall within the restricted band specified on Part 15.249 and the Part 15.209(a) limit in the table below has to be followed.

#### Standard FCC 15.209

Frequencies (MHz)	Field Strength (micorvolts/meter)	Measurement Distance (meters)
0.009~0.490	2400/F(KHz)	300
0.490~1.705	24000/F(KHz)	30
1.705~30.0	30	30
30~88	100	3
88~216	150	3
216~960	200	3
960~1000	500	3
Above 1000	Other:74.0 dB( $\mu$ V)/m (Peak) 54.0 dB( $\mu$ V)/m (Average)	3

#### Standard FCC 15.249

Frequency of Emission (MHz)	Field Strength of fundamental (millivolts /meter)	Field Strength of Harmonics (microvolts/meter)
900~928	50	500
2400~2483.5	50	500
5725~5875	50	500
24000~242500	250	2500

#### Notes:

- (1) Emissions radiated outside of the specified frequency bands, except for harmonics, shall be attenuated by at least 50 dB below the level of the fundamental or to the general radiated emission limits in Section 15.209, whichever is the lesser attenuation.

In case the emission fall within the restricted band specified on RSS-Gen limit in the followed

. In measuring unwanted emissions, the spectrum shall be investigated from 30 MHz or the lowest radio frequency signal generated in the equipment, whichever is lower, without going below 9 kHz, up to at least the frequency given below:

(a) If the equipment operates below 10 GHz to the tenth harmonic of the highest fundamental frequency or to 40 GHz, whichever is lower.

(b) If the equipment operates at or above 10 GHz: to the fifth harmonic of the highest fundamental frequency or to 100 GHz, whichever is lower.

Particular attention should be paid to harmonics and sub-harmonics of the carrier frequency, as well as to those frequencies removed from the carrier by multiples of the oscillator frequency.

Radiation at the frequencies of multiplier stages should also be checked.

The amplitude of spurious emissions attenuated more than 20 dB below the permissible value need not be reported.

When limits are expressed in absolute terms, compliance with the emission limits below 1000 MHz shall be demonstrated using a CISPR quasi-peak detector and the related measurement bandwidth. As an alternative to CISPR quasi-peak measurement, compliance with the emission limits can be demonstrated using measuring equipment employing a peak detector function properly adjusted for factors such as pulse desensitization as required, with an equal or greater measurement bandwidth relative to the applicable CISPR quasi-peak bandwidth.

Above 1000 MHz, compliance with the emission limits shall be demonstrated using an average detector with a minimum resolution bandwidth of 1 MHz.

In case the emission fall within the restricted band specified on RSS 210 Issue 9 (B.10) limit in the followed

1. The field strength of fundamental and harmonic emissions, measured at 3 m, shall not exceed 50 mV/m and 0.5 mV/m respectively.

The field strength limits shall be measured using an average detector, except for the fundamental emission in the frequency band 902-928 MHz, which is based on measurements using an International Special Committee on Radio Interference (CISPR) quasi-peak detector.

2. Emissions radiated outside of the specified frequency bands, except for harmonic emissions, shall be attenuated by at least 50 dB below the level of the fundamental emissions or to the general field strength limits listed in RSS-Gen, whichever is less stringent.

**NOTE:**

(1)The limit for radiated test was performed according to RSS 210.

(2)Emission level (dBuV/m)=20log Emission level (uV/m).



## LIMITS OF RESTRICTED FREQUENCY BANDS

FCC:

FREQUENCY (MHz)	FREQUENCY (MHz)	FREQUENCY (MHz)	FREQUENCY (GHz)
0.090-0.110	16.42-16.423	399.9-410	4.5-5.15
0.495-0.505	16.69475-16.69525	608-614	5.35-5.46
2.1735-2.1905	16.80425-16.80475	960-1240	7.25-7.75
4.125-4.128	25.5-25.67	1300-1427	8.025-8.5
4.17725-4.17775	37.5-38.25	1435-1626.5	9.0-9.2
4.20725-4.20775	73-74.6	1645.5-1646.5	9.3-9.5
6.215-6.218	74.8-75.2	1660-1710	10.6-12.7
6.26775-6.26825	108-121.94	1718.8-1722.2	13.25-13.4
6.31175-6.31225	123-138	2200-2300	14.47-14.5
8.291-8.294	149.9-150.05	2310-2390	15.35-16.2
8.362-8.366	156.52475-156.52525	2483.5-2500	17.7-21.4
8.37625-8.38675	156.7-156.9	2690-2900	22.01-23.12
8.41425-8.41475	162.0125-167.17	3260-3267	23.6-24.0
12.29-12.293	167.72-173.2	3332-3339	31.2-31.8
12.51975-12.52025	240-285	3345.8-3358	36.43-36.5
12.57675-12.57725	322-335.4	3600-4400	Above 38.6
13.36-13.41			

IC:

FREQUENCY (MHz)	FREQUENCY (MHz)	FREQUENCY (GHz)
0.090 - 0.110	149.9 - 150.05	9.0 - 9.2
0.495 - 0.505	156.52475 - 156.52525	9.3 - 9.5
2.1735 - 2.1905	156.7 - 156.9	10.6 - 12.7
3.020 - 3.026	162.0125 - 167.17	13.25 - 13.4
4.125 - 4.128	167.72 - 173.2	14.47 - 14.5
4.17725 - 4.17775	240 - 285	15.35 - 16.2
4.20725 - 4.20775	322 - 335.4	17.7 - 21.4
5.677 - 5.683	399.9 - 410	22.01 - 23.12
6.215 - 6.218	608 - 614	23.6 - 24.0
6.26775 - 6.26825	960 - 1427	31.2 - 31.8
6.31175 - 6.31225	1435 - 1626.5	36.43 - 36.5
8.291 - 8.294	1645.5 - 1646.5	Above 38.6
8.362 - 8.366	1660 - 1710	
8.37625 - 8.38675	1718.8 - 1722.2	
8.41425 - 8.41475	2200 - 2300	
12.29 - 12.293	2310 - 2390	
12.51975 - 12.52025	2483.5 - 2500	
12.57675 - 12.57725	2655 - 2900	
13.36 - 13.41	3260 - 3267	
16.42 - 16.423	3332 - 3339	
16.69475 - 16.69525	3345.8 - 3358	





16.80425 - 16.80475	3500 - 4400	
25.5 - 25.67	4500 - 5150	
37.5 - 38.25	5350 - 5460	
73 - 74.6	7250 - 7750	
74.8 - 75.2	8025 - 8500	
108 - 138		

Spectrum Parameter	Setting
Detector	Peak/AV
Attenuation	Auto
Start Frequency	1000 MHz
Stop Frequency	10th carrier harmonic
RB (emission in restricted band)	>20BW
VB (emission in restricted band)	=3xRB

Receiver Parameter	Setting
Attenuation	Auto
Start ~ Stop Frequency	9kHz~90kHz / RB 200Hz for PK & AV
	90kHz~110kHz / RB 200Hz for QP
	110kHz~490kHz / RB 200Hz for PK & AV
	490kHz~30MHz / RB 9kHz for QP
	30MHz~1000MHz / RB 120kHz for QP



### 3.2.2 TEST PROCEDURE

- a. The measuring distance of 3m shall be used for measurements. The EUT was placed on the top of a rotating table 0.8 meter above the ground at a 3 meter semi-anechoic chamber. The table was rotated 360 degrees to determine the position of the highest radiation (Below 1GHz)
- b. The measuring distance of 3m shall be used for measurements. The EUT was placed on the top of a rotating table 1.5 meter above the ground at a 3 meter semi-anechoic chamber. The table was rotated 360 degrees to determine the position of the highest radiation (Above 1GHz)
- c. The height of the test antenna shall vary between 1m to 4m. Both horizontal and vertical polarization of the antenna are set to make the measurement.
- d. The initial step in collecting radiated emission data is a receive peak detector mode. Pre-scanning the measurement frequency range. Significant peaks are then marked and then Quasi Peak detector mode re-measured.
- e. All readings are peak unless otherwise stated QP in column of Note. Peak denoted that the Peak reading complies with the QP limits and then QP Mode measurement didn't perform (Below 1GHz)
- f. All readings are Peak mode value unless otherwise stated AVG in column of Note. If the Peak mode measured value complies with the Peak limits and lower than AVG Limits, the EUT shall be deemed to meet Peak & AVG limits and then only Peak mode was measured, but AVG mode didn't perform. (Above 1GHz)
- g. For the actual test configuration, please refer to the related Item –EUT Test Photos.  
Note: Both horizontal and vertical antenna polarities were tested and performed pretest to three orthogonal axes. The worst case emissions were reported.

### 3.2.3 DEVIATION FROM TEST STANDARD

No deviation

### 3.2.4 TEST SETUP

#### (A) Radiated Emission Test-Up Frequency Below 30MHz

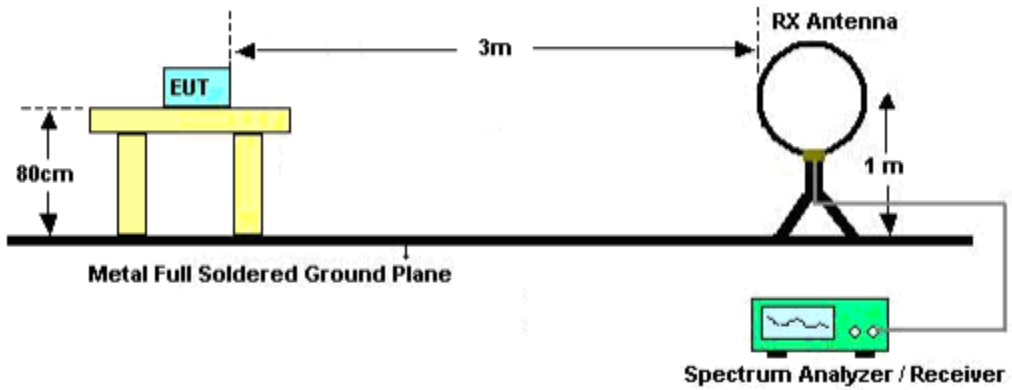

#### (B) Radiated Emission Test-Up Frequency 30MHz~1GHz

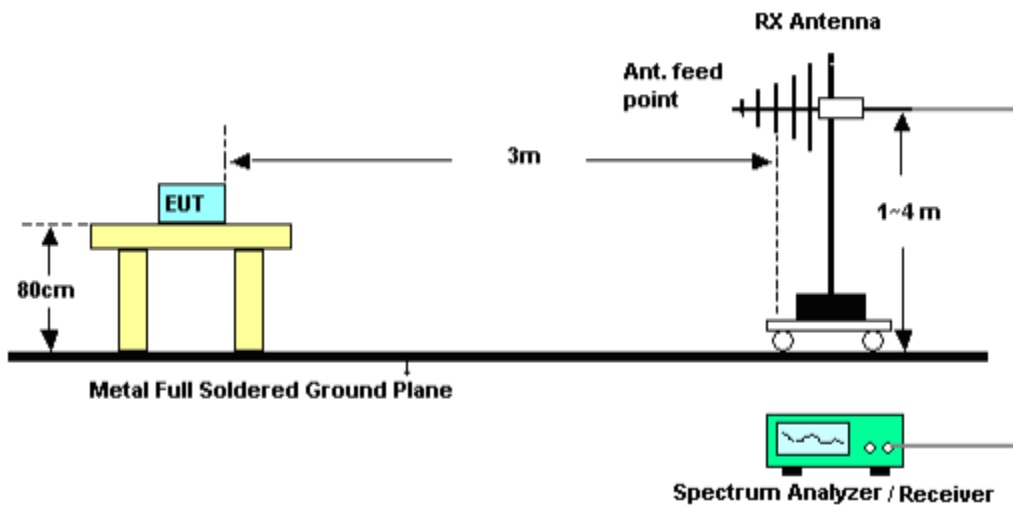

#### (C) Radiated Emission Test-Up Frequency Above 1GHz

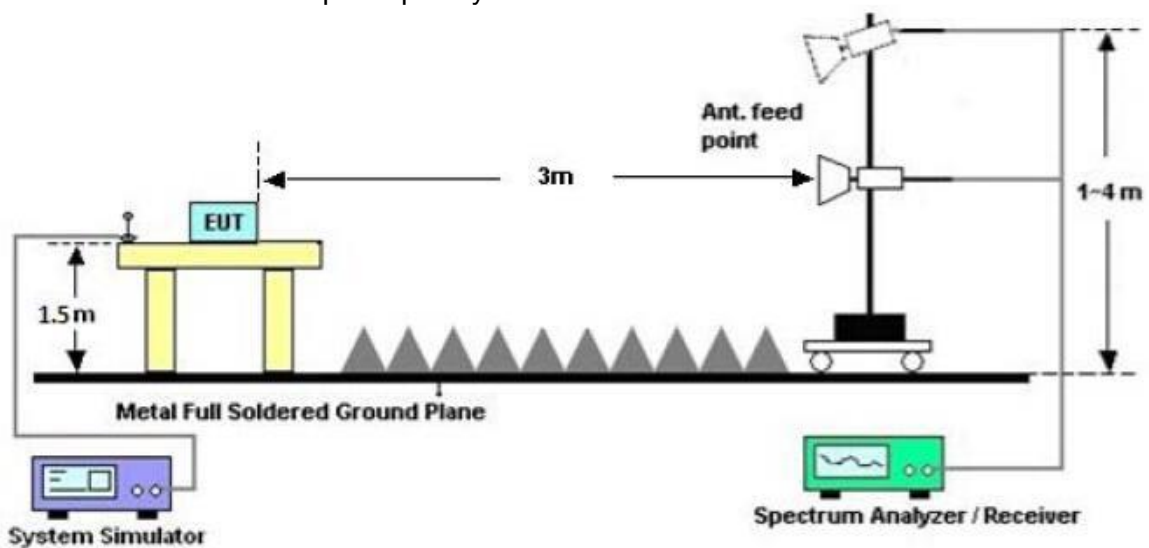



### 3.2.5 FIELD STRENGTH CALCULATION

The field strength is calculated by adding the Antenna Factor and Cable Factor and subtracting the Amplifier Gain and Duty Cycle Correction Factor (if any) from the measured reading. The basic equation with a sample calculation is as follows:

Margin=PL-PK L or AL- AV L; Margin only shown the worst case.

Where

PR = Peak Reading

AR = Average Reading

PL = Peak Level

AL = Average Level

AF = Antenna Factor

PK L = Peak Limit

AV L = AV Limit

For example

Frequency	PR	AR	AF	PL	AL	PK L	AV L	Margin
(MHz)	(dB $\mu$ V/m)	(dB $\mu$ V/m)	(dB)	(dB $\mu$ V/m)	(dB $\mu$ V/m)	(dB $\mu$ V/m)	(dB $\mu$ V/m)	(dB)
2178	40.23	30.31	9.83	50.06	40.14	74.00	54.00	-13.86





### 3.2.6 EUT OPERATING CONDITIONS

The EUT tested system was configured as the statements of 2.4 Unless otherwise a special operating condition is specified in the follows during the testing.

Below 30 MHz

Temperature:	23.1(C)	Relative Humidity:	60%RH
Test Voltage:	DC 12V	Polarization:	---
Test Mode:	TX Mode		

Freq. (MHz)	Reading (dBuV/m)	Limit (dBuV/m)	Margin (dB)	State P/F
--	--	--	--	PASS
--	--	--	--	PASS

**NOTE:**

The amplitude of spurious emissions which are attenuated by more than 20dB below the permissible value has no need to be reported.

Distance extrapolation factor =  $40 \log(\text{specific distance}/\text{test distance})$ (dB);

Limit line = specific limits(dBuv) + distance extrapolation factor.

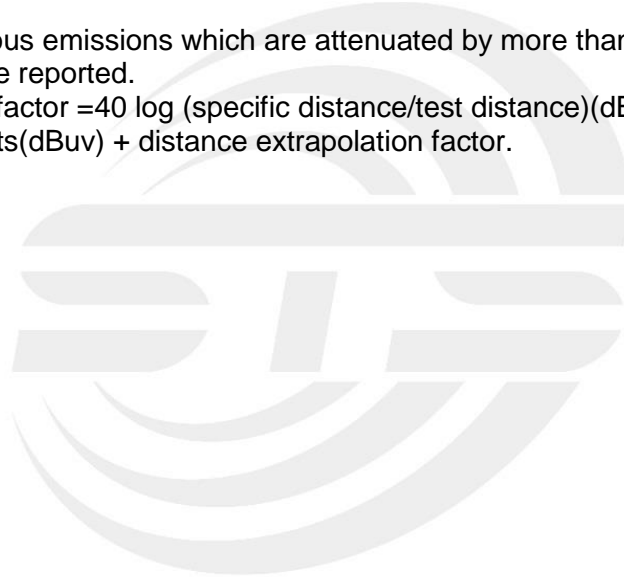



Between 30MHz – 1000 MHz Radiation Spurious

Temperature:	23.1(C)	Relative Humidity:	60%RH
Test Voltage:	DC 12V	Phase:	Horizontal
Test Mode:	Mode 1		

No.	Frequency (MHz)	Reading (dBuV)	Correct Factor(dB/m)	Result (dBuV/m)	Limit (dBuV/m)	Margin (dB)	Remark
1	95.9600	59.60	-20.67	38.93	43.50	-4.57	peak
2	199.7500	61.92	-21.11	40.81	43.50	-2.69	peak
3	312.2700	55.73	-14.36	41.37	46.00	-4.63	peak
4	398.6000	53.21	-11.20	42.01	46.00	-3.99	peak
5	796.3000	39.03	-2.02	37.01	46.00	-8.99	peak
6	929.1900	36.09	0.50	36.59	46.00	-9.41	peak

Remark:

1. Margin = Result (Result =Reading + Factor)–Limit
2. Factor= Antenna factor+Cable attenuation factor(cable loss)-Amplifier gain

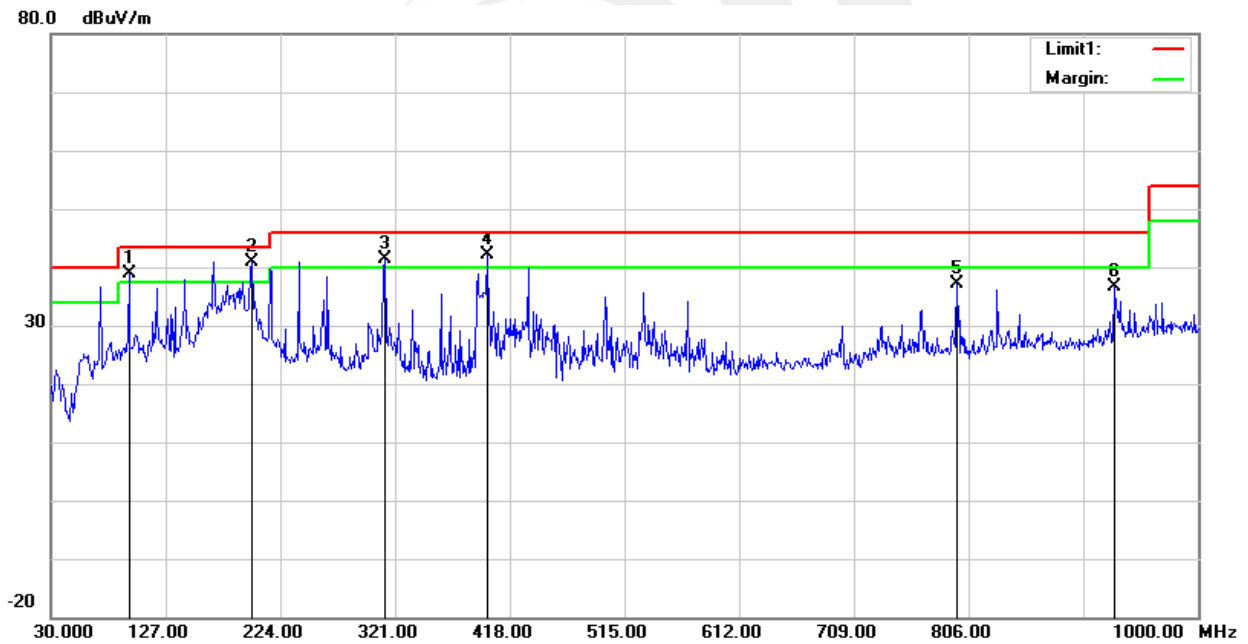



Temperature:	23.1(C)	Relative Humidity:	60%RH
Test Voltage:	DC 12V	Phase:	Vertical
Test Mode:	Mode 1		

No.	Frequency (MHz)	Reading (dBuV)	Correct Factor(dB/m)	Result (dBuV/m)	Limit (dBuV/m)	Margin (dB)	Remark
1	95.9600	60.34	-20.67	39.67	43.50	-3.83	peak
2	199.7500	61.89	-21.11	40.78	43.50	-2.72	peak
3	398.6000	48.26	-11.20	37.06	46.00	-8.94	peak
4	532.4600	41.21	-7.31	33.90	46.00	-12.10	peak
5	798.2400	43.09	-2.03	41.06	46.00	-4.94	peak
6	931.1300	36.91	0.64	37.55	46.00	-8.45	peak

Remark:

- Margin = Result (Result =Reading + Factor )-Limit
- Factor= Antenna factor+Cable attenuation factor(cable loss)-Amplifier gain

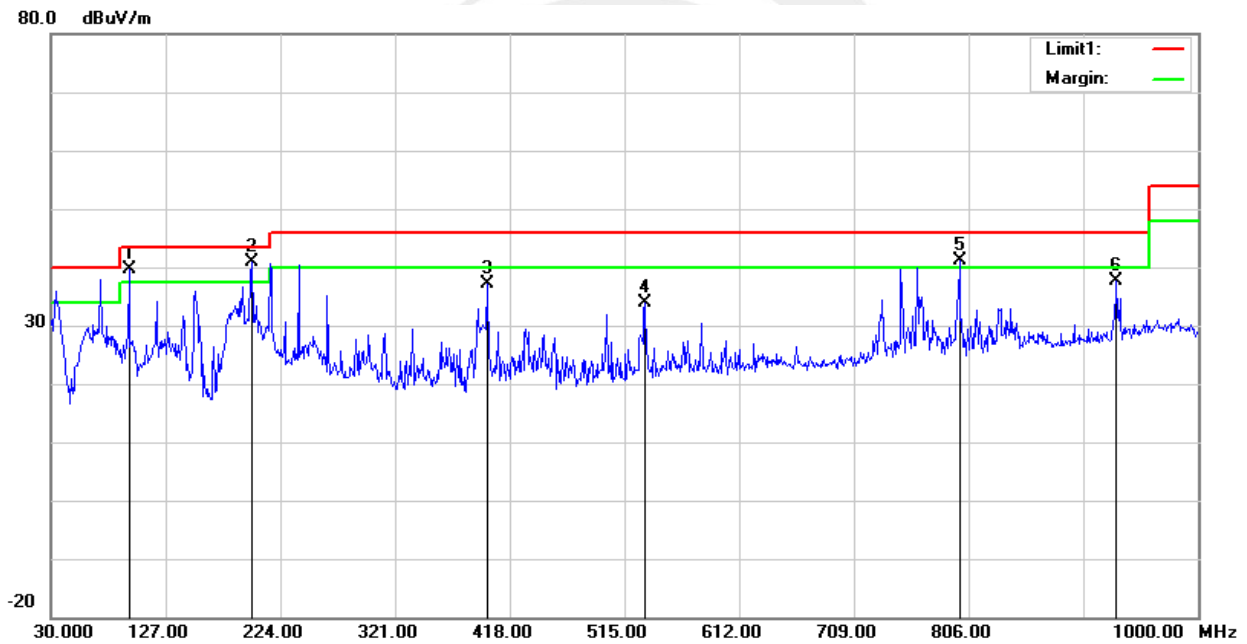



## Above 1G Radiation Spurious

## PK

Frequency (MHz)	Meter Reading (dB $\mu$ V/m)	Detector (PK/QP/AV)	Amplifier (dB)	Loss (dB)	Antenna Factor (dB/m)	Orrected Factor (dB)	Corrected Amplitude (dB $\mu$ V/m)	FCC Part 15.249/15.209/205		RX Antenna
								Limit (dB $\mu$ V/m)	Margin (dB)	Polar (H/V)
4950.13	61.29	PK	50.33	8.84	31.22	-10.27	51.02	74	-22.98	H
4950.13	60.54	PK	50.33	8.84	31.22	-10.27	50.27	74	-23.73	V
7425.14	58.20	PK	55.48	9.31	34.05	-12.12	46.08	74	-27.92	H
7425.14	56.74	PK	55.48	9.31	34.05	-12.12	44.62	74	-29.38	V
9900.17	61.51	PK	59.13	9.89	36.99	-12.25	49.26	74	-24.74	H
9900.17	60.22	PK	59.13	9.89	36.99	-12.25	47.97	74	-26.03	V

Note: The PK value is lower than the AV limit, the AV data does not need to be tested.







Duty cycle

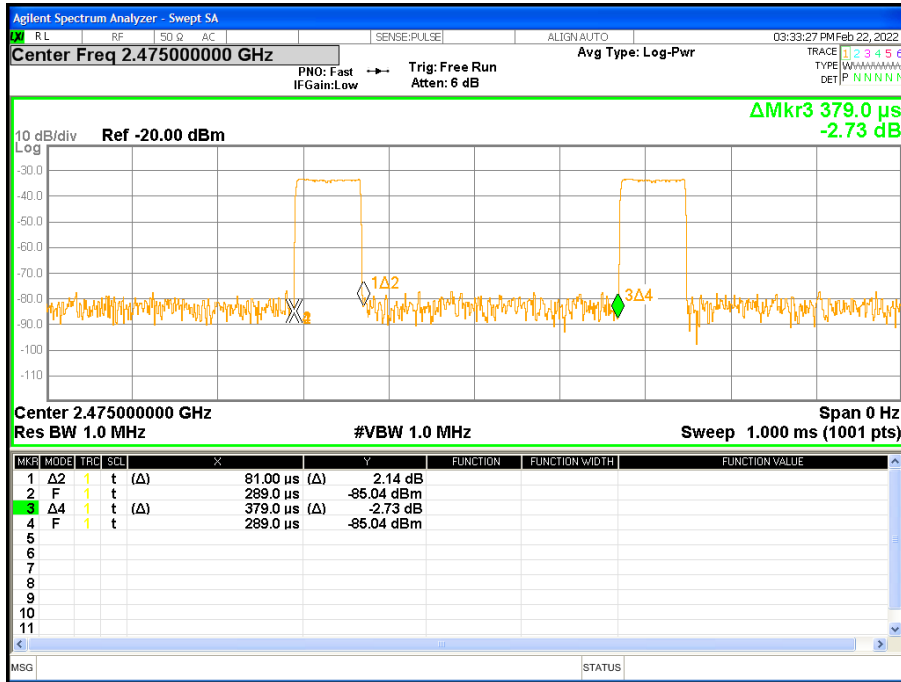

Ton	Tp	Duty cycle(%)	Duty factor(dB)
81.000	379.000	21.37%	-13.40

Note: Duty Factor=20\*LOG10(1/(Ton/Tp))



(Radiation Band edge)

Horizontal

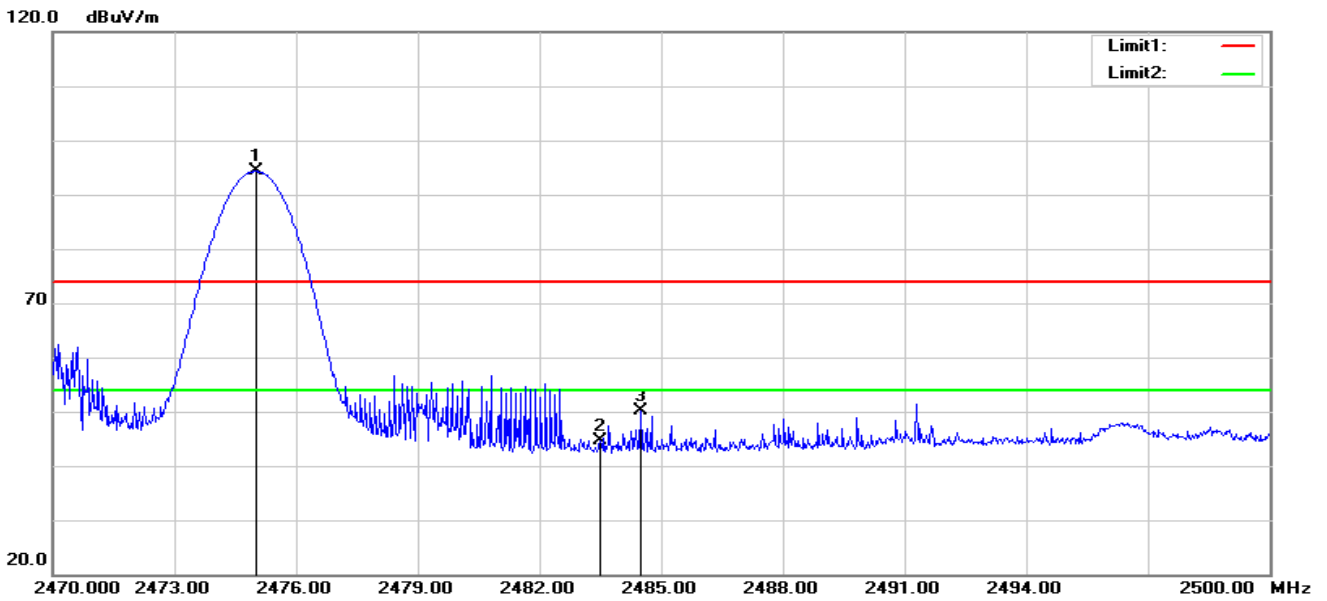

No.	Frequency (MHz)	Reading (dBuV)	Correct Factor(dB/m)	Result (dBuV/m)	Limit (dBuV/m)	Margin (dB)	Remark
2	2483.500	39.97	4.60	44.57	74.00	-29.43	peak
3	2484.490	45.59	4.61	50.20	74.00	-23.80	peak

**Fundamental Frequency**

No.	Frequency (MHz)	Reading (dBuV)	Correct Factor(dB/m)	Duty cycle Factor(dB/m)	Result (dBuV/m)	Limit (dBuV/m)	Margin (dB)	Remark
1	2475.000	89.67	4.59	-	94.26	114.00	-19.74	peak
4	2475.000	89.67	4.59	-13.40	80.86	94.00	-13.14	AVG



Vertical

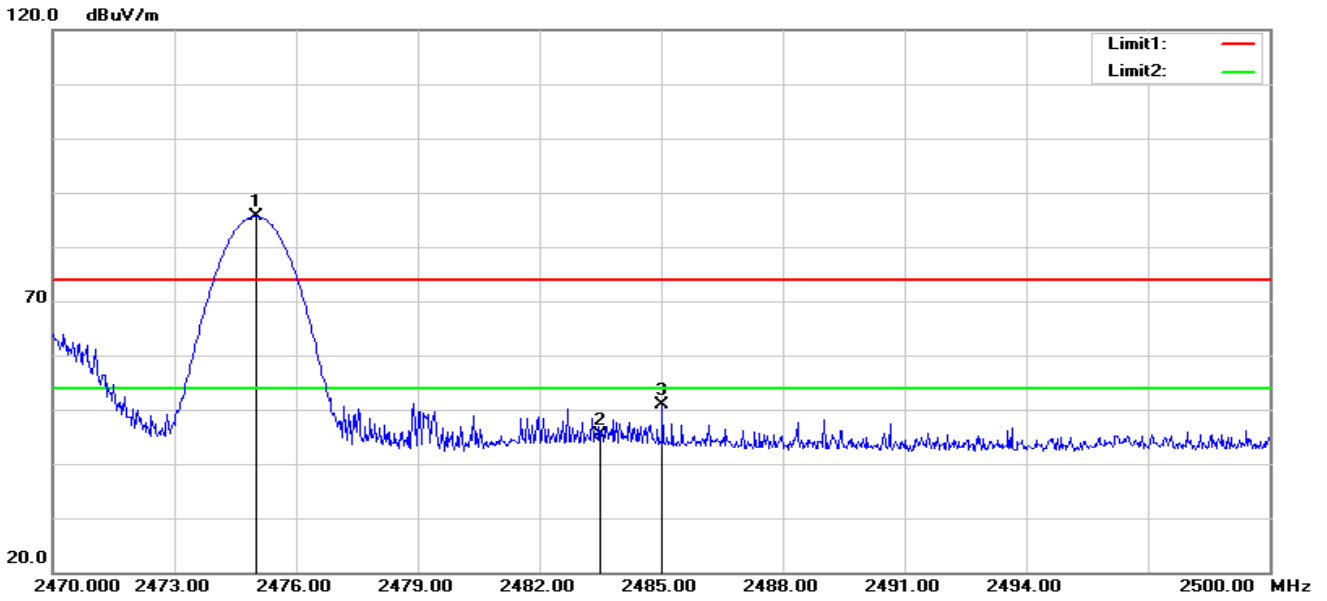

No.	Frequency (MHz)	Reading (dBuV)	Correct Factor(dB/m)	Result (dBuV/m)	Limit (dBuV/m)	Margin (dB)	Remark
2	2483.500	40.88	4.60	45.48	74.00	-28.52	peak
3	2485.030	46.29	4.61	50.90	74.00	-23.10	peak

Fundamental Frequency

No.	Frequency (MHz)	Reading (dBuV)	Correct Factor(dB/m)	Duty cycle Factor(dB/m)	Result (dBuV/m)	Limit (dBuV/m)	Margin (dB)	Remark
1	2475.000	81.03	4.59	-	85.62	114.00	-28.38	peak

#### 4. BANDWIDTH TEST

##### 4.1 TEST PROCEDURE

- a. The EUT was directly connected to the spectrum analyzer and antenna output port as show in the block diagram below.
- b. Spectrum Setting : RBW= 1% to 5% OBW, VBW  $\geq$  RBW, Sweep time = Auto.

##### 4.2 TEST SETUP

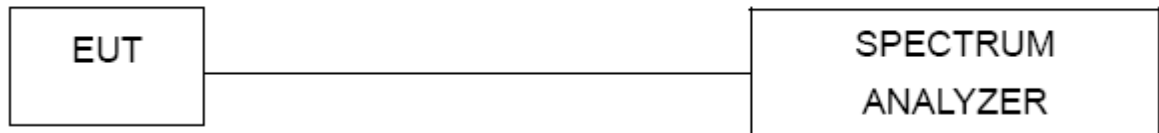

##### 4.3 EUT OPERATION CONDITIONS

TX mode.





4.4 TEST RESULTS

Temperature:	25 °C	Relative Humidity:	50%
Test Voltage:	DC 12V		

Frequency(MHz)	20 dB Bandwidth(MHz)	99% Bandwidth(MHz)
2475	1.631	1.8843

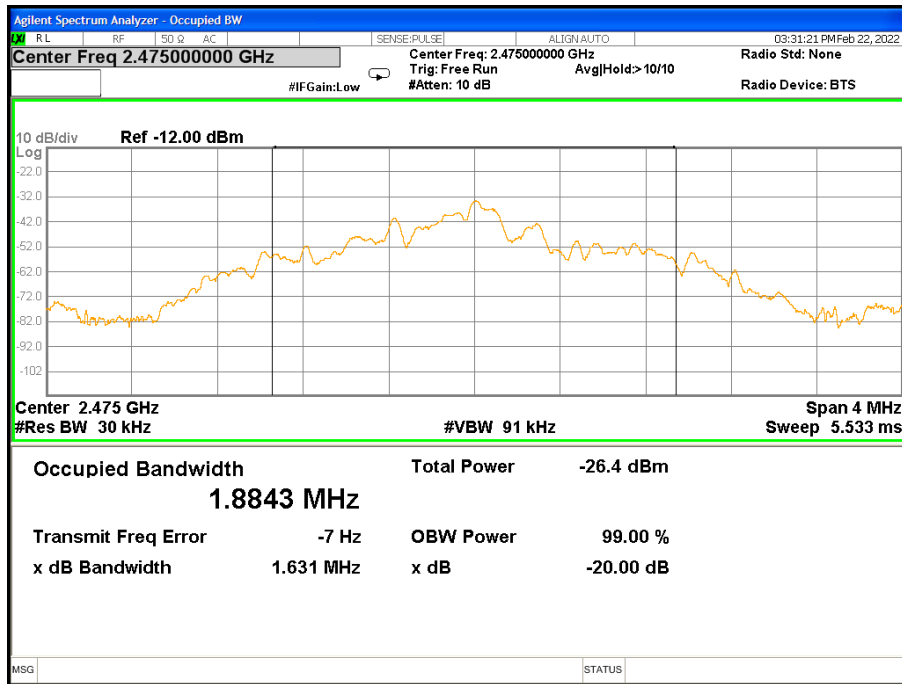



## 5. ANTENNA REQUIREMENT

### 5.1 STANDARD REQUIREMENT

According to the FCC Part 15 Paragraph 15.203&RSS Gen, an intentional radiator shall be designed to ensure that no antenna other than that furnished by the responsible party shall be used with the device.

### 5.2 EUT ANTENNA

The EUT antenna is PCB Antenna.It conforms to the standard requirements.





## APPENDIX- PHOTOS OF TEST SETUP

Note: See test photos in setup photo document for the actual connections between Product and support equipment.

\*\*\*\*\*END OF THE REPORT\*\*\*\*\*

