

09.2020 - 1.110.M1

MOUNTING & OPERATING INSTRUCTIONS

Indoor Gateway

210

Do you have all the tools needed?

1

M5x30 PANHEAD SCREWS x 2



2

WALL ANCHOR x 2

7 mm



Make sure that you have the correct type of anchors for the wall that you're mounting the device (i.e: concrete, drywall)



Hammer

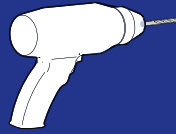

Drill



Screwdriver



Laser Meter



Tape Measure



Pencil



Bubble Level



Tape

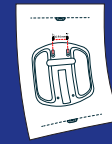

Template

INSTRUCTIONS

All instructions here are for Litum Anchor/Gateway referred to as "anchor/gateway(s)" in the document.

CAUTION

Anchor/Gateway is **not suitable for mounting on metal surfaces**. Make sure that it is mounted on a non-metal surface such as concrete, plastic, drywall, etc.

CAUTION

Anchor/Gateway have unique node IDs that are printed on the back.

It is critical that this must be mounted with the correct **node ID** at each location as instructed by Litum application engineering team.

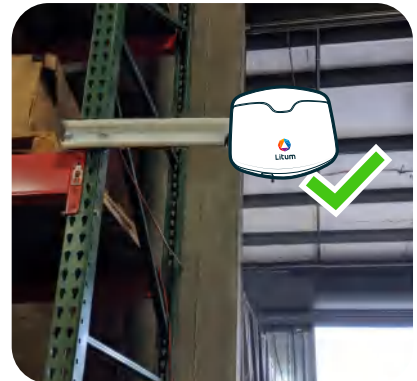
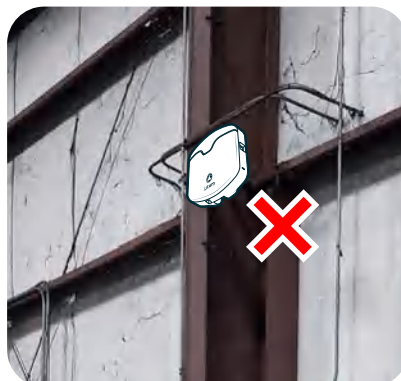
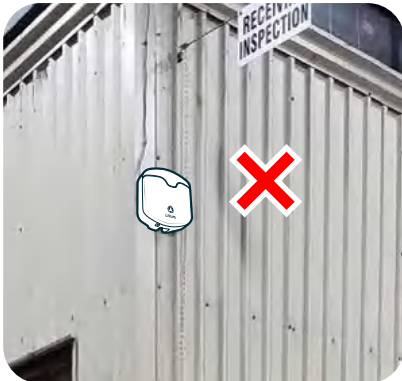
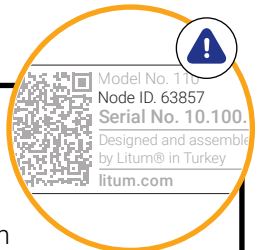

WHERE TO MOUNT

1

The anchor/gateway can be mounted both on walls and ceilings. **This document only refers to wall mounting.**

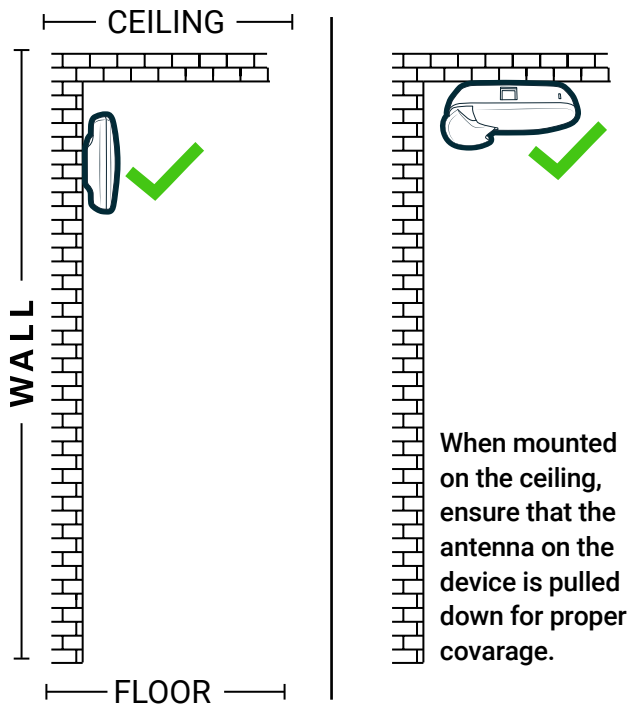

2

All anchors/gateways must be mounted consistently at **the same height from the floor.**

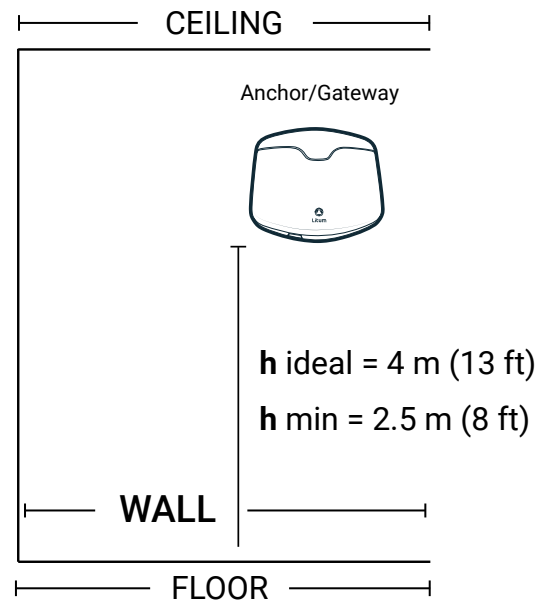

If it is required to install the anchor/gateway higher than 4m (13 ft), please consult Litum.

3

If you need to mount the anchor/gateway close to a corner, make sure to stay away at least 50 cm (1.5 feet).

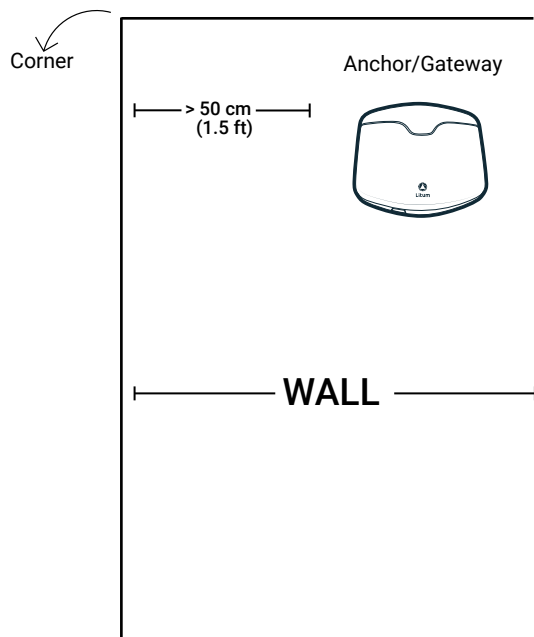

4

The anchor/gateway is a very sensitive locating device. For its optimal performance it needs to be mounted **on the exact location** that is instructed by Litum application engineering team. When you find the correct location of the anchor/gateway, please you choose a fixed reference point (such as a corner, window, etc.) and take another measurement from there to double check its location. Please make sure that you are using a correctly scaled floor plan.

5

In cases that two anchors/gateways need to be mounted closely, make sure that they are **at least 2 m (6 ft) away from each other.**

6

Devices that transmit electromagnetic signals, such as **WiFi access points**, may have a negative impact on anchor/gateway performance. If you see such a device close to where the anchor/gateway is instructed to be mounted, please consult with Litum application engineering team before you proceed.

HOW TO MOUNT

1 LOCATE & MARK

Print the [anchor/gateway drilling template](#). Use it with bubble level and place it on the wall.

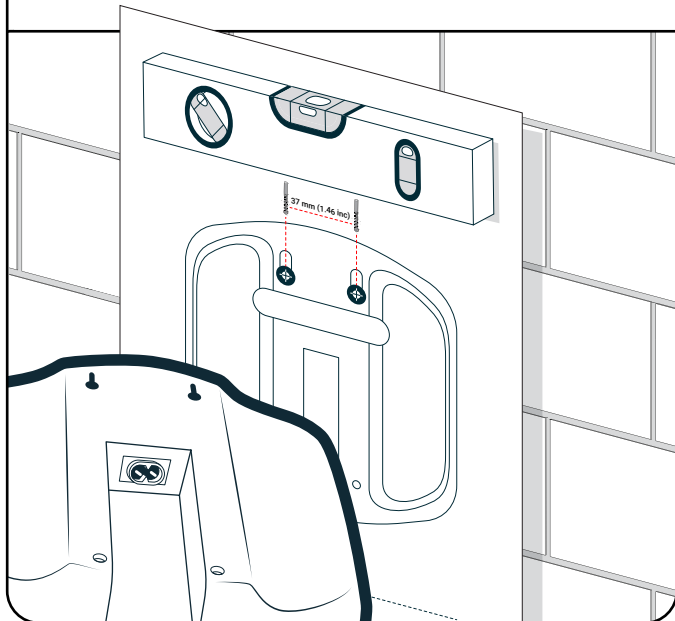

2 DRILL & INSERT WALL PLUGS

Drill the two holes on the template and insert wall plugs.

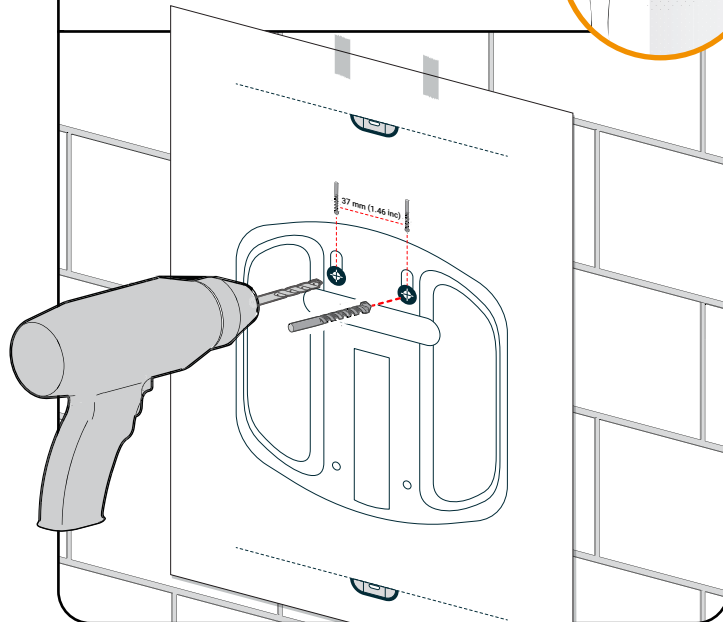
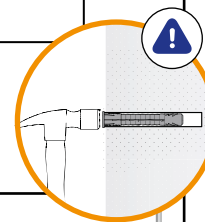

3 CABLE CONNECTION

Insert the power outlet into the plug at the back of the anchor/gateway.

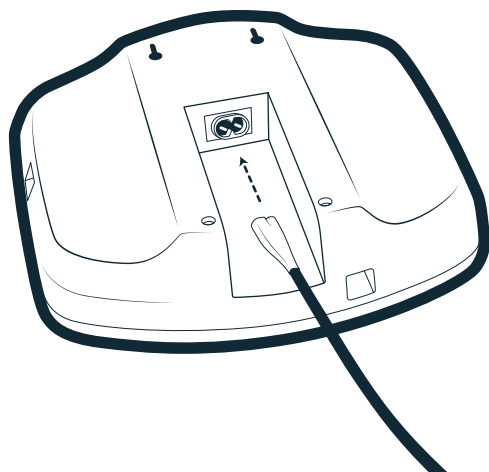

4 INSTALL SCREWS & HANG THE DEVICE

Secure the screws in place using the screwdriver. **Leave an adequate amount at the end of the screw** to allow the hanger on the anchor/gateway to position securely on the wall.

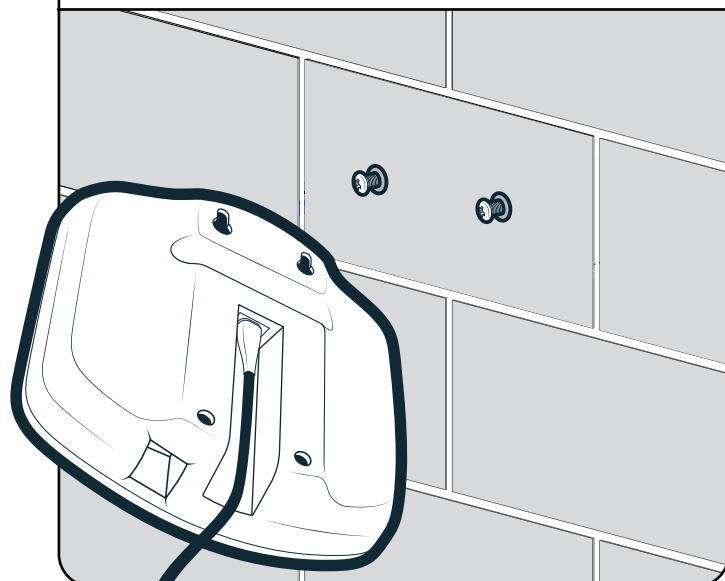

5 PLUG IN

Plug in the anchor/gateway to a 110/220 V AC power outlet. When the device is connected to a stable power supply, a green LED should start to blink on the side of the device.

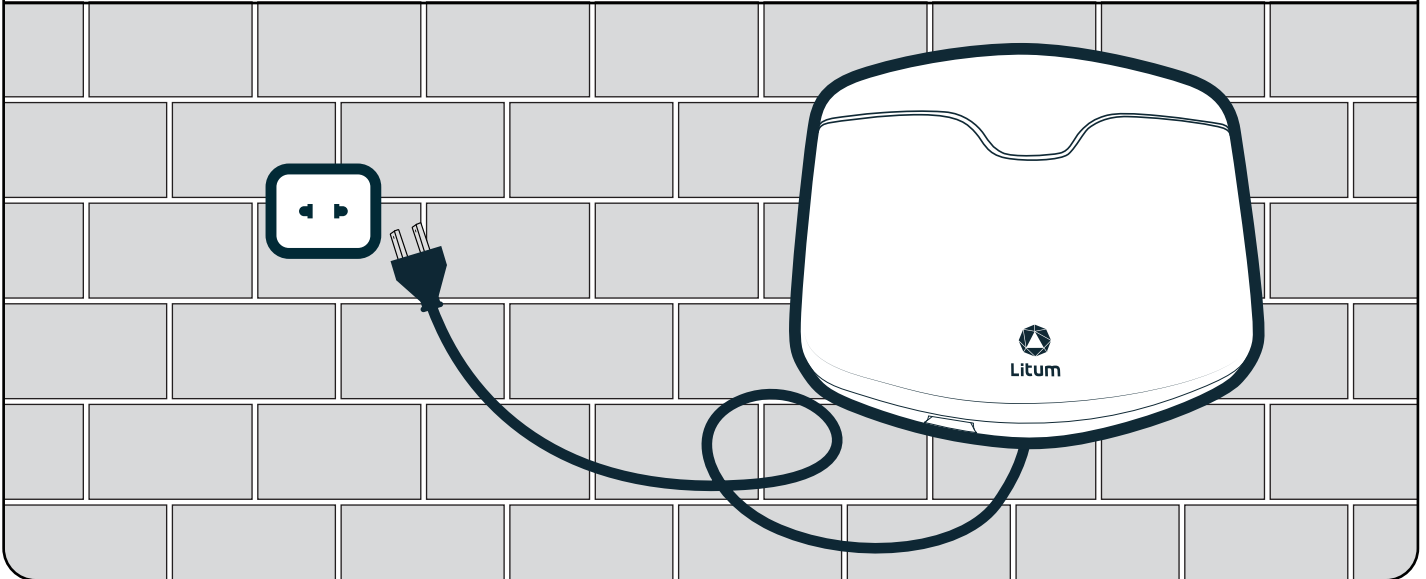
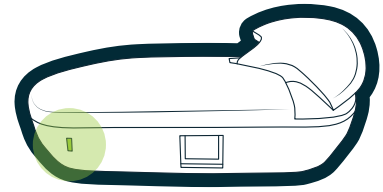

OPERATION

The green LED will light up and remain steady when the device is communicating with a server.

Additional devices with RS232 or RS485 communications can be connected to the device through the optional RJ11 port. Please [contact Litum](#) for supported devices.

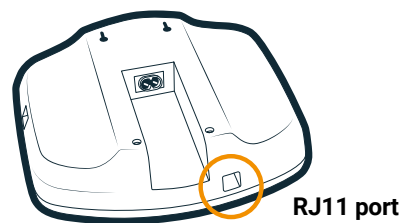

If the device is a gateway, server connection is possible through both ethernet and Wi-Fi. Network settings will be done by Litum during installation.

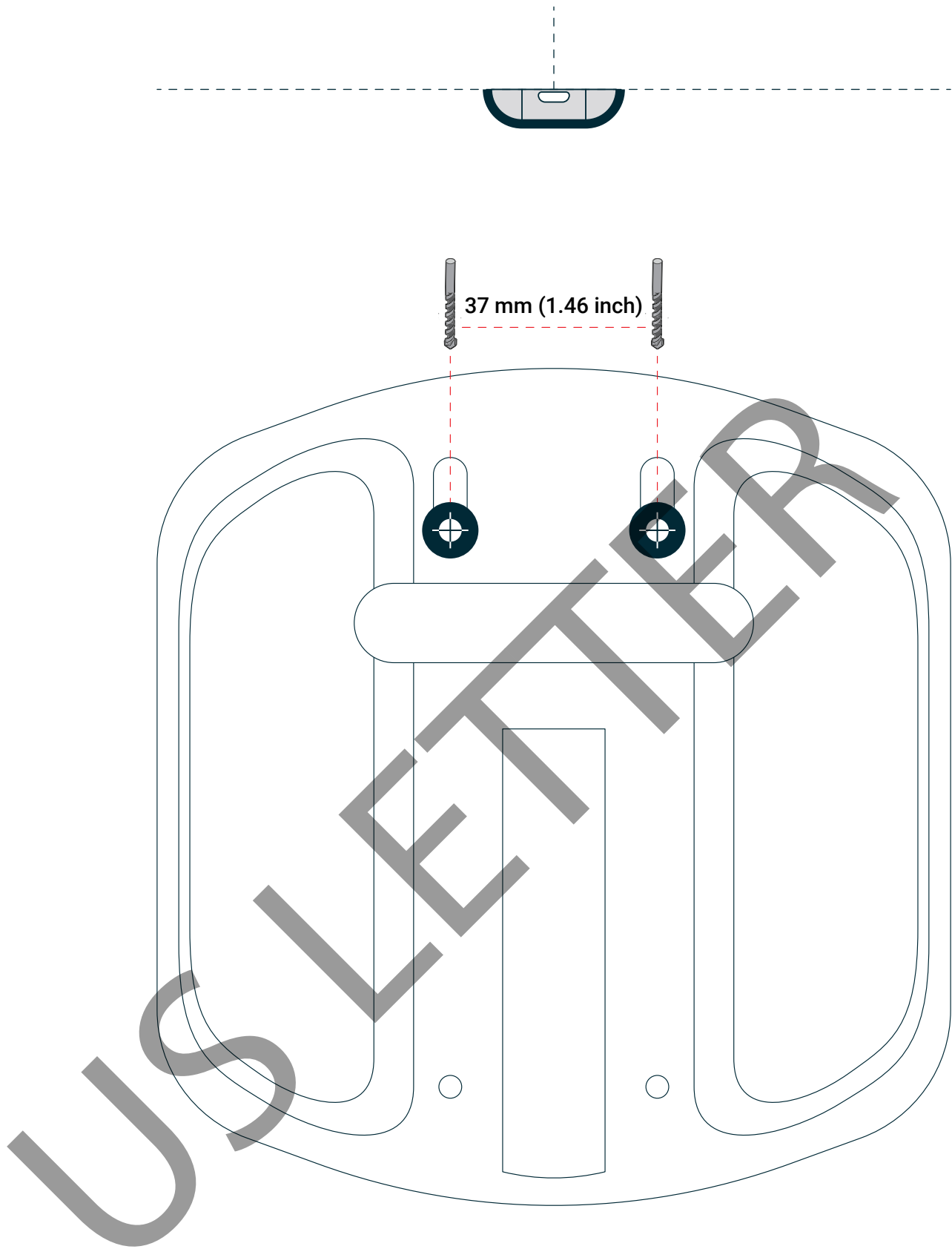

Please print the anchor drilling template on **US Letter size paper**.

Please check that the **template printout aligns with Litum Anchor/Gateway screw holes** before proceeding.

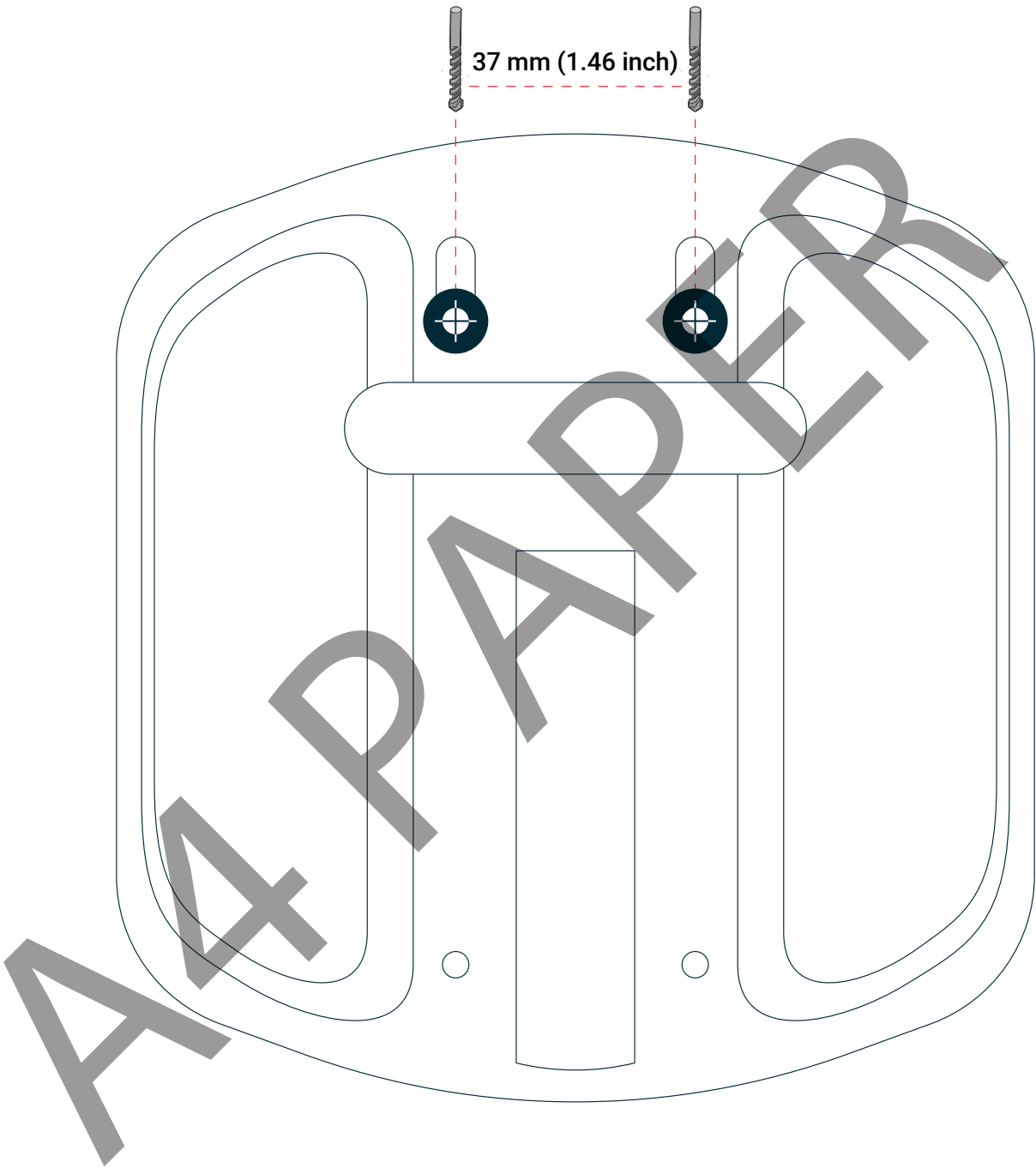
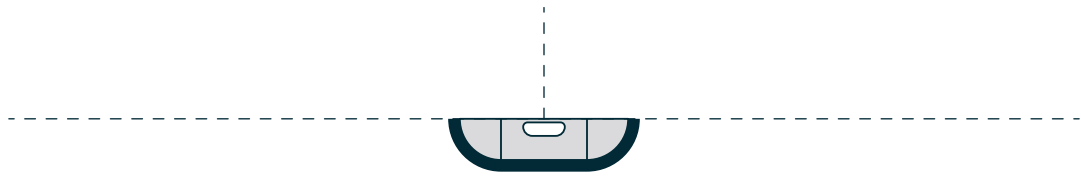

Please print the anchor drilling template on **A4 size paper**.

Please check that the **template printout aligns with Litum Anchor/Gateway screw holes** before proceeding.

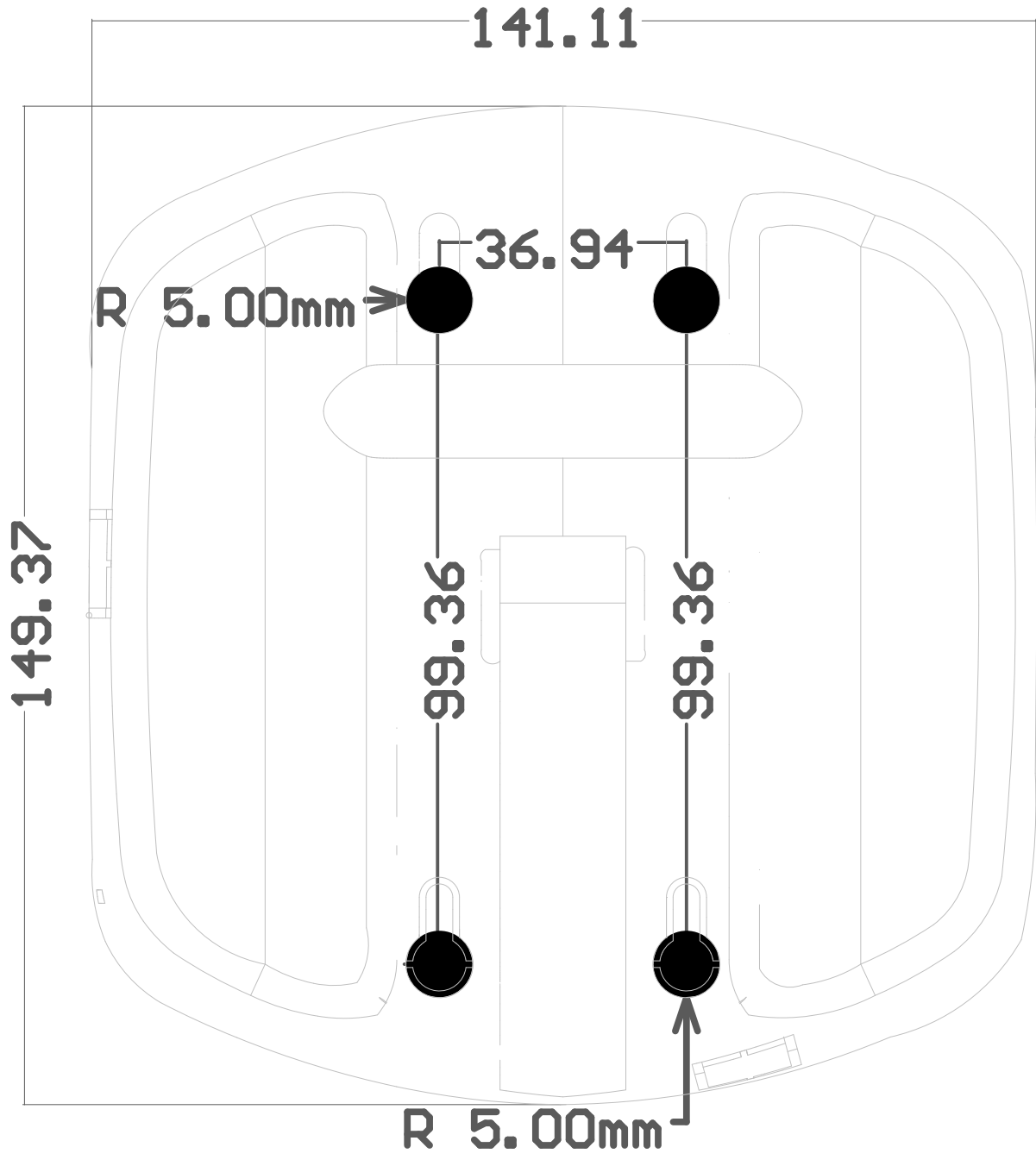

FCC Warning

This device complies with part 15 of the FCC Rules. Operation is subject to the following two conditions: (1) This device may not cause harmful interference, and (2) this device must accept any interference received, including interference that may cause undesired operation.

Any Changes or modifications not expressly approved by the party responsible for compliance could void the user's authority to operate the equipment.

Note: This equipment has been tested and found to comply with the limits for a Class B digital device, pursuant to part 15 of the FCC Rules. These limits are designed to provide reasonable protection against harmful interference in a residential installation. This equipment generates uses and can radiate radio frequency energy and, if not installed and used in accordance with the instructions, may cause harmful interference to radio communications. However, there is no guarantee that interference will not occur in a particular installation. If this equipment does cause harmful interference to radio or television reception, which can be determined by turning the equipment off and on, the user is encouraged to try to correct the interference by one or more of the following measures:

- Reorient or relocate the receiving antenna.
- Increase the separation between the equipment and receiver.
- Connect the equipment into an outlet on a circuit different from that to which the receiver is connected.
- Consult the dealer or an experienced radio/TV technician for help.

This equipment complies with FCC radiation exposure limits set forth for an uncontrolled environment. This equipment should be installed and operated with minimum distance 20cm between the radiator & your body.

Endurance Gateway belongs to FCC Part 15.517 indoor UWB systems.

"This equipment may only be operated indoors. Operation outdoors is in violation of 47 U.S.C. 301 and could subject the operator to serious legal penalties."

IC Warning

This device complies with Industry Canada's licence-exempt RSSs. Operation is subject to the following two conditions:

- (1) This device may not cause interference; and
- (2) This device must accept any interference, including interference that may cause undesired operation of the device.

This equipment complies with IC radiation exposure limits set forth for an uncontrolled environment. This equipment should be installed and operated with minimum distance 20cm between the radiator & your body.

Cet appareil est conforme aux CNR exemptes de licence d'Industrie Canada .
Son fonctionnement est soumis aux deux conditions suivantes :

- (1) Ce dispositif ne peut causer d'interférences ; et
- (2) Ce dispositif doit accepter toute interférence , y compris les interférences qui peuvent causer un mauvais fonctionnement de l'appareil.

Ce matériel est complété par une exposition de rayonnements IC pour un environnement naturel. Ce matériel doit être installé et se faire avec une distance minimale de 20cm entre les radiateurs et les autresYour body shop.