



RADIO TEST REPORT

Report No: STS2203130W02

Issued for

Litum bilgi teknolojileri san. Ve dis tic. A.S

Sevket Ozcelik sok. No29 Alsancak izmir Turkey

Product Name:	Indoor Anchor
Brand Name:	Litum
Model Name:	110
Series Model:	N/A
FCC ID:	2AW7W-110
IC:	26820-110
Test Standard:	Title 47 of the CFR, Part 15. Subpart F RSS 220 Issue 1, amendment 1 July 2018

Any reproduction of this document must be done in full. No single part of this document may be reproduced without permission from STS, All Test Data Presented in this report is only applicable to presented Test sample.

Shenzhen STS Test Services Co., Ltd.
A 1/F, Building B, Zhuoke Science Park, No.190 Chongqing Road, HepingShequ
Fuyong Sub-District, Bao'an District, Shenzhen, Guang Dong, China
TEL: +86-755 3688 6288 FAX: +86-755 3688 6277 E-mail: sts@stsapp.com





TEST RESULT CERTIFICATION

Applicant's Name: Litum bilgi teknolojileri san. Ve dis tic. A.S
Address.....: Sevket Ozcelik sok. No29 Alsancak izmir Turkey
Manufacture's Name: Litum bilgi teknolojileri san. Ve dis tic. A.S
Address.....: Sevket Ozcelik sok. No29 Alsancak izmir Turkey

Product Description

Product Name: Indoor Anchor
Brand Name: Litum
Model Name.....: 110
Series Model: N/A

Test Standards.....: Title 47 of the CFR, Part 15. Subpart F
RSS 220 Issue 1, amendment 1 July 2018
RSS-Gen Issue 5, Amendment 1, March 2019

Test Procedure.....: ANSI C63.10-2013

This device described above has been tested by STS, the test results show that the equipment under test (EUT) is in compliance with the FCC/IC requirements. And it is applicable only to the tested sample identified in the report.

This report shall not be reproduced except in full, without the written approval of STS, this document only be altered or revised by STS, personal only, and shall be noted in the revision of the document.

Date of Test.....:
Date of receipt of test item.....: 23 Mar. 2022
Date of performance of tests ...: 23 Mar. 2022 ~ 09 June 2022
Date of Issue: 09 June 2022
Test Result: Pass

Testing Engineer : Chris Chen
(Chris Chen)

Technical Manager : Sean She
(Sean she)

Authorized Signatory : Bovey Yang
(Bovey Yang)





Table of Contents	Page
1. SUMMARY OF TEST RESULTS	5
1.1 TEST FACTORY	6
1.2 MEASUREMENT UNCERTAINTY	6
2. GENERAL INFORMATION	7
2.1 GENERAL DESCRIPTION OF THE EUT	7
2.2 DESCRIPTION OF THE TEST MODES	8
2.3 TEST SOFTWARE AND POWER LEVEL	8
2.4 BLOCK DIGRAM SHOWING THE CONFIGURATION OF SYSTEM TESTED	9
2.5 DESCRIPTION OF NECESSARY ACCESSORIES AND SUPPORT UNITS	10
2.6 EQUIPMENTS LIST FOR ALL TEST ITEMS	11
3. EMISSION TEST	12
3.1 CONDUCTED EMISSION MEASUREMENT	12
3.2 RADIATED EMISSION MEASUREMENT (FOR 15.517(C)&RSS 220 5.2.1(D))	16
3.3 RADIATED EMISSION MEASUREMENT (FOR 15.517(D)&RSS 220 5.2.1(E))	47
4. UWB BANDWIDTH AND 99% BANDWIDTH	53
4.1 LIMITS OF UWB BANDWIDTH MEASUREMENT	53
4.2 INSTRUMENT SETUP VALUE AND MEASUREMENT DISTANCE	53
4.3 TEST PROCEDURE	53
4.4 TEST SETUP	53
4.5 EUT OPERATION CONDITIONS	53
4.6 TEST RESULTS	54
5 PEAK EMISSION WITHIN A 50MHZ BANDWIDTH (FOR 15.517(E) & RSS-220 5.2.1(G))	56
5.1 LIMITS OF PEAK EMISSION	56
5.2 INSTRUMENT SETUP VALUE AND MEASUREMENT DISTANCE	56
5.3 TEST PROCEDURE	56
5.4 DEVIATION FROM TEST STANDARD	56
5.5 TEST SETUP	56
5.6 FIELD STRENGTH CALCULATION	56
5.7 EUT OPERATING CONDITIONS	56
5.8 TEST RESULTS	57
6. ANTENNA REQUIREMENT	59
6.1 STANDARD REQUIREMENT	59
6.2 EUT ANTENNA	59



Revision History

Rev.	Issue Date	Report NO.	Effect Page	Contents
00	09 June 2022	STS2203130W02	ALL	Initial Issue





1. SUMMARY OF TEST RESULTS

Test procedures according to the technical standards:

FCC Part 15. Subpart F RSS 220 Issue 1, amendment 1 July 2018			
Standard Section	Test Item	Judgment	Remark
15.207 RSS-Gen (8.8)	AC Power Conducted Emission	Pass	
15.203 RSS-Gen (6.8)	Antenna Requirement	Pass	
15.209 15.517(c) RSS-220 (3.4) RSS-220 (5.2.1(d))	Radiated Spurious Emission	Pass	
15.209 15.517(d) RSS-220 (5.2.1(e))	Radiated Spurious Emission in GPS Band	Pass	
15.517(e) RSS-220 (5.2.1(g))	Peak Emissions within a 50MHz Bandwidth	Pass	
15.517(b) RSS-220 (2)	UWB Bandwidth	Pass	
RSS-Gen 6.7	99% Bandwidth	Pass	

NOTE:

- (1) 'N/A' denotes test is not applicable in this Test Report.
- (2) All tests are according to ANSI C63.10-2013.



1.1 TEST FACTORY

SHENZHEN STS TEST SERVICES CO., LTD

Add. : A 1/F, Building B, Zhuoke Science Park, No.190 Chongqing Road, HepingShequ, Fuyong Sub-District, Bao'an District, Shenzhen, Guang Dong, China

FCC test Firm Registration Number: 625569

IC test Firm Registration Number: 12108A

A2LA Certificate No.: 4338.01

1.2 MEASUREMENT UNCERTAINTY

The reported uncertainty of measurement $y \pm U$, where expanded uncertainty U is based on a standard uncertainty multiplied by a coverage factor of $k=2$, providing a level of confidence of approximately **95 %**.

No.	Item	Uncertainty
1	RF output power, conducted	$\pm 0.87\text{dB}$
2	Unwanted Emissions, conducted	$\pm 2.895\text{dB}$
3	All emissions, radiated 9K-30MHz	$\pm 3.80\text{dB}$
4	All emissions, radiated 30M-1GHz	$\pm 4.09\text{dB}$
5	All emissions, radiated 1G-6GHz	$\pm 4.92\text{dB}$
6	All emissions, radiated >6G	$\pm 5.49\text{dB}$
7	Conducted Emission (9KHz-30MHz)	$\pm 2.73\text{dB}$

2. GENERAL INFORMATION

2.1 GENERAL DESCRIPTION OF THE EUT

Product Name/PMN	Indoor Anchor								
Trade Name	Litum								
Model Name	110								
HVIN	110A								
Series Model	N/A								
Model Difference	N/A								
Product Description	<p>The EUT is a Indoor Anchor</p> <table border="1"> <tr> <td>Operation Frequency:</td> <td>6489.6MHz</td> </tr> <tr> <td>Modulation Type:</td> <td>BPSK</td> </tr> <tr> <td>Antenna Type:</td> <td>PCB antenna</td> </tr> <tr> <td>Antenna Gain(Peak):</td> <td>3.3dBi</td> </tr> </table> <p>Based on the application, features, or specification exhibited in User Manual, the EUT is considered as an ITE/Computing Device. More details of EUT technical specification, please refer to the User Manual.</p>	Operation Frequency:	6489.6MHz	Modulation Type:	BPSK	Antenna Type:	PCB antenna	Antenna Gain(Peak):	3.3dBi
Operation Frequency:	6489.6MHz								
Modulation Type:	BPSK								
Antenna Type:	PCB antenna								
Antenna Gain(Peak):	3.3dBi								
Channel List	Please refer to the Note 2.								
Rating	Input: 110-240V~, 50/60Hz, 0.065A Max.								
Hardware version number	LT020104								
Software version number/FVIN	LT_02_01_RTLS_10020300								
Serial Numbers	2100203220001								
Connecting I/O Port(s)	Please refer to the Note 1.								

Note:

- For a more detailed features description, please refer to the manufacturer's specifications or the User Manual.

- | Test channel | Frequency(GHz) | Test channel | Frequency(GHz) |
|--------------|----------------|--------------|----------------|
| 1 | 6489.6 | - | - |

- Table for Filed Antenna

Ant	Brand	Model Name	Antenna Type	Connector	Gain (dBi)	NOTE
1	Litum	110	PCB	N/A	3.3	Antenna

Note: The antenna information refer the manufacturer provide report, applicable only to the tested sample identified in the report.



2.2 DESCRIPTION OF THE TEST MODES

For Radiated spurious emissions

Each of these EUT operation mode(s) or test configuration mode(s) mentioned below was evaluated respectively.

Pretest Mode	Description	Modulation
Mode 1	TX	BPSK

Note:

(1) All above mode have been measurement, only worst data was reported.

(2) We have be tested for all avaiable U.S. voltage and frequencies(For 120V,50/60Hz and 240V, 50/60Hz) for which the device is capable of operation, and the worst case of 120V,50/60Hz is shown in the report.

For AC Conducted Emission

Test Case	
AC Conducted Emission	Mode 2 : Keeping TX

2.3 TEST SOFTWARE AND POWER LEVEL

During testing channel & power controlling software provided by the customer was used to control the operating channel as well as the output power level.

RF Function	Type	Mode Or Modulation type	Ant Gain(dBi)	Power Class	Software For Testing
UWB	6849.6MHz	BPSK	3.3	Default	The Transmitter EUT has signal transmission when it is powered on

2.4 BLOCK DIGRAM SHOWING THE CONFIGURATION OF SYSTEM TESTED

During testing channel & power controlling software provided by the customer was used to control the operating channel as well as the output power level. The RF output power selection is for the setting of RF output power expected by the customer and is going to be fixed on the firmware of the final end product power parameters.

Radiated Spurious Emission Test

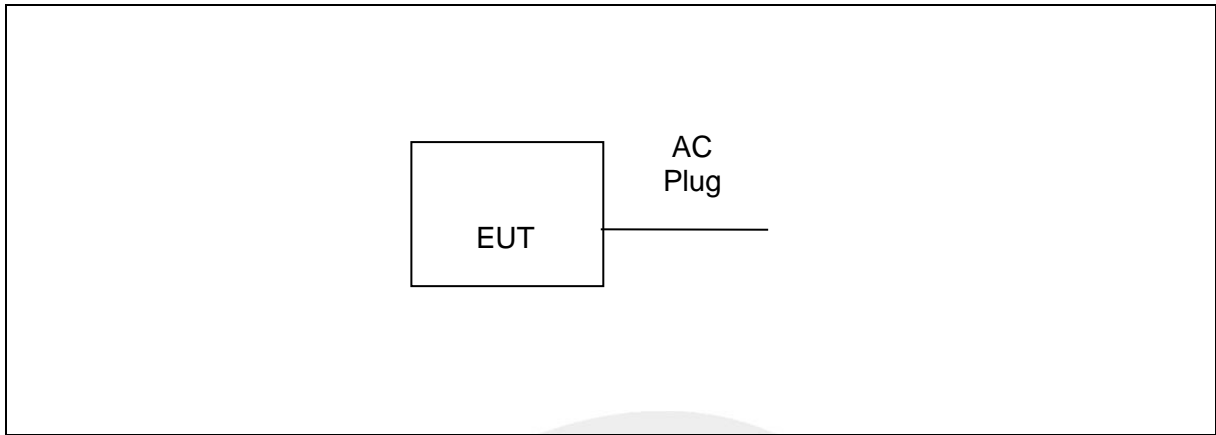

Conducted Emission Test

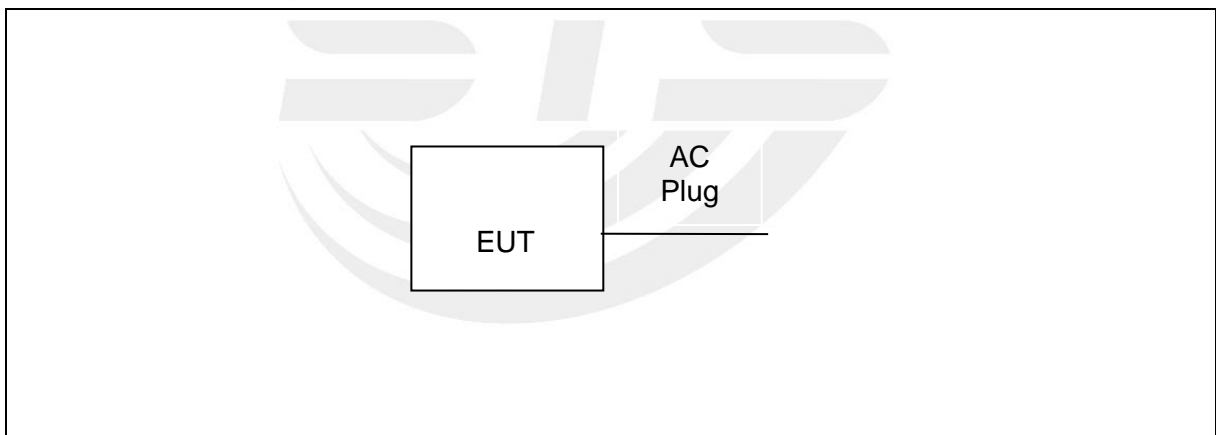



2.5 DESCRIPTION OF NECESSARY ACCESSORIES AND SUPPORT UNITS

The EUT has been tested as an independent unit together with other necessary accessories or support units. The following support units or accessories were used to form a representative test configuration during the tests.

Necessary accessories

Item	Equipment	Mfr/Brand	Model/Type No.	Serial No.	Note
N/A	N/A	N/A	N/A	N/A	N/A

Support units

Item	Equipment	Mfr/Brand	Model/Type No.	Serial No.	Note
N/A	N/A	N/A	N/A	N/A	N/A

Note:

- (1) The support equipment was authorized by Declaration of Confirmation.
- (2) For detachable type I/O cable should be specified the length in cm in 『Length』 column.



2.6 EQUIPMENTS LIST FOR ALL TEST ITEMS

Radiation Test equipment

Kind of Equipment	Manufacturer	Type No.	Serial No.	Last calibration	Calibrated until
Test Receiver	R&S	ESCI	101427	2021.09.30	2022.09.29
Signal Analyzer	R&S	FSV 40-N	101823	2021.09.30	2022.09.29
Active loop Antenna	ZHINAN	ZN30900C	16035	2021.04.11	2023.04.10
Bilog Antenna	TESEQ	CBL6111D	34678	2020.10.12	2022.10.11
Horn Antenna	SCHWARZBECK	BBHA 9120D	02014	2021.10.11	2023.10.10
Pre-Amplifier (0.1M-3GHz)	EM	EM330	060665	2021.10.08	2022.10.07
Pre-Amplifier (1G-18GHz)	SKET	LNPA-01018G-45	SK201808090 1	2021.09.30	2022.09.29
Temperature & Humidity	HH660	Mieo	N/A	2021.10.09	2022.10.08
Turn table	EM	SC100_1	60531	N/A	N/A
Antenna mast	EM	SC100	N/A	N/A	N/A
Test SW	FARAD	EZ-EMC(Ver.STSLAB-03A1 RE)			

RF Connected Test

Kind of Equipment	Manufacturer	Type No.	Serial No.	Last calibration	Calibrated until
Signal Analyzer	Agilent	N9020A	MY51110105	2022.03.01	2023.02.28
Temperature & Humidity	HH660	Mieo	N/A	2021.10.09	2022.10.08
Test SW	FARAD	LZ-RF /LzRf-3A3			

3. EMISSION TEST

3.1 CONDUCTED EMISSION MEASUREMENT

3.1.1 POWER LINE CONDUCTED EMISSION LIMITS

Operating frequency band. In case the emission fall within the restricted band specified on Part 15.207&RSS-Gen (8.8) limit in the table below has to be followed.

FREQUENCY (MHz)	Quasi-peak	Average
0.15 -0.5	66 - 56 *	56 - 46 *
0.50 -5.0	56.00	46.00
5.0 -30.0	60.00	50.00

Note:

- (1) The tighter limit applies at the band edges.
- (2) The limit of “*” marked band means the limitation decreases linearly with the logarithm of the frequency in the range.

The following table is the setting of the receiver

Receiver Parameters	Setting
Attenuation	10 dB
Start Frequency	0.15 MHz
Stop Frequency	30 MHz
IF Bandwidth	9 kHz

3.1.2 TEST PROCEDURE

- a. The EUT was 0.8 meters from the horizontal ground plane and 0.4 meters from the vertical ground plane with EUT being connected to the power mains through a line impedance stabilization network (LISN). All other support equipments powered from additional LISN(s). The LISN provide 50 Ohm/ 50uH of coupling impedance for the measuring instrument.
- b. Interconnecting cables that hang closer than 40 cm to the ground plane shall be folded back and forth in the center forming a bundle 30 to 40 cm long.
- c. I/O cables that are not connected to a peripheral shall be bundled in the center. The end of the cable may be terminated, if required, using the correct terminating impedance. The overall length shall not exceed 1 m.
- d. LISN at least 80 cm from nearest part of EUT chassis.
- e. For the actual test configuration, please refer to the related Item –EUT Test Photos.

3.1.3 TEST SETUP

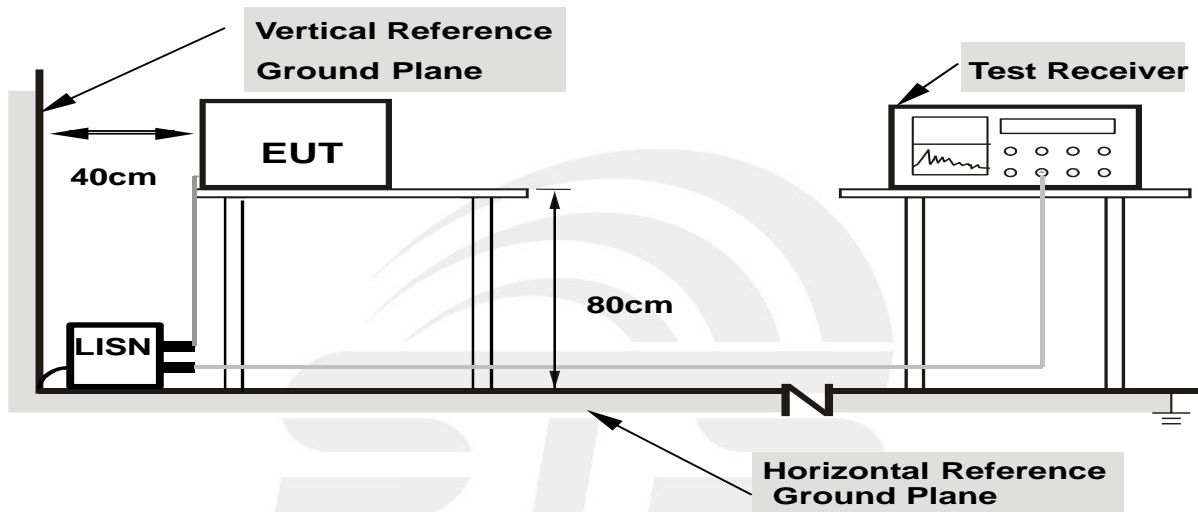

- Note: 1.Support units were connected to second LISN.**
2.Both of LISNs (AMN) are 80 cm from EUT and at least 80 from other units and other metal planes

3.1.4 EUT OPERATING CONDITIONS

The EUT was configured for testing in a typical fashion (as a customer would normally use it). The EUT has been programmed to continuously transmit during test. This operating condition was tested and used to collect the included data.



3.1.5 TEST RESULT

Temperature:	23.2(C)	Relative Humidity:	44%RH
Test Voltage:	AC 120V/60Hz	Phase:	L
Test Mode:	Mode 2		

No.	Frequency (MHz)	Reading (dBuV)	Correct Factor(dB)	Result (dBuV)	Limit (dBuV)	Margin (dB)	Remark
1	0.8260	29.96	20.34	50.30	56.00	-5.70	QP
2	0.8260	25.27	20.34	45.61	46.00	-0.39	AVG
3	0.9540	21.59	20.31	41.90	56.00	-14.10	QP
4	0.9540	14.66	20.31	34.97	46.00	-11.03	AVG
5	1.5220	21.07	20.35	41.42	56.00	-14.58	QP
6	1.5220	14.95	20.35	35.30	46.00	-10.70	AVG
7	2.0100	21.02	20.39	41.41	56.00	-14.59	QP
8	2.0100	14.30	20.39	34.69	46.00	-11.31	AVG
9	3.1700	20.88	20.47	41.35	56.00	-14.65	QP
10	3.1700	14.10	20.47	34.57	46.00	-11.43	AVG
11	22.7140	22.65	22.81	45.46	60.00	-14.54	QP
12	22.7140	14.90	22.81	37.71	50.00	-12.29	AVG

Remark:

1. All readings are Quasi-Peak and Average values
2. Margin = Result (Result =Reading + Factor)–Limit
3. Factor=LISN factor+Cable loss+Limiter (10dB)

120.0 dBuV

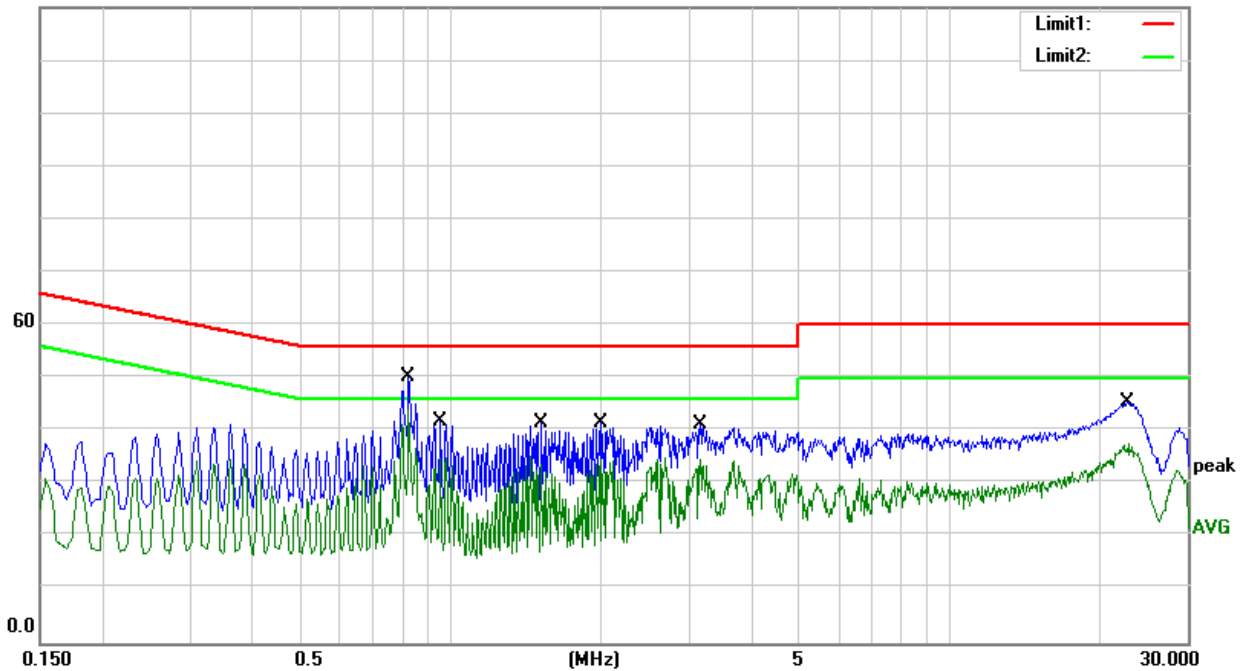



Temperature:	23.2(C)	Relative Humidity:	44%RH
Test Voltage:	AC 120V/60Hz	Phase:	N
Test Mode:	Mode 2		

No.	Frequency (MHz)	Reading (dBuV)	Correct Factor(dB)	Result (dBuV)	Limit (dBuV)	Margin (dB)	Remark
1	0.8260	23.96	20.34	44.30	56.00	-11.70	QP
2	0.8260	15.41	20.34	35.75	46.00	-10.25	AVG
3	1.1340	17.03	20.31	37.34	56.00	-18.66	QP
4	1.1340	6.65	20.31	26.96	46.00	-19.04	AVG
5	1.6740	19.61	20.36	39.97	56.00	-16.03	QP
6	1.6740	8.16	20.36	28.52	46.00	-17.48	AVG
7	2.8340	17.22	20.45	37.67	56.00	-18.33	QP
8	2.8340	7.38	20.45	27.83	46.00	-18.17	AVG
9	3.9980	16.62	20.51	37.13	56.00	-18.87	QP
10	3.9980	5.20	20.51	25.71	46.00	-20.29	AVG
11	22.9500	21.49	22.80	44.29	60.00	-15.71	QP
12	22.9500	14.27	22.80	37.07	50.00	-12.93	AVG

Remark:

1. All readings are Quasi-Peak and Average values
2. Margin = Result (Result =Reading + Factor)–Limit
3. Factor=LISN factor+Cable loss+Limiter (10dB)

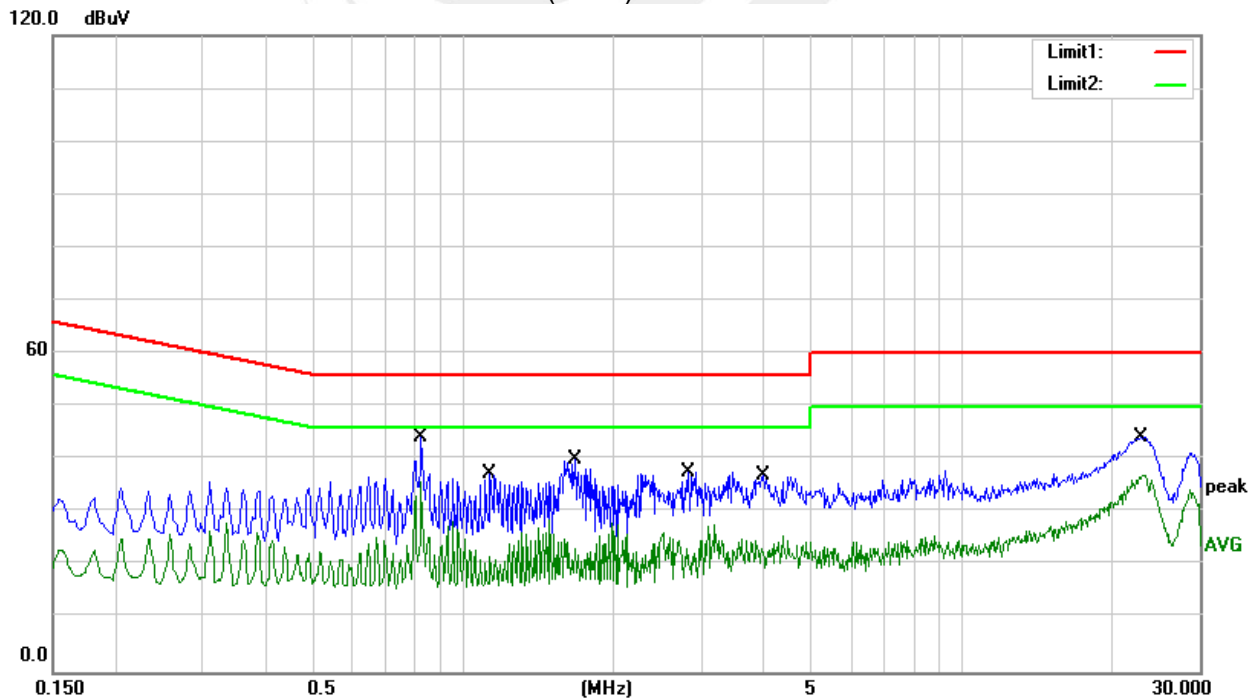

**3.2 RADIATED EMISSION MEASUREMENT (FOR 15.517(c)&RSS 220 5.2.1(d))****3.2.1 RADIATED EMISSION LIMITS**

The radiated emissions at or below 960MHz from a device operating under the provisions of this section shall not exceed the emission levels in Section 15.209&RSS 220(3.4).

Frequencies (MHz)	Field Strength (micovolts/meter)	Measurement Distance (meters)
0.009~0.490	2400/F(KHz)	300
0.490~1.705	24000/F(KHz)	30
1.705~30.0	30	30
30~88	100	3
88~216	150	3
216~960	200	3

Note: 1. The lower limit shall apply at the transition frequencies.

2. Emission level (dBuV/m) = 20 log Emission level (uV/m).

For FCC:

The radiated emissions above 960MHz from a device operating under the provisions of this section shall not exceed the following average limits when measured using a resolution bandwidth of 1MHz:

Frequency of Emission (MHz)	EIRP (dBm)	Field Strength (dBuV/m@3m)	Field Strength (dBuV/m@1m)
960~1610	-75.3	19.9	29.44
1610~1990	-53.3	41.9	51.44
1990~3100	-51.3	43.9	53.44
3100~10600	-41.3	53.9	63.44
Above 10600	-51.3	43.9	53.44

Notes: 1. Transfer rules follow 15.521(g),15.31(f)(1).

2. 15.521(c) Emissions from digital circuitry used to enable the operation of the UWB transmitter shall comply with the limits in Section 15.209 of this chapter, rather than the limits specified in this subpart.

3. $E(\text{dBuV/m})@3\text{m} = P(\text{dBm EIRP}) + 95.2;$

$E(\text{dBuV/m})@1\text{m} = E(\text{dBuV/m})@3\text{m} + 20 \cdot \log(3/1)$



For IC:

The radiated emissions above 960MHz from a device operating under the provisions of this section shall not exceed the following average limits when measured using a resolution bandwidth of 1MHz:

Frequency of Emission (MHz)	EIRP (dBm)	Field Strength (dBuV/m@3m)	Field Strength (dBuV/m@1m)
960~1610	-75.3	19.9	29.44
1610~4750	-70.0	25.2	34.74
4750~10600	-41.3	53.9	63.44
Above 10600	-51.3	43.9	53.44

Notes: 1. Transfer rules follow section 2 of the RSS 220 Annex.

2. The Emissions from digital circuitry used to enable the operation of the UWB transmitter shall comply with the limits in Section RSS 220(3.4) of this chapter, rather than the limits specified in this subpart.

3. $E(\text{dBuV/m})@3\text{m} = P(\text{dBm EIRP}) + 95.2;$
 $E(\text{dBuV/m})@1\text{m} = E(\text{dBuV/m})@3\text{m} + 20 \cdot \log(3/1)$

Spectrum Parameter	Setting
Detector	RMS
Attenuation	Auto
Start Frequency	960 MHz
Stop Frequency	10th of the highest fundamental frequency or to 40 GHz, whichever is lower
RB	1MHz
VB	3MHz
Sweep Point	1001
SweepTime	1s

Receiver Parameter	Setting
Attenuation	Auto
Start ~ Stop Frequency	9kHz~90kHz / RB 200Hz for PK & AV
	90kHz~110kHz / RB 200Hz for QP
	110kHz~490kHz / RB 200Hz for PK & AV
	490kHz~30MHz / RB 9kHz for QP
	30MHz~960MHz / RB 120kHz for QP



3.2.2 TEST PROCEDURE

- a. The measuring distance of 1m shall be used for measurements. The EUT was placed on the top of a rotating table 0.8meter (above 1GHz is 1.5 m) above the ground at a 3 meter semi-anechoic chamber. The table was rotated 360 degrees to determine the position of the highest radiation.
- b. The height of the test antenna shall vary between 1m to 4m. Both horizontal and vertical polarization of the antenna are set to make the measurement.
- c. The initial step in collecting radiated emission data is a receive peak detector mode. Pre-scanning the measurement frequency range. Significant peaks are then marked and then Quasi Peak detector mode re-measured.
- d. All readings are peak unless otherwise stated QP in column of Note. Peak denoted that the Peak reading compliance with the QP limits and then QP Mode measurement didn't perform (Below 960MHz)
- e. All readings are RMS mode value, for each suspected emission, the EUT was arranged to its worst case and then the antenna was tuned to heights from 1 meter to 4 meters and the rotatable table was turned from 0 degrees to 360 degrees to find the maximum reading. (Above 960MHz)
- f. For the actual test configuration, please refer to the related Item –EUT Test Photos.
Note: Both horizontal and vertical antenna polarities were tested and performed pretest to three orthogonal axis. The worst case emissions were reported.

3.2.3 DEVIATION FROM TEST STANDARD

No deviation

3.2.4 TEST SETUP

(A) Radiated Emission Test-Up Frequency Below 30MHz

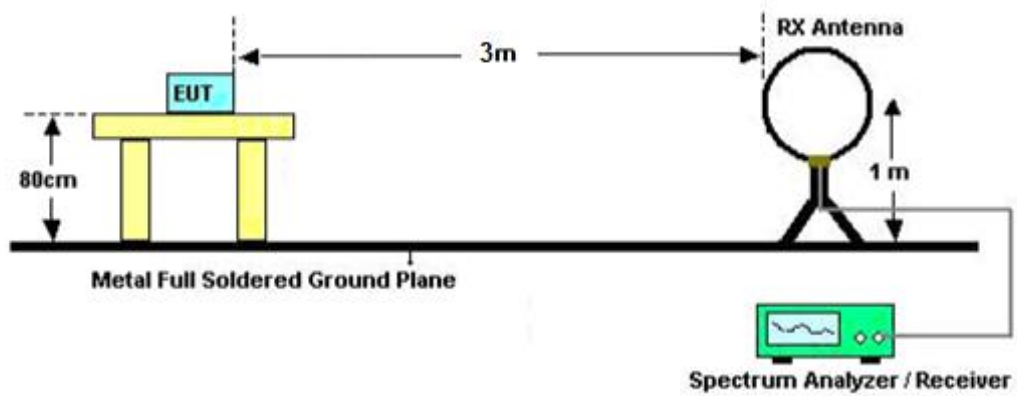

(B) Radiated Emission Test-Up Frequency 30MHz~1GHz

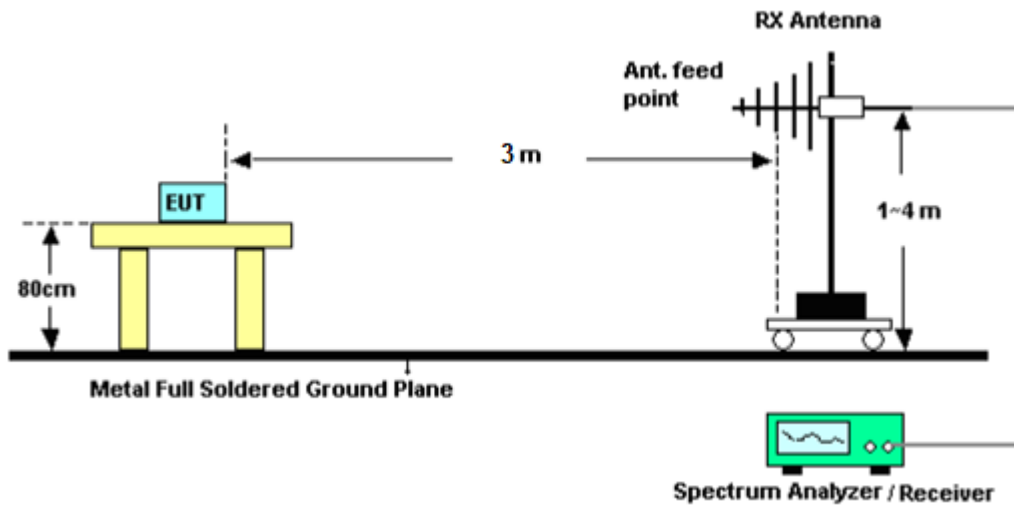

(C) Radiated Emission Test-Up Frequency Above 1GHz

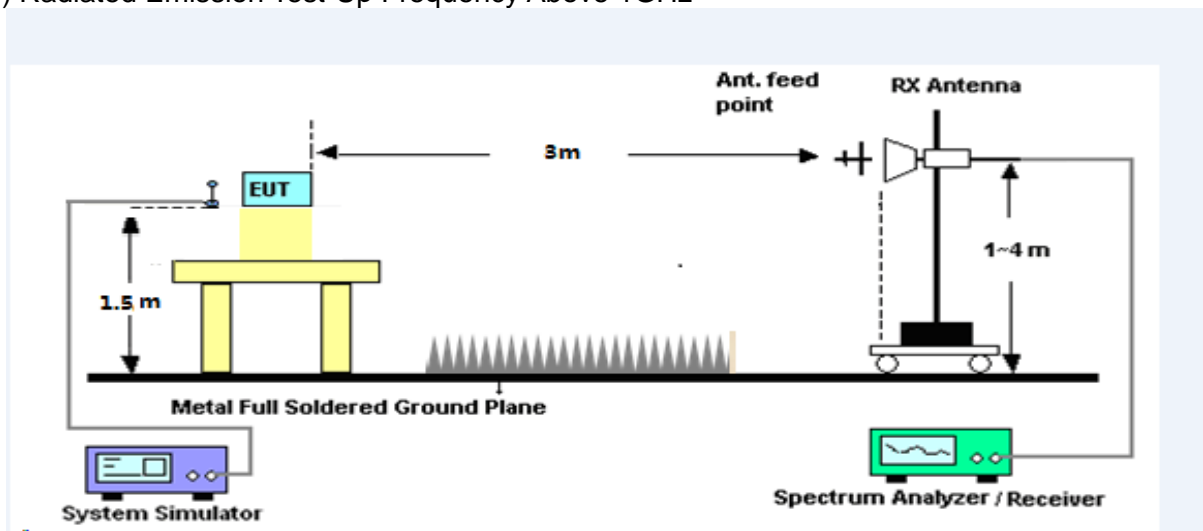

3.2.5 FIELD STRENGTH CALCULATION

The field strength is calculated by adding the Antenna Factor and Cable Factor and subtracting the Amplifier Gain and Duty Cycle Correction Factor (if any) from the measured reading. The basic equation with a sample calculation is as follows:

Margin=PL-PK L or AL- AV L; Margin only shown the worst case.

Where

PR = Peak Reading

AR = Average Reading

PL = Peak Level

AL = Average Level

AF = Antenna Factor

PK L = Peak Limit

AV L = AV Limit

For example

Frequency	PR	AR	AF	PL	AL	PK L	AV L	Margin
(MHz)	(dB μ V/m)	(dB μ V/m)	(dB)	(dB μ V/m)	(dB μ V/m)	(dB μ V/m)	(dB μ V/m)	(dB)
2178	40.23	30.31	9.83	50.06	40.14	74.00	54.00	-13.86

3.2.6 EUT OPERATING CONDITIONS

The EUT tested system was configured as the statements of 2.4 Unless otherwise a special operating condition is specified in the follows during the testing.

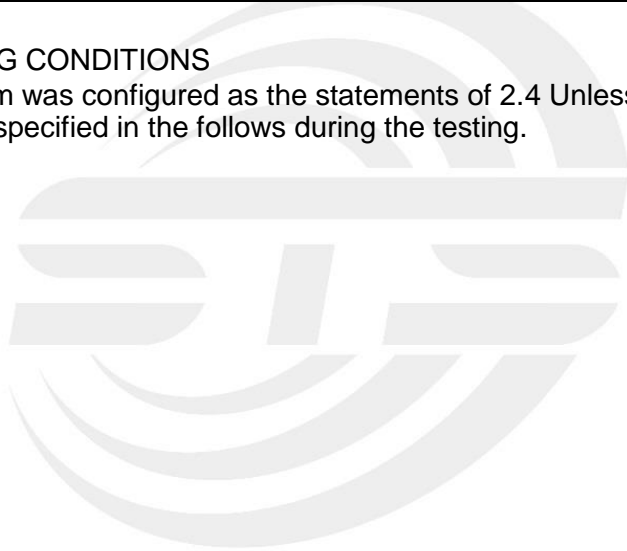



3.2.7 TEST RESULTS

Below 30MHz

Temperature:	23.1(C)	Relative Humidity:	60%RH
Test Voltage:	AC 120V/50Hz	Test Mode:	CH 1(9KHz - 150KHz)
Test distance:	3m		

No.	Frequency (KHz)	Reading (dBuV)	Correct Factor(dB/m)	Result (dBuV/m)	Limit (dBuV/m)	Margin (dB)	Remark
1	0.0177	11.17	19.93	31.10	122.64	-91.54	QP
2	0.0300	17.57	19.90	37.47	118.06	-80.59	QP
3	0.0504	20.77	19.49	40.26	113.55	-73.29	QP
4	0.0704	25.09	18.93	44.02	110.65	-66.63	QP
5	0.1018	25.29	17.60	42.89	107.45	-64.56	QP
6	0.1273	26.84	17.55	44.39	105.51	-61.12	QP

Remark:

- Margin = Result (Result =Reading + Factor)-Limit
- Factor= Antenna factor+Cable attenuation factor(cable loss)-Amplifier gain

180.0 dBuV/m

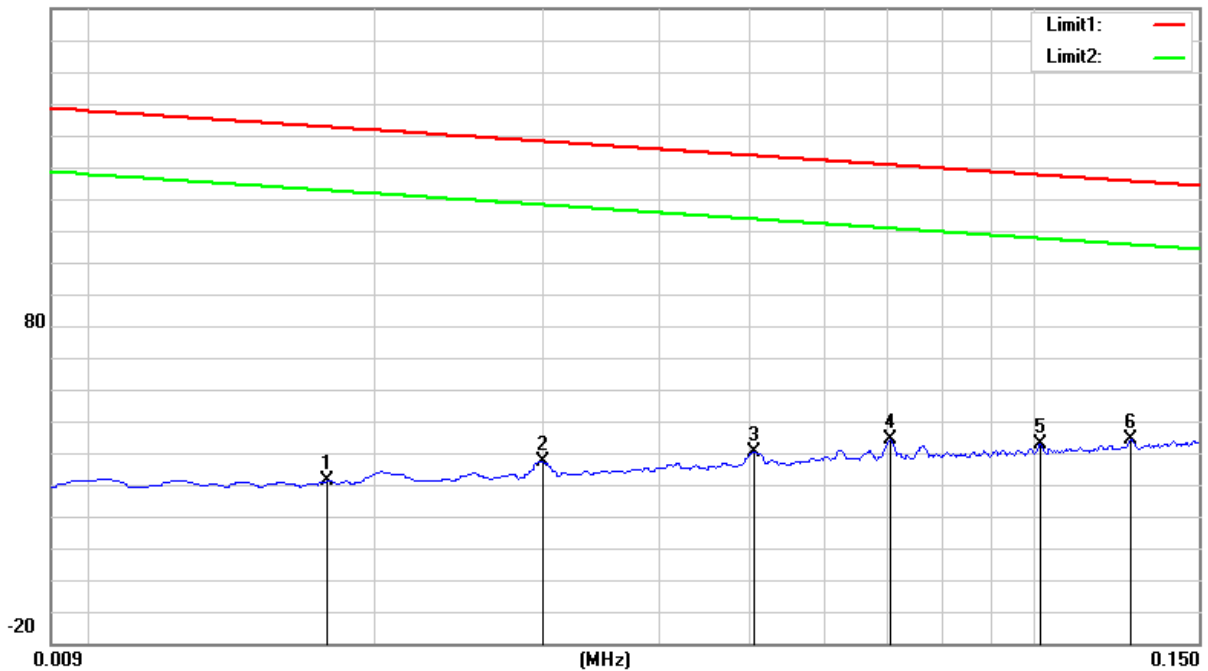



Temperature:	23.1(C)	Relative Humidity:	60%RH
Test Voltage:	AC 120V/50Hz	Test Mode:	CH 1 (150KHz – 30MHz)
Test distance:	3m		

No.	Frequency (MHz)	Reading (dBuV)	Correct Factor(dB/m)	Result (dBuV/m)	Limit (dBuV/m)	Margin (dB)	Remark
1	0.4485	8.99	20.18	29.17	94.57	-65.40	peak
2	1.2688	14.80	20.25	35.05	65.54	-30.49	peak
3	2.7470	18.55	20.18	38.73	69.54	-30.81	peak
4	5.3140	19.08	20.48	39.56	69.54	-29.98	peak
5	7.5229	19.92	20.35	40.27	69.54	-29.27	peak
6	19.0450	18.52	22.27	40.79	69.54	-28.75	peak

Remark:

- Margin = Result (Result =Reading + Factor) –Limit
- Factor= Antenna factor+Cable attenuation factor(cable loss)-Amplifier gain

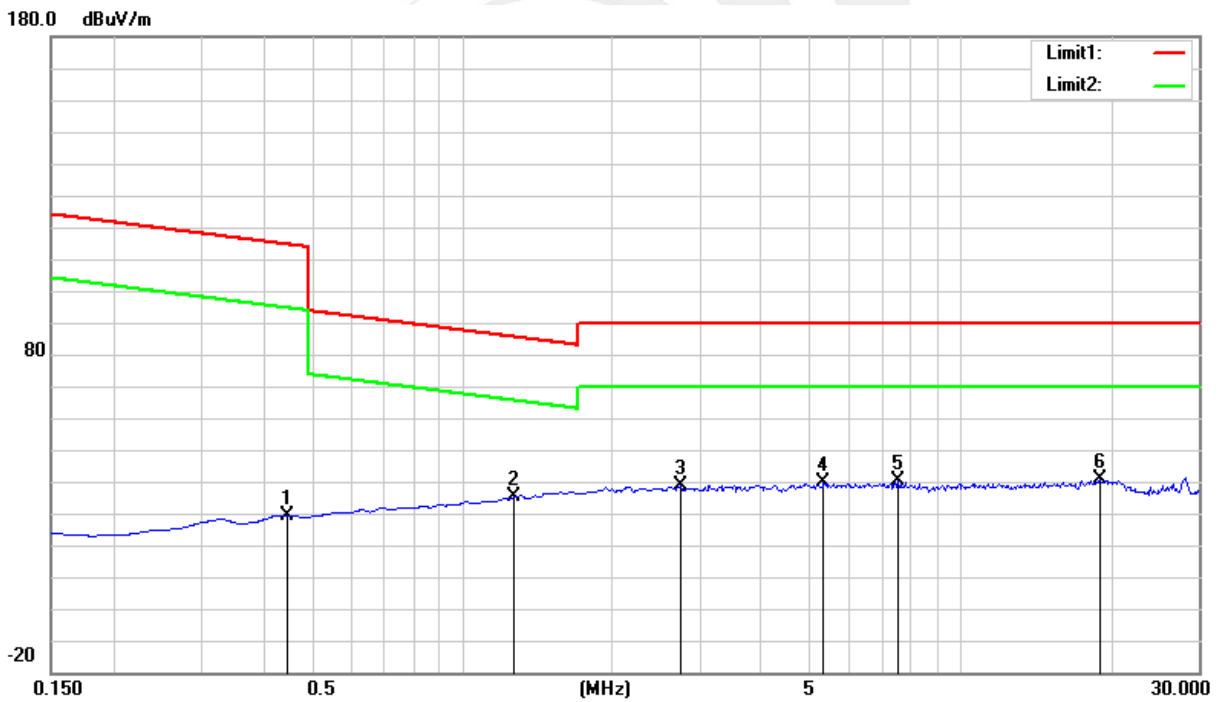

Note: The position of the measurement polarization (Horizontal / Face-on / Face-off) all has been tested, only shown the worst mode of Horizontal position.



30MHz – 960MHz Radiation Spurious

Temperature:	23.1(C)	Relative Humidity:	60%RH
Test Voltage:	AC 120V/50Hz	Phase:	Horizontal
Test Mode:	CH 1	Test distance:	3m

No.	Frequency (MHz)	Reading (dBuV)	Correct Factor(dB/m)	Result (dBuV/m)	Limit (dBuV/m)	Margin (dB)	Remark
1	31.8600	50.86	-13.82	37.04	40.00	-2.96	peak
2	116.4900	53.66	-18.50	35.16	43.50	-8.34	peak
3	160.2000	49.62	-18.83	30.79	43.50	-12.71	peak
4	292.2600	40.43	-15.07	25.36	46.00	-20.64	peak
5	734.0100	29.16	-2.33	26.83	46.00	-19.17	peak
6	941.4000	29.36	1.41	30.77	46.00	-15.23	peak

Remark:

1. $Margin = Result - (Reading + Factor) - Limit$
2. $Factor = Antenna\ factor + Cable\ attenuation\ factor(cable\ loss) - Amplifier\ gain$

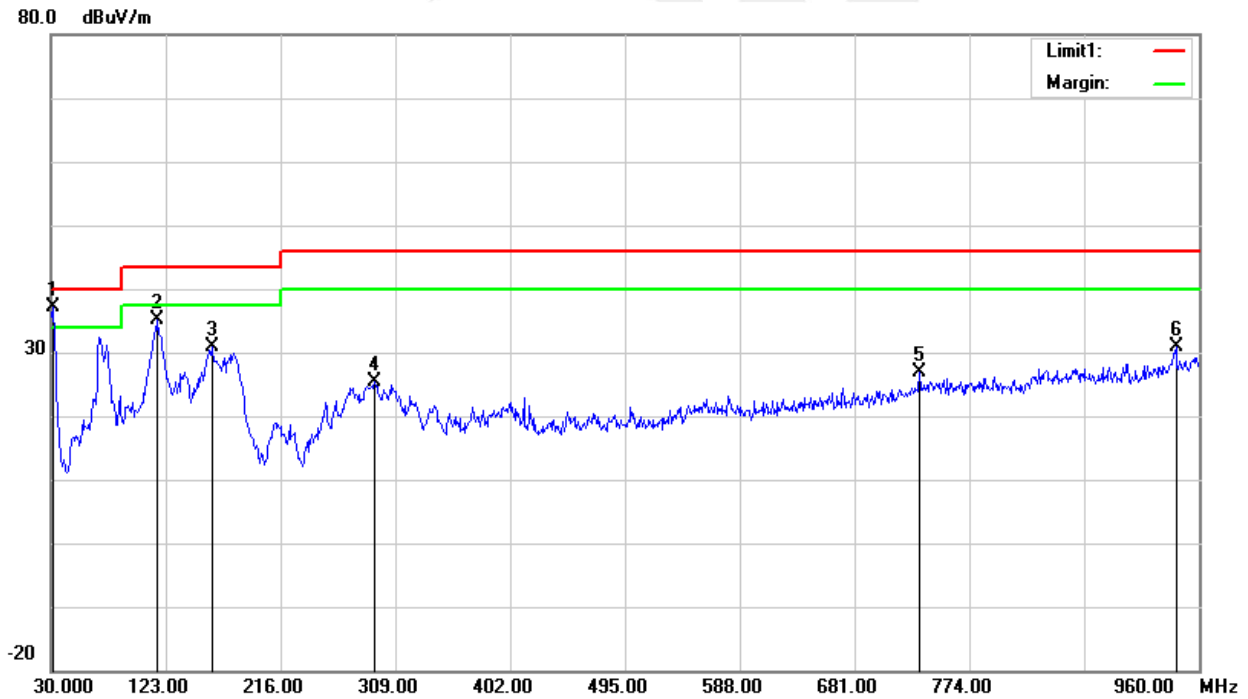



Temperature:	23.1(C)	Relative Humidity:	60%RH
Test Voltage:	AC 120V/50Hz	Phase:	Vertical
Test Mode:	CH 1	Test distance:	3m

No.	Frequency (MHz)	Reading (dBuV)	Correct Factor(dB/m)	Result (dBuV/m)	Limit (dBuV/m)	Margin (dB)	Remark
1	31.8600	46.54	-13.82	32.72	40.00	-7.28	peak
2	70.9200	56.64	-24.70	31.94	40.00	-8.06	peak
3	178.8000	49.93	-20.02	29.91	43.50	-13.59	peak
4	254.1300	40.81	-15.49	25.32	46.00	-20.68	peak
5	659.6100	29.29	-4.81	24.48	46.00	-21.52	peak
6	947.9100	27.50	1.55	29.05	46.00	-16.95	peak

Remark:

- Margin = Result (Result =Reading + Factor)-Limit
- Factor= Antenna factor+Cable attenuation factor(cable loss)-Amplifier gain

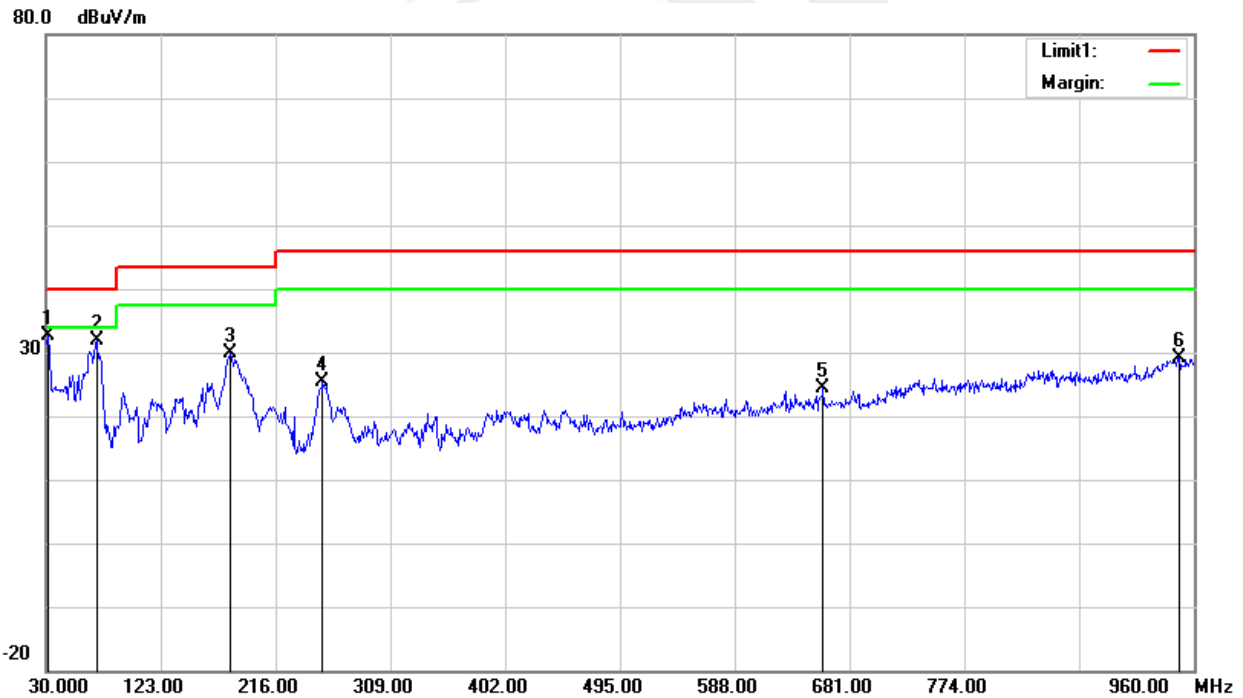



Above 960MHz Radiation Spurious

FCC:

Temperature:	23.1(C)	Relative Humidity:	60%RH
Test Voltage:	AC 120V/60Hz	Phase:	Horizontal
Test Mode:	CH 1(960MHz -1610MHz)	Test distance:	1m

No.	Frequency (MHz)	Reading (dBuV)	Correct Factor(dB/m)	Result (dBuV/m)	Limit (dBuV/m)	Margin (dB)	Remark
1	1078.950	26.82	-1.20	25.62	29.44	-3.82	peak
2	1078.950	17.86	-1.20	16.66	29.44	-12.78	RMS
3	1164.100	26.47	-0.77	25.70	29.44	-3.74	peak
4	1164.100	17.47	-0.77	16.70	29.44	-12.74	RMS
5	1277.200	25.99	-0.30	25.69	29.44	-3.75	peak
6	1277.200	16.99	-0.30	16.69	29.44	-12.75	RMS
7	1376.650	26.38	0.17	26.55	29.44	-2.89	peak
8	1376.650	17.35	0.17	17.52	29.44	-11.92	RMS
9	1469.600	25.24	1.12	26.36	29.44	-3.08	peak
10	1469.600	16.26	1.12	17.38	29.44	-12.06	RMS
11	1582.700	22.46	3.70	26.16	29.44	-3.28	peak
12	1582.700	13.43	3.70	17.13	29.44	-12.31	RMS

Remark:

- Margin = Result (Result =Reading + Factor) –Limit
- Factor= Antenna factor+Cable attenuation factor(cable loss)-Amplifier gain

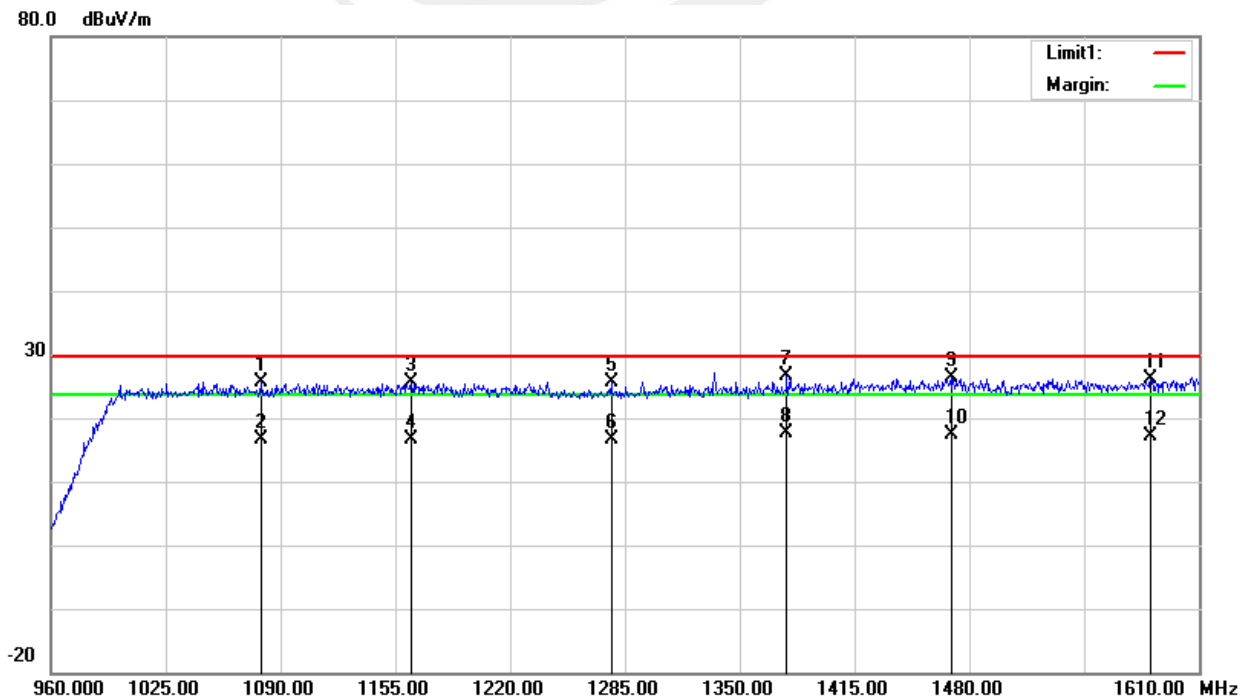



Temperature:	23.1(C)	Relative Humidity:	60%RH
Test Voltage:	AC 120V/60Hz	Phase:	Vertical
Test Mode:	CH 1(960MHz -1610MHz)	Test distance:	1m

No.	Frequency (MHz)	Reading (dBuV)	Correct Factor(dB/m)	Result (dBuV/m)	Limit (dBuV/m)	Margin (dB)	Remark
1	1065.950	23.43	-1.27	22.16	29.44	-7.28	peak
2	1065.950	14.40	-1.27	13.13	29.44	-16.31	RMS
3	1200.500	22.97	-0.42	22.55	29.44	-6.89	peak
4	1200.500	13.94	-0.42	13.52	29.44	-15.92	RMS
5	1329.200	22.61	-0.02	22.59	29.44	-6.85	peak
6	1329.200	13.56	-0.02	13.54	29.44	-15.90	RMS
7	1416.950	22.92	0.48	23.40	29.44	-6.04	peak
8	1416.950	13.99	0.48	14.47	29.44	-14.97	RMS
9	1468.950	22.92	1.11	24.03	29.44	-5.41	peak
10	1468.950	13.95	1.11	15.06	29.44	-14.38	RMS
11	1567.100	22.18	3.20	25.38	29.44	-4.06	peak
12	1567.100	13.13	3.20	16.33	29.44	-13.11	RMS

Remark:

- Margin = Result (Result =Reading + Factor)-Limit
- Factor= Antenna factor+Cable attenuation factor(cable loss)-Amplifier gain

80.0 dBuV/m

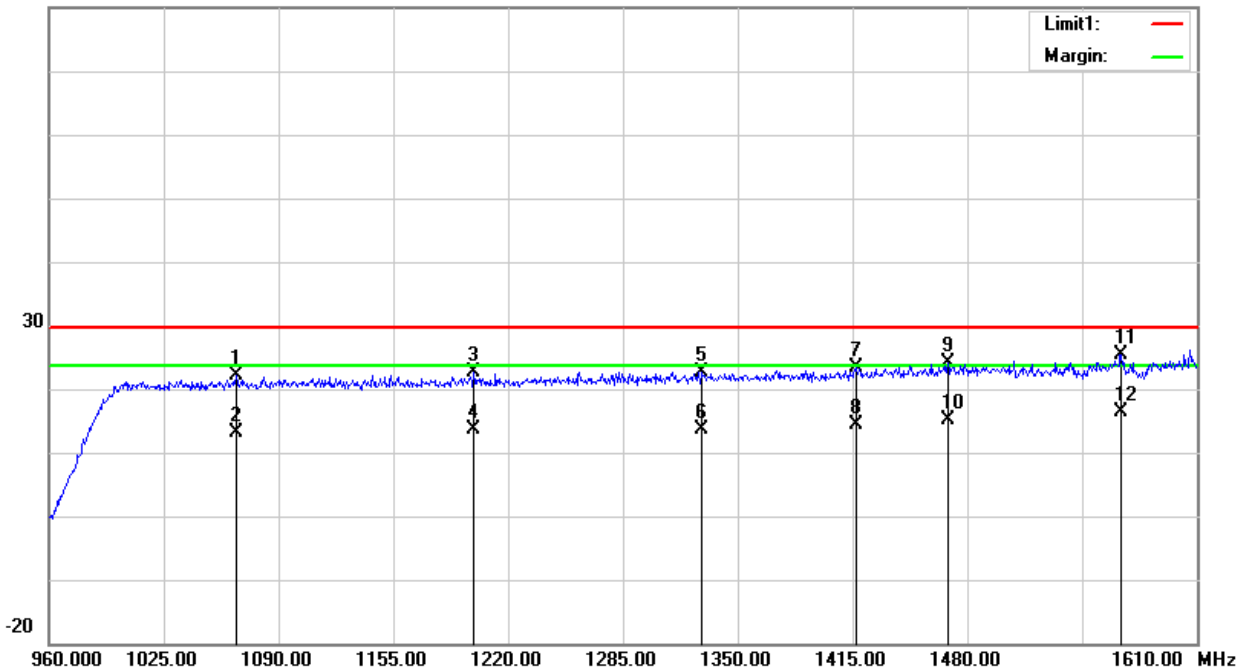



Temperature:	23.1(C)	Relative Humidity:	60%RH
Test Voltage:	AC 120V/60Hz	Phase:	Horizontal
Test Mode:	CH 1(1610MHz – 1990MHz)	Test distance:	1m

No.	Frequency (MHz)	Reading (dBuV)	Correct Factor(dB/m)	Result (dBuV/m)	Limit (dBuV/m)	Margin (dB)	Remark
1	1647.240	35.39	4.23	39.62	51.44	-11.82	peak
2	1647.240	25.44	4.23	29.67	51.44	-21.77	RMS
3	1703.480	35.26	5.11	40.37	51.44	-11.07	peak
4	1703.480	25.24	5.11	30.35	51.44	-21.09	RMS
5	1773.780	34.79	2.77	37.56	51.44	-13.88	peak
6	1773.780	24.81	2.77	27.58	51.44	-23.86	RMS
7	1837.240	35.78	2.21	37.99	51.44	-13.45	peak
8	1837.240	25.71	2.21	27.92	51.44	-23.52	RMS
9	1894.620	36.77	1.56	38.33	51.44	-13.11	peak
10	1894.620	26.81	1.56	28.37	51.44	-23.07	RMS
11	1973.280	35.31	1.75	37.06	51.44	-14.38	peak
12	1973.280	25.32	1.75	27.07	51.44	-24.37	RMS

Remark:

- Margin = Result (Result =Reading + Factor)-Limit
- Factor= Antenna factor+Cable attenuation factor(cable loss)-Amplifier gain

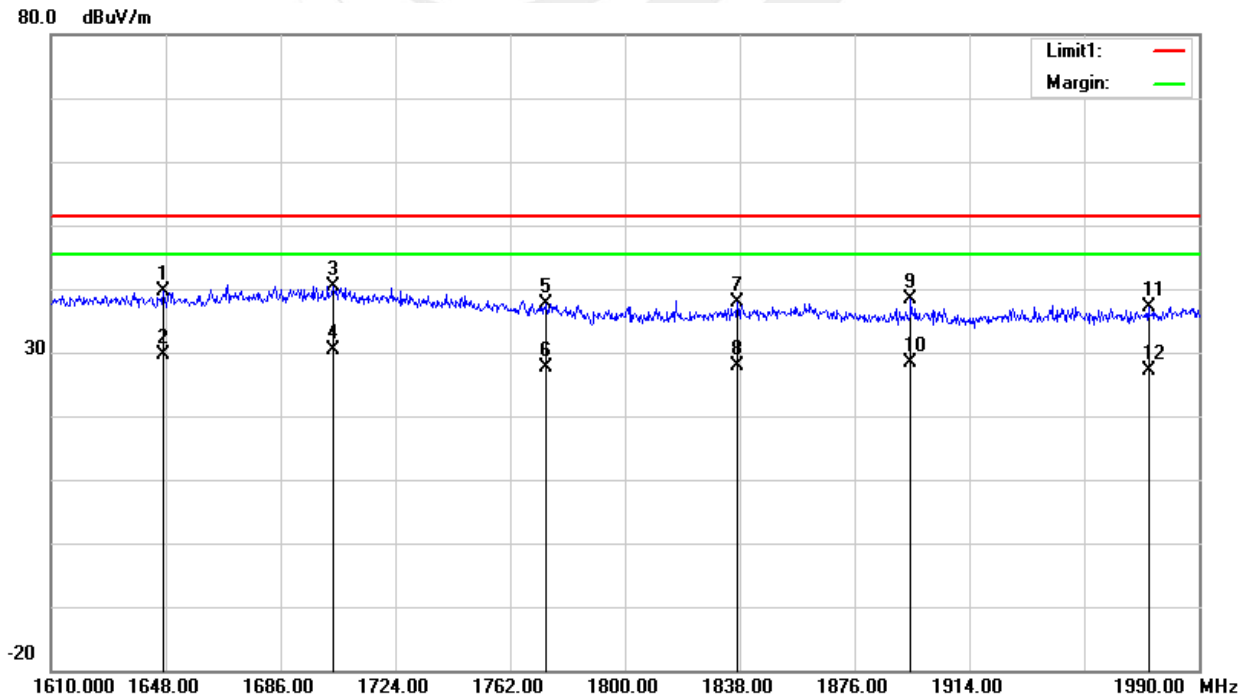



Temperature:	23.1(C)	Relative Humidity:	60%RH
Test Voltage:	AC 120V/60Hz	Phase:	Vertical
Test Mode:	CH 1(1610MHz – 1990MHz)	Test distance:	1m

No.	Frequency (MHz)	Reading (dBuV)	Correct Factor(dB/m)	Result (dBuV/m)	Limit (dBuV/m)	Margin (dB)	Remark
1	1633.180	35.35	4.24	39.59	51.44	-11.85	peak
2	1633.180	25.31	4.24	29.55	51.44	-21.89	RMS
3	1687.140	35.34	4.96	40.30	51.44	-11.14	peak
4	1687.140	25.41	4.96	30.37	51.44	-21.07	RMS
5	1767.320	37.76	3.00	40.76	51.44	-10.68	peak
6	1767.320	27.72	3.00	30.72	51.44	-20.72	RMS
7	1836.100	35.74	2.19	37.93	51.44	-13.51	peak
8	1836.100	25.73	2.19	27.92	51.44	-23.52	RMS
9	1880.940	35.84	1.80	37.64	51.44	-13.80	peak
10	1880.940	25.85	1.80	27.65	51.44	-23.79	RMS
11	1938.700	36.57	1.51	38.08	51.44	-13.36	peak
12	1938.700	26.54	1.51	28.05	51.44	-23.39	RMS

Remark:

- Margin = Result (Result =Reading + Factor)-Limit
- Factor= Antenna factor+Cable attenuation factor(cable loss)-Amplifier gain

80.0 dBuV/m

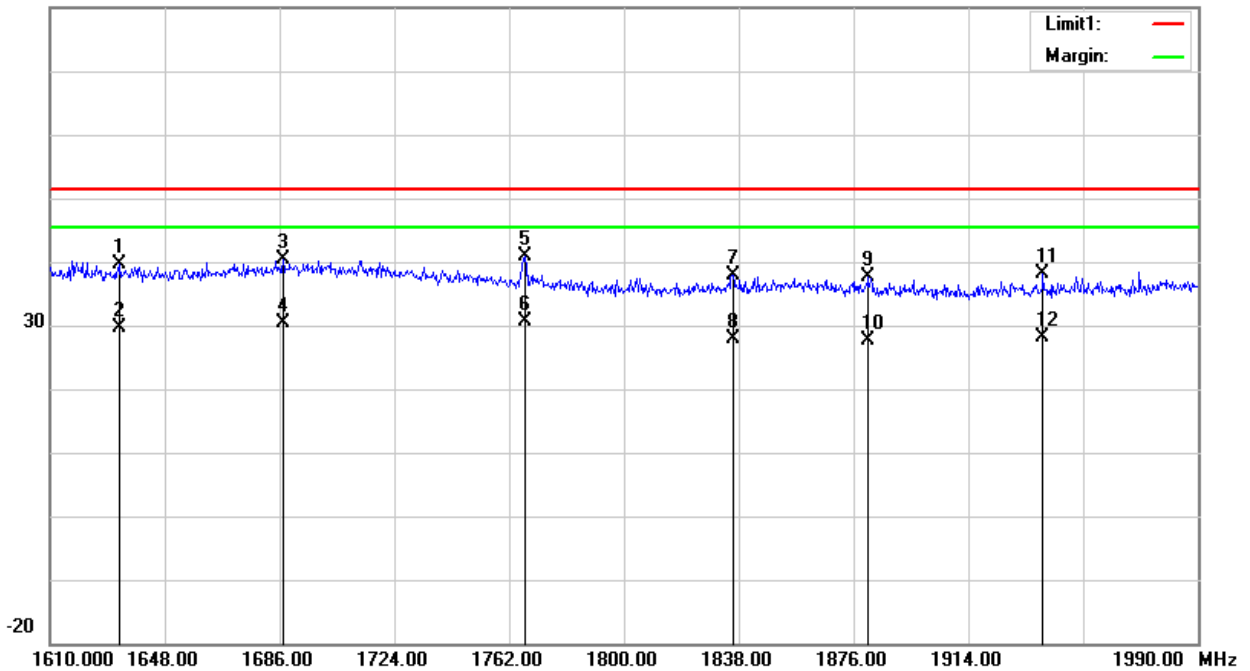



Temperature:	23.1(C)	Relative Humidity:	60%RH
Test Voltage:	AC 120V/60Hz	Phase:	Horizontal
Test Mode:	CH 1(1990MHz – 3100MHz)	Test distance:	1m

No.	Frequency (MHz)	Reading (dBuV)	Correct Factor(dB/m)	Result (dBuV/m)	Limit (dBuV/m)	Margin (dB)	Remark
1	2169.820	35.56	3.15	38.71	53.44	-14.73	peak
2	2169.820	25.63	3.15	28.78	53.44	-24.66	RMS
3	2405.140	34.65	4.50	39.15	53.44	-14.29	peak
4	2405.140	24.68	4.50	29.18	53.44	-24.26	RMS
5	2566.090	34.99	5.00	39.99	53.44	-13.45	peak
6	2566.090	24.91	5.00	29.91	53.44	-23.53	RMS
7	2725.930	34.09	5.85	39.94	53.44	-13.50	peak
8	2725.930	24.11	5.85	29.96	53.44	-23.48	RMS
9	2819.170	35.05	6.35	41.40	53.44	-12.04	peak
10	2819.170	25.12	6.35	31.47	53.44	-21.97	RMS
11	3013.420	14.47	28.21	42.68	53.44	-10.76	peak
12	3013.420	4.48	28.21	32.69	53.44	-20.75	RMS

Remark:

- Margin = Result (Result =Reading + Factor)-Limit
- Factor= Antenna factor+Cable attenuation factor(cable loss)-Amplifier gain

80.0 dBuV/m

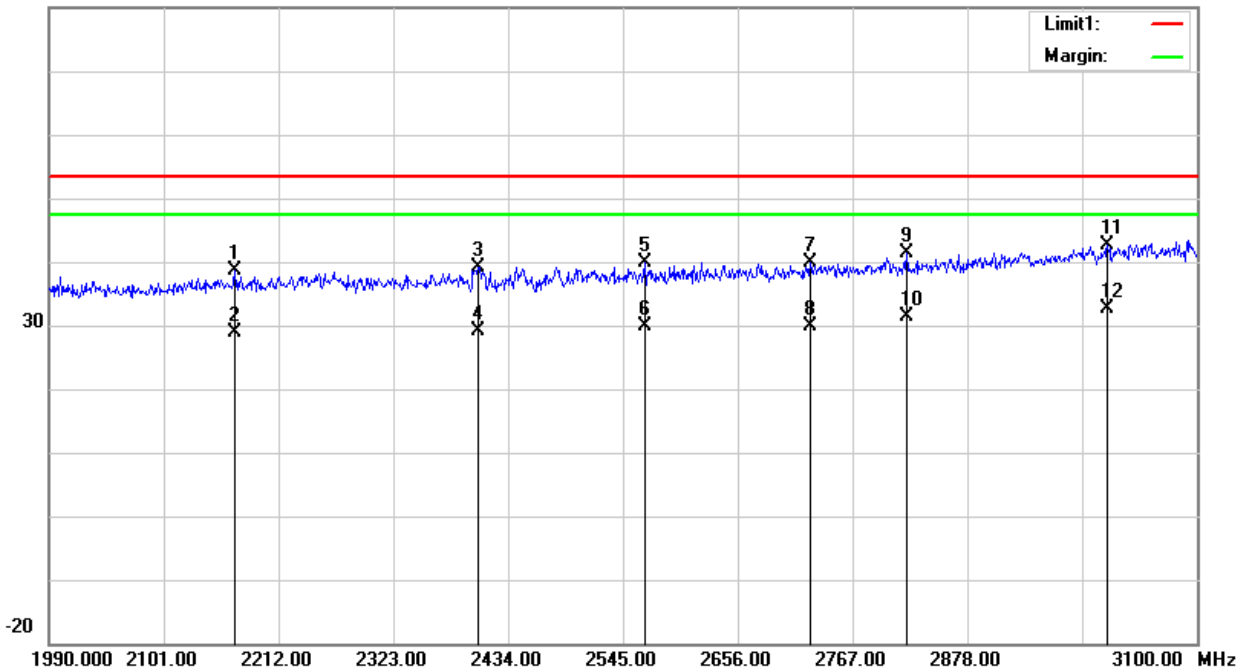



Temperature:	23.1(C)	Relative Humidity:	60%RH
Test Voltage:	AC 120V/60Hz	Phase:	Vertical
Test Mode:	CH 1(1990MHz – 3100MHz)	Test distance:	1m

No.	Frequency (MHz)	Reading (dBuV)	Correct Factor(dB/m)	Result (dBuV/m)	Limit (dBuV/m)	Margin (dB)	Remark
1	2157.610	35.83	3.24	39.07	53.44	-14.37	peak
2	2157.610	25.80	3.24	29.04	53.44	-24.40	RMS
3	2406.250	36.22	4.49	40.71	53.44	-12.73	peak
4	2406.250	26.29	4.49	30.78	53.44	-22.66	RMS
5	2629.360	35.31	5.34	40.65	53.44	-12.79	peak
6	2629.360	26.34	5.34	31.68	53.44	-21.76	RMS
7	2757.010	35.29	6.09	41.38	53.44	-12.06	peak
8	2757.010	25.30	6.09	31.39	53.44	-22.05	RMS
9	2907.970	35.31	6.76	42.07	53.44	-11.37	peak
10	2907.970	25.30	6.76	32.06	53.44	-21.38	RMS
11	3011.200	13.72	28.21	41.93	53.44	-11.51	peak
12	3011.200	3.71	28.21	31.92	53.44	-21.52	RMS

Remark:

- Margin = Result (Result =Reading + Factor)-Limit
- Factor= Antenna factor+Cable attenuation factor(cable loss)-Amplifier gain

80.0 dBuV/m

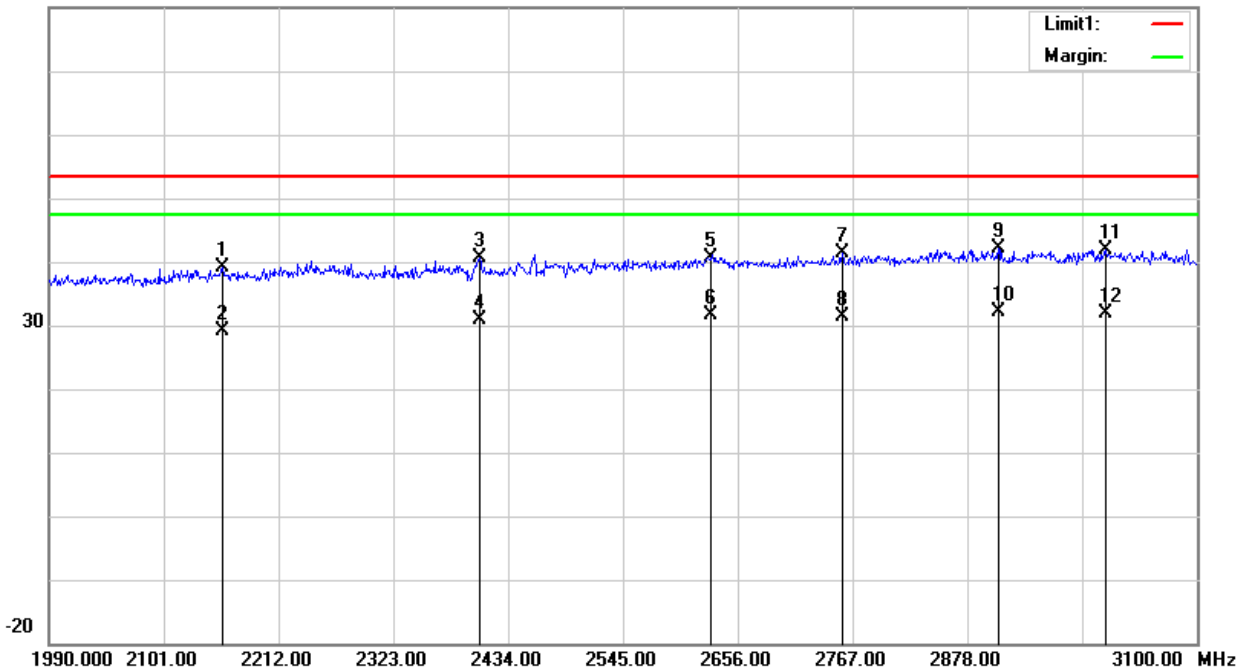



Temperature:	23.1(C)	Relative Humidity:	60%RH
Test Voltage:	AC 120V/60Hz	Phase:	Horizontal
Test Mode:	CH 1 (3100MHz – 10600MHz)	Test distance:	1m

No.	Frequency (MHz)	Reading (dBuV)	Correct Factor(dB/m)	Result (dBuV/m)	Limit (dBuV/m)	Margin (dB)	Remark
1	4825.000	50.64	-7.13	43.51	63.44	-19.93	peak
2	4825.000	41.64	-7.13	34.51	63.44	-28.93	RMS
3	5335.000	50.49	-5.22	45.27	63.44	-18.17	peak
4	5335.000	41.49	-5.22	36.27	63.44	-27.17	RMS
5	6422.500	59.07	-2.17	56.90	63.44	-6.54	peak
6	6422.500	50.07	-2.17	47.90	63.44	-15.54	RMS
7	7690.000	51.75	1.83	53.58	63.44	-9.86	peak
8	7690.000	42.75	1.83	44.58	63.44	-18.86	RMS
9	8410.000	51.85	2.62	54.47	63.44	-8.97	peak
10	8410.000	42.85	2.62	45.47	63.44	-17.97	RMS
11	10090.000	51.68	3.65	55.33	63.44	-8.11	peak
12	10090.000	42.68	3.65	46.33	63.44	-17.11	RMS

Remark:

- Margin = Result (Result = Reading + Factor) - Limit
- Factor = Antenna factor + Cable attenuation factor (cable loss) - Amplifier gain

100.0 dBuV/m

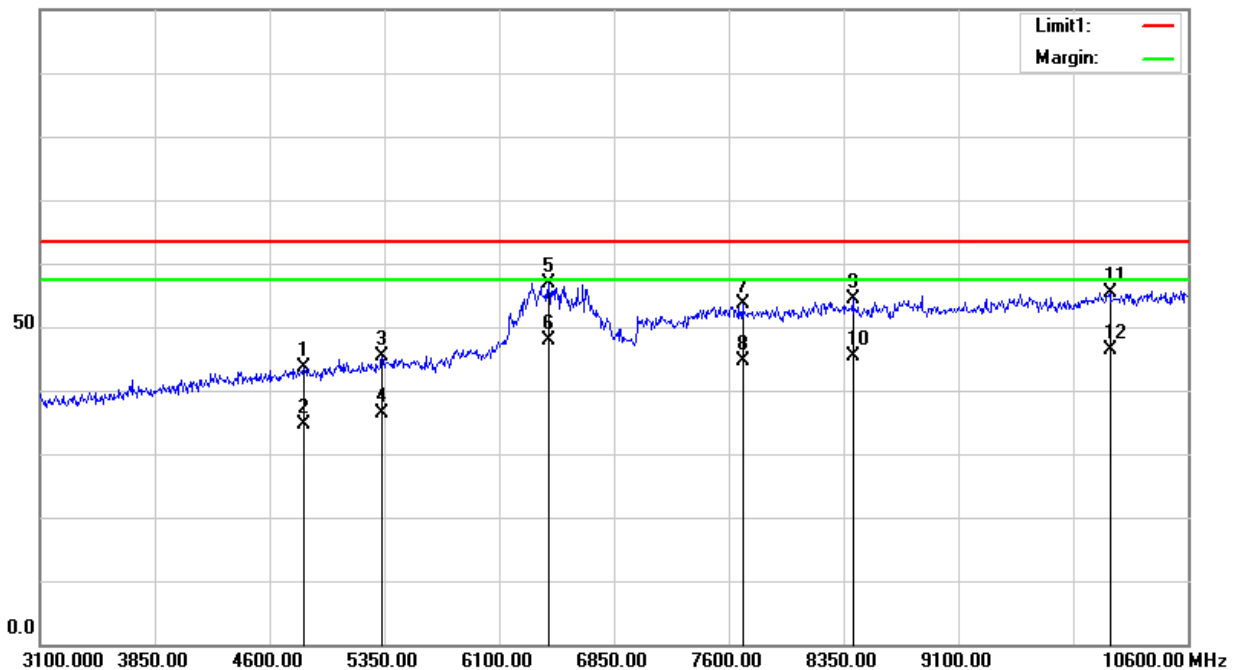



Temperature:	23.1(C)	Relative Humidity:	60%RH
Test Voltage:	AC 120V/60Hz	Phase:	Vertical
Test Mode:	CH 1 (3100MHz – 10600MHz)	Test distance:	1m

No.	Frequency (MHz)	Reading (dBuV)	Correct Factor(dB/m)	Result (dBuV/m)	Limit (dBuV/m)	Margin (dB)	Remark
1	4787.500	51.41	-7.23	44.18	63.44	-19.26	peak
2	4787.500	42.41	-7.23	35.18	63.44	-28.26	RMS
3	5447.500	50.47	-5.14	45.33	63.44	-18.11	peak
4	5447.500	41.47	-5.14	36.33	63.44	-27.11	RMS
5	6512.500	59.17	-1.92	57.25	63.44	-6.19	peak
6	6512.500	50.17	-1.92	48.25	63.44	-15.19	RMS
7	7577.500	52.23	1.72	53.95	63.44	-9.49	peak
8	7577.500	43.23	1.72	44.95	63.44	-18.49	RMS
9	8365.000	52.98	2.58	55.56	63.44	-7.88	peak
10	8365.000	43.98	2.58	46.56	63.44	-16.88	RMS
11	10015.000	52.77	3.41	56.18	63.44	-7.26	peak
12	10015.000	43.77	3.41	47.18	63.44	-16.26	RMS

Remark:

- Margin = Result (Result =Reading + Factor)-Limit
- Factor= Antenna factor+Cable attenuation factor(cable loss)-Amplifier gain

100.0 dBuV/m

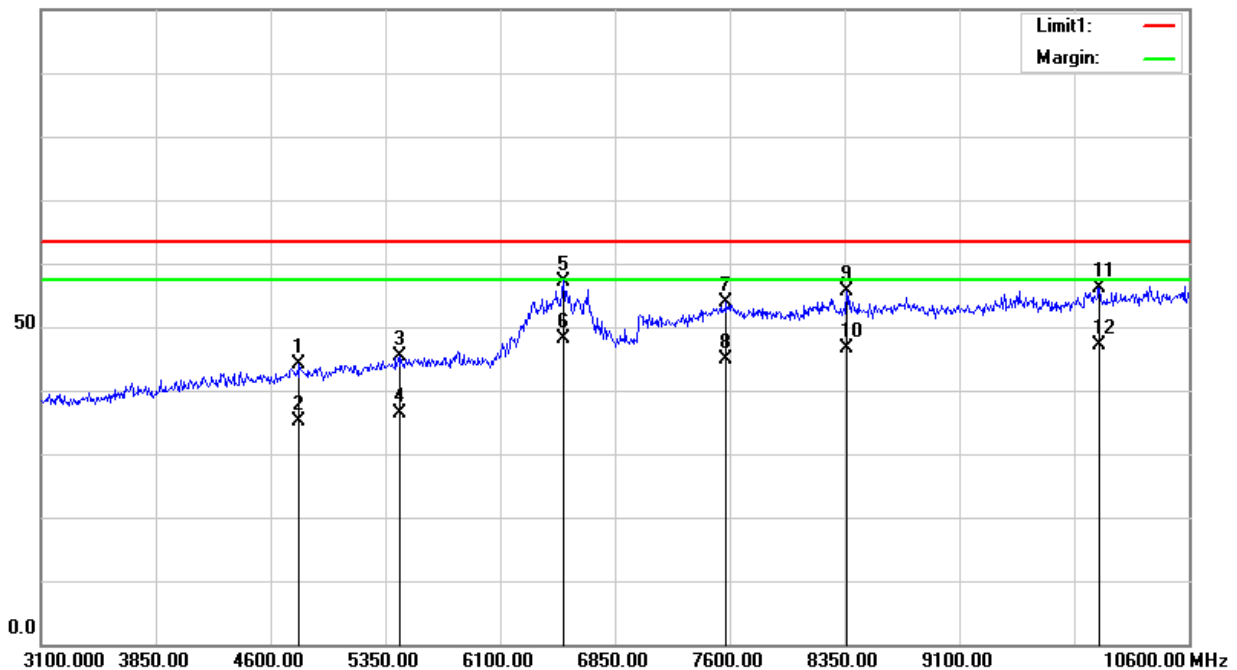



Temperature:	23.1(C)	Relative Humidity:	60%RH
Test Voltage:	AC 120V/60Hz	Phase:	Horizontal
Test Mode:	CH 1 (10600MHz – 18000MHz)	Test distance:	1m

No.	Frequency (MHz)	Reading (dBuV)	Correct Factor(dB/m)	Result (dBuV/m)	Limit (dBuV/m)	Margin (dB)	Remark
1	11192.000	37.91	6.34	44.25	53.44	-9.19	peak
2	11192.000	26.02	6.34	32.36	53.44	-21.08	RMS
3	13774.600	36.68	11.09	47.77	53.44	-5.67	peak
4	13774.600	24.80	11.09	35.89	53.44	-17.55	RMS
5	14544.200	37.71	11.29	49.00	53.44	-4.44	peak
6	14544.200	25.70	11.29	36.99	53.44	-16.45	RMS
7	15558.000	38.84	9.36	48.20	53.44	-5.24	peak
8	15558.000	27.31	9.36	36.67	53.44	-16.77	RMS
9	16890.000	39.29	9.70	48.99	53.44	-4.45	peak
10	16890.000	26.53	9.70	36.23	53.44	-17.21	RMS
11	17948.200	39.00	11.91	50.91	53.44	-2.53	peak
12	17948.200	26.71	11.91	38.62	53.44	-14.82	RMS

Remark:

- Margin = Result (Result =Reading + Factor)-Limit
- Factor= Antenna factor+Cable attenuation factor(cable loss)-Amplifier gain

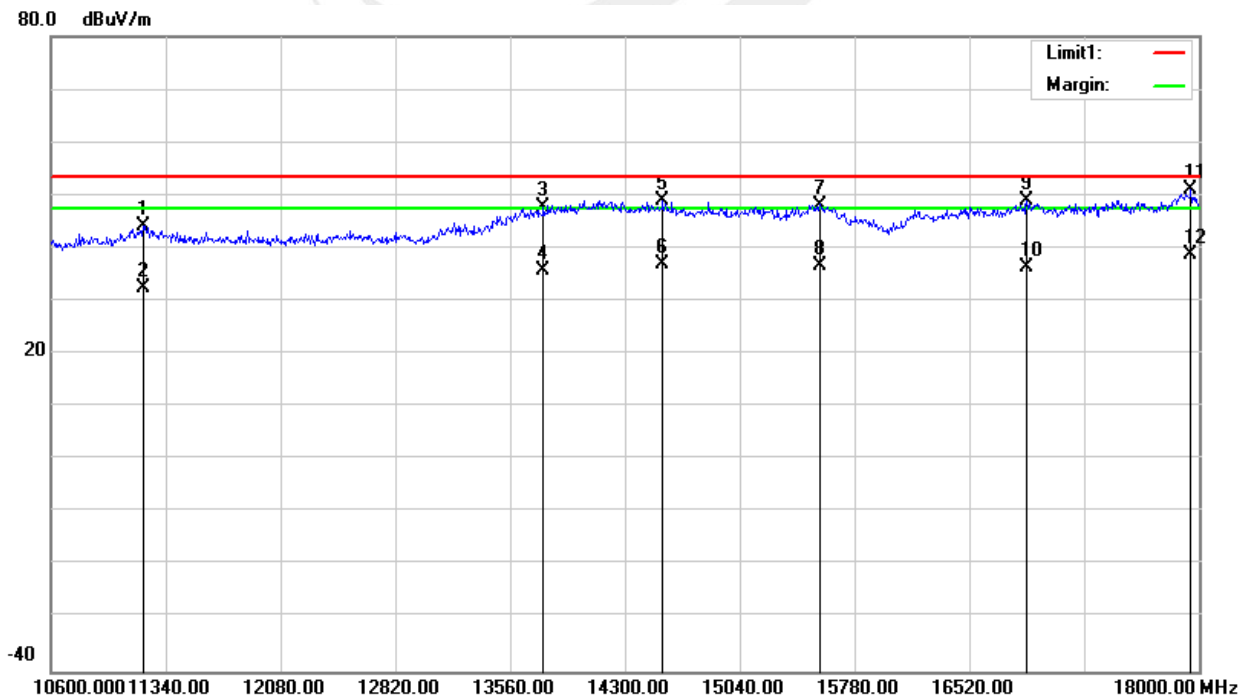



Temperature:	23.1(C)	Relative Humidity:	60%RH
Test Voltage:	AC 120V/60Hz	Phase:	Vertical
Test Mode:	CH 1 (10600MHz – 18000MHz)	Test distance:	1m

No.	Frequency (MHz)	Reading (dBuV)	Correct Factor(dB/m)	Result (dBuV/m)	Limit (dBuV/m)	Margin (dB)	Remark
1	11251.200	38.12	6.35	44.47	53.44	-8.97	peak
2	11251.200	26.27	6.35	32.62	53.44	-20.82	RMS
3	13204.800	36.17	7.81	43.98	53.44	-9.46	peak
4	13204.800	24.31	7.81	32.12	53.44	-21.32	RMS
5	14411.000	37.68	11.58	49.26	53.44	-4.18	peak
6	14411.000	25.08	11.58	36.66	53.44	-16.78	RMS
7	15587.600	40.98	9.18	50.16	53.44	-3.28	peak
8	15587.600	30.38	9.18	39.56	53.44	-13.88	RMS
9	16949.200	39.04	9.76	48.80	53.44	-4.64	peak
10	16949.200	26.56	9.76	36.32	53.44	-17.12	RMS
11	17940.800	38.48	11.89	50.37	53.44	-3.07	peak
12	17940.800	27.77	11.89	39.66	53.44	-13.78	RMS

Remark:

- Margin = Result (Result =Reading + Factor)-Limit
- Factor= Antenna factor+Cable attenuation factor(cable loss)-Amplifier gain

80.0 dBuV/m

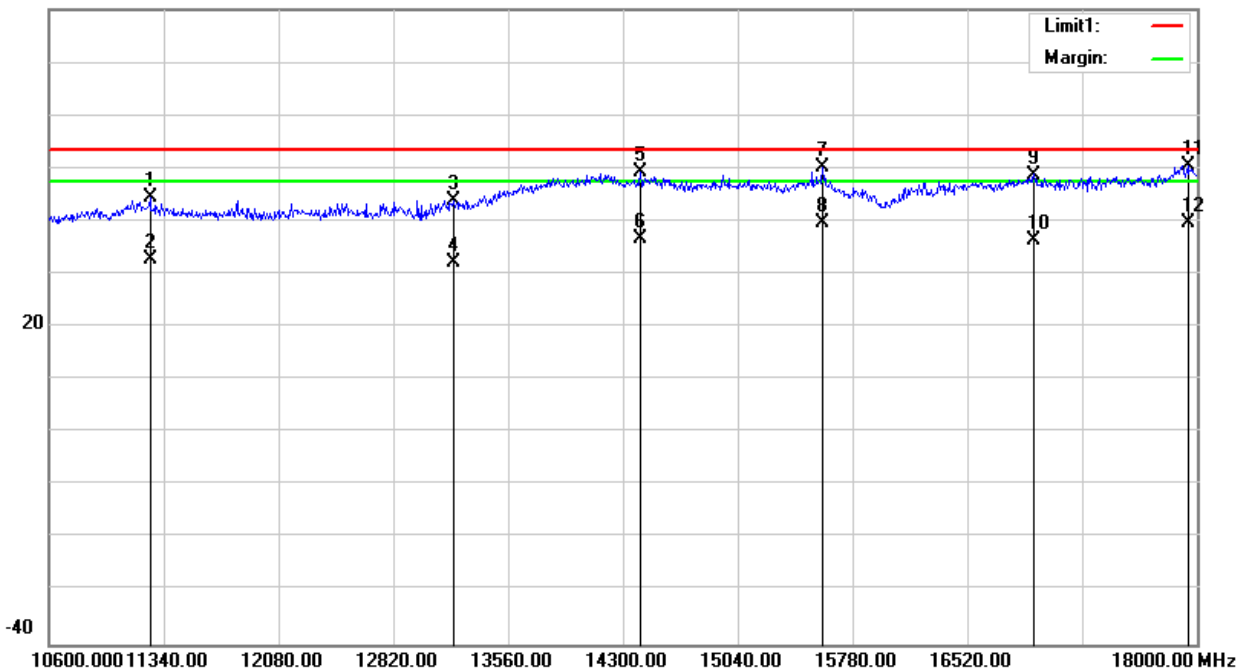



Temperature:	23.1(C)	Relative Humidity:	60%RH
Test Voltage:	AC 120V/60Hz	Phase:	Horizontal
Test Mode:	CH 1 (18000MHz – 40000MHz)	Test distance:	1m

No.	Frequency (MHz)	Reading (dBuV)	Correct Factor(dB/m)	Result (dBuV/m)	Limit (dBuV/m)	Margin (dB)	Remark
1	22004.000	38.51	2.85	41.36	53.44	-12.08	peak
2	22004.000	27.38	2.85	30.23	53.44	-23.21	RMS
3	25216.000	37.28	3.21	40.49	53.44	-12.95	peak
4	25216.000	25.05	3.21	28.26	53.44	-25.18	RMS
5	30188.000	38.40	3.05	41.45	53.44	-11.99	peak
6	30188.000	27.51	3.05	30.56	53.44	-22.88	RMS
7	34742.000	39.29	3.43	42.72	53.44	-10.72	peak
8	34742.000	27.63	3.43	31.06	53.44	-22.38	RMS
9	37338.000	41.05	3.33	44.38	53.44	-9.06	peak
10	37338.000	28.89	3.33	32.22	53.44	-21.22	RMS
11	38504.000	43.55	2.67	46.22	53.44	-7.22	peak
12	38504.000	31.89	2.67	34.56	53.44	-18.88	RMS

Remark:

- Margin = Result (Result =Reading + Factor)-Limit
- Factor= Antenna factor+Cable attenuation factor(cable loss)-Amplifier gain

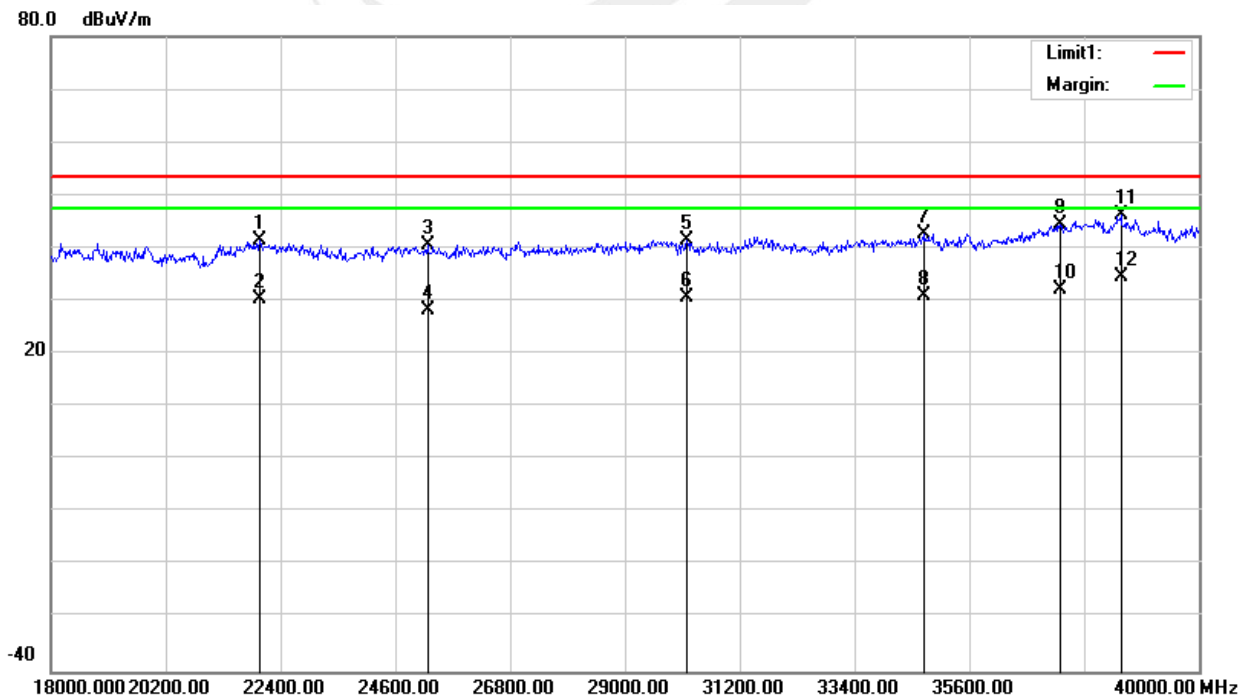



Temperature:	23.1(C)	Relative Humidity:	60%RH
Test Voltage:	AC 120V/60Hz	Phase:	Vertical
Test Mode:	CH 1 (18000MHz – 40000MHz)	Test distance:	1m

No.	Frequency (MHz)	Reading (dBuV)	Correct Factor(dB/m)	Result (dBuV/m)	Limit (dBuV/m)	Margin (dB)	Remark
1	18836.000	38.28	1.80	40.08	53.44	-13.36	peak
2	18836.000	27.43	1.80	29.23	53.44	-24.21	RMS
3	21806.000	38.76	2.64	41.40	53.44	-12.04	peak
4	21806.000	27.38	2.64	30.02	53.44	-23.42	RMS
5	25502.000	38.02	3.14	41.16	53.44	-12.28	peak
6	25502.000	26.97	3.14	30.11	53.44	-23.33	RMS
7	31508.000	38.95	3.07	42.02	53.44	-11.42	peak
8	31508.000	27.96	3.07	31.03	53.44	-22.41	RMS
9	34808.000	38.88	3.45	42.33	53.44	-11.11	peak
10	34808.000	27.76	3.45	31.21	53.44	-22.23	RMS
11	38438.000	42.92	2.78	45.70	53.44	-7.74	peak
12	38438.000	30.24	2.78	33.02	53.44	-20.42	RMS

Remark:

1. Margin = Result (Result = Reading + Factor) – Limit
2. Factor = Antenna factor + Cable attenuation factor (cable loss) – Amplifier gain

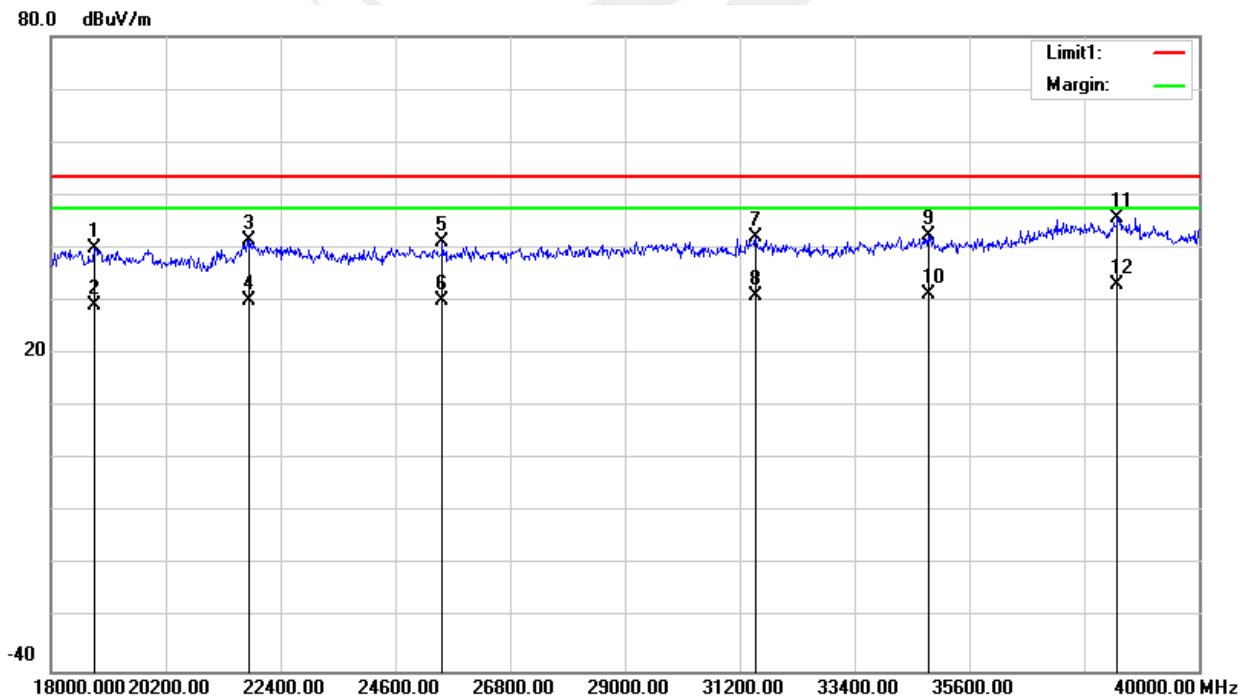



IC:

Temperature:	23.1(C)	Relative Humidity:	60%RH
Test Voltage:	AC 120V/60Hz	Phase:	Horizontal
Test Mode:	CH 1(960MHz -1610MHz)	Test distance:	1m

No.	Frequency (MHz)	Reading (dBuV)	Correct Factor(dB/m)	Result (dBuV/m)	Limit (dBuV/m)	Margin (dB)	Remark
1	1078.950	26.82	-1.20	25.62	29.44	-3.82	peak
2	1078.950	17.86	-1.20	16.66	29.44	-12.78	RMS
3	1164.100	26.47	-0.77	25.70	29.44	-3.74	peak
4	1164.100	17.47	-0.77	16.70	29.44	-12.74	RMS
5	1277.200	25.99	-0.30	25.69	29.44	-3.75	peak
6	1277.200	16.99	-0.30	16.69	29.44	-12.75	RMS
7	1376.650	26.38	0.17	26.55	29.44	-2.89	peak
8	1376.650	17.35	0.17	17.52	29.44	-11.92	RMS
9	1469.600	25.24	1.12	26.36	29.44	-3.08	peak
10	1469.600	16.26	1.12	17.38	29.44	-12.06	RMS
11	1582.700	22.46	3.70	26.16	29.44	-3.28	peak
12	1582.700	13.43	3.70	17.13	29.44	-12.31	RMS

Remark:

- Margin = Result (Result =Reading + Factor)-Limit
- Factor= Antenna factor+Cable attenuation factor(cable loss)-Amplifier gain

80.0 dBuV/m

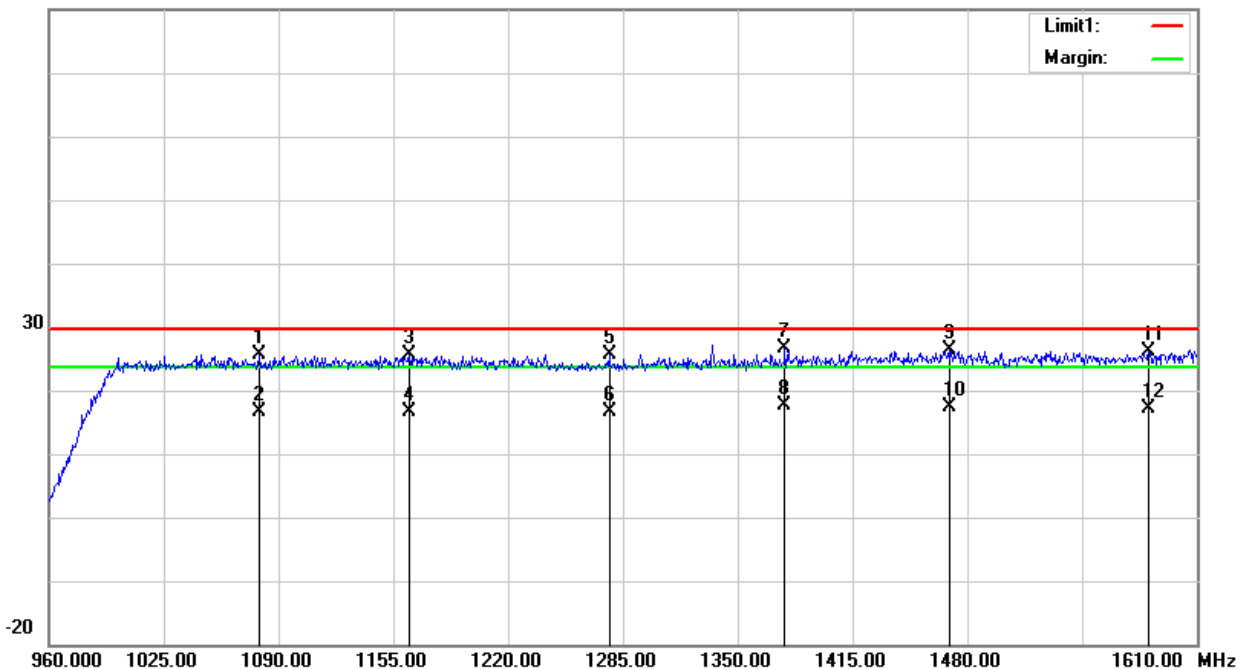



Temperature:	23.1(C)	Relative Humidity:	60%RH
Test Voltage:	AC 120V/60Hz	Phase:	Vertical
Test Mode:	CH 1(960MHz -1610MHz)	Test distance:	1m

No.	Frequency (MHz)	Reading (dBuV)	Correct Factor(dB/m)	Result (dBuV/m)	Limit (dBuV/m)	Margin (dB)	Remark
1	1065.950	23.43	-1.27	22.16	29.44	-7.28	peak
2	1065.950	14.40	-1.27	13.13	29.44	-16.31	RMS
3	1200.500	22.97	-0.42	22.55	29.44	-6.89	peak
4	1200.500	13.94	-0.42	13.52	29.44	-15.92	RMS
5	1329.200	22.61	-0.02	22.59	29.44	-6.85	peak
6	1329.200	13.56	-0.02	13.54	29.44	-15.90	RMS
7	1416.950	22.92	0.48	23.40	29.44	-6.04	peak
8	1416.950	13.99	0.48	14.47	29.44	-14.97	RMS
9	1468.950	22.92	1.11	24.03	29.44	-5.41	peak
10	1468.950	13.95	1.11	15.06	29.44	-14.38	RMS
11	1567.100	22.18	3.20	25.38	29.44	-4.06	peak
12	1567.100	13.13	3.20	16.33	29.44	-13.11	RMS

Remark:

- Margin = Result (Result =Reading + Factor)-Limit
- Factor= Antenna factor+Cable attenuation factor(cable loss)-Amplifier gain

80.0 dBuV/m

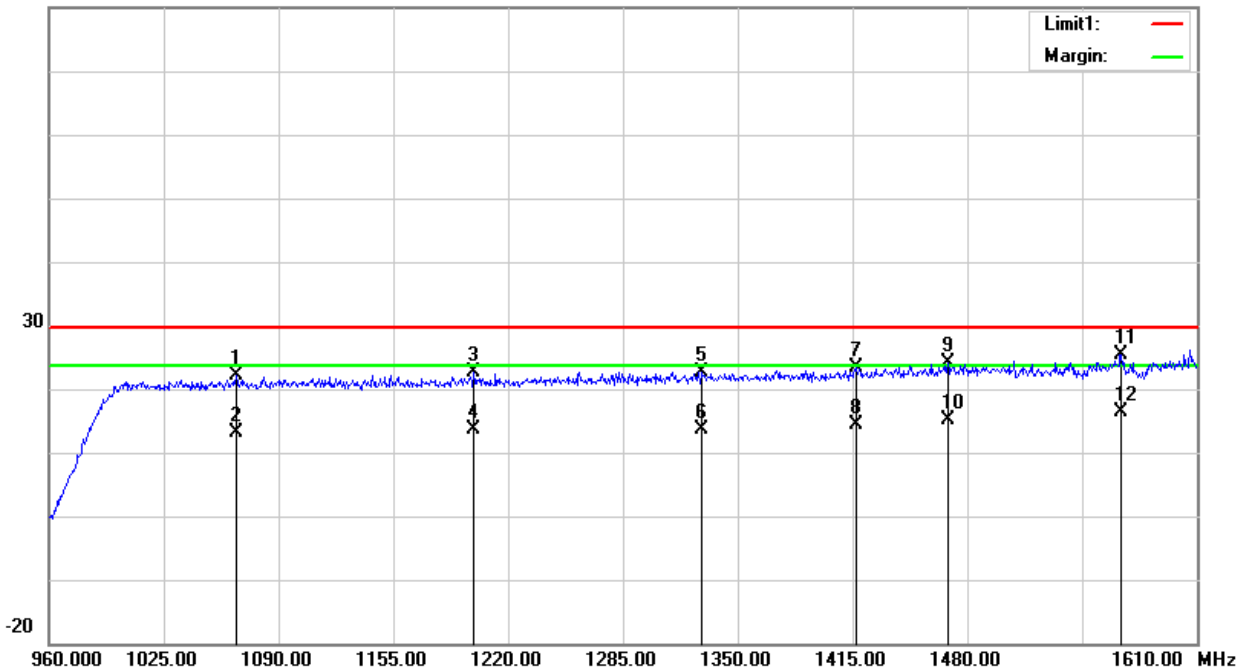



Temperature:	23.1(C)	Relative Humidity:	60%RH
Test Voltage:	AC 120V/60Hz	Phase:	Horizontal
Test Mode:	CH 1(1610MHz – 4750MHz)	Test distance:	1m

No.	Frequency (MHz)	Reading (dBuV)	Correct Factor(dB/m)	Result (dBuV/m)	Limit (dBuV/m)	Margin (dB)	Remark
1	2153.220	18.21	3.27	21.48	34.74	-13.26	peak
2	2153.220	8.22	3.27	11.49	34.74	-23.25	RMS
3	2916.240	17.71	6.80	24.51	34.74	-10.23	peak
4	2916.240	7.72	6.80	14.52	34.74	-20.22	RMS
5	3399.800	-3.21	28.44	25.23	34.74	-9.51	peak
6	3399.800	-13.20	28.44	15.24	34.74	-19.50	RMS
7	3946.160	-3.89	29.57	25.68	34.74	-9.06	peak
8	3946.160	-13.88	29.57	15.69	34.74	-19.05	RMS
9	4288.420	-5.53	30.22	24.69	34.74	-10.05	peak
10	4288.420	-15.52	30.22	14.70	34.74	-20.04	RMS
11	4593.000	-4.41	30.79	26.38	34.74	-8.36	peak
12	4593.000	-14.40	30.79	16.39	34.74	-18.35	RMS

Remark:

- Margin = Result (Result =Reading + Factor)–Limit
- Factor= Antenna factor+Cable attenuation factor(cable loss)-Amplifier gain

80.0 dBuV/m

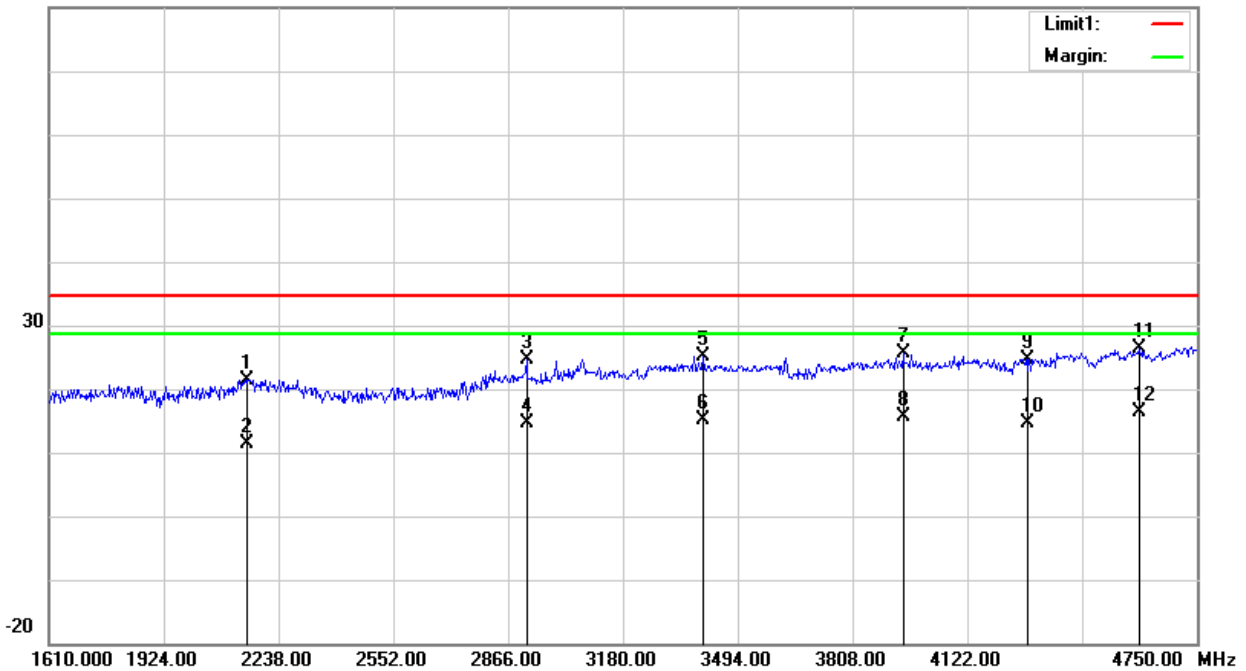



Temperature:	23.1(C)	Relative Humidity:	60%RH
Test Voltage:	AC 120V/60Hz	Phase:	Vertical
Test Mode:	CH 1(1610MHz – 4750MHz)	Test distance:	1m

No.	Frequency (MHz)	Reading (dBuV)	Correct Factor(dB/m)	Result (dBuV/m)	Limit (dBuV/m)	Margin (dB)	Remark
1	2121.820	15.68	2.80	18.48	34.74	-16.26	peak
2	2121.820	5.69	2.80	8.49	34.74	-26.25	RMS
3	2831.460	14.43	6.44	20.87	34.74	-13.87	peak
4	2831.460	5.44	6.44	11.88	34.74	-22.86	RMS
5	3082.660	-6.80	28.25	21.45	34.74	-13.29	peak
6	3082.660	-16.79	28.25	11.46	34.74	-23.28	RMS
7	3760.900	-5.20	29.13	23.93	34.74	-10.81	peak
8	3760.900	-15.18	29.13	13.95	34.74	-20.79	RMS
9	4332.380	-4.59	30.30	25.71	34.74	-9.03	peak
10	4332.380	-14.57	30.30	15.73	34.74	-19.01	RMS
11	4586.720	-6.44	30.77	24.33	34.74	-10.41	peak
12	4586.720	-16.42	30.77	14.35	34.74	-20.39	RMS

Remark:

1. Margin = Result (Result =Reading + Factor)-Limit
2. Factor= Antenna factor+Cable attenuation factor(cable loss)-Amplifier gain

80.0 dBuV/m

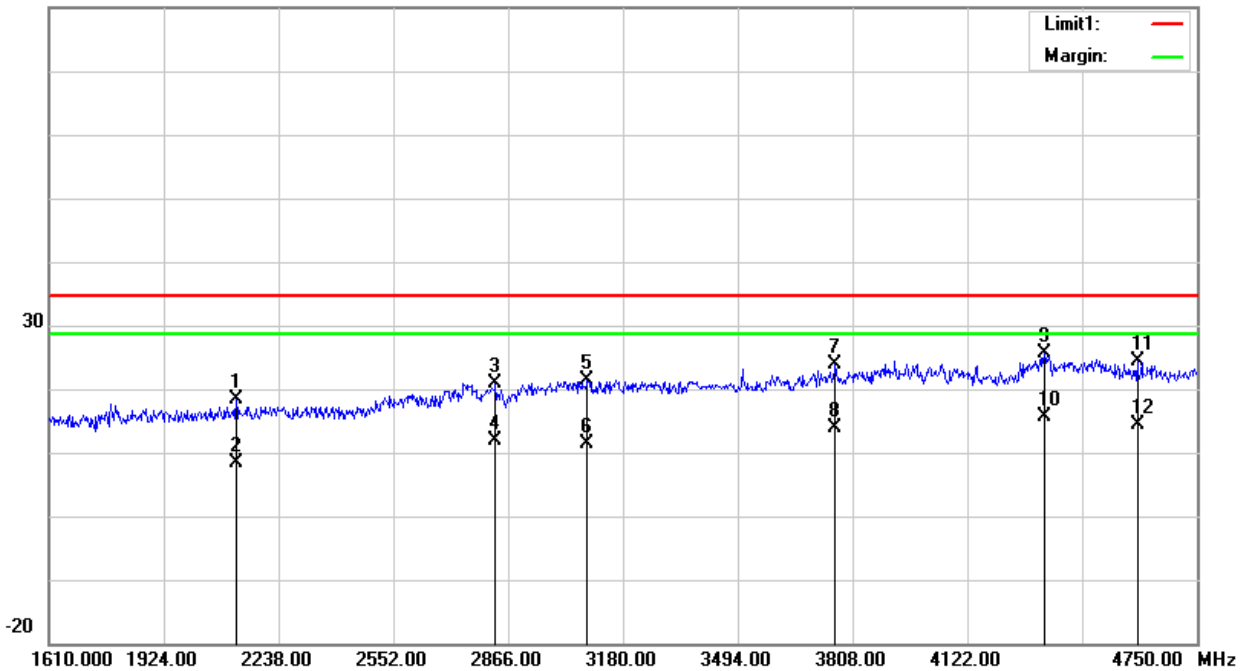



Temperature:	23.1(C)	Relative Humidity:	60%RH
Test Voltage:	AC 120V/60Hz	Phase:	Horizontal
Test Mode:	CH 1 (4750MHz – 10600MHz)	Test distance:	1m

No.	Frequency (MHz)	Reading (dBuV)	Correct Factor(dB/m)	Result (dBuV/m)	Limit (dBuV/m)	Margin (dB)	Remark
1	5329.150	50.68	-5.22	45.46	63.44	-17.98	peak
2	5329.150	41.68	-5.22	36.46	63.44	-26.98	RMS
3	6311.950	56.04	-2.41	53.63	63.44	-9.81	peak
4	6311.950	47.04	-2.41	44.63	63.44	-18.81	RMS
5	7534.600	51.24	1.67	52.91	63.44	-10.53	peak
6	7534.600	42.24	1.67	43.91	63.44	-19.53	RMS
7	8260.000	51.52	2.45	53.97	63.44	-9.47	peak
8	8260.000	42.52	2.45	44.97	63.44	-18.47	RMS
9	9277.900	51.82	2.83	54.65	63.44	-8.79	peak
10	9277.900	42.82	2.83	45.65	63.44	-17.79	RMS
11	10383.550	50.27	4.60	54.87	63.44	-8.57	peak
12	10383.550	41.27	4.60	45.87	63.44	-17.57	RMS

Remark:

- Margin = Result (Result =Reading + Factor)-Limit
- Factor= Antenna factor+Cable attenuation factor(cable loss)-Amplifier gain

100.0 dBuV/m

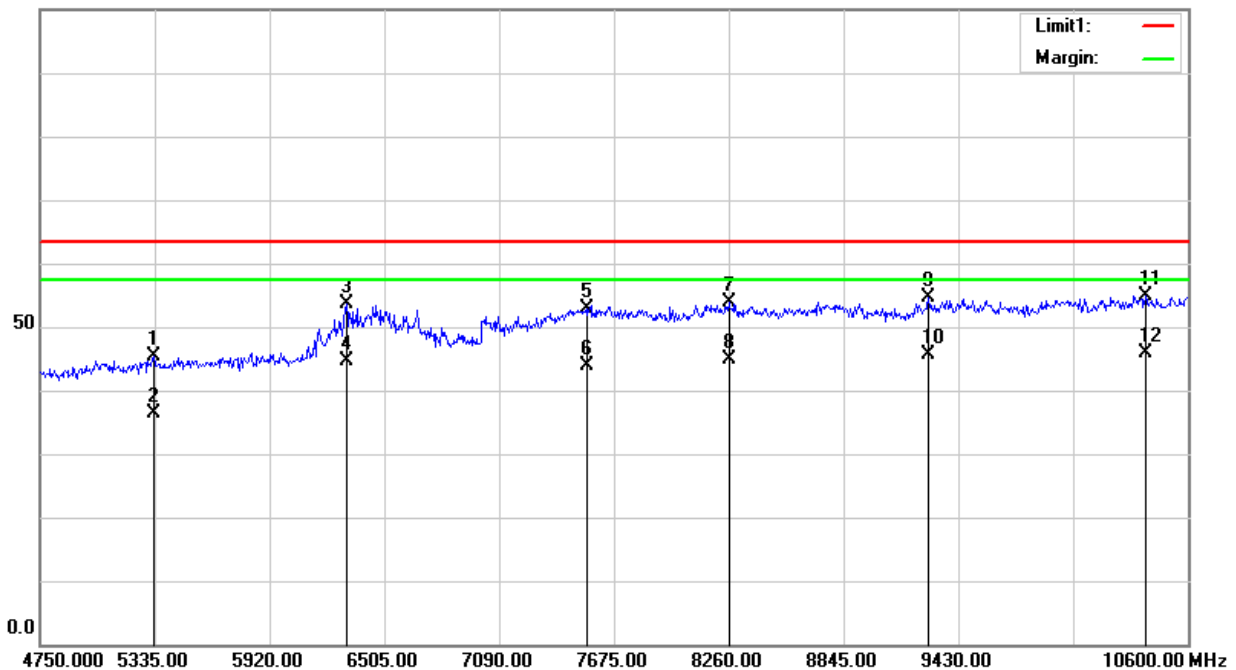



Temperature:	23.1(C)	Relative Humidity:	60%RH
Test Voltage:	AC 120V/60Hz	Phase:	Vertical
Test Mode:	CH 1 (4750MHz – 10600MHz)	Test distance:	1m

No.	Frequency (MHz)	Reading (dBuV)	Correct Factor(dB/m)	Result (dBuV/m)	Limit (dBuV/m)	Margin (dB)	Remark
1	5691.850	49.98	-4.66	45.32	63.44	-18.12	peak
2	5691.850	40.98	-4.66	36.32	63.44	-27.12	RMS
3	6452.350	58.54	-2.08	56.46	63.44	-6.98	peak
4	6452.350	49.54	-2.08	47.46	63.44	-15.98	RMS
5	7505.350	51.39	1.64	53.03	63.44	-10.41	peak
6	7505.350	42.39	1.64	44.03	63.44	-19.41	RMS
7	8634.400	51.17	2.65	53.82	63.44	-9.62	peak
8	8634.400	42.17	2.65	44.82	63.44	-18.62	RMS
9	9353.950	51.56	2.94	54.50	63.44	-8.94	peak
10	9353.950	42.56	2.94	45.50	63.44	-17.94	RMS
11	10330.900	50.43	4.42	54.85	63.44	-8.59	peak
12	10330.900	41.43	4.42	45.85	63.44	-17.59	RMS

Remark:

- Margin = Result (Result =Reading + Factor)-Limit
- Factor= Antenna factor+Cable attenuation factor(cable loss)-Amplifier gain

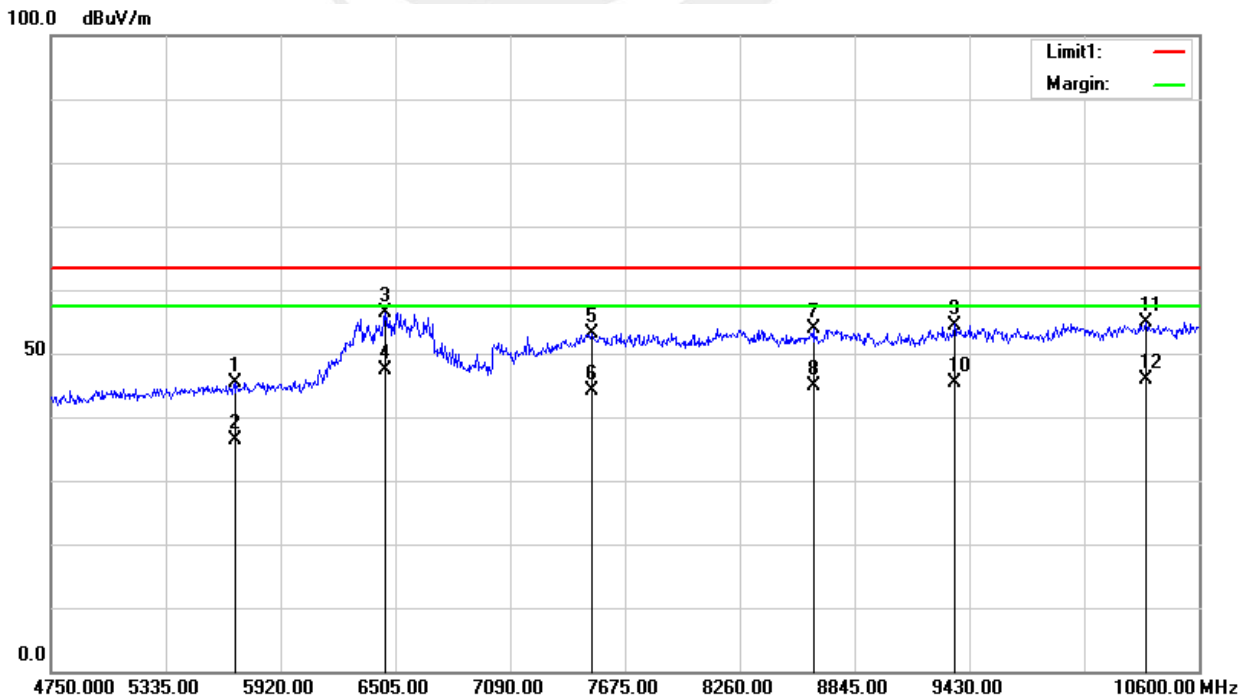



Temperature:	23.1(C)	Relative Humidity:	60%RH
Test Voltage:	AC 120V/60Hz	Phase:	Horizontal
Test Mode:	CH 1 (10600MHz – 18000MHz)	Test distance:	1m

No.	Frequency (MHz)	Reading (dBuV)	Correct Factor(dB/m)	Result (dBuV/m)	Limit (dBuV/m)	Margin (dB)	Remark
1	11236.400	37.27	6.35	43.62	53.44	-9.82	peak
2	11236.400	26.21	6.35	32.56	53.44	-20.88	RMS
3	12427.800	38.12	5.83	43.95	53.44	-9.49	peak
4	12427.800	27.05	5.83	32.88	53.44	-20.56	RMS
5	14152.000	37.13	12.04	49.17	53.44	-4.27	peak
6	14152.000	26.60	12.04	38.64	53.44	-14.80	RMS
7	15513.600	39.21	9.64	48.85	53.44	-4.59	peak
8	15513.600	26.68	9.64	36.32	53.44	-17.12	RMS
9	16964.000	39.10	9.78	48.88	53.44	-4.56	peak
10	16964.000	27.20	9.78	36.98	53.44	-16.46	RMS
11	17896.400	27.58	22.52	50.10	53.44	-3.34	peak
12	17896.400	16.17	22.52	38.69	53.44	-14.75	RMS

Remark:

- Margin = Result (Result =Reading + Factor)-Limit
- Factor= Antenna factor+Cable attenuation factor(cable loss)-Amplifier gain

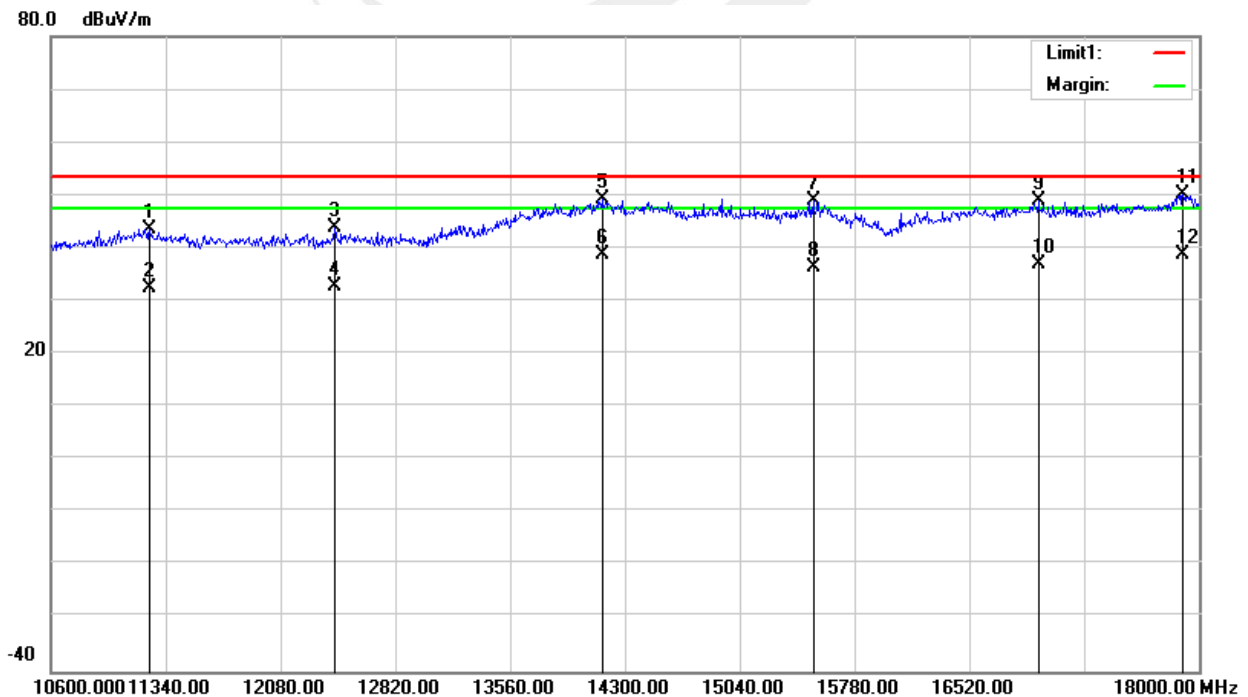



Temperature:	23.1(C)	Relative Humidity:	60%RH
Test Voltage:	AC 120V/60Hz	Phase:	Vertical
Test Mode:	CH 1 (10600MHz – 18000MHz)	Test distance:	1m

No.	Frequency (MHz)	Reading (dBuV)	Correct Factor(dB/m)	Result (dBuV/m)	Limit (dBuV/m)	Margin (dB)	Remark
1	11458.400	37.33	6.40	43.73	53.44	-9.71	peak
2	11458.400	25.93	6.40	32.33	53.44	-21.11	RMS
3	12524.000	37.03	5.87	42.90	53.44	-10.54	peak
4	12524.000	26.98	5.87	32.85	53.44	-20.59	RMS
5	13863.400	36.60	11.57	48.17	53.44	-5.27	peak
6	13863.400	25.99	11.57	37.56	53.44	-15.88	RMS
7	14951.200	38.04	10.19	48.23	53.44	-5.21	peak
8	14951.200	27.02	10.19	37.21	53.44	-16.23	RMS
9	16564.400	38.46	9.35	47.81	53.44	-5.63	peak
10	16564.400	27.21	9.35	36.56	53.44	-16.88	RMS
11	17859.400	38.65	11.66	50.31	53.44	-3.13	peak
12	17859.400	28.32	11.66	39.98	53.44	-13.46	RMS

Remark:

- Margin = Result (Result = Reading + Factor) – Limit
- Factor = Antenna factor + Cable attenuation factor (cable loss) – Amplifier gain

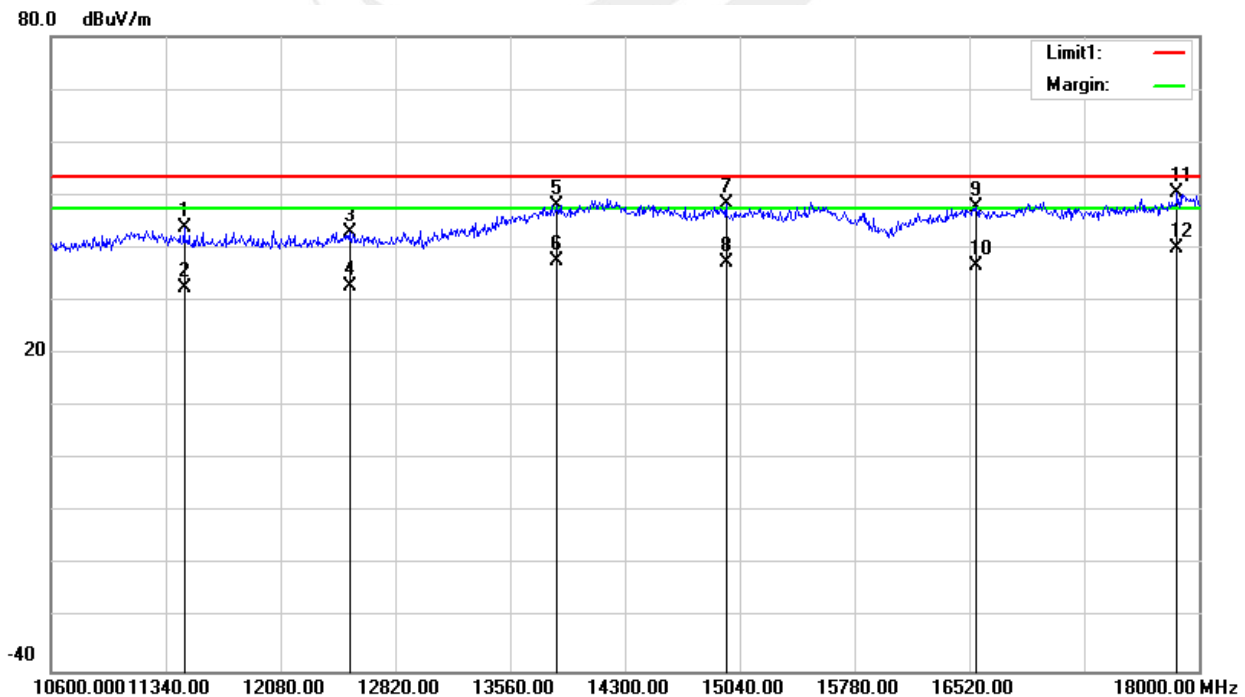



Temperature:	23.1(C)	Relative Humidity:	60%RH
Test Voltage:	AC 120V/60Hz	Phase:	Horizontal
Test Mode:	CH 1 (18000MHz – 40000MHz)	Test distance:	1m

No.	Frequency (MHz)	Reading (dBuV)	Correct Factor(dB/m)	Result (dBuV/m)	Limit (dBuV/m)	Margin (dB)	Remark
1	18440.000	37.90	1.75	39.65	53.44	-13.79	peak
2	18440.000	27.28	1.75	29.03	53.44	-24.41	RMS
3	21960.000	38.60	2.81	41.41	53.44	-12.03	peak
4	21960.000	28.21	2.81	31.02	53.44	-22.42	RMS
5	27548.000	37.79	2.73	40.52	53.44	-12.92	peak
6	27548.000	27.49	2.73	30.22	53.44	-23.22	RMS
7	34148.000	39.19	3.13	42.32	53.44	-11.12	peak
8	34148.000	29.10	3.13	32.23	53.44	-21.21	RMS
9	37668.000	40.87	3.42	44.29	53.44	-9.15	peak
10	37668.000	30.20	3.42	33.62	53.44	-19.82	RMS
11	38548.000	42.48	2.59	45.07	53.44	-8.37	peak
12	38548.000	31.73	2.59	34.32	53.44	-19.12	RMS

Remark:

- Margin = Result (Result =Reading + Factor)-Limit
- Factor= Antenna factor+Cable attenuation factor(cable loss)-Amplifier gain

80.0 dBuV/m

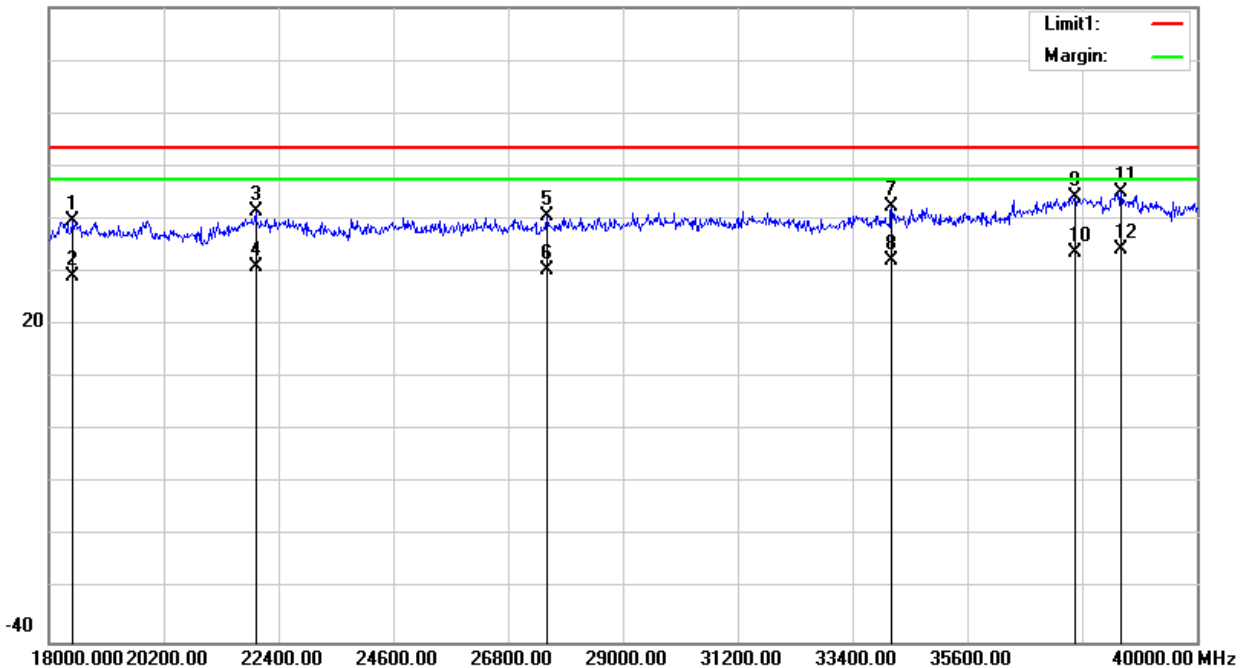



Temperature:	23.1(C)	Relative Humidity:	60%RH
Test Voltage:	AC 120V/60Hz	Phase:	Vertical
Test Mode:	CH 1 (18000MHz – 40000MHz)	Test distance:	1m

No.	Frequency (MHz)	Reading (dBuV)	Correct Factor(dB/m)	Result (dBuV/m)	Limit (dBuV/m)	Margin (dB)	Remark
1	18880.000	38.88	1.81	40.69	53.44	-12.75	peak
2	18880.000	28.42	1.81	30.23	53.44	-23.21	RMS
3	22158.000	39.63	2.82	42.45	53.44	-10.99	peak
4	22158.000	28.41	2.82	31.23	53.44	-22.21	RMS
5	26866.000	38.55	2.88	41.43	53.44	-12.01	peak
6	26866.000	28.10	2.88	30.98	53.44	-22.46	RMS
7	31530.000	38.52	3.08	41.60	53.44	-11.84	peak
8	31530.000	28.14	3.08	31.22	53.44	-22.22	RMS
9	36128.000	39.46	3.33	42.79	53.44	-10.65	peak
10	36128.000	28.56	3.33	31.89	53.44	-21.55	RMS
11	38504.000	43.54	2.67	46.21	53.44	-7.23	peak
12	38504.000	33.19	2.67	35.86	53.44	-17.58	RMS

Remark:

1. Margin = Result (Result = Reading + Factor) – Limit
2. Factor = Antenna factor + Cable attenuation factor (cable loss) – Amplifier gain

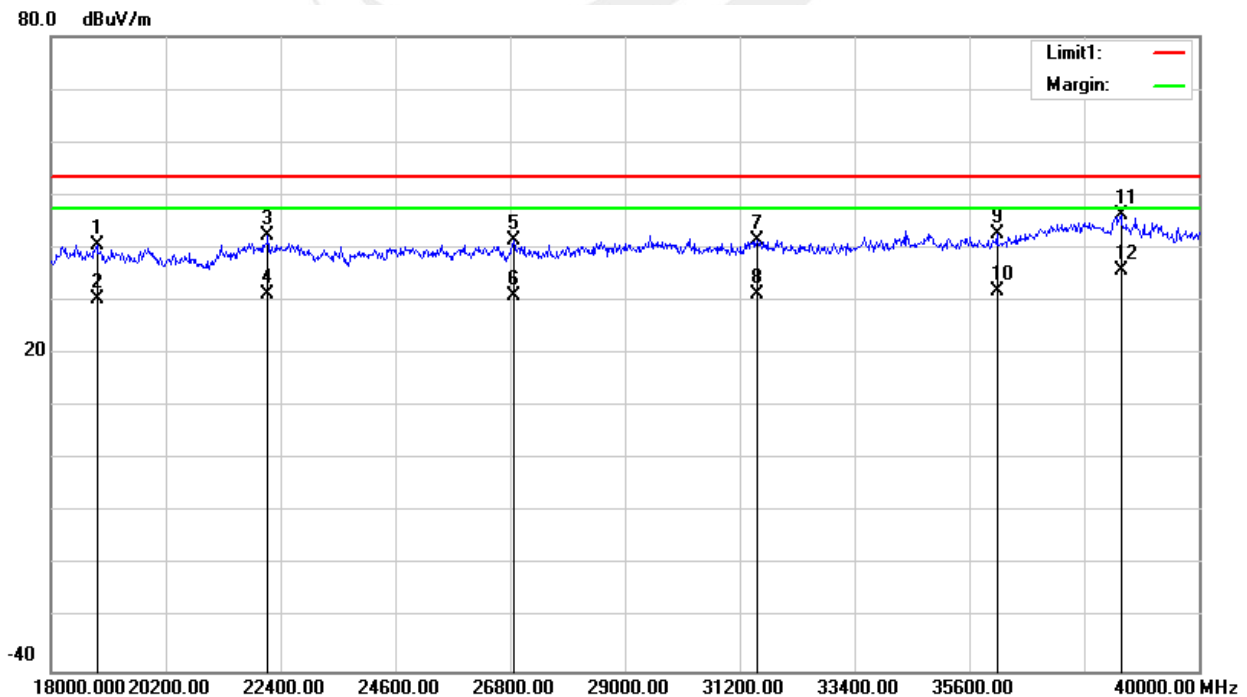



3.3 RADIATED EMISSION MEASUREMENT (FOR 15.517(d)&RSS 220 5.2.1(e))

3.3.1 RADIATED EMISSION LIMITS

Frequency of Emission (MHz)	EIRP (dBm)	Field Strength (dBuV/m@3m)	Field Strength (dBuV/m@1m)
1164~1240	-85.3	10	19.54
1559~1610	-85.3	10	19.54

Notes: 1. Transfer rules follow 15.521(g),15.31(f)(1).

2. 15.521(g) converted to a peak field strength level at 3 meters using $E(\text{dBuV/m}) = P(\text{dBmEIRP}) + 95.2$.

3. $\text{dBuV/m@1m} = \text{dBuV/m@3m} + 20 \cdot \log(3/1)$

UWB transmitters operating under the provisions of this section shall not exceed the following average limits when measured using a resolution bandwidth of no less than 1 kHz:

Frequency Range	RBW	VBW	Detector	Measurement Distance
1164~1240	1kHz	3kHz	RMS	1 Meter
1559~1610	1kHz	3kHz	RMS	1 Meter

3.3.2 TEST PROCEDURE

- a. The measuring distance of 1m shall be used for measurements. The EUT was placed on the top of rotating table 0.8 meter above the ground at a 3 meter semi-anechoic chamber. The table was rotated 360 degrees to determine the position of the highest radiation.
- b. The height of the test antenna shall vary between 1m to 4m. Both horizontal and vertical polarization of the antenna are set to make the measurement.
- c. All readings are RMS mode value, for each suspected emission, the EUT was arranged to its worst case and then the antenna was tuned to heights from 1 meter to 4 meters and the rotatable table was turned from 0 degrees to 360 degrees to find the maximum reading.
(Above 960MHz)
- d. For the actual test configuration, please refer to the related Item –EUT Test Photos.
Note: Both horizontal and vertical antenna polarities were tested and performed pretest to three orthogonal axis. The worst case emissions were reported.

3.3.3 DEVIATION FROM TEST STANDARD

No deviation

3.3.4 TEST SETUP

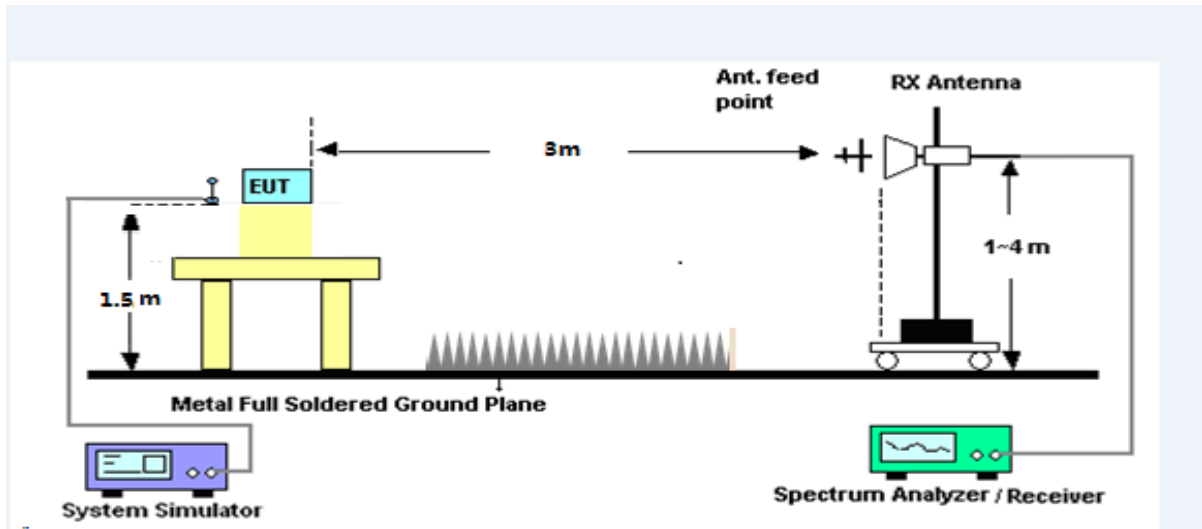

3.3.5 FIELD STRENGTH CALCULATION

Same as 3.2.5

3.3.6 EUT OPERATING CONDITIONS

Same as 3.2.6

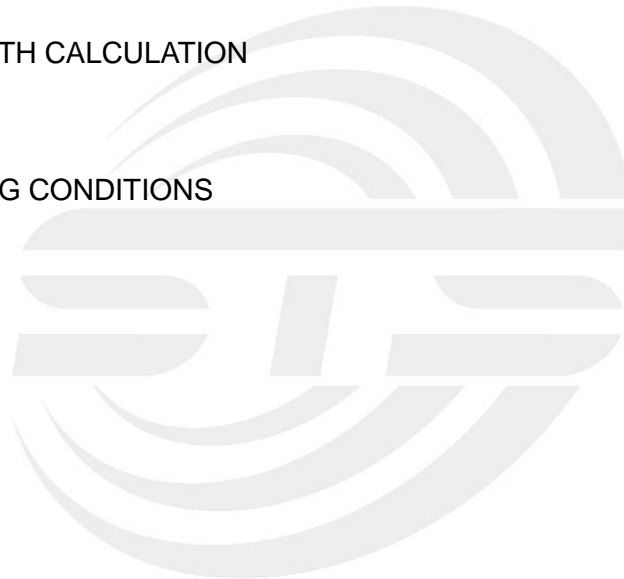



3.3.7 TEST RESULTS

Temperature:	23.1(C)	Relative Humidity:	60%RH
Test Voltage:	AC 120V/60Hz	Phase:	Horizontal
Test Mode:	CH 1(1164Hz – 1240MHz)	Test distance:	1m

No.	Frequency (MHz)	Reading (dBuV)	Correct Factor(dB/m)	Result (dBuV/m)	Limit (dBuV/m)	Margin (dB)	Remark
1	1177.984	8.47	-0.64	7.83	19.44	-11.61	peak
2	1177.984	-7.22	-0.64	-7.86	19.44	-27.30	RMS
3	1189.840	8.31	-0.52	7.79	19.44	-11.65	peak
4	1189.840	-7.23	-0.52	-7.75	19.44	-27.19	RMS
5	1197.516	8.34	-0.44	7.90	19.44	-11.54	peak
6	1197.516	-7.49	-0.44	-7.93	19.44	-27.37	RMS
7	1205.572	7.98	-0.43	7.55	19.44	-11.89	peak
8	1205.572	-7.10	-0.43	-7.53	19.44	-26.97	RMS
9	1222.140	7.73	-0.46	7.27	19.44	-12.17	peak
10	1222.140	-6.82	-0.46	-7.28	19.44	-26.72	RMS
11	1236.352	8.79	-0.49	8.30	19.44	-11.14	peak
12	1236.352	-7.88	-0.49	-8.37	19.44	-27.81	RMS

Remark:

- Margin = Result (Result =Reading + Factor) –Limit
- Factor= Antenna factor+Cable attenuation factor(cable loss)-Amplifier gain

60.0 dBuV/m

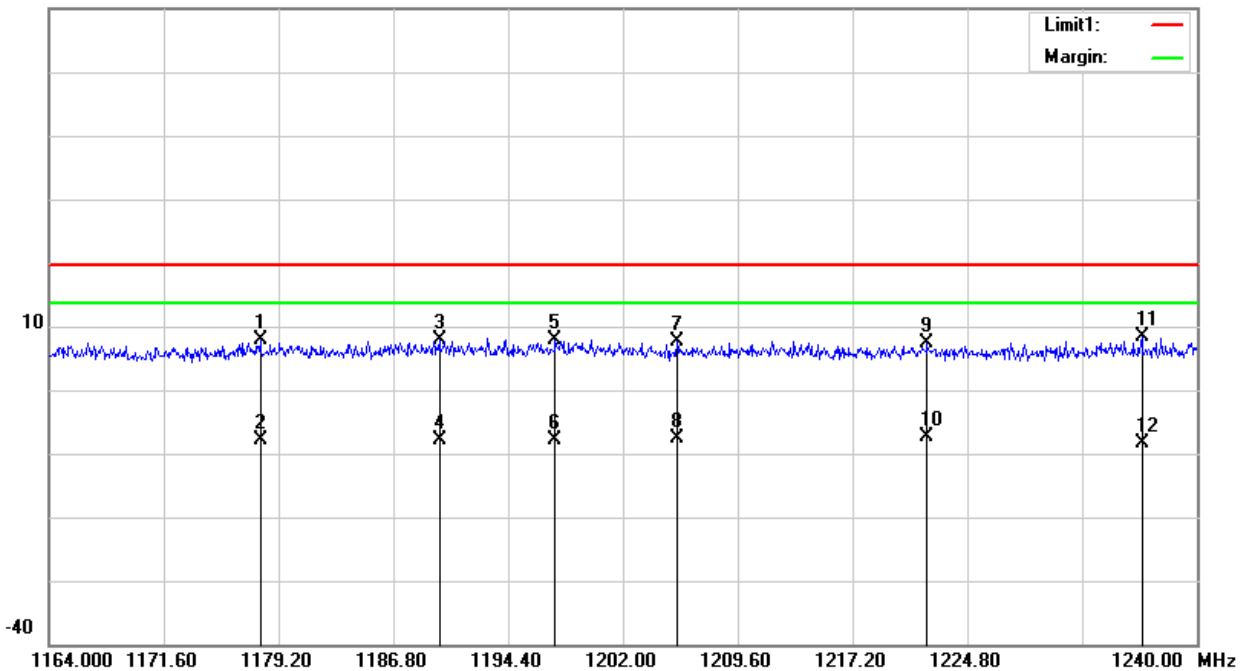



Temperature:	23.1(C)	Relative Humidity:	60%RH
Test Voltage:	AC 120V/60Hz	Phase:	Vertical
Test Mode:	CH 1(1164Hz – 1240MHz)	Test distance:	1m

No.	Frequency (MHz)	Reading (dBuV)	Correct Factor(dB/m)	Result (dBuV/m)	Limit (dBuV/m)	Margin (dB)	Remark
1	1176.464	8.04	-0.65	7.39	19.44	-12.05	peak
2	1176.464	-6.71	-0.65	-7.36	19.44	-26.80	RMS
3	1190.524	8.39	-0.52	7.87	19.44	-11.57	peak
4	1190.524	-7.30	-0.52	-7.82	19.44	-27.26	RMS
5	1202.532	7.85	-0.43	7.42	19.44	-12.02	peak
6	1202.532	-7.03	-0.43	-7.46	19.44	-26.90	RMS
7	1219.100	7.66	-0.46	7.20	19.44	-12.24	peak
8	1219.100	-6.81	-0.46	-7.27	19.44	-26.71	RMS
9	1225.028	8.50	-0.47	8.03	19.44	-11.41	peak
10	1225.028	-7.58	-0.47	-8.05	19.44	-27.49	RMS
11	1232.552	8.12	-0.48	7.64	19.44	-11.80	peak
12	1232.552	-7.19	-0.48	-7.67	19.44	-27.11	RMS

Remark:

- Margin = Result (Result =Reading + Factor)-Limit
- Factor= Antenna factor+Cable attenuation factor(cable loss)-Amplifier gain

60.0 dBuV/m

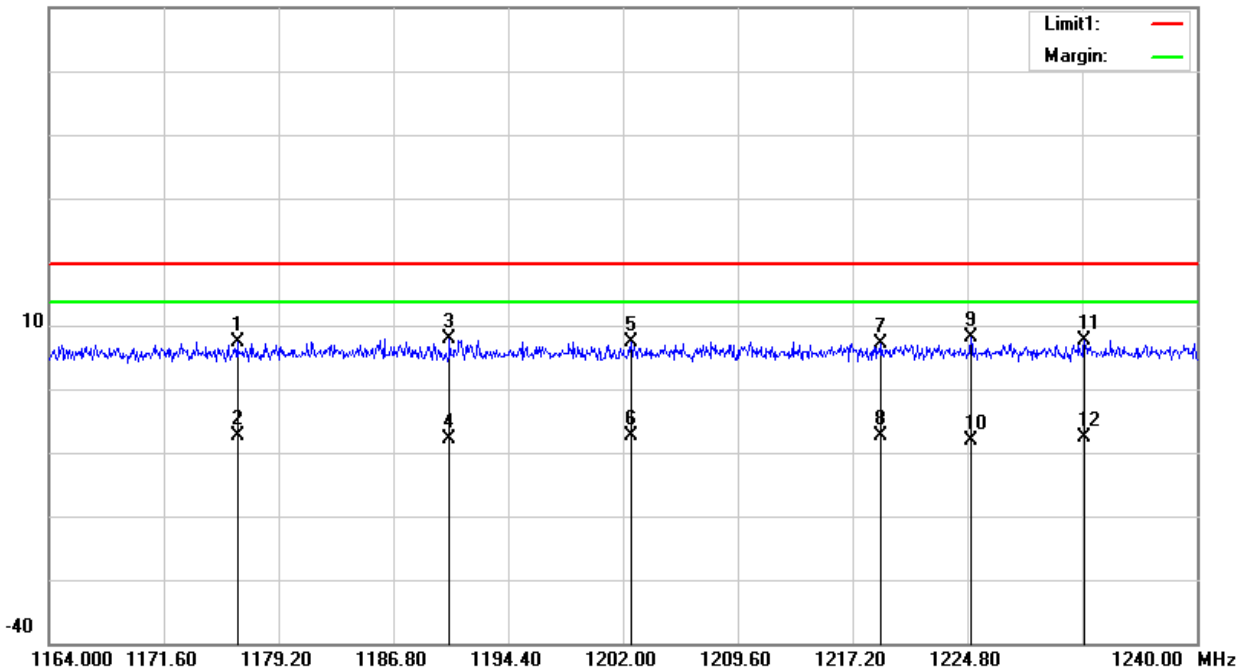



Temperature:	23.1(C)	Relative Humidity:	60%RH
Test Voltage:	AC 120V/60Hz	Phase:	Horizontal
Test Mode:	CH 1(1559Hz – 1610MHz)	Test distance:	1m

No.	Frequency (MHz)	Reading (dBuV)	Correct Factor(dB/m)	Result (dBuV/m)	Limit (dBuV/m)	Margin (dB)	Remark
1	1568.792	8.92	3.26	12.18	19.44	-7.26	peak
2	1568.792	-5.42	3.26	-2.16	19.44	-21.60	RMS
3	1577.717	7.76	3.54	11.30	19.44	-8.14	peak
4	1577.717	-4.92	3.54	-1.38	19.44	-20.82	RMS
5	1585.928	8.11	3.79	11.90	19.44	-7.54	peak
6	1585.928	-5.74	3.79	-1.95	19.44	-21.39	RMS
7	1591.436	8.75	3.97	12.72	19.44	-6.72	peak
8	1591.436	-6.73	3.97	-2.76	19.44	-22.20	RMS
9	1600.463	8.80	4.24	13.04	19.44	-6.40	peak
10	1600.463	-7.30	4.24	-3.06	19.44	-22.50	RMS
11	1605.920	8.38	4.24	12.62	19.44	-6.82	peak
12	1605.920	-6.86	4.24	-2.62	19.44	-22.06	RMS

Remark:

- Margin = Result (Result =Reading + Factor)–Limit
- Factor= Antenna factor+Cable attenuation factor(cable loss)-Amplifier gain

60.0 dBuV/m

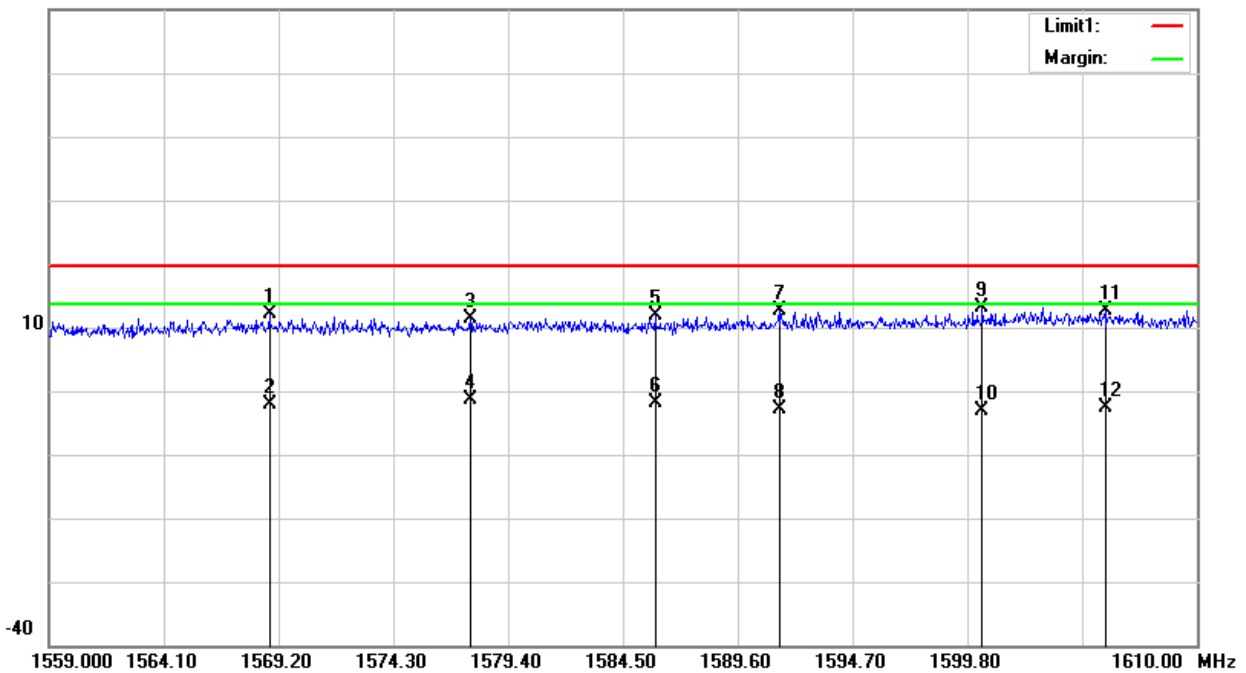



Temperature:	23.1(C)	Relative Humidity:	60%RH
Test Voltage:	AC 120V/60Hz	Phase:	Vertical
Test Mode:	CH 1(1559Hz – 1610MHz)	Test distance:	1m

No.	Frequency (MHz)	Reading (dBuV)	Correct Factor(dB/m)	Result (dBuV/m)	Limit (dBuV/m)	Margin (dB)	Remark
1	1561.754	7.67	3.04	10.71	19.44	-8.73	peak
2	1561.754	-3.75	3.04	-0.71	19.44	-20.15	RMS
3	1567.772	7.88	3.23	11.11	19.44	-8.33	peak
4	1567.772	-4.40	3.23	-1.17	19.44	-20.61	RMS
5	1573.841	8.29	3.42	11.71	19.44	-7.73	peak
6	1573.841	-5.20	3.42	-1.78	19.44	-21.22	RMS
7	1583.990	7.38	3.74	11.12	19.44	-8.32	peak
8	1583.990	-4.90	3.74	-1.16	19.44	-20.60	RMS
9	1591.640	8.01	3.98	11.99	19.44	-7.45	peak
10	1591.640	-5.93	3.98	-1.95	19.44	-21.39	RMS
11	1603.523	8.36	4.24	12.60	19.44	-6.84	peak
12	1603.523	-5.92	4.24	-1.68	19.44	-21.12	RMS

Remark:

- Margin = Result (Result =Reading + Factor)-Limit
- Factor= Antenna factor+Cable attenuation factor(cable loss)-Amplifier gain

60.0 dBuV/m

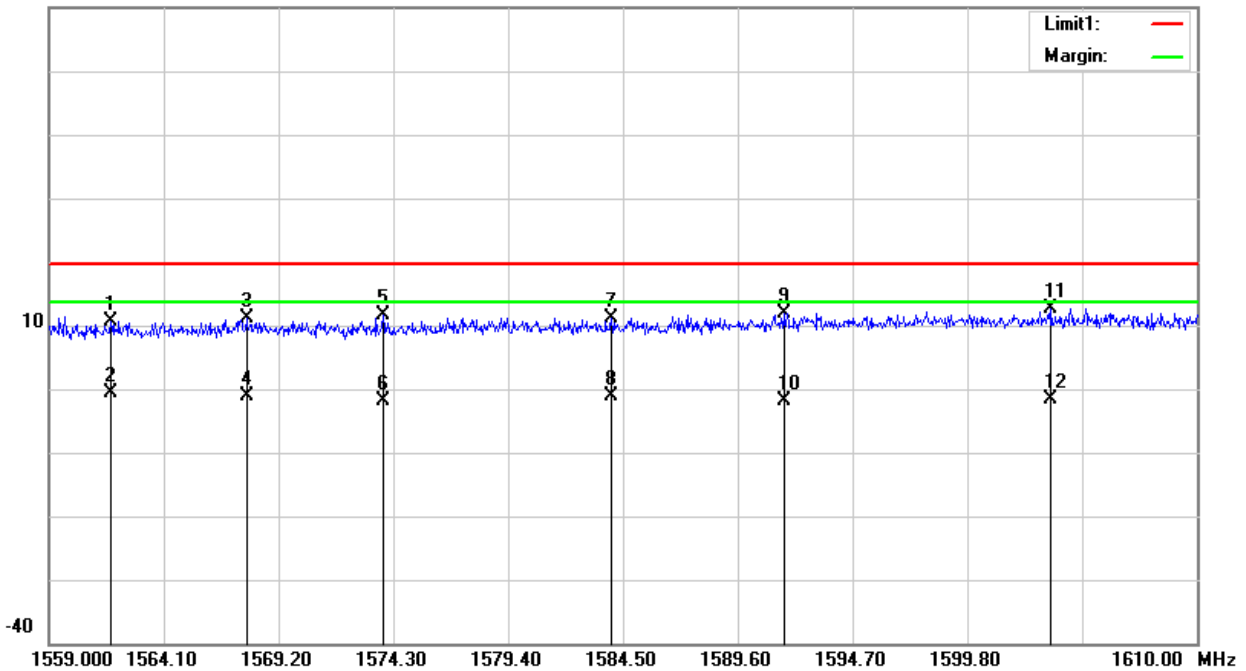



4. UWB BANDWIDTH AND 99% BANDWIDTH

4.1 LIMITS OF UWB BANDWIDTH MEASUREMENT

The UWB bandwidth of a UWB system operating under the provisions of this section must be contained between 3100 MHz and 10,600 MHz.

At any point in time, has a fractional bandwidth equal to or greater than 0.20 or has a UWB bandwidth equal to or greater than 500 MHz, regardless of the fractional bandwidth.

The 99% bandwidth for reporting purposes only.

4.2 INSTRUMENT SETUP VALUE AND MEASUREMENT DISTANCE

Frequency Range	RBW	VBW	Detector	Measurement Distance
3100~10600	1MHz	1MHz	PEAK	1 Meter

4.3 TEST PROCEDURE

- The measuring distance of 1m shall be used for measurements. The EUT was placed on the top of a rotating table 0.8 meter above the ground at a 3 meter semi-anechoic chamber. The table was rotated 360 degrees to determine the position of the highest radiation.
- The height of the test antenna shall vary between 1m to 4m. Both horizontal and vertical polarization of the antenna are set to make the measurement.
- All readings are RMS mode value, for each suspected emission, the EUT was arranged to its worst case and then the antenna was tuned to heights from 1 meter to 4 meters and the rotatable table was turned from 0 degrees to 360 degrees to find the maximum reading.
- For the actual test configuration, please refer to the related Item –EUT Test Photos.
- The Spectrum Analyzer system was set to Peak Detect Function and Specified Bandwidth with Maximum Hold Mode.
- The UWB Bandwidth is measured at the 10 dB point (FL, FH).

Note: Both horizontal and vertical antenna polarities were tested. The worst case emissions were reported.

99% Bandwidth connect the UUT to the spectrum analyser and use the following settings:

Center Frequency	The centre frequency of the channel under test
Detector	Peak
RBW	1% to 5% of the occupied bandwidth
VBW	approximately 3×RBW
Trace	Max hold
Sweep	Auto

Allow the trace to stabilize and measure the maximum width of the emission that is constrained by the frequencies associated with the two outermost amplitude points (upper and lower frequencies) that are attenuated by 6 dB and 99% relative to the maximum level measured in the fundamental emission.

4.4 TEST SETUP

Same as 3.3.4

4.5 EUT OPERATION CONDITIONS

Same as 3.2.6



4.6 TEST RESULTS

Temperature:	25 °C	Relative Humidity:	50%
Test Voltage:	AC 120V/60Hz		

Test Channel	f _M (MHz)	f _L (MHz)	f _H (MHz)	-10dB Bandwidth (MHz)	f _c (MHz)	Fractional Bandwidth (MHz)	Limit	Result
CH1	6294.2	6151	6779	628	6465	0.10	-10dB Bandwidth ≥ 500MHz or Fractional Bandwidth ≥ 0.2	Pass

CH 1

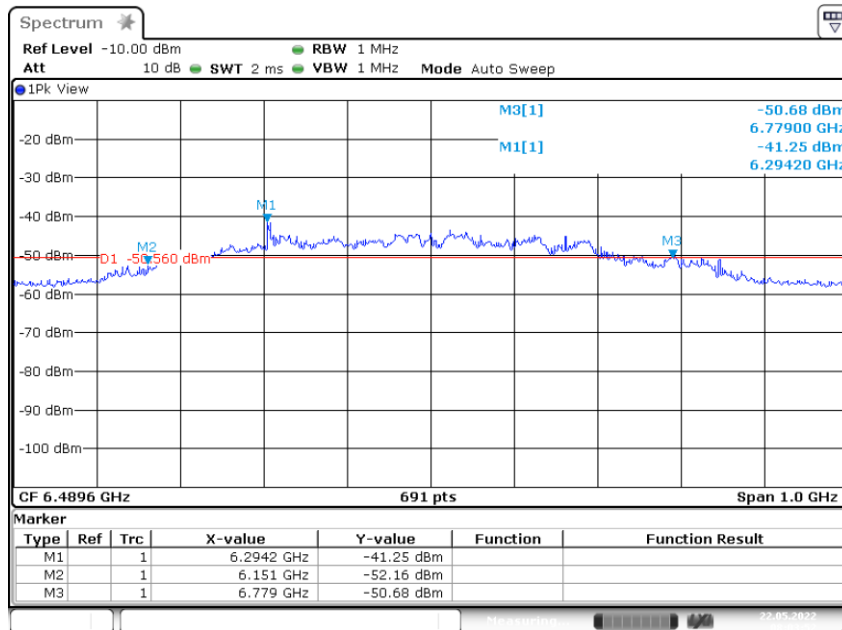

Date: 22.MAY.2022 08:03:52



Temperature:	25 °C	Relative Humidity:	50%
Test Voltage:	AC 120V/60Hz		

Frequency (MHz)	99% Bandwidth (MHz)	Result
6489.6	723.59	PASS

CH 1

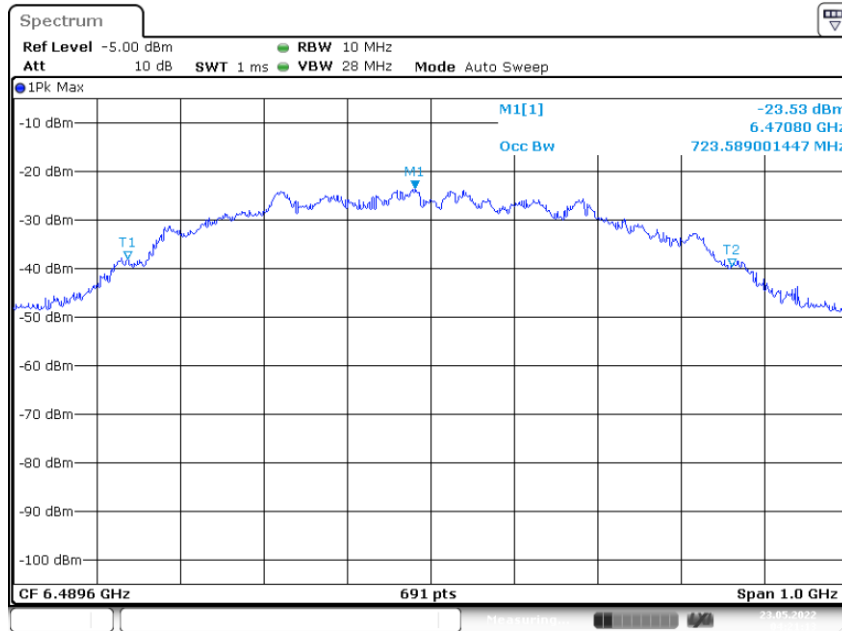

Date: 23.MAY.2022 04:21:13



5 PEAK EMISSION WITHIN A 50MHZ BANDWIDTH (FOR 15.517(e) & RSS-220

5.2.1(g))

5.1 LIMITS OF PEAK EMISSION

The Maximum Peak Output Power Measurement is 0dBm(RBW=50MHz).

If a resolution bandwidth other than 50 MHz is Employed, the peak EIRP limit shall be $20 \log(RBW/50)$ dBm where RBW is the resolution bandwidth in megahertz that is employed. The resolution bandwidth used to make the peak measurement was 1MHz, resulting in a limit of -34dBm.

This may be converted to a peak field strength level at 3 meters using

$$E(\text{dBuV/m}) = P(\text{dBm EIRP}) + 95.2 = -34 + 95.2 = 61.2 \text{ dBuV/m}$$

$$\text{Note: } EIRP_{1\text{MHz}} = EIRP_{50\text{MHz}} + 20\log(1\text{MHz} / 50 \text{ MHz}) = 0 \text{ dBm} + -34 \text{ dB} = -34 \text{ dBm}$$

5.2 INSTRUMENT SETUP VALUE AND MEASUREMENT DISTANCE

Frequency Range	RBW	VBW	Detector	Measurement Distance
3100~10600	1MHz	3MHz	PEAK	3 Meter

5.3 TEST PROCEDURE

Same as 3.3.2

5.4 DEVIATION FROM TEST STANDARD

No deviation

5.5 TEST SETUP

Same as 3.3.4

5.6 FIELD STRENGTH CALCULATION

Same as 3.2.5

5.7 EUT OPERATING CONDITIONS

Same as 3.2.5



5.8 TEST RESULTS

Temperature:	23.5(C)	Relative Humidity:	62%RH
Test Voltage:	AC 120V/60Hz	Phase:	Horizontal
Test Mode:	CH 1	Test distance:	3m

No.	Frequency (MHz)	Reading (dBuV)	Correct Factor(dB/m)	Result (dBuV/m)	Limit (dBuV/m)	Margin (dB)	Remark
1	6297.519	59.63	-2.45	57.18	61.20	-4.02	peak

Remark:

- 1. Margin = Result (Result =Reading + Factor)-Limit
- 2. Factor= Antenna factor+Cable attenuation factor(cable loss)-Amplifier gain

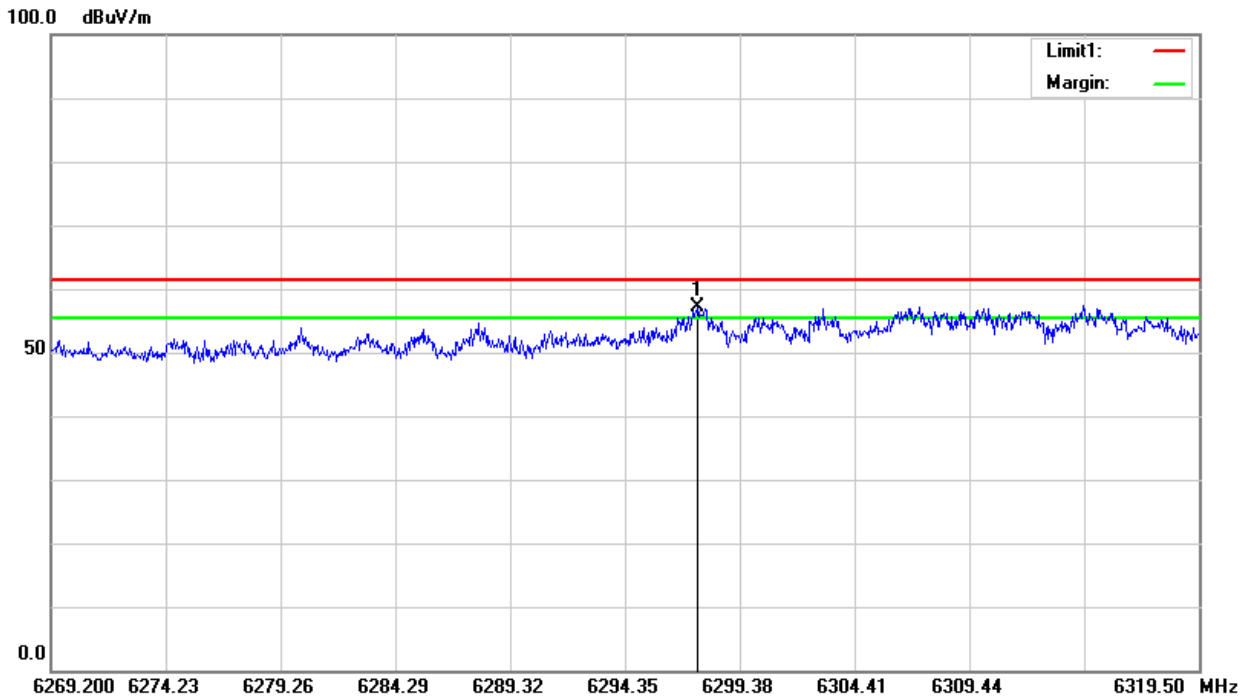



Temperature:	23.5(C)	Relative Humidity:	62%RH
Test Voltage:	AC 120V/60Hz	Phase:	Vertical
Test Mode:	CH 1	Test distance:	3m

No.	Frequency (MHz)	Reading (dBuV)	Correct Factor(dB/m)	Result (dBuV/m)	Limit (dBuV/m)	Margin (dB)	Remark
1	6298.978	59.48	-2.44	57.04	61.20	-4.16	peak

Remark:

- 1. Margin = Result (Result =Reading + Factor)-Limit
- 2. Factor= Antenna factor+Cable attenuation factor(cable loss)-Amplifier gain

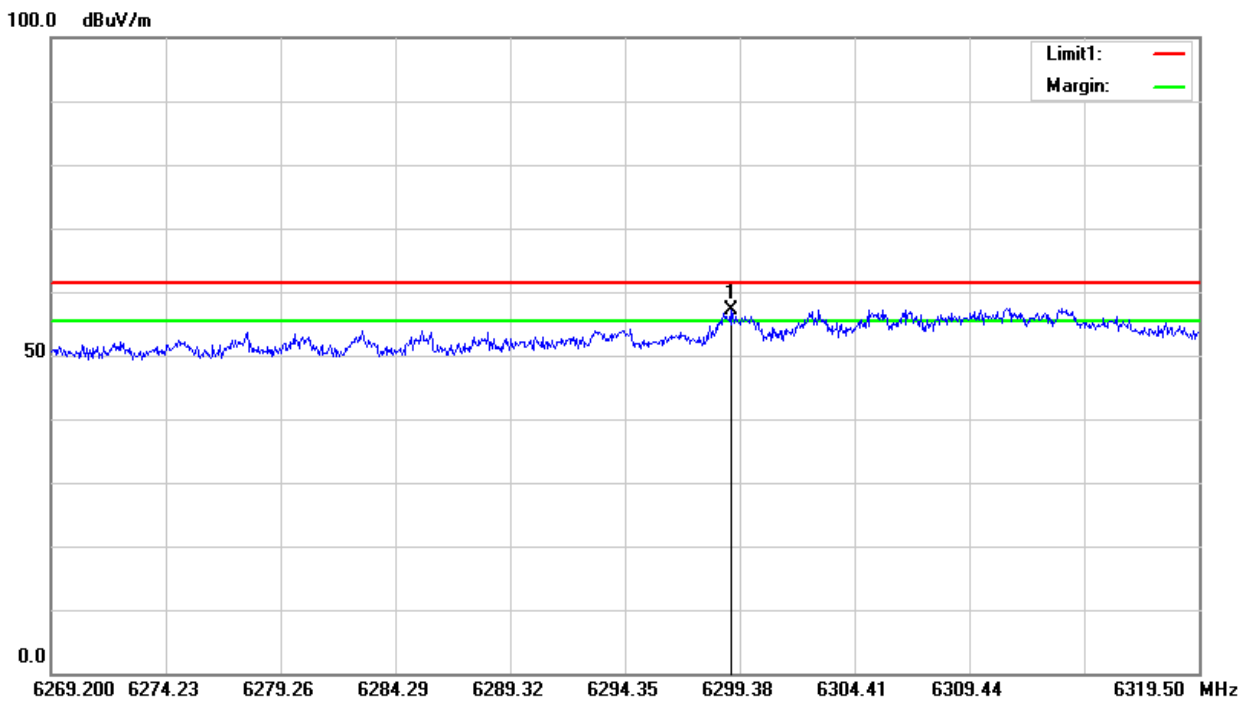



6. ANTENNA REQUIREMENT

6.1 STANDARD REQUIREMENT

According to the FCC Part 15 Paragraph 15.203&RSS-Gen(6.8), an intentional radiator shall be designed to ensure that no antenna other than that furnished by the responsible party shall be used with the device.

6.2 EUT ANTENNA

The EUT antenna is PCB Antenna.It conforms to the standard requirements.





APPENDIX- PHOTOS OF TEST SETUP

Note: See test photos in setup photo document for the actual connections between Product and support equipment.

*****END OF THE REPORT*****

