



FCC PART 15.247 TEST REPORT

For

Shenzhen Digidragon Technology Co., Ltd

F02-3, Block 36, Dayun Software Town, Longgang District, Shenzhen, China

FCC ID: 2AW7SDS571

Report Type: Original Report	Product Name: 3G Mobile Phone
Report Number:	<u>SZ2210517-17697E-00A</u>
Report Date:	<u>2021-06-17</u>
Reviewed By:	Rocky Xiao RF Engineer <i>Rocky Xiao</i>
Test Laboratory:	Bay Area Compliance Laboratories Corp. (Dongguan) No.12, Pulong East 1 st Road, Tangxia Town, Dongguan, Guangdong, China Tel: +86-769-86858888 Fax: +86-769-86858891 www.baclcorp.com.cn

TABLE OF CONTENTS

GENERAL INFORMATION.....	4
PRODUCT DESCRIPTION FOR EQUIPMENT UNDER TEST (EUT).....	4
OBJECTIVE	4
TEST METHODOLOGY	4
MEASUREMENT UNCERTAINTY	5
TEST FACILITY	5
DECLARATIONS.....	5
SYSTEM TEST CONFIGURATION.....	6
DESCRIPTION OF TEST CONFIGURATION	6
EUT EXERCISE SOFTWARE	6
EQUIPMENT MODIFICATIONS	6
SUPPORT CABLE LIST AND DETAILS	6
BLOCK DIAGRAM OF TEST SETUP	7
SUMMARY OF TEST RESULTS	8
FCC §15.247 (i) & §1.1310 & §2.1093- RF EXPOSURE.....	9
APPLICABLE STANDARD	9
FCC §15.203 - ANTENNA REQUIREMENT.....	10
APPLICABLE STANDARD	10
ANTENNA CONNECTOR CONSTRUCTION	10
FCC §15.207 (a) – AC LINE CONDUCTED EMISSIONS	11
APPLICABLE STANDARD	11
EUT SETUP	11
EMI TEST RECEIVER SETUP.....	11
TEST PROCEDURE	12
CORRECTED AMPLITUDE & MARGIN CALCULATION	12
TEST EQUIPMENT LIST AND DETAILS.....	12
TEST DATA	13
FCC §15.209, §15.205 & §15.247(d) - SPURIOUS EMISSIONS.....	15
APPLICABLE STANDARD	15
EUT SETUP	15
EMI TEST RECEIVER & SPECTRUM ANALYZER SETUP	16
TEST PROCEDURE	16
TEST EQUIPMENT LIST AND DETAILS.....	16
CORRECTED AMPLITUDE & MARGIN CALCULATION	17
TEST DATA	17
FCC §15.247(a) (1) - CHANNEL SEPARATION TEST	23
APPLICABLE STANDARD	23
TEST EQUIPMENT LIST AND DETAILS.....	23
TEST PROCEDURE	23
TEST DATA	23
FCC §15.247(a) (1) – 20 dB BANDWIDTH TESTING.....	29
APPLICABLE STANDARD	29
TEST PROCEDURE	29
TEST EQUIPMENT LIST AND DETAILS.....	29

TEST DATA29

FCC §15.247(a) (1) (iii) - QUANTITY OF HOPPING CHANNEL TEST35

 APPLICABLE STANDARD35

 TEST PROCEDURE35

 TEST EQUIPMENT LIST AND DETAILS.....35

 TEST DATA35

FCC §15.247(a) (1) (iii) - TIME OF OCCUPANCY (DWELL TIME).....38

 APPLICABLE STANDARD38

 TEST PROCEDURE38

 TEST EQUIPMENT LIST AND DETAILS.....38

 TEST DATA38

FCC §15.247(b) (1) - PEAK OUTPUT POWER MEASUREMENT44

 APPLICABLE STANDARD44

 TEST PROCEDURE44

 TEST EQUIPMENT LIST AND DETAILS.....44

 TEST DATA44

FCC §15.247(d) - BAND EDGES TESTING46

 APPLICABLE STANDARD46

 TEST PROCEDURE46

 TEST EQUIPMENT LIST AND DETAILS.....46

 TEST DATA47

GENERAL INFORMATION

Product Description for Equipment under Test (EUT)

EUT Name:		3G Mobile Phone
EUT Model:		DS571
Operation Frequency:		2402-2480 MHz
Maximum Peak Output Power (Conducted):		4.53 dBm
Modulation Type:		GFSK, $\pi/4$ -DQPSK, 8DPSK
Antenna Gain▲:		-1.24 dBi
Adapter Information	Model:	J002-1
	Input:	100-240Vac 50/60Hz 0.2A
	Output:	5.0Vdc 1000mA
Rated Input Voltage:		DC 3.8V from battery or DC 5V from Adapter
Serial Number:		SZ2210517-17697E-RF-S1
EUT Received Date:		2021.05.20
EUT Received Status:		Good

Objective

This report is prepared on behalf of **Shenzhen Digidragon Technology Co., Ltd** in accordance with Part 2, Subpart J, Part 15, Subparts A and C of the Federal Communications Commission's rules

The tests were performed in order to determine the Bluetooth BDR and EDR mode of EUT compliance with FCC Rules Part 15, Subpart C, and section 15.203, 15.205, 15.207, 15.209 and 15.247 rules.

Test Methodology

All measurements detailed in this Test Report were performed in accordance with ANSI C63.10-2013 "American National Standard of Procedures for Compliance Testing of Unlicensed Wireless Devices".

All emissions measurement was performed and Bay Area Compliance Laboratories Corp. (Dongguan).

Measurement Uncertainty

Parameter	Measurement Uncertainty
Occupied Channel Bandwidth	±5 %
RF output power, conducted	±0.61dB
Power Spectral Density, conducted	±0.61 dB
Unwanted Emissions, radiated	30M~200MHz: 4.55 dB,200M~1GHz: 5.92 dB,1G~6GHz: 4.98 dB, 6G~18GHz: 5.89 dB,18G~26.5G:5.47 dB,26.5G~40G:5.63 dB
Unwanted Emissions, conducted	±1.5 dB
Temperature	±1 °C
Humidity	±5%
DC and low frequency voltages	±0.4%
Duty Cycle	1%
AC Power Lines Conducted Emission	3.12 dB (150 kHz to 30 MHz)

Note: Otherwise required by the applicant or Product Regulations, Decision Rule in this report did not consider the uncertainty. The extended uncertainty given in this report is obtained by combining the standard uncertainty times the coverage factor K with the 95% confidence interval.

Test Facility

The Test site used by Bay Area Compliance Laboratories Corp. (Dongguan) to collect test data is located on the No.12, Pulong East 1st Road, Tangxia Town, Dongguan, Guangdong, China.

The lab has been recognized as the FCC accredited lab under the KDB 974614 D01 and is listed in the FCC Public Access Link (PAL) database, FCC Registration No. : 897218, the FCC Designation No. : CN1220.

The lab has been recognized by Innovation, Science and Economic Development Canada to test to Canadian radio equipment requirements, the CAB identifier: CN0022.

Declarations

BACL is not responsible for the authenticity of any test data provided by the applicant. Data included from the applicant that may affect test results are marked with a triangle symbol “▲”. Customer model name, addresses, names, trademarks etc. are not considered data.

Unless otherwise stated the results shown in this test report refer only to the sample(s) tested.

This report cannot be reproduced except in full, without prior written approval of the Company.

This report is valid only with a valid digital signature. The digital signature may be available only under the Adobe software above version 7.0.

This report may contain data that are not covered by the accreditation scope and shall be marked with an asterisk “★”.

SYSTEM TEST CONFIGURATION

Description of Test Configuration

The system was configured for testing in engineering mode, which was provided by manufacturer.

EUT Exercise Software

The 'engineering mode' was used during test, which was provided by manufacturer. The maximum power level was configured by the software as below table▲:

Mode	Channel	Frequency (MHz)	Power Level Setting
GFSK	Low	2402	Default
	Middle	2441	Default
	High	2480	Default
$\pi/4$ -DQPSK	Low	2402	Default
	Middle	2441	Default
	High	2480	Default
8DPSK	Low	2402	Default
	Middle	2441	Default
	High	2480	Default

Equipment Modifications

No modification was made to the EUT.

Support Cable List and Details

Cable Description	Shielding Type	Ferrite Core	Length (m)	From Port	To
Earphone Cable	No	No	1.2	EUT	Earphone
USB Cable	Yes	No	1.2	Adapter	EUT

Block Diagram of Test Setup

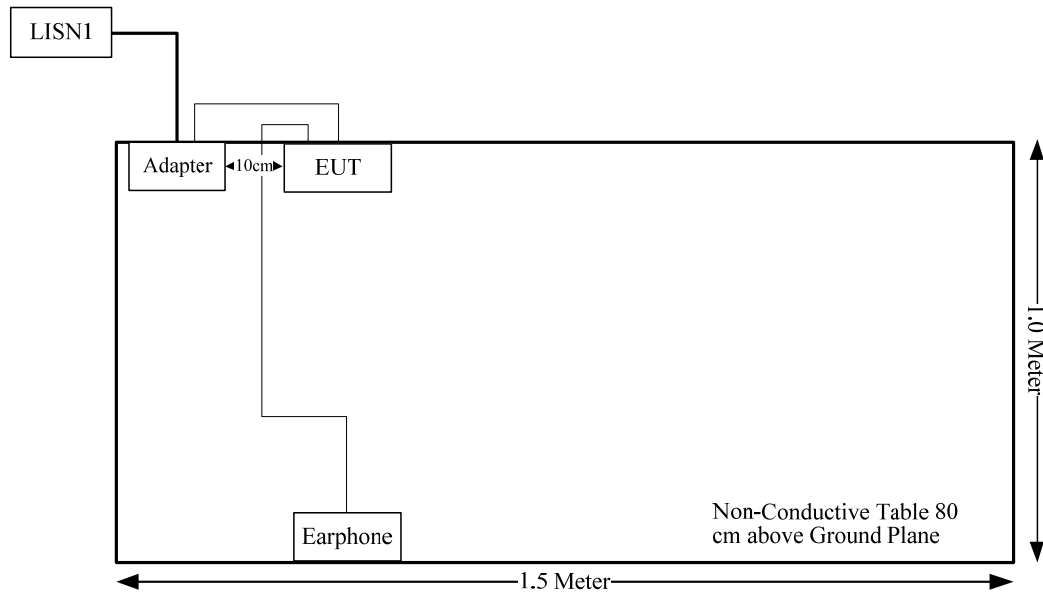

SUMMARY OF TEST RESULTS

FCC Rules	Description of Test	Result
FCC§15.247 (i) & §1.1310 & §2.1093	RF Exposure	Compliance
FCC §15.203	Antenna requirement	Compliance
FCC §15.207(a)	AC line conducted emissions	Compliance
FCC §15.205, §15.209, §15.247(d)	Spurious emissions	Compliance
FCC §15.247(a)(1)	Channel separation	Compliance
FCC §15.247(a)(1)	20 dB bandwidth	Compliance
FCC §15.247(a)(1)(iii)	Quantity of hopping channel test	Compliance
FCC §15.247(a)(1)(iii)	Time of occupancy (dwell time)	Compliance
FCC §15.247(b)(1)	Peak output power measurement	Compliance
FCC §15.247(d)	Band edges	Compliance

FCC §15.247 (i) & §1.1310 & §2.1093- RF EXPOSURE

Applicable Standard

According to §15.247(i) and §1.1310, systems operating under the provisions of this section shall be operated in a manner that ensure that the public is not exposed to radio frequency energy level in excess of the Commission's guideline.

According to KDB447498 D01 General RF Exposure Guidance v06:

The 1-g and 10-g SAR test exclusion thresholds for 100 MHz to 6 GHz at test separation distances ≤ 50 mm are determined by:

$[(\text{max. power of channel, including tune-up tolerance, mW})/(\text{min. test separation distance, mm})] \cdot [\sqrt{f(\text{GHz})}]$
 ≤ 3.0 for 1-g SAR and ≤ 7.5 for 10-g extremity SAR, where

- $f(\text{GHz})$ is the RF channel transmit frequency in GHz
- Power and distance are rounded to the nearest mW and mm before calculation
- The result is rounded to one decimal place for comparison
- 3.0 and 7.5 are referred to as the numeric thresholds in the step 2 below

The test exclusions are applicable only when the minimum test separation distance is ≤ 50 mm and for transmission frequencies between 100 MHz and 6 GHz. When the minimum test separation distance is < 5 mm, a distance of 5 mm according to 5) in section 4.1 is applied to determine SAR test exclusion.

Measurement Result

The max conducted power including tune-up tolerance is 5.0 dBm (3.16 mW).

$[(\text{max. power of channel, mW})/(\text{min. test separation distance, mm})][\sqrt{f(\text{GHz})}]$
 $= 3.16/5 \cdot (\sqrt{2.480}) = 1.0 < 3.0$

So the stand-alone SAR evaluation is not necessary.

FCC §15.203 - ANTENNA REQUIREMENT

Applicable Standard

According to FCC § 15.203, an intentional radiator shall be designed to ensure that no antenna other than that furnished by the responsible party shall be used with the device. The use of a permanently attached antenna or of an antenna that uses a unique coupling to the intentional radiator shall be considered sufficient to comply with the provisions of this Section. The manufacturer may design the unit so that a broken antenna can be replaced by the user, but the use of a standard antenna jack or electrical connector is prohibited.

Antenna Connector Construction

The EUT has one internal FPC antennas arrangement, fulfill the requirement of this section. Please refer to the EUT photos.

Antenna Type	input impedance (Ohm)	Antenna Gain /Frequency Range
FPC	50	-1.24 dBi/2.4~2.5GHz

Result: Compliance.

FCC §15.207 (a) – AC LINE CONDUCTED EMISSIONS

Applicable Standard

FCC§15.207(a)

EUT Setup

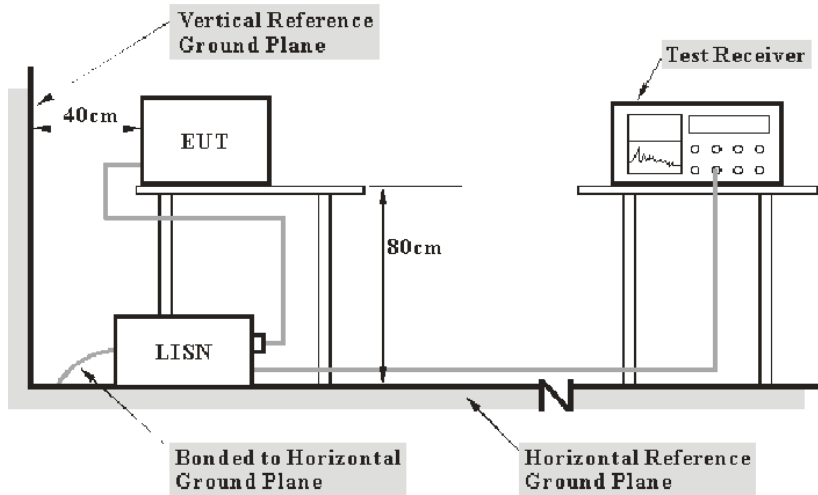

- Note: 1. Support units were connected to second LISN.
 2. Both of LISNs (AMN) 80 cm from EUT and at the least 80 cm from other units and other metal planes support units.

The setup of EUT is according with per ANSI C63.10-2013 measurement procedure. The specification used was with the FCC Part 15.207 limits.

The spacing between the peripherals was 10 cm.

The adapter was connected to the main LISN with a 120 V/60 Hz AC power source.

EMI Test Receiver Setup

The EMI test receiver was set to investigate the spectrum from 150 kHz to 30 MHz.

During the conducted emission test, the EMI test receiver was set with the following configurations:

Frequency Range	IF B/W
150 kHz – 30 MHz	9 kHz

Test Procedure

During the conducted emission test, the adapter was connected to the outlet of the first LISN.

The frequency and amplitude of the six highest ac power-line conducted emissions relative to the limit, measured over all the current-carrying conductors of the EUT power cords, and the operating frequency or frequency to which the EUT is tuned (if appropriate), should be reported, unless such emissions are more than 20 dB below the limit. AC power-line conducted emissions measurements are to be separately carried out only on each of the phase (“hot”) line(s) and (if used) on the neutral line(s), but not on the ground [protective earth] line(s). If less than six emission frequencies are within 20 dB of the limit, then the noise level of the measuring instrument at representative frequencies should be reported. The specific conductor of the power-line cord for each of the reported emissions should be identified. Measure the six highest emissions with respect to the limit on each current-carrying conductor of each power cord associated with the EUT (but not the power cords of associated or peripheral equipment that are part of the test configuration). Then, report the six highest emissions with respect to the limit from among all the measurements identifying the frequency and specific current-carrying conductor identified with the emission. The six highest emissions should be reported for each of the current-carrying conductors, or the six highest emissions may be reported over all the current-carrying conductors.

Corrected Amplitude & Margin Calculation

The basic equation is as follows:

$$V_C = V_R + A_C + VDF$$

Herein,

V_C : corrected voltage amplitude

V_R : reading voltage amplitude

A_C : attenuation caused by cable loss

VDF : voltage division factor of AMN or ISN

The “**Margin**” column of the following data tables indicates the degree of compliance within the applicable limit. For example, a margin of 7dB means the emission is 7dB below the limit. The equation for margin calculation is as follows:

$$\text{Margin} = \text{Limit} - \text{Corrected Amplitude}$$

Test Equipment List and Details

Manufacturer	Description	Model	Serial Number	Calibration Date	Calibration Due Date
R&S	LISN	ENV 216	101614	2020-09-12	2021-09-12
R&S	EMI Test Receiver	ESCI	101121	2020-07-07	2021-07-07
MICRO-COAX	Coaxial Cable	C-NJNJ-50	C-0200-01	2020-09-05	2021-09-05
R&S	Test Software	EMC32	Version 9.10.00	N/A	N/A

* **Statement of Traceability:** Bay Area Compliance Laboratories Corp. (Dongguan) attests that all calibrations have been performed, traceable to National Primary Standards and International System of Units (SI).

Test Data

Environmental Conditions

Temperature:	24.8°C
Relative Humidity:	65 %
ATM Pressure:	100.4kPa
Tester:	Walker Chen
Test Date:	2021-06-09

Test Result: Compliance

Test Mode: Transmitting

AC120V, 60 Hz, Line:

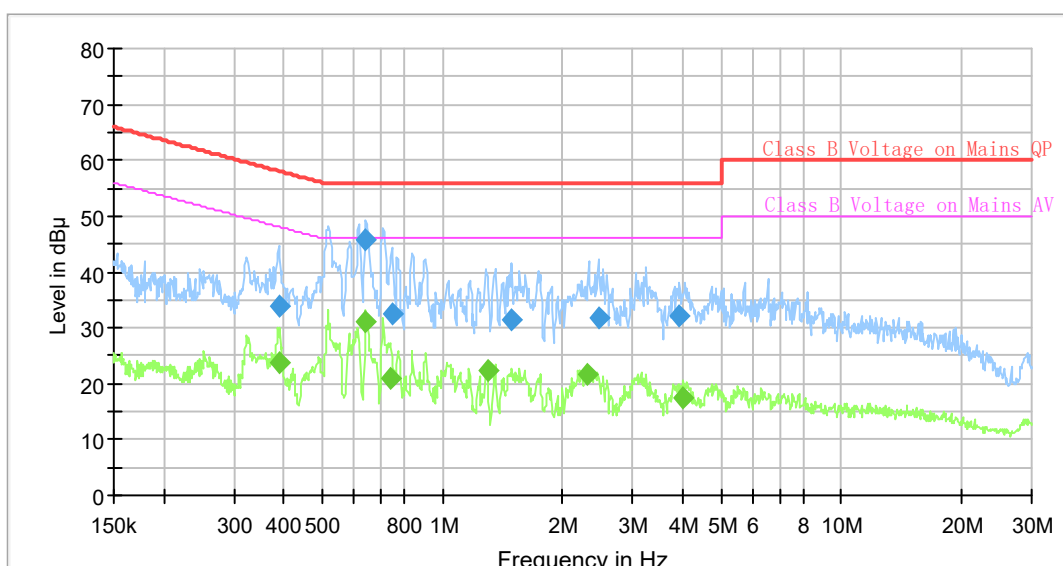

Final Result

Frequency (MHz)	QuasiPeak (dB µV)	Average (dB µV)	Limit (dB µV)	Margin (dB)	Bandwidth (kHz)	Line	Corr. (dB)
0.388874	33.99	---	58.09	24.10	9.000	L1	9.6
0.390819	---	23.75	48.05	24.30	9.000	L1	9.6
0.643549	---	31.12	46.00	14.88	9.000	L1	9.6
0.643549	45.78	---	56.00	10.22	9.000	L1	9.6
0.739999	---	20.96	46.00	25.04	9.000	L1	9.7
0.747417	32.58	---	56.00	23.42	9.000	L1	9.7
1.293689	---	22.49	46.00	23.51	9.000	L1	9.7
1.495016	31.55	---	56.00	24.45	9.000	L1	9.7
2.307242	---	21.59	46.00	24.41	9.000	L1	9.7
2.461795	31.83	---	56.00	24.17	9.000	L1	9.7
3.934248	32.06	---	56.00	23.94	9.000	L1	9.7
4.013525	---	17.44	46.00	28.56	9.000	L1	9.7

AC120V, 60 Hz, Neutral:

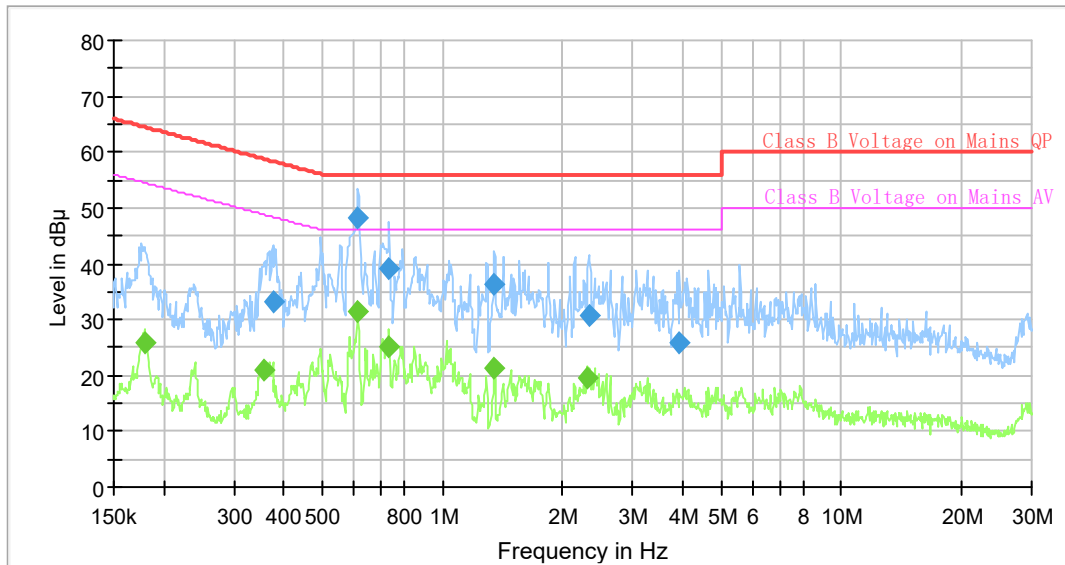

Final Result

Frequency (MHz)	QuasiPeak (dB μ V)	Average (dB μ V)	Limit (dB μ V)	Margin (dB)	Bandwidth (kHz)	Line	Corr. (dB)
0.178609	---	25.95	54.55	28.60	9.000	N	9.6
0.355484	---	21.11	48.83	27.72	9.000	N	9.6
0.375532	33.35	---	58.38	25.03	9.000	N	9.6
0.615300	---	31.30	46.00	14.70	9.000	N	9.6
0.615300	48.20	---	56.00	7.80	9.000	N	9.6
0.736317	---	25.22	46.00	20.78	9.000	N	9.6
0.736317	39.27	---	56.00	16.73	9.000	N	9.6
1.346351	36.41	---	56.00	19.59	9.000	N	9.6
1.346351	---	21.36	46.00	24.64	9.000	N	9.6
2.318778	---	19.54	46.00	26.46	9.000	N	9.6
2.330372	30.88	---	56.00	25.12	9.000	N	9.6
3.934248	25.92	---	56.00	30.08	9.000	N	9.6

FCC §15.209, §15.205 & §15.247(d) - SPURIOUS EMISSIONS

Applicable Standard

FCC §15.247 (d); §15.209; §15.205;

EUT Setup

Below 1GHz:

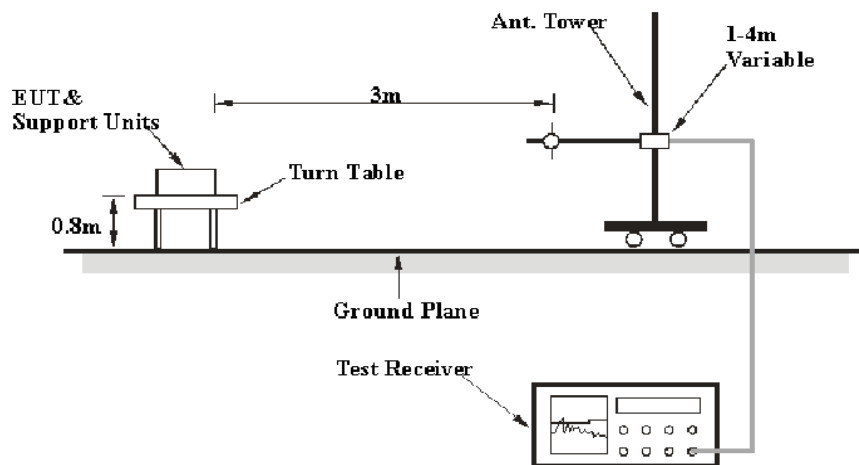

Above 1GHz:

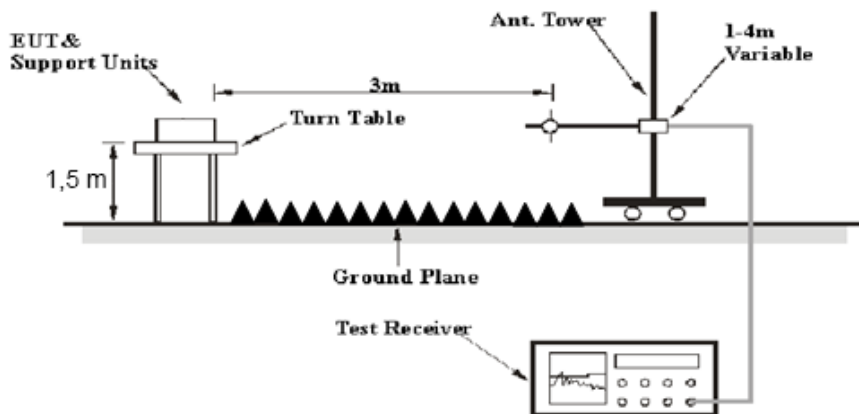

The radiated emission below 1GHz tests were performed in the 10 meters chamber, above 1GHz tests were performed in the 3 meters chamber B, using the setup accordance with the ANSI C63.10-2013. The specification used was the FCC 15.209, and FCC 15.247 limits.

The external I/O cables were draped along the test table and formed a bundle 30 to 40 cm long in the middle.

The spacing between the peripherals was 10 cm.

EMI Test Receiver & Spectrum Analyzer Setup

The system was investigated from 30 MHz to 25 GHz.

According to FCC public notice: DA-00-705, during the radiated emission test, the EMI test receiver & Spectrum Analyzer Setup were set with the following configurations:

Frequency Range	RBW	Video B/W	IF B/W	Measurement
30 MHz – 1000 MHz	120 kHz	300 kHz	120 kHz	QP
Above 1 GHz	1MHz	3 MHz	/	PK
	1MHz	10 Hz	/	AV

If the maximized peak measured value complies with under the QP/Average limit more than 6dB, then it is unnecessary to perform an QP/Average measurement.

Test Procedure

Maximizing procedure was performed on the highest emissions to ensure that the EUT complied with all installation combinations.

Data was recorded in Quasi-peak detection mode for frequency range of 30 MHz - 1 GHz, peak and average detection modes for frequencies above 1 GHz.

Test Equipment List and Details

Manufacturer	Description	Model	Serial Number	Calibration Date	Calibration Due Date
Radiation Below 1GHz					
Sunol Sciences	Antenna	JB3	A060611-2	2020-08-25	2023-08-25
R&S	EMI Test Receiver	ESCI	100224	2020-09-12	2021-09-12
Unknown	Coaxial Cable	C-NJNJ-50	C-1000-01	2020-09-05	2021-09-05
Unknown	Coaxial Cable	C-NJNJ-50	C-0400-02	2020-09-05	2021-09-05
Unknown	Coaxial Cable	C-NJNJ-50	C-0530-01	2020-09-24	2021-09-24
Sonoma	Amplifier	310N	185914	2020-10-13	2021-10-13
Farad	Test Software	EZ-EMC	V1.1.4.2	N/A	N/A
Radiation Above 1GHz					
ETS-Lindgren	Horn Antenna	3115	000 527 35	2018-10-12	2021-10-12
Ducommun Technologies	Horn Antenna	ARH-4223-02	1007726-01 1304	2020-12-05	2023-12-04
Agilent	Spectrum Analyzer	E4440A	SG43360054	2020-07-07	2021-07-07
Unknown	Coaxial Cable	C-SJSJ-50	C-0800-01	2020-09-05	2021-09-05
Unknown	Coaxial Cable	C-2.4J2.4J-50	C-0700-02	2020-06-27	2021-06-27
Mini-Circuit	Amplifier	ZVA-213-S+	54201245	2020-09-05	2021-09-05
Quinstar	Amplifier	QLW-18405536-JO	15964001001	2020-06-27	2021-06-27
Farad	Test Software	EZ-EMC	V1.1.4.2	N/A	N/A
E-Microwave	Band-stop Filters	OBSF-2400-2483.5-S	OE01601525	2020-06-16	2021-06-16
Mini Circuits	High Pass Filter	VHF-6010+	31118	2020-06-16	2021-06-16

* **Statement of Traceability:** Bay Area Compliance Laboratories Corp. (Dongguan) attests that all calibrations have been performed, traceable to National Primary Standards and International System of Units (SI).

Corrected Amplitude & Margin Calculation

The Corrected Amplitude is calculated by adding the Antenna Factor and Cable Loss, and subtracting the Amplifier Gain from the Meter Reading. The basic equation is as follows:

$$\text{Corrected Amplitude} = \text{Meter Reading} + \text{Antenna Factor} + \text{Cable Loss} - \text{Amplifier Gain}$$

The “**Margin**” column of the following data tables indicates the degree of compliance with the applicable limit. For example, a margin of 7dB means the emission is 7dB below the limit. The equation for margin calculation is as follows:

$$\text{Margin} = \text{Limit} - \text{Corrected Amplitude}$$

Test Data

Environmental Conditions

Test Items	Radiation Below 1GHz	Radiation Above 1GHz
Temperature:	25.1°C	29.4°C
Relative Humidity:	50%	41 %
ATM Pressure:	100kPa	100.6kPa
Tester:	Asa Chen	Jeremy Liang
Test Date:	2021-06-01	2021-05-30

Test Mode: Transmitting

1) 30MHz-1GHz (BDR High channel was the worst)

Horizontal:

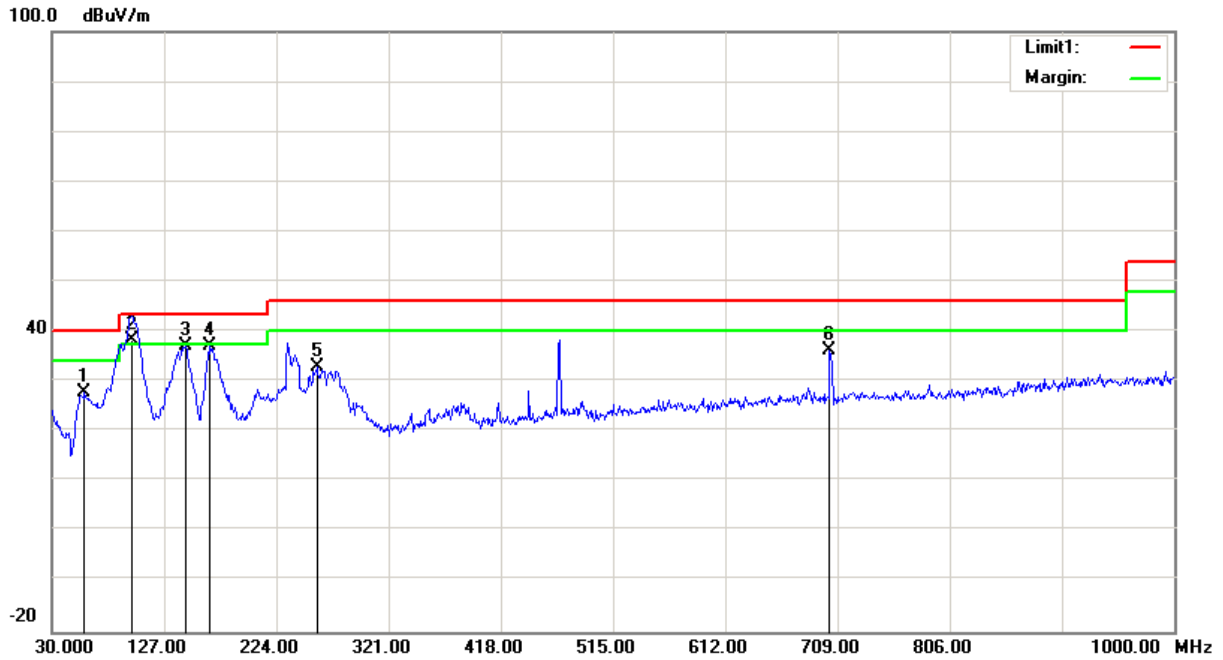

Frequency (MHz)	Receiver Reading (dBμV)	Remark	Correction Factor (dB/m)	Cord. Amp. (dBμV/m)	Limit (dBμV/m)	Margin (dB)
58.1300	44.48	peak	-16.51	27.97	40.00	12.03
98.8700	52.48	QP	-14.08	38.40	43.50	5.10
145.4300	46.41	peak	-9.11	37.30	43.50	6.20
166.7700	46.74	peak	-9.51	37.23	43.50	6.27
258.9200	42.41	peak	-9.33	33.08	46.00	12.92
702.2100	36.28	peak	0.04	36.32	46.00	9.68

Vertical:

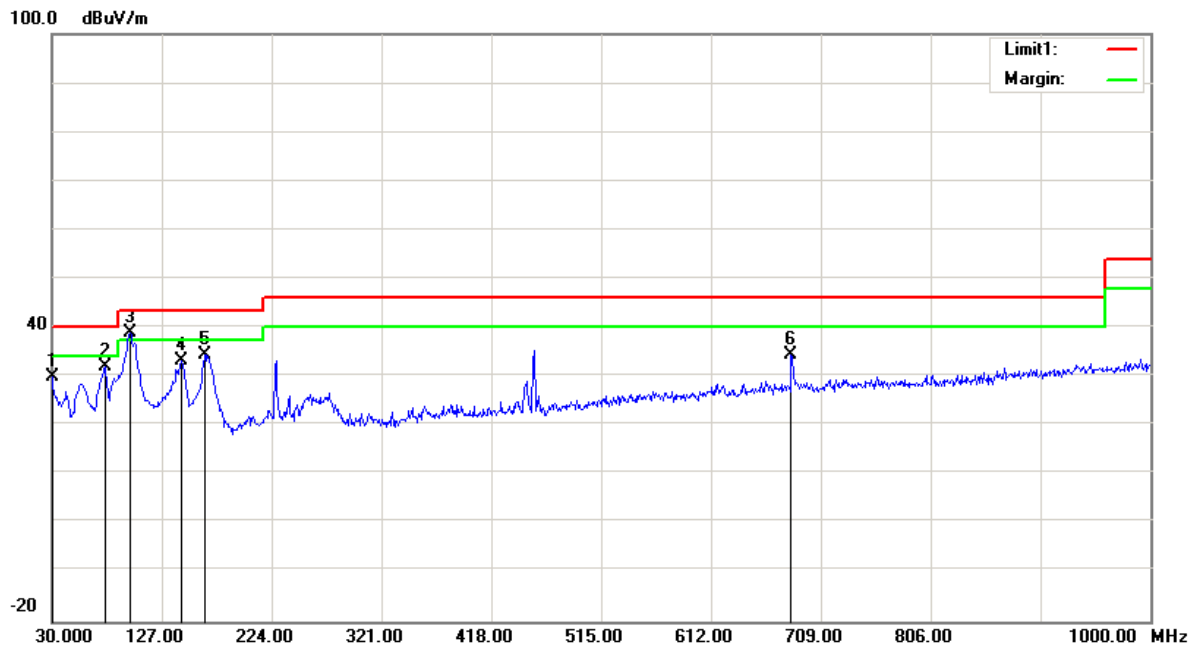

Frequency (MHz)	Receiver Reading (dBµV)	Remark	Correction Factor (dB/m)	Cord. Amp. (dBµV/m)	Limit (dBµV/m)	Margin (dB)
30.0000	33.94	peak	-4.10	29.84	40.00	10.16
76.5600	48.15	peak	-16.05	32.10	40.00	7.90
98.8700	52.89	peak	-14.08	38.81	43.50	4.69
144.4600	42.39	peak	-9.03	33.36	43.50	10.14
164.8300	43.94	peak	-9.40	34.54	43.50	8.96
682.8100	34.06	peak	0.29	34.35	46.00	11.65

2)1GHz-25GHz:*BDR Mode(GFSK):*

Frequency (MHz)	Receiver		Rx Antenna		Cable loss (dB)	Amplifier Gain (dB)	Corrected Amplitude (dBµV/m)	Limit (dBµV/m)	Margin (dB)
	Reading (dBµV)	Remark	Polar (H/V)	Factor (dB/m)					
Low Channel: 2402 MHz									
2402.00	59.31	PK	H	28.10	1.80	0.00	89.21	N/A	N/A
2402.00	54.15	AV	H	28.10	1.80	0.00	84.05	N/A	N/A
2402.00	60.95	PK	V	28.10	1.80	0.00	90.85	N/A	N/A
2402.00	55.13	AV	V	28.10	1.80	0.00	85.03	N/A	N/A
2390.00	29.31	PK	V	28.08	1.80	0.00	59.19	74.00	14.81
2390.00	16.81	AV	V	28.08	1.80	0.00	46.69	54.00	7.31
4804.00	37.27	PK	V	32.91	3.17	25.60	47.75	74.00	26.25
4804.00	26.38	AV	V	32.91	3.17	25.60	36.86	54.00	17.14
7206.00	35.12	PK	V	35.74	4.82	25.60	50.08	74.00	23.92
7206.00	23.14	AV	V	35.74	4.82	25.60	38.10	54.00	15.90
Middle Channel: 2441 MHz									
2441.00	62.09	PK	H	28.18	1.82	0.00	92.09	N/A	N/A
2441.00	56.24	AV	H	28.18	1.82	0.00	86.24	N/A	N/A
2441.00	62.18	PK	V	28.18	1.82	0.00	92.18	N/A	N/A
2441.00	56.43	AV	V	28.18	1.82	0.00	86.43	N/A	N/A
4882.00	37.25	PK	V	33.06	3.27	25.66	47.92	74.00	26.08
4882.00	26.67	AV	V	33.06	3.27	25.66	37.34	54.00	16.66
7323.00	35.24	PK	V	36.04	4.62	25.73	50.17	74.00	23.83
7323.00	23.15	AV	V	36.04	4.62	25.73	38.08	54.00	15.92
High Channel: 2480 MHz									
2480.00	60.03	PK	H	28.26	1.84	0.00	90.13	N/A	N/A
2480.00	54.05	AV	H	28.26	1.84	0.00	84.15	N/A	N/A
2480.00	60.37	PK	V	28.26	1.84	0.00	90.47	N/A	N/A
2480.00	54.69	AV	V	28.26	1.84	0.00	84.79	N/A	N/A
2483.50	28.85	PK	V	28.27	1.84	0.00	58.96	74.00	15.04
2483.50	17.06	AV	V	28.27	1.84	0.00	47.17	54.00	6.83
4960.00	37.65	PK	V	33.22	3.23	25.63	48.47	74.00	25.53
4960.00	27.54	AV	V	33.22	3.23	25.63	38.36	54.00	15.64
7440.00	35.64	PK	V	36.34	4.41	25.85	50.54	74.00	23.46
7440.00	23.56	AV	V	36.34	4.41	25.85	38.46	54.00	15.54

Worst plots (GFSK Low channel was the worst)

Horizontal

Fundamental
Test with Band
Rejection Filter

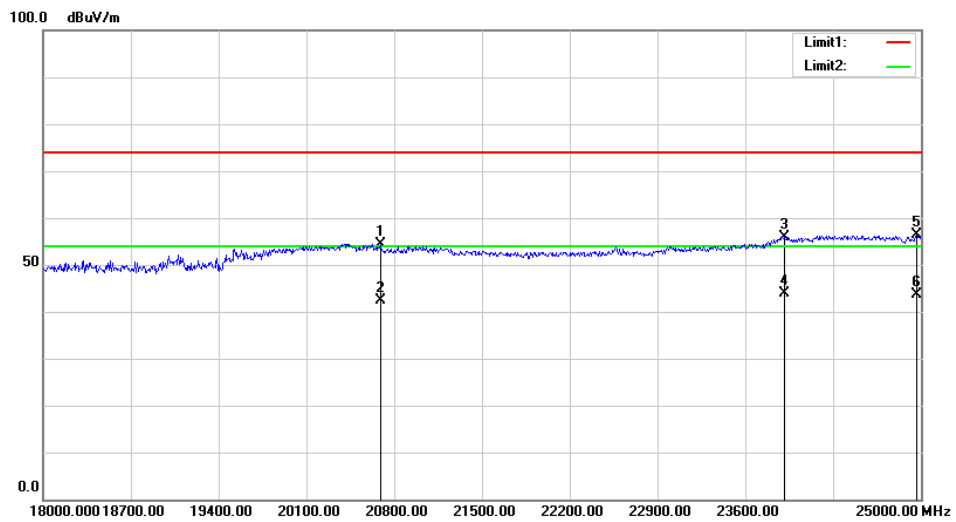
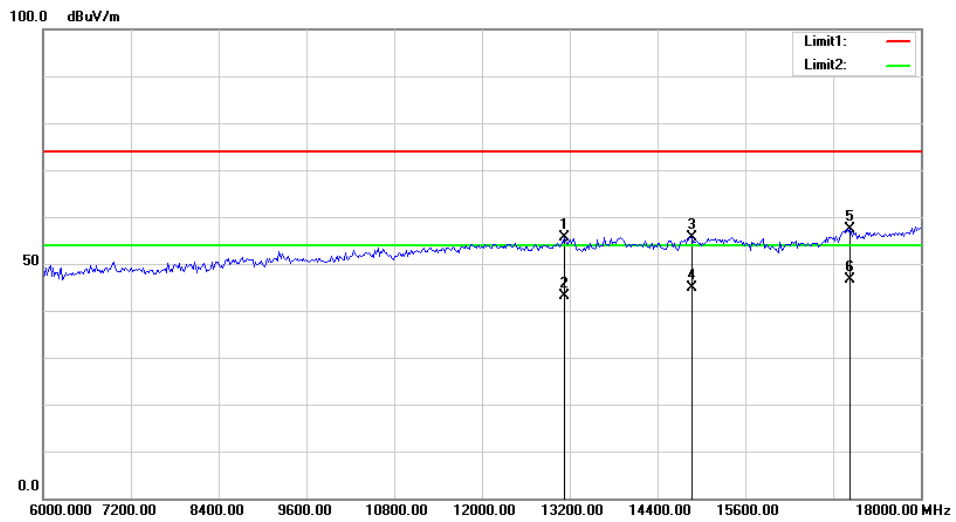
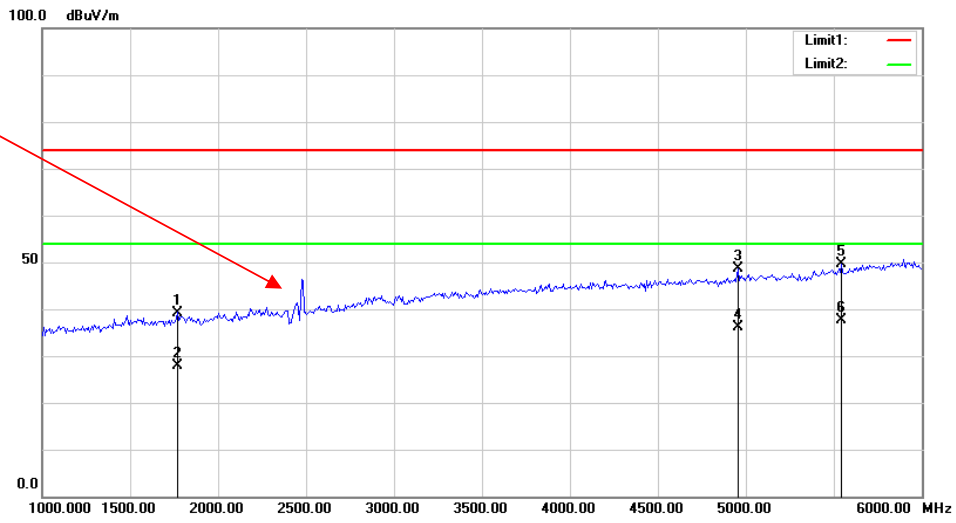

Vertical

Fundamental
Test with Band
Rejection Filter

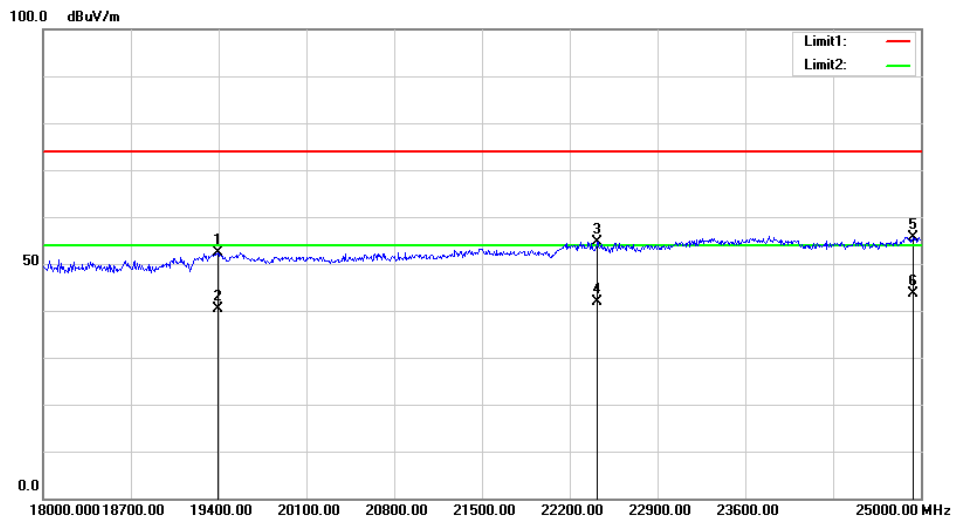
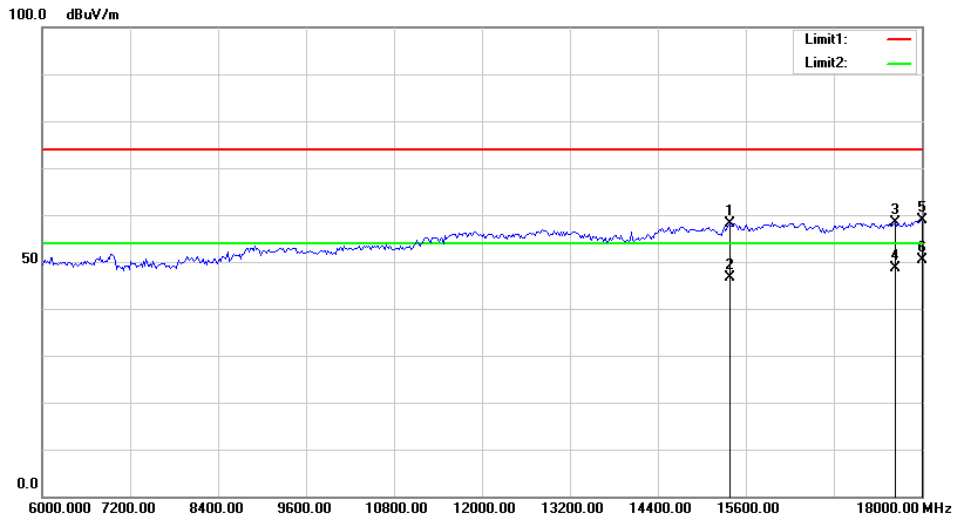
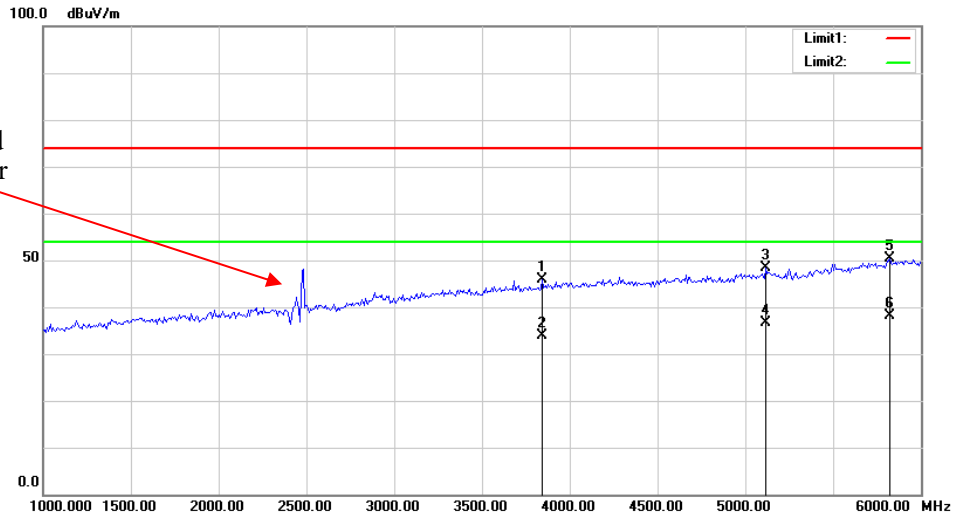

FCC §15.247(a) (1) - CHANNEL SEPARATION TEST

Applicable Standard

Frequency hopping systems shall have hopping channel carrier frequencies separated by a minimum of 25 kHz or the 20dB bandwidth of the hopping channel, whichever is greater. Alternatively, frequency hopping systems operating in the 2400-2483.50 MHz band may have hopping channel carrier frequencies that are separated by 25 kHz or two-thirds of the 20dB bandwidth of the hopping channel, whichever is greater provided the systems operate with an output power no greater than 125 mW.

Test Equipment List and Details

Manufacturer	Description	Model	Serial Number	Calibration Date	Calibration Due Date
R&S	EMI Test Receiver	ESR3	102453	2020-09-12	2021-09-12
Unknown	Coaxial Cable	C-SJ00-0010	C0010/01	Each time	N/A

* **Statement of Traceability:** Bay Area Compliance Laboratories Corp. (Dongguan) attests that all calibrations have been performed, traceable to National Primary Standards and International System of Units (SI).

Test Procedure

1. Set the EUT in transmitting mode, spectrum Bandwidth was set at 30 kHz, maxhold the channel.
2. Set the adjacent channel of the EUT maxhold another trace.
3. Measure the channel separation.

Test Data

Environmental Conditions

Temperature:	27.5 °C
Relative Humidity:	46 %
ATM Pressure:	100kPa
Test by:	Joe Qiao
Test Date:	2021-05-31

Test Result: Compliance. Please refer to following tables and plots

Test Mode: Transmitting

Mode	Channel	Frequency (MHz)	Channel Separation (MHz)	Limit (MHz)
BDR (GFSK)	Low	2402	1.000	0.62
	Middle	2441	1.000	0.62
	High	2480	1.000	0.62
EDR ($\pi/4$ -DQPSK)	Low	2402	1.000	0.83
	Middle	2441	1.000	0.83
	High	2480	1.000	0.83
EDR (8DPSK)	Low	2402	1.000	0.84
	Middle	2441	1.000	0.84
	High	2480	1.000	0.84

Note: Limit= (2/3) × 20dB bandwidth

BDR Mode (GFSK):

Low Channel

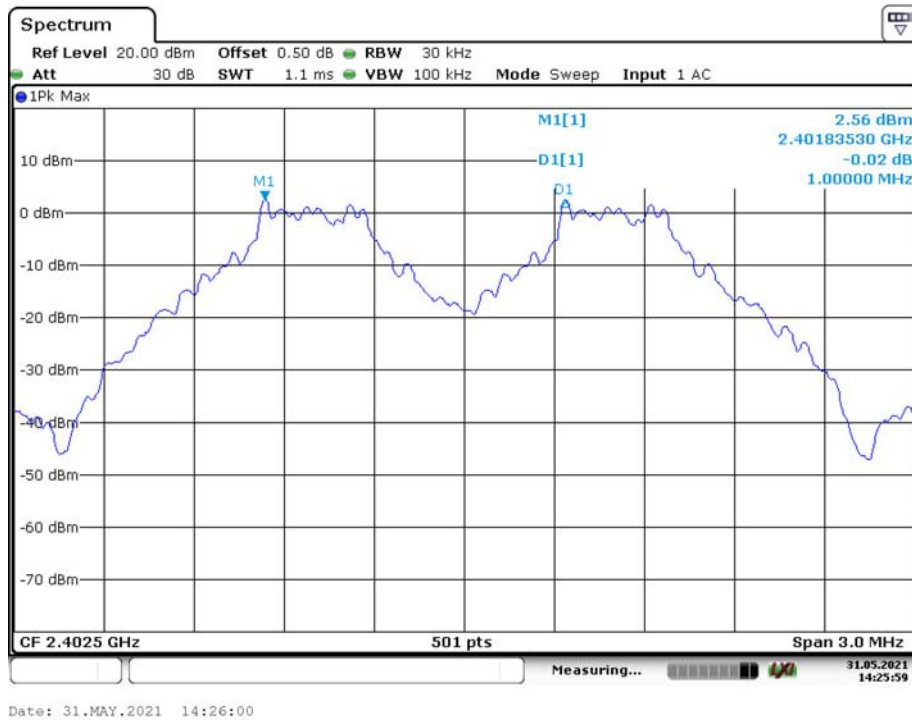

Middle Channel

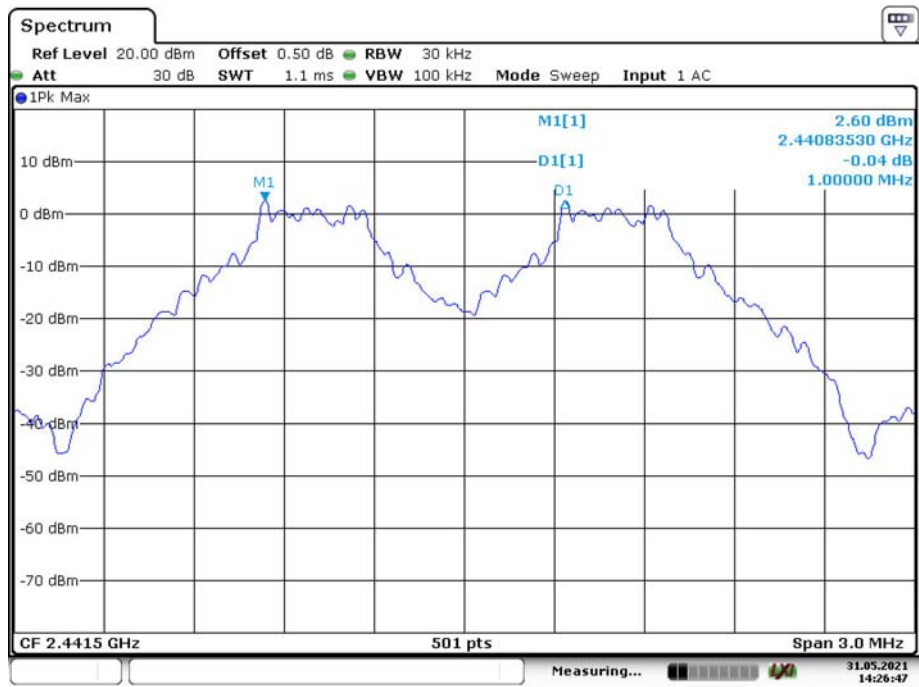

Date: 31.MAY.2021 14:26:47

High Channel

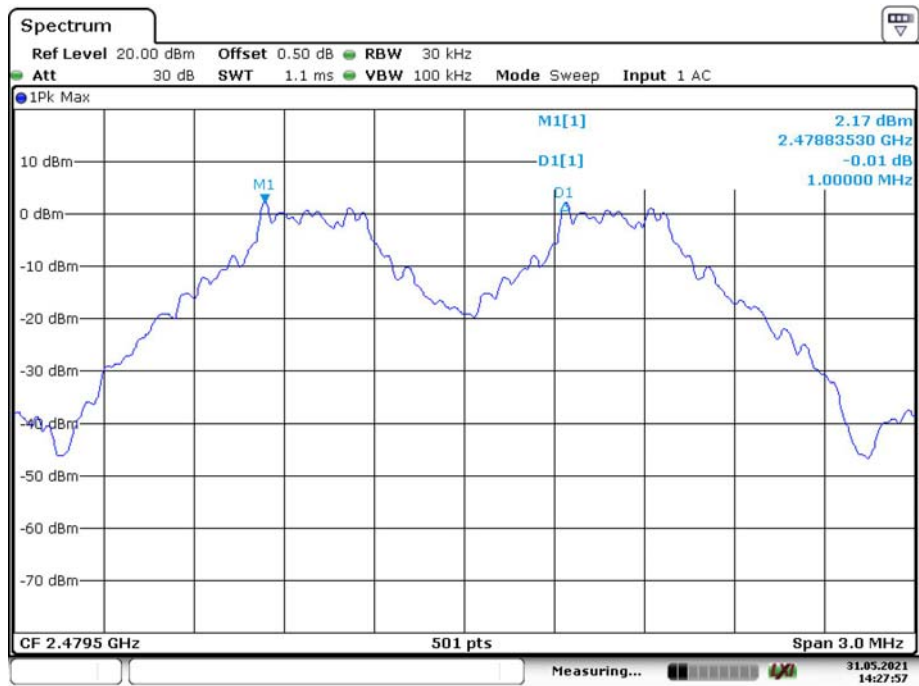

Date: 31.MAY.2021 14:27:57

EDR Mode ($\pi/4$ -DQPSK):

Low Channel

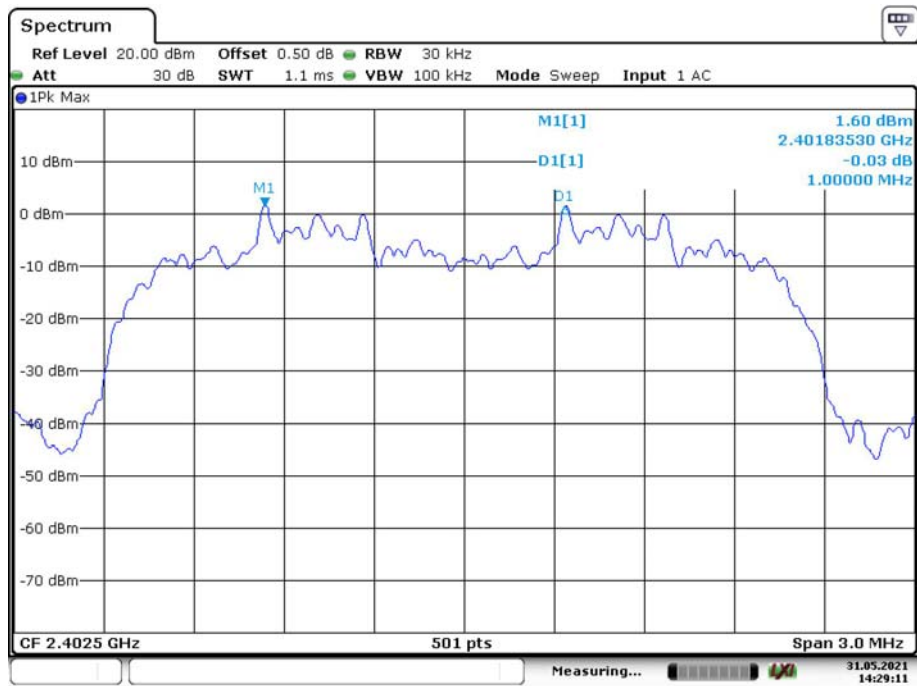

Date: 31.MAY.2021 14:29:12

Middle Channel

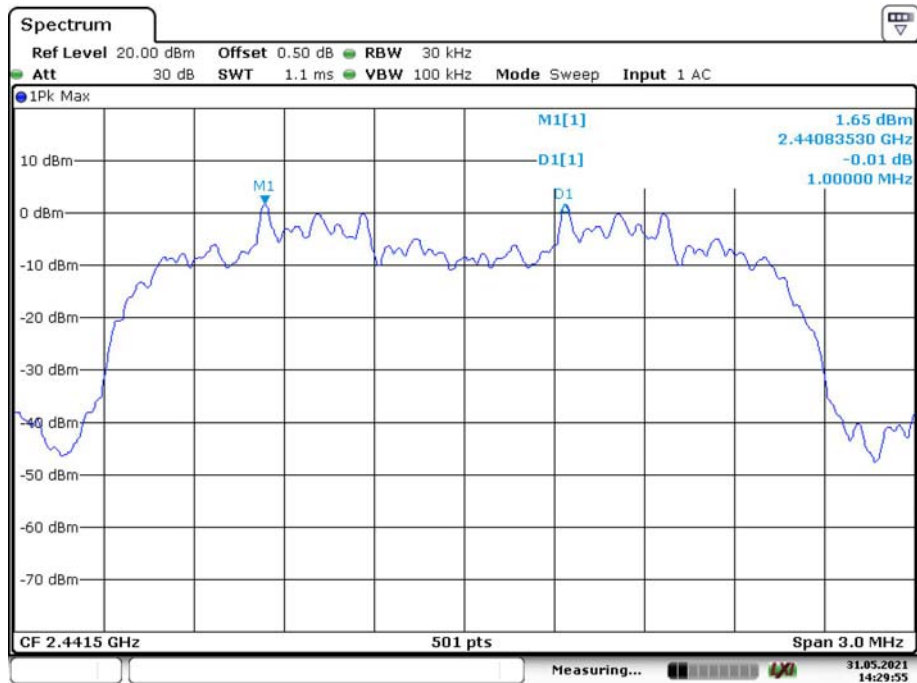

Date: 31.MAY.2021 14:29:56

High Channel

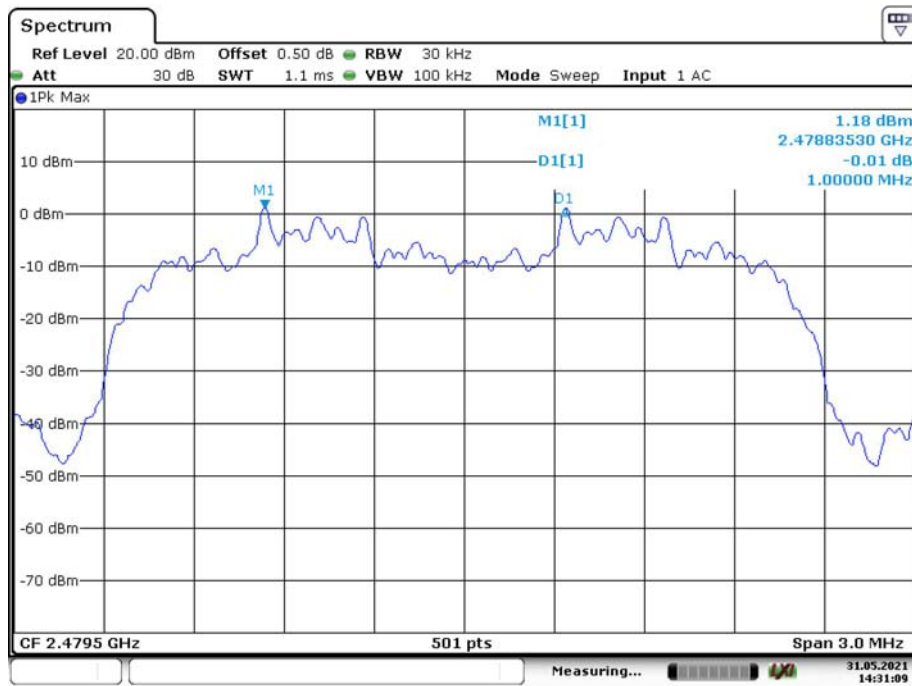

Date: 31.MAY.2021 14:31:10

EDR Mode (8DPSK):

Low Channel



Date: 31.MAY.2021 14:35:26

Middle Channel

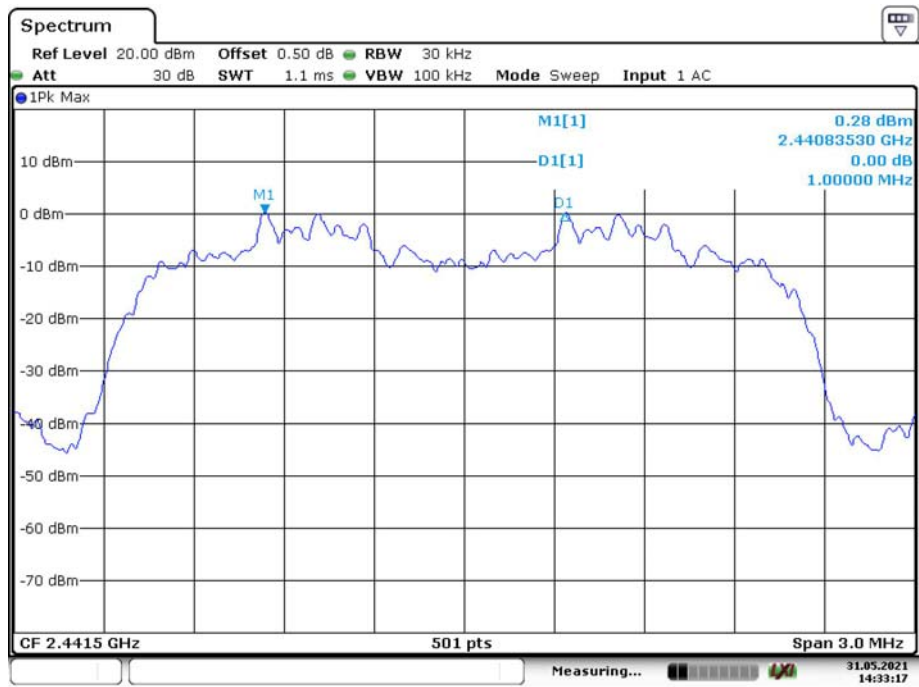

Date: 31.MAY.2021 14:33:17

High Channel



Date: 31.MAY.2021 14:34:19

FCC §15.247(a) (1) – 20 dB BANDWIDTH TESTING

Applicable Standard

Alternatively, frequency hopping systems operating in the 2400–2483.5 MHz band may have hopping channel carrier frequencies that are separated by 25 kHz or two-thirds of the 20 dB bandwidth of the hopping channel, whichever is greater, provided the systems operate with an output power no greater than 125 mW.

Test Procedure

1. Check the calibration of the measuring instrument using either an internal calibrator or a known signal from an external generator.
2. Position the EUT on the test table without connection to measurement instrument. Turn on the EUT. Then set it to any one convenient frequency within its operating range. Set a reference level on the measuring instrument equal to the highest peak value.
3. Measure the frequency difference of two frequencies that were attenuated 20 dB from the reference level. Record the frequency difference as the emission bandwidth.
4. Repeat above procedures until all frequencies measured were complete.

Test Equipment List and Details

Manufacturer	Description	Model	Serial Number	Calibration Date	Calibration Due Date
R&S	EMI Test Receiver	ESR3	102453	2020-09-12	2021-09-12
Unknown	Coaxial Cable	C-SJ00-0010	C0010/01	Each time	N/A

* *Statement of Traceability:* Bay Area Compliance Laboratories Corp. (Dongguan) attests that all calibrations have been performed, traceable to National Primary Standards and International System of Units (SI).

Test Data

Environmental Conditions

Temperature:	27.5 °C
Relative Humidity:	46 %
ATM Pressure:	100kPa
Test by:	Joe Qiao
Test Date:	2021-05-31

Test Result: Compliance. Please refer to following tables and plots

Test Mode: Transmitting

Mode	Channel	Frequency (MHz)	20 dB Bandwidth (MHz)
BDR Mode (GFSK)	Low	2402	0.932
	Middle	2441	0.932
	High	2480	0.928
EDR Mode ($\pi/4$ -DQPSK)	Low	2402	1.248
	Middle	2441	1.252
	High	2480	1.252
EDR Mode (8DPSK)	Low	2402	1.256
	Middle	2441	1.256
	High	2480	1.260

BDR Mode (GFSK):

Low Channel

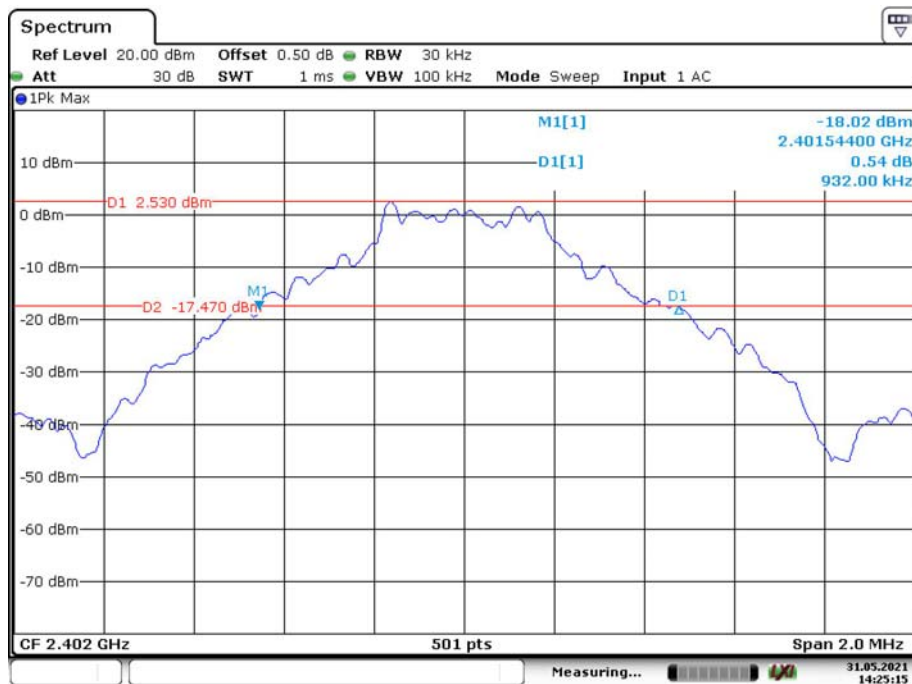

Date: 31.MAY.2021 14:25:16

Middle Channel

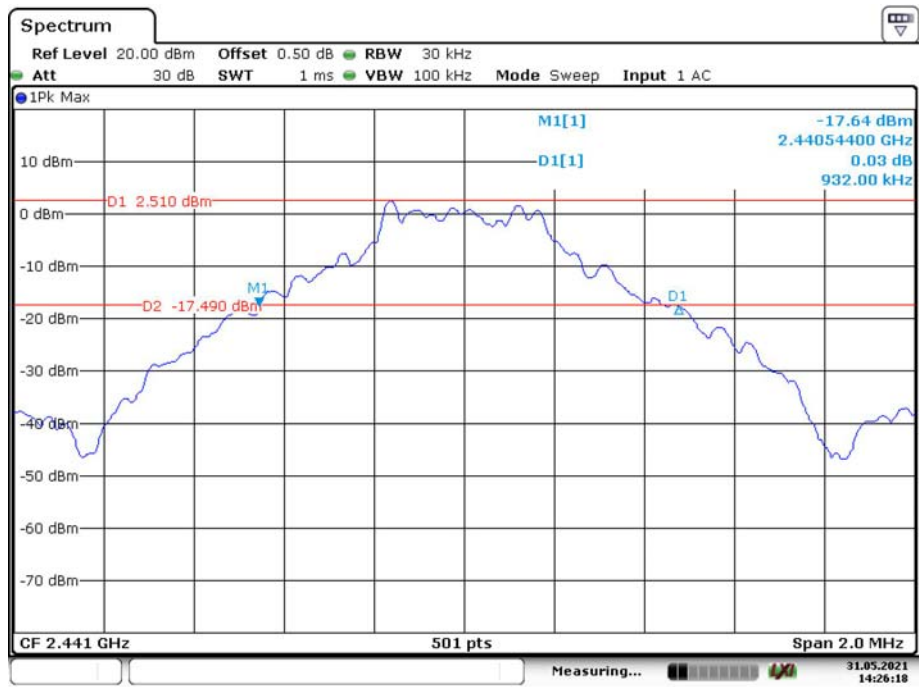

Date: 31.MAY.2021 14:26:19

High Channel

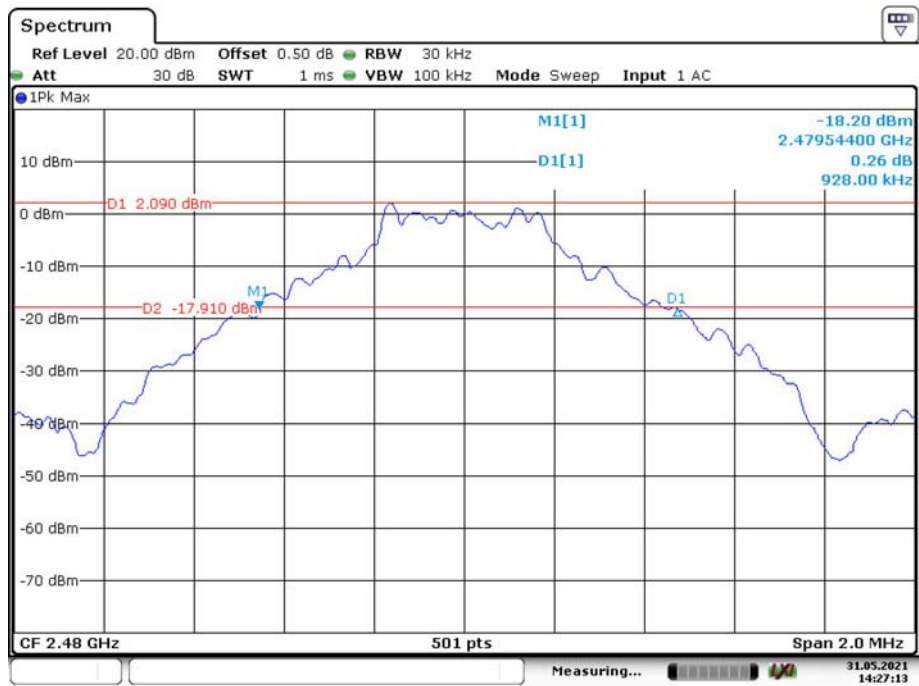

Date: 31.MAY.2021 14:27:14

EDR Mode ($\pi/4$ -DQPSK):

Low Channel

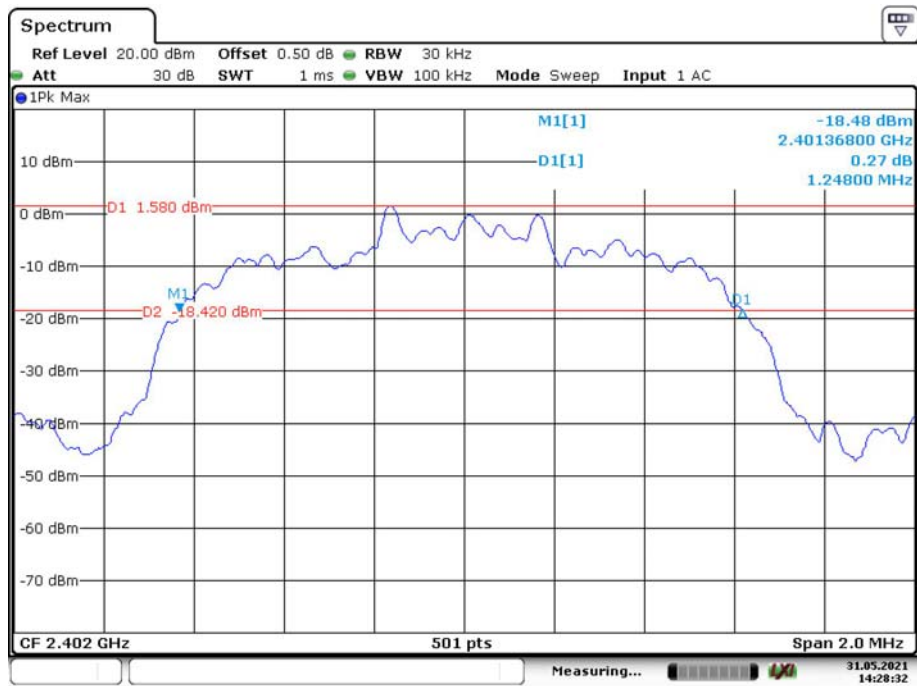

Date: 31.MAY.2021 14:28:33

Middle Channel

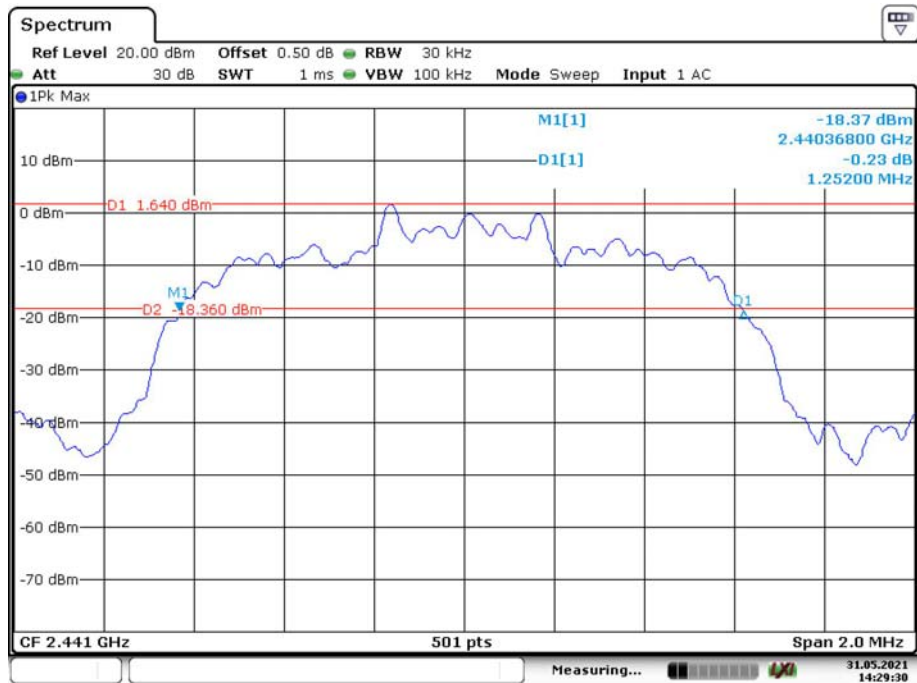

Date: 31.MAY.2021 14:29:30

High Channel

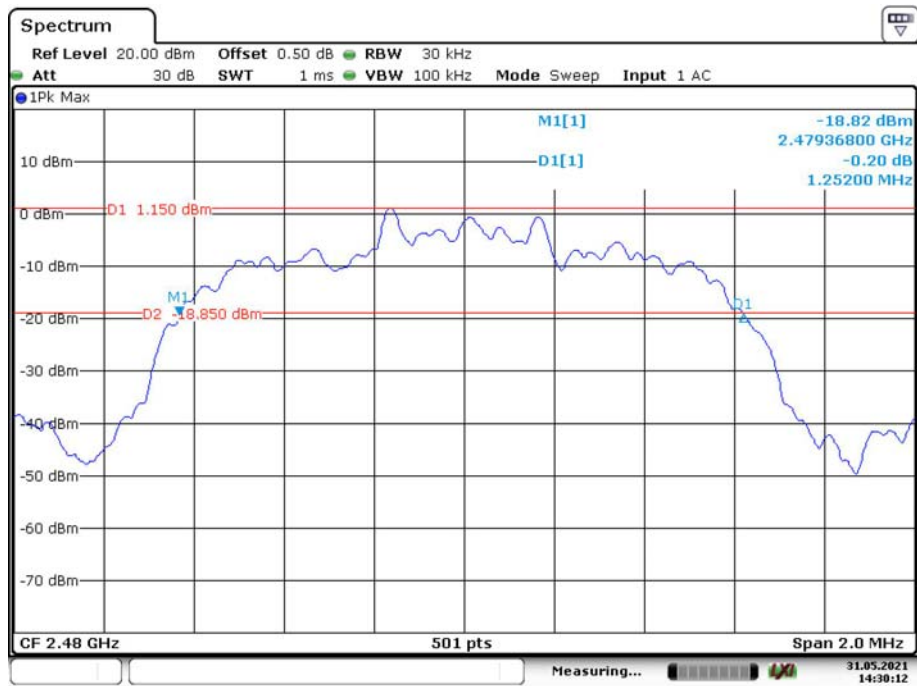

EDR Mode (8DPSK):

Low Channel

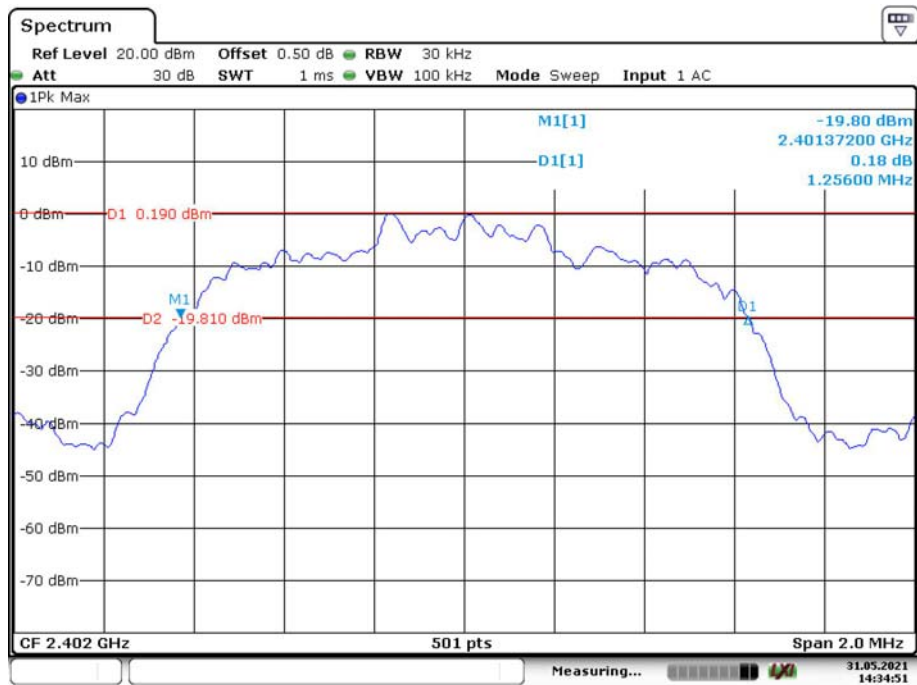

Middle Channel

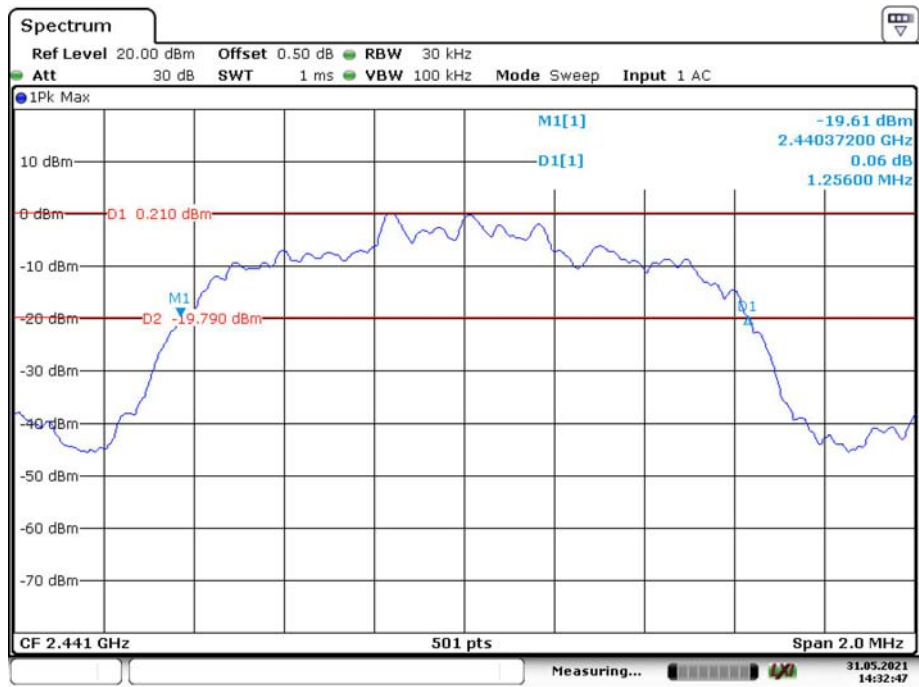

Date: 31.MAY.2021 14:32:48

High Channel

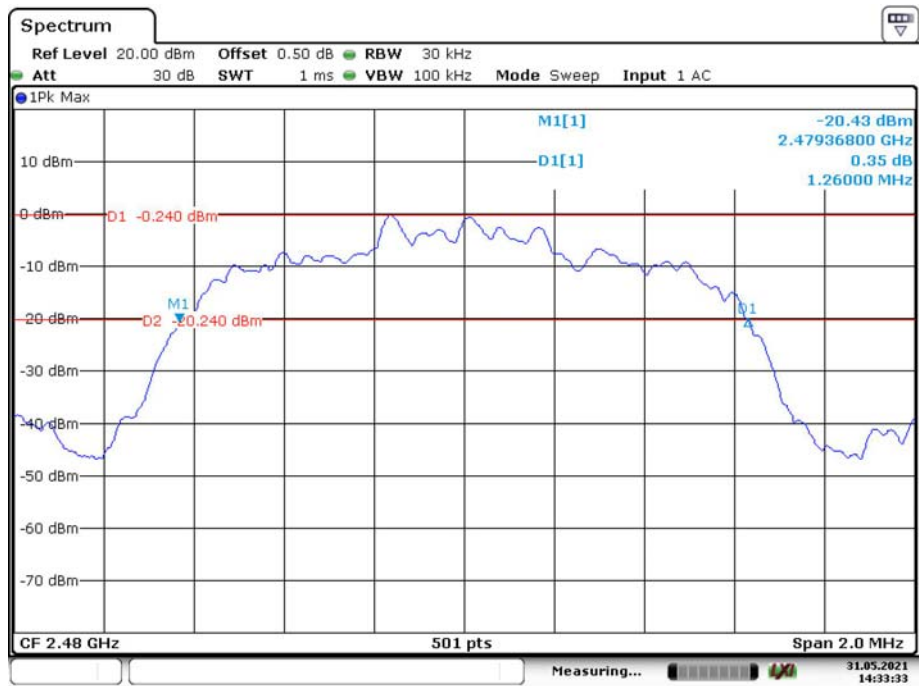

Date: 31.MAY.2021 14:33:34

FCC §15.247(a) (1) (iii) - QUANTITY OF HOPPING CHANNEL TEST

Applicable Standard

Frequency hopping systems in the 2400–2483.5 MHz band shall use at least 15 channels. The average time of occupancy on any channel shall not be greater than 0.4 seconds within a period of 0.4 seconds multiplied by the number of hopping channels employed. Frequency hopping systems may avoid or suppress transmissions on a particular hopping frequency provided that a minimum of 15 channels are used.

Test Procedure

1. Check the calibration of the measuring instrument (SA) using either an internal calibrator or a known signal from an external generator.
2. Set the EUT in hopping mode from first channel to last.
3. By using the Max-Hold function record the Quantity of the channel.

Test Equipment List and Details

Manufacturer	Description	Model	Serial Number	Calibration Date	Calibration Due Date
R&S	EMI Test Receiver	ESR3	102453	2020-09-12	2021-09-12
Unknown	Coaxial Cable	C-SJ00-0010	C0010/01	Each time	N/A

** Statement of Traceability: Bay Area Compliance Laboratories Corp. (Dongguan) attests that all calibrations have been performed, traceable to National Primary Standards and International System of Units (SI).*

Test Data

Environmental Conditions

Temperature:	27.5 °C
Relative Humidity:	46 %
ATM Pressure:	100kPa
Test by:	Joe Qiao
Test Date:	2021-05-31

Test Result: Compliance. Please refer to following tables and plots

Test Mode: Transmitting

Test mode	Frequency Range (MHz)	Number of Hopping Channel	Limit
GFSK	2400-2483.5	79	≥15
π/4-DQPSK	2400-2483.5	79	≥15
8DPSK	2400-2483.5	79	≥15

BDR Mode (GFSK)

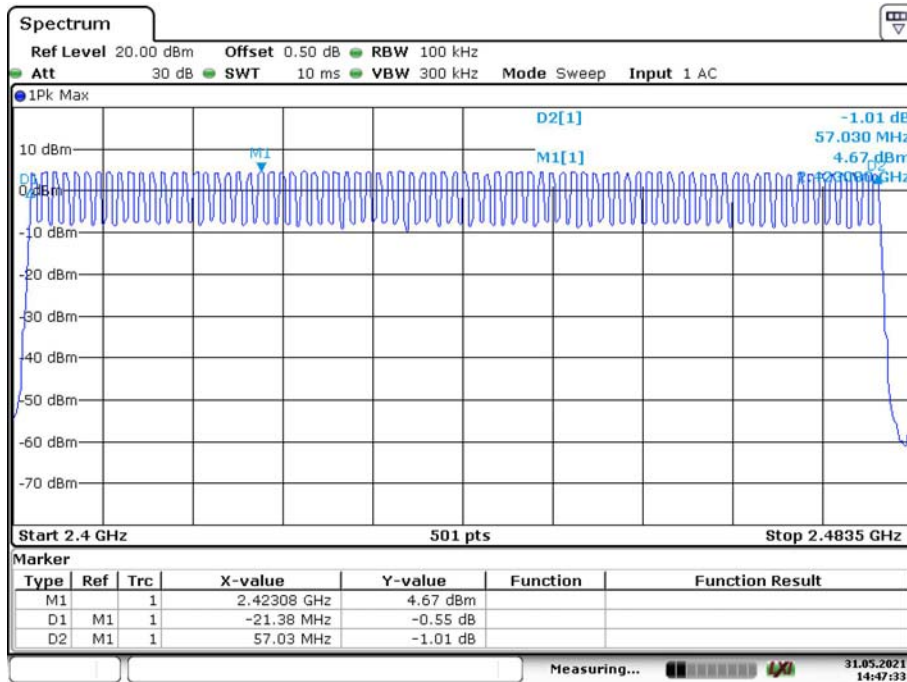

Date: 31.MAY.2021 14:47:34

EDR Mode ($\pi/4$ -DQPSK)

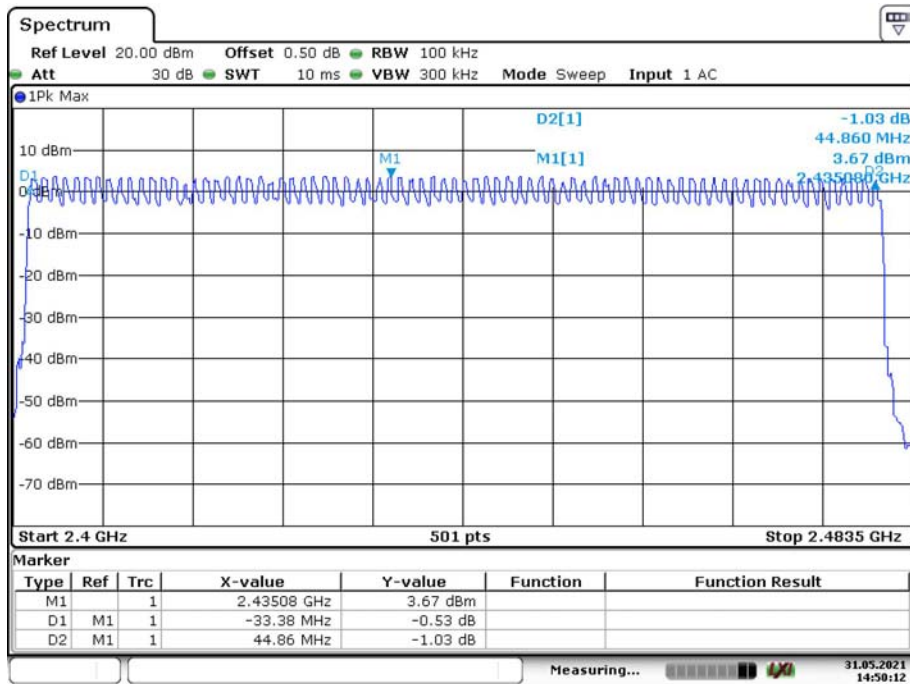

Date: 31.MAY.2021 14:50:12

EDR Mode (8DPSK)

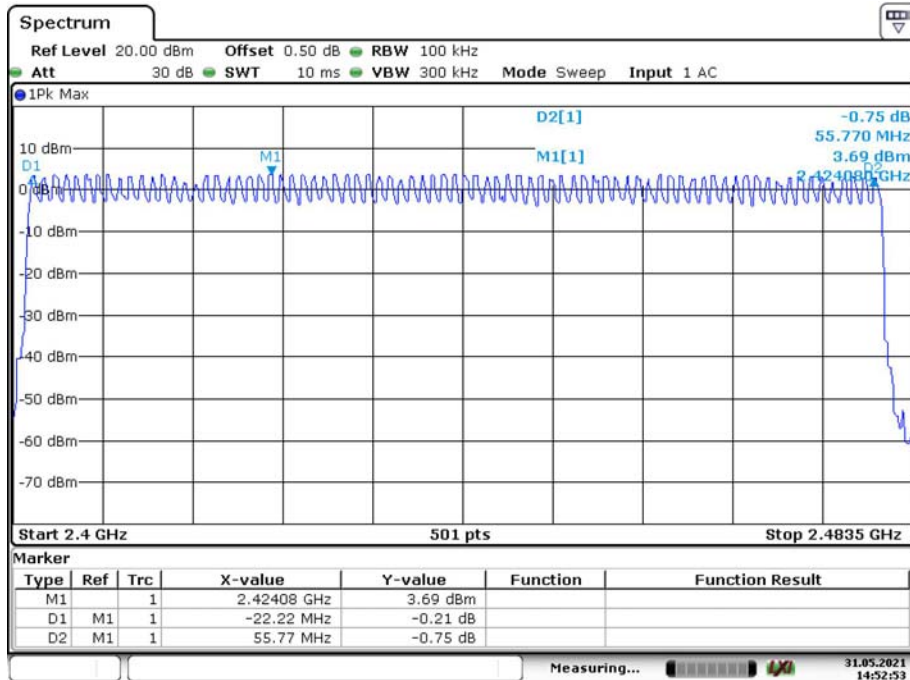

Date: 31.MAY.2021 14:52:53

FCC §15.247(a) (1) (iii) - TIME OF OCCUPANCY (DWELL TIME)

Applicable Standard

Frequency hopping systems in the 2400-2483.5 MHz shall use at least 15 channels. The average time of occupancy on any channel shall not be greater than 0.4 seconds within a period of 0.4 seconds multiplied by the number of hopping channels employed. Frequency hopping systems may avoid or suppress transmissions on a particular hopping frequency provided that a minimum of 15 channels are used.

Test Procedure

The EUT was worked in channel hopping; the time of single pulses was tested.

Test Equipment List and Details

Manufacturer	Description	Model	Serial Number	Calibration Date	Calibration Due Date
R&S	EMI Test Receiver	ESR3	102453	2020-09-12	2021-09-12
Unknown	Coaxial Cable	C-SJ00-0010	C0010/01	Each time	N/A

* *Statement of Traceability:* Bay Area Compliance Laboratories Corp. (Dongguan) attests that all calibrations have been performed, traceable to National Primary Standards and International System of Units (SI).

Test Data

Environmental Conditions

Temperature:	27.5°C
Relative Humidity:	46 %
ATM Pressure:	100kPa
Test by:	Joe Qiao
Test Date:	2021-05-31

Test Result: Compliance. Please refer to following tables and plots

Test Mode: Transmitting

Mode	Packet type	Channel	Frequency (MHz)	Pulse width (ms)	Result (s)	Limit (s)
GFSK	DH1	Middle	2441	0.411	0.132	0.4
	DH3	Middle	2441	1.659	0.265	
	DH5	Middle	2441	2.912	0.311	
$\pi/4$ -DQPSK	2DH1	Middle	2441	0.400	0.128	
	2DH3	Middle	2441	1.709	0.273	
	2DH5	Middle	2441	2.912	0.311	
8DPSK	3DH1	Middle	2441	0.403	0.129	
	3DH3	Middle	2441	1.687	0.270	
	3DH5	Middle	2441	2.925	0.312	

Note:
 DH1:Dwell time=Pulse time (ms) × (1600/2/79) ×31.6 s
 DH3:Dwell time=Pulse time (ms) × (1600/4/79) ×31.6 s
 DH5:Dwell time=Pulse time (ms) × (1600/6/79) ×31.6 s

BDR Mode (GFSK):

DH1: Middle Channel

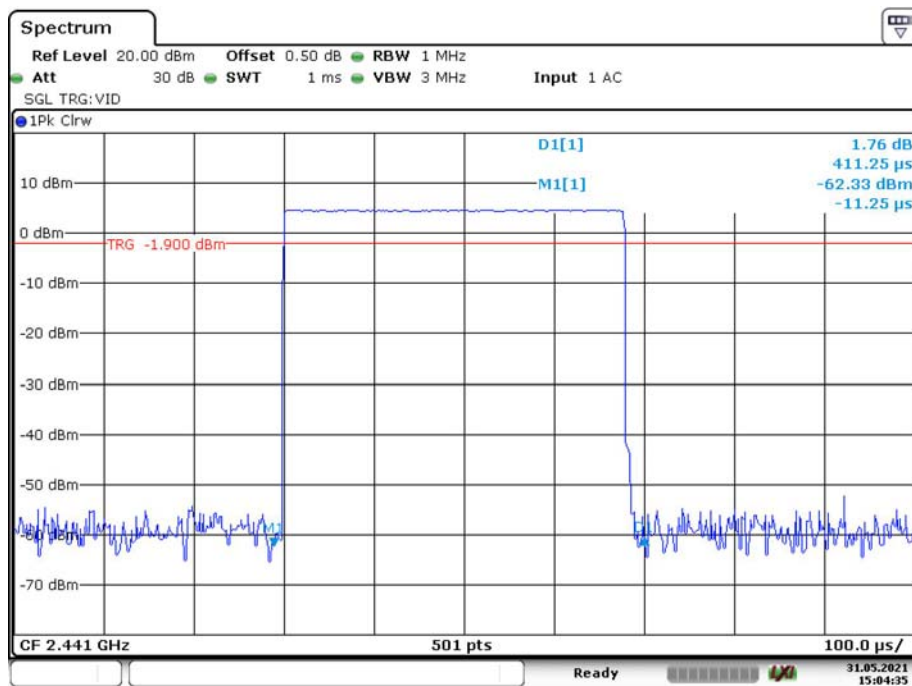

Date: 31.MAY.2021 15:04:35

DH3: Middle Channel

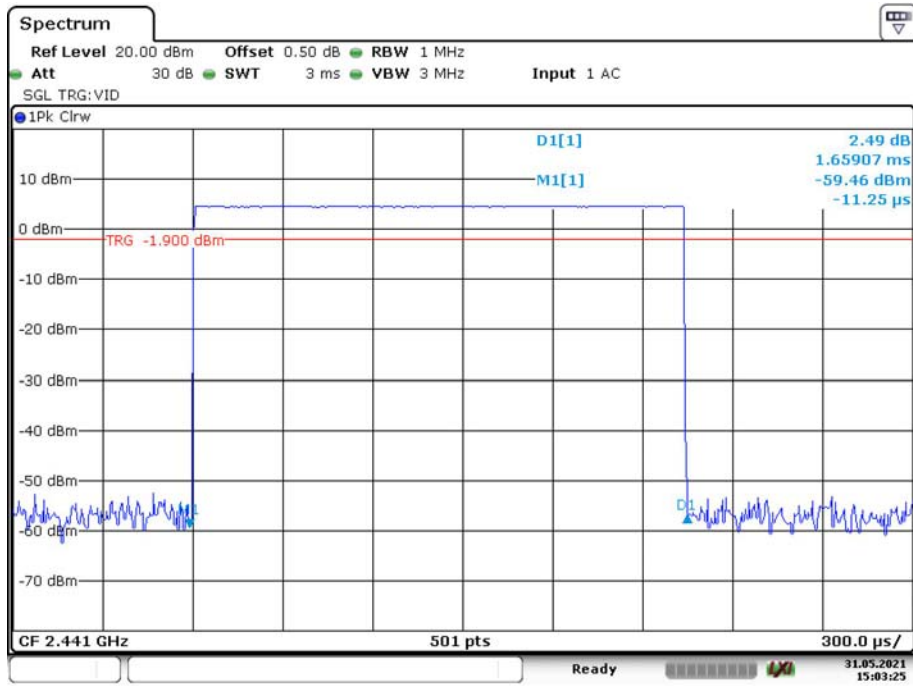

Date: 31.MAY.2021 15:03:25

DH5: Middle Channel

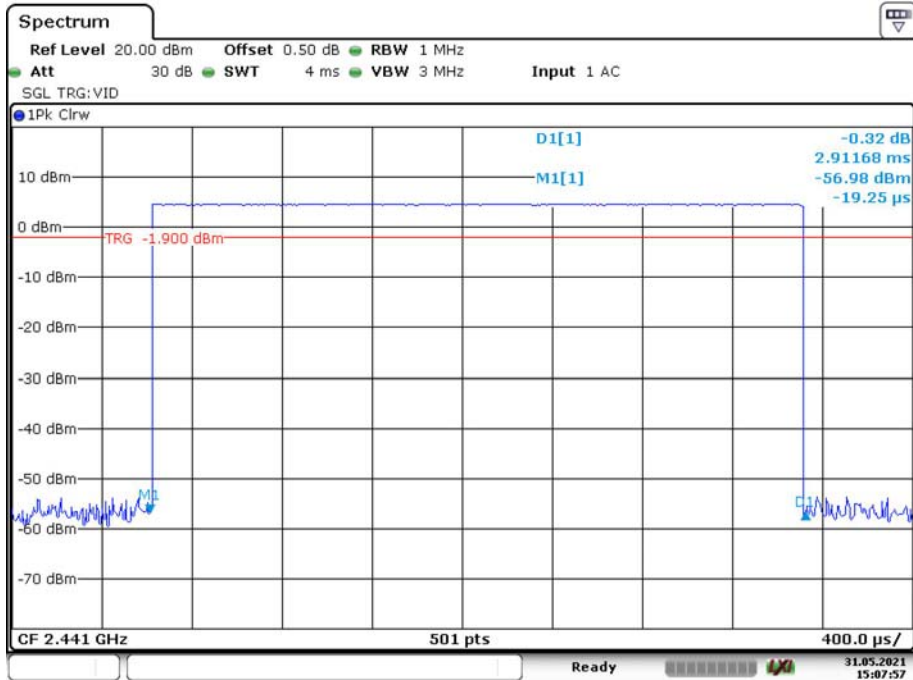

Date: 31.MAY.2021 15:07:58

EDR Mode ($\pi/4$ -DQPSK):

2DH1: Middle Channel

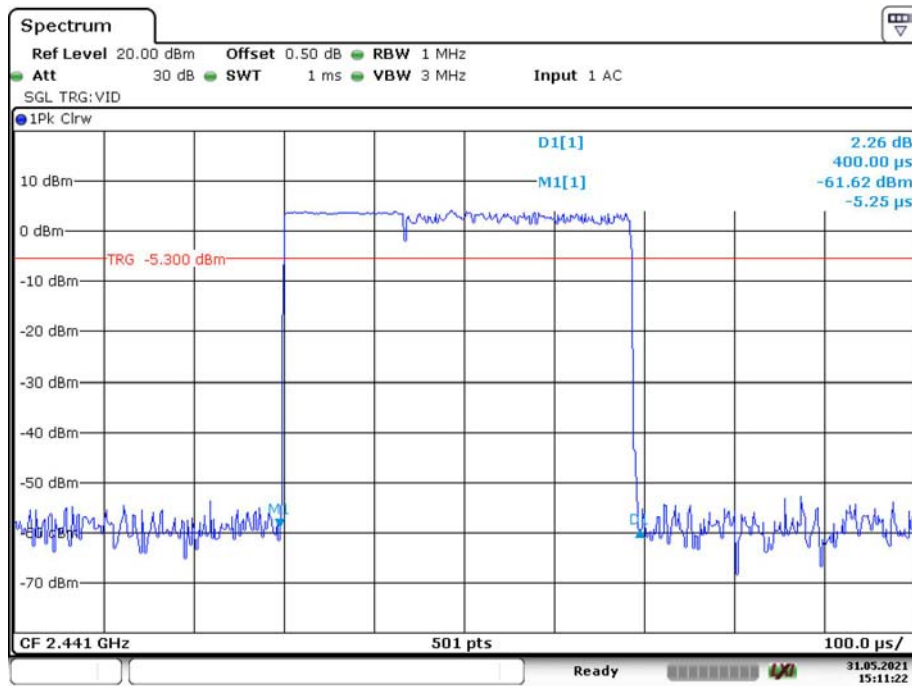

Date: 31.MAY.2021 15:11:22

2DH3: Middle Channel

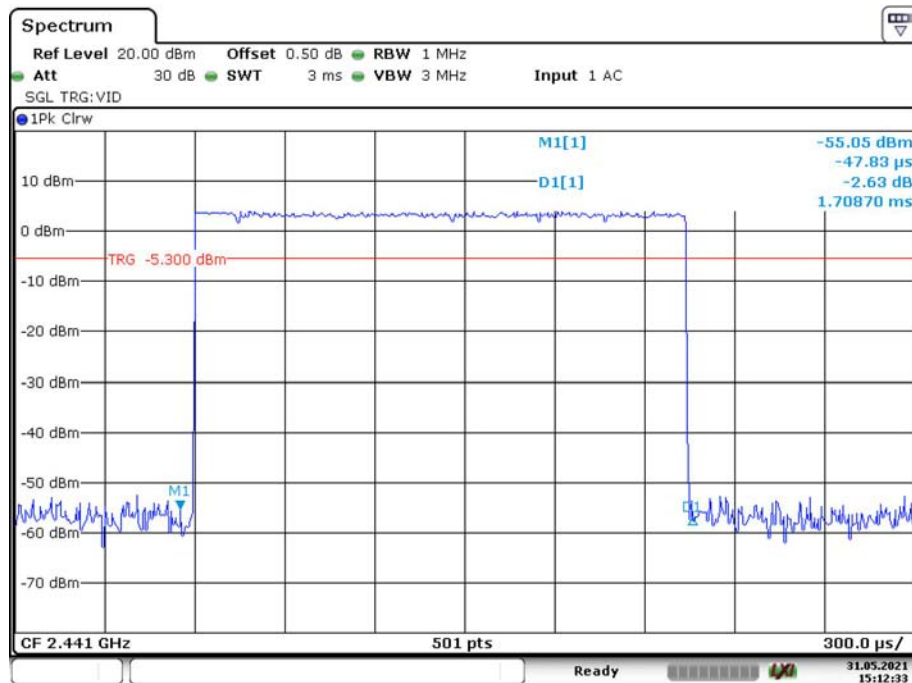

Date: 31.MAY.2021 15:12:34

2DH5: Middle Channel

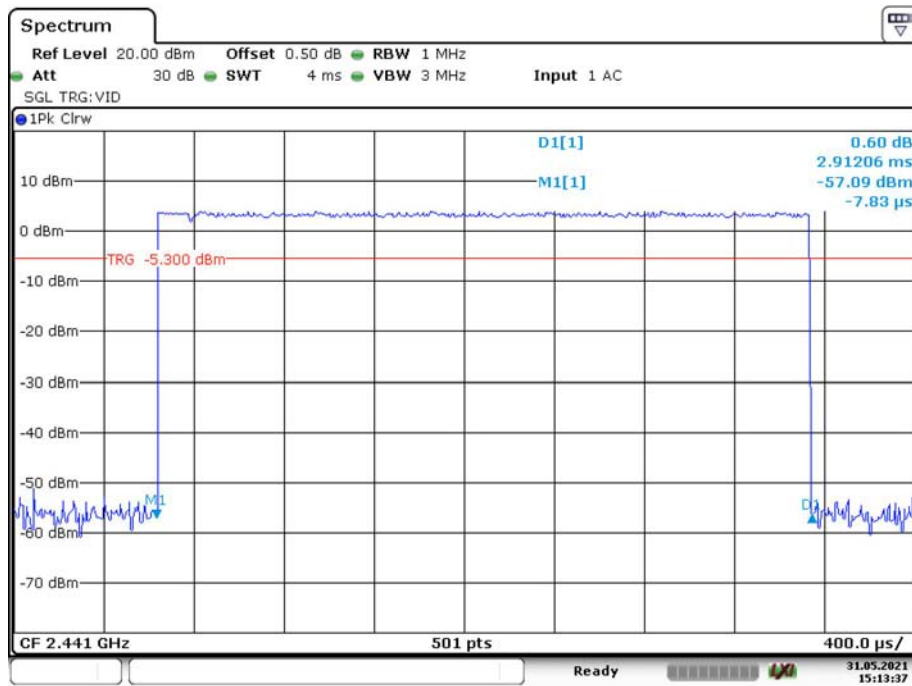

Date: 31.MAY.2021 15:13:37

EDR Mode (8DPSK):

3DH1: Middle Channel

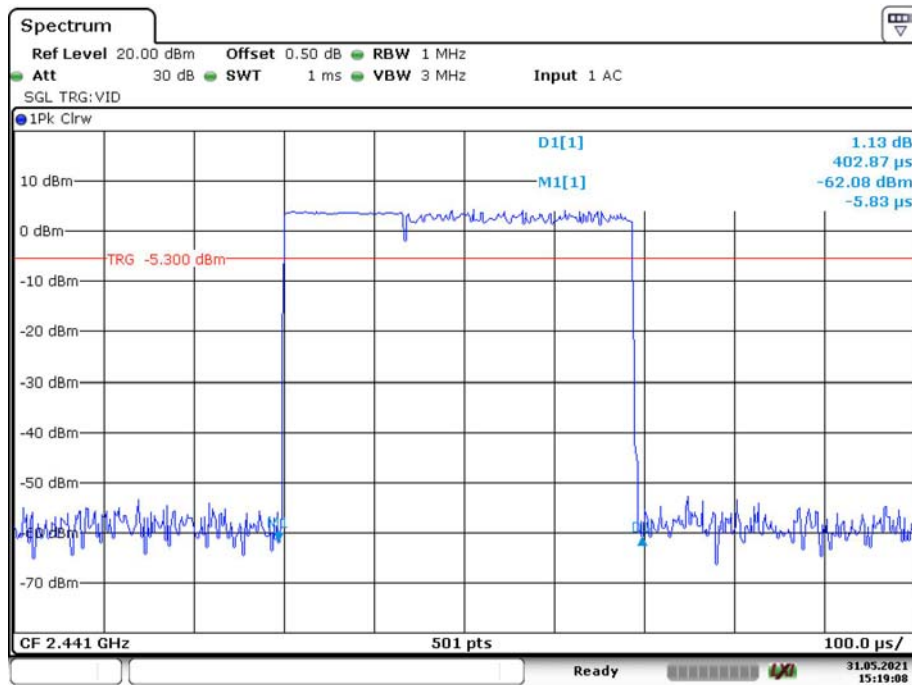

Date: 31.MAY.2021 15:19:09

3DH3: Middle Channel

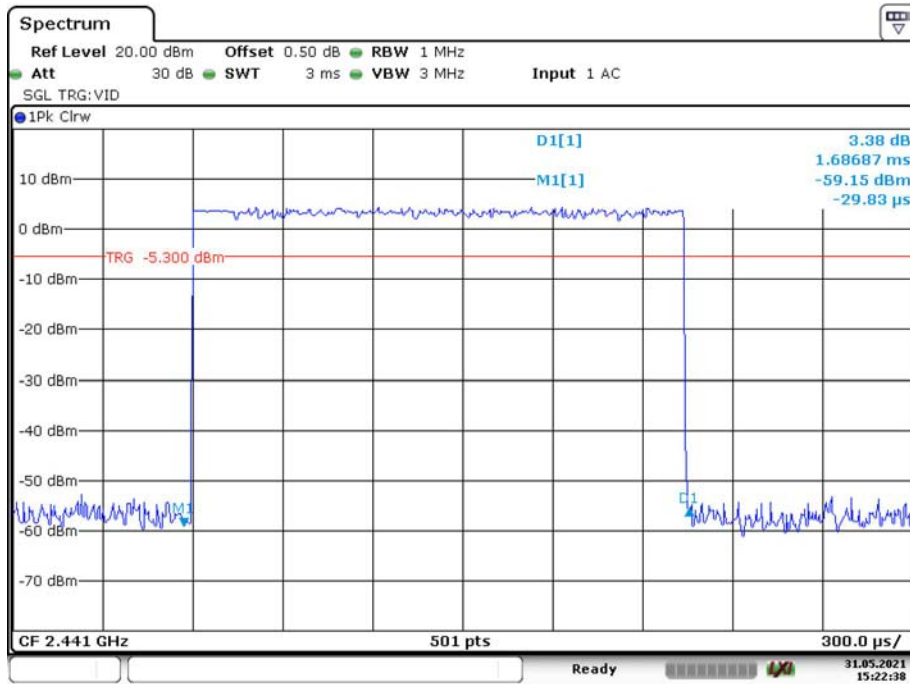

Date: 31.MAY.2021 15:22:39

3DH5: Middle Channel

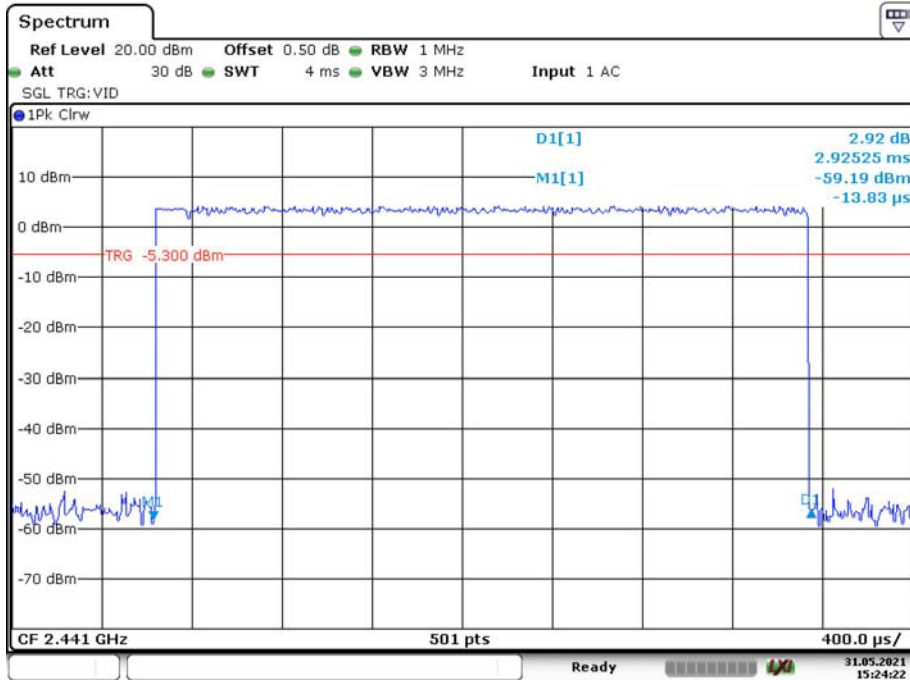

Date: 31.MAY.2021 15:24:23

FCC §15.247(b) (1) - PEAK OUTPUT POWER MEASUREMENT

Applicable Standard

According to §15.247(b) (1), for frequency hopping systems operating in the 2400–2483.5 MHz band employing at least 75 non-overlapping hopping channels, and all frequency hopping systems in the 5725–5850 MHz band: 1 watt. For all other frequency hopping systems in the 2400–2483.5 MHz band: 0.125 watts

Test Procedure

1. Place the EUT on a bench and set in transmitting mode.
2. Remove the antenna from the EUT and then connect a low loss RF cable from the antenna port to one test equipment.
3. Add a correction factor to the display.

Test Equipment List and Details

Manufacturer	Description	Model	Serial Number	Calibration Date	Calibration Due Date
E-Microwave	Coaxial Attenuators	EMCA10-5RN-6	OE01203239	2020-09-06	2021-09-06
Agilent	USB Wideband Power Sensor	U2022XA	MY5417006	2020-09-12	2021-09-12
ESPEC	Constant temperature and humidity Tester	ESX-4CA	018 463	2021-02-24	2022-02-23

* **Statement of Traceability:** Bay Area Compliance Laboratories Corp. (Dongguan) attests that all calibrations have been performed, traceable to National Primary Standards and International System of Units (SI).

Test Data

Environmental Conditions

Temperature:	27.5 °C
Relative Humidity:	46 %
ATM Pressure:	100kPa
Test by:	Joe Qiao
Test Date:	2021-05-31

Test Result: Compliance.

Test Mode: Transmitting

Mode	Test Frequency (MHz)	Peak Conducted Output Power (dBm)	Limit (dBm)
BDR Mode (GFSK)	2402	4.53	21
	2441	4.52	21
	2480	4.17	21
EDR Mode ($\pi/4$ -DQPSK)	2402	3.65	21
	2441	3.68	21
	2480	3.25	21
EDR Mode (8DPSK)	2402	3.64	21
	2441	3.67	21
	2480	3.28	21

Note: The data above was tested in conducted mode.

FCC §15.247(d) - BAND EDGES TESTING

Applicable Standard

In any 100 kHz bandwidth outside the frequency band in which the spread spectrum or digitally modulated intentional radiator is operating, the radio frequency power that is produced by the intentional radiator shall be at least 20 dB below that in the 100 kHz bandwidth within the band that contains the highest level of the desired power, based on either an RF conducted or a radiated measurement, provided the transmitter demonstrates compliance with the peak conducted power limits. If the transmitter complies with the conducted power limits based on the use of RMS averaging over a time interval, as permitted under paragraph (b)(3) of this section, the attenuation required under this paragraph shall be 30 dB instead of 20 dB. Attenuation below the general limits specified in §15.209(a) is not required. In addition, radiated emissions which fall in the restricted bands, as defined in §15.205(a), must also comply with the radiated emission limits specified in §15.209(a) (see §15.205(c)).

Test Procedure

1. Check the calibration of the measuring instrument using either an internal calibrator or a known signal from an external generator.
2. Remove the antenna from the EUT and then connect to a low loss RF cable from the antenna port to a EMI test receiver, then turn on the EUT and make it operate in transmitting mode. Then set it to Low Channel and High Channel within its operating range, and make sure the instrument is operated in its linear range.
3. Set RBW/ VBW of spectrum analyzer to 100/300 kHz with a convenient frequency span including 100 kHz bandwidth from band edge.
4. Measure the highest amplitude appearing on spectral display and set it as a reference level. Plot the graph with marking the highest point and edge frequency.
5. Repeat above procedures until all measured frequencies were complete.

Test Equipment List and Details

Manufacturer	Description	Model	Serial Number	Calibration Date	Calibration Due Date
R&S	EMI Test Receiver	ESR3	102453	2020-09-12	2021-09-12
Unknown	Coaxial Cable	C-SJ00-0010	C0010/01	Each time	N/A

* **Statement of Traceability:** Bay Area Compliance Laboratories Corp. (Dongguan) attests that all calibrations have been performed, traceable to National Primary Standards and International System of Units (SI).

Test Data

Environmental Conditions

Temperature:	27.5°C
Relative Humidity:	46 %
ATM Pressure:	100kPa
Test by:	Joe Qiao
Test Date:	2021-05-31

Test Result: Compliance

Single Channel Mode,
BDR Mode (GFSK):

Band Edge, Left Side

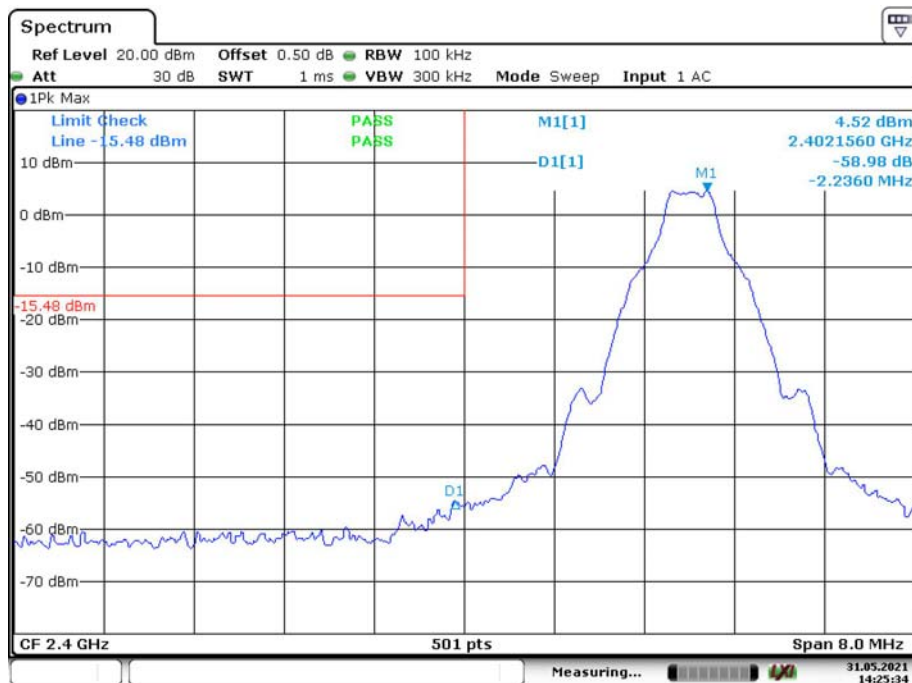

Date: 31.MAY.2021 14:25:35

Band Edge, Right Side

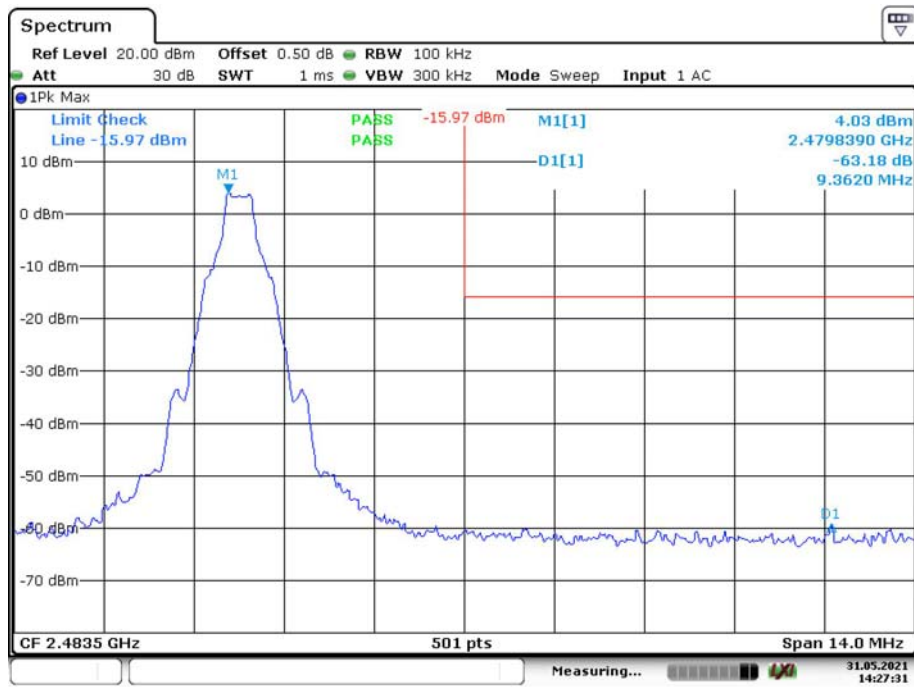

EDR Mode ($\pi/4$ -DQPSK):

Band Edge, Left Side

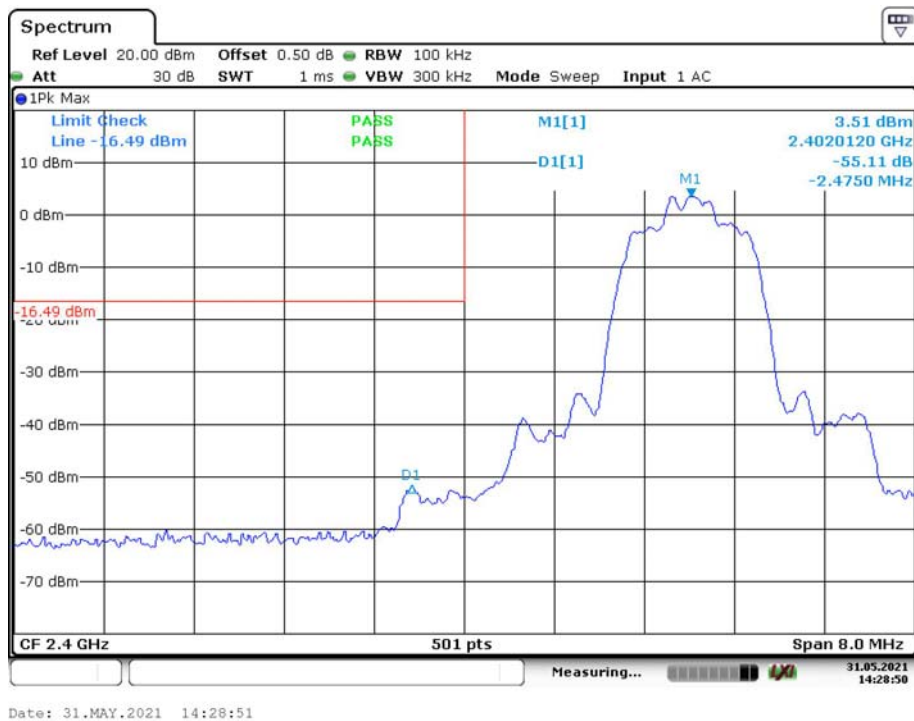

Band Edge, Right Side

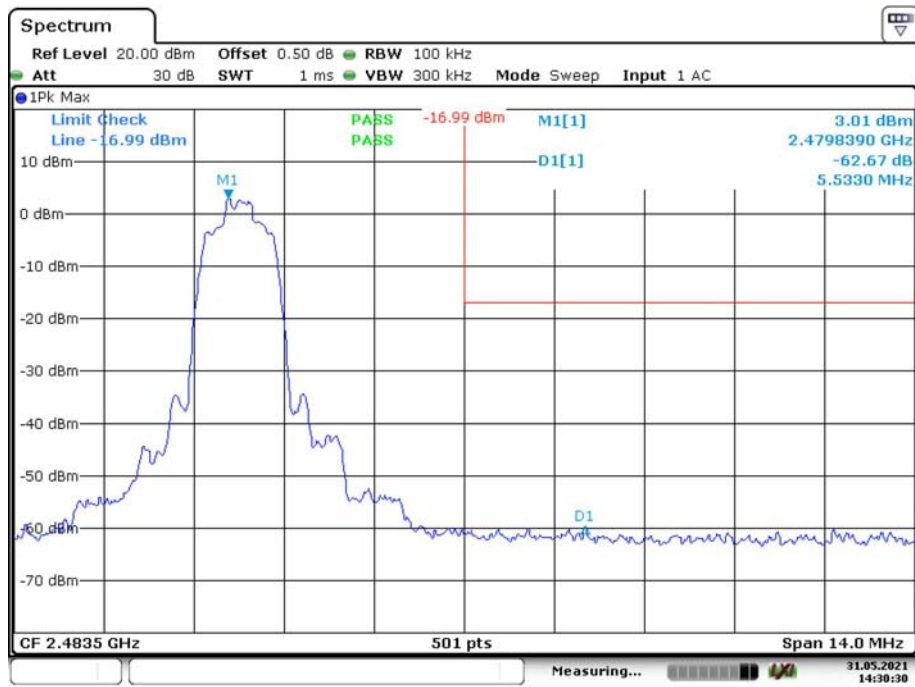

Date: 31.MAY.2021 14:30:31

EDR Mode (8DPSK):

Band Edge, Left Side

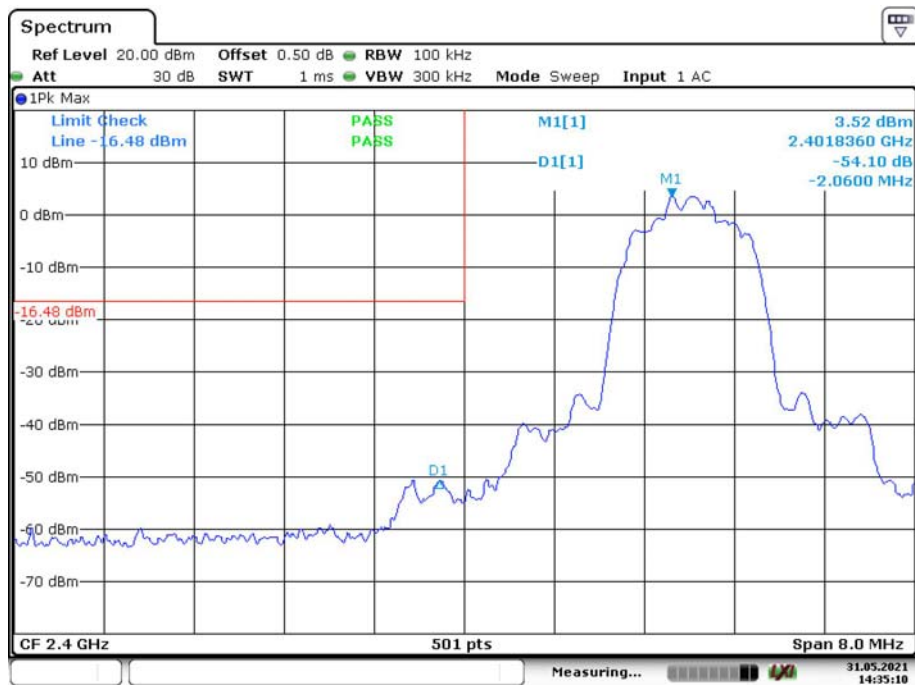

Date: 31.MAY.2021 14:35:11

Band Edge, Right Side

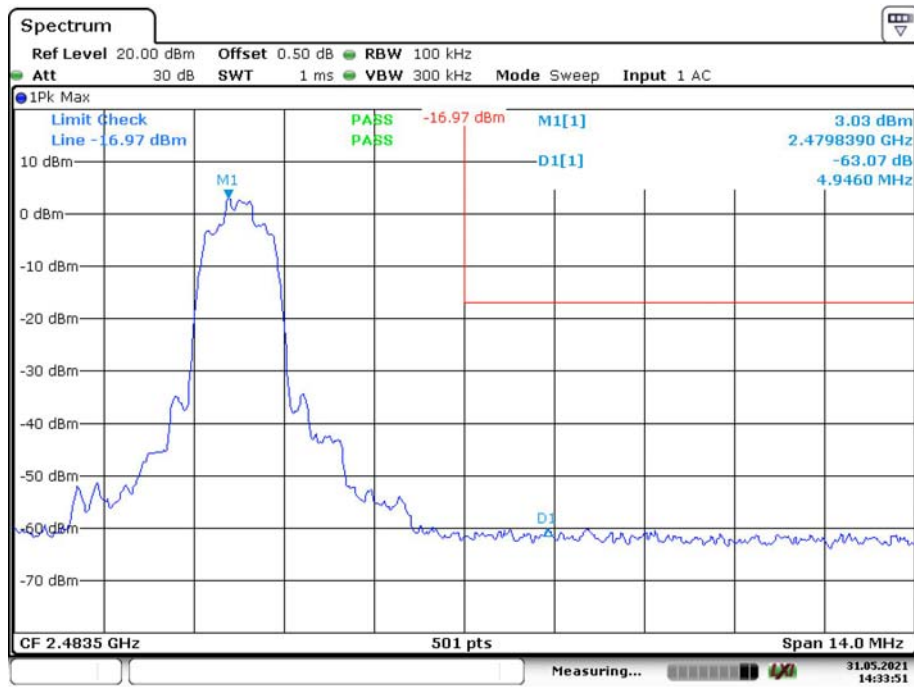

*Hopping Mode,
 BDR Mode (GFSK):*

Band Edge, Left Side

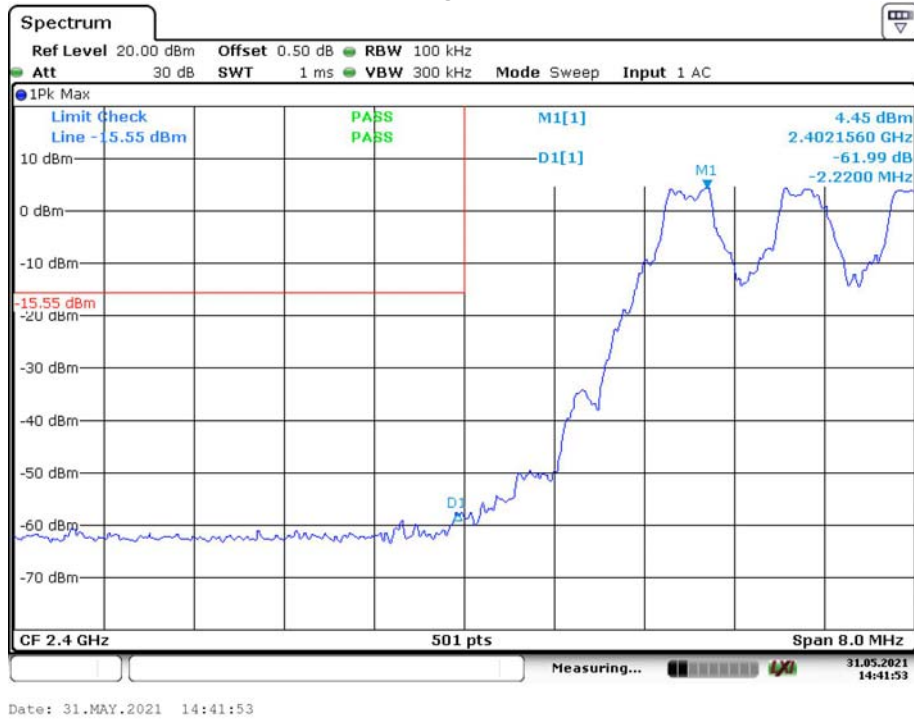

Band Edge, Right Side

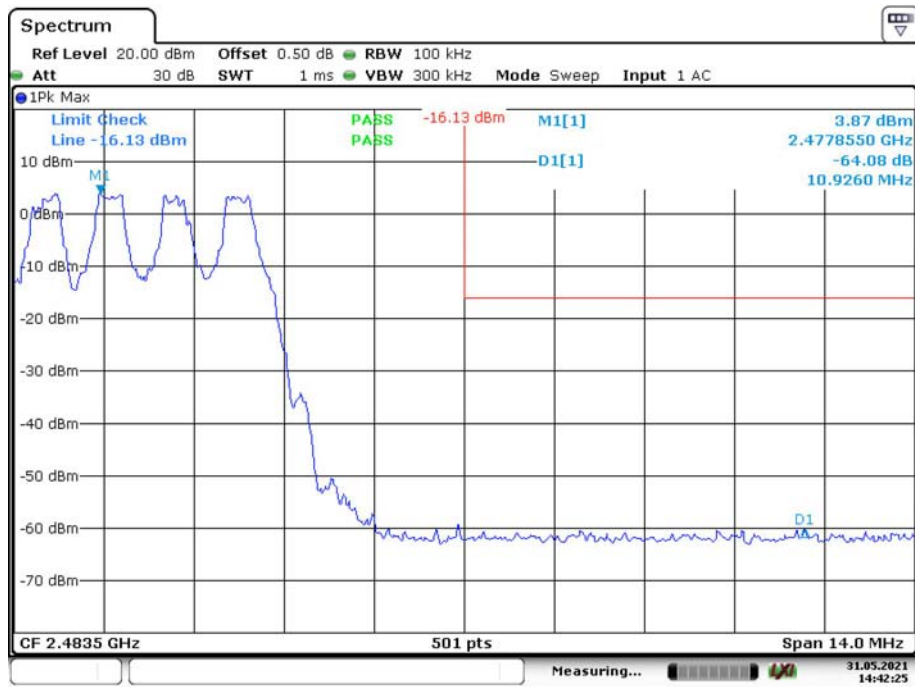

EDR Mode ($\pi/4$ -DQPSK):

Band Edge, Left Side

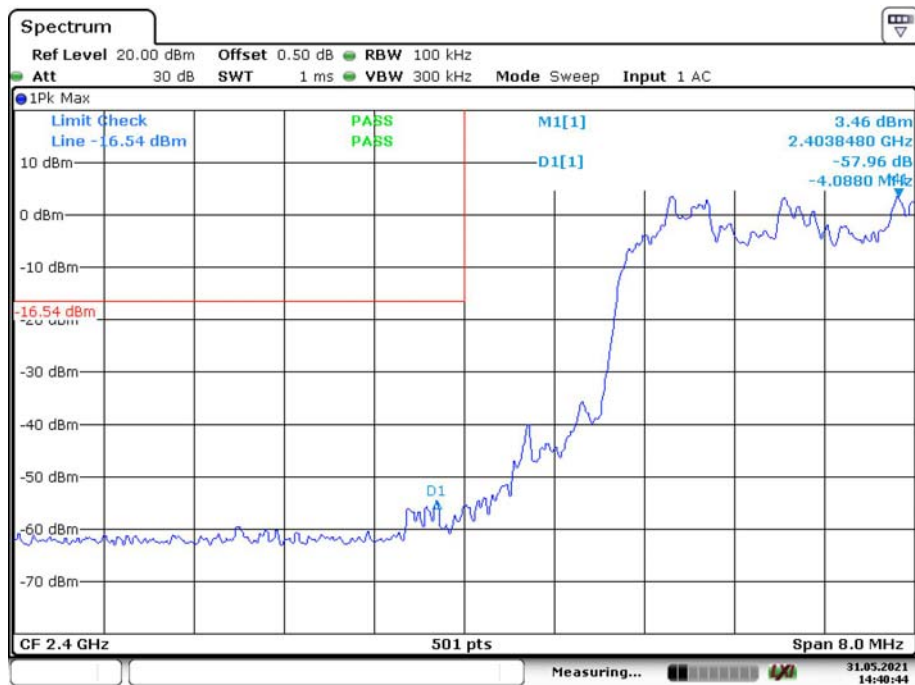

Band Edge, Right Side

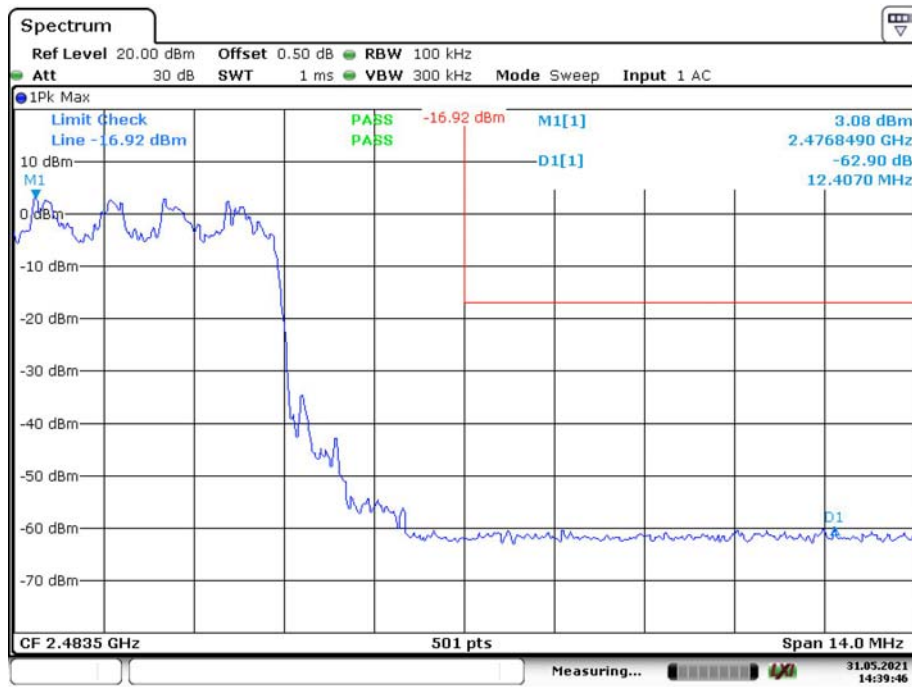

Date: 31.MAY.2021 14:39:46

EDR Mode (8DPSK):

Band Edge, Left Side

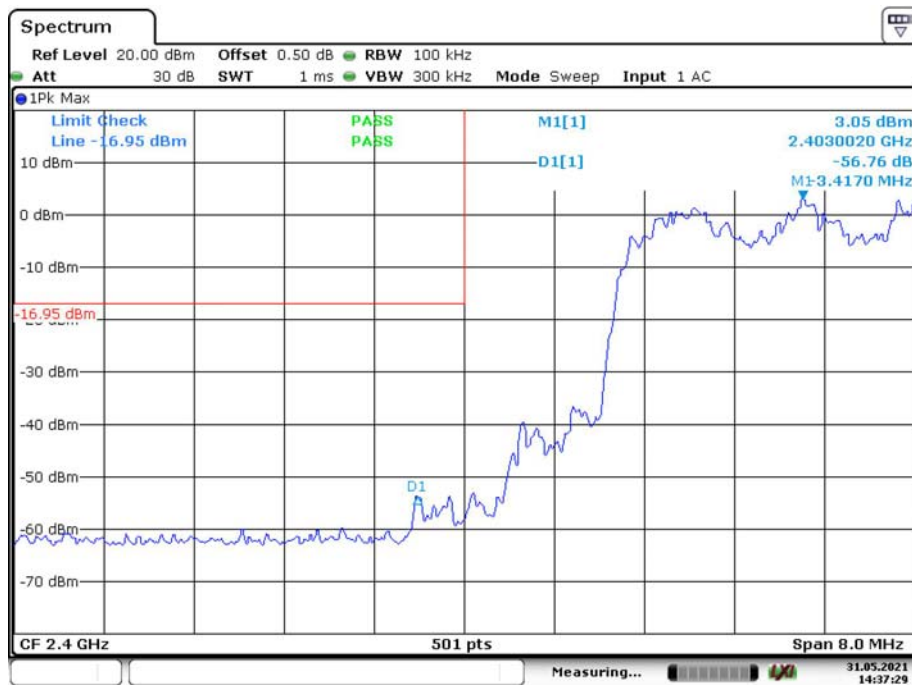

Date: 31.MAY.2021 14:37:30

Band Edge, Right Side

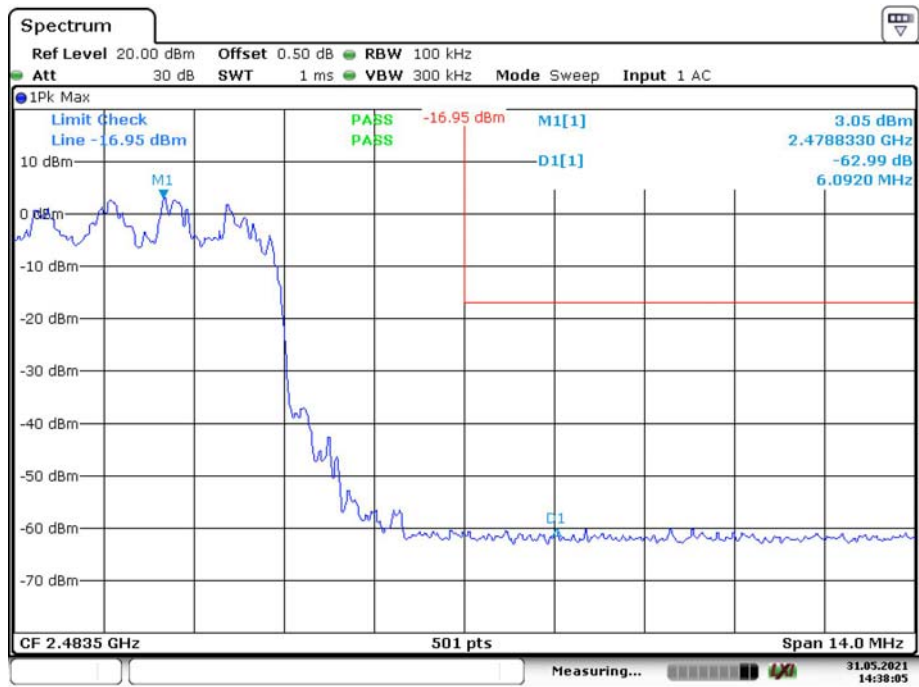

Date: 31.MAY.2021 14:38:06

**** END OF REPORT ****