



# FCC Test Report

**Test Report  
On Behalf of  
Shenzhen Xiangdangwen Technology Co.,Ltd.  
For  
Line Metal Magnetic Wireless Car Charger  
Model No.: 2E746  
FCC ID: 2AW73-2E746**

**Prepared For:** Shenzhen Xiangdangwen Technology Co.,Ltd.  
106, 1/F, No.313-4 Building, Huachang Road, Langkou Community, Dalang  
Street, Longhua District, Shenzhen, China

**Prepared By:** Shenzhen HUAK Testing Technology Co., Ltd.  
1-2/F., Building B2, Junfeng Zhongcheng Zhizao Innovation Park, Heping,  
Fuhai Street, Bao'an District, Shenzhen, Guangdong, China

**Date of Test:** May 04, 2023 ~ May 26, 2023

**Date of Report:** May 26, 2023

**Report Number:** HK2305041697-1E



### Test Result Certification

**Applicant's Name**..... : Shenzhen Xiangdangwen Technology Co.,Ltd.  
**Address**..... : 106, 1/F, No.313-4 Building, Huachang Road, Langkou Community, Dalang Street, Longhua District, Shenzhen, China  
**Manufacture's Name**..... : Huizhou Yimai Electronics Technology Co., Ltd.  
**Address**..... : 3rd Floor, Building B, Huakai High-tech Industrial Park, Electronic City Road, Longxi Street, Boluo Country, Huizhou, China

#### Product Description

**Trade Mark**..... : LISEN, AINOPE, VEICO  
**Product Name**..... : Line Metal Magnetic Wireless Car Charger  
**Model and/or Type Reference**: 2E746

**Standards** ..... : FCC CFR 47 PART 18

This publication may be reproduced in whole or in part for non-commercial purposes as long as the Shenzhen HUAK Testing Technology Co., Ltd. is acknowledged as copyright owner and source of the material. Shenzhen HUAK Testing Technology Co., Ltd. takes no responsibility for and will not assume liability for damages resulting from the reader's interpretation of the reproduced material due to its placement and context.

**Date of Test**..... :  
**Date (s) of Performance of Tests** ..... : **May 04, 2023 ~ May 26, 2023**  
**Date of Issue**..... : **May 26, 2023**  
**Test Result**..... : **Pass**

Testing Engineer : Gary Qian  
 (Gary Qian)

Technical Manager : Eden Hu  
 (Eden Hu)

Authorized Signatory : Jason Zhou  
 (Jason Zhou)

The results shown in this test report refer only to the sample(s) tested unless otherwise stated and the sample(s) are retained for 30 days only. The document is issued by HUAK, this document cannot be reproduced except in full with our prior written permission. The more details and the authenticity of the report will be confirmed at <http://www.cer-mark.com>.



**Table of Contents**

**Page**

1 . Test Summary	5
1.1 . Test Procedures and Results	5
1.2 . Information of the Test Laboratory	5
1.3 . Measurement Uncertainty	5
2. General Information	6
2.1. General Description of EUT	6
2.2. Carrier Frequency of Channels	7
2.3. Operation of EUT during Testing	7
2.4. Description of Test Setup	8
2.5. Measurement Instruments List	9
3. Conducted Emission Test	10
3.1. Block Diagram of Test Setup	10
3.2. Conducted Power Line Emission Limit	10
3.3. Test Procedure	10
3.4. Test Result	11
4. Radiated Emissions	13
4.1. Block Diagram of Test Setup	13
4.2. Rules and Specifications	14
4.3. Test Procedure	14
4.4. Test Result	14
5. Antenna Requirement	18
6. Photograph of Test	19
7. Photos of the EUT	21



**\*\* Modified History \*\***

<b>Revision</b>	<b>Description</b>	<b>Issued Data</b>	<b>Remark</b>
Revision 1.0	Initial Test Report Release	May 26, 2023	Jason Zhou



### 1. Test Summary

#### 1.1. Test Procedures and Results

Description of Test	Section Number	Result
Conducted Emissions Test	18.307	COMPLIANT
Radiated Emission Test	18.305	COMPLIANT

**Note:**

- 1. PASS: Test item meets the requirement.
- 2. Fail: Test item does not meet the requirement.
- 3. N/A: Test case does not apply to the test object.
- 4. The test result judgment is decided by the limit of test standard.

#### 1.2. Information of the Test Laboratory

Shenzhen HUAK Testing Technology Co., Ltd.  
 Add.: 1-2/F., Building B2, Junfeng Zhongcheng Zhizao Innovation Park, Heping,  
 Fuhai Street, Bao'an District, Shenzhen, Guangdong, China

Testing Laboratory Authorization :  
 A2LA Accreditation Code is 4781.01.  
 FCC Designation Number is CN1229.  
 Canada IC CAB identifier is CN0045.  
 CNAS Registration Number is L9589.

#### 1.3. Measurement Uncertainty

Measurement Uncertainty	
Conducted Emission Expanded Uncertainty	= 2.71dB, k=2
Radiated emission expanded uncertainty(9kHz-30MHz)	= 3.90dB, k=2
Radiated emission expanded uncertainty(30MHz-1000MHz)	= 3.90dB, k=2
Radiated emission expanded uncertainty(Above 1GHz)	= 4.28dB, k=2



2. General Information

2.1. General Description of EUT

Equipment:	Line Metal Magnetic Wireless Car Charger
Model Name:	2E746
Series Models:	N/A
Model Difference:	N/A
Trade Mark:	LISEN, AINOPE, VEICO
FCC ID:	<b>2AW73-2E746</b>
Antenna Type:	Coil Antenna
Antenna Gain:	0dBi
Operation Frequency:	112KHz~205KHz
Test Frequency:	128KHz
Number of Channels:	1
Modulation Type:	ASK
Power Source:	Input: DC5V/3A, 9V/3A Output: 5W/7.5W/10W/15W
Power Rating:	Input: DC5V/3A, 9V/3A Output: 5W/7.5W/10W/15W

The results shown in this test report refer only to the sample(s) tested unless otherwise stated and the sample(s) are retained for 30 days only. The document is issued by HUAK, this document cannot be reproduced except in full with our prior written permission. The more details and the authenticity of the report will be confirmed at <http://www.cer-mark.com>.

TEL : +86-755 2302 9901 FAX : +86-755 2302 9901 E-mail : [service@cer-mark.com](mailto:service@cer-mark.com)

Add: 1-2F., Building B2, Junfeng Zhongcheng Zhizao Innovation Park, Heping Community, Fuhai Street, Bao'an District, Shenzhen, Guangdong, China



### 2.2. Carrier Frequency of Channels

Operation Frequency each of channel	
Channel	Frequency
1	128KHz

### 2.3. Operation of EUT during Testing

Operating Mode

The mode is used: Transmitting mode



### 2.4. Description of Test Setup

Operation of EUT during Testing:

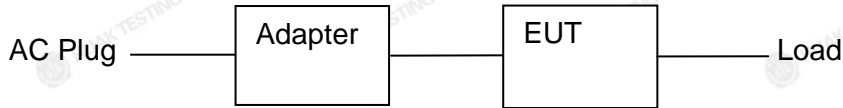

#### Adapter information

Model: CD289

Input: AC100-240V, 50/60Hz, 2A Max

USB-C1 Output: DC5V/3A, 9V/3A, 12V/3A, 15V/3A, 20V/5A, 28V/5A 140W MAX

USB-C2 Output: DC5V/3A, 9V/3A, 12V/3A, 15V/3A, 20V/5A 100W MAX

USB-A Output: DC5V/4.5A, 4.5V/5A, 5V/3A, 9V/2A, 12V/1.5A 22.5W MAX

Total Output: 140W Max

The sample was placed (0.8m (30MHz~1GHz), 0.8m (9KHz~30MHz)) above the ground plane of 3m chamber. Measurements in both horizontal and vertical polarities were performed. During the test, each emission was maximized by: having the EUT continuously working, investigated all operating modes, rotated about all 3 axis (X, Y & Z) and considered typical configuration to obtain worst position, manipulating interconnecting cables, rotating the turntable, varying antenna height from 1m to 4m in both horizontal and vertical polarizations. The emissions worst-case are shown in Test Results of the following pages. The worst case is X position.



**2.5. Measurement Instruments List**

Item	Equipment	Manufacturer	Model No.	Serial No.	Last Cal.	Cal. Interval
1.	L.I.S.N. Artificial Mains Network	R&S	ENV216	HKE-002	Feb. 17, 2023	1 Year
2.	Receiver	R&S	ESR-7	HKE-005	Feb. 17, 2023	1 Year
3.	RF automatic control unit	Tonscend	JS0806-2	HKE-060	Feb. 17, 2023	1 Year
4.	Spectrum analyzer	R&S	FSP40	HKE-025	Feb. 17, 2023	1 Year
5.	Spectrum analyzer	Agilent	N9020A	HKE-048	Feb. 17, 2023	1 Year
6.	Preamplifier	Schwarzbeck	BBV 9743	HKE-006	Feb. 17, 2023	1 Year
7.	EMI Test Receiver	Rohde & Schwarz	ESR-7	HKE-010	Feb. 17, 2023	1 Year
8.	Bilog Broadband Antenna	Schwarzbeck	VULB9163	HKE-012	Feb. 17, 2023	1 Year
9.	Loop Antenna	Schwarzbeck	FMZB 1519 B	HKE-014	Feb. 17, 2023	1 Year
10.	Horn Antenna	Schwarzbeck	9120D	HKE-013	Feb. 17, 2023	1 Year
11.	Pre-amplifier	EMCI	EMC051845 SE	HKE-015	Feb. 17, 2023	1 Year
12.	Pre-amplifier	Agilent	83051A	HKE-016	Feb. 17, 2023	1 Year
13.	EMI Test Software EZ-EMC	Tonscend	JS1120-B Version	HKE-083	N/A	N/A
14.	Power Sensor	Agilent	E9300A	HKE-086	Feb. 17, 2023	1 Year
15.	Spectrum analyzer	Agilent	N9020A	HKE-048	Feb. 17, 2023	1 Year
16.	Signal generator	Agilent	N5182A	HKE-029	Feb. 17, 2023	1 Year
17.	Signal Generator	Agilent	83630A	HKE-028	Feb. 17, 2023	1 Year
18.	Shielded room	Shiel Hong	4*3*3	HKE-039	Dec. 09, 2021	3 Year



### 3. Conducted Emission Test

#### 3.1. Block Diagram of Test Setup

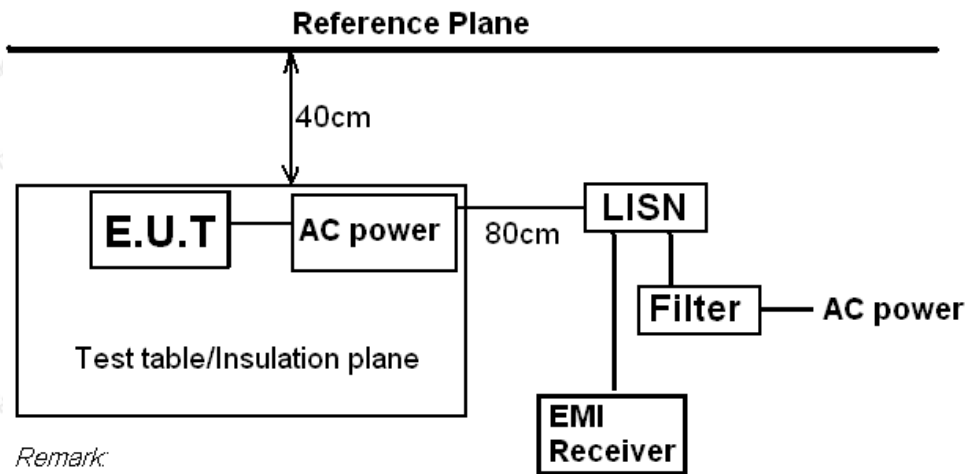

*Remark:*  
 E.U.T: Equipment Under Test  
 LISN: Line Impedance Stabilization Network  
 Test table height=0.8m

#### 3.2. Conducted Power Line Emission Limit

According to FCC Part 18.307(b)

Frequency (MHz)	Maximum RF Line Voltage (dBμV)			
	CLASS A		CLASS B	
	Q.P.	Ave.	Q.P.	Ave.
0.15 - 0.50	79	66	66-56*	56-46*
0.50 - 5.00	73	60	56	46
5.00 - 30.0	73	60	60	50

\* Decreasing linearly with the logarithm of the frequency

For intentional device, according to §18.307 Line Conducted Emission Limit is same as above table.

#### 3.3. Test Procedure

1. The equipment was set up as per the test configuration to simulate typical actual usage per the user's manual. The EUT is a tabletop system, a wooden table with a height of 0.8 meters is used and is placed on the ground plane as per ANSI C63.10.
2. Support equipment, if needed, was placed as per ANSI C63.10.
3. All I/O cables were positioned to simulate typical actual usage as per ANSI C63.10.
4. If a EUT received DC power from the USB Port of Notebook PC, the PC's adapter received AC120V/60Hz power through a Line Impedance Stabilization Network (LISN) which supplied power source and was grounded to the ground plane.
5. All support equipments received AC power from a second LISN, if any.
6. The EUT test program was started. Emissions were measured on each current carrying line of the EUT using a spectrum Analyzer / Receiver connected to the LISN powering the EUT. The LISN has two monitoring points: Line 1 (Hot Side) and Line 2 (Neutral Side). Two scans were taken: one with Line 1 connected to Analyzer / Receiver and Line 2 connected to a 50 ohm load; the second scan had Line 1 connected to a 50 ohm load and Line 2 connected to the Analyzer / Receiver.
7. Analyzer / Receiver scanned from 150 KHz to 30MHz for emissions in each of the test modes.



### 3.4. Test Result

PASS

All the test modes completed for test. Only the worst result was reported as below:

Test Specification: Line

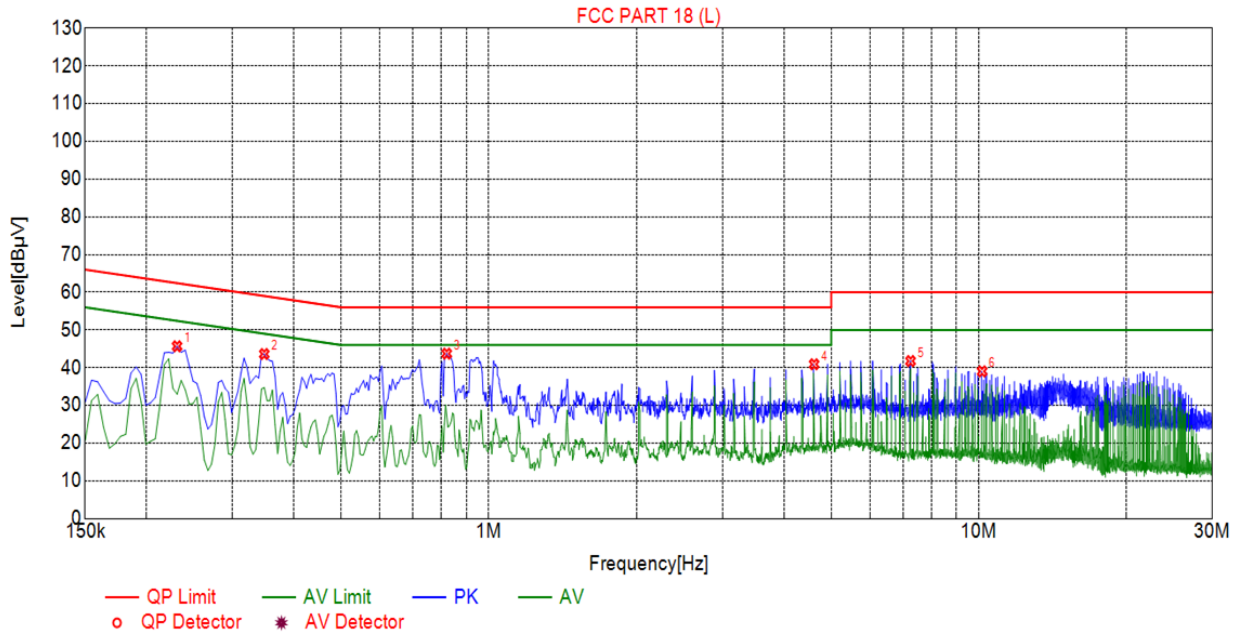

Suspected List								
NO.	Freq. [MHz]	Level [dBμV]	Factor [dB]	Limit [dBμV]	Margin [dB]	Reading [dBμV]	Detector	Type
1	0.2310	45.68	20.03	62.43	16.75	25.65	PK	L
2	0.3480	43.63	20.03	59.06	15.43	23.60	PK	L
3	0.8205	43.72	20.06	56.00	12.28	23.66	PK	L
4	4.6140	40.91	20.26	56.00	15.09	20.65	PK	L
5	7.2600	41.76	20.18	60.00	18.24	21.58	PK	L
6	10.1625	39.02	20.06	60.00	20.98	18.96	PK	L

Remark: Margin = Limit - Level

Correction factor = Cable lose + LISN insertion loss

Level=Test receiver reading + correction factor



Test Specification: Neutral

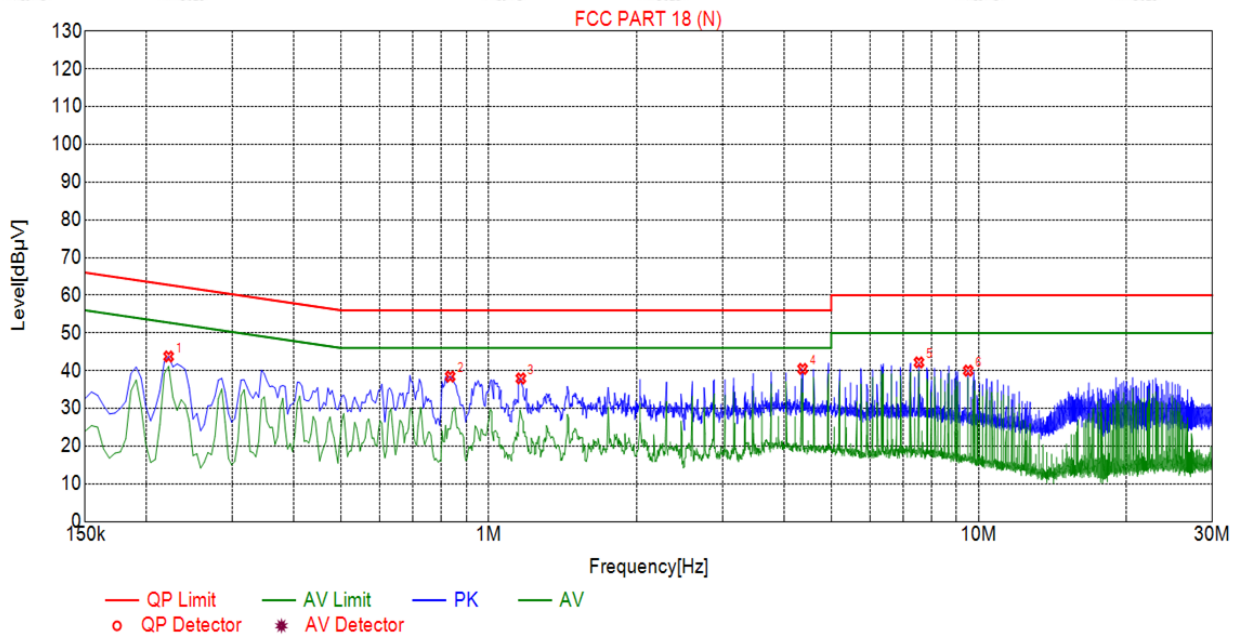

### Suspected List

NO.	Freq. [MHz]	Level [dBµV]	Factor [dB]	Limit [dBµV]	Margin [dB]	Reading [dBµV]	Detector	Type
1	0.2220	43.76	20.04	62.82	19.06	23.72	PK	N
2	0.8340	38.45	20.06	56.00	17.55	18.39	PK	N
3	1.1625	37.94	20.09	56.00	18.06	17.85	PK	N
4	4.3710	40.47	20.25	56.00	15.53	20.22	PK	N
5	7.5525	42.19	20.17	60.00	17.81	22.02	PK	N
6	9.5190	40.01	20.09	60.00	19.99	19.92	PK	N

Remark: Margin = Limit - Level

Correction factor = Cable lose + LISN insertion loss

Level=Test receiver reading + correction factor



#### 4. Radiated Emissions

##### 4.1. Block Diagram of Test Setup

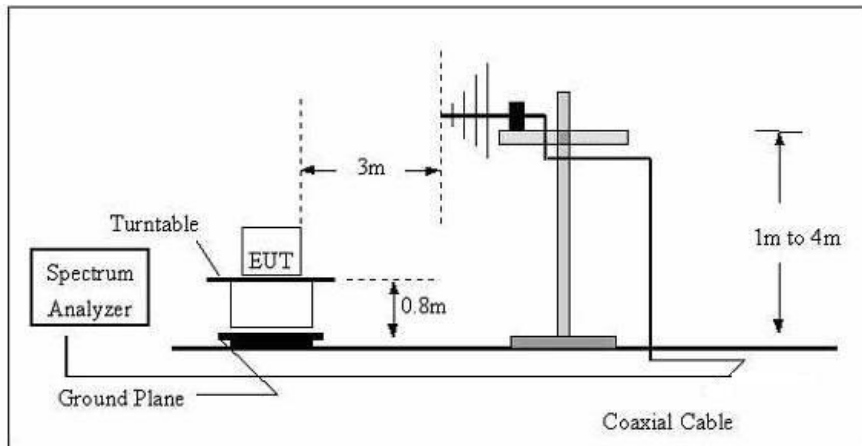
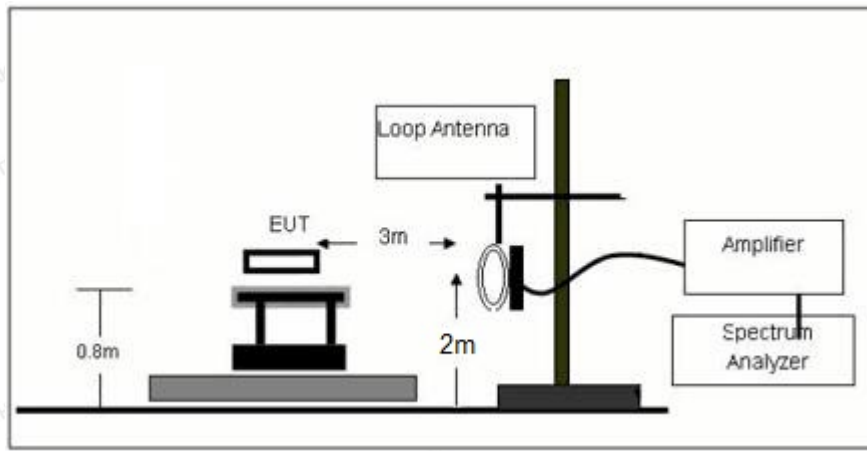



### 4.2. Rules and Specifications

Except as provided elsewhere in this Subpart 18.305 (b), the field strength levels of emissions which lie outside the bands specified in §18.301, unless otherwise indicated, shall not exceed the following table:

Equipment	Operating frequency	RF Power generated by equipment (watts)	Field strength limit (uV/m)	Distance (meters)
(miscellaneous)				
	Any non-ISM frequency	Below 500 500 or more	15 15 × SQRT(power/500)	300 1300

Remark:

- (1) Emission level dBuV/m for 0.009~30MHz = 20log (15) + 40log (300/3) dBuV/m;
- (2) Calculated according FCC 18.305.
- (3) The smaller limit shall apply at the cross point between two frequency bands.
- (4) Distance is the distance in meters between the measuring instrument, antenna and the closest point of any part of the device or system.

### 4.3. Test Procedure

Measurement distance 3m

For the measurement range up to 30MHz in the following plots the field strength result from 3m Distance measurements are extrapolated to 300m and 30m distance respectively, by 40dB/decade, Per antenna factor scaling.

Measurements below 1000MHz are performed with a peak detector and compared to average limits, Measurements with an average detector are not required.

Note:

For battery operated equipment, the equipment tests shall be performed using a new battery.

### 4.4. Test Result

**PASS**

Note: All the test modes completed for test. Only the worst result was reported as below:



For 9KHz - 30MHz

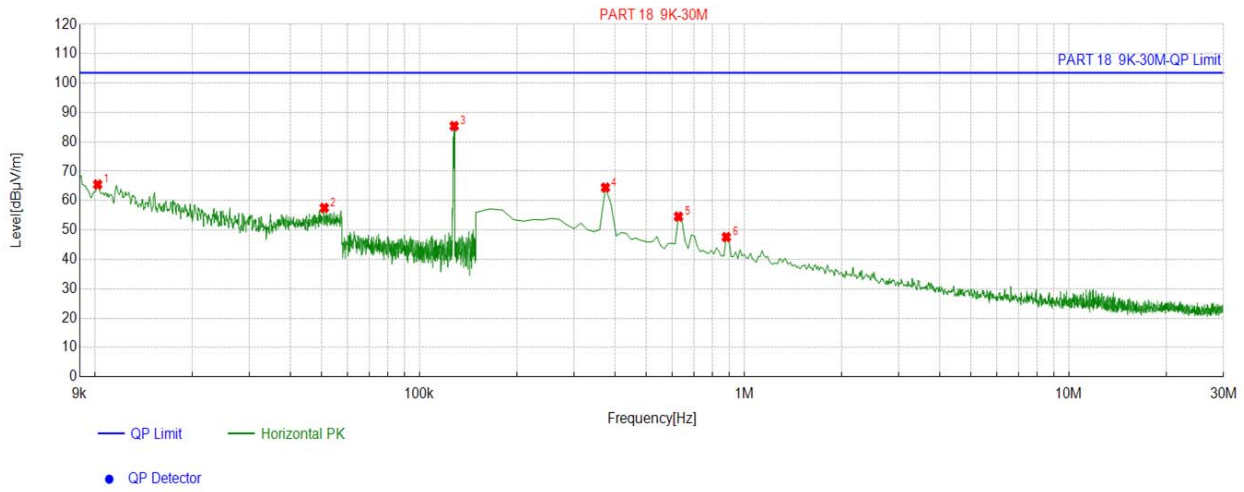

Suspected List						
NO.	Freq. [MHz]	Factor [dB]	Reading [dBµV/m]	Level [dBµV/m]	Limit [dBµV/m]	Margin [dB]
1	0.0102	16.63	48.86	65.49	103.50	38.01
2	0.0509	13.92	43.59	57.51	103.50	45.99
3	0.1279	13.78	71.62	85.40	103.50	18.10
4	0.3740	13.76	50.67	64.43	103.50	39.07
5	0.6278	13.73	40.82	54.55	103.50	48.95
6	0.8817	14.11	33.47	47.58	103.50	55.92

Remark: Factor = Cable loss + Antenna factor – Pre-amplifier; Level = Reading + Factor; Margin = Limit – Level



For 30MHz-1GHz

Antenna polarity: H



Suspected List									
NO.	Freq. [MHz]	Factor [dB]	Reading [dBµV/m]	Level [dBµV/m]	Limit [dBµV/m]	Margin [dB]	Height [cm]	Angle [°]	Polarity
1	37.7678	-15.63	43.35	27.72	63.50	35.78	100	184	Horizontal
2	46.5065	-14.89	46.05	31.16	63.50	32.34	100	195	Horizontal
3	66.8969	-15.28	45.29	30.01	63.50	33.49	100	6	Horizontal
4	121.2713	-15.87	41.78	25.91	63.50	37.59	100	114	Horizontal
5	211.5716	-14.55	59.51	44.96	63.50	18.54	100	357	Horizontal
6	455.2853	-8.34	40.28	31.94	63.50	31.56	100	298	Horizontal

Remark: Factor = Cable loss + Antenna factor – Preamplifier; Level = Reading + Factor; Margin = Limit – Level;





Antenna polarity: V

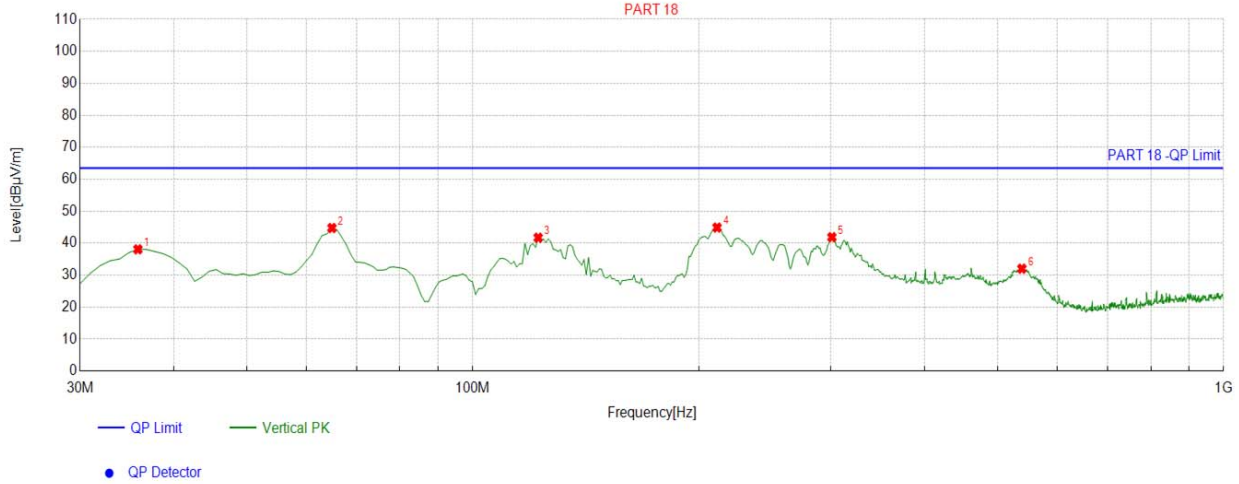

Suspected List									
NO.	Freq. [MHz]	Factor [dB]	Reading [dBµV/m]	Level [dBµV/m]	Limit [dBµV/m]	Margin [dB]	Height [cm]	Angle [°]	Polarity
1	35.8258	-15.82	53.89	38.07	63.50	25.43	100	224	Vertical
2	64.9550	-14.59	59.34	44.75	63.50	18.75	100	192	Vertical
3	122.2422	-15.95	57.66	41.71	63.50	21.79	100	64	Vertical
4	211.5716	-14.55	59.43	44.88	63.50	18.62	100	72	Vertical
5	300.9009	-11.91	53.78	41.87	63.50	21.63	100	272	Vertical
6	538.7888	-6.58	38.59	32.01	63.50	31.49	100	168	Vertical

Remark: Factor = Cable loss + Antenna factor – Preamplifier; Level = Reading + Factor; Margin = Limit – Level;

## 5. Antenna Requirement

### Refer to statement below for compliance.

The manufacturer may design the unit so that the user can replace a broken antenna, but the use of a standard antenna jack or electrical connector is prohibited. Further, this requirement does not apply to intentional radiators that must be professionally installed.

### Antenna Connected Construction

The antenna used in this product is a Coil Antenna, which permanently attached. It conforms to the standard requirements. The directional gains of antenna used for transmitting is 0dBi.

Antenna

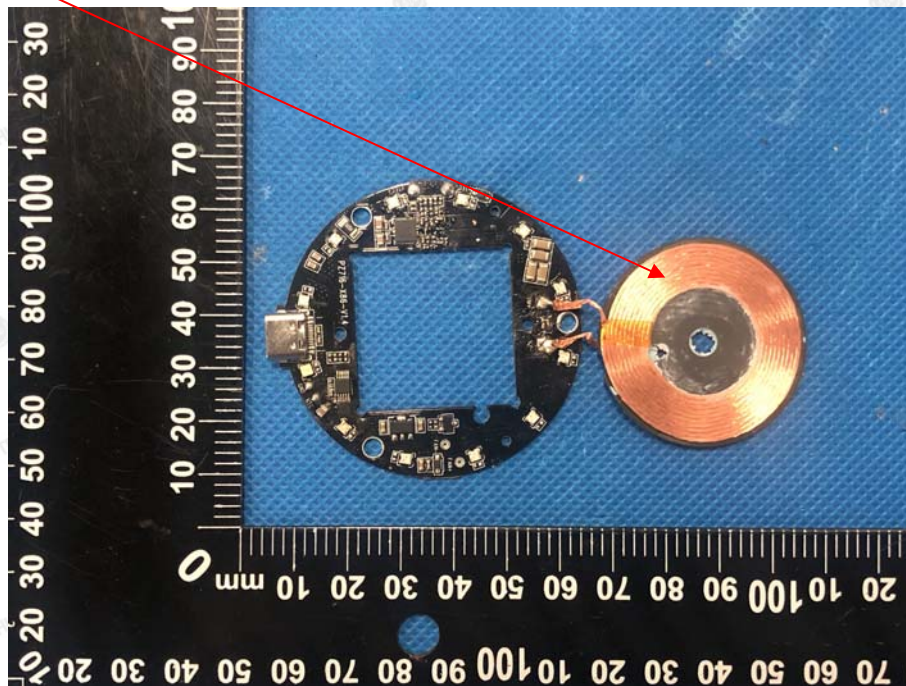



## 6. Photograph of Test

### Radiated Emission

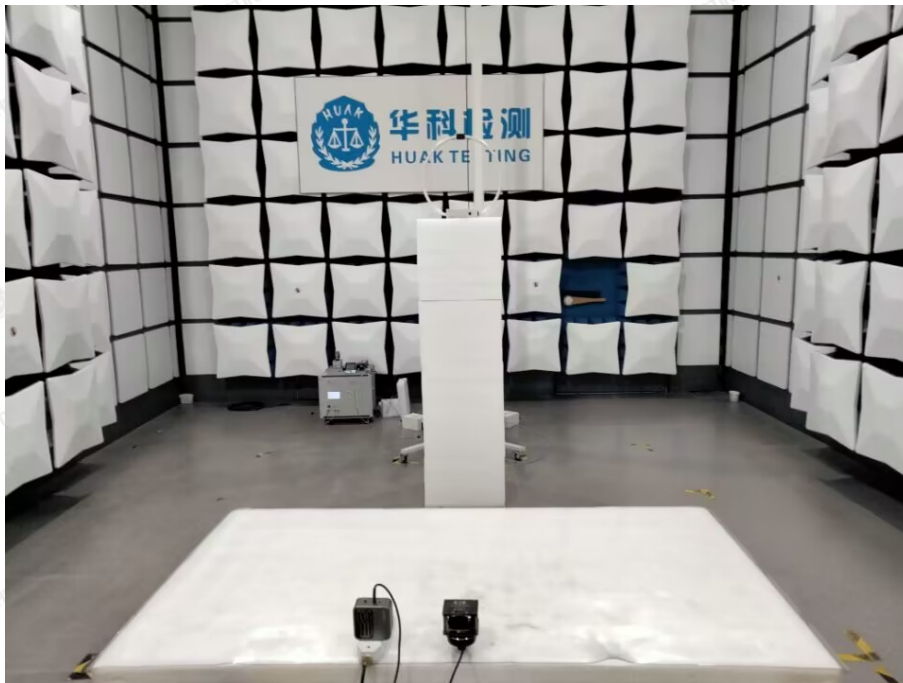
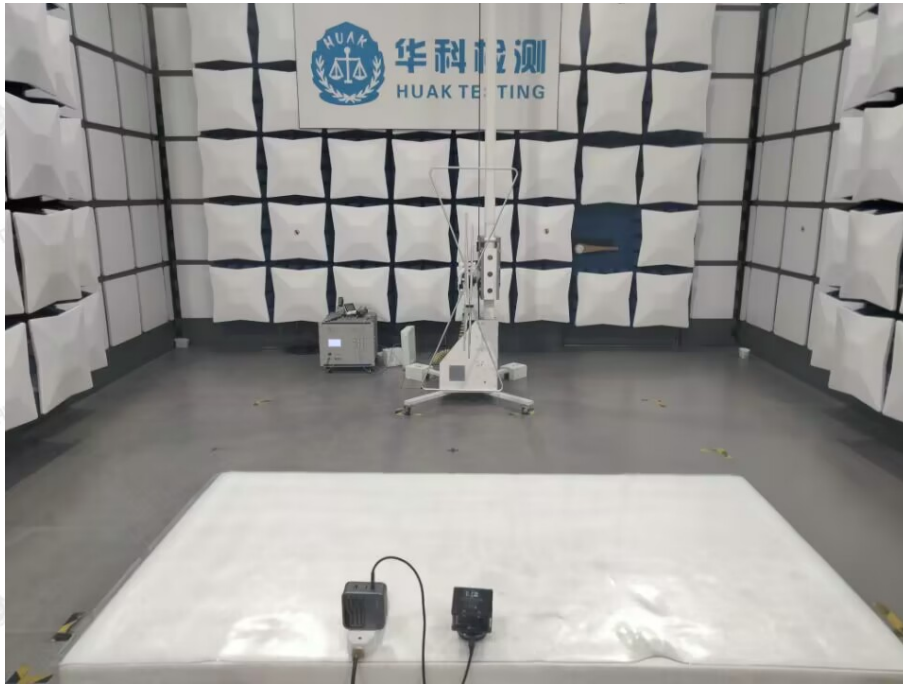

The results shown in this test report refer only to the sample(s) tested unless otherwise stated and the sample(s) are retained for 30 days only. The document is issued by HUAK, this document cannot be reproduced except in full with our prior written permission. The more details and the authenticity of the report will be confirmed at <http://www.cer-mark.com>.

TEL : +86-755 2302 9901 FAX : +86-755 2302 9901 E-mail : [service@cer-mark.com](mailto:service@cer-mark.com)

Addr: 1-2F., Building B2, Junfeng Zhongcheng Zhizao Innovation Park, Heping Community, Fuhai Street, Bao'an District, Shenzhen, Guangdong, China



### Conducted Emission



The results shown in this test report refer only to the sample(s) tested unless otherwise stated and the sample(s) are retained for 30 days only. The document is issued by HUAK, this document cannot be reproduced except in full with our prior written permission. The more details and the authenticity of the report will be confirmed at <http://www.cer-mark.com>.

TEL : +86-755 2302 9901 FAX : +86-755 2302 9901 E-mail : [service@cer-mark.com](mailto:service@cer-mark.com)

Addr: 1-2F., Building B2, Junfeng Zhongcheng Zhizao Innovation Park, Heping Community, Fuhai Street, Bao'an District, Shenzhen, Guangdong, China



## 7. Photos of the EUT

Reference to the report: ANNEX A of external photos and ANNEX B of internal photos.

-----End of test report-----