

Test Report

Report No.: MTi240417002-07E1

Date of issue: 2024-05-15

Applicant: Shenzhen Xiangdangwen Technology Co., Ltd.

Product: 3-IN-1 WIRELESS CHARGING DESKTOP STAND

Model(s): 2E567

FCC ID: 2AW73-2E567

Shenzhen Microtest Co., Ltd.

<http://www.mtitest.cn>

The test report is only used for customer scientific research, teaching, internal quality control and other purposes, and is for internal reference only.



Instructions

1. This test report shall not be partially reproduced without the written consent of the laboratory.
2. The test results in this test report are only responsible for the samples submitted
3. This test report is invalid without the seal and signature of the laboratory.
4. This test report is invalid if transferred, altered, or tampered with in any form without authorization.
5. Any objection to this test report shall be submitted to the laboratory within 15 days from the date of receipt of the report.

Table of contents

1	General Description	5
1.1	Description of the EUT	5
1.2	Description of test modes	6
1.3	Environmental Conditions	7
1.4	Description of support units	7
1.5	Measurement uncertainty	7
2	Summary of Test Result	8
3	Test Facilities and accreditations	9
3.1	Test laboratory	9
4	List of test equipment.....	10
5	Evaluation Results (Evaluation).....	11
5.1	Antenna requirement	11
6	Radio Spectrum Matter Test Results (RF)	12
6.1	Conducted Emission at AC power line	12
6.2	20dB Occupied Bandwidth	15
6.3	Emissions in frequency bands (below 30MHz).....	21
6.4	Emissions in frequency bands (30MHz - 1GHz).....	26
	Photographs of the test setup.....	29
	Photographs of the EUT.....	30

Test Result Certification	
Applicant:	Shenzhen Xiangdangwen Technology Co., Ltd.
Address:	106, 1/F, No.313-4 Building, Huachang Road, Langkou Community, Dalang Street, Longhua District, Shenzhen, China
Manufacturer:	Huizhou Yimai Electronics Technology Co., Ltd.
Address:	3rd Floor, Building B, Huakai High-tech Industrial Park, Electronic City Road, Longxi Street, Boluo Country
Product description	
Product name:	3-IN-1 WIRELESS CHARGING DESKTOP STAND
Trademark:	LISEN, AINOPE, VEICO
Model name:	2E567
Series Model(s):	N/A
Standards:	47 CFR Part 15C
Test Method:	ANSI C63.10-2013
Date of Test	
Date of test:	2024-04-21 to 2024-05-15
Test result:	Pass

Test Engineer	:	<i>James Qin</i>
		(James Qin)
Reviewed By	:	<i>David. Lee</i>
		(David Lee)
Approved By	:	<i>Leon Chen</i>
		(Leon Chen)

1 General Description

1.1 Description of the EUT

Product name:	3-IN-1 WIRELESS CHARGING DESKTOP STAND
Model name:	2E567
Series Model(s):	N/A
Model difference:	N/A
Electrical rating:	Input: DC 5V/3A, 9V/3A, 12V/3A Phone Output: 5W/7.5W/10W/15W(Qi2) Earbuds Output: 5W Watch Output: 5W
Accessories:	Cable: USB-C to USB-C Cable 100cm
Hardware version:	V1.0
Software version:	KB-T9-9516-V1
RF specification	
Operating frequency range:	Coil 1(Phone): 115-205kHz(5W,7.5W,10W),360 kHz(15W) Coil 2(Earphone): 115-205 kHz Coil 3(Watch): 300-350 kHz
Modulation type:	ASK

1.2 Description of test modes

No.	Emission test modes
Mode1	Wireless output(5W)+Earphone(5W)+Watch(5W)
Mode2	Wireless output(7.5W)+Earphone(5W)+Watch(5W)
Mode3	Wireless output(10W)+Earphone(5W)+Watch(5W)
Mode4	Wireless output(15W Qi2)+Earphone(5W)+Watch(5W)
Mode5	Wireless output(5W)+Earphone(5W)
Mode6	Wireless output(7.5W)+Earphone(5W)
Mode7	Wireless output(10W)+Earphone(5W)
Mode8	Wireless output(15W Qi2)+Earphone(5W)
Mode9	Wireless output(5W)+Watch(5W)
Mode10	Wireless output(7.5W)+Watch(5W)
Mode11	Wireless output(10W)+Watch(5W)
Mode12	Wireless output(15W Qi2)+Watch(5W)
Mode13	Earphone(5W)+Watch(5W)
Mode14	Wireless output(5W)
Mode15	Wireless output(7.5W)
Mode16	Wireless output(10W)
Mode17	Wireless output(15W Qi2)
Mode18	Watch(5W)
Mode19	Earphone(5W)
Mode20	stand by

1.3 Environmental Conditions

During the measurement the environmental conditions were within the listed ranges:

Temperature:	15°C ~ 35°C
Humidity:	20% RH ~ 75% RH
Atmospheric pressure:	98 kPa ~ 101 kPa

1.4 Description of support units

The EUT has been tested as an independent unit together with other necessary accessories or support units. The following support units or accessories were used to form a representative test configuration during the tests.

Support equipment list			
Description	Model	Serial No.	Manufacturer
wireless charging load	YBZ1.1	/	YBZ
wireless charging load	YBZ2.0	/	YBZ
iWatch	iWatch S7	M0JVGQG1VP	Apple
Air Pods	MQD83CH/A	/	Apple
HUAWEI QUICK CHARGE(65W)	HW-200200ZP1	JN67LSN7N03451	HUAWEI
Support cable list			
Description	Length (m)	From	To
/	/	/	/

1.5 Measurement uncertainty

Measurement	Uncertainty
Conducted emissions (AMN 150kHz~30MHz)	±3.1dB
Occupied channel bandwidth	±3 %
Radiated spurious emissions (9kHz~30MHz)	±4.3dB
Radiated spurious emissions (30MHz~1GHz)	±4.7dB
Temperature	±1 °C
Humidity	± 5 %

This uncertainty represents an expanded uncertainty expressed at approximately the 95% confidence level using a coverage factor of k=2.

2 Summary of Test Result

No.	Item	Standard	Requirement	Result
1	Antenna requirement	47 CFR Part 15C	47 CFR Part 15.203	Pass
2	Conducted Emission at AC power line	47 CFR Part 15C	47 CFR Part 15.207(a)	Pass
3	20dB Occupied Bandwidth	47 CFR Part 15C	47 CFR Part 15.215(c)	Pass
4	Emissions in frequency bands (below 30MHz)	47 CFR Part 15C	47 CFR Part 15.209	Pass
5	Emissions in frequency bands (30MHz - 1GHz)	47 CFR Part 15C	47 CFR Part 15.209	Pass

3 Test Facilities and accreditations

3.1 Test laboratory

Test laboratory:	Shenzhen Microtest Co., Ltd.
Test site location:	101, No.7, Zone 2, Xinxing Industrial Park, Fuhai Avenue, Xinhe Community, Fuhai Street, Bao'an District, Shenzhen, Guangdong, China
Telephone:	(86-755)88850135
Fax:	(86-755)88850136
CNAS Registration No.:	CNAS L5868
FCC Registration No.:	448573
IC Registration No.:	21760
CABID:	CN0093

4 List of test equipment

No.	Equipment	Manufacturer	Model	Serial No.	Cal. date	Cal. Due
Conducted Emission at AC power line						
1	EMI Test Receiver	Rohde&schwarz	ESCI3	101368	2024-03-20	2025-03-19
2	Artificial mains network	Schwarzbeck	NSLK 8127	183	2024-03-21	2025-03-20
3	Artificial Mains Network	Rohde & Schwarz	ESH2-Z5	100263	2024-03-20	2025-03-19
20dB Occupied Bandwidth						
1	Wideband Radio Communication Tester	Rohde&schwarz	CMW500	149155	2024-03-20	2025-03-19
2	ESG Series Analog Ssignal Generator	Agilent	E4421B	GB40051240	2024-03-21	2025-03-20
3	PXA Signal Analyzer	Agilent	N9030A	MY51350296	2024-03-21	2025-03-20
4	Synthesized Sweeper	Agilent	83752A	3610A01957	2024-03-21	2025-03-20
5	MXA Signal Analyzer	Agilent	N9020A	MY50143483	2024-03-21	2025-03-20
6	RF Control Unit	Tonscend	JS0806-1	19D8060152	2024-03-21	2025-03-20
7	Band Reject Filter Group	Tonscend	JS0806-F	19D8060160	2024-03-21	2025-03-20
8	ESG Vector Signal Generator	Agilent	N5182A	MY50143762	2024-03-20	2025-03-19
9	DC Power Supply	Agilent	E3632A	MY40027695	2024-03-21	2025-03-20
Emissions in frequency bands (below 30MHz)						
1	EMI Test Receiver	Rohde&schwarz	ESCI7	101166	2024-03-20	2025-03-19
2	Active Loop Antenna	Schwarzbeck	FMZB 1519 B	00066	2024-03-23	2025-03-22
3	Amplifier	Hewlett-Packard	8447F	3113A06184	2024-03-20	2025-03-19
Emissions in frequency bands (30MHz - 1GHz)						
1	EMI Test Receiver	Rohde&schwarz	ESCI7	101166	2024-03-20	2025-03-19
2	TRILOG Broadband Antenna	schwarabeck	VULB 9163	9163-1338	2023-06-11	2025-06-10
3	Active Loop Antenna	Schwarzbeck	FMZB 1519 B	00066	2024-03-23	2025-03-22
4	Amplifier	Hewlett-Packard	8447F	3113A06184	2024-03-20	2025-03-19
5	Multi-device Controller	TuoPu	TPMDC	/	2024-03-20	2025-03-19

5 Evaluation Results (Evaluation)

5.1 Antenna requirement

Test Requirement:	Refer to 47 CFR Part 15.203, an intentional radiator shall be designed to ensure that no antenna other than that furnished by the responsible party shall be used with the device. The use of a permanently attached antenna or of an antenna that uses a unique coupling to the intentional radiator shall be considered sufficient to comply with the provisions of this section.
-------------------	---

5.1.1 Conclusion:

The antenna of the EUT is permanently attached. The EUT complies with the requirement of FCC PART 15.203.
--

6 Radio Spectrum Matter Test Results (RF)

6.1 Conducted Emission at AC power line

Test Requirement:	Except as shown in paragraphs (b) and (c) of this section, for an intentional radiator that is designed to be connected to the public utility (AC) power line, the radio frequency voltage that is conducted back onto the AC power line on any frequency or frequencies, within the band 150 kHz to 30 MHz, shall not exceed the limits in the following table, as measured using a 50 μ H/50 ohms line impedance stabilization network (LISN).		
Test Limit:	Frequency of emission (MHz)	Conducted limit (dB μ V)	
		Quasi-peak	Average
	0.15-0.5	66 to 56*	56 to 46*
	0.5-5	56	46
	5-30	60	50
	*Decreases with the logarithm of the frequency.		
Test Method:	ANSI C63.10-2013 section 6.2		
Procedure:	Refer to ANSI C63.10-2013 section 6.2, standard test method for ac power-line conducted emissions from unlicensed wireless devices		

6.1.1 E.U.T. Operation:

Operating Environment:					
Temperature:	26 °C	Humidity:	41 %	Atmospheric Pressure:	101 kPa
Pre test mode:	Mode1, Mode2, Mode3, Mode4, Mode5, Mode6, Mode7, Mode8, Mode9, Mode10, Mode11, Mode12, Mode13, Mode14, Mode15, Mode16, Mode17, Mode18, Mode19, Mode20				
Final test mode:	All of the listed pre-test mode were tested, only the data of the worst mode (Mode4) is recorded in the report				

6.1.2 Test Setup Diagram:

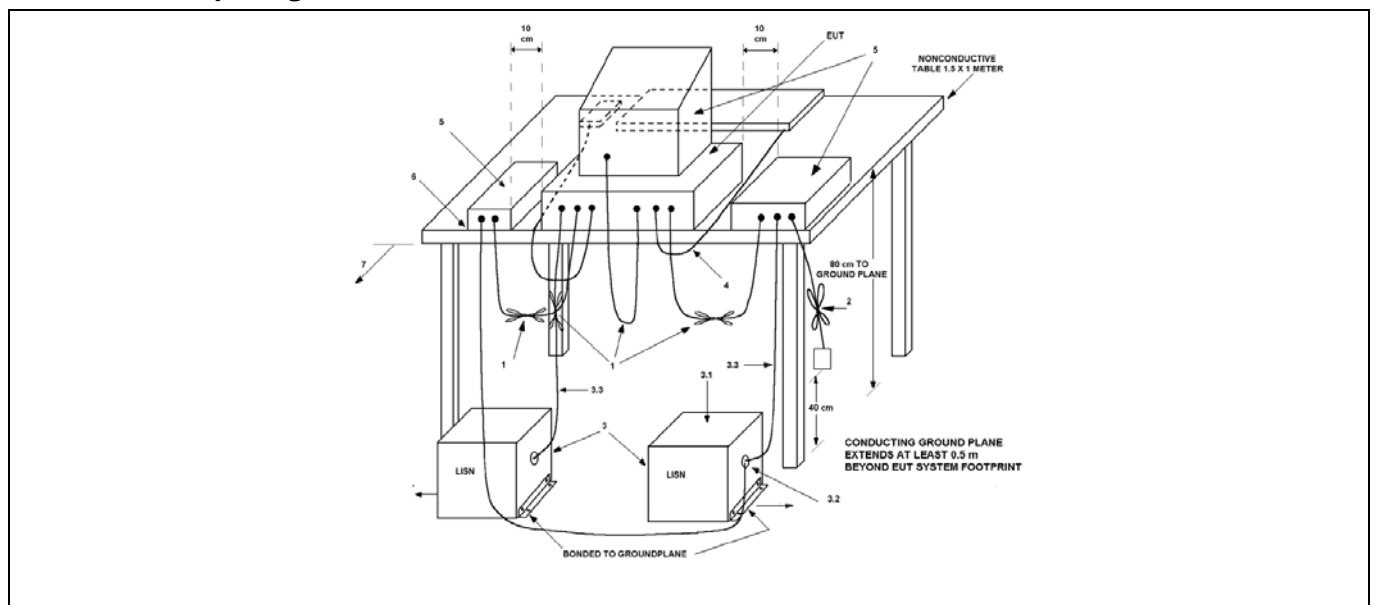

6.1.3 Test Data:

Mode4 / Line: Line

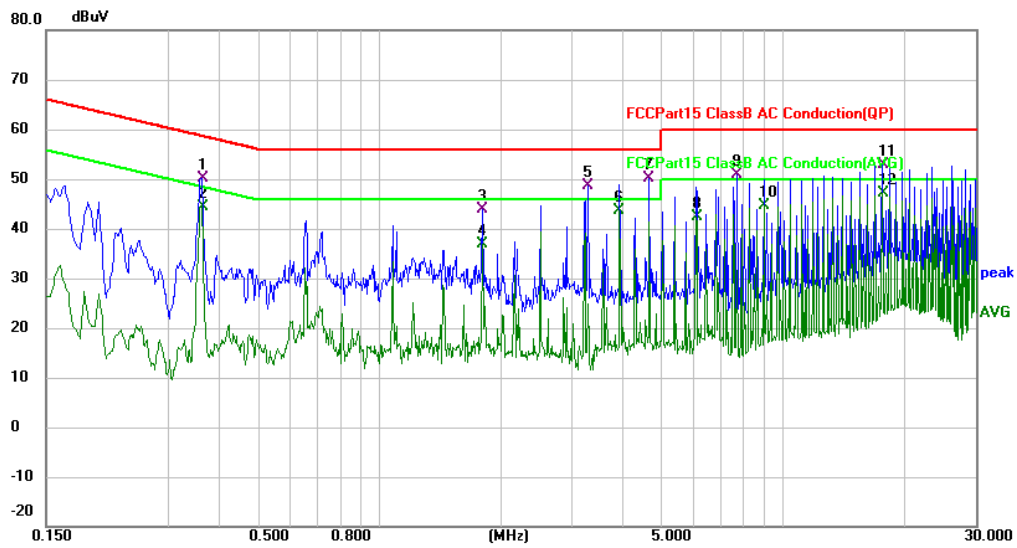

No.	Mk.	Freq. MHz	Reading Level dBuV	Correct Factor dB	Measure- ment dBuV	Limit dBuV	Over dB	Detector	Comment
1		0.3619	39.03	11.18	50.21	58.68	-8.47	QP	
2		0.3619	33.26	11.18	44.44	48.68	-4.24	AVG	
3		1.7980	29.53	14.23	43.76	56.00	-12.24	QP	
4		1.8020	22.68	14.23	36.91	46.00	-9.09	AVG	
5		3.2980	37.86	10.65	48.51	56.00	-7.49	QP	
6	*	3.9580	33.00	10.65	43.65	46.00	-2.35	AVG	
7		4.6779	39.52	10.65	50.17	56.00	-5.83	QP	
8		6.1178	31.62	10.68	42.30	50.00	-7.70	AVG	
9		7.6900	40.18	10.72	50.90	60.00	-9.10	QP	
10		8.9978	33.93	10.74	44.67	50.00	-5.33	AVG	
11		17.6378	41.80	11.10	52.90	60.00	-7.10	QP	
12		17.6378	36.15	11.10	47.25	50.00	-2.75	AVG	

Mode4 / Line: Neutral

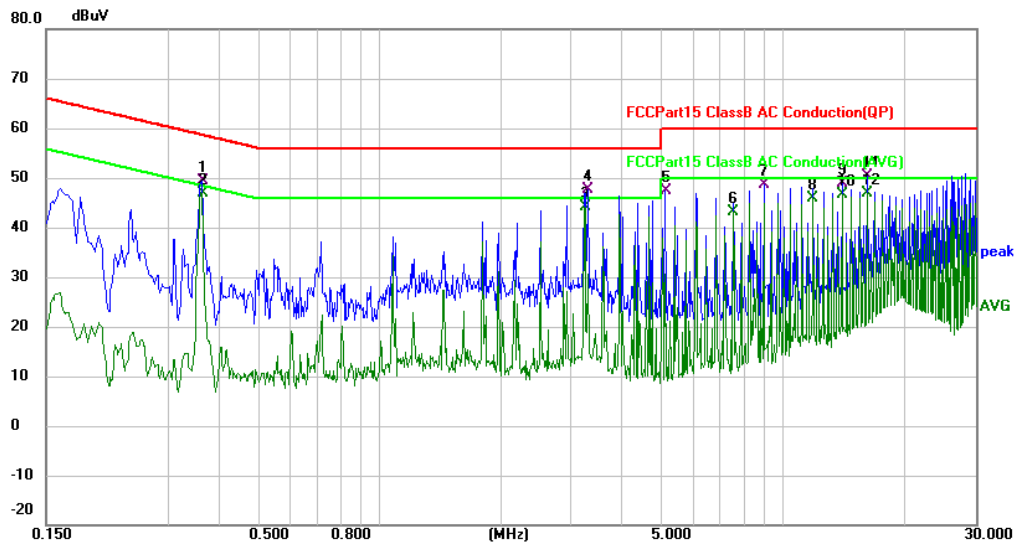

No.	Mk.	Freq.	Reading Level	Correct Factor	Measurement	Limit	Over	Detector	Comment
		MHz	dBuV	dB	dBuV	dBuV	dB		
1		0.3620	38.13	11.18	49.31	58.68	-9.37	QP	
2		0.3620	35.62	11.18	46.80	48.68	-1.88	AVG	
3	*	3.2380	33.60	10.64	44.24	46.00	-1.76	AVG	
4		3.2980	37.09	10.65	47.74	56.00	-8.26	QP	
5		5.1259	36.84	10.65	47.49	60.00	-12.51	QP	
6		7.5579	32.49	10.71	43.20	50.00	-6.80	AVG	
7		8.9979	37.95	10.74	48.69	60.00	-11.31	QP	
8		11.8779	35.09	10.86	45.95	50.00	-4.05	AVG	
9		14.0379	37.89	10.98	48.87	60.00	-11.13	QP	
10		14.0379	35.54	10.98	46.52	50.00	-3.48	AVG	
11		16.1979	39.28	11.06	50.34	60.00	-9.66	QP	
12		16.1979	35.72	11.06	46.78	50.00	-3.22	AVG	

6.2 20dB Occupied Bandwidth

Test Requirement:	47 CFR Part 15.215(c)
Test Limit:	Refer to 47 CFR 15.215(c), intentional radiators operating under the alternative provisions to the general emission limits, as contained in §§ 15.217 through 15.257 and in subpart E of this part, must be designed to ensure that the 20 dB bandwidth of the emission, or whatever bandwidth may otherwise be specified in the specific rule section under which the equipment operates, is contained within the frequency band designated in the rule section under which the equipment is operated.
Test Method:	ANSI C63.10-2013, section 6.9.2
Procedure:	<p>a) The spectrum analyzer center frequency is set to the nominal EUT channel center frequency. The span range for the EMI receiver or spectrum analyzer shall be between two times and five times the OBW.</p> <p>b) The nominal IF filter bandwidth (3 dB RBW) shall be in the range of 1% to 5% of the OBW and video bandwidth (VBW) shall be approximately three times RBW, unless otherwise specified by the applicable requirement.</p> <p>c) Set the reference level of the instrument as required, keeping the signal from exceeding the maximum input mixer level for linear operation. In general, the peak of the spectral envelope shall be more than $[10 \log (OBW/RBW)]$ below the reference level. Specific guidance is given in 4.1.5.2.</p> <p>d) Steps a) through c) might require iteration to adjust within the specified tolerances.</p> <p>e) The dynamic range of the instrument at the selected RBW shall be more than 10 dB below the target “-xx dB down” requirement; that is, if the requirement calls for measuring the -20 dB OBW, the instrument noise floor at the selected RBW shall be at least 30 dB below the reference value.</p> <p>f) Set detection mode to peak and trace mode to max hold.</p> <p>g) Determine the reference value: Set the EUT to transmit an unmodulated carrier or modulated signal, as applicable. Allow the trace to stabilize. Set the spectrum analyzer marker to the highest level of the displayed trace (this is the reference value).</p> <p>h) Determine the “-xx dB down amplitude” using $[(\text{reference value}) - xx]$. Alternatively, this calculation may be made by using the marker-delta function of the instrument.</p> <p>i) If the reference value is determined by an unmodulated carrier, then turn the EUT modulation ON, and either clear the existing trace or start a new trace on the spectrum analyzer and allow the new trace to stabilize. Otherwise, the trace from step g) shall be used for step j).</p> <p>j) Place two markers, one at the lowest frequency and the other at the highest frequency of the envelope of the spectral display, such that each marker is at or slightly below the “-xx dB down amplitude” determined in step h). If a marker is below this “-xx dB down amplitude” value, then it shall be as close as possible to this value. The occupied bandwidth is the frequency difference between the two markers. Alternatively, set a marker at the lowest frequency of the envelope of the spectral display, such that the marker is at or slightly below the “-xx dB down amplitude” determined in step h). Reset the marker-delta function and move the marker to the other side of the emission until the delta marker amplitude is at the same level as the reference marker amplitude. The marker-delta frequency reading at this point is the specified emission bandwidth.</p> <p>k) The occupied bandwidth shall be reported by providing plot(s) of the measuring instrument display; the plot axes and the scale units per division shall be clearly labeled. Tabular data may be reported in addition to the plot(s).</p>

6.2.1 E.U.T. Operation:

Operating Environment:					
Temperature:	25 °C	Humidity:	59 %	Atmospheric Pressure:	100 kPa
Pre test mode:	Mode1, Mode2, Mode3, Mode4, Mode5, Mode6, Mode7, Mode8, Mode9, Mode10, Mode11, Mode12, Mode13, Mode14, Mode15, Mode16, Mode17, Mode18, Mode19, Mode20				
Final test mode:	All of the listed pre-test mode were tested, only the data of the worst mode (Mode16, Mode17, Mode18, Mode19) is recorded in the report				

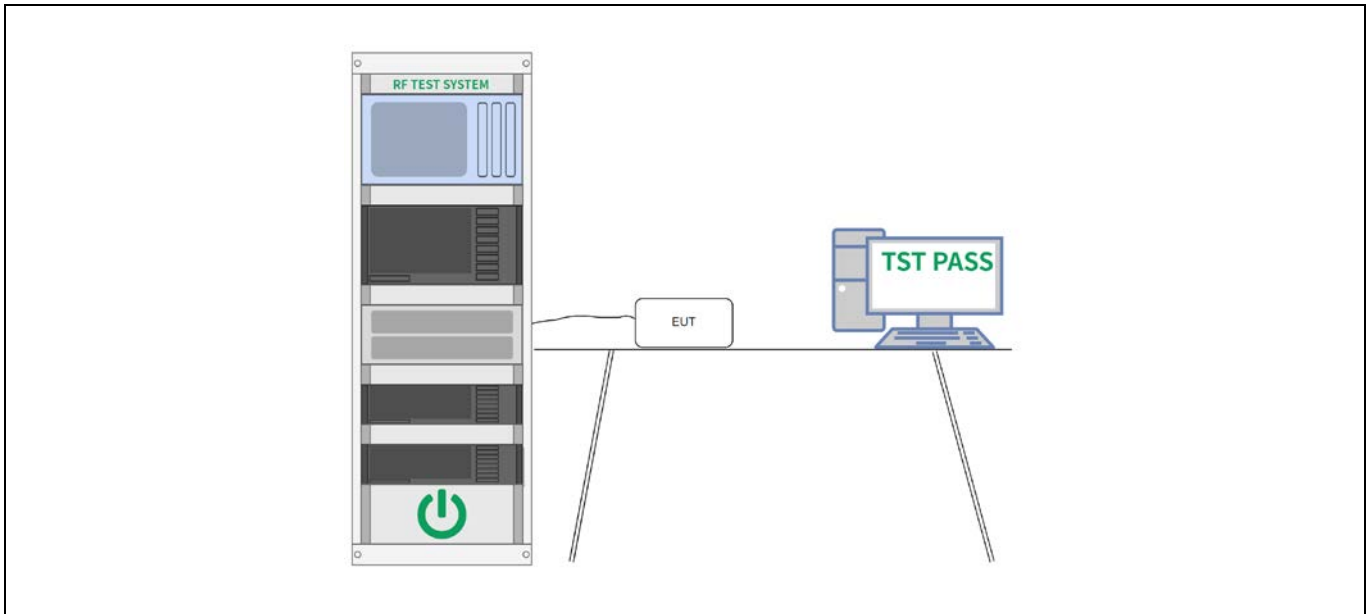
6.2.2 Test Setup Diagram:

6.2.3 Test Data:

Note: Because the measured signal is CW-like, adjusting the RBW per C63.10 would not be practical since measurement bandwidth will always follow the RBW. The RBW is set to 300 Hz to perform the occupied bandwidth test.

Mode19:

Frequency kHz	20 dB occupied bandwidth Hz	99% occupied bandwidth Hz
148.125	808	703

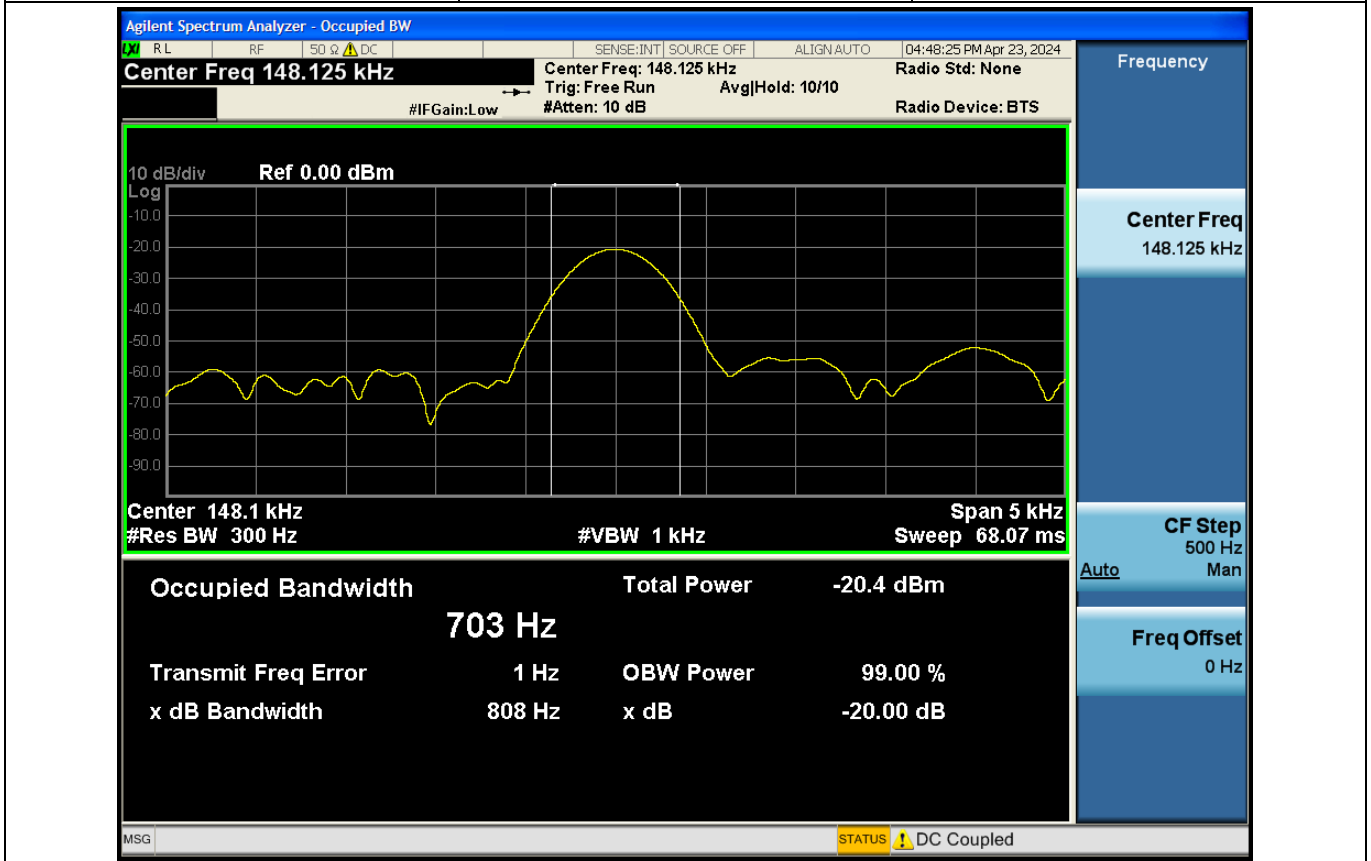

Note: Because the measured signal is CW-like, adjusting the RBW per C63.10 would not be practical since measurement bandwidth will always follow the RBW. The RBW is set to 300 Hz to perform the occupied bandwidth test.

Mode17:

Frequency kHz	20 dB occupied bandwidth Hz	99% occupied bandwidth Hz
360	811	697

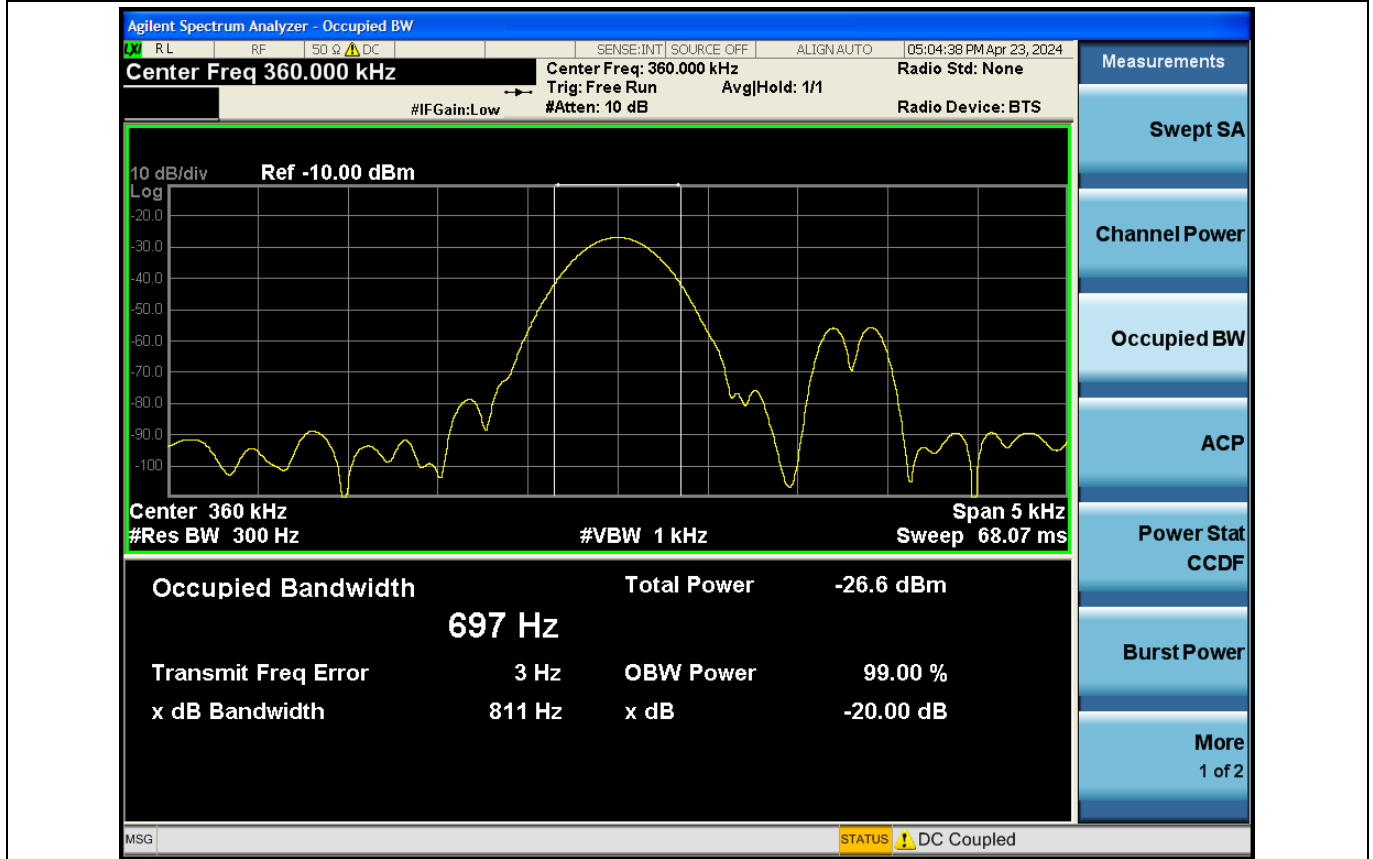

Note: Because the measured signal is CW-like, adjusting the RBW per C63.10 would not be practical since measurement bandwidth will always follow the RBW. The RBW is set to 300 Hz to perform the occupied bandwidth test.

Mode18:

Frequency kHz	20 dB occupied bandwidth Hz	99% occupied bandwidth Hz
324.295	849	831

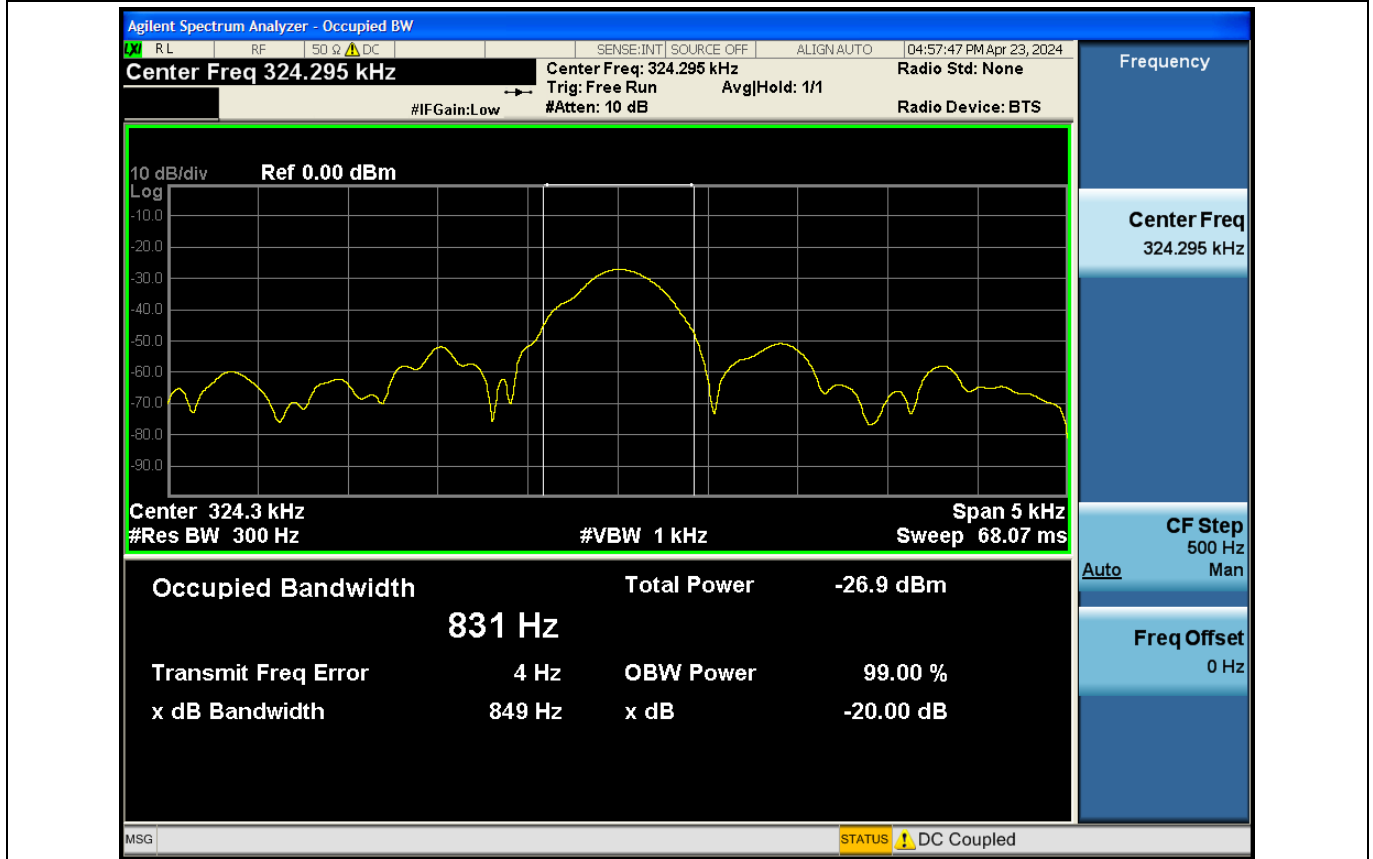

Note: Because the measured signal is CW-like, adjusting the RBW per C63.10 would not be practical since measurement bandwidth will always follow the RBW. The RBW is set to 300 Hz to perform the occupied bandwidth test.

Mode16:

Frequency kHz	20 dB occupied bandwidth Hz	99% occupied bandwidth Hz
127.84	811	690

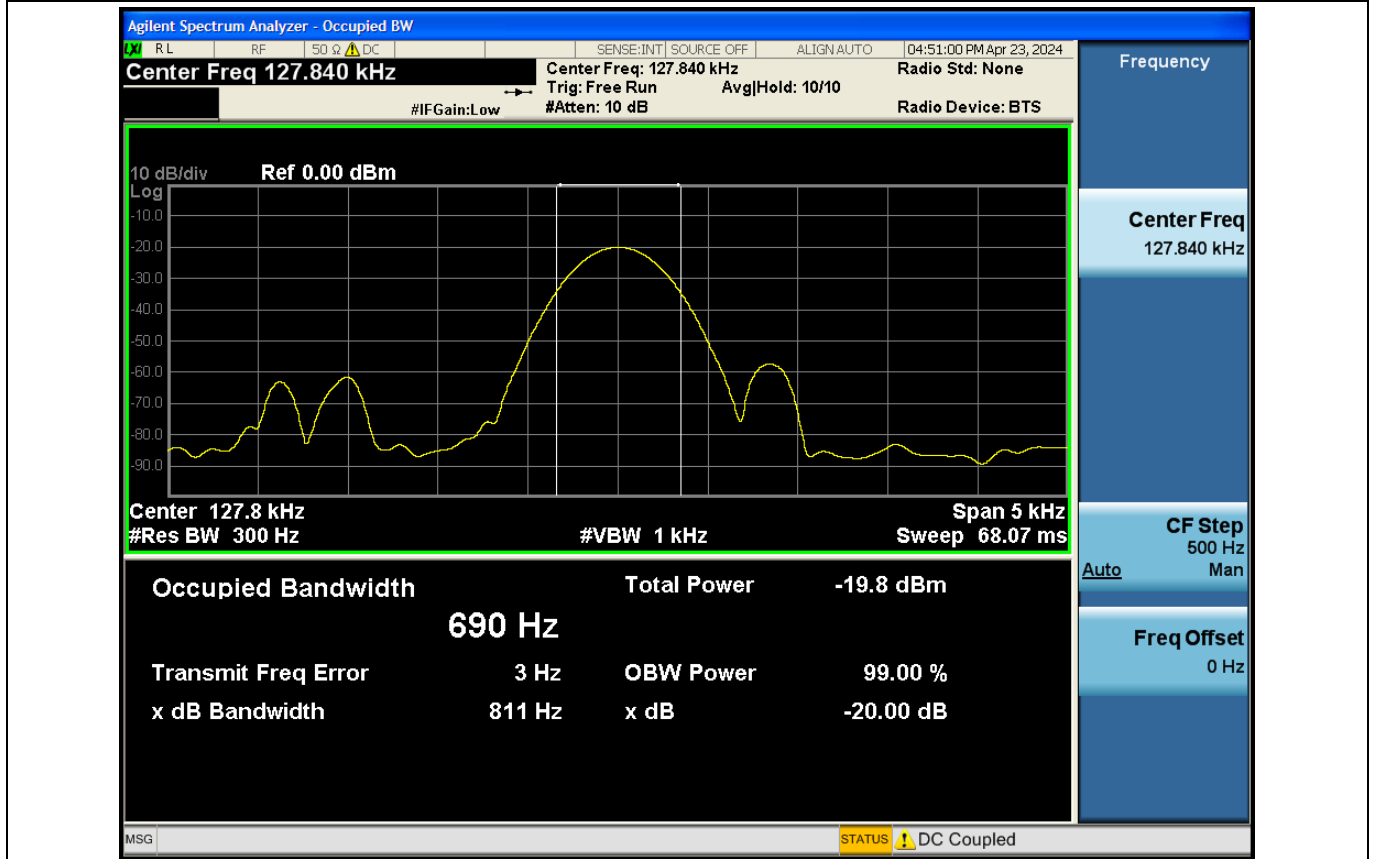

6.3 Emissions in frequency bands (below 30MHz)

Test Requirement:	47 CFR Part 15.209		
Test Limit:	Frequency (MHz)	Field strength (microvolts/meter)	Measurement distance (meters)
	0.009-0.490	2400/F(kHz)	300
	0.490-1.705	24000/F(kHz)	30
	1.705-30.0	30	30
	30-88	100 **	3
	88-216	150 **	3
	216-960	200 **	3
	Above 960	500	3
<p>** Except as provided in paragraph (g), fundamental emissions from intentional radiators operating under this section shall not be located in the frequency bands 54-72 MHz, 76-88 MHz, 174-216 MHz or 470-806 MHz. However, operation within these frequency bands is permitted under other sections of this part, e.g., §§ 15.231 and 15.241.</p> <p>In the emission table above, the tighter limit applies at the band edges. The emission limits shown in the above table are based on measurements employing a CISPR quasi-peak detector except for the frequency bands 9–90 kHz, 110–490 kHz and above 1000 MHz. Radiated emission limits in these three bands are based on measurements employing an average detector. As shown in § 15.35(b), for frequencies above 1000 MHz, the field strength limits in paragraphs (a) and (b) of this section are based on average limits. However, the peak field strength of any emission shall not exceed the maximum permitted average limits specified above by more than 20 dB under any condition of modulation. For point-to-point operation under paragraph (b) of this section, the peak field strength shall not exceed 2500 millivolts/meter at 3 meters along the antenna azimuth.</p>			
Test Method:	ANSI C63.10-2013 section 6.4		
Procedure:	ANSI C63.10-2013 section 6.4		

6.3.1 E.U.T. Operation:

Operating Environment:					
Temperature:	18.9 °C	Humidity:	65.2 %	Atmospheric Pressure:	99 kPa
Pre test mode:	Mode1, Mode2, Mode3, Mode4, Mode5, Mode6, Mode7, Mode8, Mode9, Mode10, Mode11, Mode12, Mode13, Mode14, Mode15, Mode16, Mode17, Mode18, Mode19, Mode20				
Final test mode:	All of the listed pre-test mode were tested, only the data of the worst mode (Mode3, Mode4) is recorded in the report				

6.3.2 Test Setup Diagram:

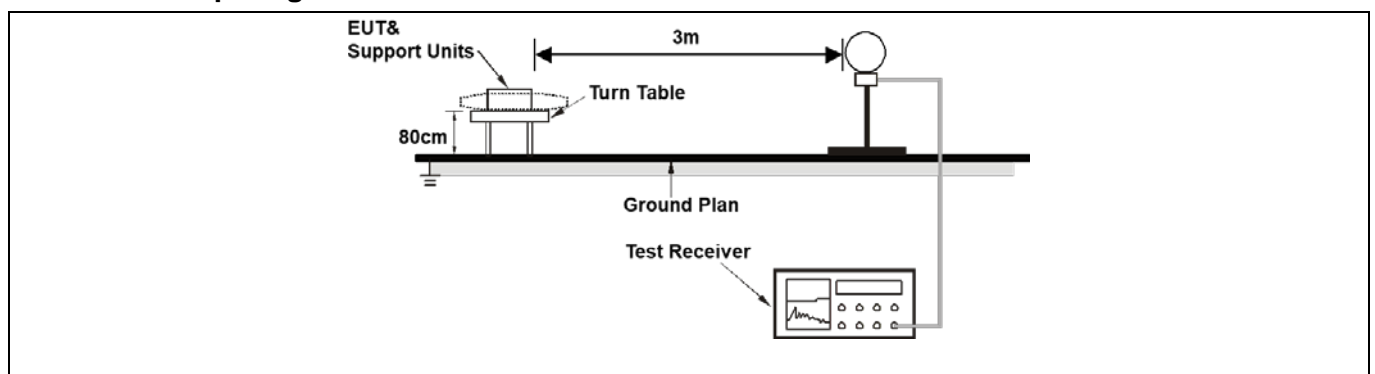

6.3.3 Test Data:

Mode4 / Polarization: coaxial

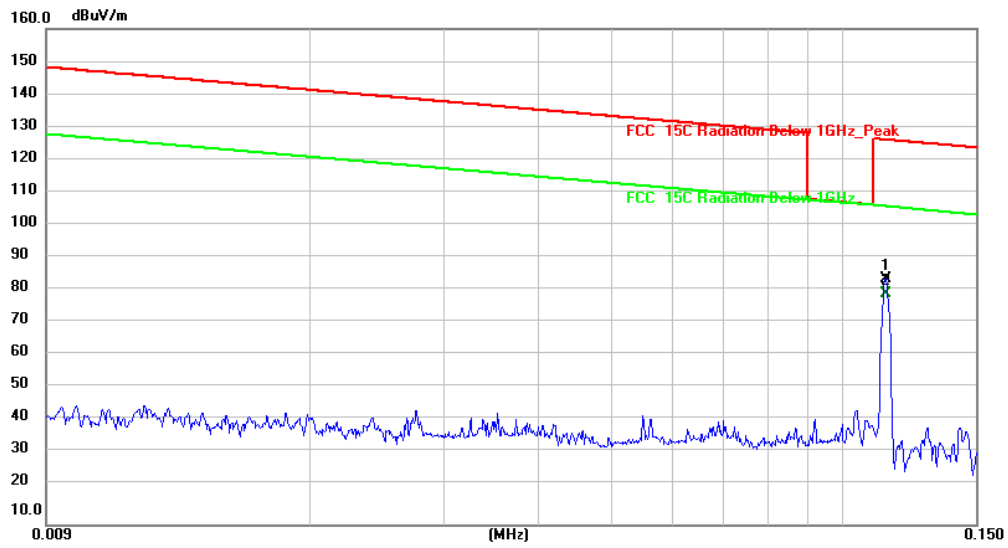

No.	Mk.	Freq.	Reading Level	Correct Factor	Measurement	Limit	Over	Detector	Comment
		MHz	dBuV	dB	dBuV/m	dBuV/m	dB		
1		0.1139	64.33	20.25	84.58	126.50	-41.92	peak	
2	*	0.1139	59.85	20.25	80.10	106.50	-26.40	AVG	

Mode4 / Polarization: coaxial

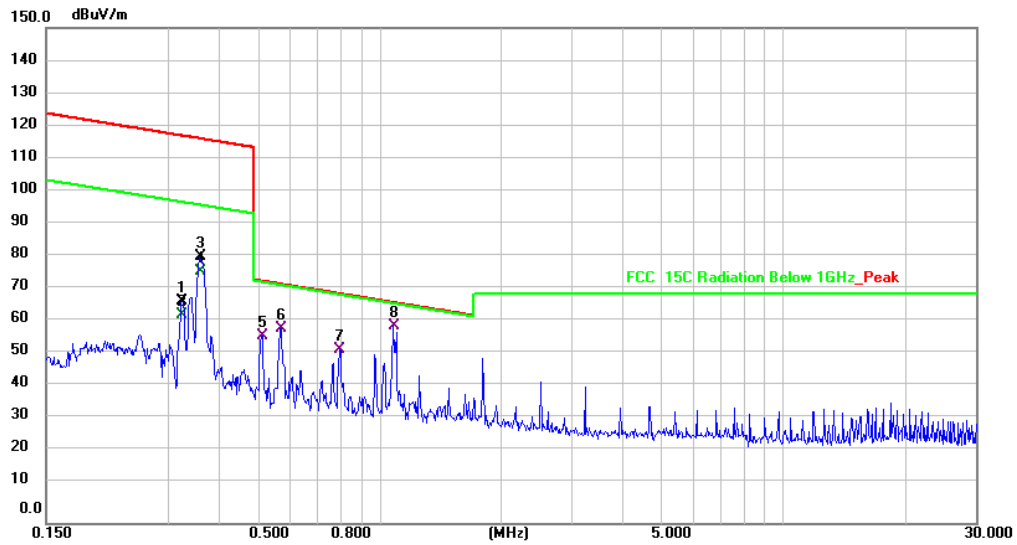

No.	Mk.	Freq. MHz	Reading Level dBuV	Correct Factor dB	Measure- ment dBuV/m	Limit dBuV/m	Over dB	Detector	Comment
1		0.3251	46.96	20.32	67.28	117.37	-50.09	peak	
2		0.3251	42.88	20.32	63.20	97.37	-34.17	AVG	
3		0.3596	60.34	20.33	80.67	116.49	-35.82	peak	
4		0.3596	55.87	20.33	76.20	96.49	-20.29	AVG	
5		0.5101	36.33	20.37	56.70	73.45	-16.75	QP	
6		0.5701	38.82	20.40	59.22	72.49	-13.27	QP	
7		0.7960	32.15	20.49	52.64	69.60	-16.96	QP	
8	*	1.0824	39.24	20.57	59.81	66.94	-7.13	QP	

Mode3 / Polarization: coaxial

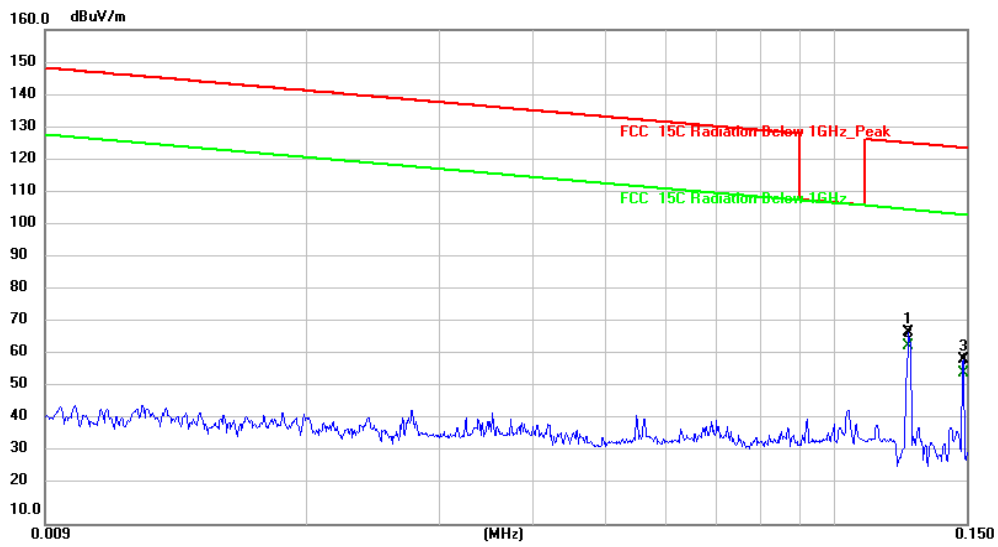

No.	Mk.	Freq.	Reading Level	Correct Factor	Measurement	Limit	Over	Detector	Comment
		MHz	dBuV	dB	dBuV/m	dBuV/m	dB		
1		0.1255	48.05	20.19	68.24	125.65	-57.41	peak	
2	*	0.1255	43.96	20.19	64.15	105.65	-41.50	AVG	
3		0.1481	39.97	20.26	60.23	124.21	-63.98	peak	
4		0.1481	35.85	20.26	56.11	104.21	-48.10	AVG	

Mode3 / Polarization: coaxial

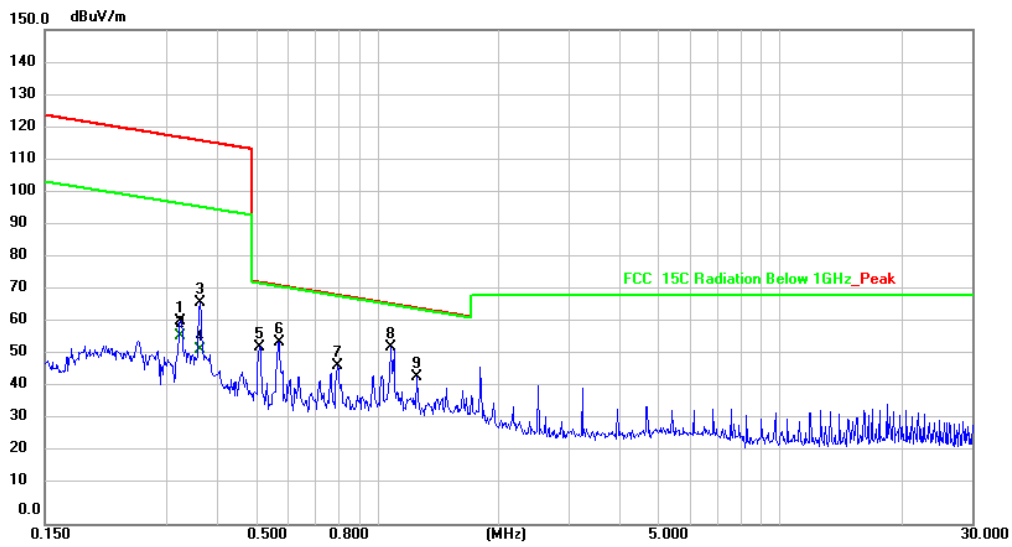

No. Mk.	Freq. MHz	Reading Level dBuV	Correct Factor dB	Measure- ment dBuV/m	Limit dBuV/m	Over dB	Detector	Comment
1	0.3251	41.46	20.32	61.78	117.37	-55.59	peak	
2	0.3251	36.82	20.32	57.14	97.37	-40.23	AVG	
3	0.3633	47.15	20.33	67.48	116.40	-48.92	peak	
4	0.3633	32.78	20.33	53.11	96.40	-43.29	AVG	
5	0.5100	33.33	20.37	53.70	73.45	-19.75	peak	
6	0.5700	34.82	20.40	55.22	72.49	-17.27	peak	
7	0.7960	27.65	20.49	48.14	69.60	-21.46	peak	
8 *	1.0823	33.24	20.57	53.81	66.94	-13.13	peak	
9	1.2554	24.23	20.59	44.82	65.65	-20.83	peak	

6.4 Emissions in frequency bands (30MHz - 1GHz)

Test Requirement:	47 CFR Part 15.209		
Test Limit:	Frequency (MHz)	Field strength (microvolts/meter)	Measurement distance (meters)
	0.009-0.490	2400/F(kHz)	300
	0.490-1.705	24000/F(kHz)	30
	1.705-30.0	30	30
	30-88	100 **	3
	88-216	150 **	3
	216-960	200 **	3
	Above 960	500	3
<p>** Except as provided in paragraph (g), fundamental emissions from intentional radiators operating under this section shall not be located in the frequency bands 54-72 MHz, 76-88 MHz, 174-216 MHz or 470-806 MHz. However, operation within these frequency bands is permitted under other sections of this part, e.g., §§ 15.231 and 15.241.</p> <p>In the emission table above, the tighter limit applies at the band edges. The emission limits shown in the above table are based on measurements employing a CISPR quasi-peak detector except for the frequency bands 9–90 kHz, 110–490 kHz and above 1000 MHz. Radiated emission limits in these three bands are based on measurements employing an average detector. As shown in § 15.35(b), for frequencies above 1000 MHz, the field strength limits in paragraphs (a) and (b) of this section are based on average limits. However, the peak field strength of any emission shall not exceed the maximum permitted average limits specified above by more than 20 dB under any condition of modulation. For point-to-point operation under paragraph (b) of this section, the peak field strength shall not exceed 2500 millivolts/meter at 3 meters along the antenna azimuth.</p>			
Test Method:	ANSI C63.10-2013 section 6.5		
Procedure:	ANSI C63.10-2013 section 6.5		

6.4.1 E.U.T. Operation:

Operating Environment:					
Temperature:	18.9 °C	Humidity:	65.2 %	Atmospheric Pressure:	99 kPa
Pre test mode:	Mode1, Mode2, Mode3, Mode4, Mode5, Mode6, Mode7, Mode8, Mode9, Mode10, Mode11, Mode12, Mode13, Mode14, Mode15, Mode16, Mode17, Mode18, Mode19, Mode20				
Final test mode:	All of the listed pre-test mode were tested, only the data of the worst mode (Mode4) is recorded in the report				

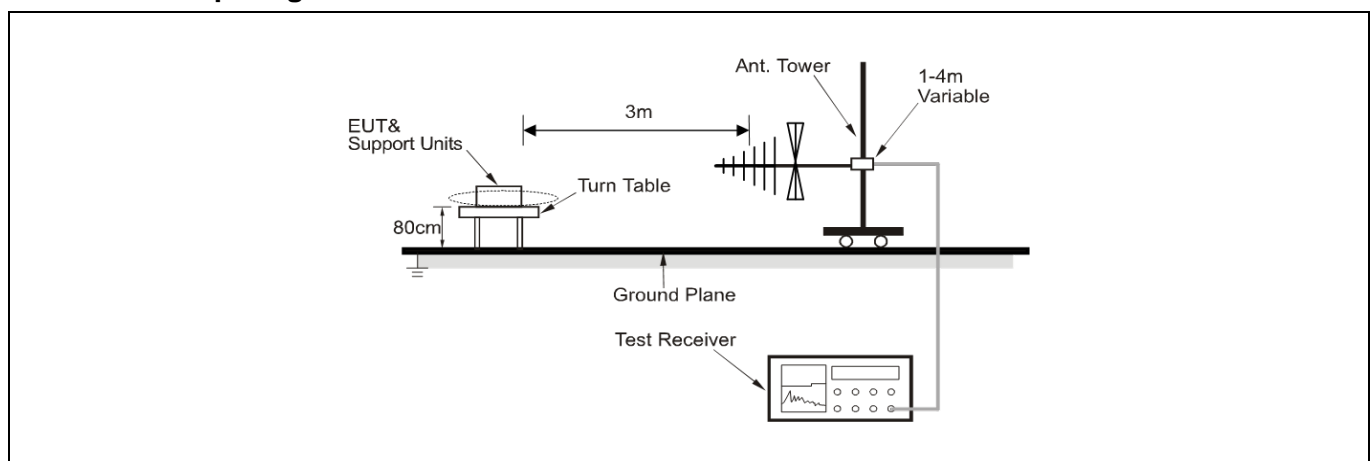
6.4.2 Test Setup Diagram:

6.4.3 Test Data:

Mode4 / Polarization: Horizontal

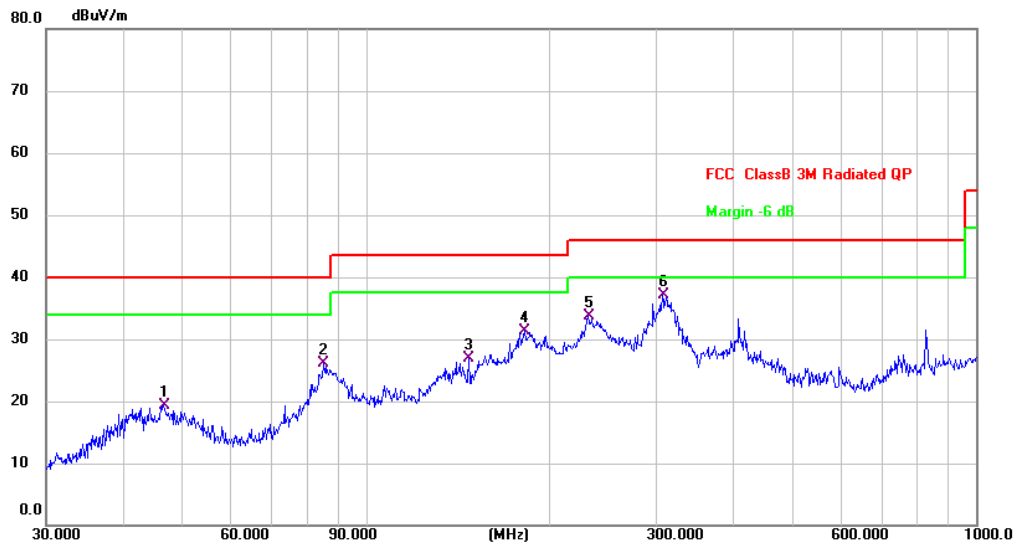

No.	Mk.	Freq. MHz	Reading Level dBuV	Correct Factor dB	Measure- ment dBuV/m	Limit dBuV/m	Over dB	Detector	Comment
1		46.6664	31.62	-12.33	19.29	40.00	-20.71	QP	
2		85.2980	42.45	-16.40	26.05	40.00	-13.95	QP	
3		147.4036	43.72	-16.78	26.94	43.50	-16.56	QP	
4		182.5592	46.10	-14.74	31.36	43.50	-12.14	QP	
5		231.7179	46.00	-12.24	33.76	46.00	-12.24	QP	
6	*	306.7537	47.05	-9.89	37.16	46.00	-8.84	QP	

Mode4 / Polarization: Vertical

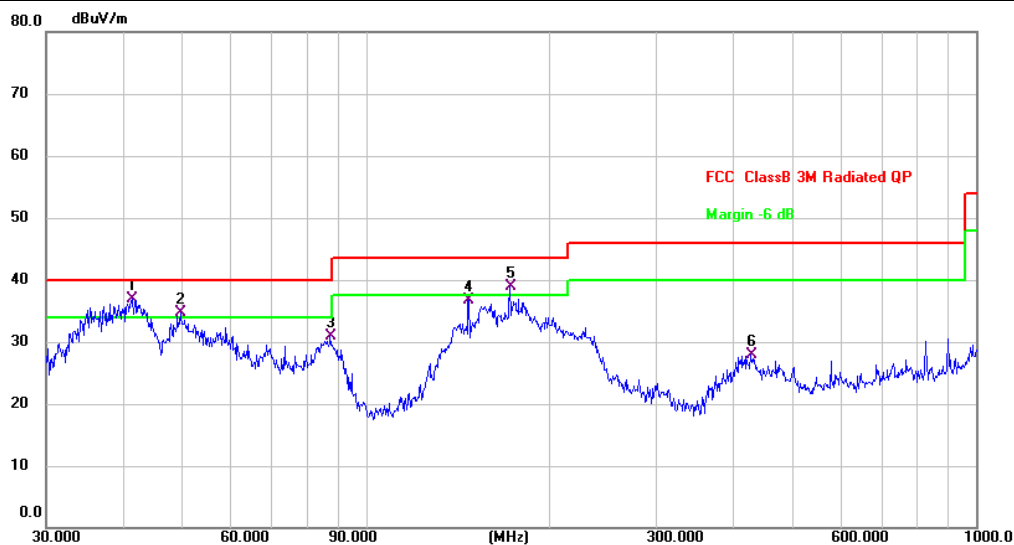

No.	Mk.	Freq.	Reading Level	Correct Factor	Measurement	Limit	Over	Detector	Comment
		MHz	dBuV	dB	dBuV/m	dBuV/m	dB		
1	*	41.5670	49.91	-13.03	36.88	40.00	-3.12	QP	
2	!	49.7068	46.86	-12.24	34.62	40.00	-5.38	QP	
3		87.4177	47.44	-16.58	30.86	40.00	-9.14	QP	
4		147.4036	53.50	-16.78	36.72	43.50	-6.78	QP	
5	!	171.9946	54.44	-15.61	38.83	43.50	-4.67	QP	
6		428.0193	35.95	-8.02	27.93	46.00	-18.07	QP	

Photographs of the test setup

Refer to Appendix - Test Setup Photos

Photographs of the EUT

Refer to Appendix - EUT Photos

----End of Report----