



DFS Test Report

FCC ID: 2AW68-NP2035G

Report No. : TBR-C-202305-0139-32
Applicant : Shenzhen SDMC Technology Co., Ltd.
Equipment Under Test (EUT)
EUT Name : AC2000 Dual Band WiFi GPON Terminal,
Dual Band WiFi GPON Terminal
Model No. : NP2035G
Series Model No. : NP2081GB
Brand Name : SDMC
Sample ID : HC-C-202305-0139-01-02
Receipt Date : 2023-06-25
Test Date : 2023-06-25 to 2023-07-13
Issue Date : 2023-07-13
Standards : 47 CFR FCC Part 15.407
Test Method : KDB 905462 D02 UNII DFS Compliance Procedures New Rules v02
Conclusions : **PASS**

In the configuration tested, the EUT complied with the standards specified above.

Test/Witness Engineer :  Seven Wu

Test/Witness Engineer :  Ivan Su

Approved & Authorized :  Ray Lai

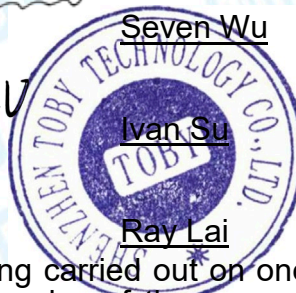

This report details the results of the testing carried out on one sample. The results contained in this test report do not relate to other samples of the same product. The manufacturer should ensure that all products in series production are in conformity with the product sample detailed in the report.

Contents

CONTENTS.....2

1. GENERAL INFORMATION ABOUT EUT.....4

1.1. Client Information.....4

1.2. General Description of EUT (Equipment Under Test)4

1.3. Test Facility.....6

2. TEST SOFTWARE.....7

3. SUPPORT EQUIPMENT.....7

4. TEST EQUIPMENT.....7

5. U-NII DFS RULE REQUIREMENTS8

5.1. Applicability of DFS requirements.....8

5.2. Test Limits and Radar Signal Parameters.....9

6. CALIBRATION OF RADAR WAVEFORM14

6.1. Test Procedure.....14

6.2. Conducted Calibration Test Setup15

6.3. Deviation from Test Standard15

6.4. Radar Waveform Calibration Result15

7. U-NII DFS TESTING16

7.1. Test Procedure.....16

7.2. Test Setup.....16

7.3. Channel Loading.....17

8. TESTING RESULTS.....18

8.1. Summary of Test Results18

8.2. DFS Detection Threshold18

8.3. Radar Waveform Calibration.....19

8.4. Channel Availability Check Time.....40

8.5. Statistical Performance check44

8.6. Channel Move Time and Channel Closing Transmission Time50

8.7. Non-occupancy Period.....51

8.8. U-NII Detection Bandwidth.....52



1. General Information about EUT

1.1. Client Information

Applicant	:	Shenzhen SDMC Technology Co., Ltd.
Address	:	Room 1022, Floor 10, Building A, Customs Building, No. 2, Xin'an 3rd Road, Dalang Community, Xin'an Street, Bao'an District, Shenzhen, China, 518000
Manufacturer	:	Shenzhen SDMC Technology Co., Ltd.
Address	:	Room 1022, Floor 10, Building A, Customs Building, No. 2, Xin'an 3rd Road, Dalang Community, Xin'an Street, Bao'an District, Shenzhen, China, 518000

1.2. General Description of EUT (Equipment Under Test)

EUT Name	:	AC2000 Dual Band WiFi GPON Terminal, Dual Band WiFi GPON Terminal
Models No.	:	NP2035G, NP2081GB
Model Difference	:	All these models are identical in the same PCB, layout and electrical circuit, The only difference is model name and product name.
Operating Frequency Band	:	<input checked="" type="checkbox"/> 5260-5320MHz <input checked="" type="checkbox"/> 5500-5720MHz
TPC	:	<input type="checkbox"/> No <input checked="" type="checkbox"/> Yes
Power Rating	:	AC Adapter (Model:SA182V-120150U)(SUNUN) Input: 100-240V~50/60Hz 0.4A Output: 12.0V=1.5A
Software Version	:	N/A
Hardware Version	:	V1.0
Function	:	This device was functioned as a <input checked="" type="checkbox"/> Master <input type="checkbox"/> Slave device with radar detection <input type="checkbox"/> Slave device without radar detection

Note:

- (1) For a more detailed features description, please refer to the manufacturer's specifications or the User's Manual.
- (2) Antenna information provided by the applicant.

Band	Antenna Type	Antenna Gain			
		Ant.1	Ant.2	Ant.3	Ant.4
Band 2	PCB	5.06dBi	4.72dBi	5.39dBi	5.03dBi
Band 3		5.36dBi	5.06dBi	5.34dBi	5.10dBi



(3) Conducted Output Power&E.I.R.P and PSD

Mode: TX (802.11ac(VHT20))						
Frequency Band (MHz)	Ant.	Max Conducted Power (dBm)	Gain ((dBi)	Max E.I.R.P (dBm)	Max E.I.R.P (mW)	Max.PSD (dBm/MHz)
5260~5320	1	11.66	5.06	16.72	46.99	5.57
	2	11.69	4.72	16.41	43.75	
	3	10.49	5.39	15.88	38.73	
	4	11.57	5.03	16.60	45.71	
5500~5720	1	11.49	5.36	16.85	48.42	5.72
	2	12.12	5.06	17.18	52.24	
	3	11.35	5.34	16.69	46.67	
	4	12.10	5.10	17.20	52.48	
Mode: TX (802.11ac(VHT40))						
Frequency Band (MHz)	Ant.	Max Conducted Power (dBm)	Gain ((dBi)	Max E.I.R.P (dBm)	Max E.I.R.P (mW)	Max.PSD (dBm/MHz)
5260~5320	1	14.83	5.06	19.89	97.50	5.41
	2	14.51	4.72	19.23	83.75	
	3	13.04	5.39	18.43	69.66	
	4	14.44	5.03	19.47	88.51	
5500~5720	1	14.60	5.36	19.96	99.08	5.75
	2	14.97	5.06	20.03	100.69	
	3	14.02	5.34	19.36	86.30	
	4	15.15	5.10	20.25	105.93	
Mode: TX (802.11ac(VHT80))						
Frequency Band (MHz)	Ant.	Max Conducted Power (dBm)	Gain ((dBi)	Max E.I.R.P (dBm)	Max E.I.R.P (mW)	Max.PSD (dBm/MHz)
5260~5320	1	14.13	5.06	19.19	82.99	2.12
	2	13.86	4.72	18.58	72.11	
	3	12.45	5.39	17.84	60.81	
	4	14.00	5.03	19.03	79.98	
5500~5720	1	11.90	5.36	17.26	53.21	0.94
	2	12.42	5.06	17.48	55.98	
	3	11.78	5.34	17.12	51.52	
	4	12.96	5.10	18.06	63.97	



1.3. Test Facility

The testing report were performed by the Shenzhen Toby Technology Co., Ltd., in their facilities located at 1/F.,Building 6, Rundongsheng Industrial Zone, Longzhu, Xixiang, Bao'an District, Shenzhen, Guangdong, China. At the time of testing, the following bodies accredited the Laboratory:

CNAS (L5813)

The Laboratory has been accredited by CNAS to ISO/IEC 17025: 2017 General Requirements for the Competence of Testing and Calibration Laboratories for the competence in the field of testing. And the Registration No.: CNAS L5813.

A2LA Certificate No.: 4750.01

The laboratory has been accredited by American Association for Laboratory Accreditation(A2LA) to ISO/IEC 17025: 2017 General Requirements for the Competence of Testing and Calibration Laboratories for the technical competence in the field of Electrical Testing. And the A2LA Certificate No.: 4750.01.FCC Accredited Test Site Number: 854351. Designation Number: CN1223.

IC Registration No.: (11950A)

The Laboratory has been registered by Certification and Engineering Bureau of Industry Canada for radio equipment testing. The site registration: Site# 11950A. CAB identifier: CN0056.



2. Test Software

Test Item	Test Software	Manufacturer	Version No.
RF Test System	JS1120-3	Tonscend	V3.2.22

3. Support Equipment

Equipment Information				
Name	Model	S/N	Manufacturer	Used “√”
Notebook	T430	-----	Thinkpad	√
Notebook	T450s	-----	Thinkpad	√
Tablet computer	AYANEO AIR Pro	-----	AYANEO	√

4. Test Equipment

Antenna Conducted Emission					
Equipment	Manufacturer	Model No.	Serial No.	Last Cal.	Cal. Due Date
Spectrum Analyzer	Rohde & Schwarz	FSV40-N	102197	Jun. 20, 2023	Jun. 19, 2024
Vector Signal Generator	Agilent	N5182A	MY50141294	Sep.01.2022	Aug. 31, 2023
Analog Signal Generator	Agilent	N5181A	MY48180463	Sep.01.2022	Aug. 31, 2023
Vector Signal Generator	KEYSIGT	N5182B	MY59101429	Sep.01.2022	Aug. 31, 2023
Analog Signal Generator	KEYSIGHT	N5173B	MY61252685	Sep.01.2022	Aug. 31, 2023
Frequency Extender	KEYSIGHT	N5182BX07	MY59360126	Sep.01.2022	Aug. 31, 2023
RF Control Unit	Tonsced	JS0806-2	21F8060439	Sep. 01, 2022	Aug. 31, 2023
Power Control Box	Tonsced	JS0806-4ADC	21C8060387	N/A	N/A



5. U-NII DFS Rule Requirements

5.1. Applicability of DFS requirements

The manufacturer shall state whether the UUT is capable of operating as a Master and/or a Client. If the UUT is capable of operating in more than one operating mode then each operating mode shall be tested separately. See tables 1 and 2 for the applicability of DFS requirements for each of the operational modes.

Table 1: Applicability of DFS requirements prior to use a channel

Requirement	Operational Mode		
	<input checked="" type="checkbox"/> Master	<input type="checkbox"/> Client without radar detection	<input type="checkbox"/> Client with radar detection
Non-Occupancy Period	✓	Not required	✓
DFS Detection Threshold	✓	Not required	✓
Channel Availability Check Time	✓	Not required	Not required
U-NII Detection Bandwidth	✓	Not required	✓

Table 2: Applicability of DFS requirements during normal operation

Requirement	Operational Mode		
	<input checked="" type="checkbox"/> Master	<input type="checkbox"/> Client without radar detection	<input type="checkbox"/> Client with radar detection
DFS Detection Threshold	✓	Not required	✓
Channel Closing Transmission Time	✓	✓	✓
Channel Move Time	✓	✓	✓
U-NII Detection Bandwidth	✓	Not required	✓



Additional requirements for devices with multiple bandwidth modes	<input checked="" type="checkbox"/> Master Device or Client with Radar Detection	<input type="checkbox"/> Client without Detection
Detection Bandwidth and Statistical Performance Check	All BW modes must be tested	Not required
Channel Move Time and Channel Closing Transmission Time	Test using widest BW mode available	Test using widest BW mode available
All other tests	Any single BW mode	Not required

Note: Frequencies selected for statistical performance check (section 7.8.4) should include several frequencies within the radar detection bandwidth and frequencies near the edge of the radar detection bandwidth. For 802.11 devices it is suggested to select frequencies in each of the bonded 20MHz channels and the channel center frequency.

5.2. Test Limits and Radar Signal Parameters

DETECTION THRESHOLD VALUES

Table 5: DFS Detection Thresholds for Master Devices and Client Devices with Radar Detection.

Maximum Transmit Power	Value (See Notes 1 and 2)
EIRP ≥ 200 milliwatt	-64 dBm
EIRP < 200 milliwatt and Power spectral density < 10 dBm/MHz	-62 dBm
EIRP < 200 milliwatt that do not meet the power spectral density requirement	-64 dBm

Note 1: This is the level at the input of the receiver assuming a 0 dBi receive antenna.

Note 2: Throughout these test procedures an additional 1 dB has been added to the amplitude of the test transmission waveforms to account for variations in measurement equipment. This will ensure that the test signal is at or above the detection threshold level to trigger a DFS response.

Note 3: E.I.R.P is based on the highest antenna gain. For MIMO devices refer to KDB Publication 662911 D01.



Table 6: DFS Response Requirement Values

Parameter	Value
Non-occupancy period	Minimum 30 minutes
Channel Availability Check Time	60 seconds
Channel Move Time	10 seconds See Note 1.
Channel Closing Transmission Time	200 milliseconds + an aggregate of 60 milliseconds over remaining 10 second period. See Notes 1 and 2.
U-NII Detection Bandwidth	Minimum 100% of the UNII 99% transmission power bandwidth. See Note 3.

Note 1: Channel Move Time and the Channel Closing Transmission Time should be performed with Radar Type 0. The measurement timing begins at the end of the Radar Type 0 burst.

Note 2: The Channel Closing Transmission Time is comprised of 200 milliseconds starting at the beginning of the Channel Move Time plus any additional intermittent control signals required to facilitate a Channel move (an aggregate of 60 milliseconds) during the remainder of the 10 second period. The aggregate duration of control signals will not count quiet periods in between transmissions.

Note 3: During the U-NII Detection Bandwidth detection test, radar type 0 should be used. For each frequency step the minimum percentage of detection is 90 percent. Measurements are performed with no data traffic.



PARAMETERS OF DFS TEST SIGNALS

Step intervals of 0.1 microsecond for Pulse Width, 1 microsecond for PRI, 1 MHz for chirp width and 1 for the number of pulses will be utilized for the random determination of specific test waveforms.

Table 7: Short Pulse Radar Test Waveforms.

Radar Type	Pulse Width (μsec)	PRI (μsec)	Number of Pulses	Minimum Percentage of Successful Detection	Minimum Number of Trials
0	1	1428	18	See Note 1	See Note 1
1	1	Test A: 15 unique PRI values randomly selected from the list of 23 PRI values in Table 5a	Roundup $\left\{ \begin{matrix} \frac{1}{360} \\ \frac{19 \cdot 10^6}{PRI_{\mu sec}} \end{matrix} \right\}$	60%	30
		Test B: 15 unique PRI values randomly selected within the range of 518-3066 μsec, with a minimum increment of 1 μsec, excluding PRI values selected in Test A			
2	1-5	150-230	23-29	60%	30
3	6-10	200-500	16-18	60%	30
4	11-20	200-500	12-16	60%	30
Aggregate (Radar Types 1-4)				80%	120
Note 1: Short Pulse Radar Type 0 should be used for the detection bandwidth test, channel move time, and channel closing time tests.					

A minimum of 30 unique waveforms are required for each of the Short Pulse Radar Types 2 through 4. If more than 30 waveforms are used for Short Pulse Radar Types 2 through 4, then each additional waveform must also be unique and not repeated from the previous waveforms. If more than 30 waveforms are used for Short Pulse Radar Type 1, then each additional waveform is generated with Test B and must also be unique and not repeated from the previous waveforms in Tests A or B.



Table 7a: Pulse Repetition Intervals Values for Test A.

Pulse Repetition Frequency Number	Pulse Repetition Frequency (Pulses Per Second)	Pulse Repetition Interval (Microseconds)
1	1930.5	518
2	1858.7	538
3	1792.1	558
4	1730.1	578
5	1672.2	598
6	1618.1	618
7	1567.4	638
8	1519.8	658
9	1474.9	678
10	1432.7	698
11	1392.8	718
12	1355	738
13	1319.3	758
14	1285.3	778
15	1253.1	798
16	1222.5	818
17	1193.3	838
18	1165.6	858
19	1139	878
20	1113.6	898
21	1089.3	918
22	1066.1	938
23	326.2	3066



Table 8: Long Pulse Radar Test Waveform

Radar Type	Pulse Width (µsec)	Chirp Width (MHz)	PRI (µsec)	Number of Pulses per Burst	Number of Bursts	Minimum Percentage of Successful Detection	Minimum Number of Trials
5	50-100	5-20	1000-2000	1-3	8-20	80%	30

The parameters for this waveform are randomly chosen (The center frequency for each of the 30 trials of the Bin 5 radar shall be randomly selected within 80% of the Occupied Bandwidth.)

Thirty unique waveforms are required for the Long Pulse Radar Type waveforms. If more than 30 waveforms are used for the Long Pulse Radar Type waveforms, then each additional waveform must also be unique and not repeated from the previous waveforms.

Table 9: Frequency Hopping Radar Test Waveform

Radar Type	Pulse Width (µsec)	Chirp Width (MHz)	PRI (µsec)	Number of Pulses per Burst	Number of Bursts	Minimum Percentage of Successful Detection	Minimum Number of Trials
6	1	333	9	0.333	300	70%	30



6. Calibration of Radar Waveform

6.1. Test Procedure

1. A 50 ohm load is connected in place of the spectrum analyzer, and the spectrum analyzer is connected in place of the master device and the signal generator is set to CW mode. The amplitude of the signal generator is adjusted to yield a level of -62dBm as measured on the spectrum analyzer.
2. Without changing any of the instrument settings, the spectrum analyzer is reconnected to the Common port of the Spectrum Analyzer Combiner/Divider. Measure the amplitude and calculate the difference from -62dBm . Adjust the Reference Level Offset of the spectrum analyzer to this difference.
3. The spectrum analyzer displays the level of the signal generator as received at the antenna ports of the Master Device. The interference detection threshold may be varied from the calibrated value of -62dBm and the spectrum analyzer will still indicate the level as received by the Master Device.
4. Set the signal generator to produce a radar waveform, trigger a burst manually and measure the level on the spectrum analyzer. Readjust the amplitude of the signal generator as required so that the peak level of the waveform is at a displayed level equal to the required or desired interference detection threshold. Separate signal generator amplitude settings are determined as required for each radar type.

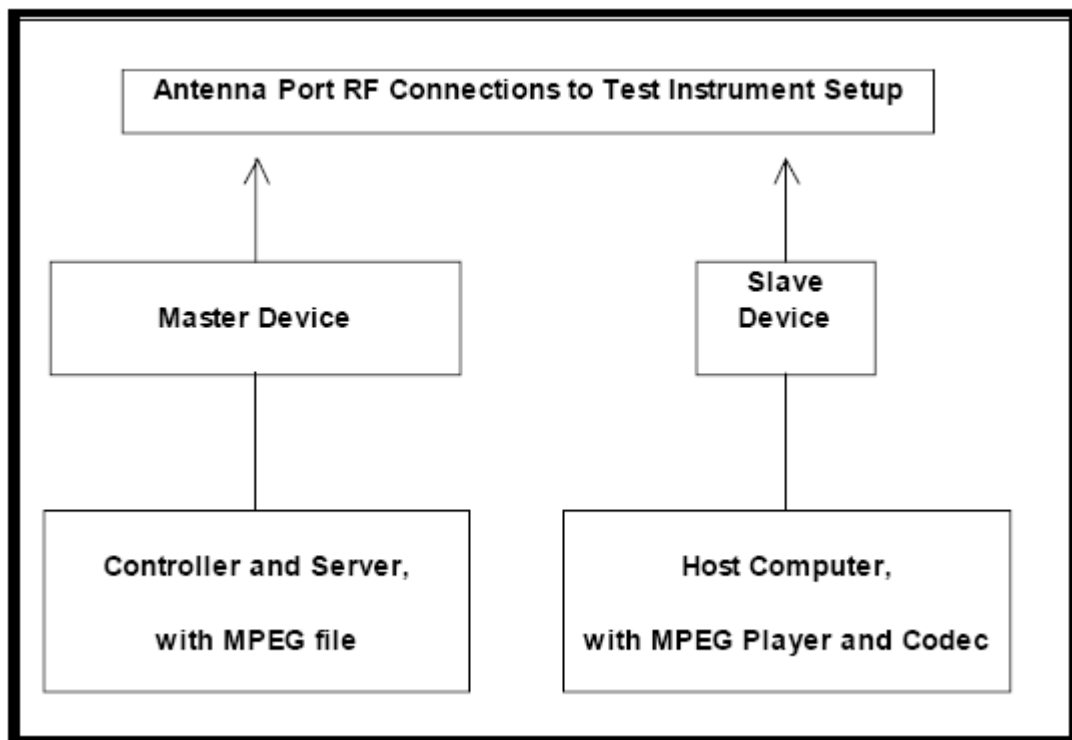

6.2. Conducted Calibration Test Setup

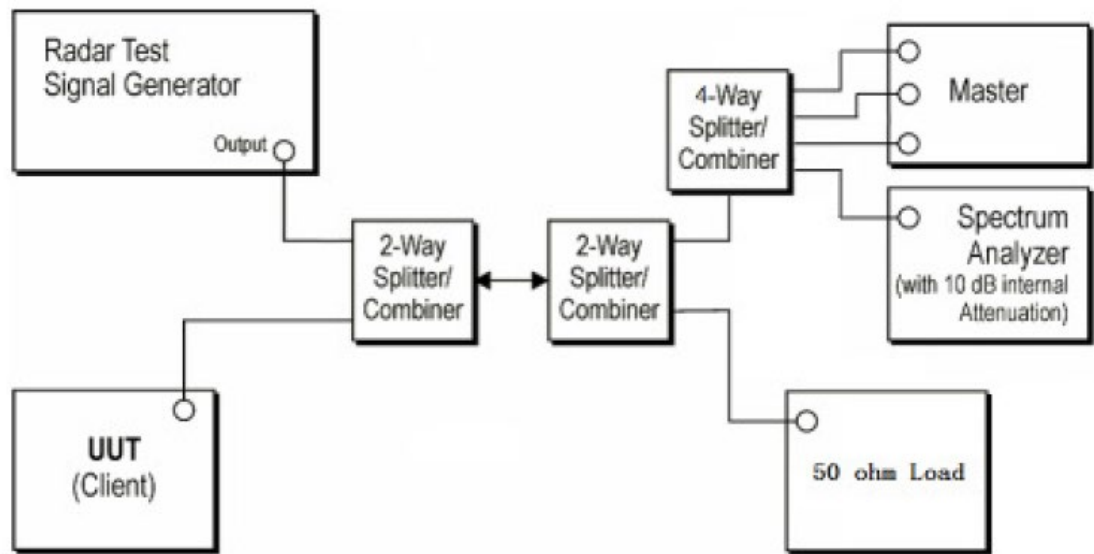

6.3. Deviation from Test Standard

No Deviation

6.4. Radar Waveform Calibration Result



7. U-NII DFS Testing

7.1. Test Procedure

1. Master device and client device are set up by conduction method as the following configuration.
2. The client device is connected to notebook and to access a IP address on wireless connection with the master device.
3. Then the master device is connected to another notebook to access a IP address.
4. Finally, let the two IP addresses run traffic with each other through the Run flow software “Lan test” to reach 17% channel loading as below:

7.2. Test Setup

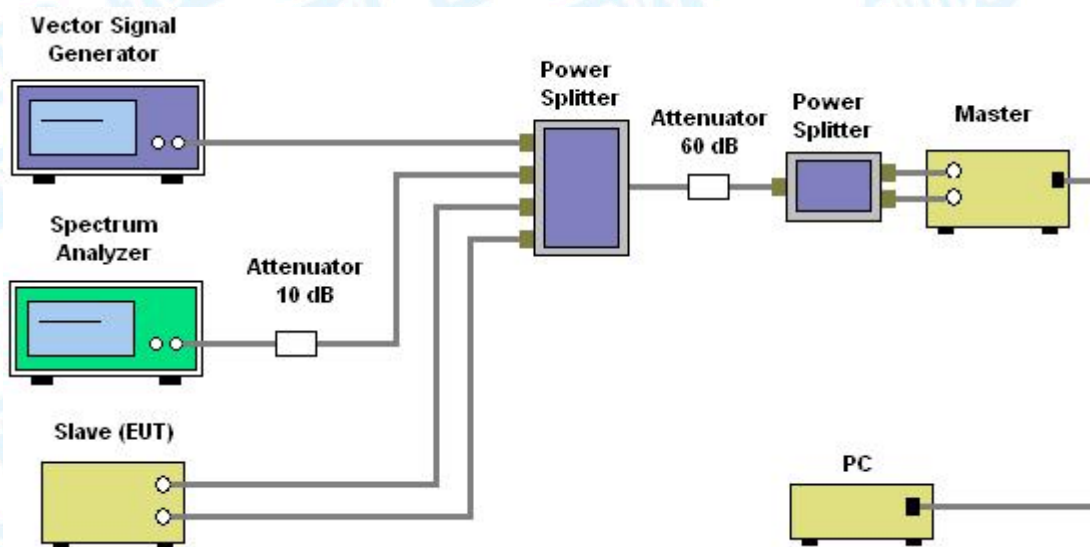

7.3. Channel Loading

Test Mode	Frequency[MHz]	Result	Limit [%]	Verdict
11AC160	5290	20.24	17	PASS
	5530	17.89	17	PASS

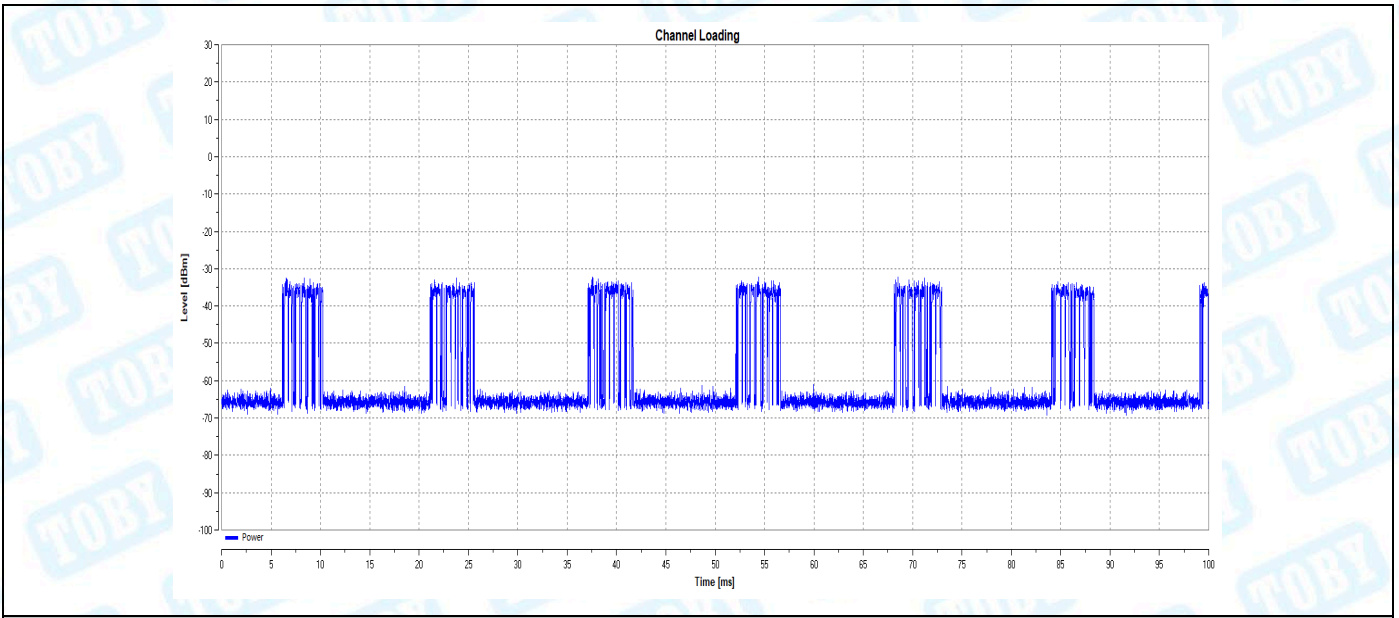

11AC80-5290

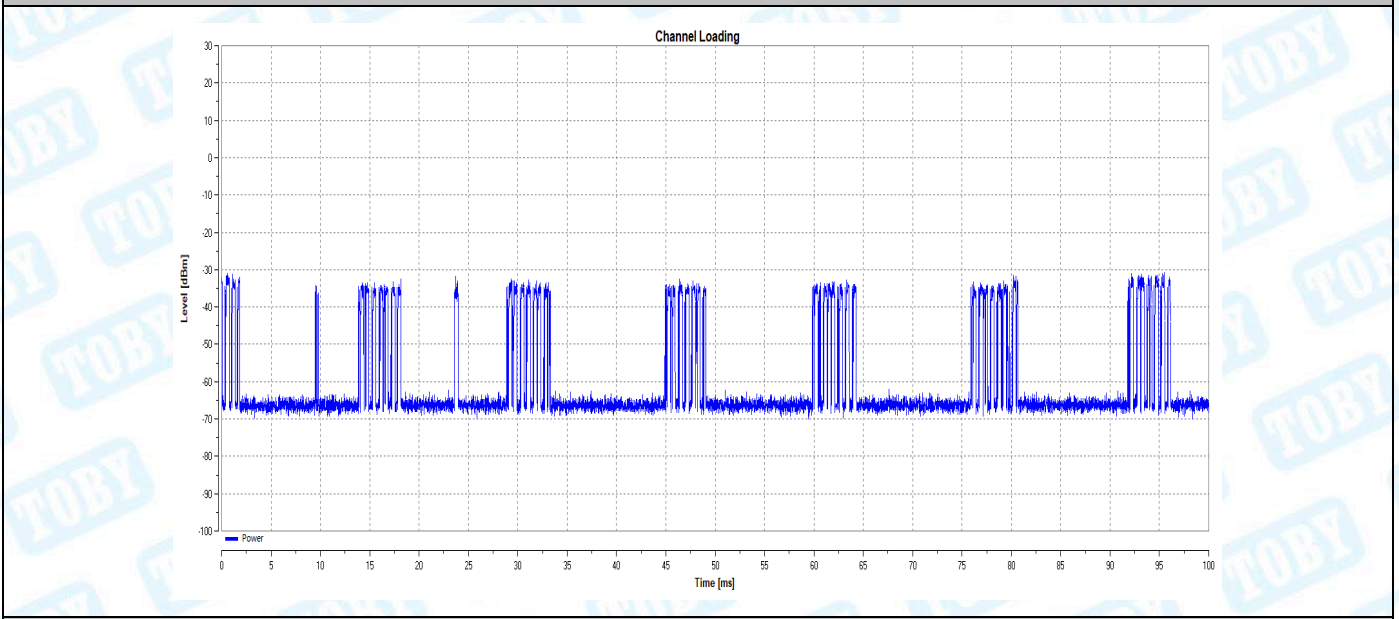

11AC80-5530



8. Testing Results

8.1. Summary of Test Results

Clause	Test Parameter	Remarks	Pass/Fail
15.407	DFS Detection Threshold	Applicable	Pass
15.407	Channel Availability Check Time	Applicable	Pass
15.407	Channel Move Time	Applicable	Pass
15.407	Channel Closing Transmission Time	Applicable	Pass
15.407	Non- Occupancy Period	Applicable	Pass
15.407	Statistical Performance Check	Applicable	Pass
15.407	U-NII Detection Bandwidth	Applicable	Pass
Test Mode			
Device operating in master mode.			
Master with injection at the Master. (Radar Test Waveforms are injected into the Master)			

8.2. DFS Detection Threshold

Calibration:

For a detection threshold level of -62dBm and the Max. antenna gain is 5.39dBi, required detection threshold is $-56.61\text{dBm} = (-62 + 5.39)\text{dBm}$.

To meet the stringent requirement, the DFS test used the detection threshold level of -64dBm.

Note: EIRP < 200 milliwatt and Power spectral density < 10 dBm/MHz in this report, so detection threshold level is -62dBm (please refer to page 5).



8.3. Radar Waveform Calibration

Test Mode	Frequency[MHz]	Radar Type	Result	Limit[dBm]	Verdict
11AC20	5260	Type0	-64.29	-64.00	PASS
		Type1	-64.18	-64.00	PASS
		Type2	-64.03	-64.00	PASS
		Type3	-64.40	-64.00	PASS
		Type4	-64.29	-64.00	PASS
		Type5	-64.21	-64.00	PASS
	5500	Type6	-64.45	-64.00	PASS
		Type0	-64.39	-64.00	PASS
		Type1	-64.36	-64.00	PASS
		Type2	-64.08	-64.00	PASS
		Type3	-64.25	-64.00	PASS
		Type4	-64.06	-64.00	PASS
11AC40	5270	Type5	-64.30	-64.00	PASS
		Type6	-64.23	-64.00	PASS
		Type0	-64.19	-64.00	PASS
		Type1	-64.13	-64.00	PASS
		Type2	-64.17	-64.00	PASS
		Type3	-64.15	-64.00	PASS
	5510	Type4	-64.15	-64.00	PASS
		Type5	-64.38	-64.00	PASS
		Type6	-64.27	-64.00	PASS
		Type0	-64.23	-64.00	PASS
		Type1	-64.29	-64.00	PASS
		Type2	-64.00	-64.00	PASS
11AC80	5290	Type3	-64.15	-64.00	PASS
		Type4	-64.21	-64.00	PASS
		Type5	-64.44	-64.00	PASS
		Type6	-64.28	-64.00	PASS
		Type0	-64.38	-64.00	PASS
		Type1	-64.08	-64.00	PASS
	5530	Type2	-64.01	-64.00	PASS
		Type3	-64.20	-64.00	PASS
		Type4	-64.41	-64.00	PASS
		Type5	-64.49	-64.00	PASS
		Type6	-64.43	-64.00	PASS
		Type0	-64.12	-64.00	PASS
5530	Type1	-64.16	-64.00	PASS	
	Type2	-64.20	-64.00	PASS	
	Type3	-64.25	-64.00	PASS	
	Type4	-64.13	-64.00	PASS	
	Type5	-64.42	-64.00	PASS	
	Type6	-64.42	-64.00	PASS	



11AC20_5260_Type0

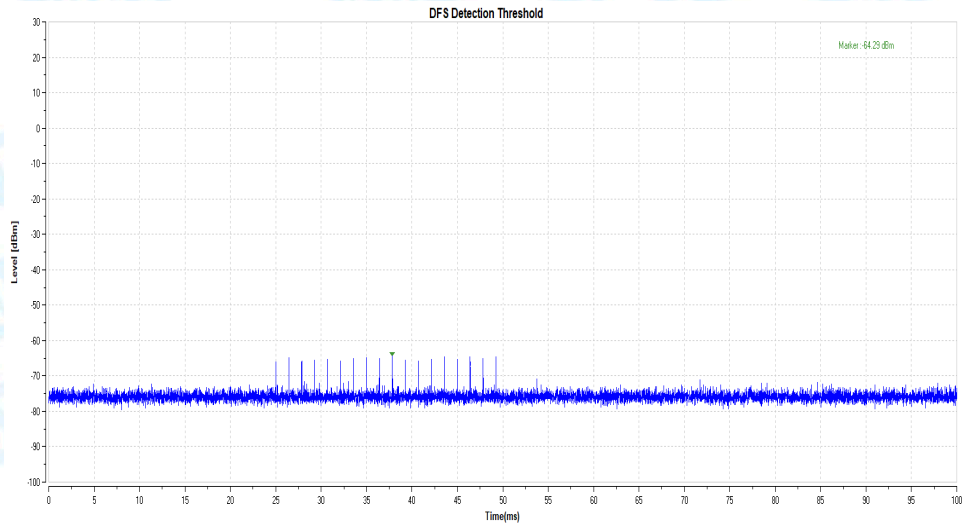

11AC20_5260_Type1

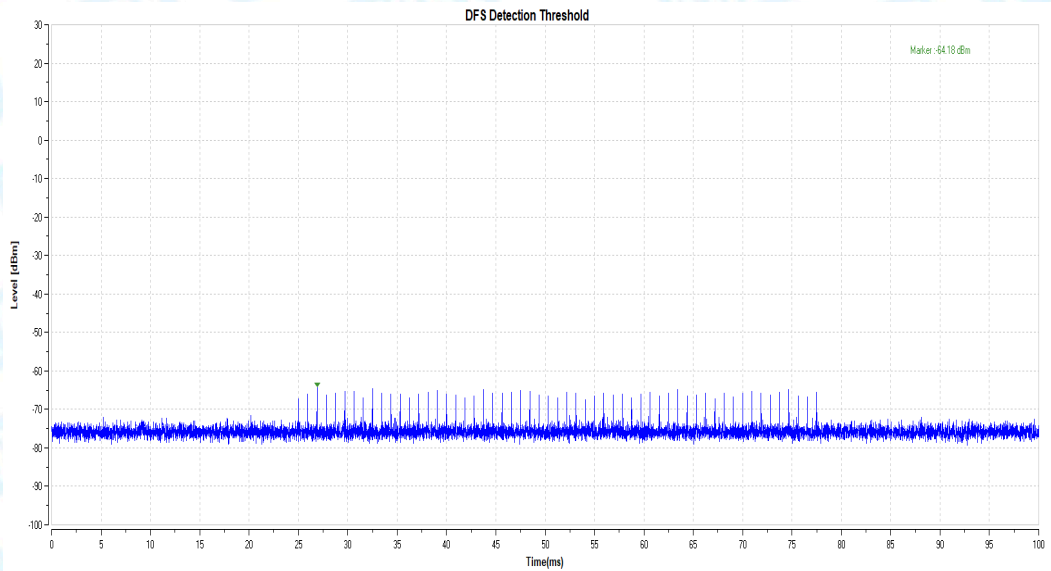

11AC20_5260_Type2

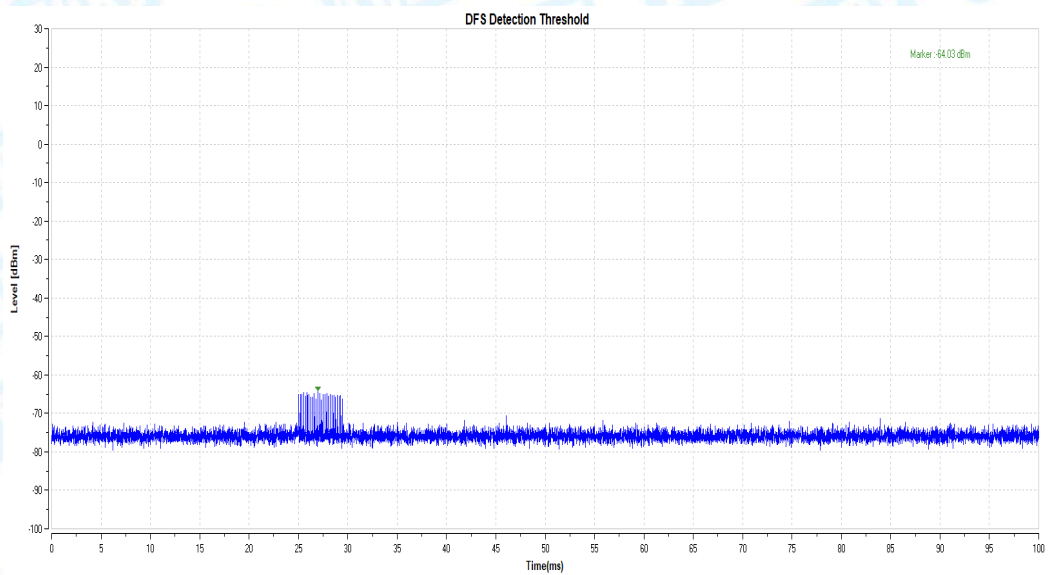

11AC20_5260_Type3

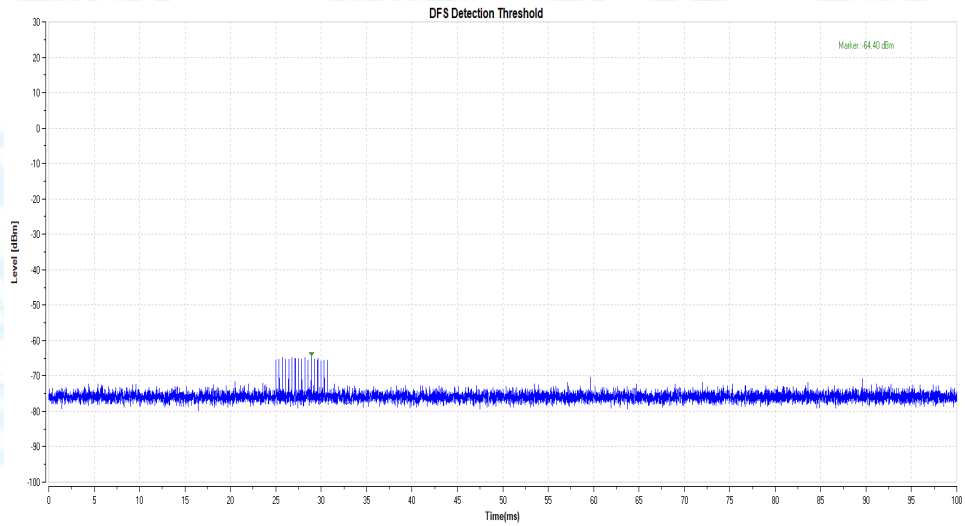

11AC20_5260_Type4

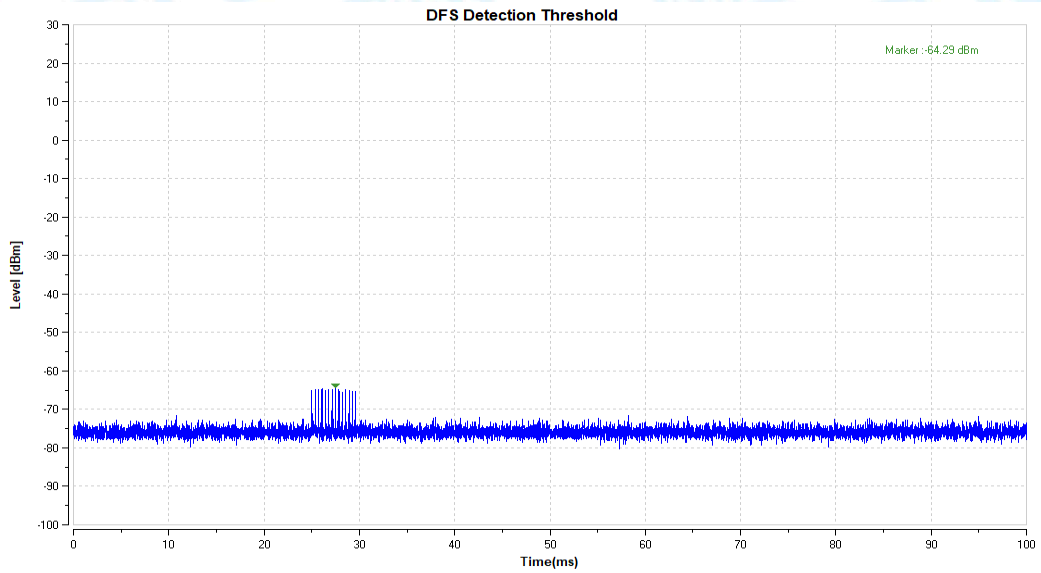

11AC20_5260_Type5

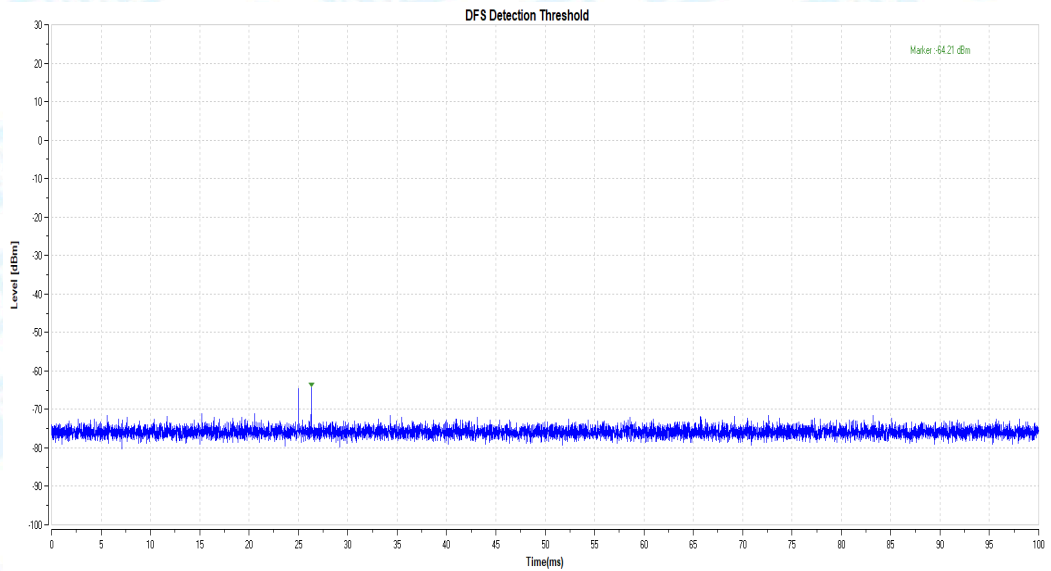

11AC20_5260_Type6

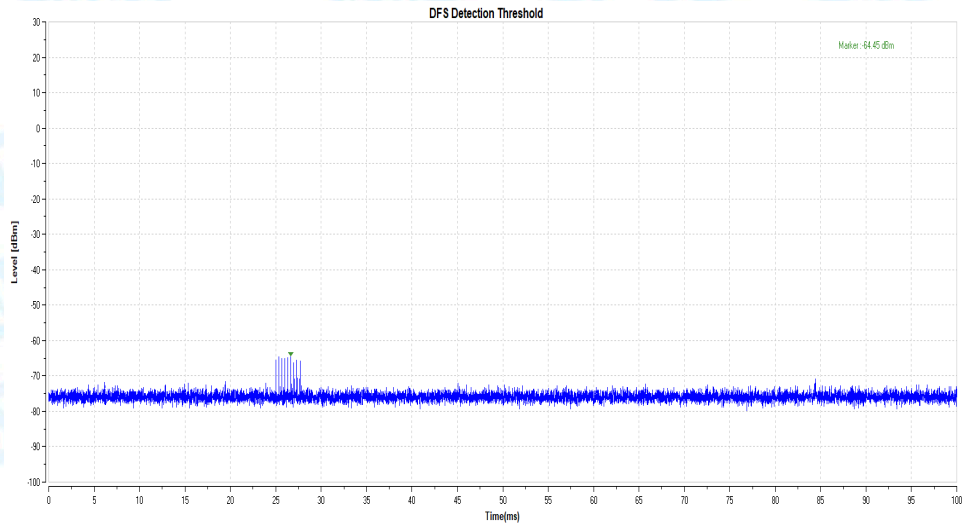

11AC20_5500_Type0

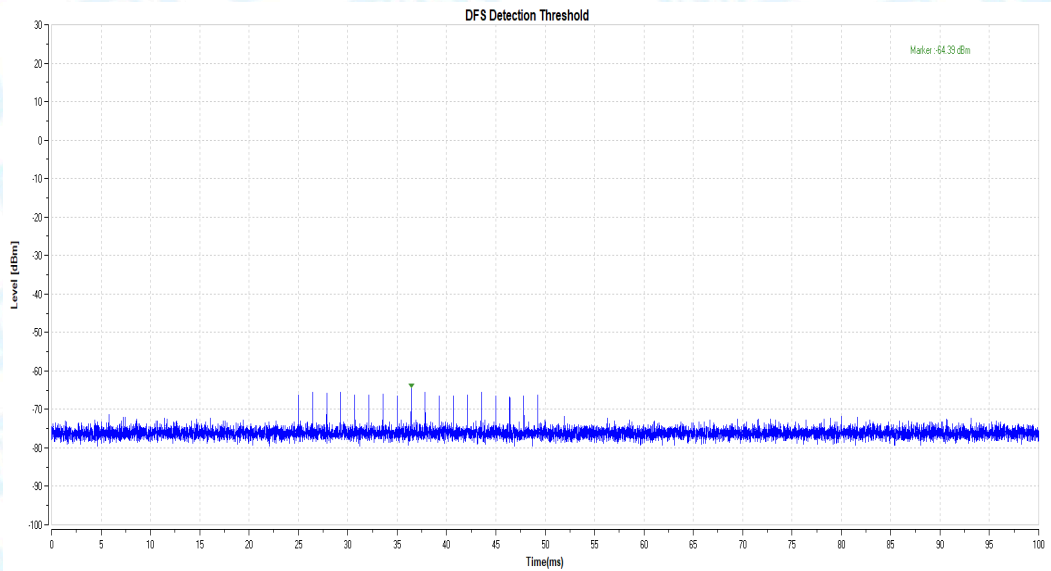

11AC20_5500_Type1

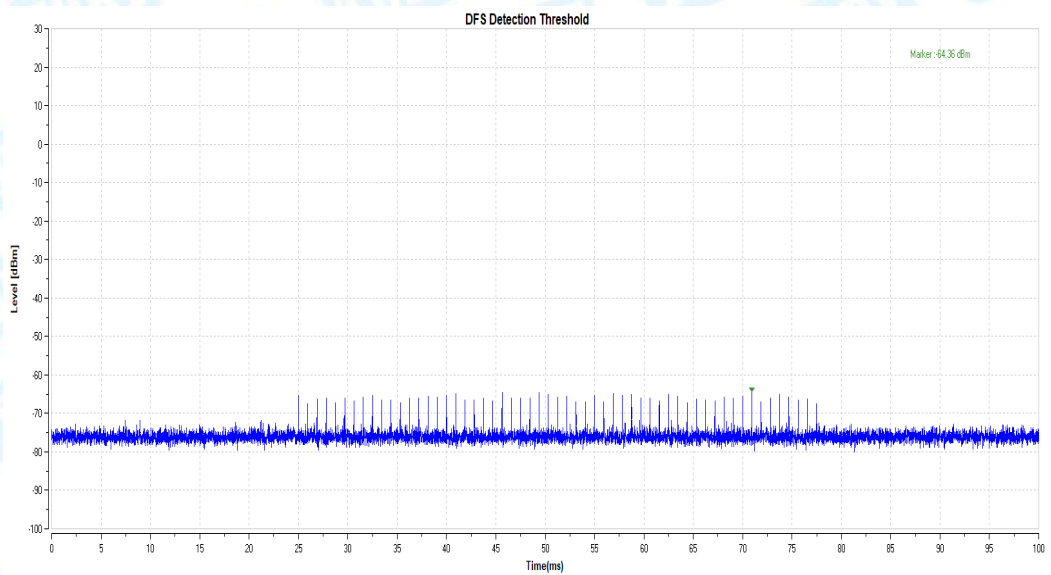

11AC20_5500_Type2

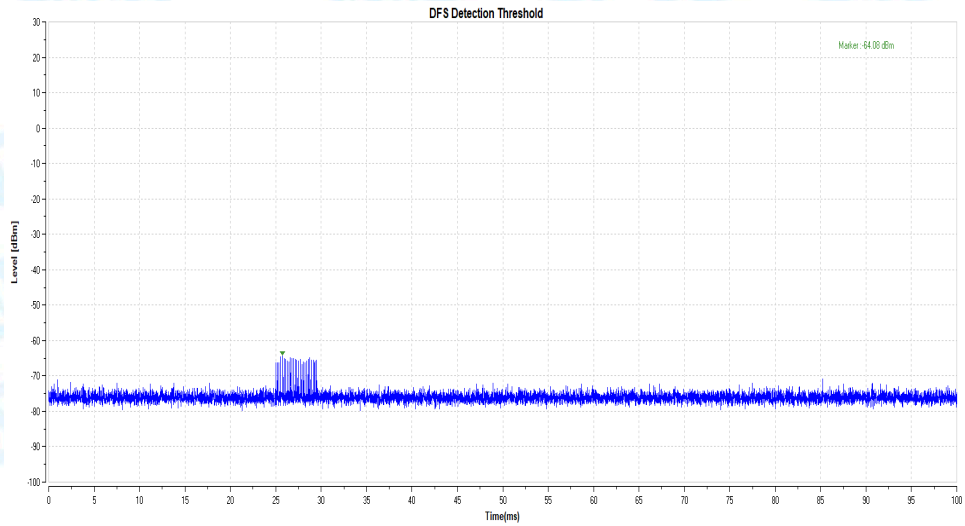

11AC20_5500_Type3

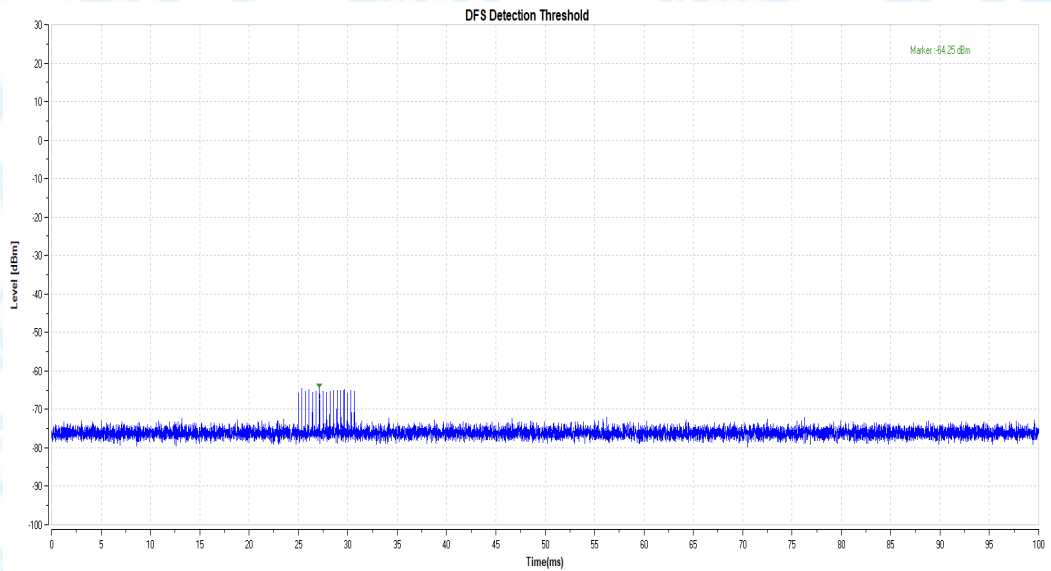

11AC20_5500_Type4

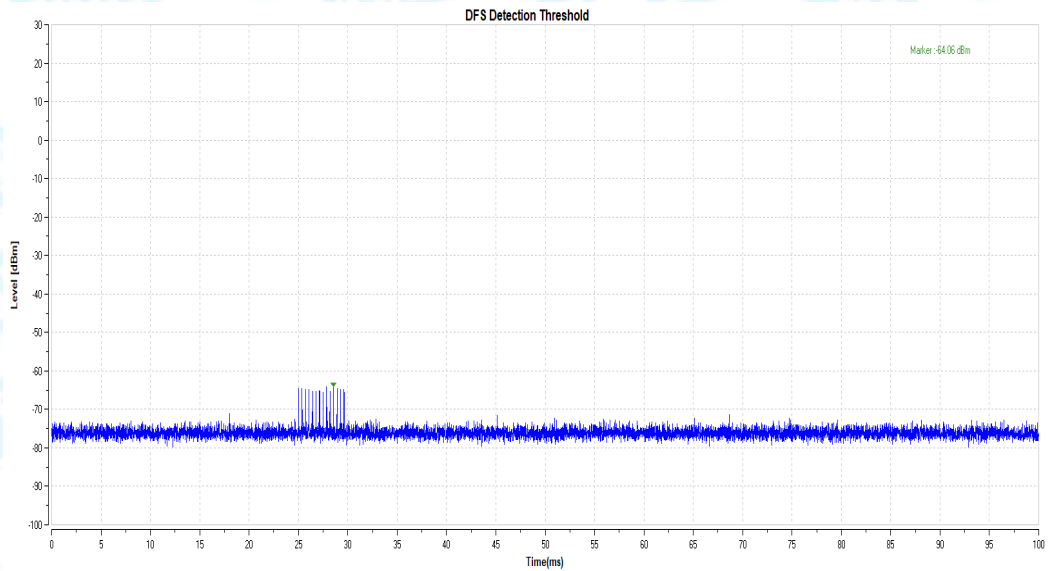

11AC20_5500_Type5

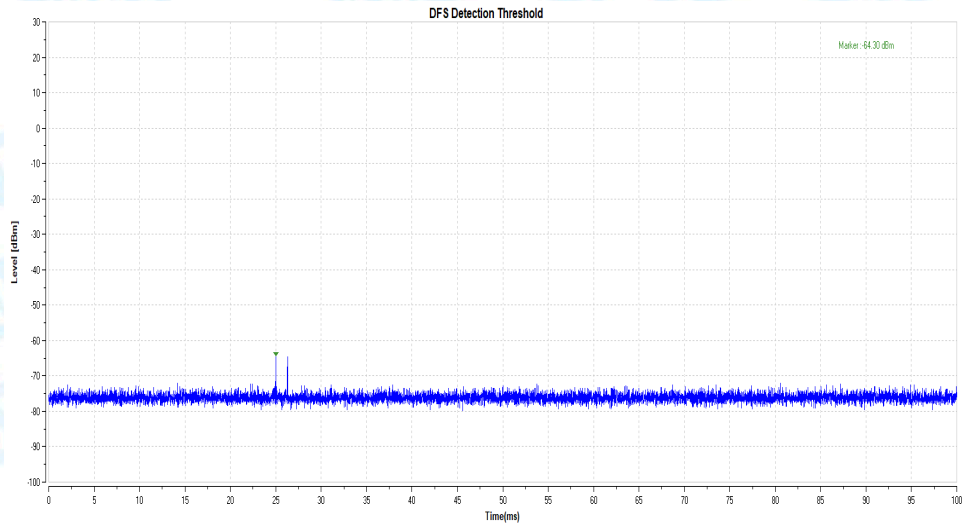

11AC20_5500_Type6

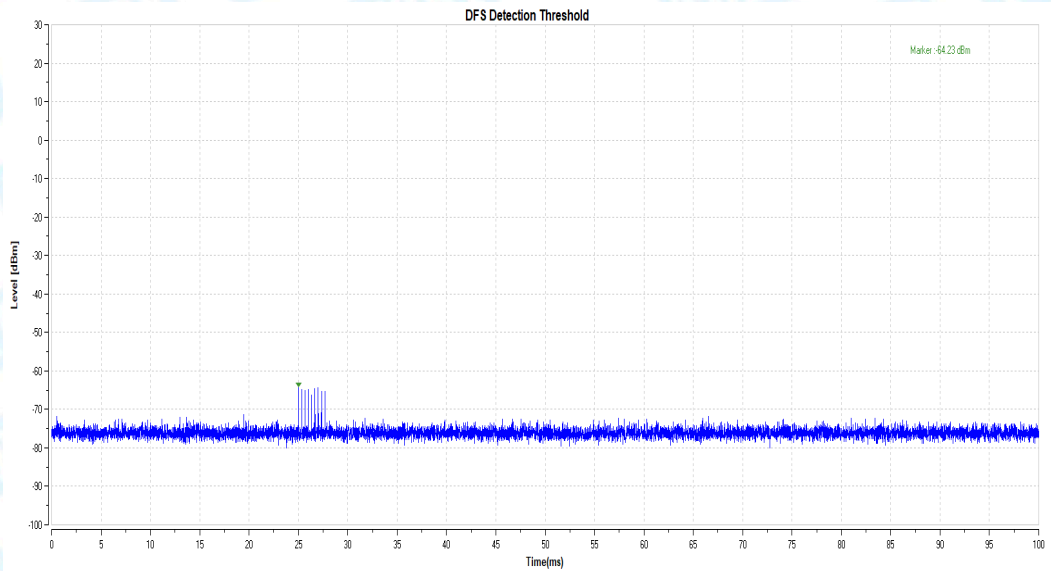

11AC40_5270_Type0

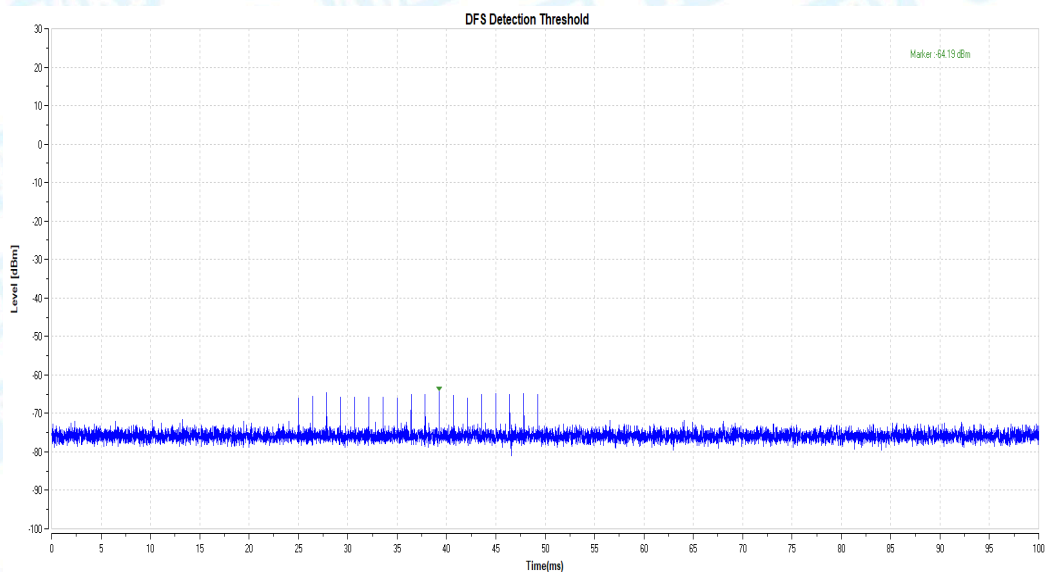

11AC40_5270_Type1

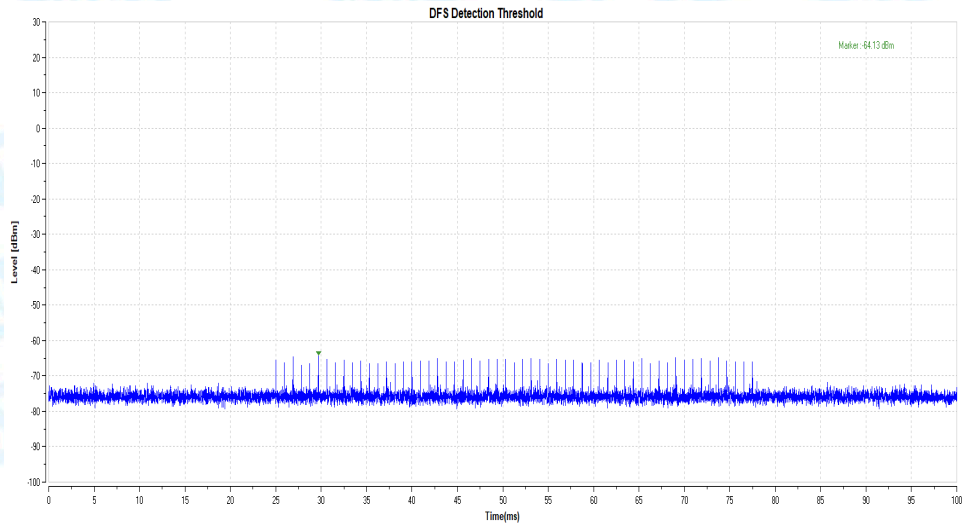

11AC40_5270_Type2

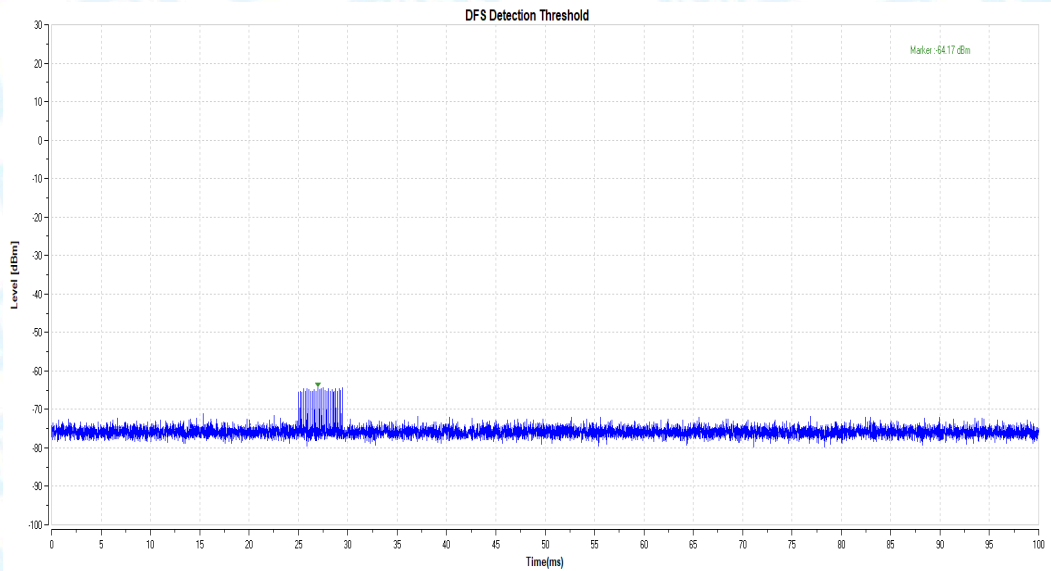

11AC40_5270_Type3

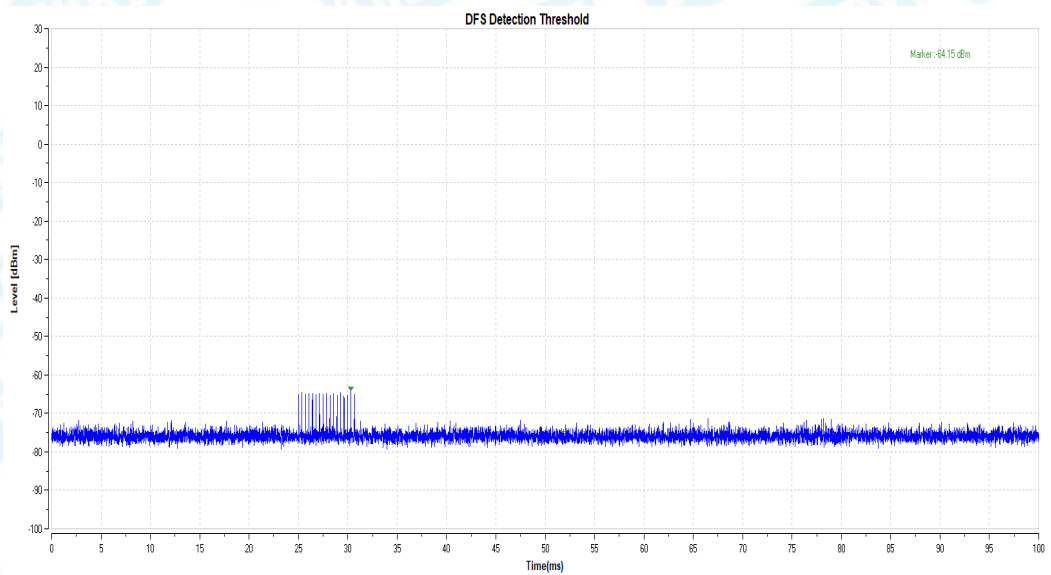

11AC40_5270_Type4

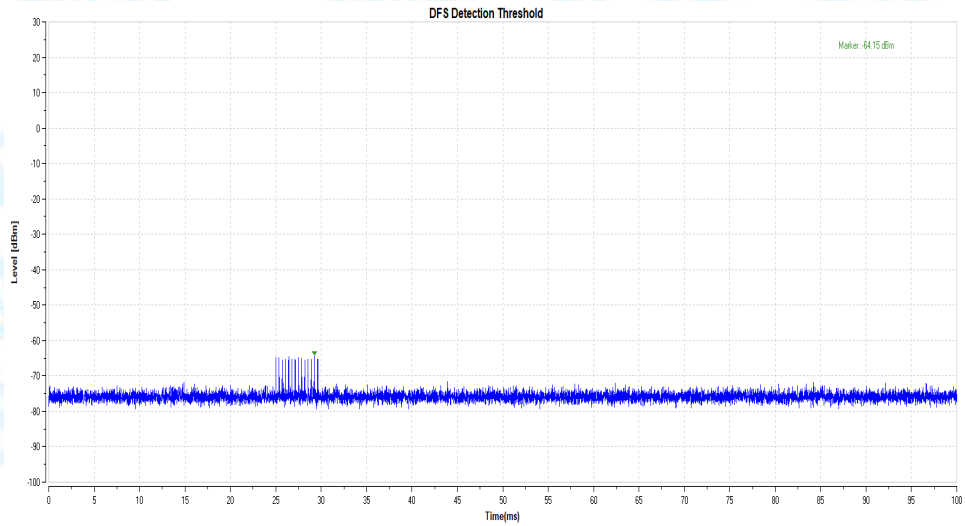

11AC40_5270_Type5

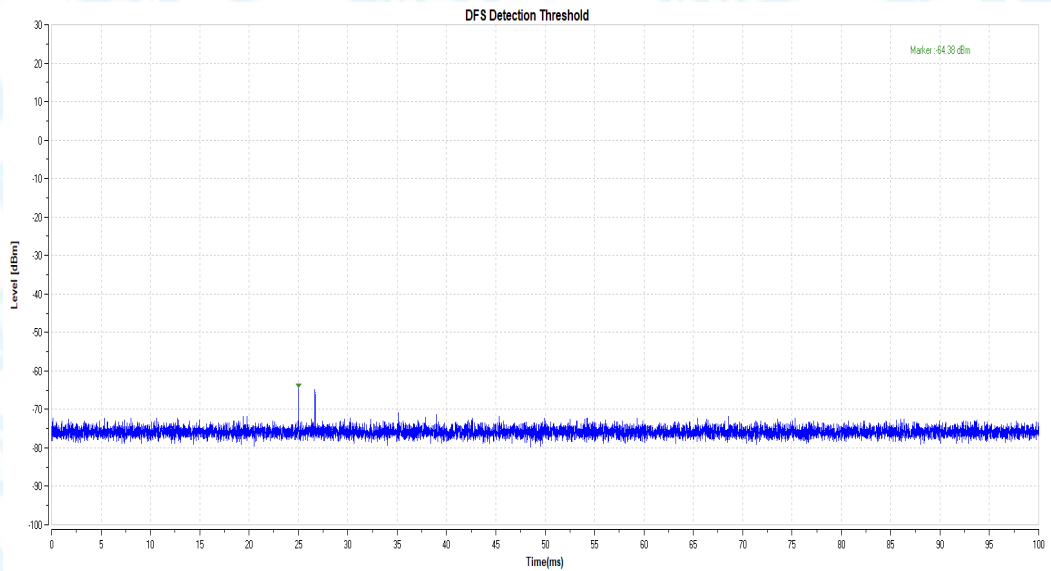

11AC40_5270_Type6

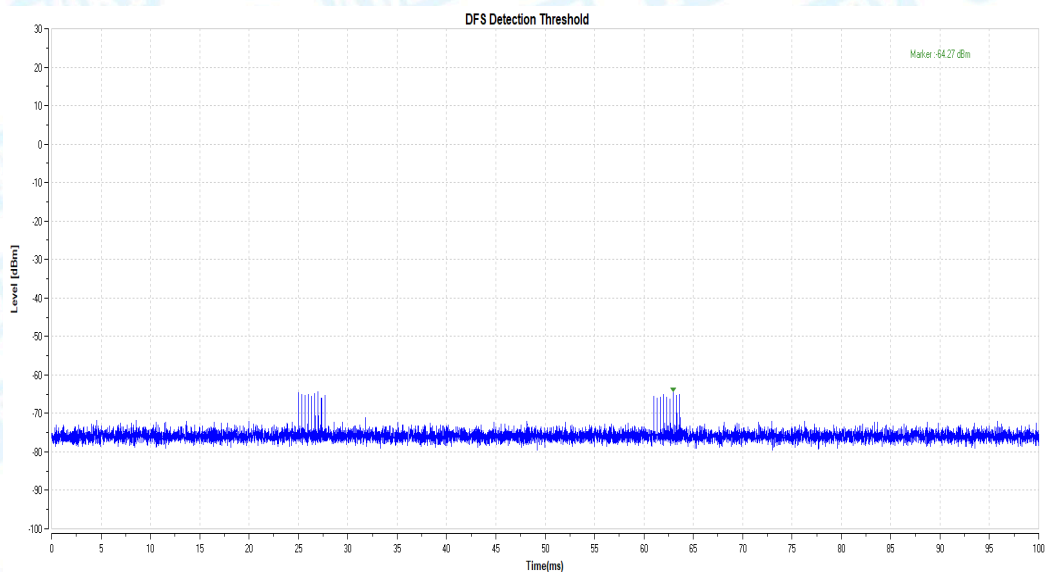

11AC40_5510_Type0

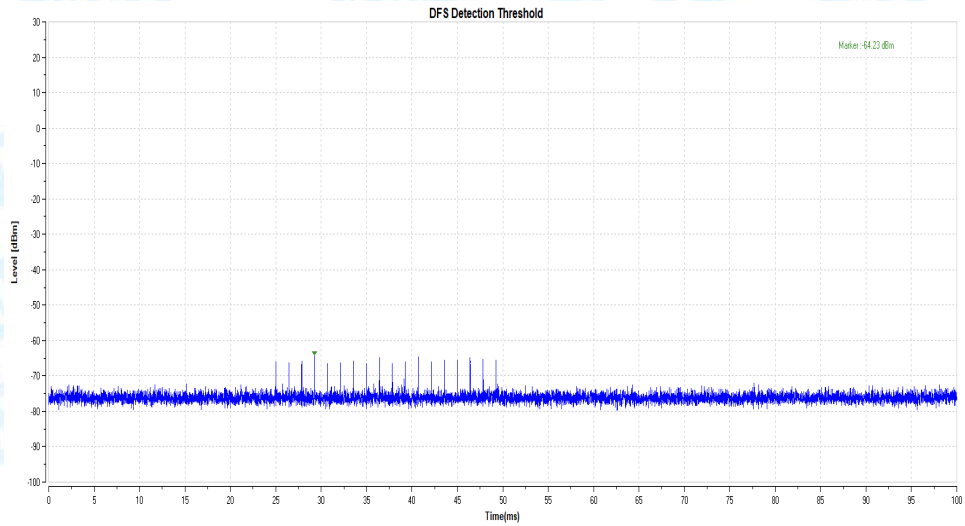

11AC40_5510_Type1

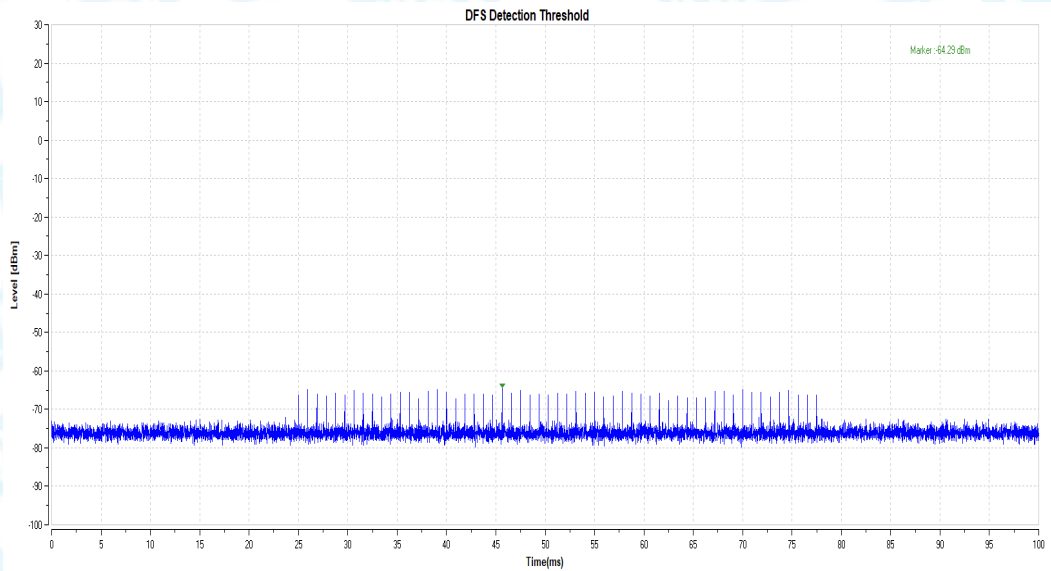

11AC40_5510_Type2

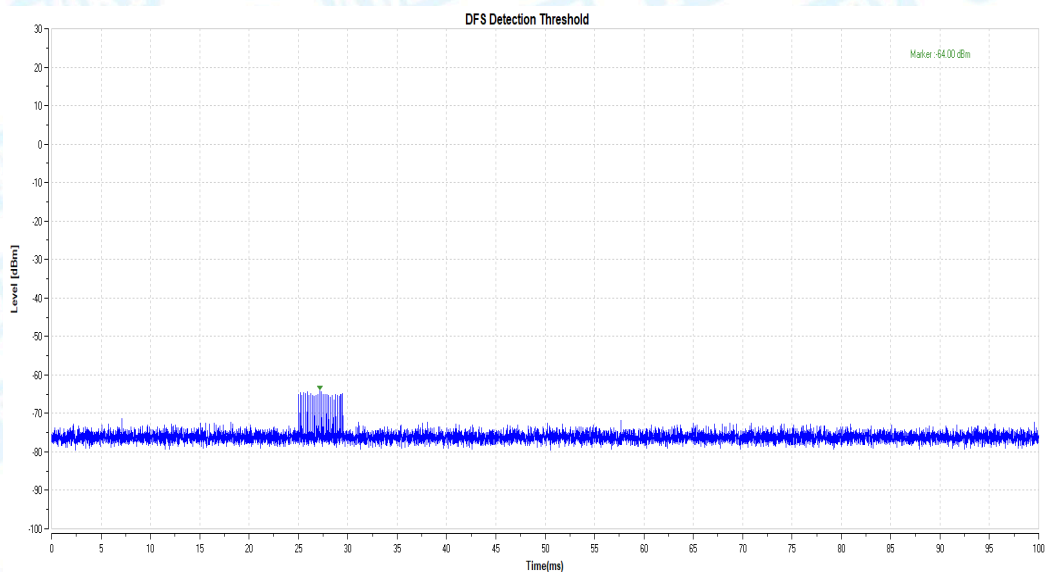

11AC40_5510_Type3

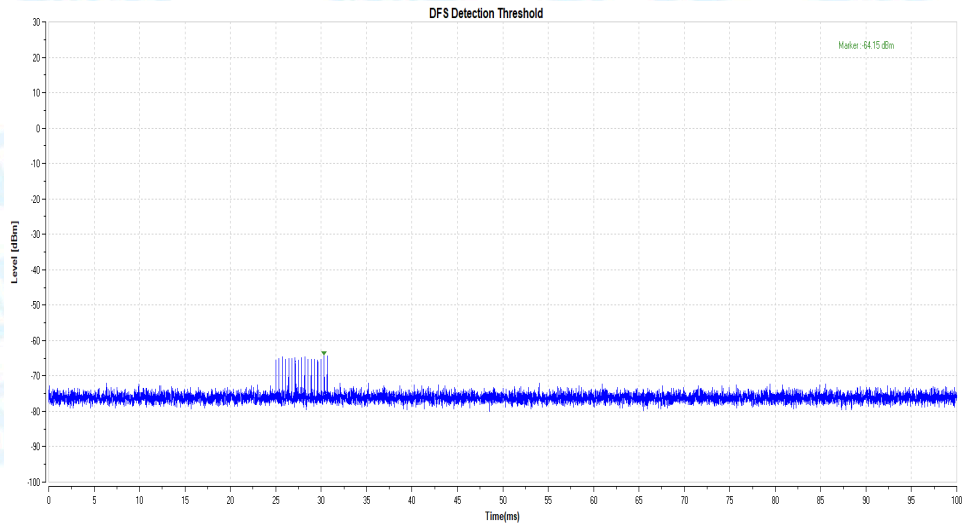

11AC40_5510_Type4

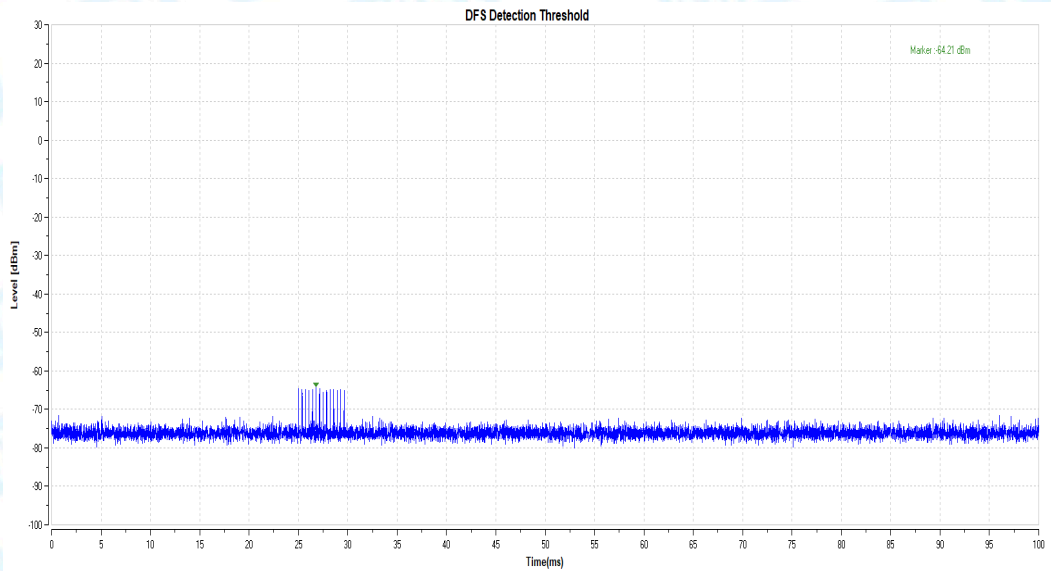

11AC40_5510_Type5

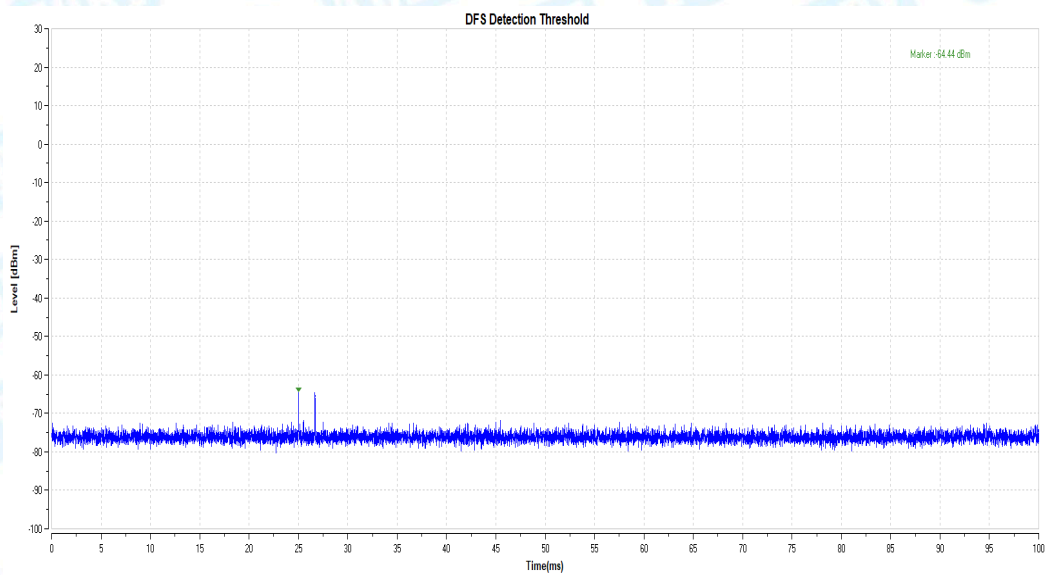

11AC40_5510_Type6

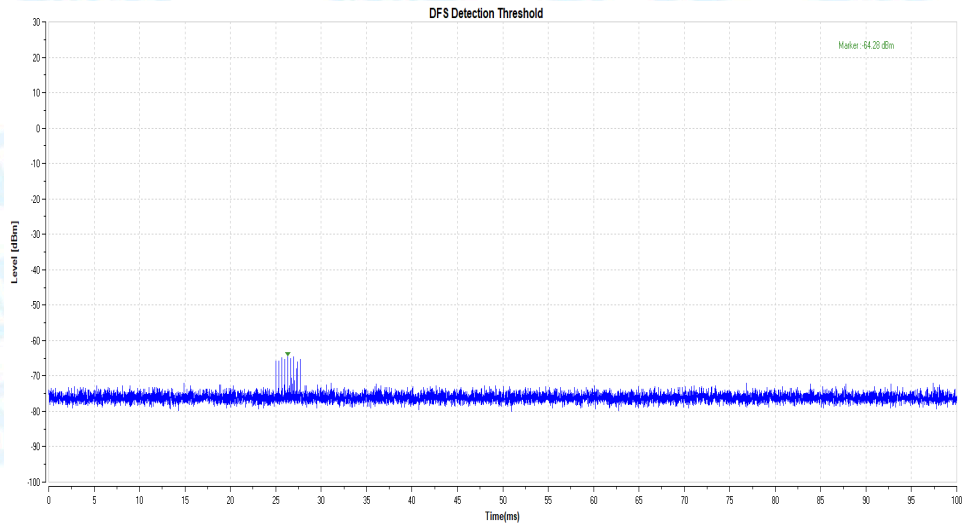

11AC80_5290_Type0

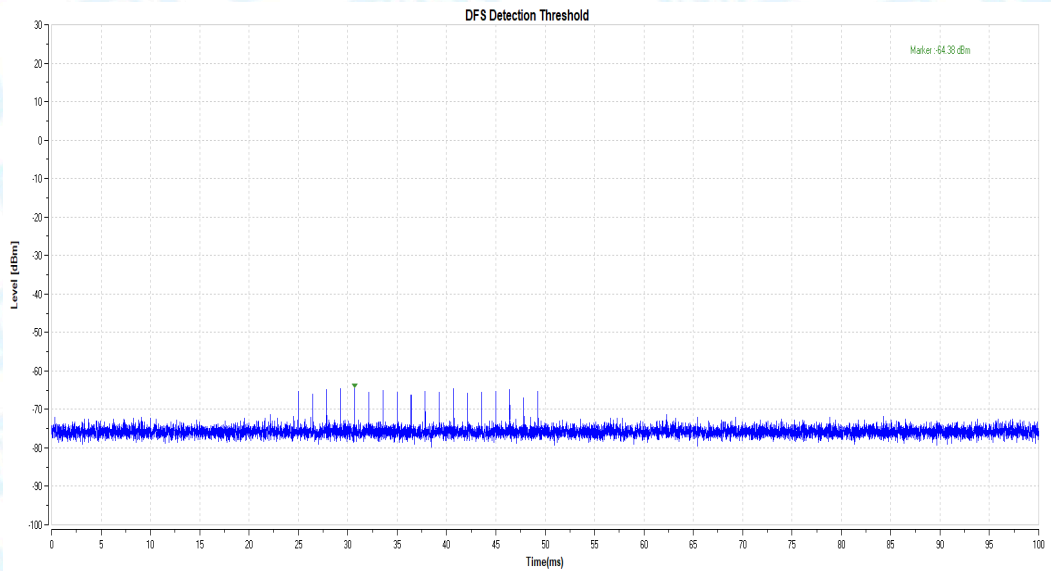

11AC80_5290_Type1

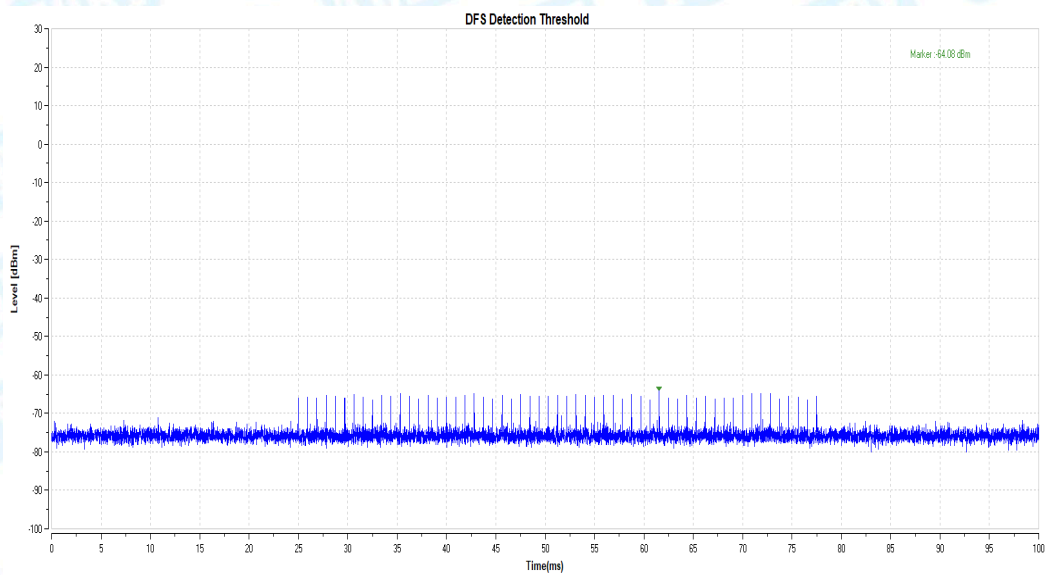

11AC80_5290_Type2

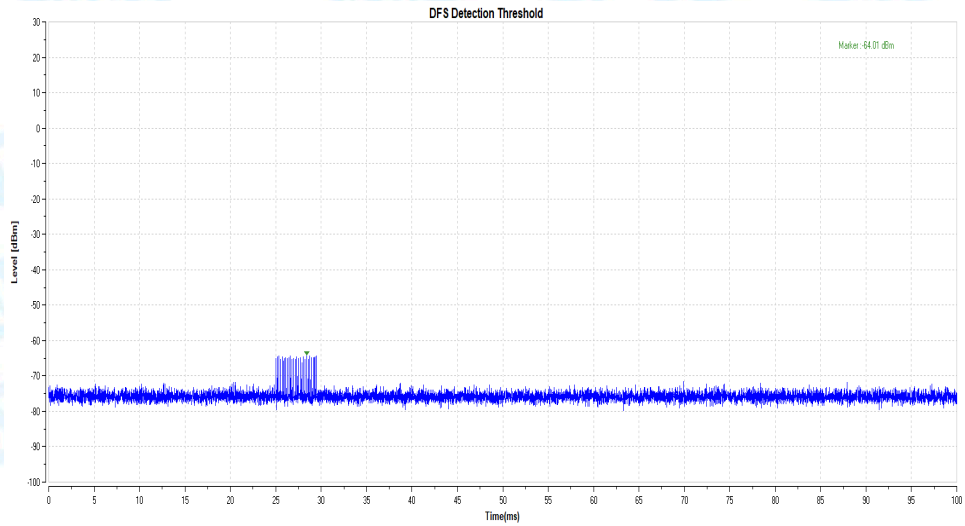

11AC80_5290_Type3

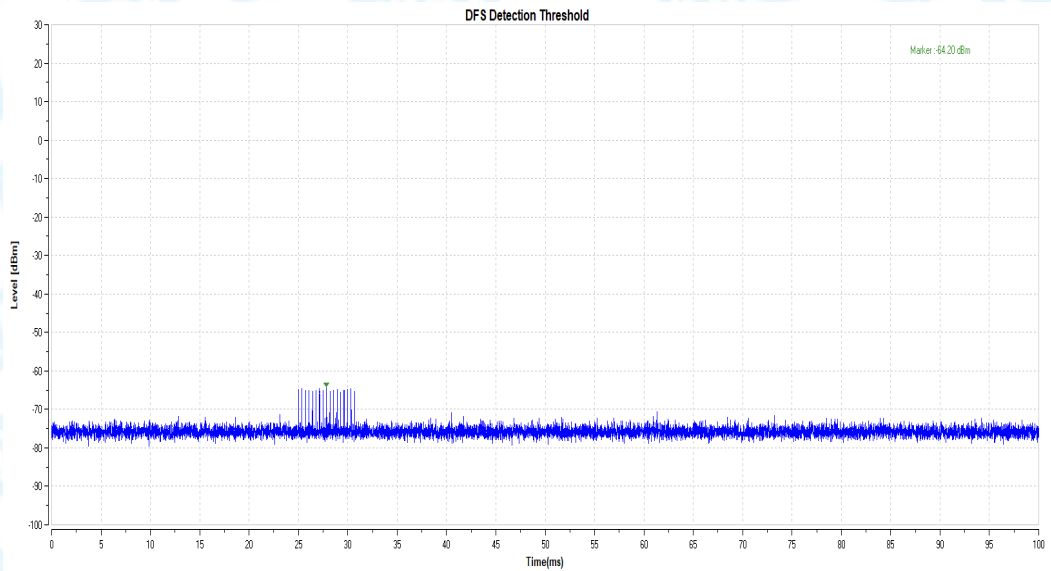

11AC80_5290_Type4

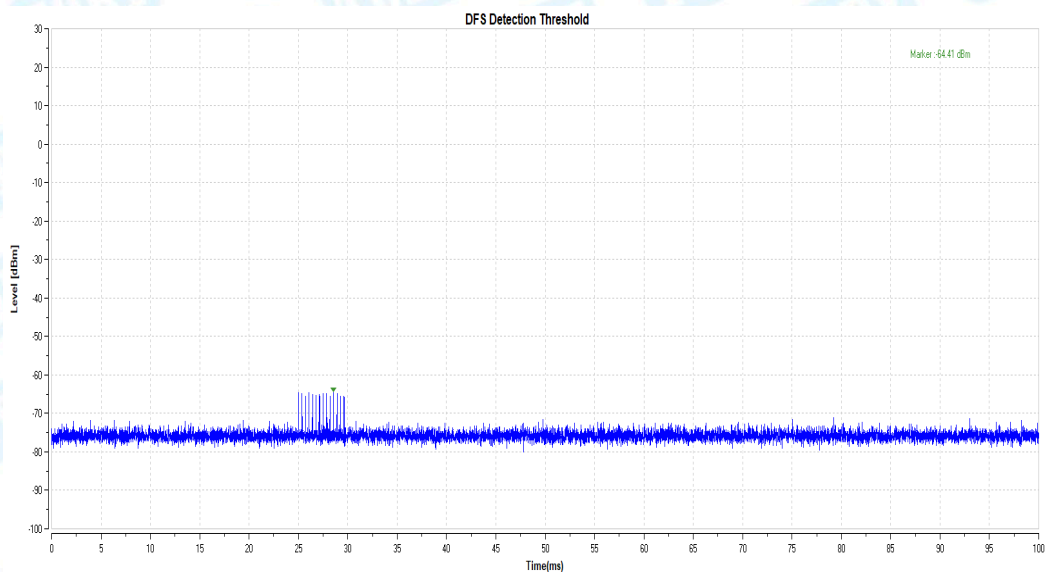

11AC80_5290_Type5

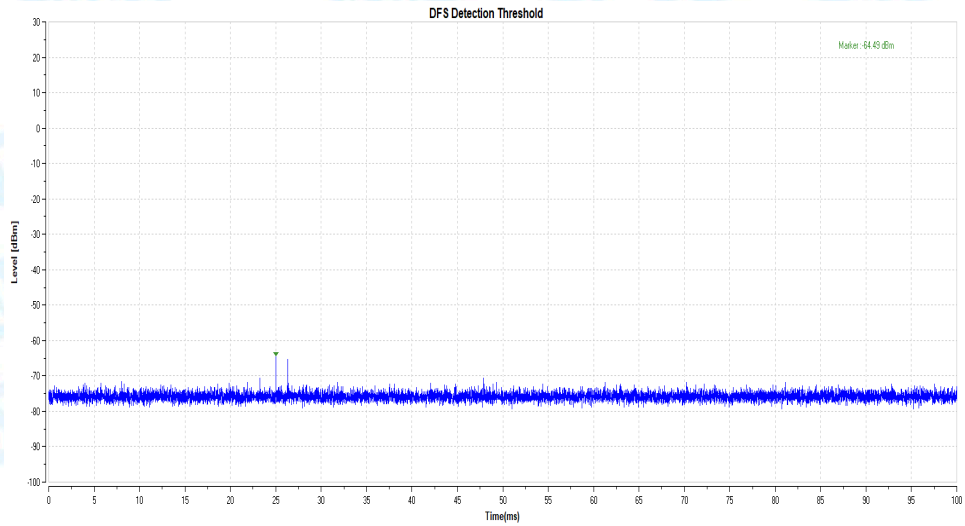

11AC80_5290_Type6

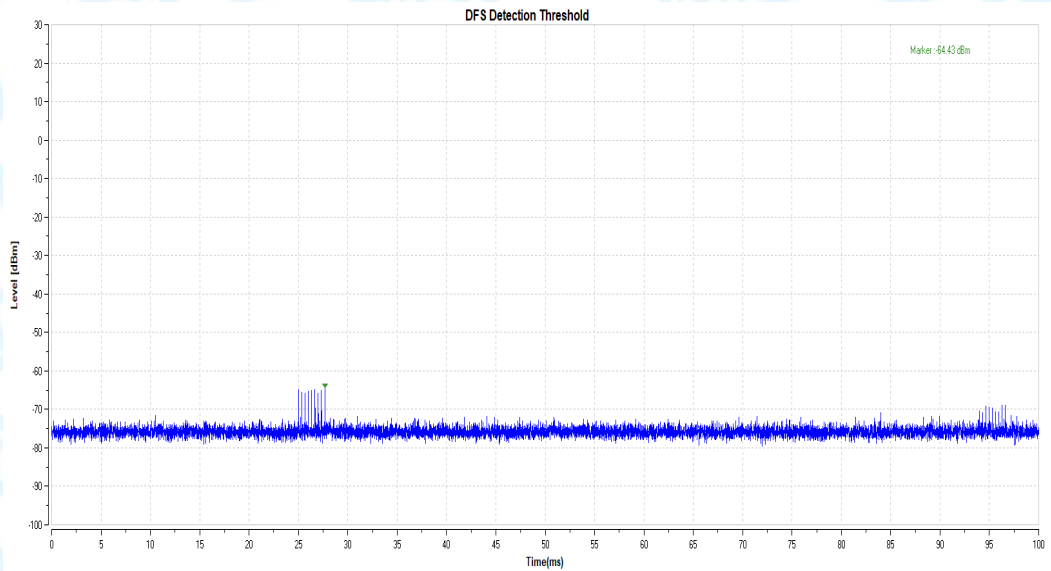

11AC80_5530_Type0

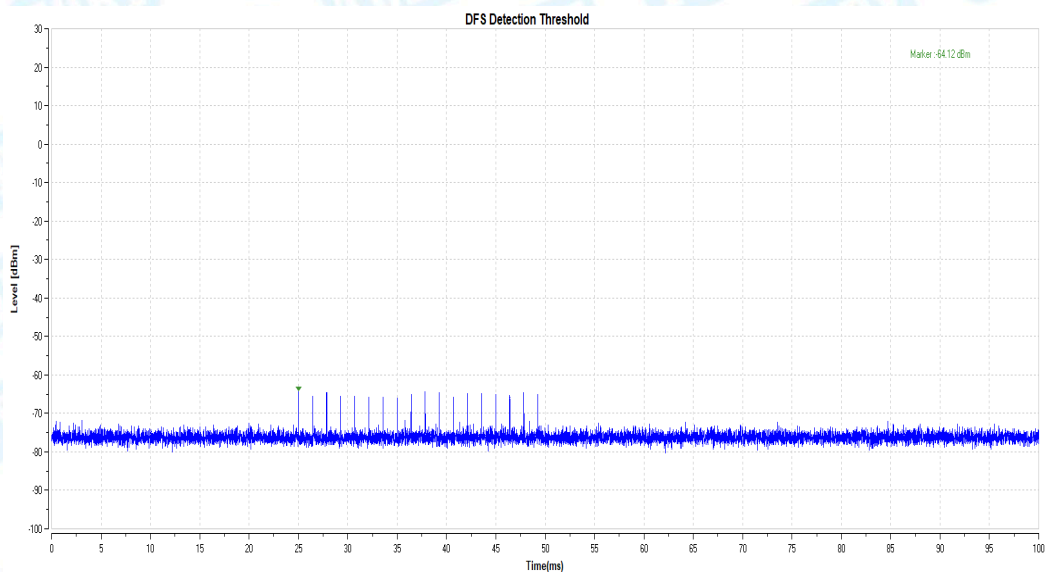

11AC80_5530_Type1

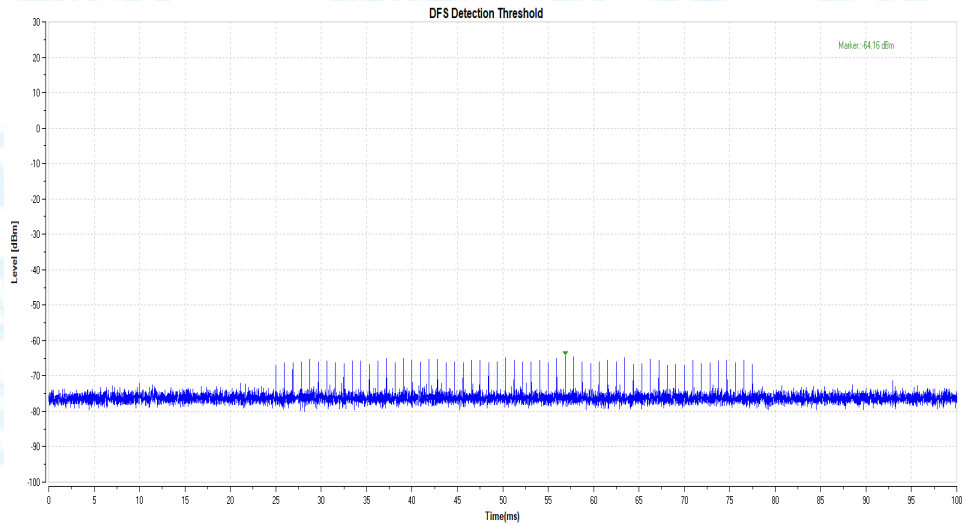

11AC80_5530_Type2

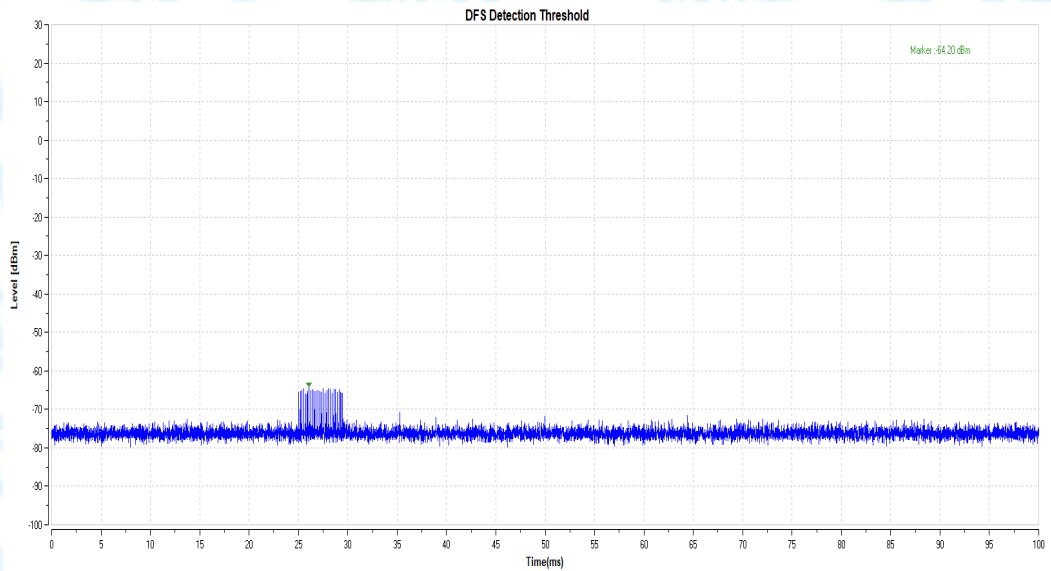

11AC80_5530_Type3

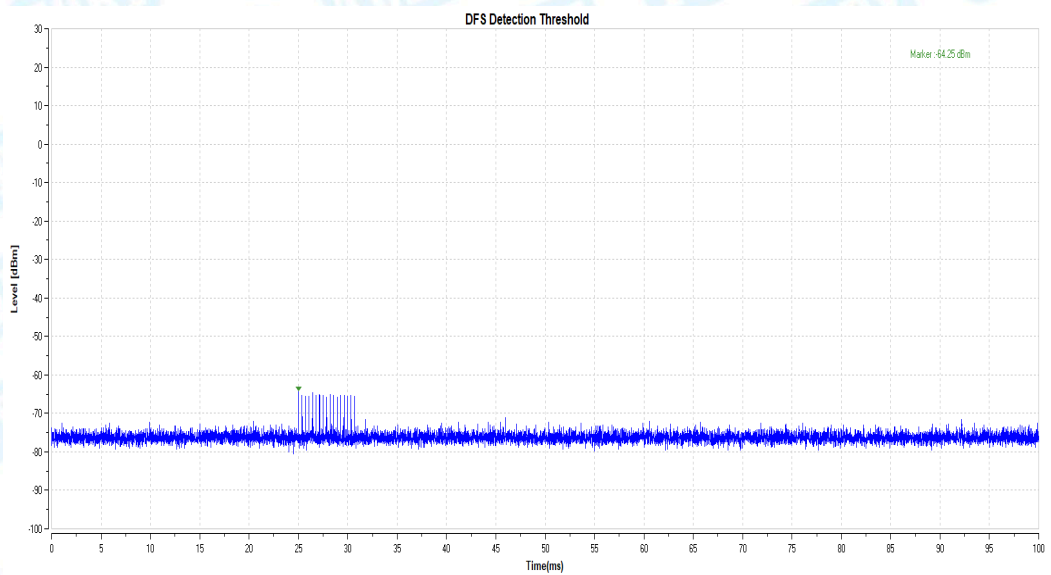

11AC80_5530_Type4

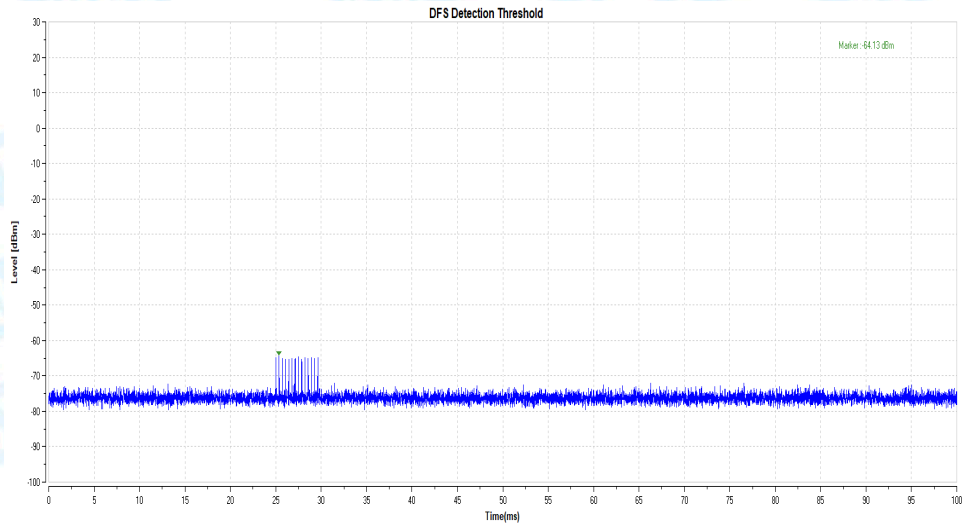

11AC80_5530_Type5

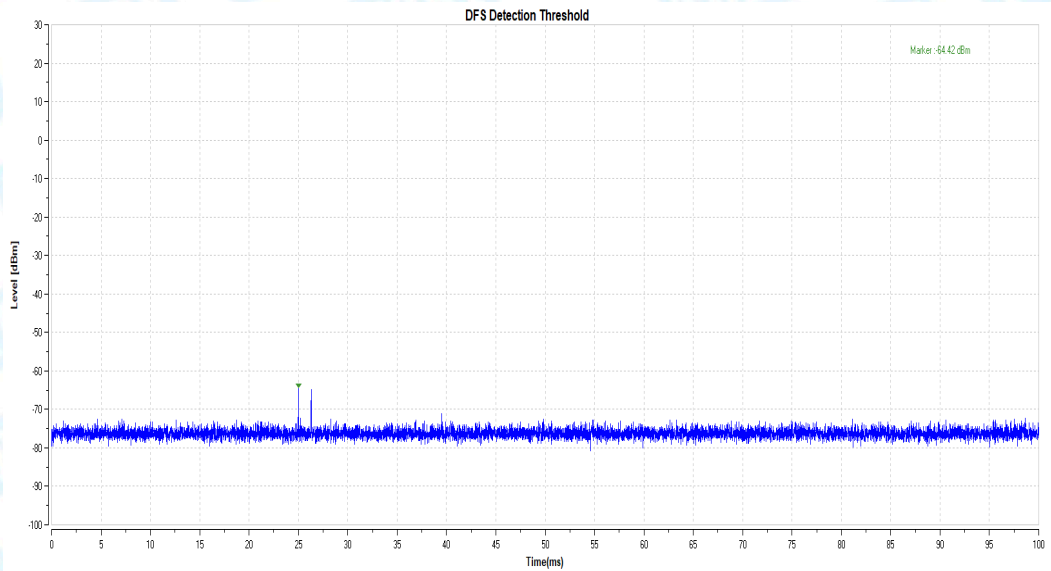

11AC80_5530_Type6

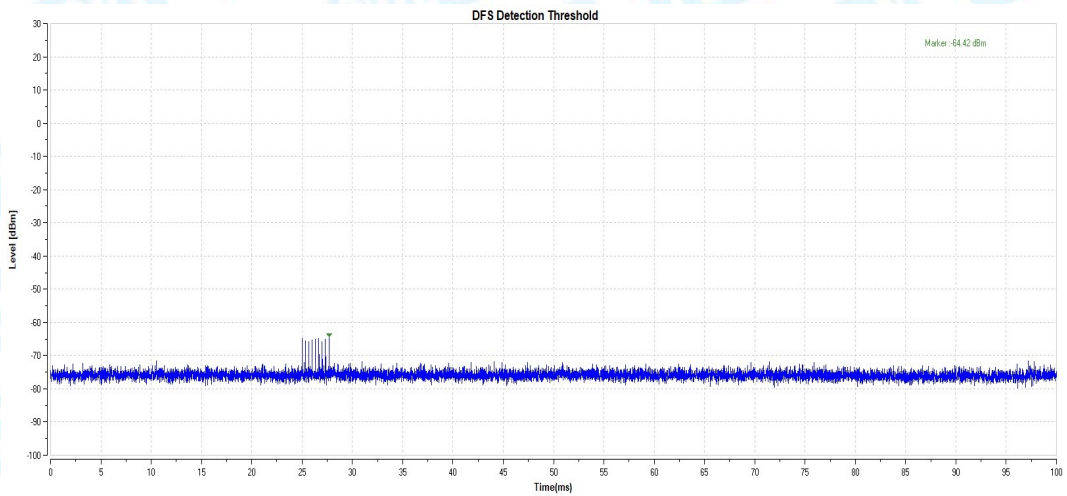

Radar Signal 1					
Trial ID	Radar Type	Pulse Width (us)	PRI (us)	Number of Pulses	Waveform Length (us)
0	Type 1	1	938	57	53466
1	Type 1	1	698	76	53048
2	Type 1	1	618	86	53148
3	Type 1	1	538	99	53262
4	Type 1	1	878	61	53558
5	Type 1	1	3066	18	55188
6	Type 1	1	638	83	52954
7	Type 1	1	918	58	53244
8	Type 1	1	838	63	52794
9	Type 1	1	858	62	53196
10	Type 1	1	798	67	53466
11	Type 1	1	718	74	53132
12	Type 1	1	578	92	53176
13	Type 1	1	598	89	53222
14	Type 1	1	558	95	53010
15	Type 1	1	2536	21	53256
16	Type 1	1	966	55	53130
17	Type 1	1	827	64	52928
18	Type 1	1	2501	22	55022
19	Type 1	1	2595	21	54495
20	Type 1	1	1114	48	53472
21	Type 1	1	1302	41	53382
22	Type 1	1	3045	18	54810
23	Type 1	1	1624	33	53592
24	Type 1	1	2878	19	54682
25	Type 1	1	1027	52	53404
26	Type 1	1	2485	22	54670
27	Type 1	1	1600	33	52800
28	Type 1	1	1172	46	53912
29	Type 1	1	1177	45	52965



Radar Signal 2					
Trial ID	Radar Type	Pulse Width (us)	PRI (us)	Number of Pulses	Waveform Length (us)
0	Type 2	3.2	179	26	4654
1	Type 2	1.1	207	23	4761
2	Type 2	2.1	230	24	5520
3	Type 2	4.8	200	29	5800
4	Type 2	3.9	214	28	5992
5	Type 2	2.9	222	26	5772
6	Type 2	3.2	204	26	5304
7	Type 2	2.5	192	25	4800
8	Type 2	3.1	164	26	4264
9	Type 2	1.2	156	23	3588
10	Type 2	3.9	210	27	5670
11	Type 2	4.6	201	29	5829
12	Type 2	3.2	162	26	4212
13	Type 2	2.2	197	25	4925
14	Type 2	4.5	163	29	4727
15	Type 2	3	203	26	5278
16	Type 2	5	168	29	4872
17	Type 2	2.4	217	25	5425
18	Type 2	2.9	191	26	4966
19	Type 2	2.3	166	25	4150
20	Type 2	3.7	150	27	4050
21	Type 2	2.2	176	25	4400
22	Type 2	4.9	195	29	5655
23	Type 2	2.9	202	26	5252
24	Type 2	2.5	178	25	4450
25	Type 2	1.1	206	23	4738
26	Type 2	3.8	155	27	4185
27	Type 2	4.7	157	29	4553
28	Type 2	2.4	224	25	5600
29	Type 2	4.2	159	28	4452



Radar Signal 3					
Trial ID	Radar Type	Pulse Width (us)	PRI (us)	Number of Pulses	Waveform Length (us)
0	Type 3	8.2	355	17	6035
1	Type 3	6.1	487	16	7792
2	Type 3	7.1	344	16	5504
3	Type 3	9.8	288	18	5184
4	Type 3	8.9	230	18	4140
5	Type 3	7.9	432	17	7344
6	Type 3	8.2	207	17	3519
7	Type 3	7.5	443	17	7531
8	Type 3	8.1	439	17	7463
9	Type 3	6.2	223	16	3568
10	Type 3	8.9	208	18	3744
11	Type 3	9.6	463	18	8334
12	Type 3	8.2	441	17	7497
13	Type 3	7.2	323	16	5168
14	Type 3	9.5	297	18	5346
15	Type 3	8	412	17	7004
16	Type 3	10	324	18	5832
17	Type 3	7.4	271	17	4607
18	Type 3	7.9	349	17	5933
19	Type 3	7.3	409	16	6544
20	Type 3	8.7	373	18	6714
21	Type 3	7.2	254	16	4064
22	Type 3	9.9	274	18	4932
23	Type 3	7.9	278	17	4726
24	Type 3	7.5	317	17	5389
25	Type 3	6.1	260	16	4160
26	Type 3	8.8	211	18	3798
27	Type 3	9.7	272	18	4896
28	Type 3	7.4	264	17	4488
29	Type 3	9.2	284	18	5112



Radar Signal 4					
Trial ID	Radar Type	Pulse Width (us)	PRI (us)	Number of Pulses	Waveform Length (us)
0	Type 4	16	355	14	4970
1	Type 4	11.3	487	12	5844
2	Type 4	13.5	344	13	4472
3	Type 4	19.4	288	16	4608
4	Type 4	17.5	230	15	3450
5	Type 4	15.3	432	14	6048
6	Type 4	15.9	207	14	2898
7	Type 4	14.3	443	13	5759
8	Type 4	15.8	439	14	6146
9	Type 4	11.5	223	12	2676
10	Type 4	17.4	208	15	3120
11	Type 4	19	463	16	7408
12	Type 4	16	441	14	6174
13	Type 4	13.8	323	13	4199
14	Type 4	18.9	297	16	4752
15	Type 4	15.5	412	14	5768
16	Type 4	19.9	324	16	5184
17	Type 4	14.1	271	13	3523
18	Type 4	15.2	349	14	4886
19	Type 4	13.8	409	13	5317
20	Type 4	17.1	373	15	5595
21	Type 4	13.8	254	13	3302
22	Type 4	19.8	274	16	4384
23	Type 4	15.3	278	14	3892
24	Type 4	14.5	317	13	4121
25	Type 4	11.3	260	12	3120
26	Type 4	17.3	211	15	3165
27	Type 4	19.2	272	16	4352
28	Type 4	14.2	264	13	3432
29	Type 4	18.2	284	15	4260



Radar Signal 5				
Trial ID	Radar Type	Number of Bursts	Burst Period (s)	Waveform Length (s)
0	Type 5	15	0.8	12
1	Type 5	8	1.5	12
2	Type 5	11	1.0909091	12
3	Type 5	20	0.6	12
4	Type 5	17	0.7058824	12
5	Type 5	14	0.8571429	12
6	Type 5	15	0.8	12
7	Type 5	12	1	12
8	Type 5	14	0.8571429	12
9	Type 5	8	1.5	12
10	Type 5	17	0.7058824	12
11	Type 5	19	0.6315789	12
12	Type 5	15	0.8	12
13	Type 5	12	1	12
14	Type 5	19	0.6315789	12
15	Type 5	14	0.8571429	12
16	Type 5	20	0.6	12
17	Type 5	12	1	12
18	Type 5	14	0.8571429	12
19	Type 5	12	1	12
20	Type 5	16	0.75	12
21	Type 5	12	1	12
22	Type 5	20	0.6	12
23	Type 5	14	0.8571429	12
24	Type 5	13	0.9230769	12
25	Type 5	8	1.5	12
26	Type 5	17	0.7058824	12
27	Type 5	19	0.6315789	12
28	Type 5	12	1	12
29	Type 5	18	0.6666667	12



Radar Signal 6							
Trial ID	Radar Type	Pulse Width (us)	PRI (us)	Pulses per Hop	Hopping Rate (kHz)	Hopping Sequence Length (ms)	Visible Frequency Number
0	Type 6	1	333.3	9	0.3333	300	32
1	Type 6	1	333.3	9	0.3333	300	27
2	Type 6	1	333.3	9	0.3333	300	25
3	Type 6	1	333.3	9	0.3333	300	33
4	Type 6	1	333.3	9	0.3333	300	37
5	Type 6	1	333.3	9	0.3333	300	30
6	Type 6	1	333.3	9	0.3333	300	33
7	Type 6	1	333.3	9	0.3333	300	27
8	Type 6	1	333.3	9	0.3333	300	33
9	Type 6	1	333.3	9	0.3333	300	30
10	Type 6	1	333.3	9	0.3333	300	37
11	Type 6	1	333.3	9	0.3333	300	36
12	Type 6	1	333.3	9	0.3333	300	38
13	Type 6	1	333.3	9	0.3333	300	35
14	Type 6	1	333.3	9	0.3333	300	28
15	Type 6	1	333.3	9	0.3333	300	37
16	Type 6	1	333.3	9	0.3333	300	35
17	Type 6	1	333.3	9	0.3333	300	37
18	Type 6	1	333.3	9	0.3333	300	27
19	Type 6	1	333.3	9	0.3333	300	34
20	Type 6	1	333.3	9	0.3333	300	35
21	Type 6	1	333.3	9	0.3333	300	37
22	Type 6	1	333.3	9	0.3333	300	41
23	Type 6	1	333.3	9	0.3333	300	36
24	Type 6	1	333.3	9	0.3333	300	29
25	Type 6	1	333.3	9	0.3333	300	32
26	Type 6	1	333.3	9	0.3333	300	30
27	Type 6	1	333.3	9	0.3333	300	31
28	Type 6	1	333.3	9	0.3333	300	31
29	Type 6	1	333.3	9	0.3333	300	40



8.4. Channel Availability Check Time

If the UUT successfully detected the radar burst, it should be observed as the UUT has no transmissions occurred until the UUT starts transmitting on another channel.

Test Result

Test Mode	Frequency[MHz]	Result	Verdict
11AC80	5290	See test Graph	PASS
	5530	See test Graph	PASS

Test Mode	Frequency[MHz]	Result	Verdict
11AC80	5290	See test Graph	PASS
	5530	See test Graph	PASS

Test Mode	Frequency[MHz]	Result	Verdict
11AC80	5290	See test Graph	PASS
	5530	See test Graph	PASS



Test Graphs

Initial Channel Availability Check Time

11AC80_5290

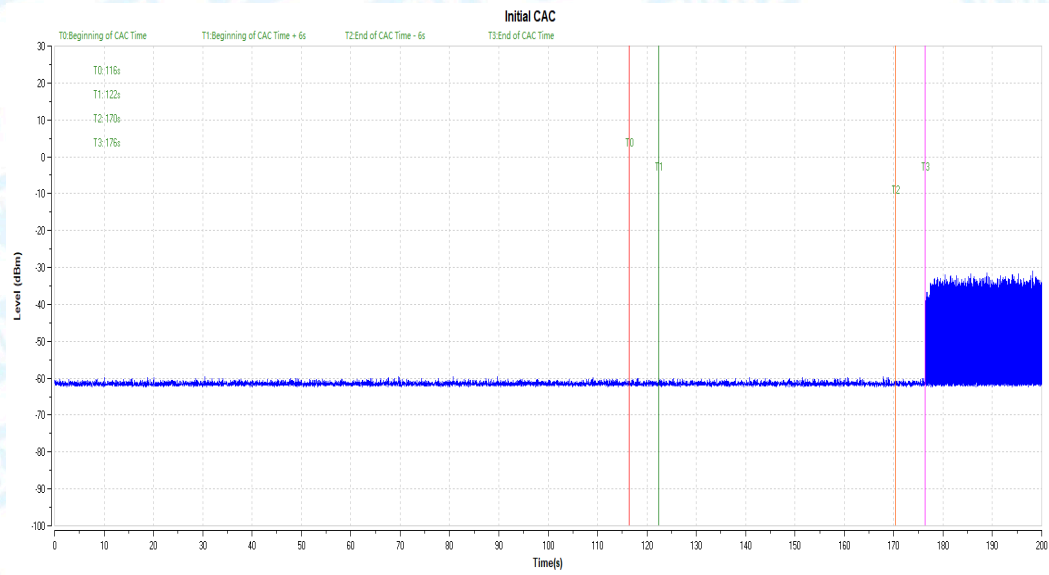

11AC80_5530

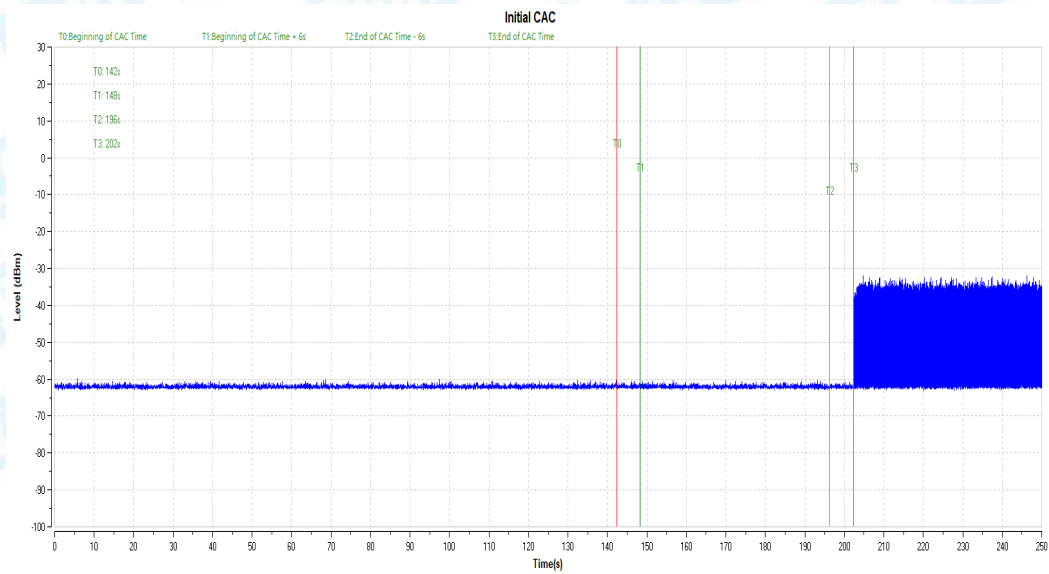

Beginning of Channel Availability Check Time

11AC80_5290

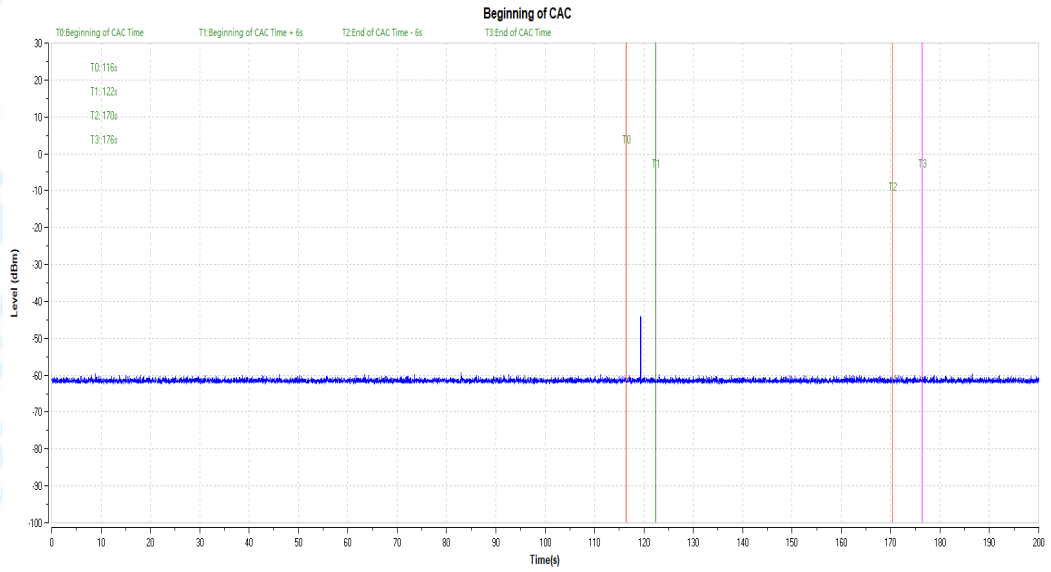

11AC80_5530

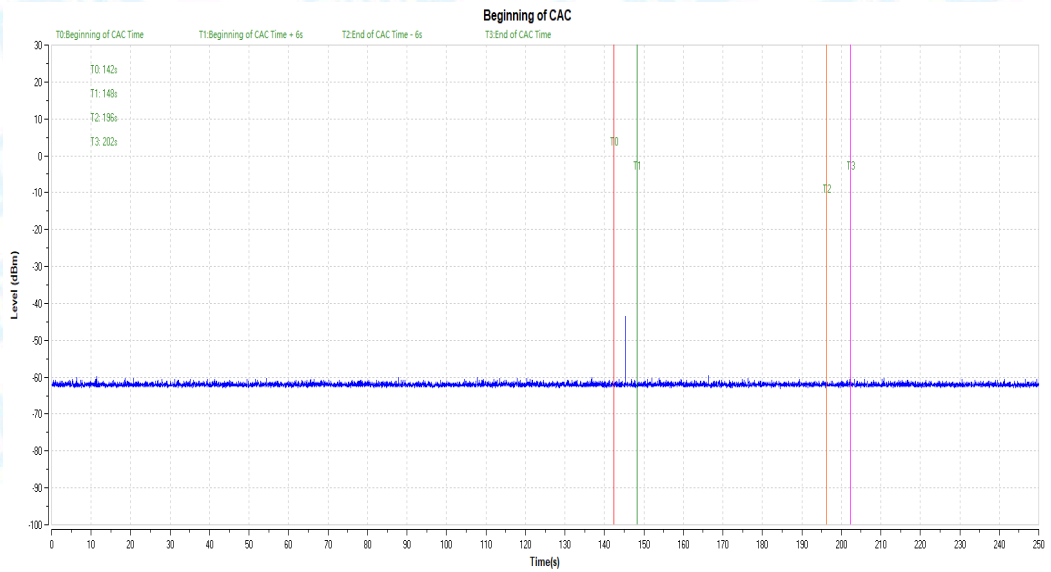

End of Channel Availability Check Time

11AC80_5290

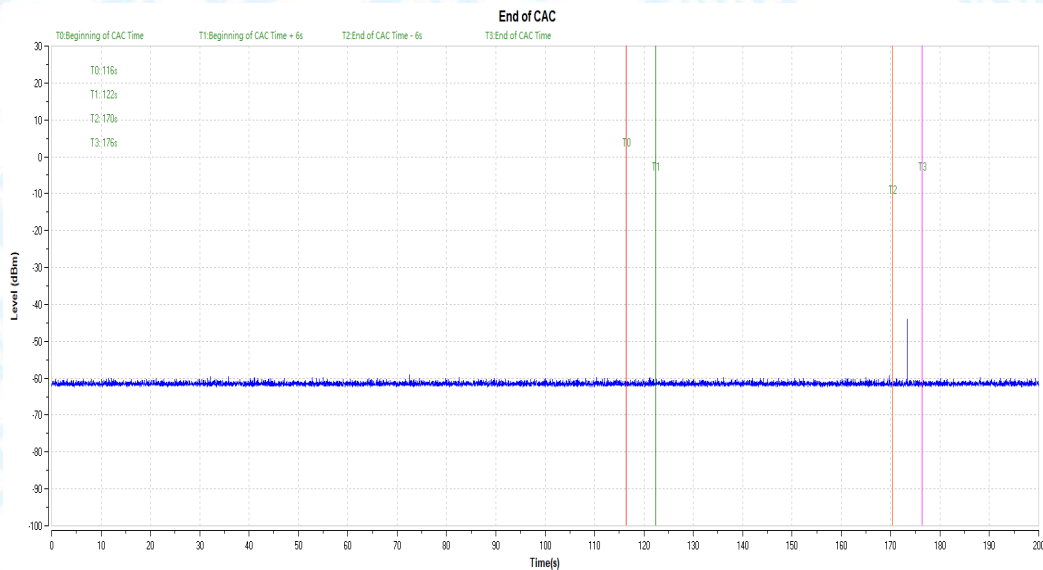

11AC80_5530

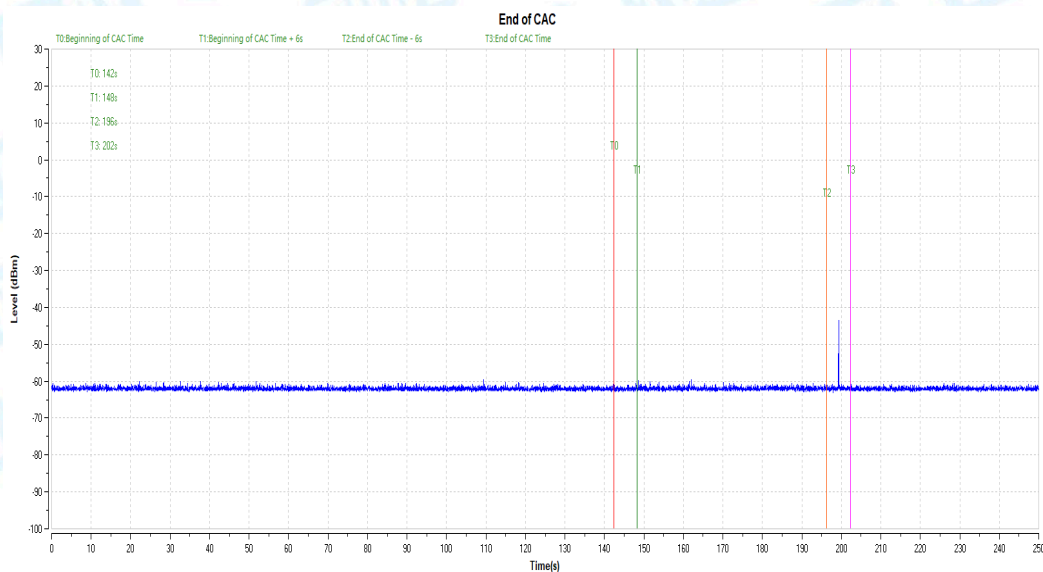

8.5. Statistical Performance check
Test Result (only show the worst data)

Test Mode	Frequency[MHz]	Radar Type	Pass Times	Fail Times	Probability (%)	Limit (%)	Verdict
11AC80	5290	Type1	27	3	90.00	60	PASS
		Type2	27	3	90.00	60	PASS
		Type3	22	8	73.33	60	PASS
		Type4	22	8	73.33	60	PASS
		Type 1-4	---	---	81.67	80	PASS
		Type5	29	1	96.67	80	PASS
	5530	Type6	29	1	96.67	70	PASS
		Type1	28	2	93.33	60	PASS
		Type2	27	3	90.00	60	PASS
		Type3	22	8	73.33	60	PASS
		Type4	22	8	73.33	60	PASS
		Type 1-4	---	---	82.50	80	PASS
		Type5	28	2	93.33	80	PASS
		Type6	29	1	96.67	70	PASS



Test Mode	Frequency [MHz]	Radar Type	Trial ID	Pulse width(μs)	PRI(μs)	Pulses per Burst	Detection (1: Yes; 0: No)
11AC80	5290	Type1	0	1.0	938.0	57	1
		Type1	1	1.0	698.0	76	1
		Type1	2	1.0	618.0	86	1
		Type1	3	1.0	538.0	99	0
		Type1	4	1.0	878.0	61	1
		Type1	5	1.0	3066.0	18	1
		Type1	6	1.0	638.0	83	1
		Type1	7	1.0	918.0	58	1
		Type1	8	1.0	838.0	63	1
		Type1	9	1.0	858.0	62	1
		Type1	10	1.0	798.0	67	1
		Type1	11	1.0	718.0	74	1
		Type1	12	1.0	578.0	92	1
		Type1	13	1.0	598.0	89	1
		Type1	14	1.0	558.0	95	1
		Type1	15	1.0	2536.0	21	1
		Type1	16	1.0	966.0	55	1
		Type1	17	1.0	827.0	64	1
		Type1	18	1.0	2501.0	22	1
		Type1	19	1.0	2595.0	21	1
		Type1	20	1.0	1114.0	48	1
		Type1	21	1.0	1302.0	41	1
		Type1	22	1.0	3045.0	18	1
		Type1	23	1.0	1624.0	33	1
		Type1	24	1.0	2878.0	19	1
		Type1	25	1.0	1027.0	52	0
		Type1	26	1.0	2485.0	22	1
		Type1	27	1.0	1600.0	33	0
		Type1	28	1.0	1172.0	46	1
		Type1	29	1.0	1177.0	45	1
		Type2	0	3.2	179.0	26	1
		Type2	1	1.1	207.0	23	1
		Type2	2	2.1	230.0	24	0
		Type2	3	4.8	200.0	29	1
		Type2	4	3.9	214.0	28	1
		Type2	5	2.9	222.0	26	1
		Type2	6	3.2	204.0	26	1
		Type2	7	2.5	192.0	25	1
		Type2	8	3.1	164.0	26	1
		Type2	9	1.2	156.0	23	1
		Type2	10	3.9	210.0	27	1
		Type2	11	4.6	201.0	29	1
		Type2	12	3.2	162.0	26	1
		Type2	13	2.2	197.0	25	1
		Type2	14	4.5	163.0	29	1
		Type2	15	3.0	203.0	26	1
		Type2	16	5.0	168.0	29	1
		Type2	17	2.4	217.0	25	1
		Type2	18	2.9	191.0	26	0
Type2	19	2.3	166.0	25	1		
Type2	20	3.7	150.0	27	1		
Type2	21	2.2	176.0	25	1		
Type2	22	4.9	195.0	29	0		
Type2	23	2.9	202.0	26	1		
Type2	24	2.5	178.0	25	1		
Type2	25	1.1	206.0	23	1		
Type2	26	3.8	155.0	27	1		
Type2	27	4.7	157.0	29	1		
Type2	28	2.4	224.0	25	1		
Type2	29	4.2	159.0	28	1		



	Type3	0	8.2	355.0	17	1
	Type3	1	6.1	487.0	16	1
	Type3	2	7.1	344.0	16	1
	Type3	3	9.8	288.0	18	1
	Type3	4	8.9	230.0	18	1
	Type3	5	7.9	432.0	17	0
	Type3	6	8.2	207.0	17	0
	Type3	7	7.5	443.0	17	1
	Type3	8	8.1	439.0	17	1
	Type3	9	6.2	223.0	16	1
	Type3	10	8.9	208.0	18	1
	Type3	11	9.6	463.0	18	1
	Type3	12	8.2	441.0	17	0
	Type3	13	7.2	323.0	16	1
	Type3	14	9.5	297.0	18	0
	Type3	15	8.0	412.0	17	1
	Type3	16	10.0	324.0	18	0
	Type3	17	7.4	271.0	17	0
	Type3	18	7.9	349.0	17	0
	Type3	19	7.3	409.0	16	1
	Type3	20	8.7	373.0	18	1
	Type3	21	7.2	254.0	16	0
	Type3	22	9.9	274.0	18	1
	Type3	23	7.9	278.0	17	1
	Type3	24	7.5	317.0	17	1
	Type3	25	6.1	260.0	16	1
	Type3	26	8.8	211.0	18	1
	Type3	27	9.7	272.0	18	1
	Type3	28	7.4	264.0	17	1
	Type3	29	9.2	284.0	18	1
	Type4	0	16.0	355.0	14	0
	Type4	1	11.3	487.0	12	1
	Type4	2	13.5	344.0	13	0
	Type4	3	19.4	288.0	16	1
	Type4	4	17.5	230.0	15	0
	Type4	5	15.3	432.0	14	1
	Type4	6	15.9	207.0	14	0
	Type4	7	14.3	443.0	13	1
	Type4	8	15.8	439.0	14	1
	Type4	9	11.5	223.0	12	1
	Type4	10	17.4	208.0	15	0
	Type4	11	19.0	463.0	16	1
	Type4	12	16.0	441.0	14	1
	Type4	13	13.8	323.0	13	1
	Type4	14	18.9	297.0	16	1
	Type4	15	15.5	412.0	14	1
	Type4	16	19.9	324.0	16	1
	Type4	17	14.1	271.0	13	1
	Type4	18	15.2	349.0	14	1
	Type4	19	13.8	409.0	13	1
	Type4	20	17.1	373.0	15	1
	Type4	21	13.8	254.0	13	1
	Type4	22	19.8	274.0	16	1
	Type4	23	15.3	278.0	14	1
	Type4	24	14.5	317.0	13	1
	Type4	25	11.3	260.0	12	1
	Type4	26	17.3	211.0	15	0
	Type4	27	19.2	272.0	16	1
	Type4	28	14.2	264.0	13	0
	Type4	29	18.2	284.0	15	0
5530	Type1	0	1.0	938.0	57	0
	Type1	1	1.0	698.0	76	1
	Type1	2	1.0	618.0	86	1
	Type1	3	1.0	538.0	99	1



Type1	4	1.0	878.0	61	1
Type1	5	1.0	3066.0	18	1
Type1	6	1.0	638.0	83	1
Type1	7	1.0	918.0	58	1
Type1	8	1.0	838.0	63	1
Type1	9	1.0	858.0	62	1
Type1	10	1.0	798.0	67	1
Type1	11	1.0	718.0	74	1
Type1	12	1.0	578.0	92	1
Type1	13	1.0	598.0	89	1
Type1	14	1.0	558.0	95	1
Type1	15	1.0	2536.0	21	1
Type1	16	1.0	966.0	55	1
Type1	17	1.0	827.0	64	1
Type1	18	1.0	2501.0	22	1
Type1	19	1.0	2595.0	21	1
Type1	20	1.0	1114.0	48	1
Type1	21	1.0	1302.0	41	0
Type1	22	1.0	3045.0	18	1
Type1	23	1.0	1624.0	33	1
Type1	24	1.0	2878.0	19	1
Type1	25	1.0	1027.0	52	1
Type1	26	1.0	2485.0	22	1
Type1	27	1.0	1600.0	33	1
Type1	28	1.0	1172.0	46	1
Type1	29	1.0	1177.0	45	1
Type2	0	3.2	179.0	26	1
Type2	1	1.1	207.0	23	1
Type2	2	2.1	230.0	24	1
Type2	3	4.8	200.0	29	1
Type2	4	3.9	214.0	28	1
Type2	5	2.9	222.0	26	1
Type2	6	3.2	204.0	26	1
Type2	7	2.5	192.0	25	0
Type2	8	3.1	164.0	26	1
Type2	9	1.2	156.0	23	1
Type2	10	3.9	210.0	27	1
Type2	11	4.6	201.0	29	1
Type2	12	3.2	162.0	26	1
Type2	13	2.2	197.0	25	1
Type2	14	4.5	163.0	29	1
Type2	15	3.0	203.0	26	1
Type2	16	5.0	168.0	29	1
Type2	17	2.4	217.0	25	1
Type2	18	2.9	191.0	26	1
Type2	19	2.3	166.0	25	0
Type2	20	3.7	150.0	27	1
Type2	21	2.2	176.0	25	0
Type2	22	4.9	195.0	29	1
Type2	23	2.9	202.0	26	1
Type2	24	2.5	178.0	25	1
Type2	25	1.1	206.0	23	1
Type2	26	3.8	155.0	27	1
Type2	27	4.7	157.0	29	1
Type2	28	2.4	224.0	25	1
Type2	29	4.2	159.0	28	1
Type3	0	8.2	355.0	17	1
Type3	1	6.1	487.0	16	1
Type3	2	7.1	344.0	16	0
Type3	3	9.8	288.0	18	1
Type3	4	8.9	230.0	18	0
Type3	5	7.9	432.0	17	1
Type3	6	8.2	207.0	17	0
Type3	7	7.5	443.0	17	1



Type3	8	8.1	439.0	17	0
Type3	9	6.2	223.0	16	0
Type3	10	8.9	208.0	18	1
Type3	11	9.6	463.0	18	1
Type3	12	8.2	441.0	17	1
Type3	13	7.2	323.0	16	1
Type3	14	9.5	297.0	18	0
Type3	15	8.0	412.0	17	1
Type3	16	10.0	324.0	18	1
Type3	17	7.4	271.0	17	1
Type3	18	7.9	349.0	17	1
Type3	19	7.3	409.0	16	0
Type3	20	8.7	373.0	18	1
Type3	21	7.2	254.0	16	1
Type3	22	9.9	274.0	18	1
Type3	23	7.9	278.0	17	1
Type3	24	7.5	317.0	17	1
Type3	25	6.1	260.0	16	1
Type3	26	8.8	211.0	18	1
Type3	27	9.7	272.0	18	1
Type3	28	7.4	264.0	17	1
Type3	29	9.2	284.0	18	0
Type4	0	16.0	355.0	14	0
Type4	1	11.3	487.0	12	1
Type4	2	13.5	344.0	13	1
Type4	3	19.4	288.0	16	0
Type4	4	17.5	230.0	15	1
Type4	5	15.3	432.0	14	1
Type4	6	15.9	207.0	14	1
Type4	7	14.3	443.0	13	1
Type4	8	15.8	439.0	14	1
Type4	9	11.5	223.0	12	1
Type4	10	17.4	208.0	15	1
Type4	11	19.0	463.0	16	1
Type4	12	16.0	441.0	14	1
Type4	13	13.8	323.0	13	1
Type4	14	18.9	297.0	16	0
Type4	15	15.5	412.0	14	1
Type4	16	19.9	324.0	16	1
Type4	17	14.1	271.0	13	0
Type4	18	15.2	349.0	14	1
Type4	19	13.8	409.0	13	1
Type4	20	17.1	373.0	15	0
Type4	21	13.8	254.0	13	1
Type4	22	19.8	274.0	16	1
Type4	23	15.3	278.0	14	0
Type4	24	14.5	317.0	13	0
Type4	25	11.3	260.0	12	1
Type4	26	17.3	211.0	15	0
Type4	27	19.2	272.0	16	1
Type4	28	14.2	264.0	13	1
Type4	29	18.2	284.0	15	1



Test Mode	Frequency [MHz]	Radar Type	Trial ID	Number Of Bursts	Waveform Length (s)	Radar Frequency[MHz]	Detection (1: Yes; 0: No)	
11AC80	5290	Type5	0	15	12	5290	1	
		Type5	1	8	12	5290	1	
		Type5	2	11	12	5290	1	
		Type5	3	20	12	5290	1	
		Type5	4	17	12	5290	1	
		Type5	5	14	12	5290	1	
		Type5	6	15	12	5290	1	
		Type5	7	12	12	5290	1	
		Type5	8	14	12	5290	1	
		Type5	9	8	12	5290	1	
		Type5	10	17	12	5258	1	
		Type5	11	19	12	5260	1	
		Type5	12	15	12	5257	1	
		Type5	13	12	12	5256	1	
		Type5	14	19	12	5259	1	
		Type5	15	14	12	5257	1	
		Type5	16	20	12	5260	1	
		Type5	17	12	12	5256	1	
		Type5	18	14	12	5257	1	
		Type5	19	12	12	5256	0	
		Type5	20	16	12	5322	1	
		Type5	21	12	12	5324	1	
		Type5	22	20	12	5320	1	
		Type5	23	14	12	5323	1	
		Type5	24	13	12	5324	1	
		Type5	25	8	12	5326	1	
		Type5	26	17	12	5322	1	
		Type5	27	19	12	5320	1	
		Type5	28	12	12	5324	1	
	Type5	29	18	12	5321	1		
	Type5	5530	Type5	0	15	12	5530	1
	Type5		1	8	12	5530	0	
	Type5		2	11	12	5530	1	
	Type5		3	20	12	5530	1	
	Type5		4	17	12	5530	1	
	Type5		5	14	12	5530	1	
	Type5		6	15	12	5530	1	
	Type5		7	12	12	5530	1	
	Type5		8	14	12	5530	1	
	Type5		9	8	12	5530	1	
	Type5		10	17	12	5499	1	
	Type5		11	19	12	5500	1	
	Type5		12	15	12	5497	1	
	Type5		13	12	12	5496	1	
	Type5		14	19	12	5499	0	
	Type5		15	14	12	5497	1	
	Type5		16	20	12	5500	1	
	Type5		17	12	12	5496	1	
	Type5		18	14	12	5497	1	
Type5	19		12	12	5496	1		
Type5	20	16	12	5562	1			
Type5	21	12	12	5564	1			
Type5	22	20	12	5560	1			
Type5	23	14	12	5563	1			
Type5	24	13	12	5563	1			
Type5	25	8	12	5566	1			
Type5	26	17	12	5561	1			
Type5	27	19	12	5560	1			
Type5	28	12	12	5564	1			
Type5	29	18	12	5561	1			



8.6. Channel Move Time and Channel Closing Transmission Time

Test Mode	Frequency[MHz]	CCTT[ms]	Limit[ms]	CMT[ms]	Limit[ms]	Verdict
11AC80	5290	200+15.6	200+60	1035.8	10000	PASS
	5530	200+15.6	200+60	1108.6	10000	PASS

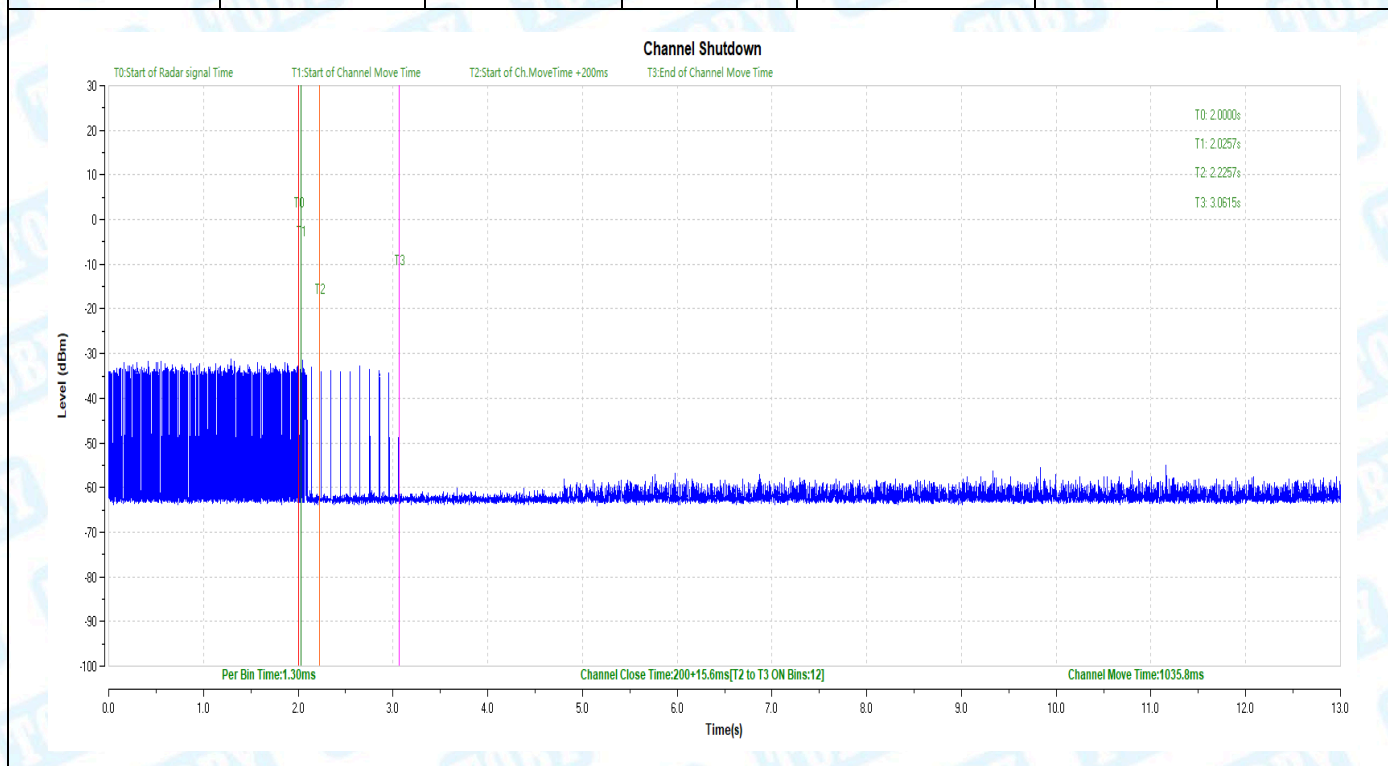

11AC80_5290

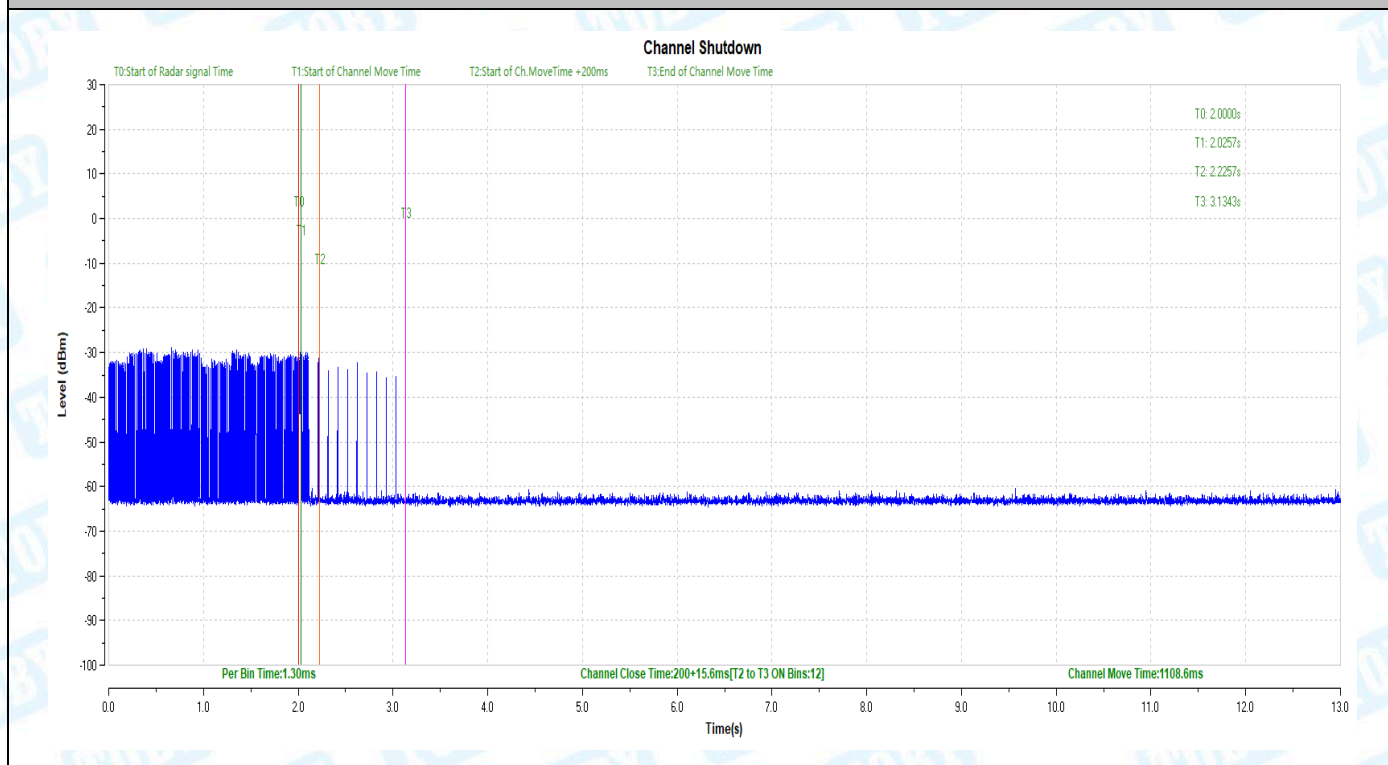

11AC80_5530



8.7. Non-occupancy Period

During the 30 minutes observation time, UUT did not make any transmissions on a channel after a radar signal was detected on that channel by either the Channel Availability Check or the In-Service Monitoring.

Non-Occupancy Period Result				
Modulation Mode	Freq. (MHz)	Non-Occupancy Period		
		Measured	Limit	Result
AC80	5290	>30min	30min	Complied
	5530	>30min	30min	Complied

11ac80 Mode 5290MHz

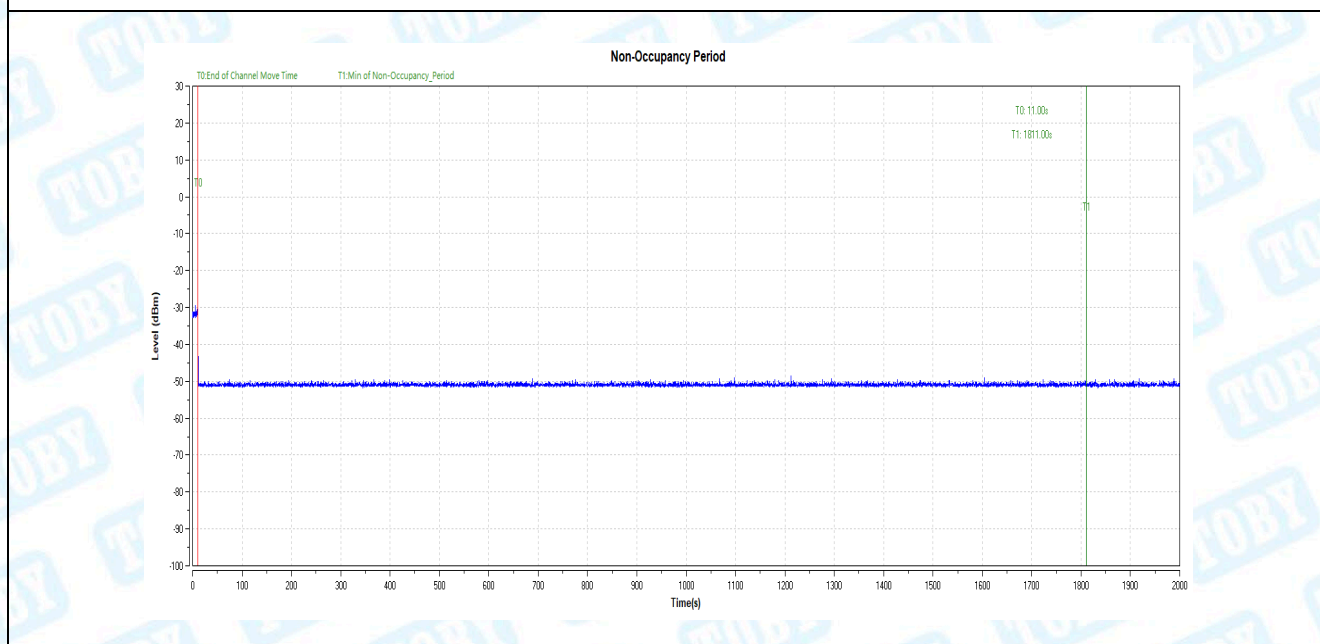

11ac80 Mode 5530MHz

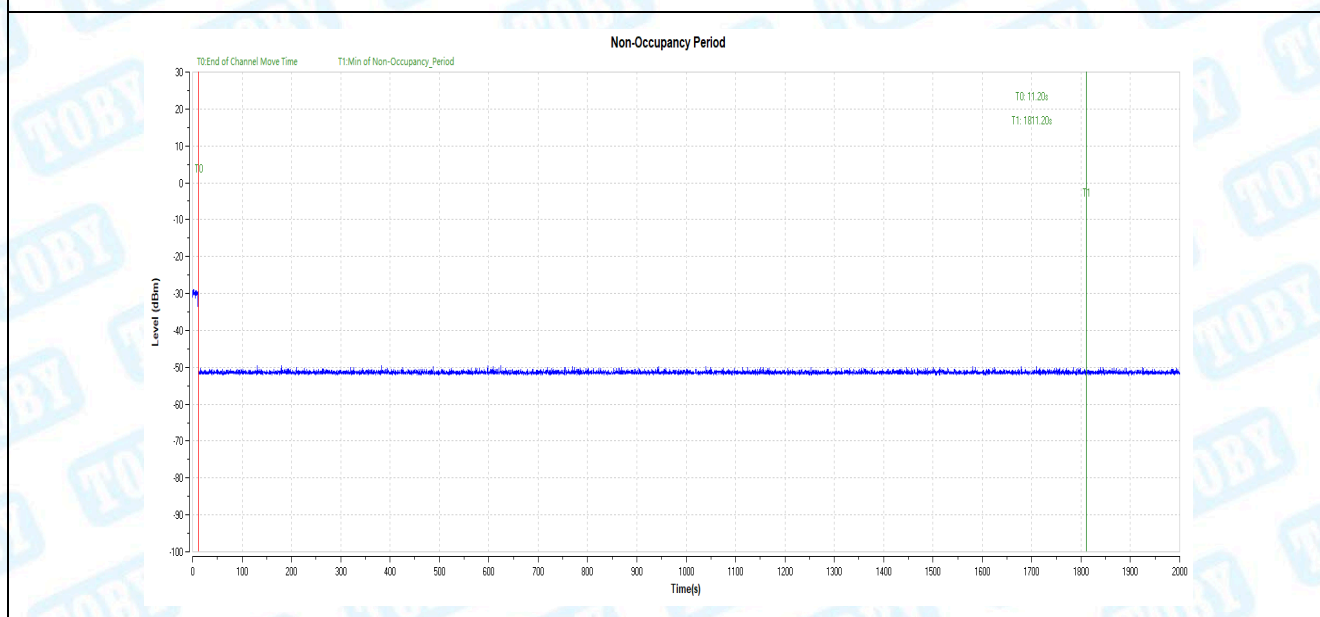

8.8. U-NII Detection Bandwidth

Test Result

Test Mode	Frequency [MHz]	FL[MHz]	FH[MHz]	Detection Bandwidth [MHz]	OCB [MHz]	Ratio [%]	Limit [%]	Verdict
11AC20	5260	5250	5270	20	18.092	110.55	≥100	PASS
	5500	5490	5510	20	18.072	110.67	≥100	PASS
11AC40	5270	5249	5291	42	36.552	114.90	≥100	PASS
	5510	5490	5531	41	36.960	110.93	≥100	PASS
11AC80	5290	5248	5330	82	76.064	107.80	≥100	PASS
	5530	5487	5574	87	75.456	115.30	≥100	PASS



Test Mode	Fre. [MHz]	Radar Freq.[MHz]	Radar Type 0										Ratio (%)		
			Trial 1	Trial 2	Trial 3	Trial 4	Trial 5	Trial 6	Trial 7	Trial 8	Trial 9	Trial 10			
11AC20	5260	5249	0	0	0	0	0	0	0	0	0	0	0	0	
		5250	1	1	1	1	1	1	1	1	1	1	1	1	100
		5255	1	1	1	1	1	1	1	1	1	1	1	1	100
		5260	1	1	1	1	1	1	1	1	1	1	1	1	100
		5265	1	1	1	1	1	1	1	1	1	1	1	1	100
		5270	1	1	1	1	1	1	1	1	1	1	1	1	100
	5271	0	0	0	0	0	0	0	0	0	0	0	0	0	
	5489	0	0	0	0	0	0	0	0	0	0	0	0	0	
	5490	1	1	1	1	1	1	1	1	1	1	1	1	100	
	5495	1	1	1	1	1	1	1	1	1	1	1	1	100	
	5500	1	1	1	1	1	1	1	1	1	1	1	1	100	
	5505	1	1	1	1	1	1	1	1	1	1	1	1	100	
5510	1	1	1	1	1	1	1	1	1	1	1	1	100		
5511	0	0	0	0	0	0	0	0	0	0	0	0	0		
11AC40	5270	5248	0	0	0	0	0	0	0	0	0	0	0	0	
		5249	1	1	1	1	1	1	1	1	1	1	1	100	
		5250	1	1	1	1	1	1	1	1	1	1	1	100	
		5255	1	1	1	1	1	1	1	1	1	1	1	100	
		5260	1	1	1	1	1	1	1	1	1	1	1	100	
		5265	1	1	1	1	1	1	1	1	1	1	1	100	
		5270	1	1	1	1	1	1	1	1	1	1	1	100	
		5275	1	1	1	1	1	1	1	1	1	1	1	100	
		5280	1	1	1	1	1	1	1	1	1	1	1	100	
		5285	1	1	1	1	1	1	1	1	1	1	1	100	
	5290	1	1	1	1	1	1	1	1	1	1	1	100		
	5291	1	1	1	1	1	1	1	1	1	1	1	100		
	5292	0	0	0	0	0	0	0	0	0	0	0	0		
	5489	0	0	0	0	0	0	0	0	0	0	0	0		
	5490	1	1	1	1	1	1	1	1	1	1	1	100		
	5495	1	1	1	1	1	1	1	1	1	1	1	100		
	5500	1	1	1	1	1	1	1	1	1	1	1	100		
	5505	1	1	1	1	1	1	1	1	1	1	1	100		
	5510	1	1	1	1	1	1	1	1	1	1	1	100		
	5515	1	1	1	1	1	1	1	1	1	1	1	100		
5520	1	1	1	1	1	1	1	1	1	1	1	100			
5525	1	1	1	1	1	1	1	1	1	1	1	100			
5530	1	1	1	1	1	1	1	1	1	1	1	100			
5531	1	1	1	1	1	1	1	1	1	1	1	100			
5532	0	0	0	0	0	0	0	0	0	0	0	0			
11AC80	5290	5247	0	0	0	0	0	0	0	0	0	0	0	0	
		5248	1	1	1	1	1	1	1	1	1	1	1	100	
		5249	1	1	1	1	1	1	1	1	1	1	1	100	
		5250	1	1	1	1	1	1	1	1	1	1	1	100	
		5255	1	1	1	1	1	1	1	1	1	1	1	100	
		5260	1	1	1	1	1	1	1	1	1	1	1	100	
		5265	1	1	1	1	1	1	1	1	1	1	1	100	
		5270	1	1	1	1	1	1	1	1	1	1	1	100	
		5275	1	1	1	1	1	1	1	1	1	1	1	100	
		5280	1	1	1	1	1	1	1	1	1	1	1	100	
		5285	1	1	1	1	1	1	1	1	1	1	1	100	
		5290	1	1	1	1	1	1	1	1	1	1	1	100	
		5295	1	1	1	1	1	1	1	1	1	1	1	100	
		5300	1	1	1	1	1	1	1	1	1	1	1	100	
		5305	1	1	1	1	1	1	1	1	1	1	1	100	
		5310	1	1	1	1	1	1	1	1	1	1	1	100	
		5315	1	1	1	1	1	1	1	1	1	1	1	100	
		5320	1	1	1	1	1	1	1	1	1	1	1	100	
	5325	1	1	1	1	1	1	1	1	1	1	1	100		
	5330	1	1	1	1	1	1	1	1	1	1	1	100		
	5331	0	0	0	0	0	0	0	0	0	0	0	0		
	5486	0	0	0	0	0	0	0	0	0	0	0	0		
	5487	1	1	1	1	1	1	1	1	1	1	1	100		
	5488	1	1	1	1	1	1	1	1	1	1	1	100		
5489	1	1	1	1	1	1	1	1	1	1	1	100			
5490	1	1	1	1	1	1	1	1	1	1	1	100			
5495	1	1	1	1	1	1	1	1	1	1	1	100			



5500	1	1	1	1	1	1	1	1	1	1	1	100
5505	1	1	1	1	1	1	1	1	1	1	1	100
5510	1	1	1	1	1	1	1	1	1	1	1	100
5515	1	1	1	1	1	1	1	1	1	1	1	100
5520	1	1	1	1	1	1	1	1	1	1	1	100
5525	1	1	1	1	1	1	1	1	1	1	1	100
5530	1	1	1	1	1	1	1	1	1	1	1	100
5535	1	1	1	1	1	1	1	1	1	1	1	100
5540	1	1	1	1	1	1	1	1	1	1	1	100
5545	1	1	1	1	1	1	1	1	1	1	1	100
5550	1	1	1	1	1	1	1	1	1	1	1	100
5555	1	1	1	1	1	1	1	1	1	1	1	100
5560	1	1	1	1	1	1	1	1	1	1	1	100
5565	1	1	1	1	1	1	1	1	1	1	1	100
5570	1	1	1	1	1	1	1	1	1	1	1	100
5571	1	1	1	1	1	1	1	1	1	1	1	100
5572	1	1	1	1	1	1	1	1	1	1	1	100
5573	1	1	1	1	1	1	1	1	1	1	1	100
5574	1	1	1	1	1	1	1	1	1	1	1	100
5575	0	0	0	0	0	0	0	0	0	0	0	0



Test Graphs

11AC20_5260

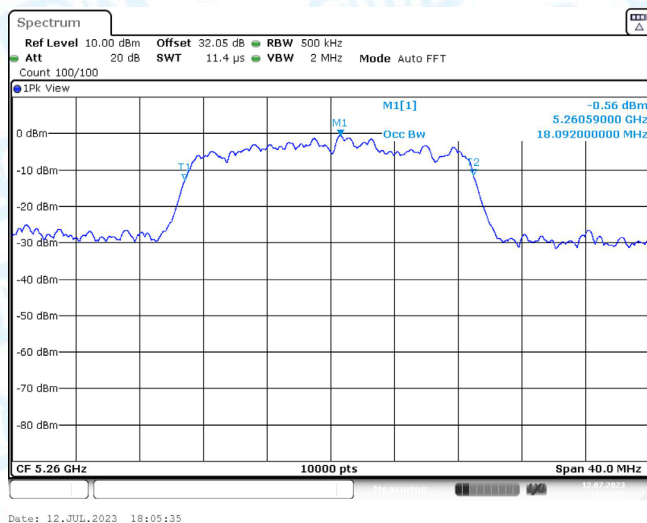

11AC20_5500

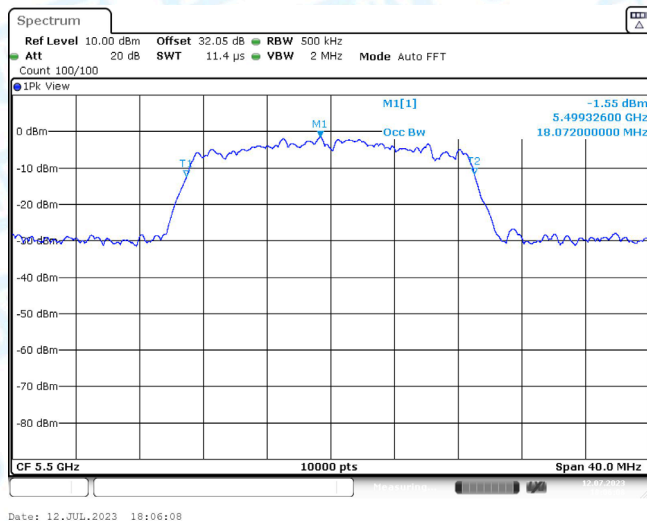

11AC40_5270

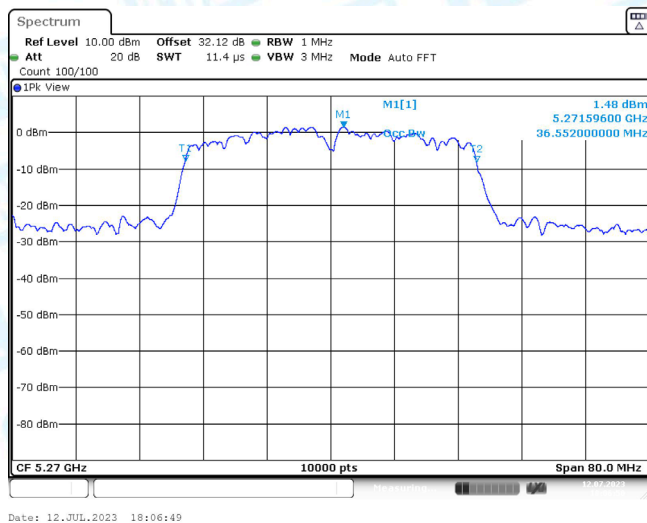

11AC40_5510

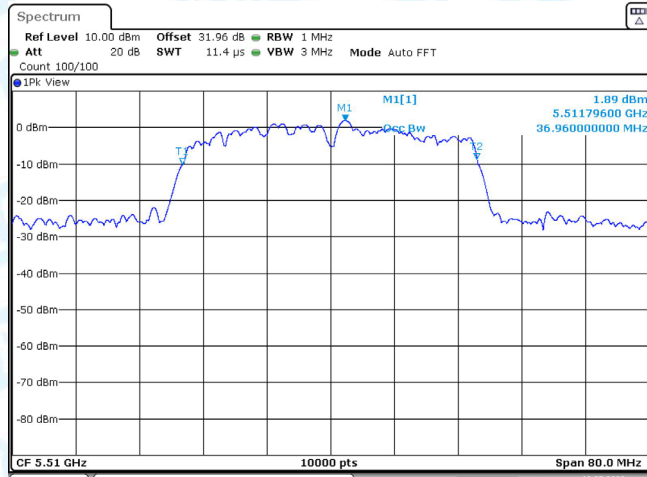

Date: 12, JUL, 2023 18:07:08

11AC80_5290

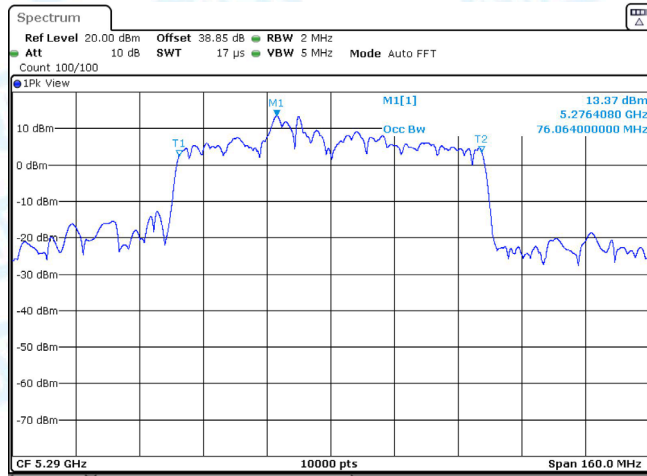

Date: 25, JUN, 2023 21:35:58

11AC80_5530

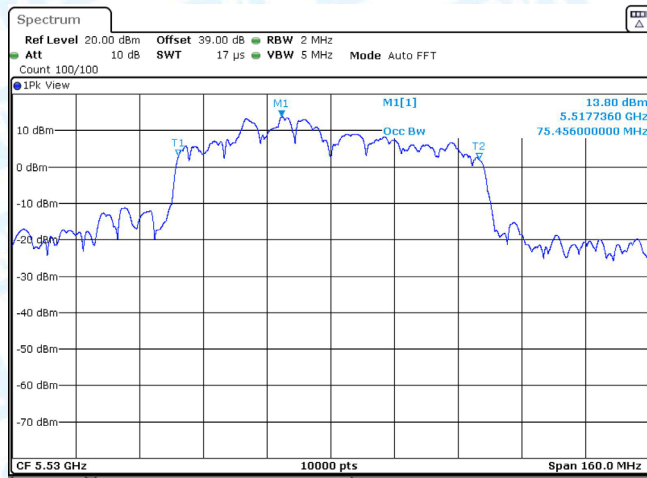

Date: 25, JUN, 2023 23:21:45

----END OF THE REPORT-----

