

## 样品承认规格书

### PART SHEET FOR APPROVAL

制造商名称: Manufacturer:	深圳自由行通信技术有限公司 Shenzhen Free Walk Communication Technology Co. LTD
供应商名称 Supplier::	深圳自由行通信技术有限公司 Shenzhen Free Walk Communication Technology Co. LTD
产品名称: Part Description:	2.4G/5G 内置天线(L=130mm) 2.4G/5G built-in antenna (L=130mm)
规格型号: Model No:	DV9161
物料编码: Cust P/N:	
日期: Issued Date:	2021-12-04

#### 供应商确认 Supplier confirmation

承办 Made By	审核 Engineer	批准 Approver

#### 华曦达确认 SDMC confirmation

承认原因: Approval Reason:	<input type="checkbox"/> 新物料 New Part <input type="checkbox"/> 替代料 Substitute Part		
承办 Made By	审核 Engineer		批准 Approver
	品质 Quality	研发 R&D	业务 Sales

备注: 签名表明提交样品获得承认, 图纸规格已经受控。Note: Signature indicates that the submitted sample is approved and the drawing/specification is now the controlling document.

地址: 深圳市南山区高新科技园科技南十二路 18 号长虹科技大厦 19 层  
Address: 19/F, Changhong Science & Technology Mansion, No.18, Keji South 12th Road, High-tech Industrial Park, Nanshan District, Shenzhen, China



# 深圳自由行通信技术有限公司

Shenzhen Free Walk Communication Technology Co. LTD

**ADD:** 深圳市宝安西乡鹤洲西区工业园 2 栋 3 楼  
3rd Floor, Building 2, Hezhou West Industrial Park,  
Xixiang, Baoan, Shenzhen

**Email:** [zyx\\_sz@yeah.net](mailto:zyx_sz@yeah.net)

**TEL:** 86-0755-29955983 **FAX:** 86-0755-29955983

## 承认书

# APPROVAL SHEET

客户 (Customer) : 深圳市华曦达科技股份有限公司  
SHEN ZHEN SDMC Technology Co., LTD

产品 (Product) : 2.4G/5G 内置天线(L=130mm)  
2.4G/5G built-in antenna (L=130mm)

型号 (Model) : DV9161

客户料号 (Customer Part Number) :

料号 (Part Number) : Z02-10222-R01

制作人 (Written By) : 胡 涛 Mr Hu

签发时间 (Issued Date) : 2021-12-04

### 客户 CUSTOMER

工程部 ENGINEER R&D DEPT	品质部 QUALITY DEPT	批准 APPROVED

### Free Walk

射频 R&D DEPT	工程部 ENGINEER R&D DEPT	批准 APPROVED
胡 涛	古政华	邓凯



# 深圳自由行通信技术有限公司

Shenzhen Free Walk Communication Technology Co. LTD

## 文件变更履历表

### Document change history

表单编号: QR-ZYX-084 版本: A0

Form number: QR-ZYX-084 Version: A0

产品型号 Product number		文件变更记录 Document change history					
序号 Serial number	变更类型 Change type	文件编号 File Number	变更日期 Change date	变更内容说明 Description of changes	制作/修订 Production/Revision	版本 version	备注 Remarks

# 目 录

## Index

一、	封面 (Cover)	1
二、	文件变更履历表 (Document Change Resume)	2
三、	目录 (Index)	3
四、	基本参数 (The basic parameters)	4
五、	工程图纸 (Product Drawing)	5
六、	测试设备 (Test Equipment & Conditions)	6
七、	测试数据 (Test Data)	7-10
八、	可靠性试验报告 (Reliability test report)	11
	维持力 (Sustaining power)	11
	恒温恒湿试验 (Constant temperature and humidity test)	12-13
	高低温冷热冲击 (High and low temperature shock)	14-15
	盐雾测试 (Salt spray test)	16
九、	天线图片 (Antenna Picture)	17
十、	包装方式 (TEE PACKING WAY)	18

The basic parameters

A. Electrical Characteristics	
<b>Frequency</b>	<b>2400 MHz ~2500MHz/5150MHz~5850MHz</b>
<b>VSWR</b>	<b>&lt;2</b>
<b>Efficiency</b>	<b>&gt;50%</b>
<b>Impedance</b>	<b>50 Ohm</b>
<b>Polarization</b>	<b>Linear</b>
<b>Gain</b>	<b>2.4G/5G 4±1dBi</b>
B. Material & Mechanical Characteristics	
<b>Material of Radiator</b>	
<b>Cable Type</b>	<b>Φ1.13 Gray</b>
<b>Connector Type</b>	<b>First generation IPEX</b>
<b>Dimension</b>	
C. Environmental	
<b>Operation Temperature</b>	<b>- 20 °C ~ + 60 °C</b>
<b>Storage Temperature</b>	<b>- 40 °C ~ + 80 °C</b>

序号 NO	品名 Name	材料/规格 Material	颜色 Colour	数量 Amount	备注 Remark
①	POB	FR-4	绿色 Green	1	
②	∅1.13射频线 RF line	Cu+编织带 Cu+Woven belt	灰色 black	1	
③	泡棉胶 Foam rubber	EVA+3M9448A	黑色 black	1	
④	IPEX	第一代 The third generation	金色 golden	1	

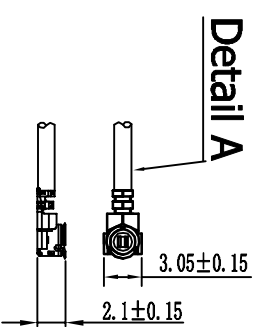
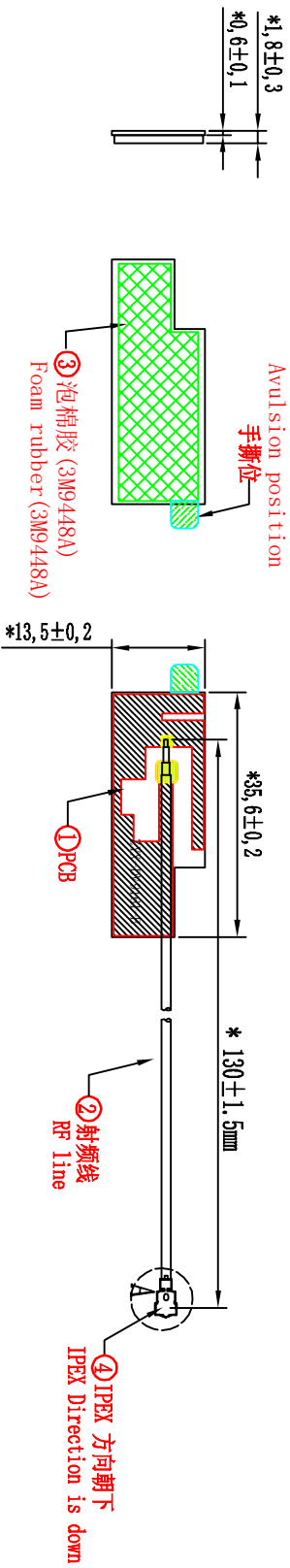

notes:

- Standard \* is the key dimension, Dimensions not marked with tolerance shall be tested according to  $\pm 0.15$
- Refer to drawing without dimension; Other dimensions are subject to actual matching;
- The Routing area, The gold-plating, The 3M300LSE gum
- The product shall be free of oil, dust, burr, etc;
- accord with ROHS

## 深圳自由行通信技术有限公司

Shenzhen Free Walk Technology Co. LTD

Third angle system	机种/Project	品名/Part Name	料号/Part NO	客户料号 Customer P/N	unit	mm	Scale	1:1	Rea	A
0~10	±0.10	○	0.02							
10~20	±0.15	◎	0.03							
20~40	±0.20	⊥	0.02							
40~	±0.25	∇	0.04							
Do not measure the drawings	Location	W/A								

Date 2021/12/04

Checked by MD Gudog

RF Li wen ke

## Test Equipment & Conditions

### 1. Network Analyzers :

Agilent 8753D 5071B

### 2. Communications Test Set:

Agilent 8960

### 3. 3D Chamber Test System

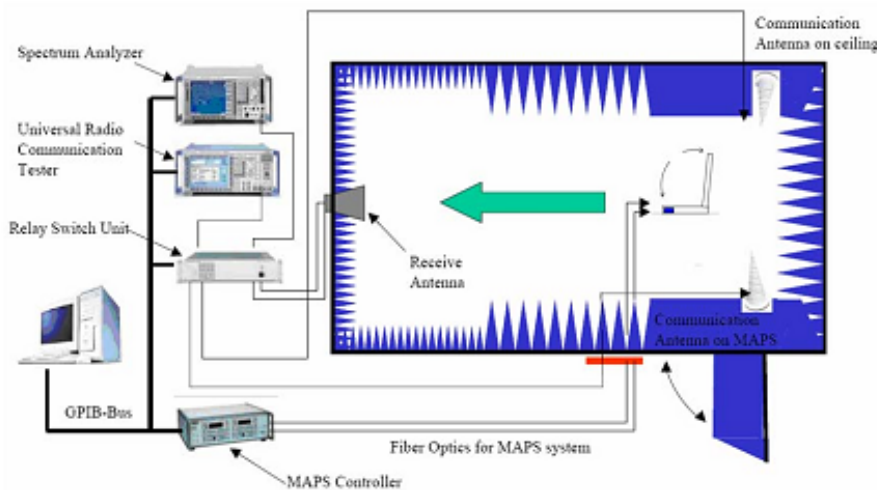

(Testing by 3D anechoic chamber)

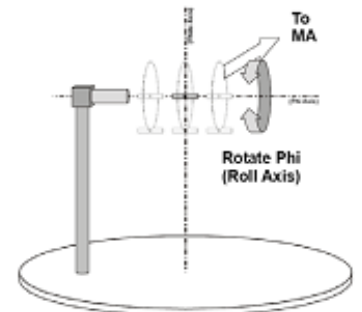

Phi axis test

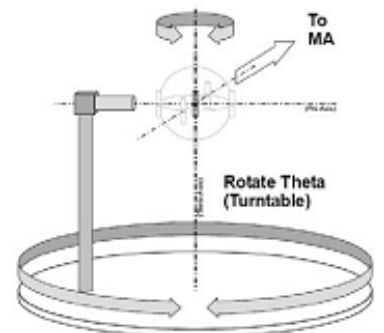

Theta axis test

测试数据 Test Data

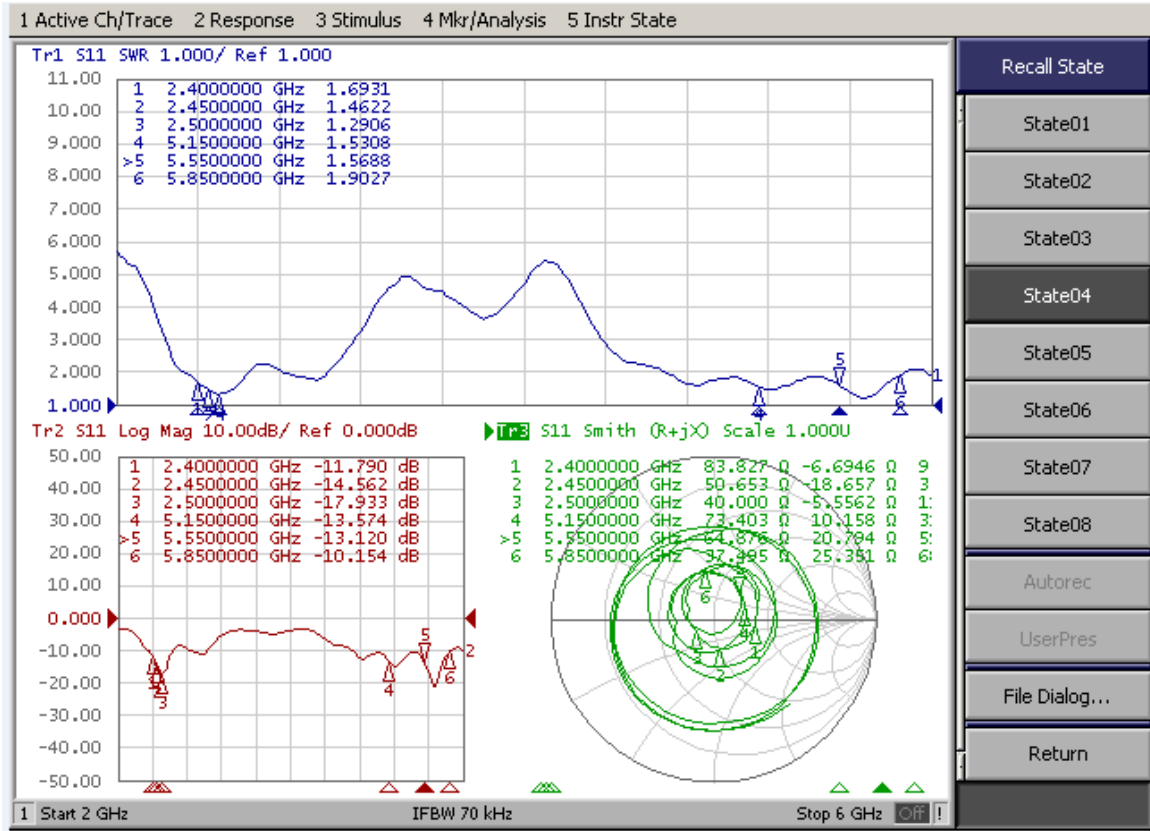

驻波比数据 SWR data

Freq/GHz	2.4	2.45	2.5	5.15	5.55	5.85
VSWR	1.6	1.4	1.2	1.2	1.2	1.9





效率&增益:

Efficiency&Gain

2.4G test data

Freq(MHz)	Effi (%)	Gain(dBi)
2400	60.81	4.79
2410	60.46	4.79
2420	61.98	3.72
2430	63.55	4.13
2440	63.05	3.94
2450	62.07	4.44
2460	63.15	3.87
2470	63.35	4.39
2480	63.65	4.27
2490	64.46	4.46
2500	65.39	4.42

5.8G test data

Freq(MHz)	Effi (%)	Gain(dBi)
5150	68.68	3.33
5200	65.53	3.30
5250	65.53	3.32
5300	60.08	3.08
5350	63.88	3.07
5400	74.66	3.26
5450	72.61	3.44
5500	59.95	3.94
5550	64.43	3.80
5600	66.09	3.68
5650	64.57	3.89
5700	59.45	3.90
5750	66.52	3.11
5800	64.16	3.14
5850	58.95	3.29

方向图 (3D)

Directional map (3D)

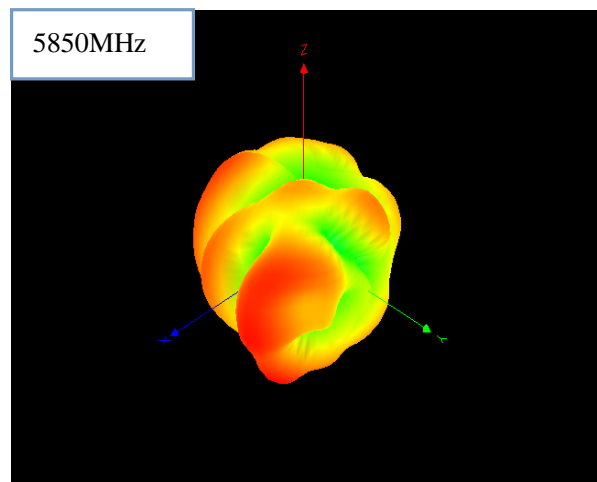
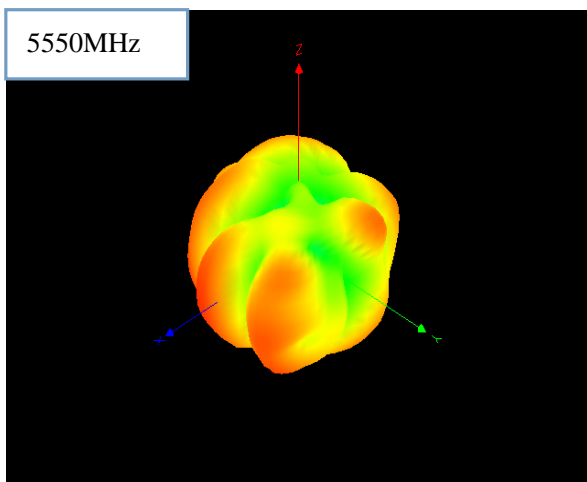
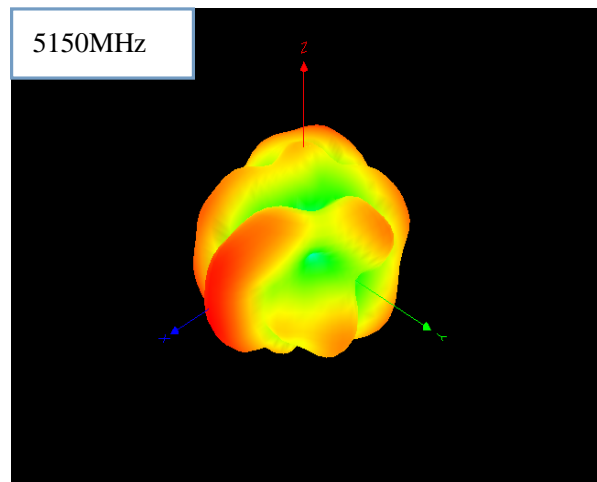
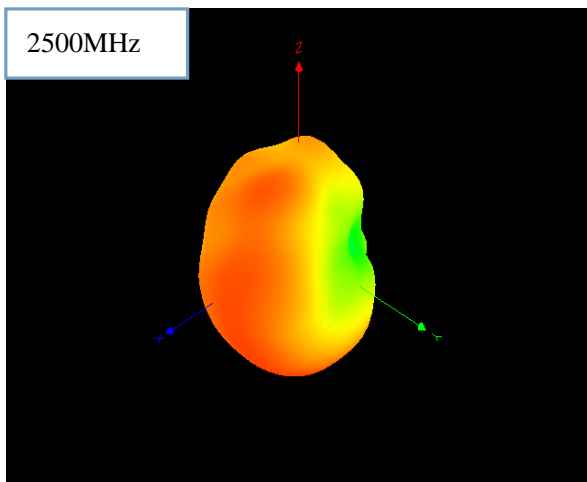
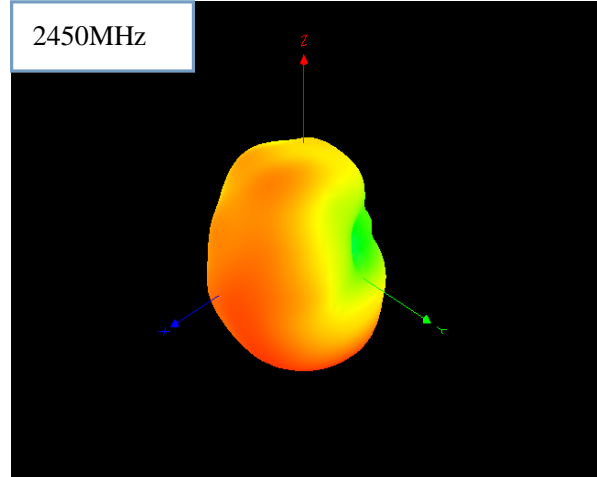
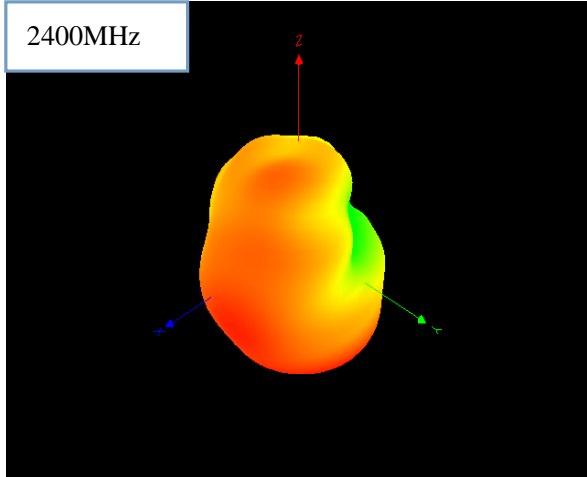

方向图 (2D)

Directional map (2D)

XOY surface

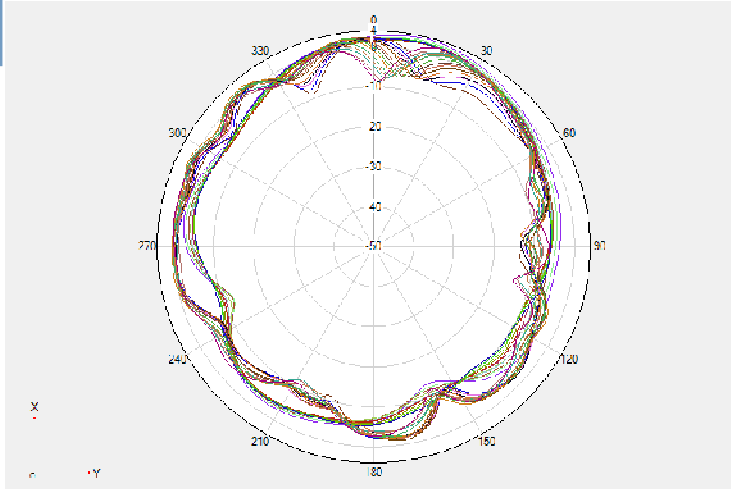

ZOX surface

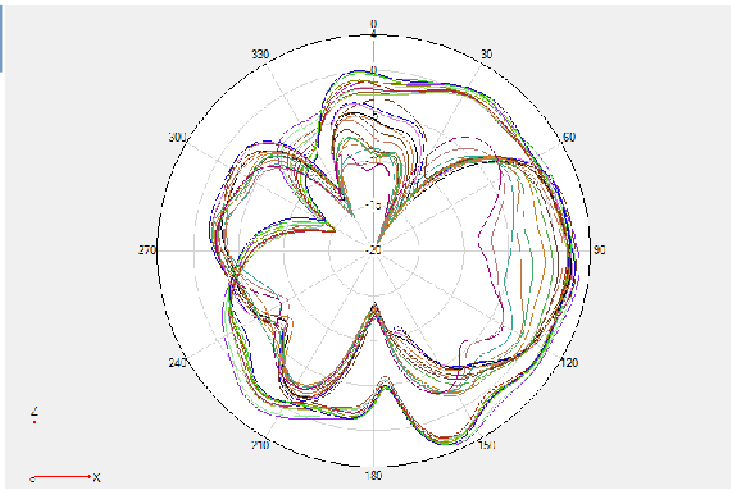

ZOY surface

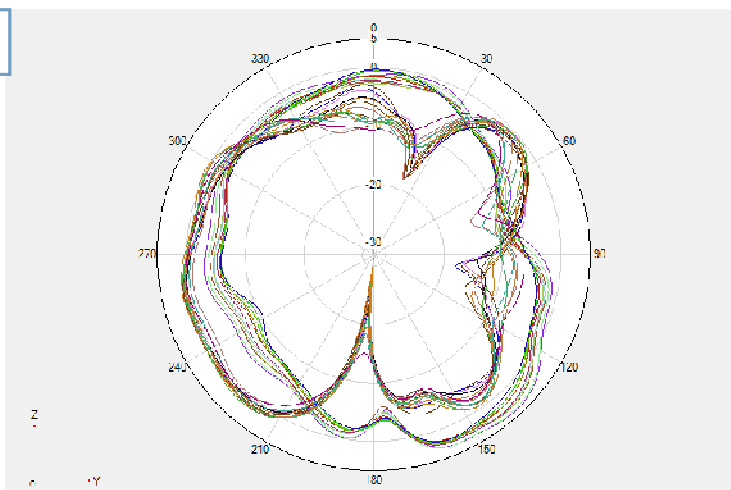

## 可靠性试验报告

### Reliability test report

#### 维持力 Sustaining power

试验/试验项目 Test/test item	维持力 Sustaining power		检验单号 Inspection order number		
产品名称/规格 Product name/specification	2.4G/5G 内置天线(L=130mm) 2.4G/5G built-in antenna (L=130mm)		试验数量 (Number of tests) : 5 PCS		
送检日期 (Inspection date) : 2021-10-22			完成日期 (Completion Date) : 2021-10-23		
试验/检验设备 (Test/inspection equipment) :					
1. 拉力测试计 (Tensile tester)					
试验/检验条件 (Test/inspection conditions) :					
1. 温度 (Temperature) : 18-25℃					
2. 湿度 (Humidity) ≤65%RH					
试验/检验结果 (Test/inspection results) :					
项目 project 项目 conditi	端子与线缆之间的维持力 (Holding force between terminal and cable) ≥1kgf				
测试次数Testing frequency	1	2	3	4	5
测试结果Test Results	1.11	1.12	1.08	1.08	1.05
备注 (Remarks) :					
试验/检验判定 (Test/inspection judgment) :					
<input checked="" type="checkbox"/> 合格 (PASS) <input type="checkbox"/> 不合格 (NG) <input type="checkbox"/> 不作判定 (No judgment)					
测试 (test) : 梁艺叶 (Yiye Liang)			审核 (Review) : 黄俊 (Jun Huang)		

## 恒温恒湿试验 Constant temperature and humidity test

试验/试验项目 Test/test item	<b>恒温恒湿试验</b> Constant temperature and humidity test	检验单号 Inspection order number
产品名称/规格 Product name/specifica tion	2.4G/5G 内置天线(L=130mm) 2.4G/5G built-in antenna (L=130mm)	试验数量 (Number of tests) : 5PCS
送检日期 (Inspection date) : 2021-10-22		完成日期 (Completion Date): 2021-10-23
试验/检验设备 (Test/inspection equipment) :		
1. 可编程恒温恒湿试验箱 (Programmable constant temperature and humidity experiment box)		
2. 8753ES 网络分析仪 (8753ES network analyzer)		
试验/检验条件 (Test/inspection conditions) :		
1. 恒温-30℃ 下试验 12H (Test at constant temperature -30℃ for 12H)		
2. +65℃ 65~70%RH 试验 12H, 共 24 小时: (+65℃ 65~70%RH test for 12H, a total of 24 hours;)		
<b>试验结果</b> test results		
判定标准 (judgement standard):		
1、金属表面镀层应无剥落, 裂痕起皱, 分离等; 非金属部分不应发生变色, 开裂, 变形, 脱胶等不良; The metal surface coating should be free from peeling, cracks, wrinkles, separation, etc.; non-metal parts should not be discolored, cracked, deformed, or degummed;		
2、电气测试符合标准要求: 电压驻波比测试合格 The electrical test meets the standard requirements: the voltage standing wave ratio test is qualified		



# 深圳自由行通信技术有限公司

Shenzhen Free Walk Communication Technology Co. LTD

检验项目 Test items	恒温恒湿试验前 Before constant temperature and humidity test	恒温恒湿试验后 After constant temperature and humidity test	缺陷描述 Defect description	判定结果 judgement result
外观 Exterior	外观无变色开裂、变形、脱胶 No discoloration, cracking, deformation or degumming in appearance	外观无变色开裂、变形、脱胶 No discoloration, cracking, deformation or degumming in appearance	无 no	合格 PASS
电性能 Electrical properties	天线电压驻波比测试合格 The antenna voltage standing wave ratio test is qualified	天线电压驻波比测试合格 The antenna voltage standing wave ratio test is qualified	无 no	合格 PASS

试验/检验判定 (Test/inspection judgment) :  
 合格 (PASS)       不合格 (NG)       不作判定 (No judgment)

测试 (test) : 梁艺叶 (Yiye Liang)      审核 (Review) : 黄俊 (Jun Huang)

## 高低温冷热冲击 High and low temperature shock

试验/试验项目 Test/test item	高低温冷热冲击 High and low temperature shock	检验单号 Inspection order number
产品名称/规格 Product name/specification	2.4G/5G 内置天线(L=130mm) 2.4G/5G built-in antenna (L=130mm)	试验数量 (Number of tests) : 5PCS
送检日期 (Inspection date) : 2021-10-22		完成日 (Completion Date) : 2021-10-23
试验/检验设备 (Test/inspection equipment): 1. 高低温交变湿热箱 (High and low temperature alternating hot and humid box) 2. 8753ES 网络分析仪 (8753ES network analyzer)		
试验/检验条件 (Test/inspection conditions): -40°C (2H) --- 间隔 80°C (2H) , 6 次循环, 共 24 小时 -40° C (2H) --- interval 80° C (2H), 6 cycles, 24 hours in total		
<b>试验结果</b> <b>test results</b>		
判定标准 (judgement standard): 1、金属表面镀层应无剥落, 裂痕起皱, 分离等; 非金属部分不应发生变色, 开裂, 变形, 脱胶等不良; The coating on the metal surface should be free from peeling, cracks, wrinkles, separation, etc.; non-metal parts should not be discolored, cracked, deformed, or degummed; 2、电气测试符合标准: 电压驻波比测试合格。 Electrical test meets the standard: the voltage standing wave ratio test is qualified		



# 深圳自由行通信技术有限公司

Shenzhen Free Walk Communication Technology Co. LTD

检验项目 Test items	高低温冷热冲击试验前 Before high and low temperature thermal shock test	高低温冷热冲击试验后 After high and low temperature thermal shock test	缺陷描述 Defect description	判定结果 judgement result
外观 Exterior	外观无变色开裂、变形、脱胶 No discoloration, cracking, deformation or degumming in appearance	外观无变色开裂、变形、脱胶 No discoloration, cracking, deformation or degumming in appearance	无 no	合格 PASS
电性能 Electrical properties	天线电压驻波比测试合格 The antenna voltage standing wave ratio test is qualified	天线电压驻波比测试合格 The antenna voltage standing wave ratio test is qualified	无 no	合格 PASS
试验/检验判定 (Test/inspection judgment) : <input checked="" type="checkbox"/> 合格 (PASS) <input type="checkbox"/> 不合格 (NG) <input type="checkbox"/> 不作判定 (No judgment)				
测试 (test) : 梁艺叶 (Yiye Liang)      审核 (Review) : 黄俊 (Jun Huang)				



## 盐雾测试 Salt spray test

试验/试验项目 Test/test item	<b>盐雾测试</b> <b>Salt spray test</b>		检验单号 Inspection order number
产品名称/规格 Product name/specifica tion	2.4G/5G 内置天线(L=130mm) 2.4G/5G built-in antenna (L=130mm)		试验数量 (Number of tests) : 5PCS
送检日期 (Inspection date) : 2021-10-22			完成日 (Completion Date) : 2021-10-23
试验/检验设备 (Test/inspection equipment): 1. HL-60-SS 盐雾测试仪 (HL-60-SS Salt Spray Tester)			
试验/检验条件 (Test/inspection conditions): 1. 盐雾箱内温度为 35±2℃; 试验室温度 22~30℃ The temperature in the salt spray box is 35±2℃; the temperature in the laboratory is 22~30℃ 2. 盐雾沉降速度经 24H 喷雾后每 80cm 面积为 1-2ML/h 氯化钠浓度为 50±10g/L, PH 值为 6.5/7.2 The sedimentation rate of the salt spray after 24H spraying is 1-2ML/h per 80cm area, the sodium chloride concentration is 50±10g/L, and the PH value is 6.5/7.2			
试验/检验结果 (Test/inspection results): 合格 (PASS)			
样品编号 Sample serial number	评价等级 Rating	缺陷描述 Defect description	
1	合格 (PASS)		
2	合格 (PASS)		
3	合格 (PASS)		
4	合格 (PASS)		
5	合格 (PASS)		
试验/检验判定 (Test/inspection judgment) : <input checked="" type="checkbox"/> 合格 (PASS) <input type="checkbox"/> 不合格 (NG) <input type="checkbox"/> 不作判定 (No judgment)			
测试 (test) : 梁艺叶 (Yiye Liang)		审核 (Review) : 黄俊 (Jun Huang)	

天线图片

**Antenna Picture**

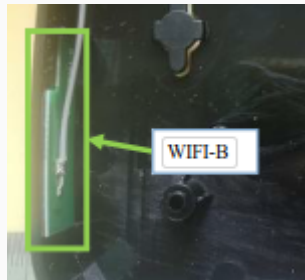

# Product packaging specification

page: 1 of 1

Product Name: antenna

Rea : A00

Except for others

一: Antenna

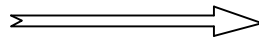

二: Put them in PE bags, quantity is packed in (50 100pcs)  
Subject to the actual situation

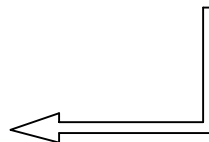
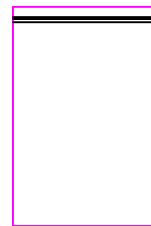
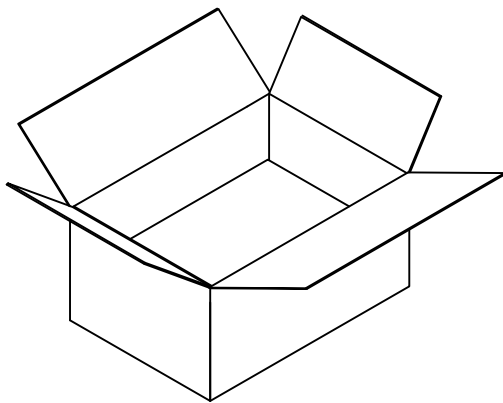

三: Put the antenna in the carton

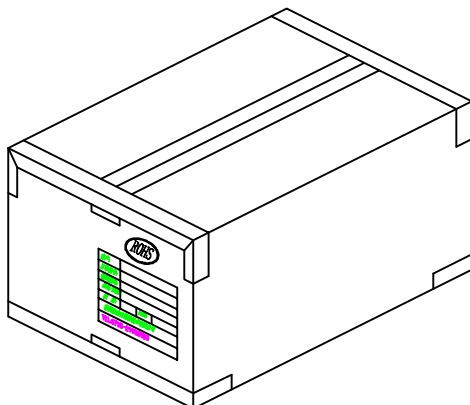

四: Seal the box and paste the production label and RoHS label on the outer box (actual situation shall prevail)