

**REXING<sup>®</sup>**

# **M2 Max**

## User Manual

The information in this manual is subject to change without notice.

[www.rexingusa.com](http://www.rexingusa.com)

# Notice

1. The user menu is to be set up in non-video mode. If the device is in video mode, please proceed only after stopping the video recording.
2. Memory Card: Using a new MicroSD card always requires formatting it to your device. Regularly clear the memory card, as continuous video recording for an extended period of time may produce some protected files that are not subject to long-term protection (these files may not be overwritten during loop recording) and some storage fragments, which must be cleared regularly in order to save usable storage space.
3. Time-lapse photography should not be enabled while driving. This function captures images more slowly than normal but plays in speed-up mode, which may affect the integrity and continuity of your video.
4. On-board Charger: The standard input voltage is configured to 12V. If a voltage greater than 12V, contact store of purchase or our customer care via **care@rexingusa.com** to replace it with a replacement charger.
5. The features described in this operation manual are available for all products of the same type. The device you buy may be a model with optional or additional functions. Menu operations may vary. Please refer to your actual product.
6. Pay attention to the mounting position, which must not interfere with driving or lead to unsafe driving operation. Make sure it is safely secured.
7. A standard 6-meter cable is provided for the rearview camera. It is not recommended to install this type of dash cam if your car is larger than the connection cable range.

 **Warning**

The battery (module or pack) must not be exposed to overheat environments such as direct sunlight or flame.

Never remove, strike, or squeeze the battery or put it in fire. Stop using the battery if it is ballooned, warped, leaking, or shows any other visible signs of damage.

# Overview

## Thank you for choosing **REXING!**

We hope you love your new products as much as we do. If you need assistance, or have any suggestions to improve it, please contact us.

 [care@rexingusa.com](mailto:care@rexingusa.com)

 (877) 740-8004

Our support team will respond to you as soon as possible.

Always a surprise with Rexing

## Check us out here.

- <https://www.facebook.com/rexingusa/>
- <https://www.instagram.com/rexingdashcam/>
- <https://www.rexingusa.com/support/registration/>

 [Facebook](#)



 [Instagram](#)



 [Site](#)



 [Product Support](#)



# What's in the box?

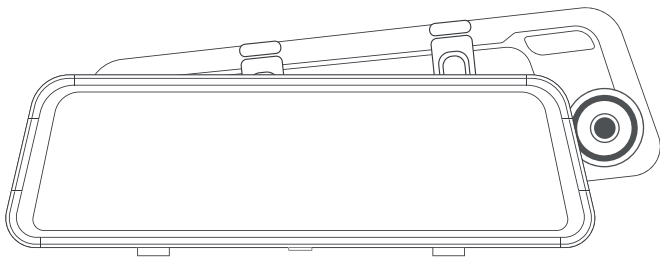

1

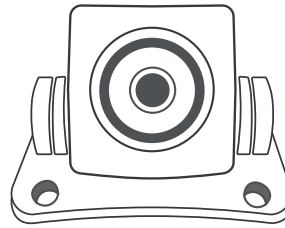

2

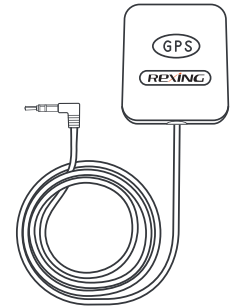

3

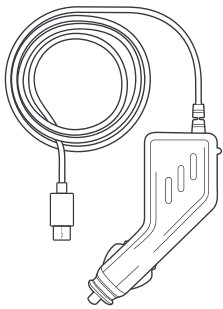

4

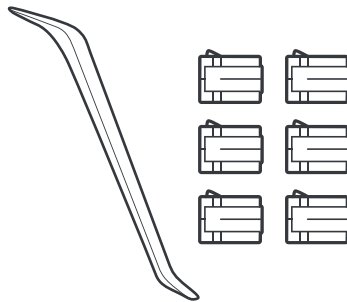

5

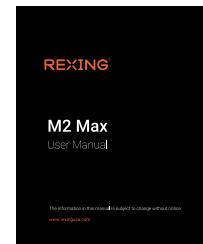

6

- 
1. Rexing M2 Max Smart Mirror Dash camera
  2. Rexing rear camera
  3. GPS Logger

4. In-car power cable (12ft)
  5. Cable Management Tool
  6. User Manual
-

# Table of Contents

Camera Overview	6
Installation	8
Basic Operations	12
Product Specifications	36
General Troubleshooting	37
Warranty & Support	38

# Camera Overview

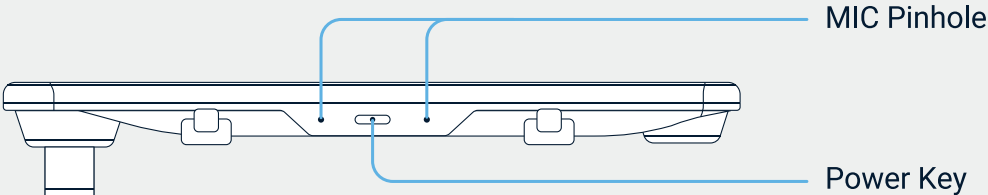
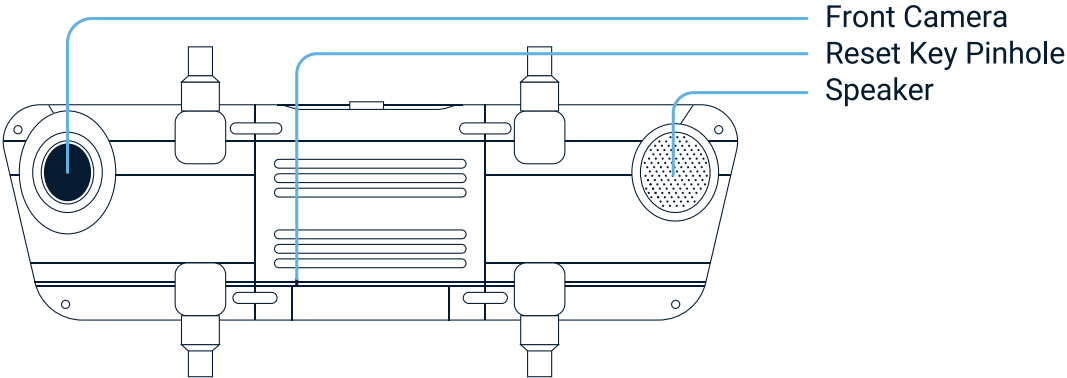
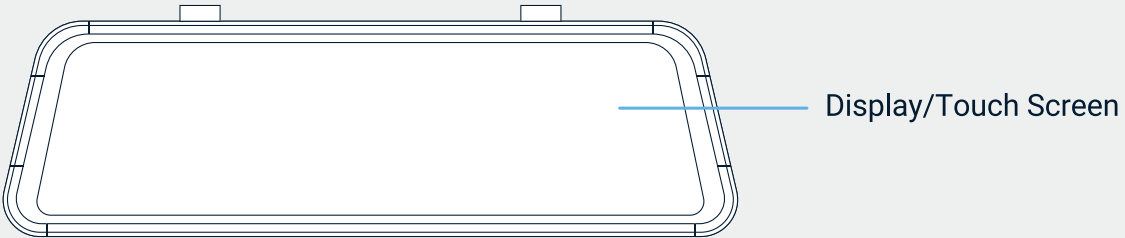
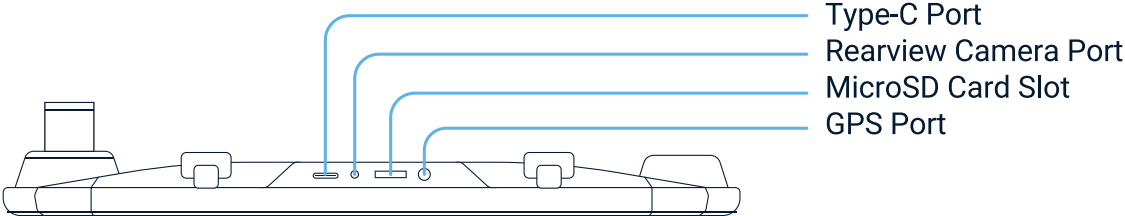

## Designation

## Description of Functions

---

### Power Button

In connection with an external power source, in the power-off state, press and hold the power button on the bottom for three seconds to start the device. In a power-on state, press and hold the power button for three seconds to switch *off* the device.

In a power-on state, press this button quickly to turn the screen backlight *off*. Press it again to turn the backlight *on*.

---

### Display / Touch Screen

Except for power - on/off operation, all other primary functions can be accessed on the LCD touch screen.

---

### Reset Key

If the device crashes, unplug the power source, OR stick a pin into the reset slot labled R on the back of the device to resume normal operation.

---

### Type-C

Power Port

---

### GPS Port

Plug the included GPS Logger into the GPS port to utilize the location tracking function.

---

### Micro SD Card Slot

A slot for inserting a MicroSD card

---

### Front Camera

Front camera faces the same direction as the front of the vehicle and captures videos/images in front of the car.

---

### Rear Camera Port

Rear camera plug-in port labled AV port on the top of the device.

---



# Installation

**!** Due to excessive mishandling, this device could be damaged during transportation. To avoid the high cost of troubleshooting and repairs due to repeated mounting and removal, we recommend that you assemble all components first after delivery and test the device with the on-board charger power supply. Make sure that the device is visibly undamaged prior to installation. Contact our Customer Care with any questions or concerns.

## I. Install the Device

1. Turn off the engine of the car.
2. Place the MicroSD card into the slot.
3. Secure the dashcam to the rearview mirror of the car.
4. Plug the GPS module into the GPS port and secure the module to a pillar on the inside of your vehicle that is near the rearview mirror. The antenna receiver side (the side without 3M adhesive) faces the outside and the side with 3M adhesive faces down. It should be properly secured.
5. Plug the charger into the car's cigarette lighter and connect it to the dash cam's Type-C Port.

### Note:

The optional rearview camera is mounted on the rear of the car. Pay attention to its orientation during installation. Plug the rearview camera connector into the corresponding port of the dashcam once the installation is completed. Adjust the position of the lens to ensure that it aligns horizontal with the ground. Start the engine to check the video functionality of the device.

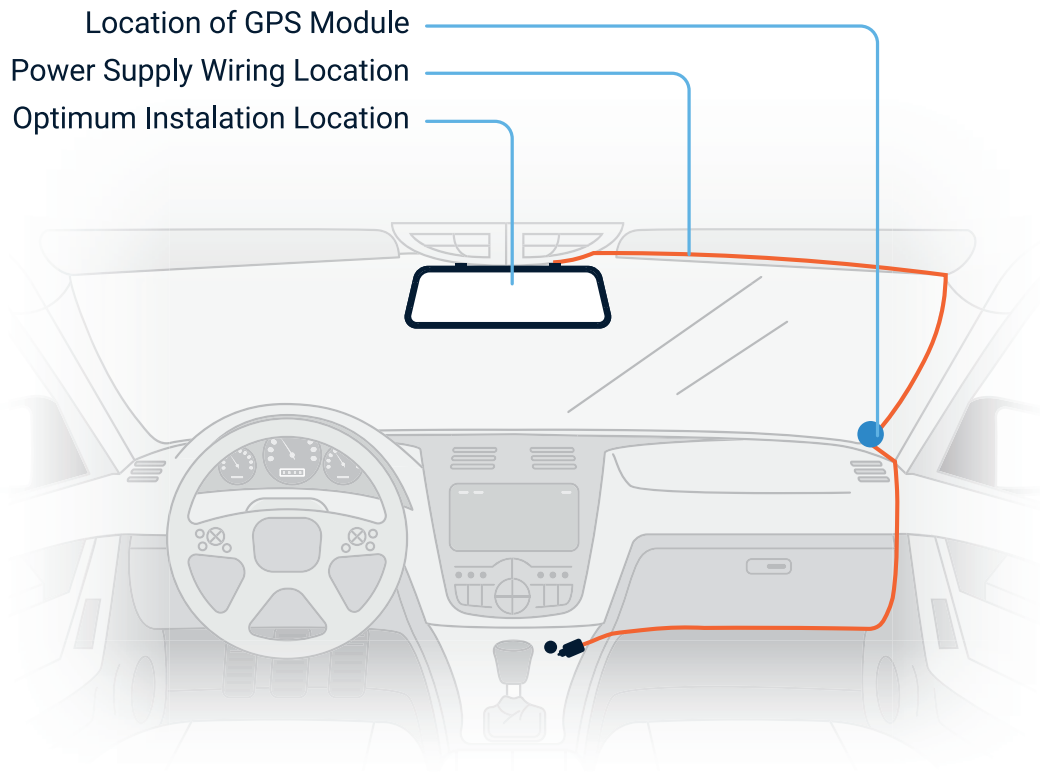

## II. Install the Rearview Camera

1. Some rearview cameras are connected through removable coupling connectors. If you receive a product with a separated plug and socketed cable, then connect the plug-in components properly according to the illustrations below. To avoid damage to the pins and connector holes, never use extra force while making connections. The rearview camera cable must be plugged into the Rear Camera port on the device.

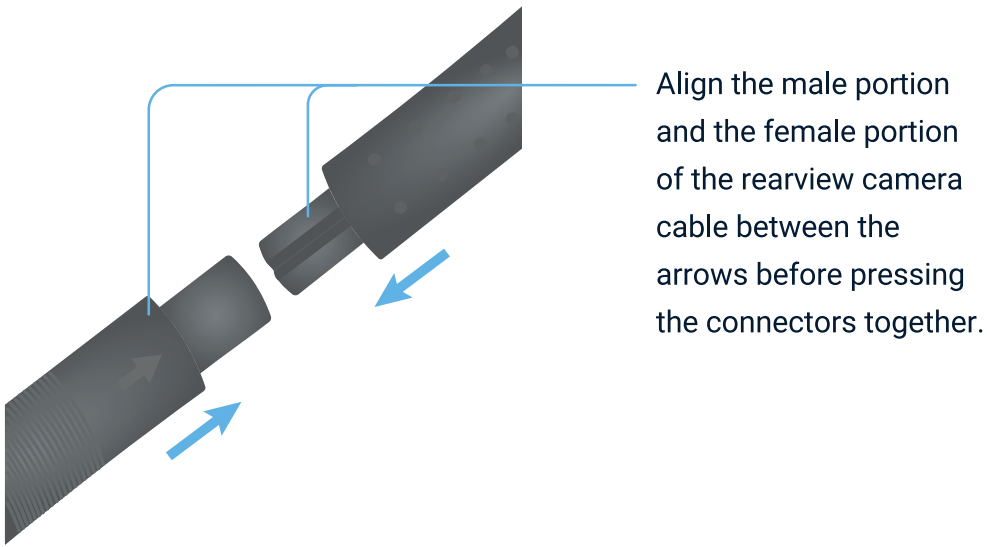

## 2. Rearview Camera Wiring Instruction (as shown below)

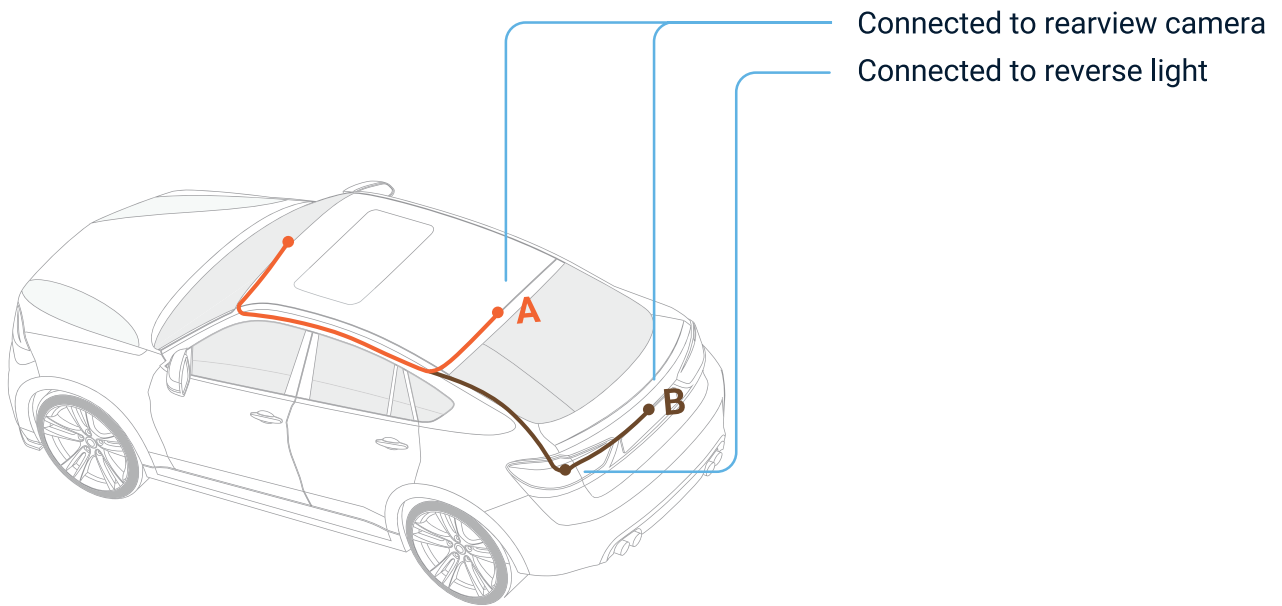

The rearview camera has two wire routing options as shown in the above figure. For both options, it is suggested that you conceal the wiring against the edges of the car's door.

### Note:

The device is configured with a media streaming rearview camera that provides clear traffic view behind the car. To obtain clearer and more intuitive images, it is recommended to mount the camera above the license plate (as shown by option B).

### 3. Instructions for Reverse Trigger Wiring (optional)

The red wire connects to the positive end of one of the car's reverse light. Make sure that the car charger is energized during use. This is only required if you want to utilize the auto backup camera feature.

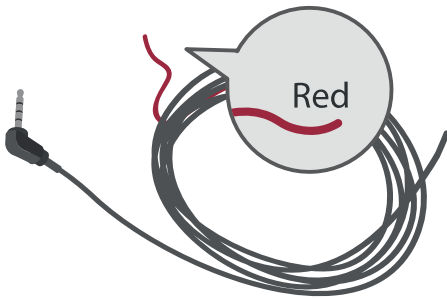

## III. Turn on the Dash Cam

Connect the dash cam to the car charger after installation. Starting the car engine will start the device. The built-in battery will be charged at the same time.

### Note:

Due to unstable voltages caused by starting the car engine, a voltage fluctuation in some vehicles may be especially obvious. If a flashing screen or some other unforeseeable operating problem occurs when you start the engine, it is recommended to unplug the device from the charger before starting the engine, and then reconnect it after the engine is running.

# Basic Operations

## I. Video Mode

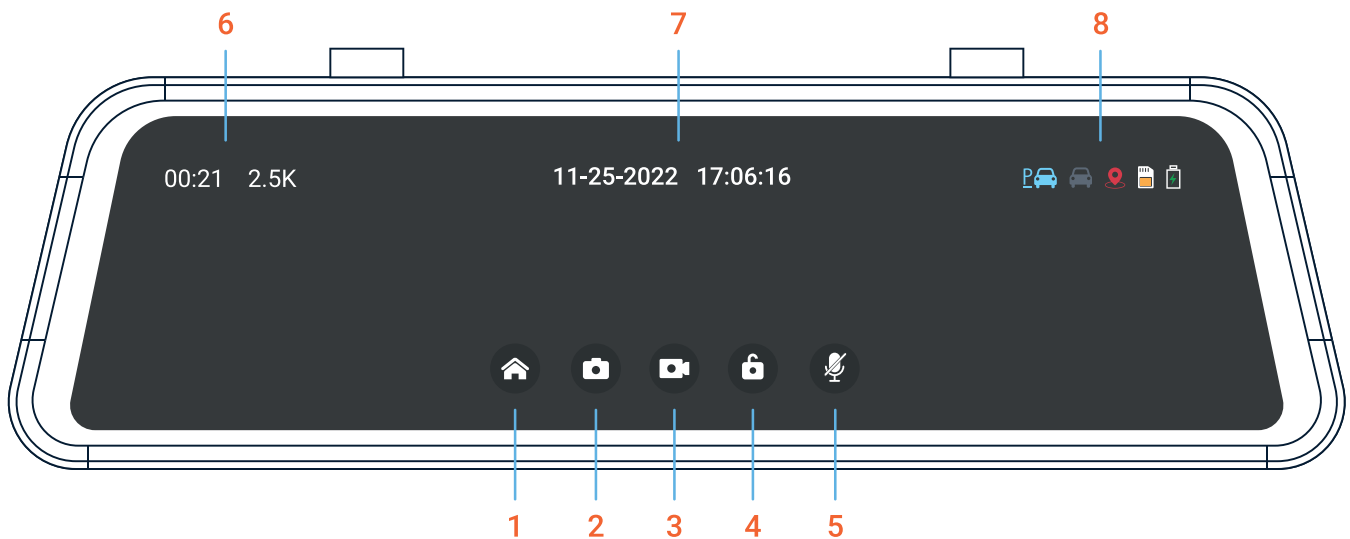

### Key Functions

- |                         |                           |
|-------------------------|---------------------------|
| 1. Home                 | 5. On/Off Audio Recording |
| 2. Take Snapshot        | 6. Video Duration         |
| 3. Start/Stop Recording | 7. Date & Time            |
| 4. Recorded File Locked | 8. Status Bar             |

## Video Recording Operation

With a MicroSD card inserted in the device, it will record automatically in video mode after starting. A red indicator  will flash in the upper left corner of the screen during video recording.



Press the icon to stop recording

---



Press the icon to start recording when no recording is active.

---



Press the icon to take a snapshot.

---



Press the unlocked icon during recording will lock the current video file and the icon will change to the locked icon  at the same time.

---



Press the icon again to unlock the current video and the icon changes to the unlocked icon .

---



Press the icon to stop audio recording.

---



Touch the icon again to start audio recording.

---



Swipe left/right to reveal front and rear camera view.

---

## II. Home Interface

Choosing the home button brings you to the home screen where you can find smart drive, file explorer, camera settings, and system settings

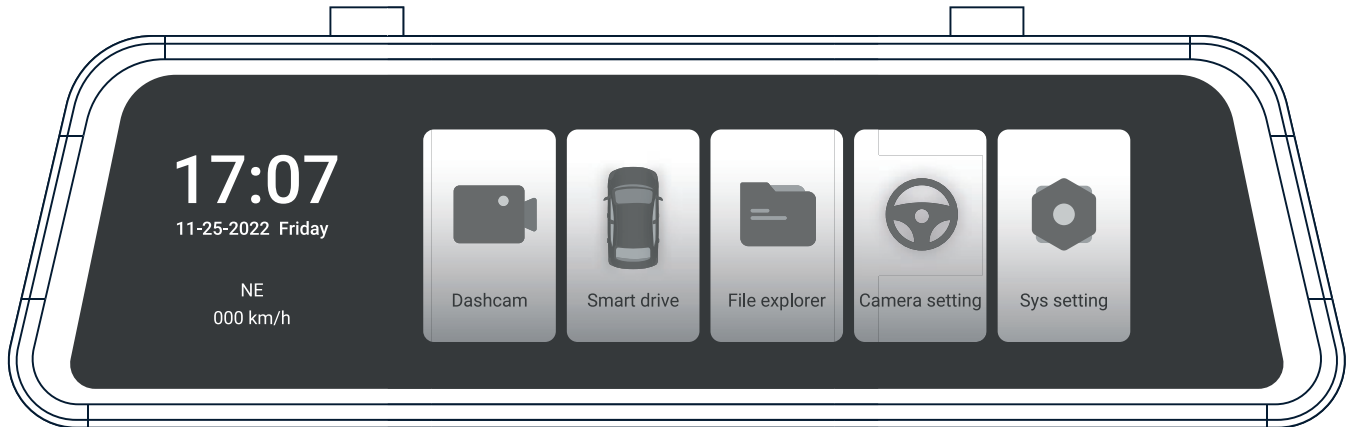

## III. Smart Drive

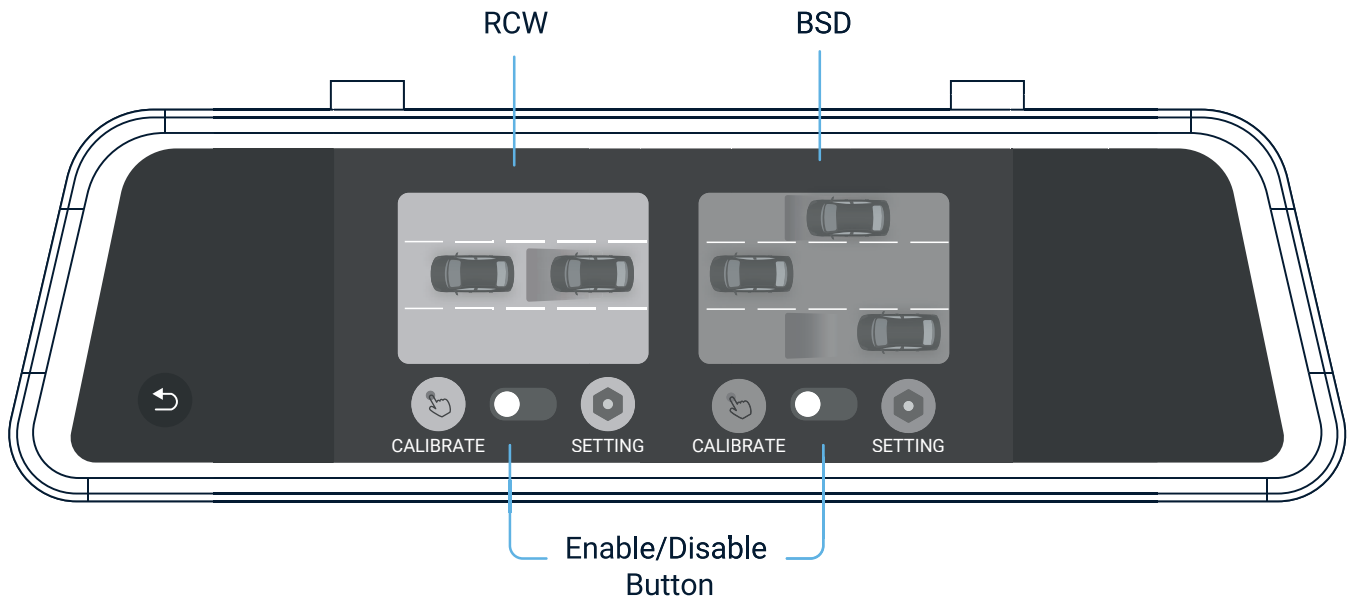

## Outline

RCW refers to Rear-End Collision Warning. This warning system will trigger an alert when an object or vehicle is detected by the rear camera.

**BSD** refers to Blind Spot Detection, which monitors in real time any vehicle in the blind spots on both sides during driving. It gives an alert so as to reduce the risk of traffic accidents that are likely to occur when you intend to shift to another lane. It is also called **LCA** (Lane Change Assist).

**RCW** and **BSD** systems may be interfered with by sunlight, inadequate lane lines, rain, and fog. Certain impacts may be affected by these inaccuracies, and some collisions may not be avoidable. Currently, the **RCW** provides a rate of accuracy between 80 to 90 percent during the daytime and 60 to 70 percent at night. **BSD** provides a rate of accuracy around 90 percent during the daytime and around 80 percent at night.

The following instructions are mainly used for the calibration of the smart driving application of the dashcam. It mainly includes the calibration of **RCW** and the blind spot monitoring range.

Before using **RCW and BSD** it is necessary to calibrate it according to its mounting position and view angle of the dashcam. Only in this way can it detect vehicles and lanes accurately.

### Disclaimer:

The system is a safe driving assistant system and it cannot be used as a proof for the liability of traffic accidents.





# BSD Calibration

- 1 Smart Drive
- 2 Turn on BSD
- 3 Choose Calibrate under BSD
- 4 Read Calibration Directions and choose Next
- 5 Use the arrows on screen to set the view correctly.
- 6 Once set correctly so that the yellow box lines up with the red area, choose save,
- 7 Success
- 8 Save results and exit
- 9 End

## Setup Steps:

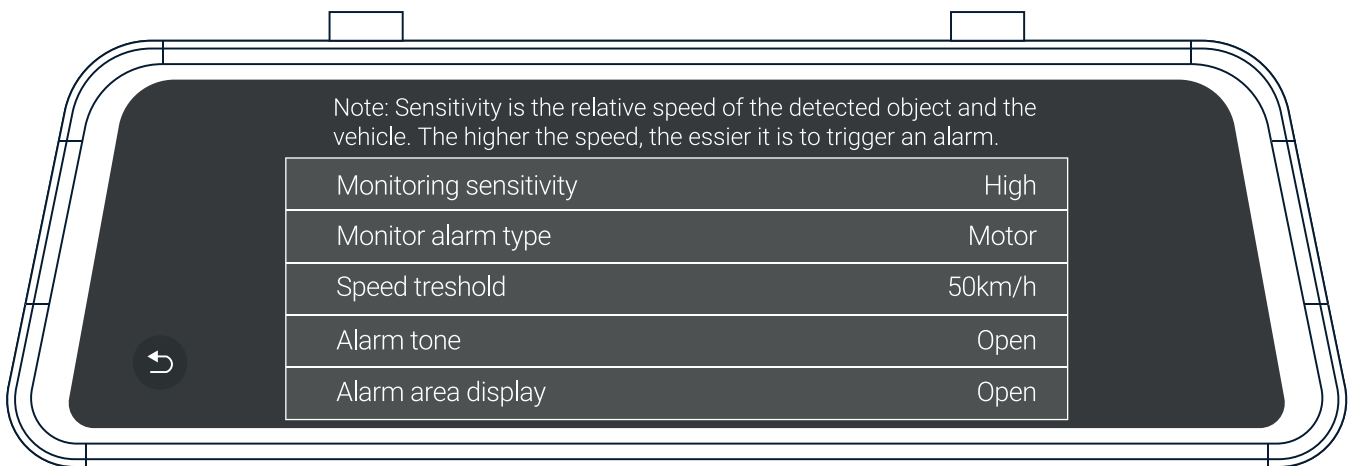
1. Open the smart driving application and turn on BSD (blind spot detection). The button turns from gray to blue.
2. Click  to access the BSD setup page. Click the option *Monitoring sensitivity* and select the appropriate option (a default value may be used). Monitoring sensitivity refers to the relative speed of the detected object and the vehicle.



4. Click  to access the BSD calibration page. You will initially see the concept and a brief introduction on the calibration page. Click Next to access the real calibration interface, as shown below. Move the red line up or down align with the horizon (the intersection line between the sky and ground). Move the yellow line up or down to the interface between the engine hood and ground. Move the green line left or right to the focal point where the far end of the road intersects with the horizon.

**Note:**

The range of calibration line adjustment is limited. If the extreme adjustment has reached its limits and the result is unsatisfactory, it may be necessary to adjust the mounting position of the dashcam or perform fine adjustments of the lens so as to align it properly within all angles.

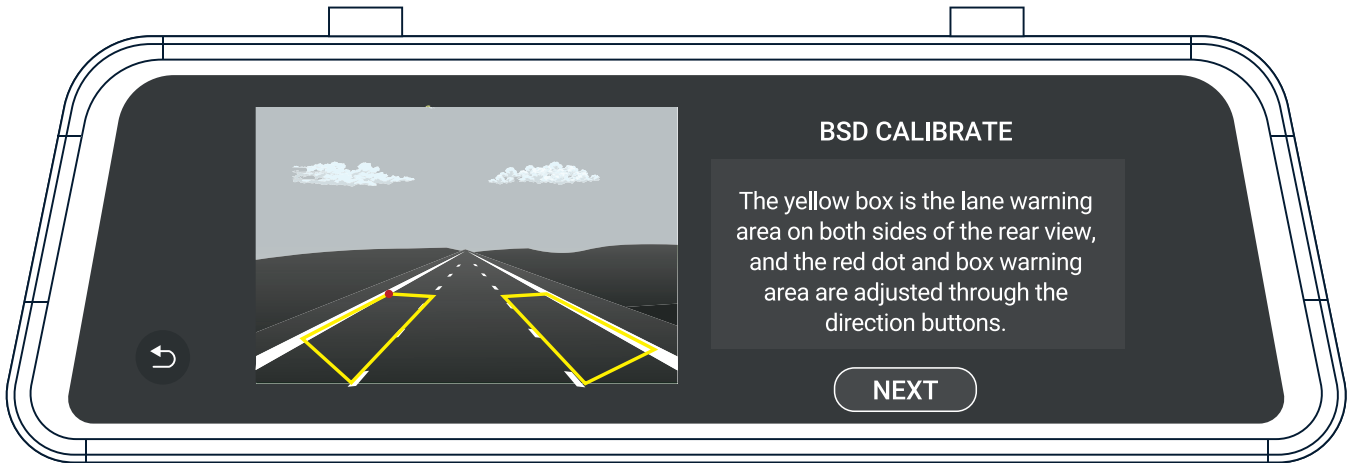

5. When the adjustment is accurate as shown above, save and exit.

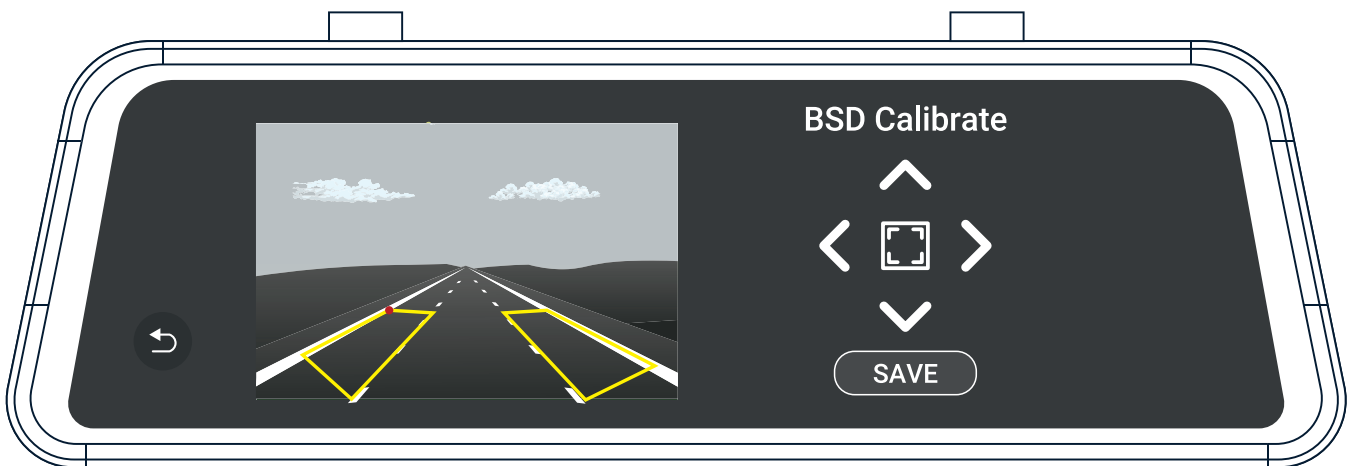

# RCW Calibration

- 1 Smart Drive
- 2 Turn on RCW
- 3 Calibrate RCW
- 4 Read Calibration directions and choose next
- 5 Use arrows to establish the correct view
- 6 Once correct view is established choose save
- 7 Move the box left or right to adjust blind spot warning range
- 8 Save the result and exit
- 9 End

## Setup Steps:

1. Open the smart driving application and turn on RCW (Rear Collision Warning). The button turns from gray to blue.
2. Choose settings under RCW (Rear Collision Warning). to complete the setup. The Warning Speed means that when any vehicle is detected within the set warning range, an alarm is activated if the driving speed of the car is greater than the set value.

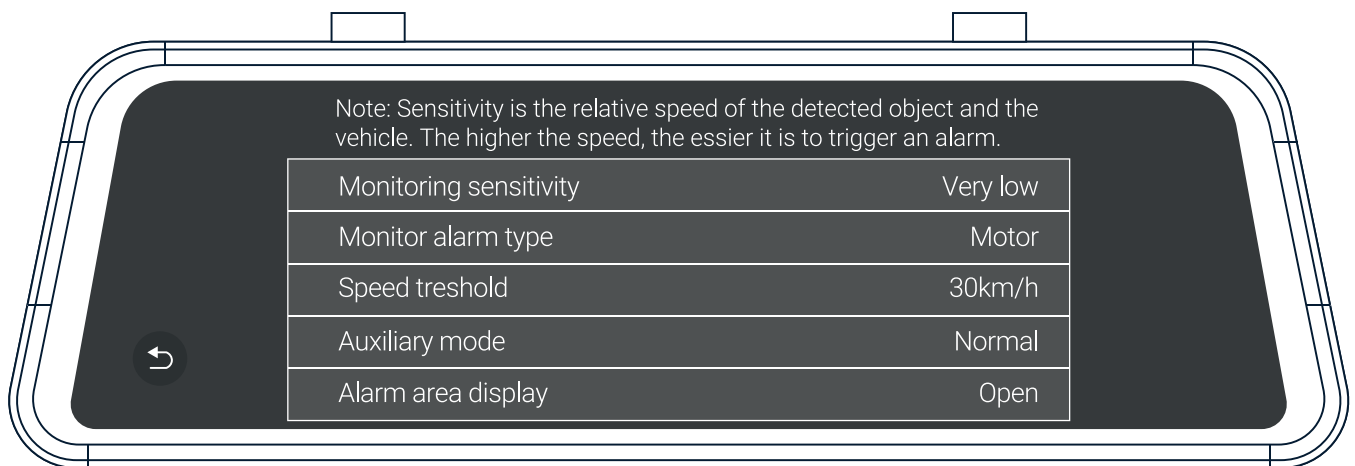

3. Click the option *Monitoring Sensitivity* and select an appropriate option (a default value can be used). Warning Sensitivity means that when any vehicle is detected within the set warning range, an alarm is activated if the driving speed of the following vehicle is greater than that of the car. High: An alarm is activated regardless of car speed. Moderate: An alarm is activated if the following vehicle has a speed 10km/h greater than the car. Low: An alarm is activated if the following vehicle has a speed 20kg/h greater than the car.

4. Click  to access the RCW calibration interface. You will initially see the concept and a brief introduction on the calibration page. Click *Next* to access the real calibration interface, as shown below:

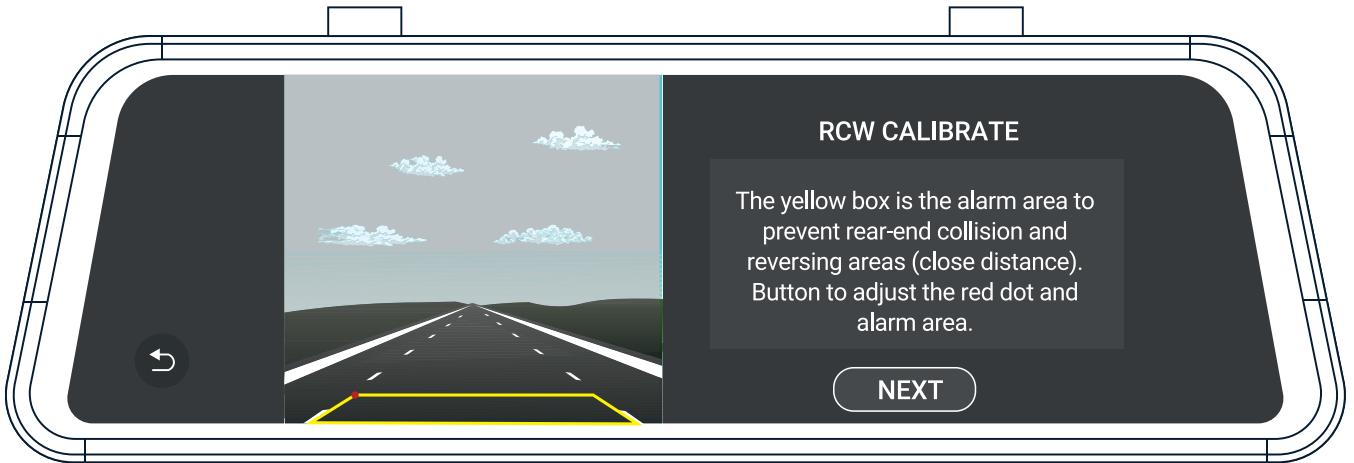



5. Move the red line up or down to the horizon (the intersection line between sky and Earth). Move the yellow line up or down to the interface between the car's tail and ground. Move the green line left or right to the focal point where the far end road intersects with the horizon. After proper adjustment, click *Next* to access calibration of the warning range.

## Note:

The range of calibration of the line adjustment is limited. If extreme adjustment is still unsatisfactory, it will be necessary to adjust the mounting position of the camera or perform fine adjustments of the lens so as to align it in the rearward direction.

### 6. Warning Range Setup:

Click  to switch among the four corners of both the left and right square zones. The corner indicated by the red spot means the zone is currently adjustable. Click  to adjust the warning range. By touching one of the four arrows you may move it up, down, left, or right. Click Save after making the appropriate adjustments. Only in this way can the calibration data be saved.

## V. Playback Mode (File Explorer)

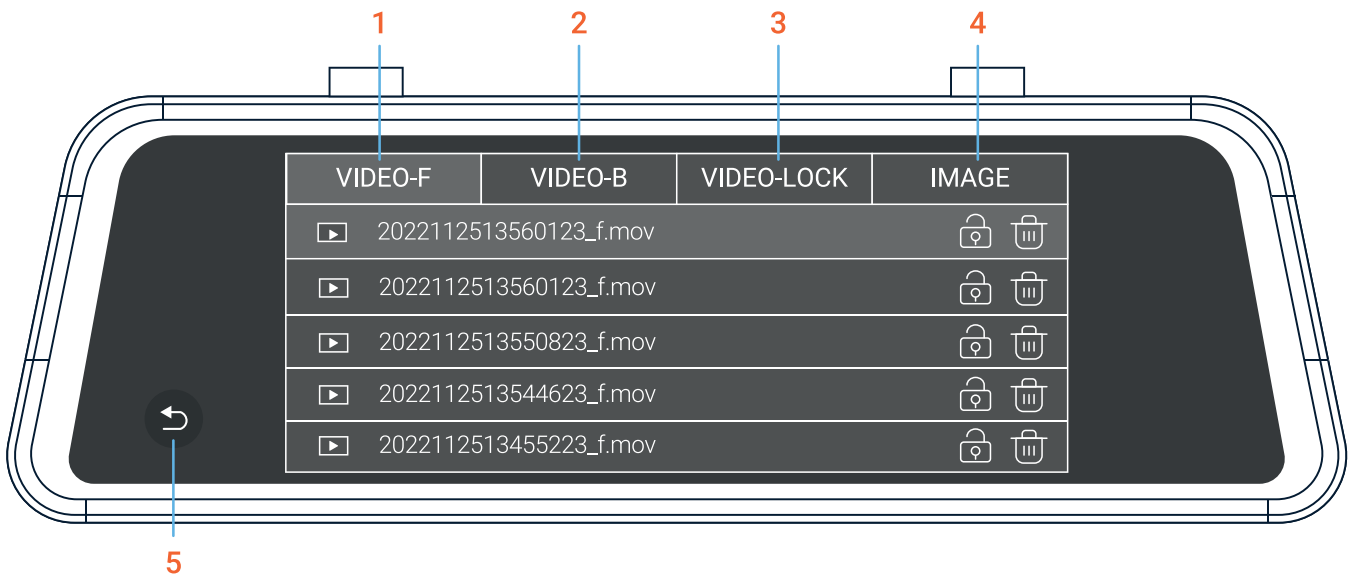

### Key Functions

- 1. Front camera video file
- 2. Rear camera video file
- 3. Locked video file
- 4. Image files
- 5. Return to home

Enter the file list interface and touch the icon to lock a video file. For a locked video file, touch the icon to unlock the file. For unwanted video and picture files, touch the icon to delete the file. To play a video file, touch the file name. During playback, touch the icon to pause it. Touch to scroll up the files and touch the icon to scroll down the files.

For an image file, touch the file name to enter the full screen view. Touch to scroll up the files and touch the icon to scroll down the file. On the file list page touch to delete a file.

### Note:

Locked files will not be overwritten by loop recording. When there are too many locked files or the *Locked files full* message is prompted, please backup the files and delete them from the device.



## VI. Camera Settings

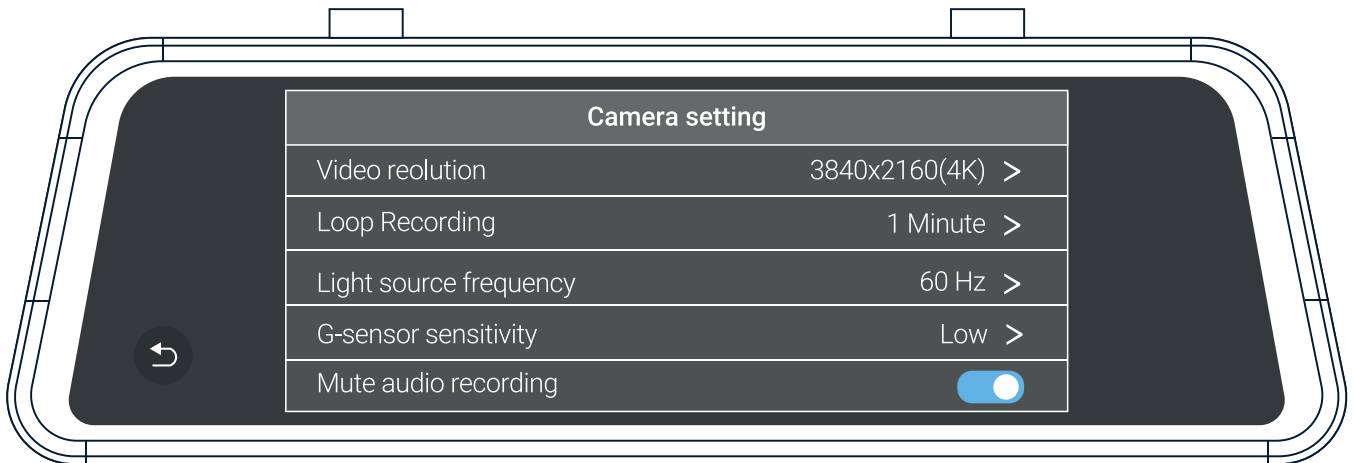

- **Video Resolution:** 4K Front + 1080P Rear
- **Loop Recording:** 1, 2 minutes. Video record is saved in segments. When the storage card is full, the earliest recorded video will be overwritten in order to maintain loop recording status. The time length in menu is the duration of each recording.
- **Frequency:** 50HZ, 60HZ
- **G-sensor Sensitivity:** High, Moderate, Low, Off

### Note:

The gravity sensor can pick up on when the car shakes violently or receives an impact and the system will automatically save the current recording as a protected file. This feature performs the same function as the manually activated emergency lock. If the emergency mode is not activated automatically, touch the  icon during recording and apply the manual lock to protect the current video file.

- **Mute Video Recording (On, Off):**

When mute is *on*, video is recorded with no audio. This function can be directly switched *on* by clicking the  icon on the video recording interface.



- **Rear Camera Mirroring (On, Off):**

This feature displays a reverse image on-screen display for rear camera view. *On* enables mirroring display and *off* displays the original image.

- **Time Stamp:**

*Off, On*

- **Parking Monitor (On, Off):**

This feature is *on* when you see the illuminated  icon in the status bar on the video recording interface, and it is *off* when you see the grayed-out  icon. When the parking monitor is activated, its standby state will be activated after the engine is turned *off*. When the car is shocked by an external force and the sensor detects the impact, the system will begin video recording (Intelligent hardwire kit required).

## The characteristics and precautions of the parking monitor are as follows:

1. With the use of the smart hardwire kit (sold separately). After the car engine is turned *off*, the smart hardwire kit detects the power loss and sends a command to the host device. The system enters a standby state. The mini USB plug must always be kept connected to the USB port of the device so as to ensure a constant power supply to the smart hardwire kit.
2. In parking mode, the dash cam will turn on, record a 15s video, lock the video, and then turn off again. When a recording is started, the screen does not light up and there is no booting sound.

3. When the engine is restarted and the parking monitor has been activated, a prompt will be immediately indicated as shown below:

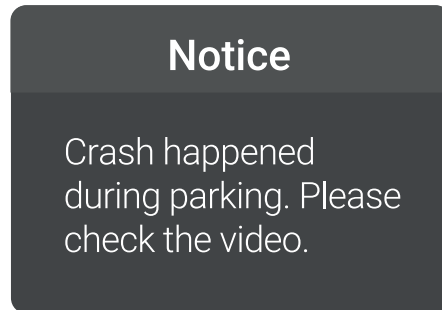

4. Monitoring files are saved in the folders VIDEO\_F\_LOCK and VIDEO\_R\_LOCK.

## VII. System Setup

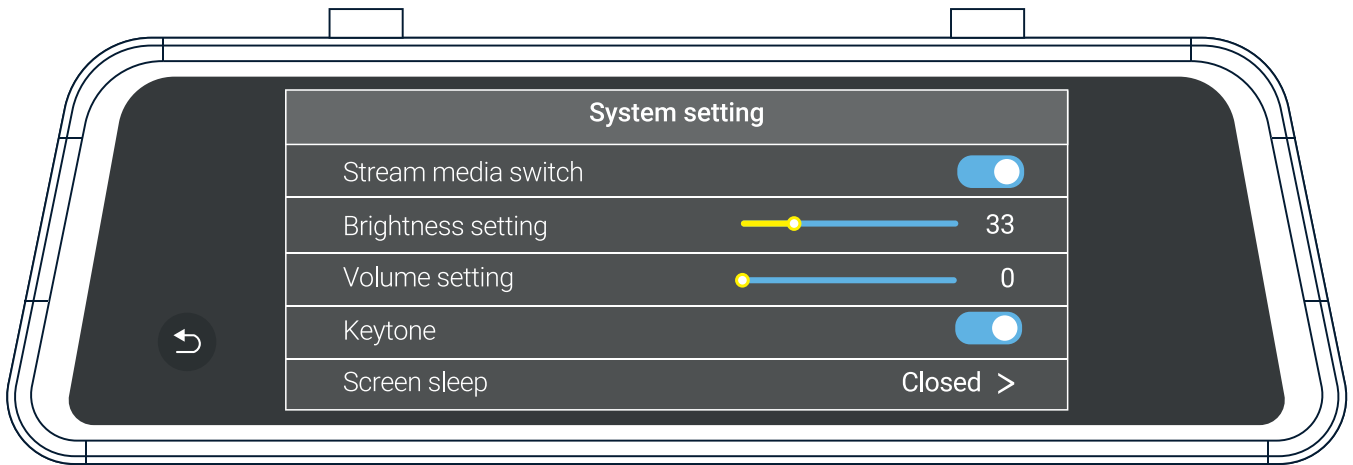

- **Wi-Fi:**  
On, Off.
- **Stream Media:**  
When this feature is switched *on*, the full screen rearview camera image is displayed after starting the device.
- **Brightness Setup:**  
10-100 Sets the brightness of the screen.
- **Volume Setup:**  
0, 1, 2, 3, 4 Sets the audio volume of the system.
- **Screensaver:**  
10S, 30S, 60S, *off* Sets the time to activate the screen's sleep mode. The display remains on without powering-off when sleep mode is deactivated.
- **Speed Unit:**  
*km/h or mph* Sets the speed unit.

- **Key Tone:**  
*Off, On*
- **Daylight Savings Time:**  
*Off, On*
- **Language Setup:**  
English, Chinese, Japanese, and other languages.
- **Time Zone Select:**  
Select your timezone.
- **Time Setup:**  
System time setup.
- **Satellite Information:**  
Check GPS information status and GPS signal condition.
- **System Formatting:**  
*Confirm, Cancel.*

**Note:**

Formatting removes all files (including protected files) from the storage card. Files cannot be restored after formatting. Please, back up important files before formatting.

- **Version:**  
System version
- **Restore Factory Settings (*Confirm, Cancel*)::**  
Select *Confirm* to restore system default values. Settings made by the user will be altered.

# Track Playback

## I. Video Track Playback:

Please download GPS logger player through the link <https://www.rexingusa.com/support/rexing-apps/> OR Scan the QR Code below.



The video track player enables display of traveling track information when playing a video.

### Operating Steps:

1. Connect the MicroSD card to the computer via a card reader.
2. Please follow the steps to download and install the GPS player onto your computer.
3. After installation, click the shortcut  icon to run the player. The following picture shows the player playing a video with front and rear tracks of road.

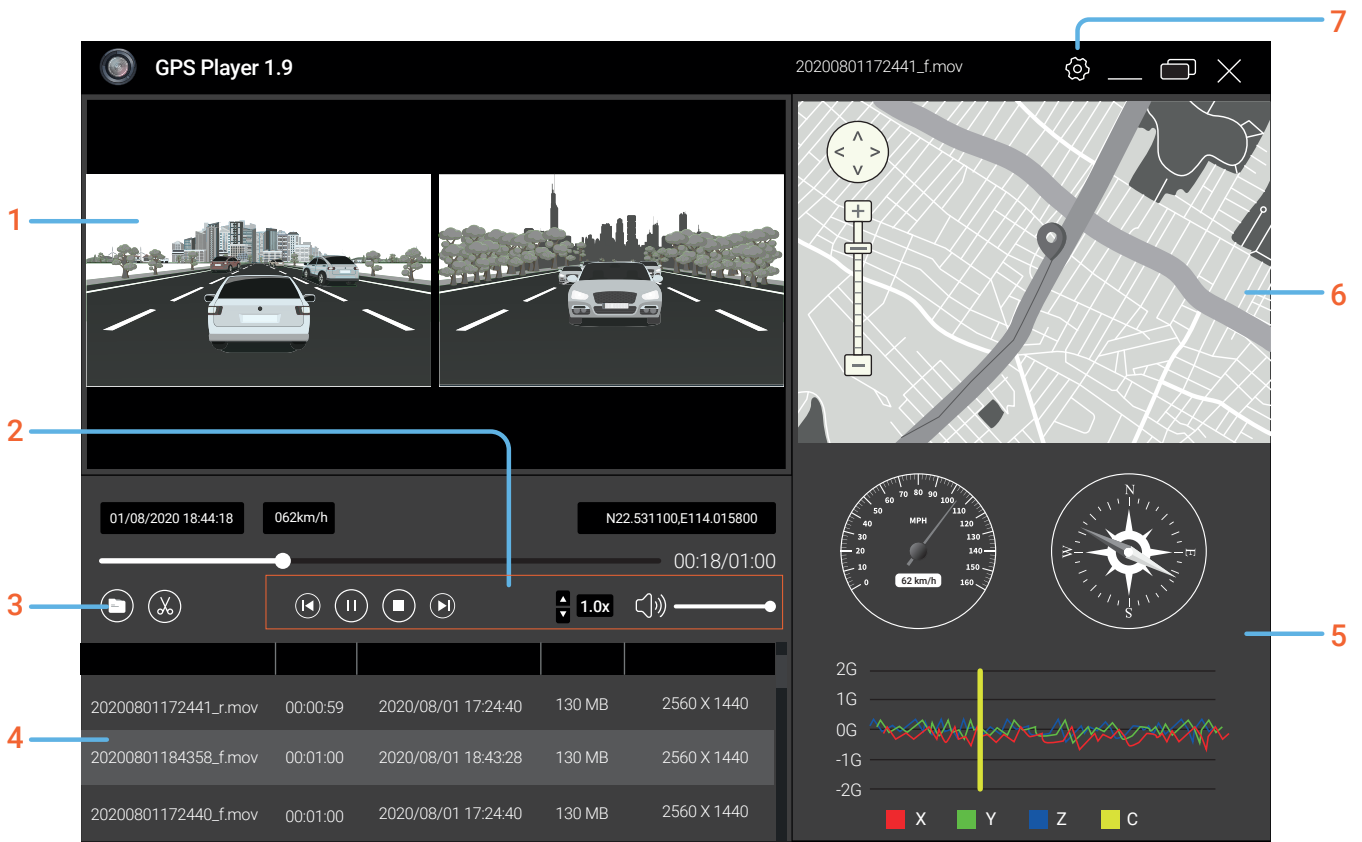

## Primary features of the player are shown below:

### 1. Video Play Window.

If the video files of front and rear road tracks are recorded synchronously and loaded into the playing list at the same time, they can be played separately in split left and right screens.

### 2. Play Control Panel

### 3. Open a Video File

Press the button and select storage path. When you find the desired video file, click on the video and load it into the play list to play it. When you need to select several files, hold down the left mouse button and drag the desired files to the box to load them into the play list.

4. Play List
5. Speed And Driving State Indication
6. Map and Track Display
7. Setup of primary functions such as language, map selection, and speed

## II. GPS Satellite Connection Exception

Even when GPS is successfully connected with the satellite network, your location and environmental factors may directly affect its accuracy. The following factors have a direct impact on satellite signal reception and may cause a failure of the speed detection features and camera reporting.



Surrounded by heavily wooded areas, too many overhead barriers to satellite signals



Underground or in a tunnel



Under an overpass or bridge



Surrounded by high-rise buildings



## Check Recorded Files with a Computer

1. Unplug the used MicroSD card and place it into a card reader
2. Connect the card reader to the USB port of the computer. Open the removable disc and you will see the following file folders
  - **PICTURE:** Pictures saved
  - **VIDEO\_F/VIDEO\_R:** Video records of front and rear road tracks
  - **VIDEO\_F\_LOCK/VIDEO\_R\_LOCK:** locked video records of front and rear road tracks

### Note:

Be careful when deleting any locked video. Important videos, if any, should be backed up.

4. To play videos or browse pictures, your computer must have the necessary software available.
5. Backup Files

If you intend to keep important and memorable videos and pictures for a long time, we suggest that you make a copy of each file from the card to your computer. Do not save them in a new folder created in the same storage card; doing so will reduce the available space of the card.

# Wi-Fi Connect

## Step 1

To enable the Wi-Fi feature, go to system settings, find Wi-Fi, and choose On.

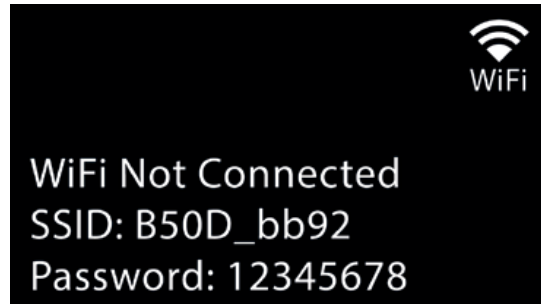

## Step 2

On your mobile device, navigate to your Wi-Fi settings. Connect to your dash cam's Wi-Fi by tapping its name when it appears. Enter your dash cam's Wi-Fi password if you are prompted to do so.

**Note:** On some mobile devices, you may have to try to connect more than once. To ensure you've successfully connected, your mobile device's screen should resemble the examples shown.

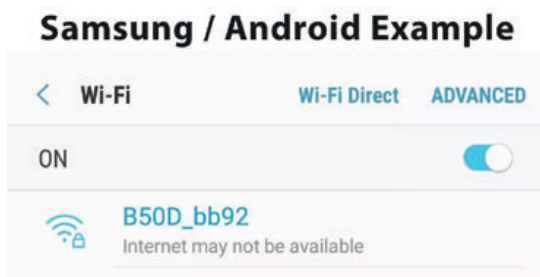

### Step 3

Once you're connected to the dash cam, open the Rexing Connect app on your mobile device.

Please select "Keep Trying Wi-Fi" if you see the notification on the right.

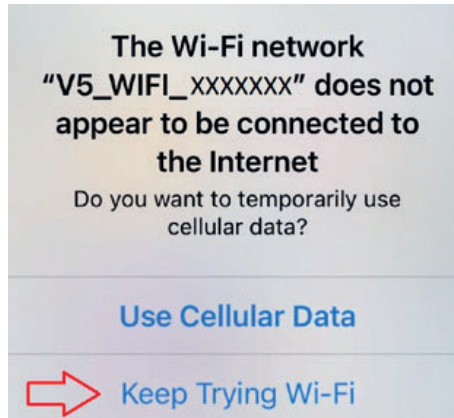

### Step 4

In the app, hit the "Connect" button to connect to your dash cam, allowing you to access live view and view/download your recordings.

### Note:

To disable Wi-Fi, go to system settings, find Wi-Fi, and choose **OFF**.

## Rexing Connect App

Easily download the app by scanning the QR code below or search via the App Store or Google Play.

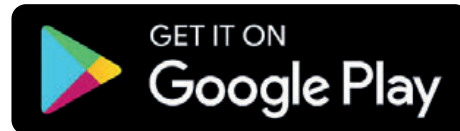

## Wi-Fi Connect Troubleshooting

If you bring up the Rexing connect app and cannot connect your phone to the dash cam please go to

<https://www.rexingusa.com/wifi-connect/>

OR scan the QR code below.



# Product Specifications

## Display                      IPS Touch Screen

---

<b>MicroSD card</b>	Class 10 and above (supports a card capacity up to 256GB)
---------------------	---

---

<b>Speaker</b>	Built-in
----------------	----------

---

<b>MIC</b>	Built-in
------------	----------

---

<b>Video format</b>	MOV
---------------------	-----

---

<b>Picture format</b>	JPG
-----------------------	-----

---

<b>Video resolution</b>	3840 X 2160(4K)
-------------------------	-----------------

---

<b>Available languages</b>	English, Chinese, Japanese, and other languages.
----------------------------	--

---

<b>G-SENSOR</b>	Yes
-----------------	-----

---

<b>Loop recording</b>	1, 2, minutes
-----------------------	---------------

---

<b>Input current</b>	DC5V 2000mA
----------------------	-------------

---

### Note:

Be careful when deleting any locked video. Important videos, if any, should be backed up.

# General Troubleshooting

<b>Trouble</b>	<b>Possible Causes</b>	<b>Solution</b>
<b>Device fails to power on</b>	Defective connection with the charger or burned out fuse	Check the plug to the cigarette lighter or check the charger fuse for continuity
<b>Device fails to record video or take a picture</b>	<ul style="list-style-type: none"><li>• MicroSD card is not inserted or recognized by the device.</li><li>• Card error notice/please format notice</li><li>• Insufficient space notice when taking a picture</li></ul>	<p>Plug in the card. If the card is not recognized, unplug it and plug it in again, or clean up any contamination from the card contacts, or format the card by connecting it to a computer.</p> <p>Format MicroSD storage card</p> <p>Delete some files or unlock to release storage space, or format MicroSD card.</p>
<b>Video does not play smoothly</b>	Slow reading speed of the card reader or insufficient system ROM of the computer	Change card reader or copy the video file to your computer, and then play it again. If this does not solve the problem, try another computer.
<b>All buttons fail to function</b>	Program error or wrong operation	Press Reset Key to restart the device.

# Warranty & Support

## Warranty

The Rexing M2 Max Dash Cam comes with a full 12-month warranty. If you register your product on our official site (<https://www.rexingusa.com/support/registration>), you can extend the warranty to 18 months.

## Support

If you have any questions regarding your product, please do not hesitate to contact us at [care@rexingusa.com](mailto:care@rexingusa.com), or call us at (877) 740-8004. Queries are typically answered within 12-24 hours.

## Your opinion matters

Rexing is firmly committed to always improving our products, services, and user experience. If you have any thoughts on how we can do even better, we welcome your constructive feedback and suggestions.

Connect with us today at [care@rexingusa.com](mailto:care@rexingusa.com)

**Thank you for choosing Rexing!**

## FCC Warning

This device complies with part 15 of the FCC Rules. Operation is subject to the following two conditions: (1) This device may not cause harmful interference, and (2) this device must accept any interference received, including interference that may cause undesired operation.

Changes or modifications not expressly approved by the party responsible for compliance could void the user's authority to operate this equipment.

NOTE: This equipment has been tested and found to comply with the limits for a Class B digital device, pursuant to part 15 of the FCC Rules. These limits are designed to provide reasonable protection against harmful interference in a residential installation. This equipment generates uses and can radiate radio frequency energy and, if not installed and used in accordance with the instructions, may cause harmful interference to radio communications. However, there is no guarantee that interference will not occur in a particular installation. If this equipment does cause harmful interference to radio or television reception, which can be determined by turning the equipment off and on, the user is encouraged to try to correct the interference by one or more of the following measures:

- Reorient or relocate the receiving antenna.
- Increase the separation between the equipment and receiver.
- Connect the equipment into an outlet on a circuit different from that to which the receiver is connected.
- Consult the dealer or an experienced radio/TV technician for help.

### Radiation Exposure Statement

This equipment complies with FCC radiation exposure limits set forth for an uncontrolled environment. This equipment should be installed and operated with minimum distance 20cm between the radiator and your body.

# REXING<sup>®</sup>



MADE IN CHINA