



# RADIO TEST REPORT

Report No.: STS2009191W05

Issued for

Excellus Communications, LLC

27298 Wetland Road, Suite 101 Harrisburg, SD 57032 USA

<b>Product Name:</b>	4G phone
<b>Brand Name:</b>	Snapfon
<b>Model Name:</b>	Snapfon ez4G
<b>Series Model:</b>	N/A
<b>FCC ID:</b>	2AW56-EZ4G
<b>Test Standard:</b>	FCC Part 15.247

Any reproduction of this document must be done in full. No single part of this document may be reproduced without permission from STS, All Test Data Presented in this report is only applicable to presented Test sample.

Shenzhen STS Test Services Co., Ltd.  
A 1/F, Building B, Zhuoke Science Park, No.190 Chongqing Road, HepingShequ,  
Fuyong Sub-District, Bao'an District, Shenzhen, Guang Dong, China  
TEL: +86-755 3688 6288 FAX: +86-755 3688 6277 E-mail: sts@ststest.com





### TEST RESULT CERTIFICATION

**Applicant's Name** ..... : Excellus Communications, LLC  
 Address ..... : 27298 Wetland Road, Suite 101 Harrisburg, SD 57032 USA  
**Manufacturer's Name** ..... : Ying Tai Electronics Co., Ltd  
 Address ..... : ROOM 803, CHEVALIER HOUSE 45-51 CHATHAM ROAD SOUTH,  
 TSIM SHA TSUI, KOWLOON, HONG KONG  
**Product Description**  
 Product Name ..... : 4G phone  
 Brand Name ..... : Snapfon  
 Model Name ..... : Snapfon ez4G  
 SeriesModel ..... : N/A  
**Test Standards** ..... : FCC Part15.247  
 Test Procedure ..... : ANSI C63.10-2013

This device described above has been tested by STS, the test results show that the equipment under test (EUT) is in compliance with the FCC requirements. And it is applicable only to the tested sample identified in the report.

This report shall not be reproduced except in full, without the written approval of STS, this document only be altered or revised by STS, personal only, and shall be noted in the revision of the document.

**Date of Test** ..... :  
 Date of receipt of test item ..... : 07 Sept. 2020  
 Date (s) of performance of tests ..... : 07 Sept. 2020 ~ 26 Oct. 2020  
 Date of Issue ..... : 26 Oct. 2020  
 Test Result ..... : **Pass**



Testing Engineer :   
 \_\_\_\_\_  
 (Chris Chen)  
 Technical Manager :   
 \_\_\_\_\_  
 (Sean she)  
 Authorized Signatory :   
 \_\_\_\_\_  
 (Vita Li)

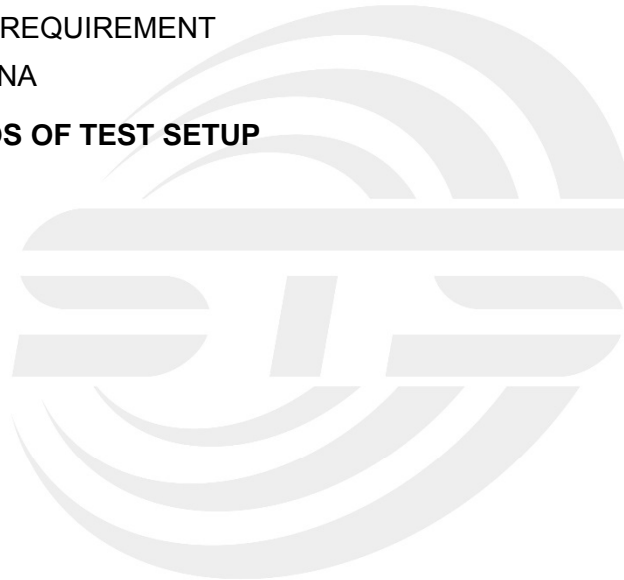



Table of Contents	Page
<b>1. SUMMARY OF TEST RESULTS</b>	<b>6</b>
1.1 TEST FACTORY	7
1.2 MEASUREMENT UNCERTAINTY	7
<b>2. GENERAL INFORMATION</b>	<b>8</b>
2.1 GENERAL DESCRIPTION OF THE EUT	8
2.2 DESCRIPTION OF THE TEST MODES	10
2.3 TEST SOFTWARE AND POWER LEVEL	10
2.4 BLOCK DIGRAM SHOWING THE CONFIGURATION OF SYSTEM TESTED	11
2.5 DESCRIPTION OF NECESSARY ACCESSORIES AND SUPPORT UNITS	12
2.6 EQUIPMENTS LIST FOR ALL TEST ITEMS	13
<b>3. EMC EMISSION TEST</b>	<b>15</b>
3.1 CONDUCTED EMISSION MEASUREMENT	15
3.2 RADIATED EMISSION MEASUREMENT	19
<b>4.CONDUCTED SPURIOUS &amp; BAND EDGE EMISSION</b>	<b>31</b>
4.1 LIMIT	31
4.2 TEST PROCEDURE	31
4.3 DEVIATION FROM STANDARD	31
4.4 TEST SETUP	31
4.5 EUT OPERATION CONDITIONS	31
4.6 TEST RESULTS	32
<b>5. POWER SPECTRAL DENSITY TEST</b>	<b>48</b>
5.1 LIMIT	48
5.2 TEST PROCEDURE	48
5.3 DEVIATION FROM STANDARD	48
5.4 TEST SETUP	48
5.5 EUT OPERATION CONDITIONS	48
5.6 TEST RESULTS	49
<b>6. BANDWIDTH TEST</b>	<b>57</b>
6.1 LIMIT	57
6.2 TEST PROCEDURE	57
6.3 DEVIATION FROM STANDARD	57
6.4 TEST SETUP	57
6.5 EUT OPERATION CONDITIONS	57



Table of Contents	Page
6.6 TEST RESULTS	58
<b>7. PEAK OUTPUT POWER TEST</b>	<b>66</b>
7.1 LIMIT	66
7.2 TEST PROCEDURE	66
7.3 DEVIATION FROM STANDARD	66
7.4 TEST SETUP	66
7.5 EUT OPERATION CONDITIONS	66
7.6 TEST RESULTS	67
<b>8. ANTENNA REQUIREMENT</b>	<b>68</b>
8.1 STANDARD REQUIREMENT	68
8.2 EUT ANTENNA	68
<b>APPENDIX-PHOTOS OF TEST SETUP</b>	<b>69</b>





**Revision History**

Rev.	Issue Date	Report No.	Effect Page	Contents
00	26 Oct. 2020	STS2009191W05	ALL	Initial Issue





## 1. SUMMARY OF TEST RESULTS

Test procedures according to the technical standards:  
KDB 558074 D01 15.247 Meas Guidance v05r02.

FCC Part 15.247, Subpart C			
Standard Section	Test Item	Judgment	Remark
15.207	Conducted Emission	PASS	--
15.247 (a)(2)	6dB Bandwidth	PASS	--
15.247 (b)(3)	Output Power	PASS	--
15.209	Radiated Spurious Emission	PASS	--
15.247 (d)	Conducted Spurious & Band Edge Emission	PASS	--
15.247 (e)	Power Spectral Density	PASS	--
15.205	Restricted Band Edge Emission	PASS	--
Part 15.247(d)/part 15.209(a)	Band Edge Emission	PASS	--
15.203	Antenna Requirement	PASS	--

### NOTE:

- (1) 'N/A' denotes test is not applicable in this Test Report.
- (2) All tests are according to ANSI C63.10-2013.



## 1.1 TEST FACTORY

SHENZHEN STS TEST SERVICES CO., LTD

Add. : A 1/F, Building B, Zhuoke Science Park, No.190 Chongqing Road, HepingShequ, Fuyong Sub-District, Bao'an District, Shenzhen, Guang Dong, China

FCC test Firm Registration Number: 625569

IC test Firm Registration Number: 12108A

A2LA Certificate No.: 4338.01

## 1.2 MEASUREMENT UNCERTAINTY

The reported uncertainty of measurement  $y \pm U$ , where expanded uncertainty  $U$  is based on a standard uncertainty multiplied by a coverage factor of  $k=2$ , providing a level of confidence of approximately 95 %.

No.	Item	Uncertainty
1	RF output power, conducted	$\pm 0.68\text{dB}$
2	Unwanted Emissions, conducted	$\pm 2.988\text{dB}$
3	All emissions, radiated 30-1GHz	$\pm 5.6\text{dB}$
4	All emissions, radiated 1G-6GHz	$\pm 5.5\text{dB}$
5	All emissions, radiated >6G	$\pm 5.8\text{dB}$
6	Conducted Emission (9KHz-150KHz)	$\pm 3.37\text{dB}$
7	Conducted Emission (150KHz-30MHz)	$\pm 3.83\text{dB}$



## 2. GENERAL INFORMATION

### 2.1 GENERAL DESCRIPTION OF THE EUT

Product Name	4G phone	
Trade Name	Snapfon	
Model Name	Snapfon ez4G	
Series Model	N/A	
Model Difference	N/A	
Product Description	The EUT is a 4G phone	
	Operation Frequency:	802.11b/g/n 20: 2412~2462 MHz 802.11n(40MHz):2422~2452MHz
	Modulation Type:	802.11b(DSSS):CCK,DQPSK,DBPSK 802.11g(OFDM):BPSK,QPSK,16-QAM,64-QAM 802.11n(OFDM):BPSK,QPSK,16-QAM,64-QAM
	Bit Rate of Transmitter:	802.11b:11/5.5/2/1 Mbps 802.11g:54/48/36/24/18/12/9/6Mbps 802.11n(20MHz): 65/58.5/52/39/26/19.5/13/6.5Mbps 802.11n(40MHz): 135/121.5/108/81/54/40.5/37/13.5Mbps
	Number of Channel:	802.11b/g/n20: 11CH 802.11n 40: 7CH
	Antenna Designation:	Please refer to the Note 3.
	AntennaGain (dBi):	0.5 dBi
	Duty Cycle:	>98%
	Channel List	Please refer to the Note 2.
Adapter	Input: AC 100-240V 50/60Hz 0.2A Output: DC 5V 1A	
Battery	Rated Voltage: 3.7V Charge Limit: 4.2V Capacity: 1500mAh	
Hardware version number	G1-MB-V1.1	
Software version number	Snapfon_ez4G_v2.0_20200821_1249	
Connecting I/O Port(s)	Please refer to the Note 1.	

#### Note:

1. For a more detailed features description, please refer to the manufacturer's specifications or the User Manual.





2.

Operation Frequency of channel			
802.11b/g/n(20MHz)		Channel List for 802.11n(40MHz)	
Channel	Frequency	Channel	Frequency
01	2412	03	2422
02	2417	04	2427
03	2422	05	2432
04	2427	06	2437
05	2432	07	2442
06	2437	08	2447
07	2442	09	2452
08	2447		
09	2452		
10	2457		
11	2462		

**Note:**

In section 15.31(m), regards to the operating frequency range over 10 MHz, the Lowest frequency, the middle frequency, and the highest frequency of channel were selected to perform the test, and the selected channel see below:

Carrier Frequency Channel

**2.4GHz Test Frequency:**

For 802.11b/g/n (HT20)		For 802.11n (HT40)	
Channel	Freq.(MHz)	Channel	Freq.(MHz)
01	2412	03	2422
06	2437	06	2437
11	2462	09	2452

3.

Ant.	Brand	Model Name	Antenna Type	Connector	Gain (dBi)	NOTE
1	Snapfon	Snapfon ez4G	PIFA	N/A	0.5 dBi	WLAN Antenna



## 2.2 DESCRIPTION OF THE TEST MODES

Each of these EUT operation mode(s) or test configuration mode(s) mentioned above was evaluated respectively.

Worst Mode	Description	Data Rate
Mode 1	TX IEEE 802.11b CH1	1 Mbps
Mode 2	TX IEEE 802.11b CH6	1 Mbps
Mode 3	TX IEEE 802.11 b CH11	1 Mbps
Mode 4	TX IEEE 802.11g CH1	6 Mbps
Mode 5	TX IEEE 802.11g CH6	6 Mbps
Mode 6	TX IEEE 802.11g CH11	6 Mbps
Mode 7	TX IEEE 802.11n HT20 CH1	MCS 0
Mode 8	TX IEEE 802.11n HT20 CH6	MCS 0
Mode 9	TX IEEE 802.11n HT20 CH11	MCS 0
Mode 10	TX IEEE 802.11n HT40 CH3	MCS 0
Mode 11	TX IEEE 802.11n HT40 CH6	MCS 0
Mode 12	TX IEEE 802.11n HT40 CH9	MCS 0

Note:

- (1) The measurements are performed at all Bit Rate of Transmitter, the worst data was reported.
- (2) We have be tested for all available U.S. voltage and frequencies(For 120V,50/60Hz and 240V, 50/60Hz) for which the device is capable of operation, and the worst case of 120V /60Hz is shown in the report.
- (3) The battery is full-charged during the radited and RF conducted test.

### AC Conducted Emission

Test Case	
AC Conducted Emission	Mode13: Keeping WIFI TX

## 2.3 TEST SOFTWARE AND POWER LEVEL

During testing channel & power controlling software provided by the customer was used to control the operating channel as well as the output power level.

RF Function	Type	Mode Or Modulation type	Ant Gain(dBi)	Power Class	Software For Testing
WIFI(2.4G)	2.4G WIFI	802.11b	0.5	19	Engineering mode
		802.11g		15	
		802.11n(HT20)		15	
		802.11n(HT40)		16.5	

## 2.4 BLOCK DIGRAM SHOWING THE CONFIGURATION OF SYSTEM TESTED

### Radiation Test Set

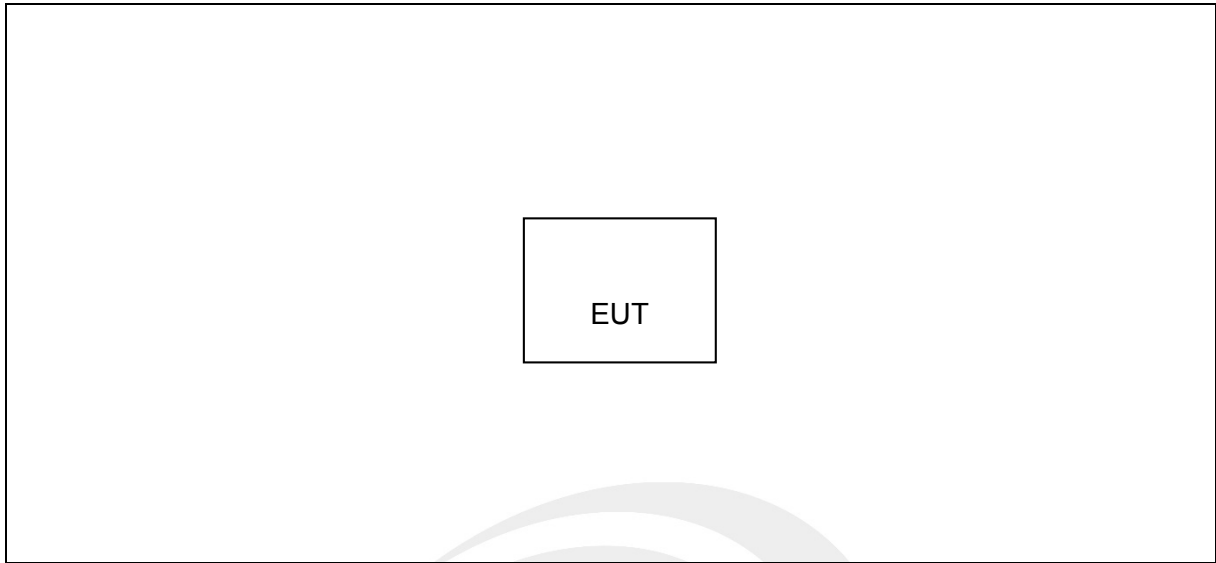

### conduction Test Set

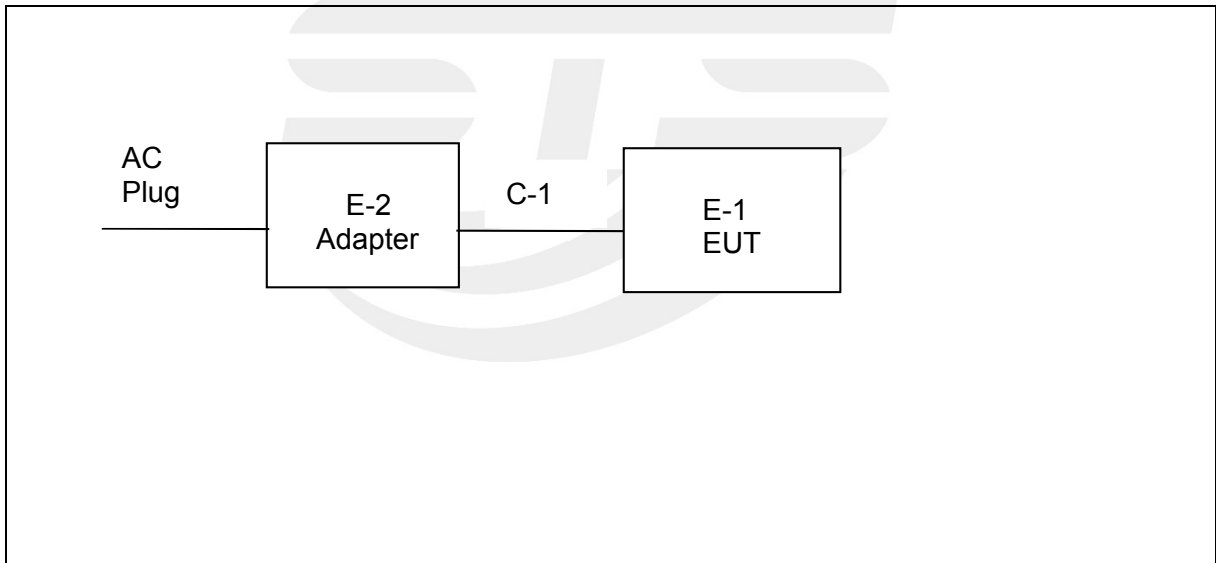



## 2.5 DESCRIPTION OF NECESSARY ACCESSORIES AND SUPPORT UNITS

The EUT has been tested as an independent unit together with other necessary accessories or support units. The following support units or accessories were used to form a representative test configuration during the tests.

### Necessary accessories

Item	Equipment	Mfr/Brand	Model/Type No.	Length	Note
E-2	Adapter	N/A	HJ-0501000E1-US	N/A	N/A
C-1	DC Cable	N/A	N/A	100cm	N/A

### Support units

Item	Equipment	Mfr/Brand	Model/Type No.	Length	Note
N/A	N/A	N/A	N/A	N/A	N/A

#### Note:

- (1) For detachable type I/O cable should be specified the length in cm in 『Length』 column.



## 2.6 EQUIPMENTS LIST FOR ALL TEST ITEMS

## Radiation Test equipment

Kind of Equipment	Manufacturer	Type No.	Serial No.	Last calibration	Calibrated until
Test Receiver	R&S	ESCI	101427	2020.10.12	2021.10.11
Signal Analyzer	R&S	FSV 40-N	101823	2020.10.10	2021.10.09
Active loop Antenna	ZHINAN	ZN30900C	16035	2019.07.11	2021.07.10
Bilog Antenna	TESEQ	CBL6111D	34678	2020.10.12	2022.10.11
Horn Antenna	SCHWARZBECK	BBHA 9120D	02014	2019.10.15	2021.10.14
SHF-EHF Horn Antenna (18G-40GHz)	A-INFO	LB-180400-KF	J211020657	2020.10.12	2022.10.11
Pre-Amplifier (0.1M-3GHz)	EM	EM330	060665	2020.10.12	2021.10.11
Pre-Amplifier (1G-18GHz)	SKET	LNPA-01018G-45	SK2018080901	2020.10.12	2021.10.11
Pre-Amplifier (18G-40GHz)	SKET	LNPA-1840-50	SK2018101801	2020.10.10	2021.10.09
Temperature & Humidity	HH660	Mieo	N/A	2020.10.13	2021.10.12
Turn table	EM	SC100_1	60531	N/A	N/A
Antenna mast	EM	SC100	N/A	N/A	N/A
Test SW	FARAD	EZ-EMC(Ver.STSLAB-03A1 RE)			

## Conduction Test equipment

Kind of Equipment	Manufacturer	Type No.	Serial No.	Last calibration	Calibrated until
Test Receiver	R&S	ESCI	101427	2020.10.12	2021.10.11
LISN	R&S	ENV216	101242	2020.10.12	2021.10.11
LISN	EMCO	3810/2NM	23625	2020.10.12	2021.10.11
Temperature & Humidity	HH660	Mieo	N/A	2020.10.13	2021.10.12
Test SW	FARAD	EZ-EMC(Ver.STSLAB-03A1 RE)			



## RF Connected Test

Kind of Equipment	Manufacturer	Type No.	Serial No.	Last calibration	Calibrated until
MIMO Power measurement test Set	Keysight	U2021XA	MY55520005	2020.10.10	2021.10.09
			MY55520006	2020.10.10	2021.10.09
			MY56120038	2020.10.10	2021.10.09
			MY56280002	2020.10.10	2021.10.09
Signal Analyzer	Agilent	N9020A	MY51110105	2020.03.05	2021.03.04
Temperature & Humidity	HH660	Mieo	N/A	2020.10.13	2021.10.12
MIMO Power measurement test Set	Keysight	U2021XA	MY55520005	2020.10.10	2021.10.09
Test SW	FARAD	EZ-EMC(Ver.STSLAB-03A1 RE)			





### 3. EMC EMISSION TEST

#### 3.1 CONDUCTED EMISSION MEASUREMENT

##### 3.1.1 POWER LINE CONDUCTED EMISSION LIMITS

The radio frequency voltage that is conducted back onto the AC power line on any frequency or frequencies, within the band 150 kHz to 30 MHz, shall not exceed the limits in the following table.

FREQUENCY (MHz)	Conducted Emissionlimit (dBuV)	
	Quasi-peak	Average
0.15 -0.5	66 - 56 *	56 - 46 *
0.50 -5.0	56.00	46.00
5.0 -30.0	60.00	50.00

Note:

- (1) The tighter limit applies at the band edges.
- (2) The limit of “ \* ” marked band means the limitation decreases linearly with the logarithm of the frequency in the range.

The following table is the setting of the receiver

Receiver Parameters	Setting
Attenuation	10 dB
Start Frequency	0.15 MHz
Stop Frequency	30 MHz
IF Bandwidth	9 kHz

### 3.1.2 TEST PROCEDURE

- The EUT is 0.8 m from the horizontal ground plane and 0.4 m from the vertical ground plane with EUT being connected to the power mains through a line impedance stabilization network (LISN). All other support equipments are powered from additional LISN(s). The LISN provides 50 Ohm/ 50uH of coupling impedance for the measuring instrument.
- Interconnecting cables that hang closer than 40 cm to the ground plane shall be folded back and forth in the center forming a bundle 30 to 40 cm long.
- I/O cables that are not connected to a peripheral shall be bundled in the center. The end of the cable may be terminated, if required, using the correct terminating impedance. The overall length shall not exceed 1 m.
- LISN is at least 80 cm from the nearest part of EUT chassis.
- For the actual test configuration, please refer to the related Item –EUT Test Photos.

### 3.1.3 TEST SETUP

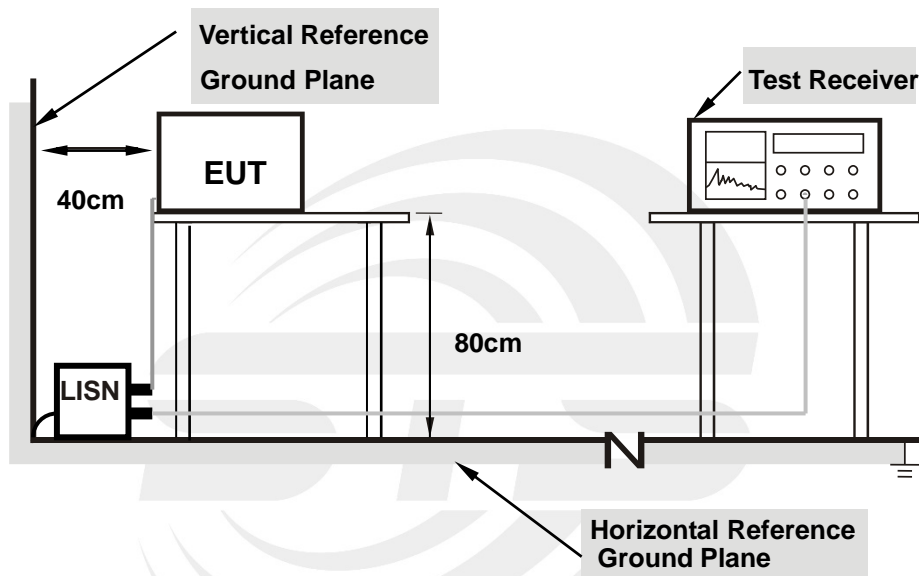

**Note: 1.Support units were connected to second LISN.**

**2.Both of LISNs (AMN) are 80 cm from EUT and at least 80 cm from other units and other metal planes support.**

### 3.1.4EUT OPERATING CONDITIONS

The EUT was configured for testing in a typical fashion (as a customer would normally use it). The EUT has been programmed to continuously transmit during test. This operating condition was tested and used to collect the included data.





3.1.5 TEST RESULT

Temperature:	27.0(C)	Relative Humidity:	67%RH
Test Voltage:	AC 120V/60Hz	Phase:	L
Test Mode:	Mode 13		

No.	Frequency (MHz)	Reading (dBuV)	Correct Factor(dB)	Result (dBuV)	Limit (dBuV)	Margin (dB)	Remark
1	0.1540	25.60	20.20	45.80	65.78	-19.98	QP
2	0.1540	9.12	20.20	29.32	55.78	-26.46	AVG
3	0.4380	23.01	20.49	43.50	57.10	-13.60	QP
4	0.4380	11.34	20.49	31.83	47.10	-15.27	AVG
5	0.8300	20.17	20.23	40.40	56.00	-15.60	QP
6	0.8300	4.62	20.23	24.85	46.00	-21.15	AVG
7	3.4700	21.91	20.07	41.98	56.00	-14.02	QP
8	3.4700	5.85	20.07	25.92	46.00	-20.08	AVG
9	7.6380	21.71	19.89	41.60	60.00	-18.40	QP
10	7.6380	6.69	19.89	26.58	50.00	-23.42	AVG
11	16.7860	22.63	20.27	42.90	60.00	-17.10	QP
12	16.7860	14.20	20.27	34.47	50.00	-15.53	AVG

Remark:

1. All readings are Quasi-Peak and Average values
2. Margin = Result (Result =Reading + Factor )–Limit
3. Factor=LISN factor+Cable loss+Limiter (10dB)

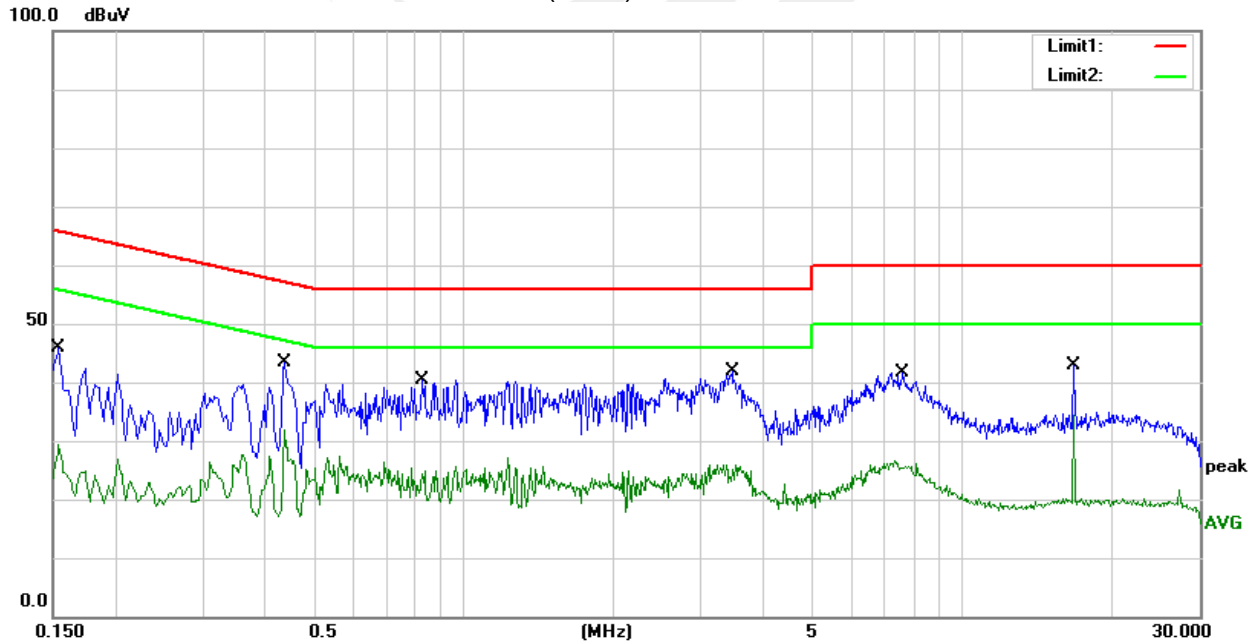



Temperature:	27.3(C)	Relative Humidity:	65%RH
Test Voltage:	AC 120V/60Hz	Phase:	N
Test Mode:	Mode 13		

No.	Frequency (MHz)	Reading (dBuV)	Correct Factor(dB)	Result (dBuV)	Limit (dBuV)	Margin (dB)	Remark
1	0.1580	22.41	20.21	42.62	65.57	-22.95	QP
2	0.1580	7.48	20.21	27.69	55.57	-27.88	AVG
3	0.3620	21.08	20.61	41.69	58.68	-16.99	QP
4	0.3620	5.24	20.61	25.85	48.68	-22.83	AVG
5	0.6900	20.88	20.29	41.17	56.00	-14.83	QP
6	0.6900	3.83	20.29	24.12	46.00	-21.88	AVG
7	2.0900	20.84	20.14	40.98	56.00	-15.02	QP
8	2.0900	3.59	20.14	23.73	46.00	-22.27	AVG
9	7.9540	21.54	19.88	41.42	60.00	-18.58	QP
10	7.9540	7.16	19.88	27.04	50.00	-22.96	AVG
11	22.0940	16.75	20.65	37.40	60.00	-22.60	QP
12	22.0940	5.94	20.65	26.59	50.00	-23.41	AVG

Remark:

1. All readings are Quasi-Peak and Average values
2. Margin = Result (Result = Reading + Factor) – Limit
3. Factor=LISN factor+Cable loss+Limiter (10dB)

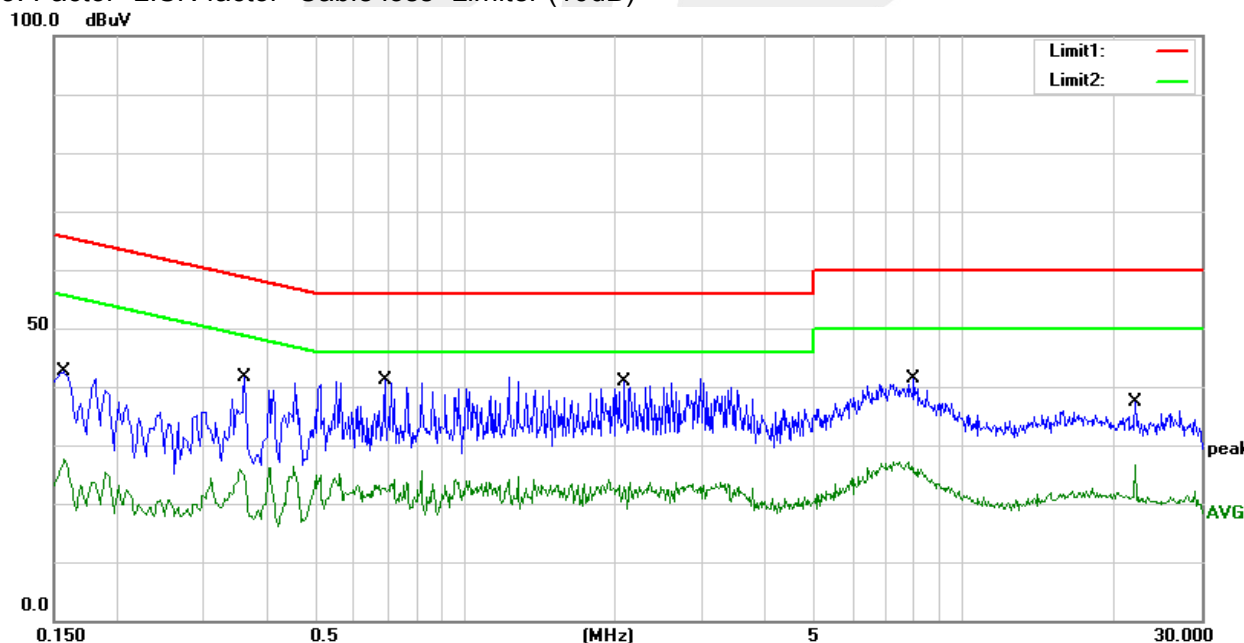



### 3.2 RADIATED EMISSION MEASUREMENT

#### 3.2.1 RADIATED EMISSION LIMITS

In any 100 kHz bandwidth outside the operating frequency band. In case the emission fall within the Restricted band specified on Part15.205(a)&209(a) limit in the table and according to ANSI C63.10-2013 below has to be followed.

LIMITS OF RADIATED EMISSION MEASUREMENT (0.009MHz - 1000MHz)

Frequencies (MHz)	Field Strength (micovolts/meter)	Measurement Distance (meters)
0.009~0.490	2400/F(KHz)	300
0.490~1.705	24000/F(KHz)	30
1.705~30.0	30	30
30~88	100	3
88~216	150	3
216~960	200	3
Above 960	500	3

LIMITS OF RADIATED EMISSION MEASUREMENT (1000MHz-25GHz)

FREQUENCY (MHz)	(dBuV/m) (at 3M)	
	PEAK	AVERAGE
Above 1000	74	54

Notes:

- (1) The limit for radiated test was performed according to FCC PART 15C.
- (2) The tighter limit applies at the band edges.
- (3) Emission level (dBuV/m)=20log Emission level (uV/m).

#### LIMITS OF RESTRICTED FREQUENCY BANDS

FREQUENCY (MHz)	FREQUENCY (MHz)	FREQUENCY (MHz)	FREQUENCY (GHz)
0.090-0.110	16.42-16.423	399.9-410	4.5-5.15
0.495-0.505	16.69475-16.69525	608-614	5.35-5.46
2.1735-2.1905	16.80425-16.80475	960-1240	7.25-7.75
4.125-4.128	25.5-25.67	1300-1427	8.025-8.5
4.17725-4.17775	37.5-38.25	1435-1626.5	9.0-9.2
4.20725-4.20775	73-74.6	1645.5-1646.5	9.3-9.5
6.215-6.218	74.8-75.2	1660-1710	10.6-12.7
6.26775-6.26825	108-121.94	1718.8-1722.2	13.25-13.4
6.31175-6.31225	123-138	2200-2300	14.47-14.5
8.291-8.294	149.9-150.05	2310-2390	15.35-16.2
8.362-8.366	156.52475-156.52525	2483.5-2500	17.7-21.4
8.37625-8.38675	156.7-156.9	2690-2900	22.01-23.12
8.41425-8.41475	162.0125-167.17	3260-3267	23.6-24.0
12.29-12.293	167.72-173.2	3332-3339	31.2-31.8
12.51975-12.52025	240-285	3345.8-3358	36.43-36.5
12.57675-12.57725	322-335.4	3600-4400	Above 38.6
13.36-13.41			



## For Radiated Emission

Spectrum Parameter	Setting
Attenuation	Auto
Detector	Peak/QP/AV
Start Frequency	9 KHz/150KHz(Peak/QP/AV)
Stop Frequency	150KHz/30MHz(Peak/QP/AV)
RB / VB (emission in restricted band)	200Hz (From 9kHz to 0.15MHz)/ 9KHz (From 0.15MHz to 30MHz); 200Hz (From 9kHz to 0.15MHz)/ 9KHz (From 0.15MHz to 30MHz)

Spectrum Parameter	Setting
Attenuation	Auto
Detector	Peak/QP
Start Frequency	30 MHz(Peak/QP)
Stop Frequency	1000 MHz (Peak/QP)
RB / VB (emission in restricted band)	120 KHz / 300 KHz

Spectrum Parameter	Setting
Attenuation	Auto
Detector	Peak/AV
Start Frequency	1000 MHz(Peak/AV)
Stop Frequency	10th carrier hamonic(Peak/AV)
RB / VB (emission in restricted band)	1 MHz / 3 MHz(Peak) 1 MHz/1/T MHz(AVG)

## For Restricted band

Spectrum Parameter	Setting
Detector	Peak/AV
Start/Stop Frequency	Lower Band Edge: 2310 to 2450 MHz Upper Band Edge: 2440 to 2500 MHz
RB / VB	1 MHz / 3 MHz(Peak) 1 MHz/1/T MHz(AVG)



Receiver Parameter	Setting
Start ~ Stop Frequency	9kHz~90kHz / RB 200Hz for PK & AV
Start ~ Stop Frequency	90kHz~110kHz / RB 200Hz for QP
Start ~ Stop Frequency	110kHz~490kHz / RB 200Hz for PK & AV
Start ~ Stop Frequency	490kHz~30MHz / RB 9kHz for QP
Start ~ Stop Frequency	30MHz~1000MHz / RB 120kHz for QP

### 3.2.2 TEST PROCEDURE

- a. The measuring distance of at 3 m shall be used for measurements at frequency 0.009MHz up to 1GHz, and above 1GHz.
- b. The EUT was placed on the top of a rotating table 0.8 meters(above 1GHz is 1.5 m) above the ground at a 3 meter anechoic chamber. The table was rotated 360 degrees to determine the position of the highest radiation.
- c. The height of the equipment shall be 0.8 m(above 1GHz is 1.5 m); the height of the test antenna shall vary between 1 m to 4 m. Horizontal and vertical polarizations of the antenna are set to make the measurement.
- d. The initial step in collecting conducted emission data is a spectrum analyzer peak detector mode pre-scanning the measurement frequency range. Significant peaks are then marked and then Quasi Peak detector mode re-measured.
- e. If the Peak Mode measured value compliance with and lower than Quasi Peak Mode Limit, the EUT shall be deemed to meet QP Limits and then no additional QP Mode measurement performed.
- f. For the actual test configuration, please refer to the related Item –EUT Test Photos.

Note:

Both horizontal and vertical antenna polarities were tested and performed test to three orthogonal axis. The worst case emissions were reported.

### 3.2.3 TEST SETUP

#### (A) Radiated Emission Test-Up Frequency Below 30MHz

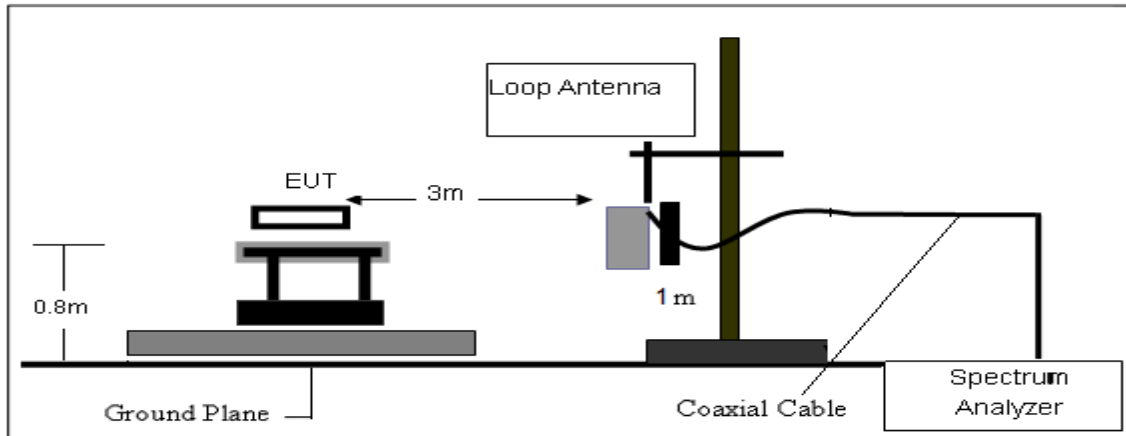

#### (B) Radiated Emission Test-Up Frequency 30MHz~1GHz

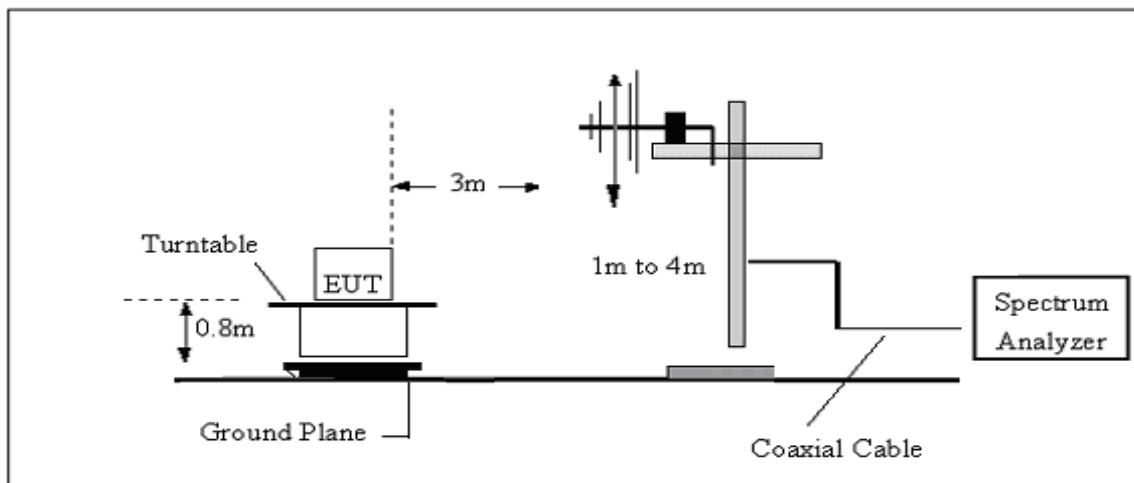

#### (C) Radiated Emission Test-Up Frequency Above 1GHz

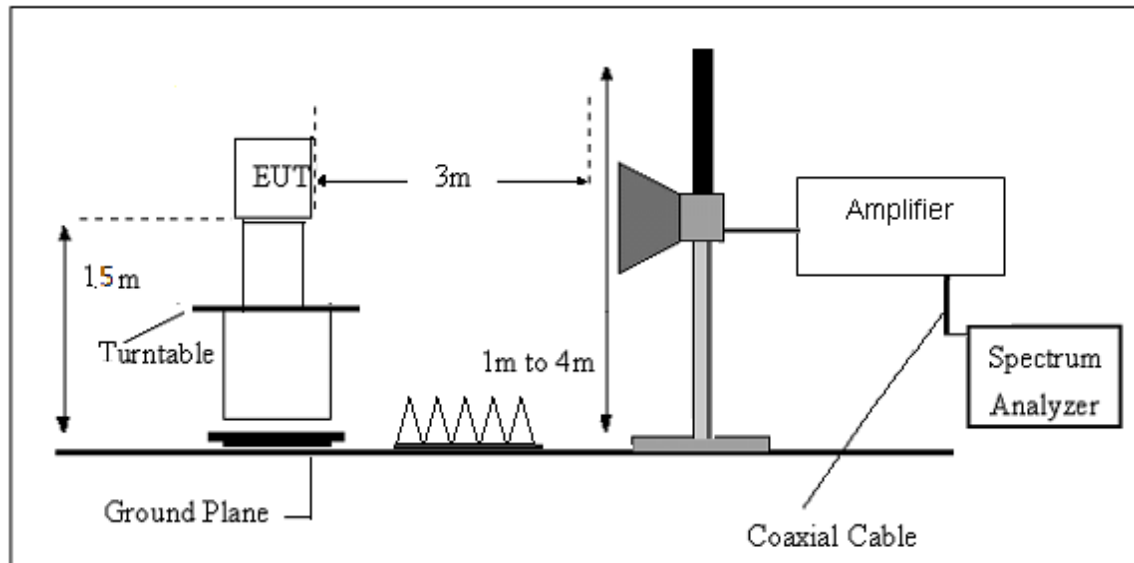

### 3.2.4 EUT OPERATING CONDITIONS

The EUT tested system was configured as the statements of 2.3 Unless otherwise a special operating condition is specified in the follows during the testing.



### 3.2.5 FIELD STRENGTH CALCULATION

The field strength is calculated by adding the Antenna Factor and Cable Factor and subtracting the Amplifier Gain and Duty Cycle Correction Factor (if any) from the measured reading. The basic equation with a sample calculation is as follows:

$$FS = RA + AF + CL - AG$$

Where

FS = Field Strength

CL = Cable Attenuation Factor (Cable Loss)

RA = Reading Amplitude

AG = Amplifier Gain

AF = Antenna Factor

For example

Frequency (MHz)	FS (dB $\mu$ V/m)	RA (dB $\mu$ V/m)	AF (dB)	CL (dB)	AG (dB)	Factor (dB)
300	40	58.1	12.2	1.6	31.9	-18.1

$$\text{Factor} = \text{AF} + \text{CL} - \text{AG}$$





## 3.2.6 TEST RESULT

9KHz-30MHz

Temperature:	23.2(C)	Relative Humidity:	61%RH
Test Voltage:	DC 3.7V	Polarization:	--
Test Mode:	TX Mode		

Freq. (MHz)	Reading (dBuV/m)	Limit (dBuV/m)	Margin (dB)	State P/F	Test Result
--	--	--	--	--	PASS
--	--	--	--	--	PASS

## Note:

The amplitude of spurious emissions which are attenuated by more than 20dB below the permissible value has no need to be reported.

Distance extrapolation factor =  $40 \log (\text{specific distance}/\text{test distance})$ (dB);

Limit line = specific limits(dBuv) + distance extrapolation factor.

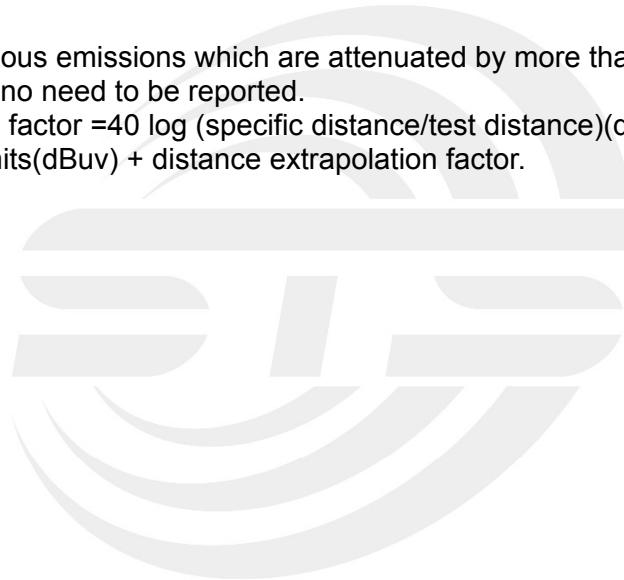





(30MHz - 1000MHz)

Temperature:	23.2(C)	Relative Humidity:	61%RH
Test Voltage:	DC 3.7V	Phase:	Horizontal
Test Mode:	Mode 1/2/3/4/5/6/7/8/9/10/11/12 (Mode 11 worst mode)		

No.	Frequency (MHz)	Reading (dBuV)	Correct Factor(dB/m)	Result (dBuV/m)	Limit (dBuV/m)	Margin (dB)	Remark
1	50.3700	43.19	-23.42	19.77	40.00	-20.23	QP
2	182.2900	35.44	-20.19	15.25	43.50	-28.25	QP
3	423.8200	30.18	-10.11	20.07	46.00	-25.93	QP
4	561.5600	29.67	-5.51	24.16	46.00	-21.84	QP
5	733.2500	30.27	-2.35	27.92	46.00	-18.08	QP
6	976.7200	29.95	2.45	32.40	54.00	-21.60	QP

Remark:

- Margin = Result (Result =Reading + Factor)–Limit
- Factor= Antenna factor+Cable attenuation factor(cable loss)-Amplifier gain

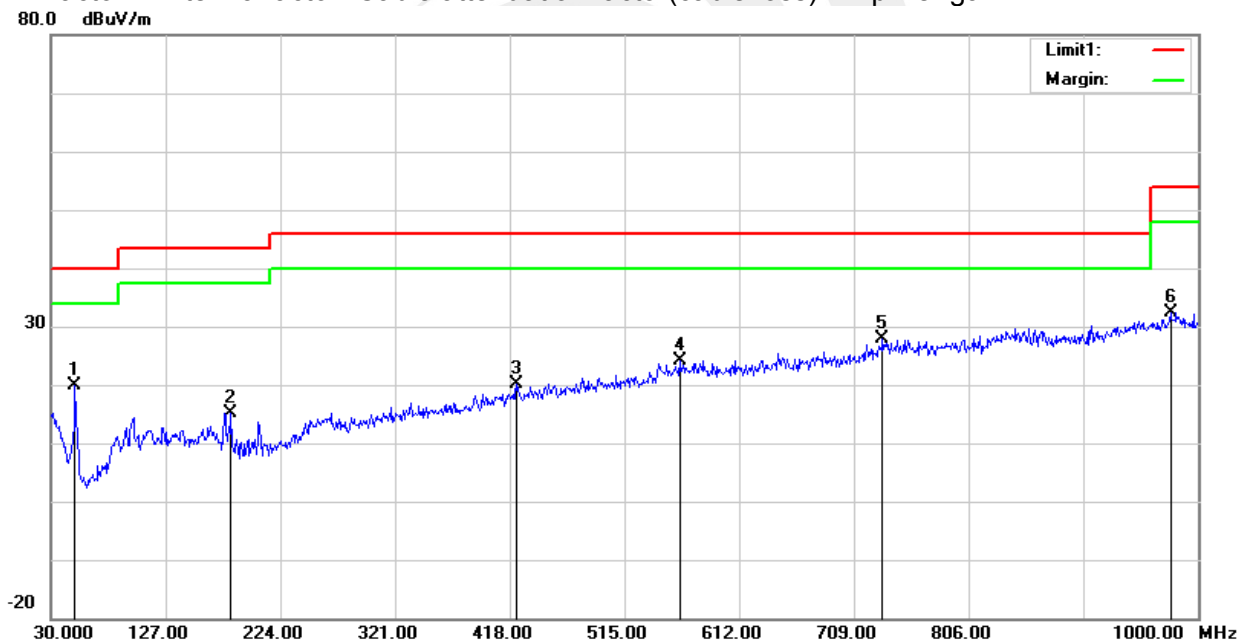



Temperature:	23.2(C)	Relative Humidity:	61%RH
Test Voltage:	DC 3.7V	Phase:	Vertical
Test Mode:	Mode 1/2/3/4/5/6/7/8/9/10/11/12 (Mode 11 worst mode)		

No.	Frequency (MHz)	Reading (dBuV)	Correct Factor(dB/m)	Result (dBuV/m)	Limit (dBuV/m)	Margin (dB)	Remark
1	32.9100	38.53	-14.33	24.20	40.00	-15.80	QP
2	98.8700	44.12	-20.31	23.81	43.50	-19.69	QP
3	442.2500	31.70	-9.99	21.71	46.00	-24.29	QP
4	733.2500	30.86	-2.35	28.51	46.00	-17.49	QP
5	869.0500	33.29	-0.52	32.77	46.00	-13.23	QP
6	994.1800	30.57	2.05	32.62	54.00	-21.38	QP

Remark:.

- Margin = Result (Result =Reading + Factor )-Limit
- Factor= Antenna factor+Cable attenuation factor(cable loss)-Amplifier gain

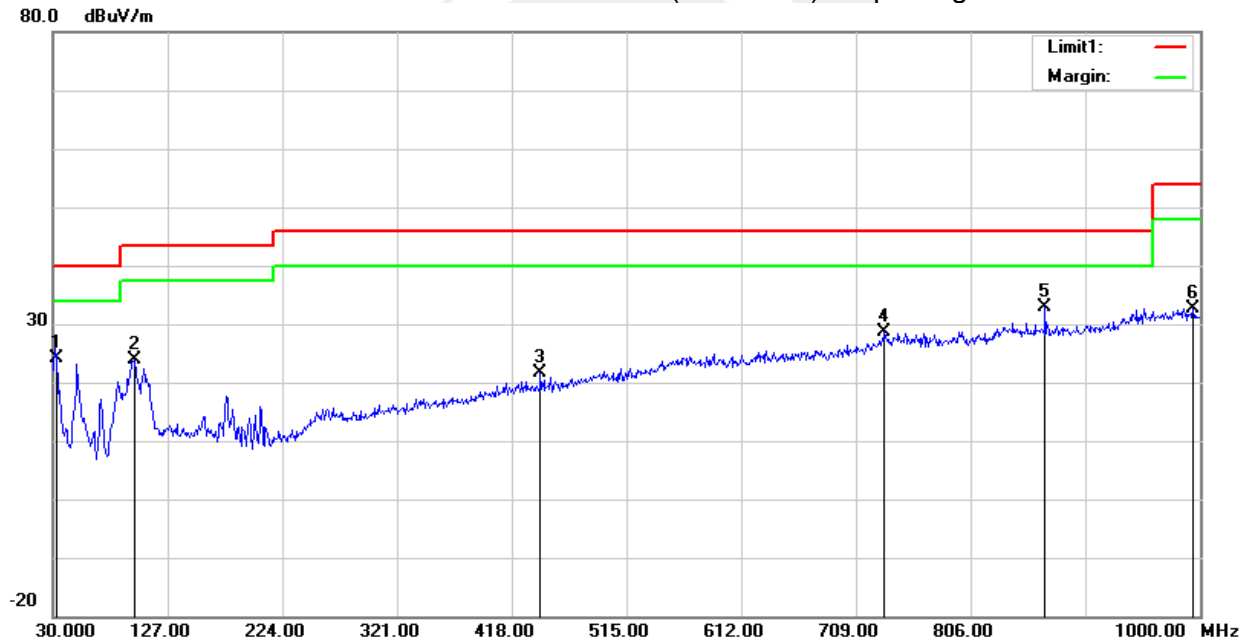



## (1000MHz-25GHz) Spurious emission Requirements

## 802.11 n(HT40)

Frequency (MHz)	Meter Reading (dBμV)	Amplifier (dB)	Loss (dB)	Antenna Factor (dB/m)	Orrected Factor (dB)	Emission Level (dBμV/m)	Limits (dBμV/m)	Margin (dB)	Detector Type	Comment
Low Channel (802.11n40/2422 MHz)										
3264.70	61.99	44.70	6.70	28.20	-9.80	52.19	74.00	-21.81	PK	Vertical
3264.70	50.36	44.70	6.70	28.20	-9.80	40.56	54.00	-13.44	AV	Vertical
3264.60	60.95	44.70	6.70	28.20	-9.80	51.15	74.00	-22.85	PK	Horizontal
3264.60	51.27	44.70	6.70	28.20	-9.80	41.47	54.00	-12.53	AV	Horizontal
4824.49	58.90	44.20	9.04	31.60	-3.56	55.34	74.00	-18.66	PK	Vertical
4824.49	50.25	44.20	9.04	31.60	-3.56	46.69	54.00	-7.31	AV	Vertical
4824.54	58.81	44.20	9.04	31.60	-3.56	55.25	74.00	-18.75	PK	Horizontal
4824.54	49.87	44.20	9.04	31.60	-3.56	46.31	54.00	-7.69	AV	Horizontal
5359.79	49.36	44.20	9.86	32.00	-2.34	47.02	74.00	-26.98	PK	Vertical
5359.79	39.71	44.20	9.86	32.00	-2.34	37.37	54.00	-16.63	AV	Vertical
5359.59	47.50	44.20	9.86	32.00	-2.34	45.16	74.00	-28.84	PK	Horizontal
5359.59	38.04	44.20	9.86	32.00	-2.34	35.70	54.00	-18.30	AV	Horizontal
7235.98	54.04	43.50	11.40	35.50	3.40	57.44	74.00	-16.56	PK	Vertical
7235.98	44.55	43.50	11.40	35.50	3.40	47.95	54.00	-6.05	AV	Vertical
7235.67	53.65	43.50	11.40	35.50	3.40	57.05	74.00	-16.95	PK	Horizontal
7235.92	43.54	43.50	11.40	35.50	3.40	46.94	54.00	-7.06	AV	Horizontal
Middle Channel (802.11n40/2437 MHz)										
3264.61	61.24	44.70	6.70	28.20	-9.80	51.44	74.00	-22.56	PK	Vertical
3264.61	51.71	44.70	6.70	28.20	-9.80	41.91	54.00	-12.09	AV	Vertical
3264.76	61.61	44.70	6.70	28.20	-9.80	51.81	74.00	-22.19	PK	Horizontal
3264.76	51.13	44.70	6.70	28.20	-9.80	41.33	54.00	-12.67	AV	Horizontal
4874.37	58.18	44.20	9.04	31.60	-3.56	54.62	74.00	-19.38	PK	Vertical
4874.37	49.44	44.20	9.04	31.60	-3.56	45.88	54.00	-8.12	AV	Vertical
4874.52	58.37	44.20	9.04	31.60	-3.56	54.81	74.00	-19.19	PK	Horizontal
4874.52	50.52	44.20	9.04	31.60	-3.56	46.96	54.00	-7.04	AV	Horizontal
5359.78	49.10	44.20	9.86	32.00	-2.34	46.76	74.00	-27.24	PK	Vertical
5359.78	38.97	44.20	9.86	32.00	-2.34	36.63	54.00	-17.37	AV	Vertical
5359.85	48.42	44.20	9.86	32.00	-2.34	46.08	74.00	-27.92	PK	Horizontal
5359.85	38.35	44.20	9.86	32.00	-2.34	36.01	54.00	-17.99	AV	Horizontal
7310.97	54.90	43.50	11.40	35.50	3.40	58.30	74.00	-15.70	PK	Vertical
7310.97	44.16	43.50	11.40	35.50	3.40	47.56	54.00	-6.44	AV	Vertical
7310.89	54.43	43.50	11.40	35.50	3.40	57.83	74.00	-16.17	PK	Horizontal
7310.89	44.29	43.50	11.40	35.50	3.40	47.69	54.00	-6.31	AV	Horizontal



High Channel (802.11n40/2452 MHz)										
3264.86	60.91	44.70	6.70	28.20	-9.80	51.11	74.00	-22.89	PK	Vertical
3264.86	50.61	44.70	6.70	28.20	-9.80	40.81	54.00	-13.19	AV	Vertical
3264.81	61.36	44.70	6.70	28.20	-9.80	51.56	74.00	-22.44	PK	Horizontal
3264.81	50.90	44.70	6.70	28.20	-9.80	41.10	54.00	-12.90	AV	Horizontal
4924.33	58.81	44.20	9.04	31.60	-3.56	55.25	74.00	-18.75	PK	Vertical
4924.33	50.27	44.20	9.04	31.60	-3.56	46.71	54.00	-7.29	AV	Vertical
4924.34	58.34	44.20	9.04	31.60	-3.56	54.78	74.00	-19.22	PK	Horizontal
4924.34	49.22	44.20	9.04	31.60	-3.56	45.66	54.00	-8.34	AV	Horizontal
5359.60	48.07	44.20	9.86	32.00	-2.34	45.73	74.00	-28.27	PK	Vertical
5359.60	38.97	44.20	9.86	32.00	-2.34	36.63	54.00	-17.37	AV	Vertical
5359.64	47.24	44.20	9.86	32.00	-2.34	44.90	74.00	-29.10	PK	Horizontal
5359.64	39.16	44.20	9.86	32.00	-2.34	36.82	54.00	-17.18	AV	Horizontal
7385.82	53.88	43.50	11.40	35.50	3.40	57.28	74.00	-16.72	PK	Vertical
7385.82	43.95	43.50	11.40	35.50	3.40	47.35	54.00	-6.65	AV	Vertical
7385.71	53.69	43.50	11.40	35.50	3.40	57.09	74.00	-16.91	PK	Horizontal
7385.71	43.66	43.50	11.40	35.50	3.40	47.06	54.00	-6.94	AV	Horizontal

## Remark:

- Factor = Antenna Factor + Cable Loss – Pre-amplifier.
- Scan with 802.11b, 802.11g, 802.11n (HT-20), 802.11n (HT-40) the worst case is 802.11 n(HT40).  
Emission Level = Reading + Factor  
Margin = Limit - Emission Level
- The frequency emission of peak points that did not show above the forms are at least 20dB below the limit, the frequency emission is mainly from the environment noise.

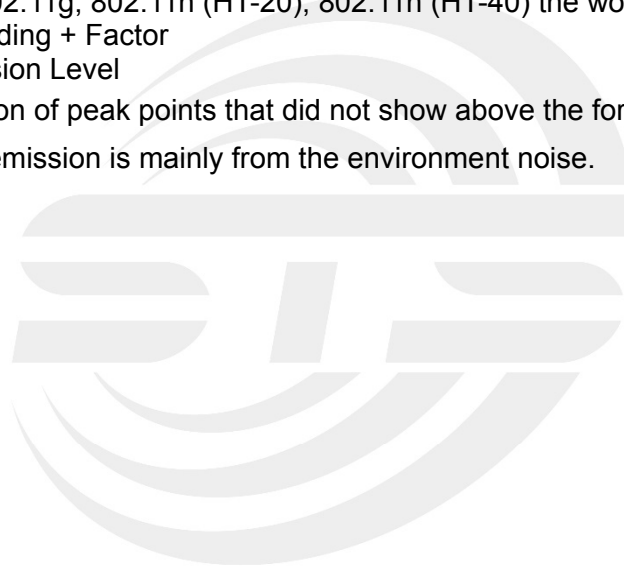



3.2.6 TEST RESULTS(Band edge Requirements)

802.11 n(HT40)-Low

Horizontal

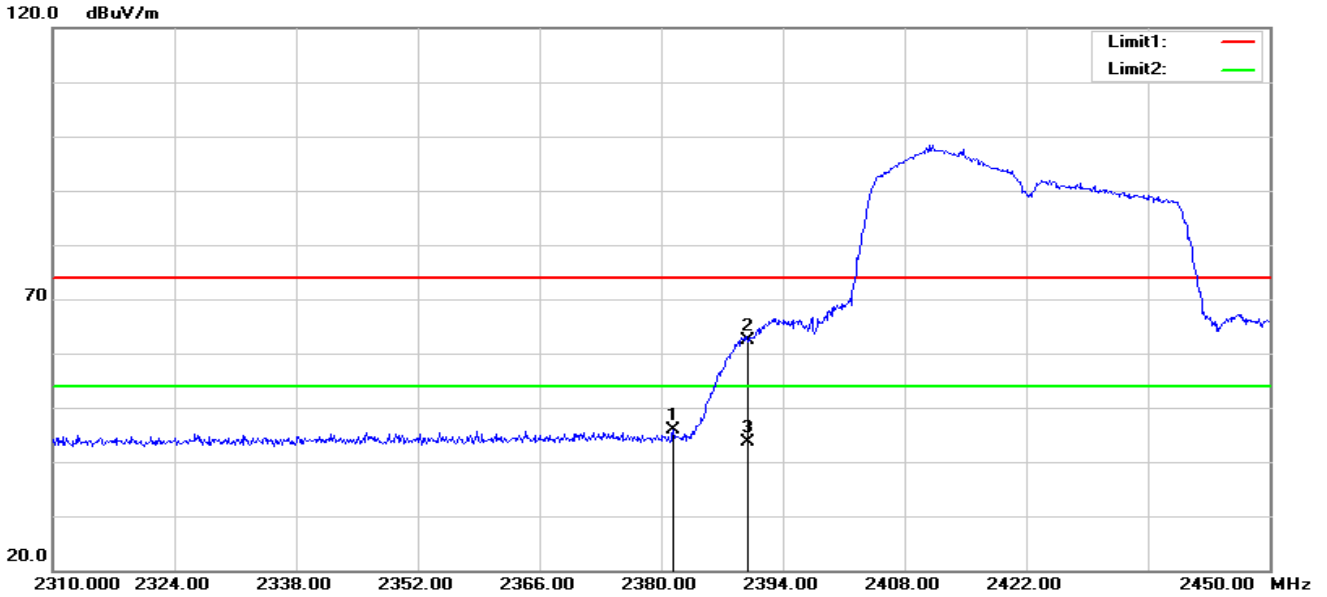

No.	Frequency (MHz)	Reading (dBuV)	Correct Factor(dB/m)	Result (dBuV/m)	Limit (dBuV/m)	Margin (dB)	Remark
1	2381.400	41.58	4.21	45.79	74.00	-28.21	peak
2	2390.000	57.93	4.34	62.27	74.00	-11.73	peak
3	2390.000	39.22	4.34	43.56	54.00	-10.44	AVG

Vertical

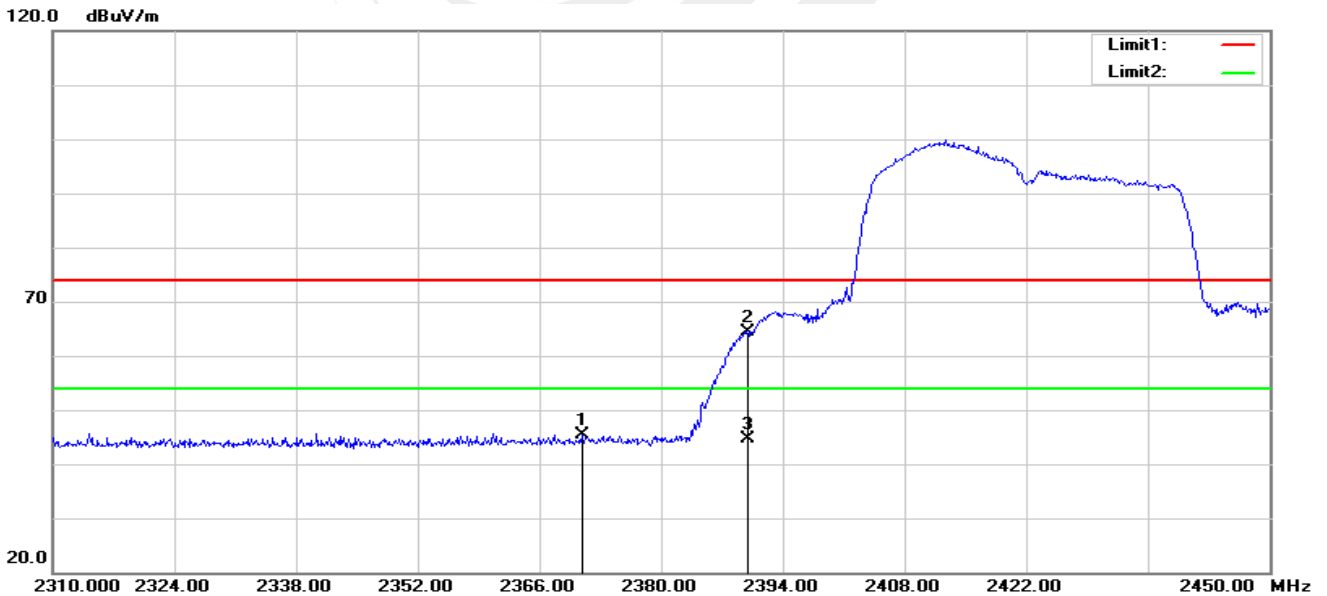

No.	Frequency (MHz)	Reading (dBuV)	Correct Factor(dB/m)	Result (dBuV/m)	Limit (dBuV/m)	Margin (dB)	Remark
1	2370.900	41.27	4.05	45.32	74.00	-28.68	peak
2	2390.000	59.93	4.34	64.27	74.00	-9.73	peak
3	2390.000	40.29	4.34	44.63	54.00	-9.37	AVG



802.11 n(HT40)-High  
Horizontal

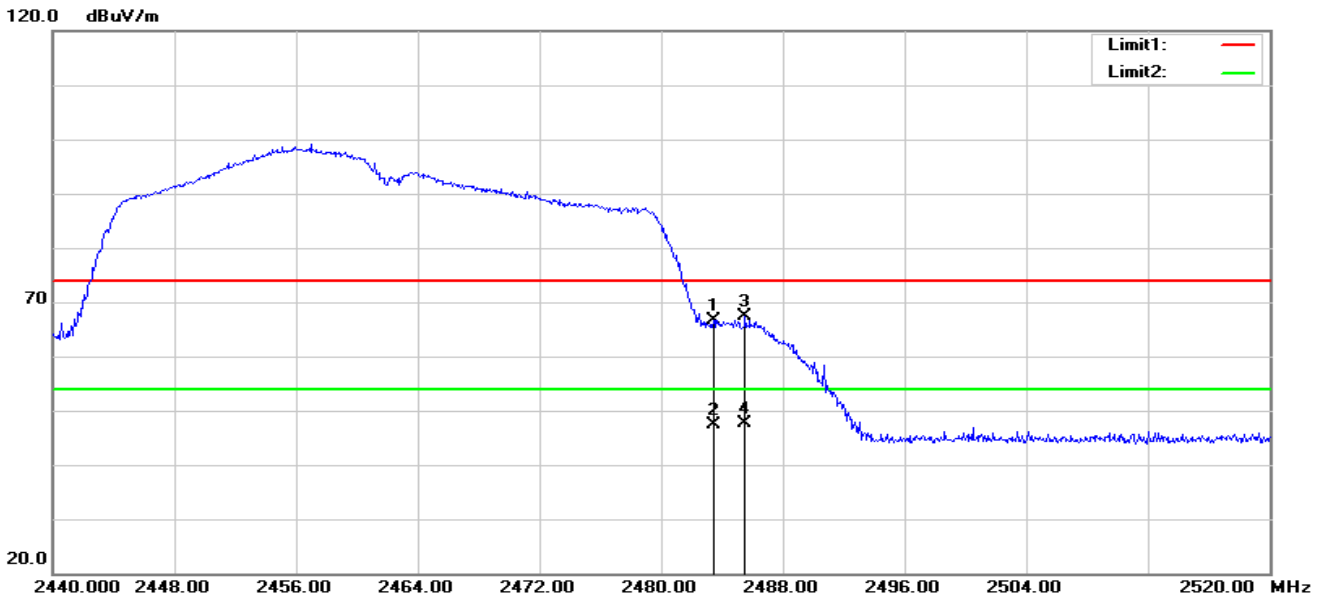

No.	Frequency (MHz)	Reading (dBuV)	Correct Factor(dB/m)	Result (dBuV/m)	Limit (dBuV/m)	Margin (dB)	Remark
1	2483.500	61.92	4.60	66.52	74.00	-7.48	peak
2	2483.500	42.72	4.60	47.32	54.00	-6.68	AVG
3	2485.520	62.88	4.61	67.49	74.00	-6.51	peak
4	2485.520	42.92	4.61	47.53	54.00	-6.47	AVG

Vertical

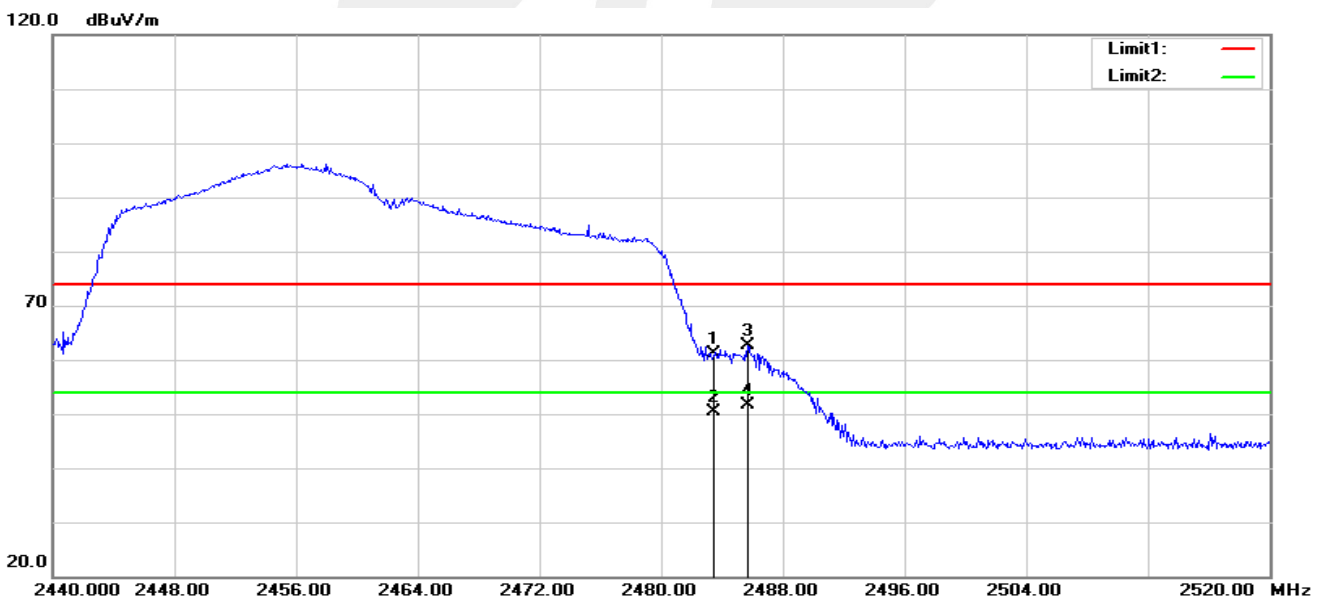

No.	Frequency (MHz)	Reading (dBuV)	Correct Factor(dB/m)	Result (dBuV/m)	Limit (dBuV/m)	Margin (dB)	Remark
1	2483.500	56.64	4.60	61.24	74.00	-12.76	peak
2	2483.500	45.72	4.60	50.32	54.00	-3.68	AVG
3	2485.680	58.00	4.61	62.61	74.00	-11.39	peak
4	2485.680	46.92	4.61	51.53	54.00	-2.47	AVG

Note: 802.11b, 802.11g, 802.11n (HT-20), 802.11n (HT-40) mode all have been tested, the worst case is 802.11 n(HT40), only show the worst case.

#### 4.CONDUCTED SPURIOUS & BAND EDGE EMISSION

##### 4.1 LIMIT

According to FCC section 15.247(d), in any 100kHz bandwidth outside the frequency band in which the spread spectrum or digitally modulated intentional radiator is operating, the radio frequency power that is produced by the intentional radiator shall be at least 20dB below that in the 100kHz bandwidth within the band that contains the highest level of the desired power, based on either an RF conducted or a radiated measurement.

##### 4.2 TEST PROCEDURE

Spectrum Parameter	Setting
Detector	Peak
Start/Stop Frequency	30 MHz to 10th carrier harmonic
RB / VB (emission in restricted band)	100 KHz/300 KHz
Trace-Mode:	Max hold

For Band edge

Spectrum Parameter	Setting
Detector	Peak
Start/Stop Frequency	Lower Band Edge: 2300 to 2432 MHz Upper Band Edge: 2442 to 2500 MHz
RB / VB (emission in restricted band)	100 KHz/300 KHz
Trace-Mode:	Max hold

##### 4.3 DEVIATION FROM STANDARD

No deviation.

##### 4.4 TEST SETUP



The EUT is connected to the Spectrum Analyzer; the RF load attached to the EUT antenna terminal is 50Ohm; the path loss as the factor is calibrated to correct the reading. Tune the measurement with the spectrum analyzer's resolution bandwidth (RBW) = 100 kHz. In order to make an accurate measurement, the span is set to be greater than RBW.

##### 4.5 EUT OPERATION CONDITIONS

Please refer to section 3.1.4 of this report.



4.6 TEST RESULTS

Temperature:	25°C	Relative Humidity:	60%
Test Voltage:	DC 3.7V	Test Mode:	TX b Mode /CH01, CH06, CH11

CH 01

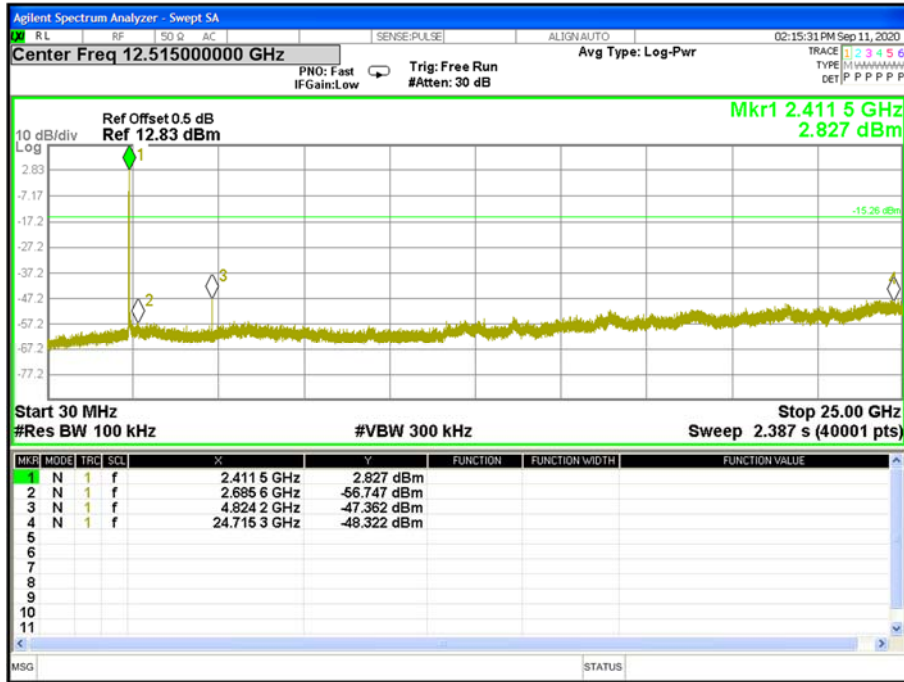

CH 06

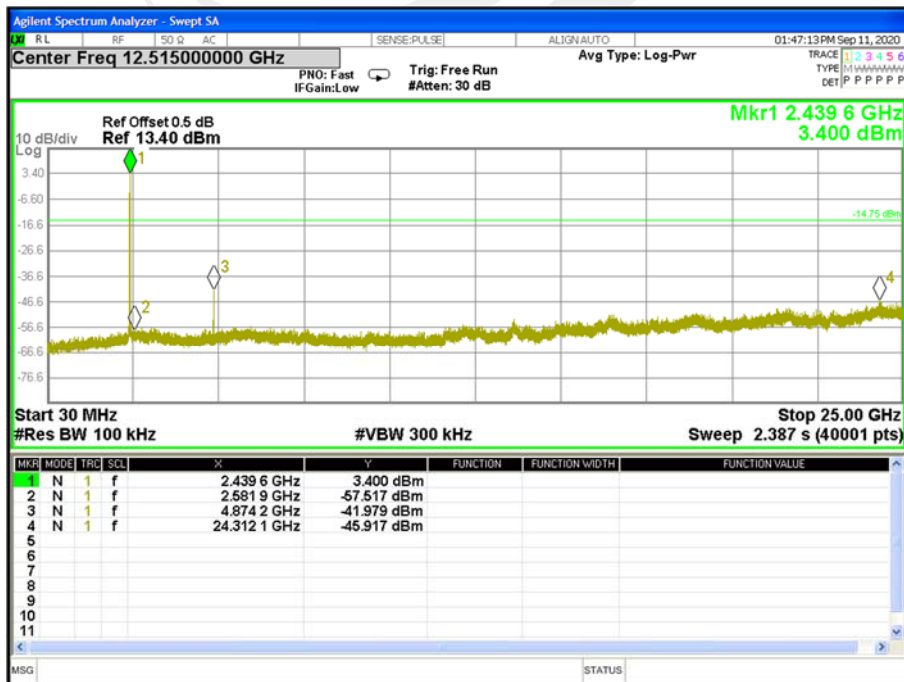





CH 11

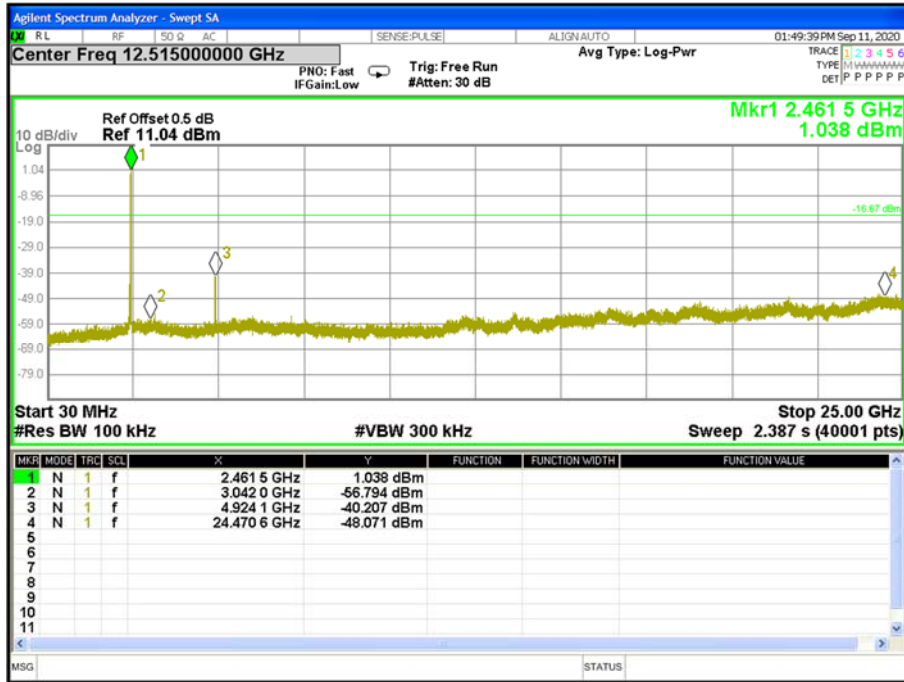



Band edge(it's also the reference level for conducted spurious emission)

CH 01

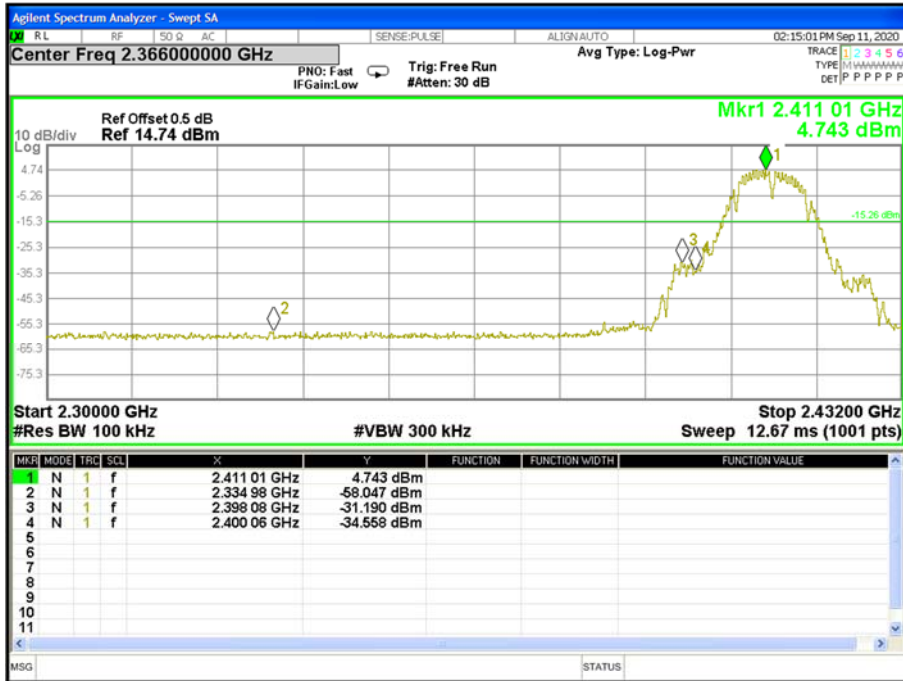

CH 06





CH 11

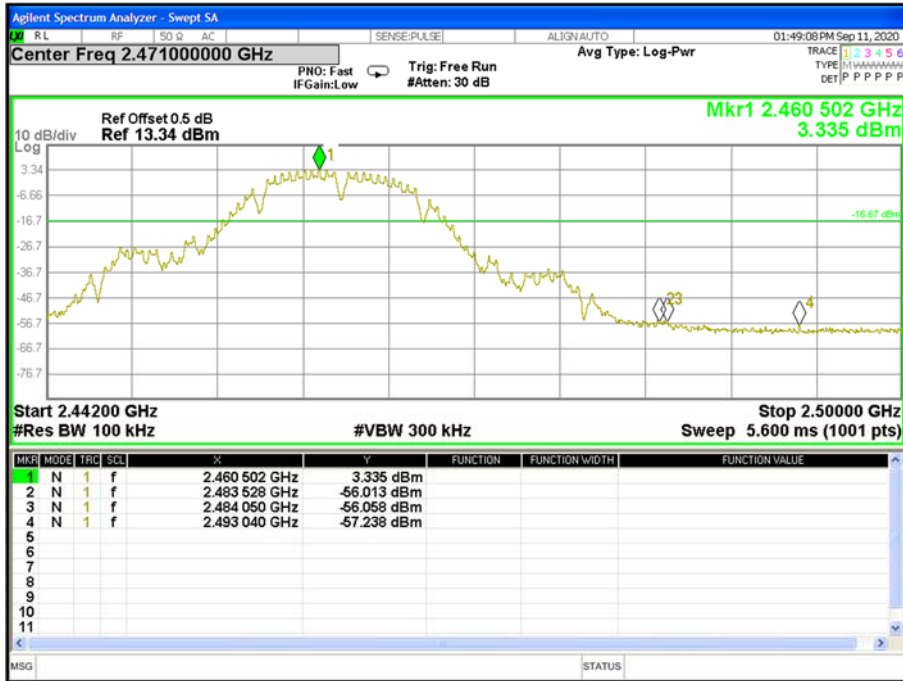



Temperature:	25°C	Relative Humidity:	60%
Test Voltage:	DC 3.7V	Test Mode:	TX g Mode /CH01, CH06, CH11

CH 01

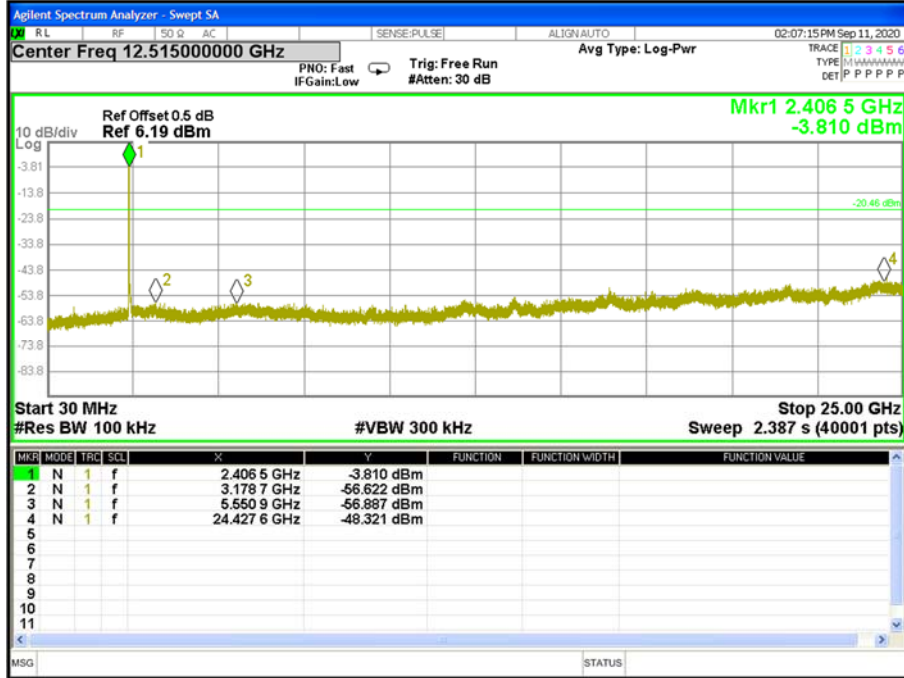

CH06

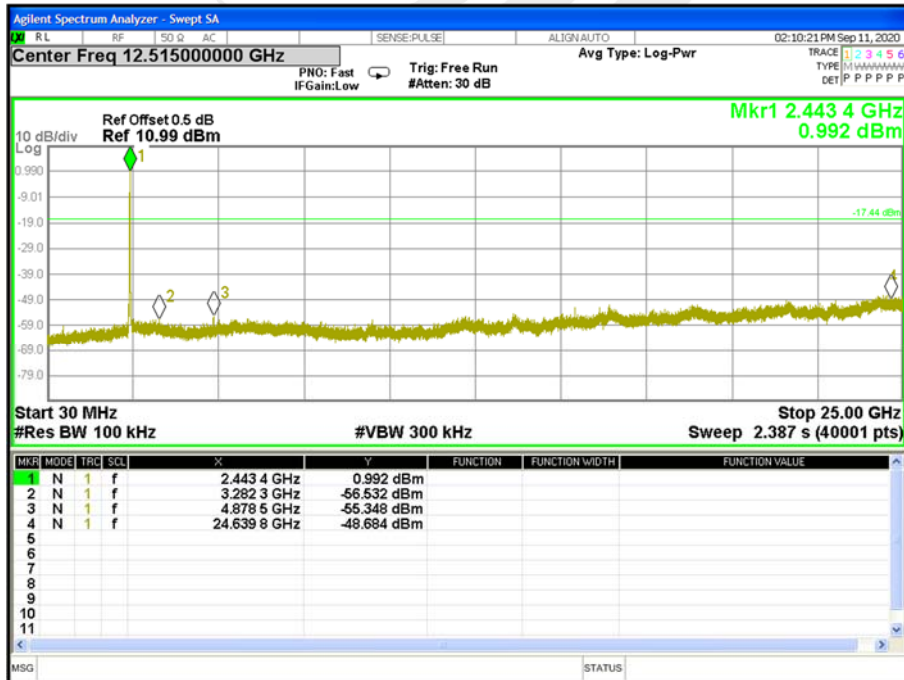



CH 11

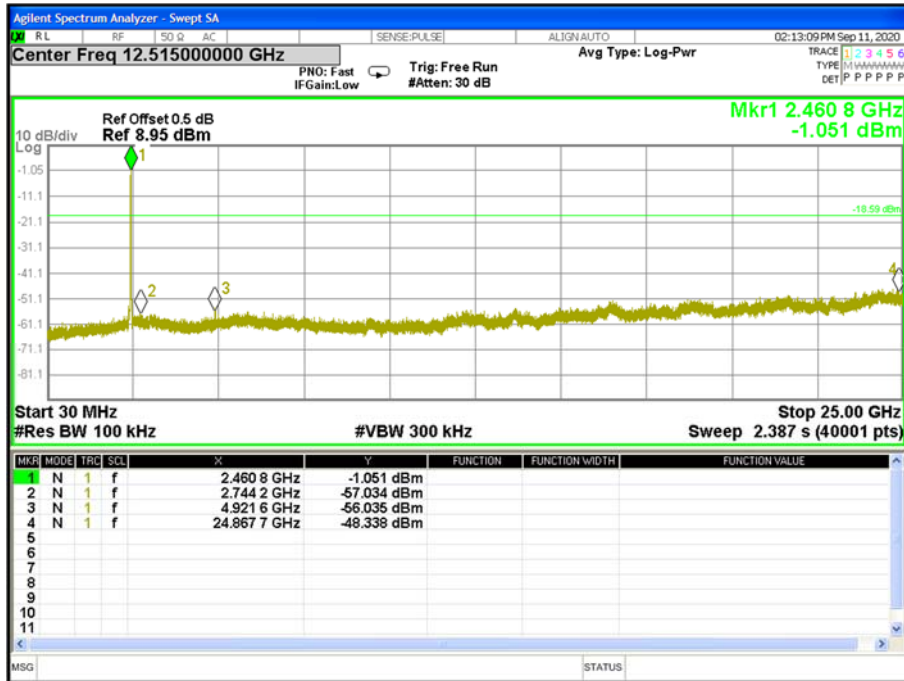



Band edge(it's also the reference level for conducted spurious emission)

CH 01

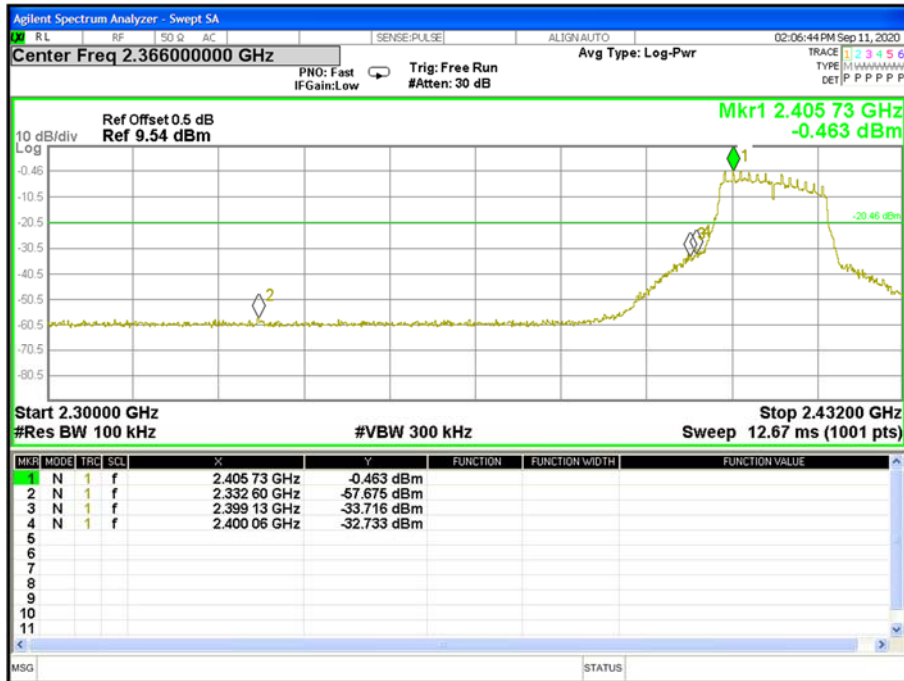

CH06

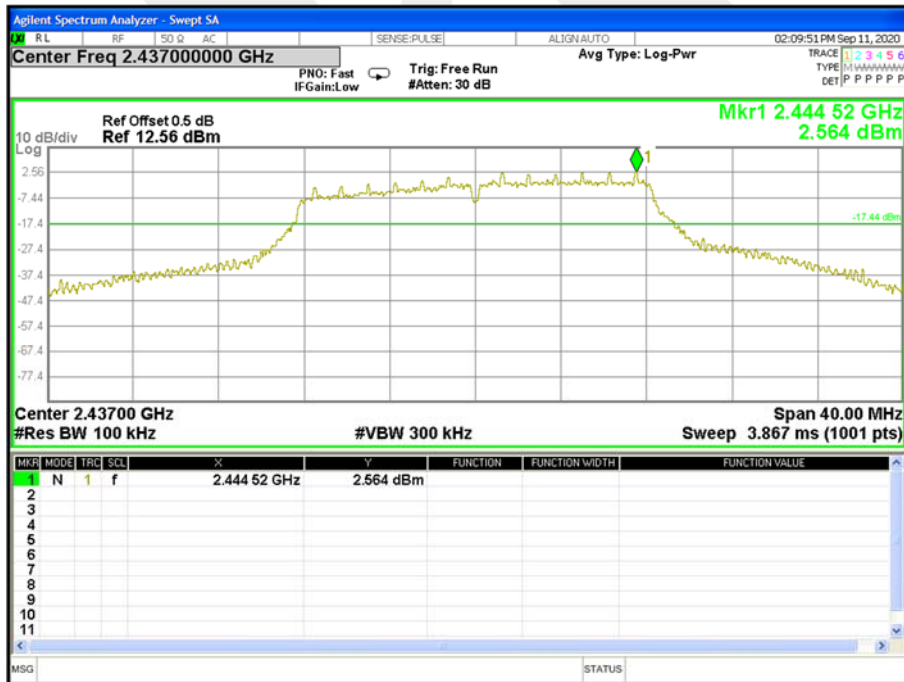



CH11

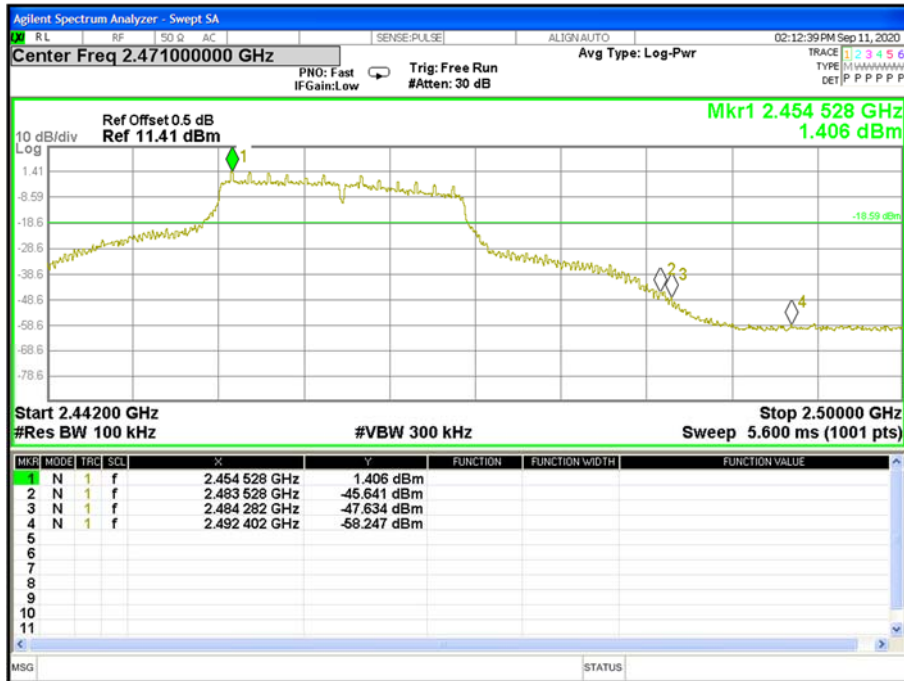



Temperature:	25°C	Relative Humidity:	60%
Test Voltage:	DC 3.7V	Test Mode:	TX n Mode(20M) /CH01, CH06, CH11

CH 01

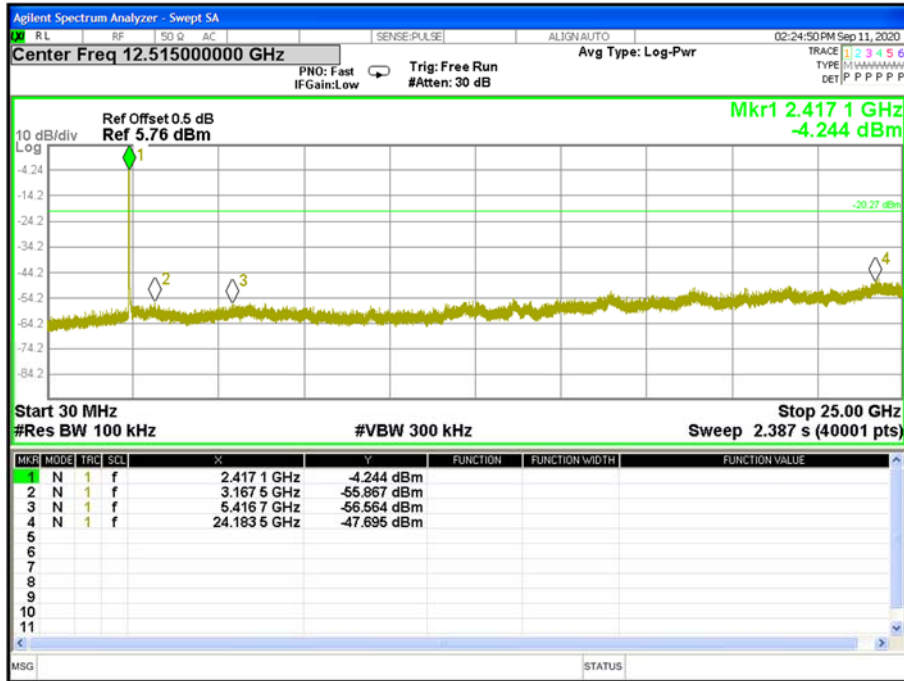

CH 06

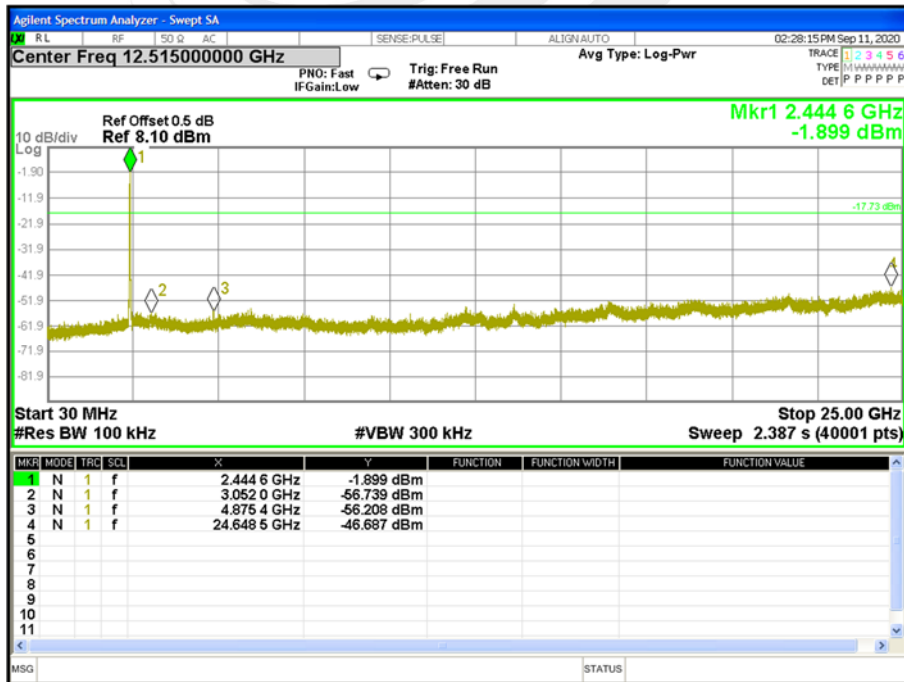





CH 11

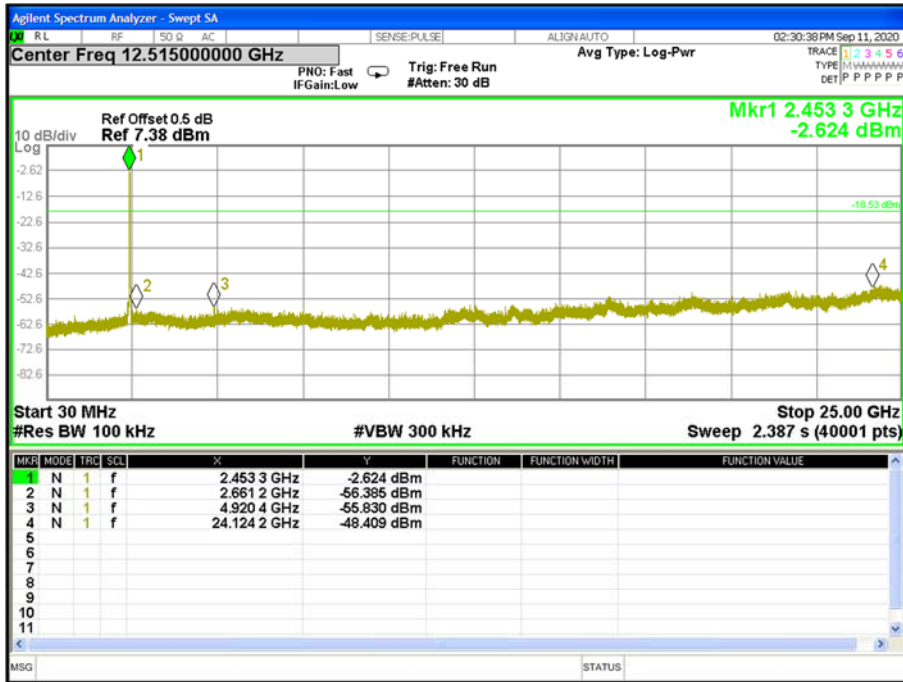



Band edge(it's also the reference level for conducted spurious emission)

CH 01

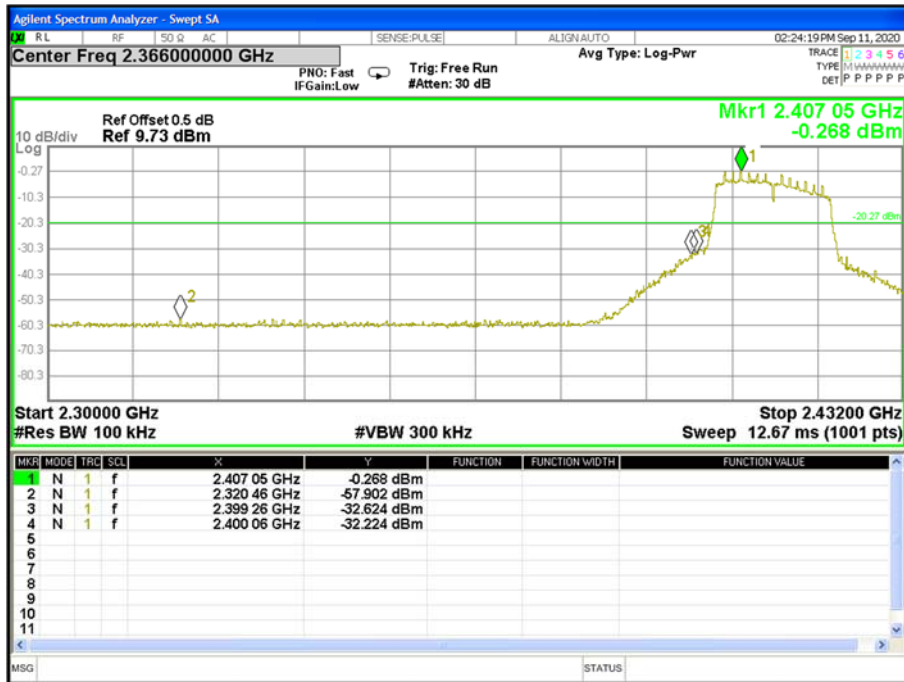

CH 06

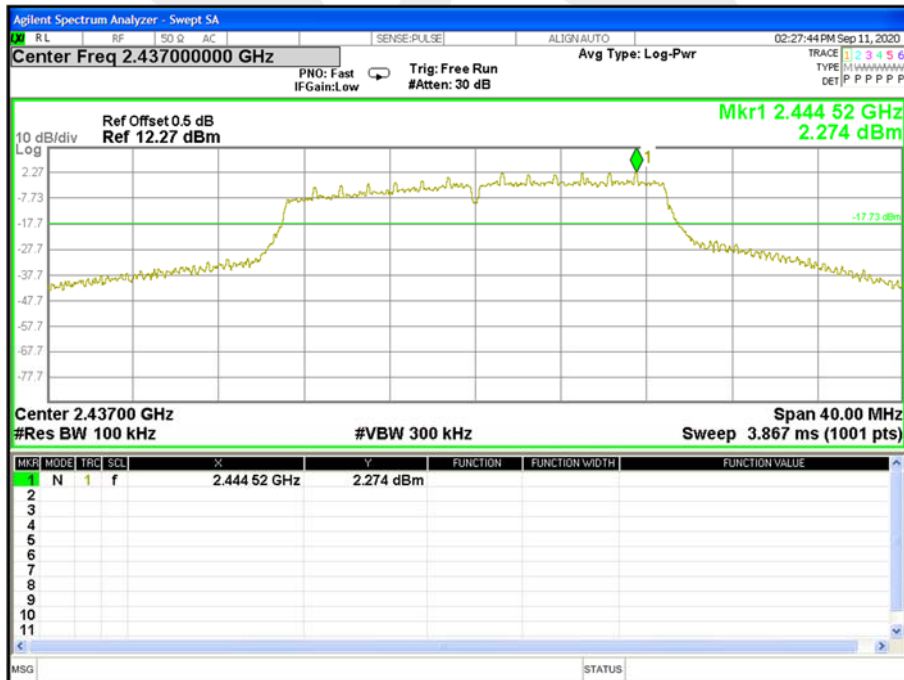



CH 11

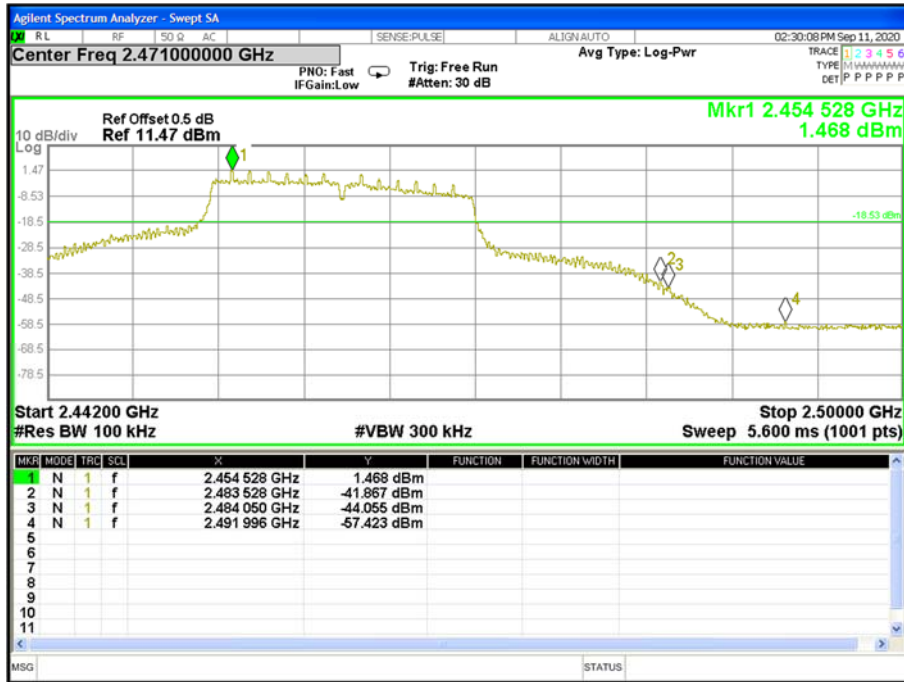



Temperature:	25°C	Relative Humidity:	60%
Test Voltage:	DC 3.7V	Test Mode:	TX n Mode(40M) /CH03, CH06, CH09

CH 03

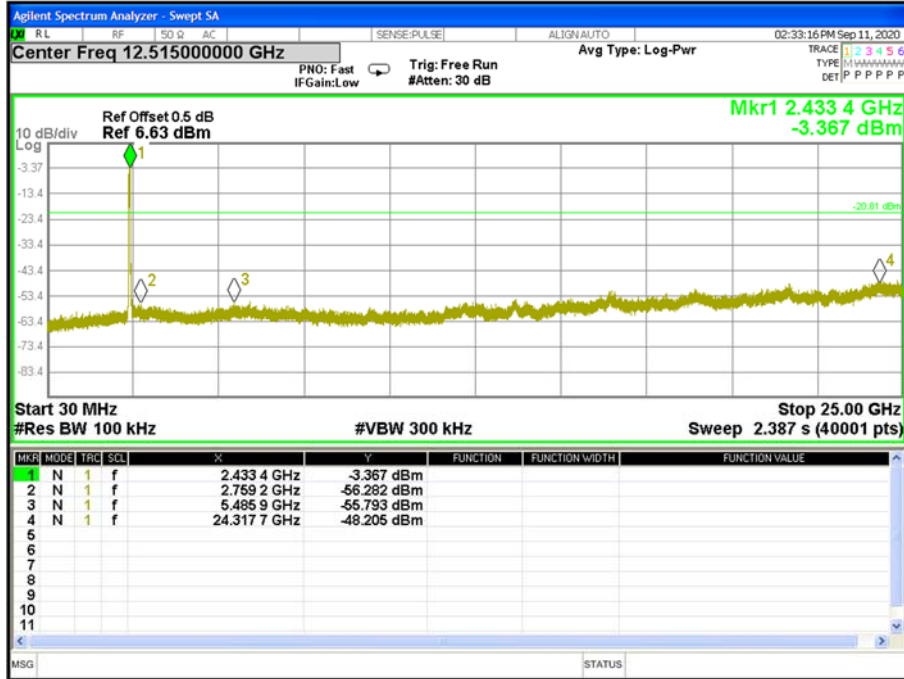



CH06

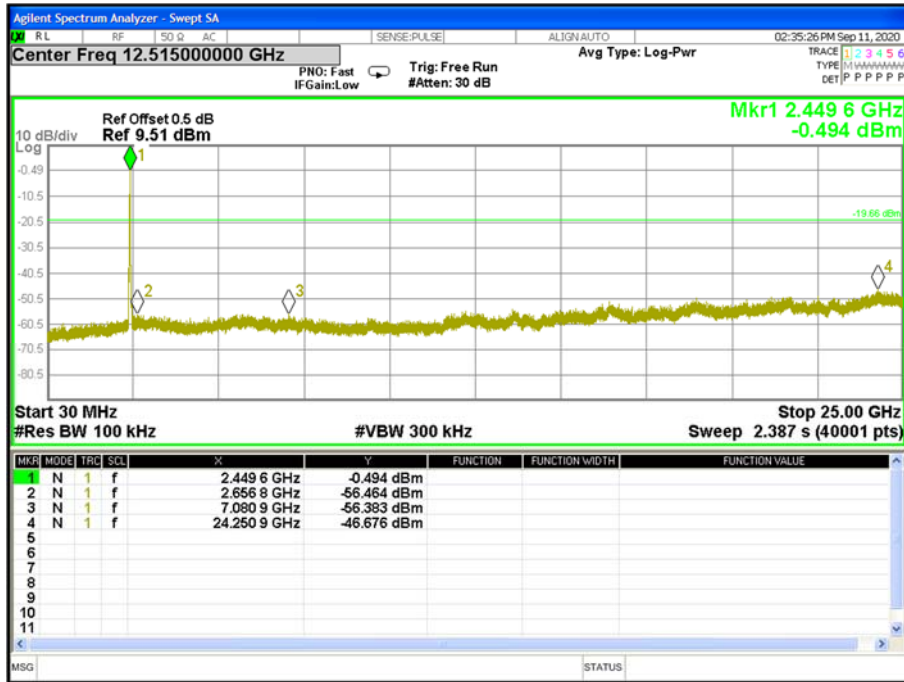

CH09

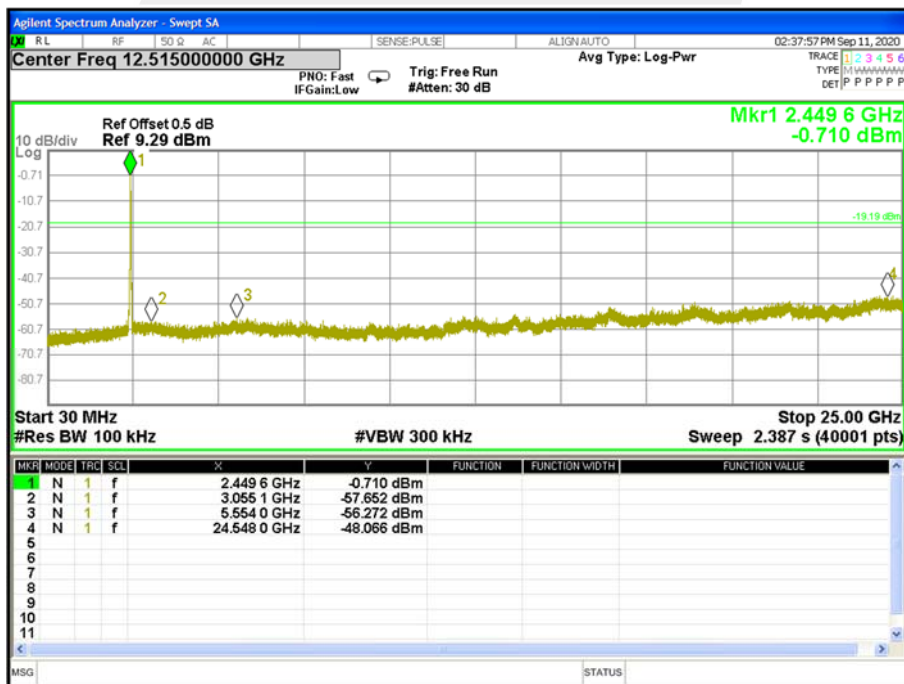



Band edge(it's also the reference level for conducted spurious emission)

CH03

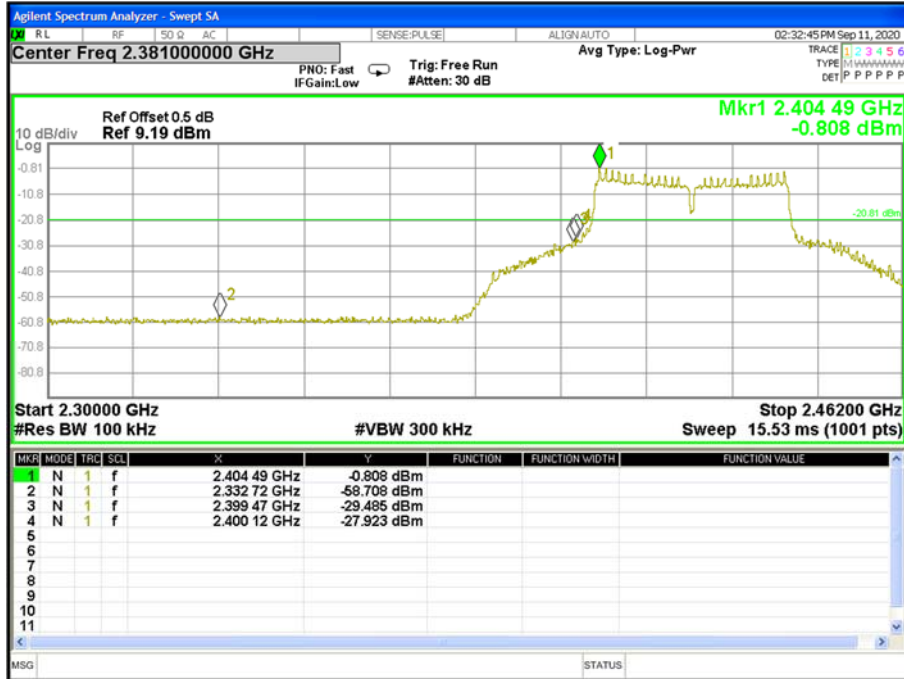

CH 06





CH 09

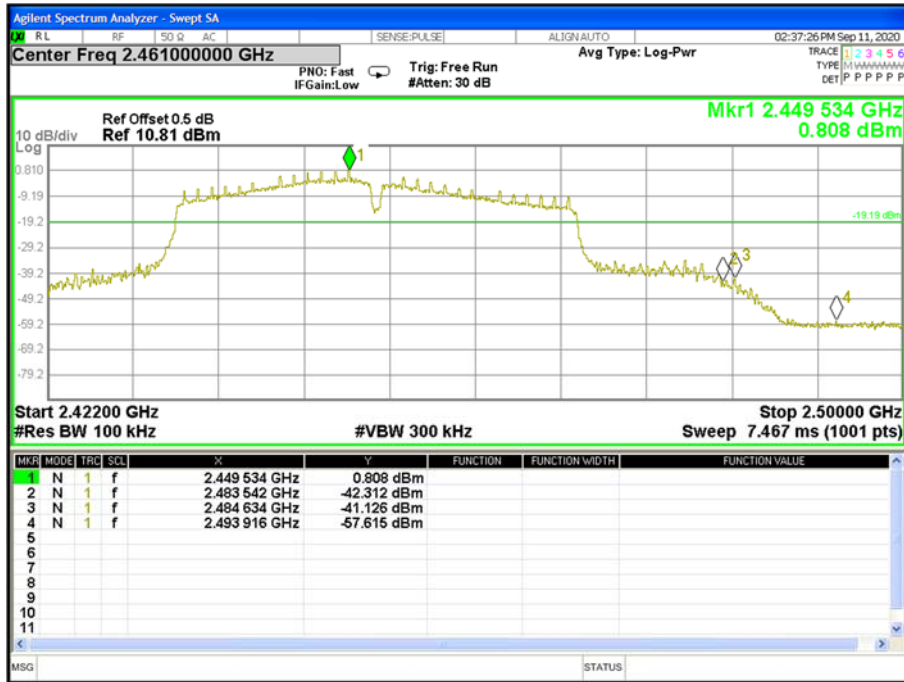

## 5. POWER SPECTRAL DENSITY TEST

### 5.1 LIMIT

FCC Part15.247 , Subpart C				
Section	Test Item	Limit	Frequency Range (MHz)	Result
15.247(e)	Power Spectral Density	≤8 dBm (RBW ≥3KHz)	2400-2483.5	PASS

### 5.2 TEST PROCEDURE

1. Set analyzer center frequency to DTS channel center frequency.
2. Set the span to 1.5 times the DTS channel bandwidth.
3. Set the 100 kHz ≥ RBW ≥3 kHz.
4. Set the VBW ≥ 3 x RBW.
5. Detector = peak.
6. Sweep time = auto couple.
7. Trace mode = max hold.
8. Allow trace to fully stabilize.
9. Use the peak marker function to determine the maximum amplitude level.
10. If measured value exceeds limit, reduce RBW (no less than 3 kHz) and repeat.

### 5.3 DEVIATION FROM STANDARD

No deviation.

### 5.4 TEST SETUP



### 5.5 EUT OPERATION CONDITIONS

Please refer to section 3.1.4 of this report.





5.6 TEST RESULTS

Temperature:	25°C	Relative Humidity:	60%
Test Voltage:	DC 3.7V	Test Mode:	TX b Mode /CH01, CH06, CH11

Frequency	Power Density	Limit (3KHZ/dBm)	Result
	(dBm/3kHz)		
2412 MHz	-9.169	≤8	PASS
2437 MHz	-9.517	≤8	PASS
2462 MHz	-11.706	≤8	PASS

TX CH01

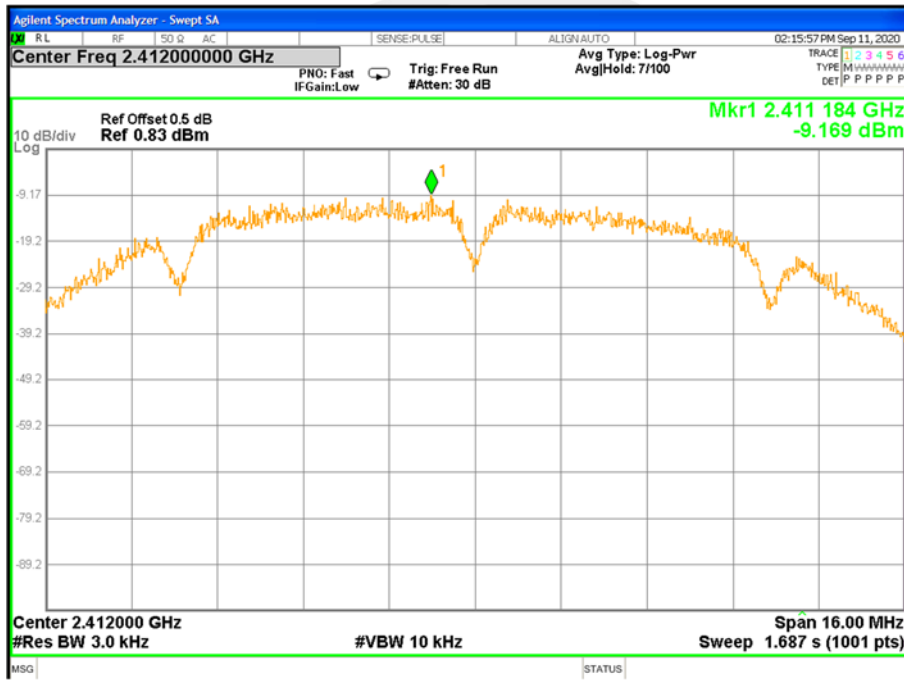



### TX CH06

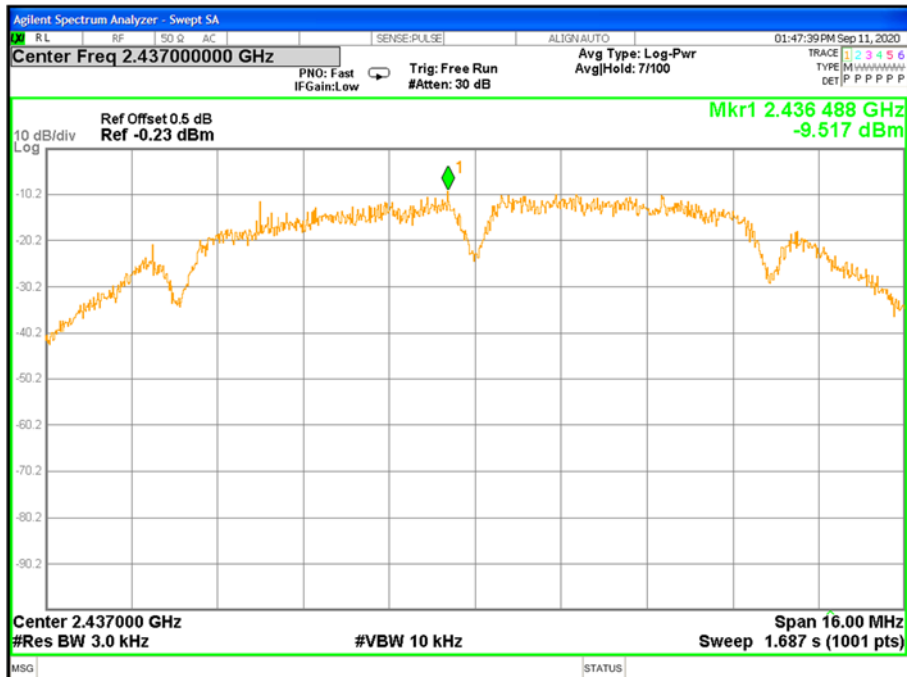

### TX CH11

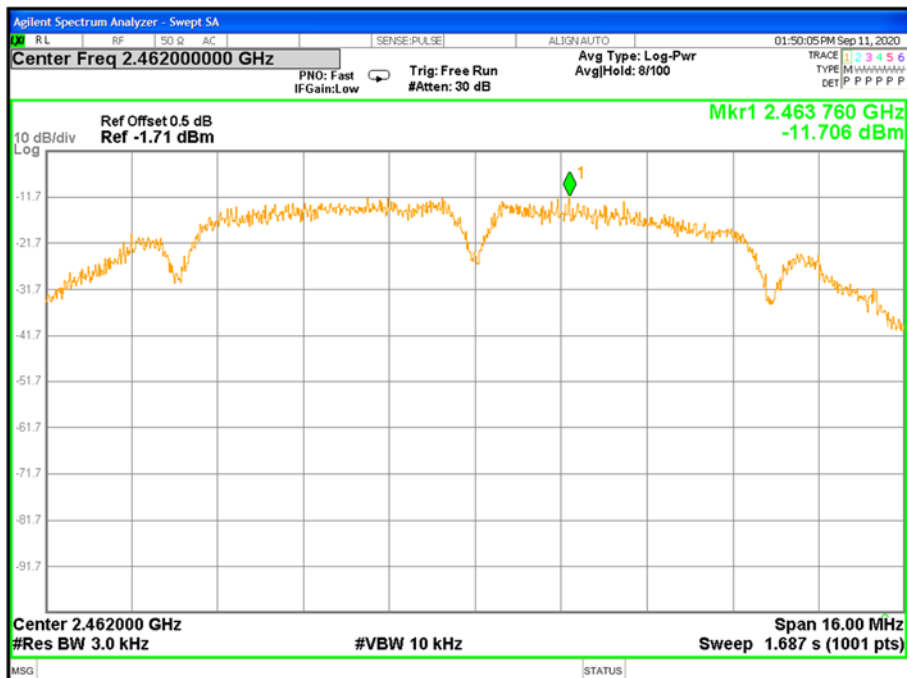



Temperature:	25°C	Relative Humidity:	60%
Test Voltage:	DC 3.7V	Test Mode:	TX g Mode /CH01, CH06, CH11

Frequency	Power Density	Limit (3KHZ/dBm)	Result
	(dBm/3kHz)		
2412 MHz	-15.2060	≤8	PASS
2437 MHz	-12.3240	≤8	PASS
2462 MHz	-12.9440	≤8	PASS

TX CH01

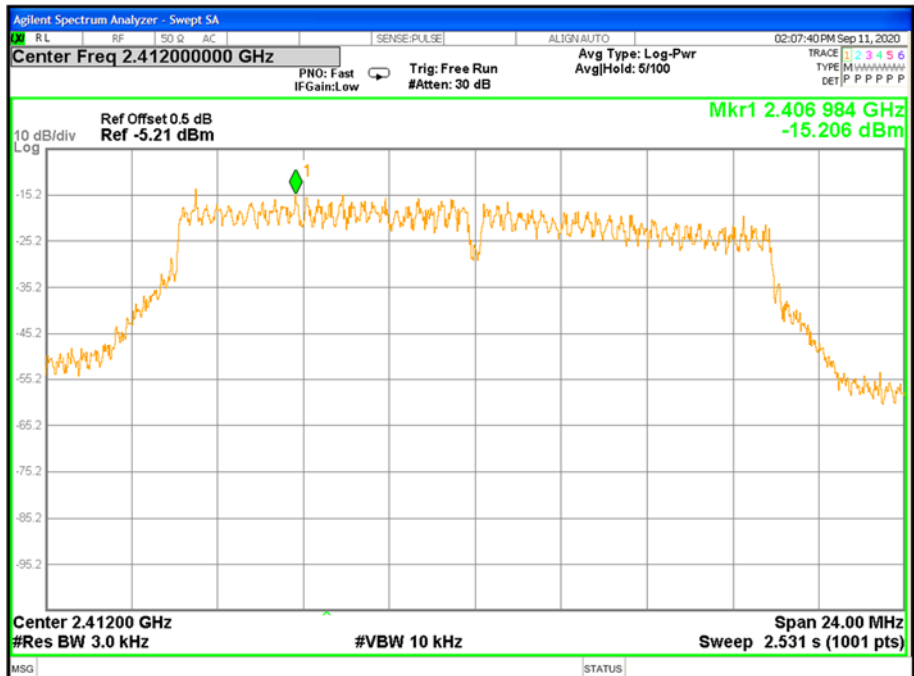



### TX CH06

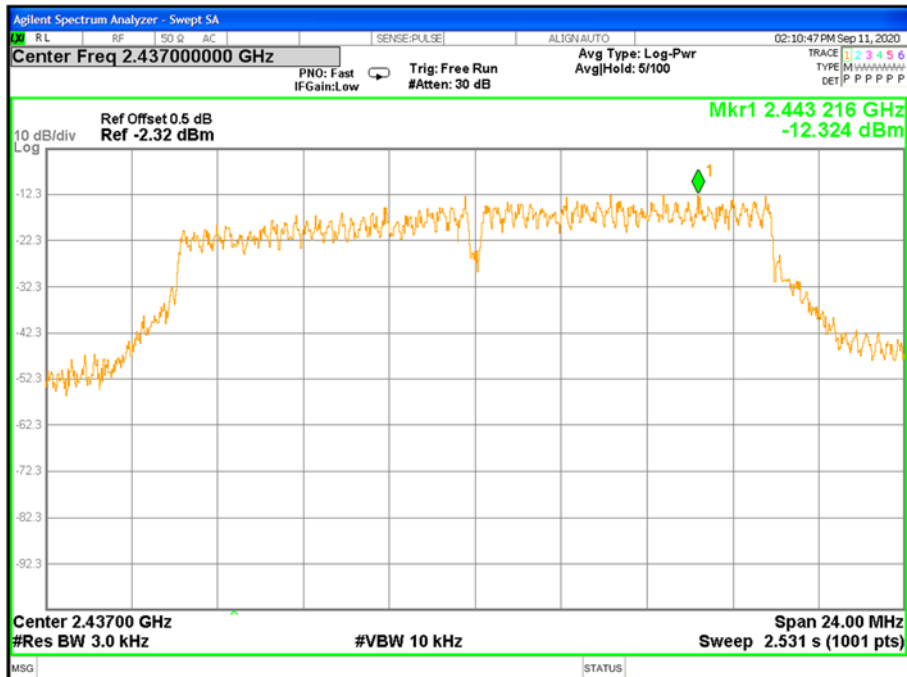

### TX CH11

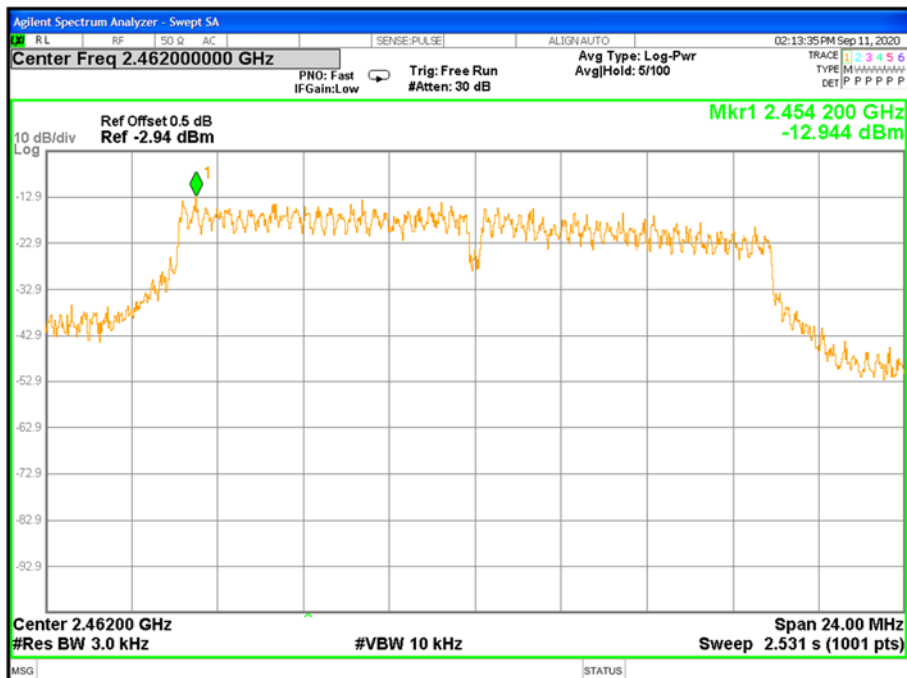



Temperature:	25°C	Relative Humidity:	60%
Test Voltage:	DC 3.7V	Test Mode:	TX n Mode(20M) /CH01, CH06, CH11

Frequency	Power Density	Limit (3KHZ/dBm)	Result
	(dBm/3kHz)		
2412 MHz	-15.5310	≤8	PASS
2437 MHz	-12.4050	≤8	PASS
2462 MHz	-13.5820	≤8	PASS

TX CH01

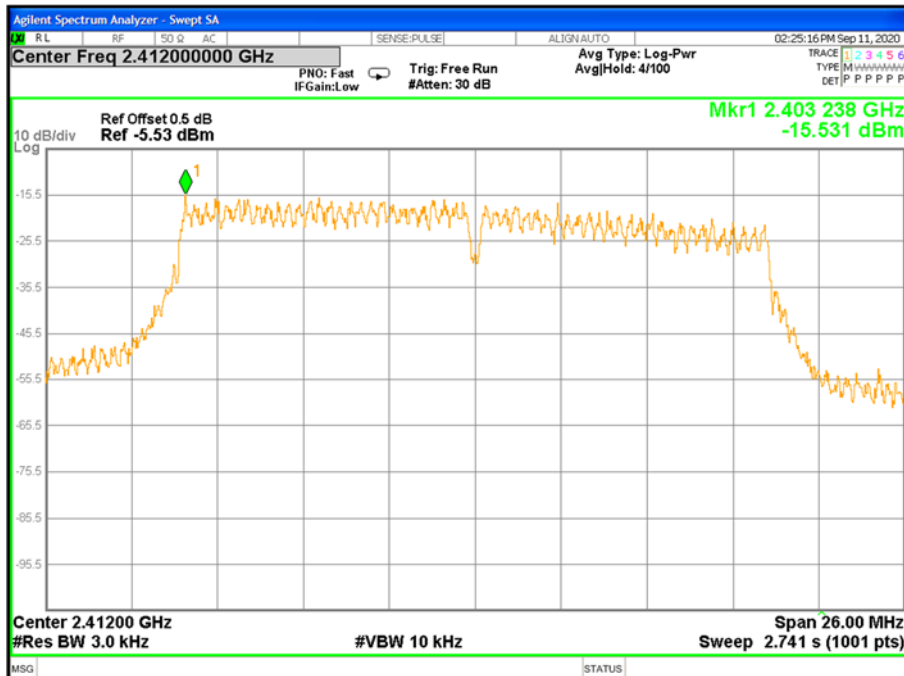



### TX CH06

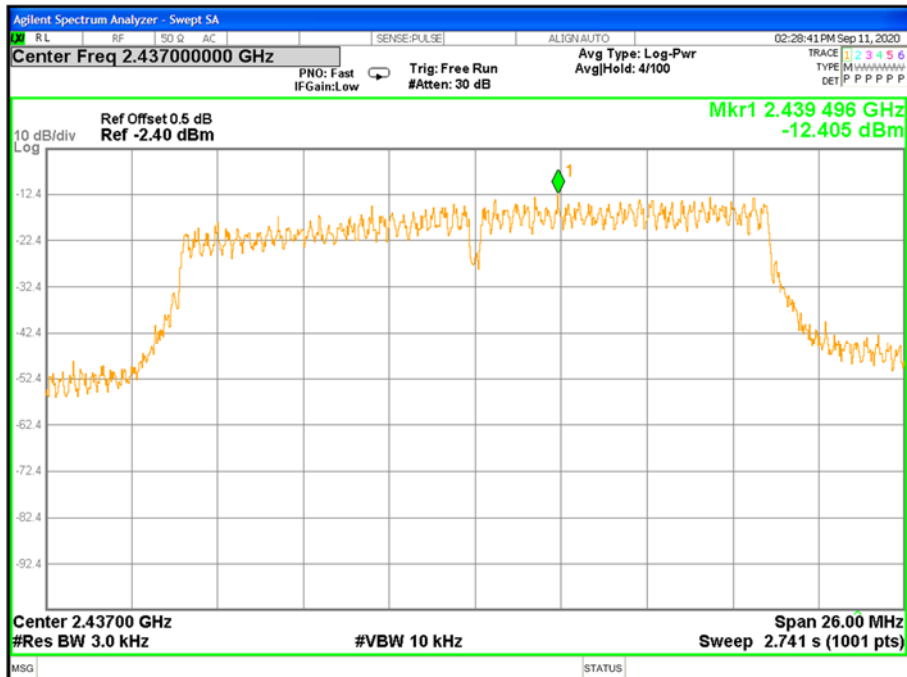

### TX CH11

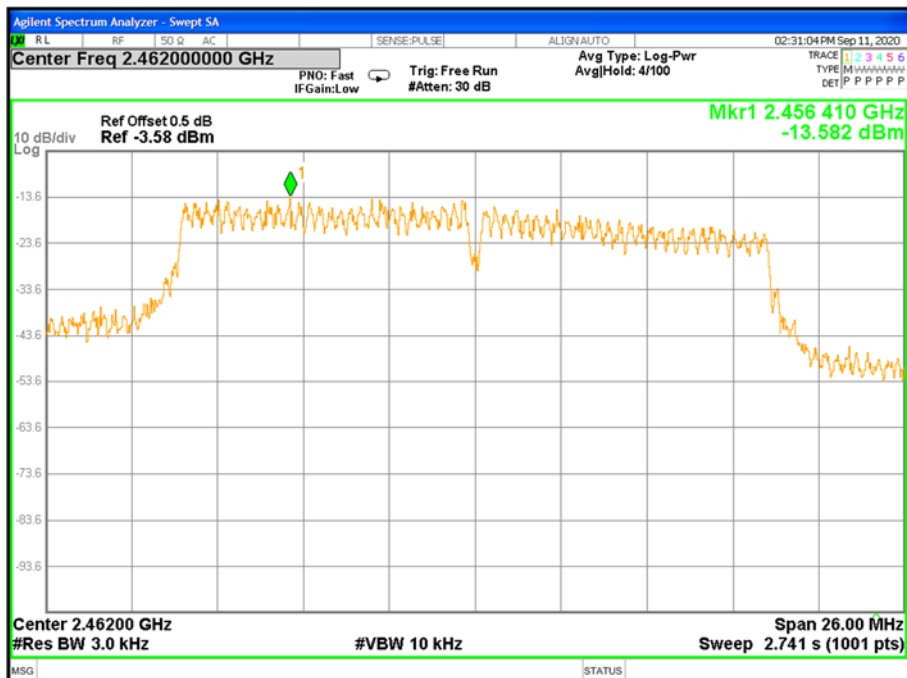



Temperature:	25°C	Relative Humidity:	60%
Test Voltage:	DC 3.7V	Test Mode:	TX n Mode(40M) /CH03, CH06, CH09

Frequency	Power Density	Limit (3KHZ/dBm)	Result
	(dBm/3kHz)		
2422 MHz	-17.5930	≤8	PASS
2437 MHz	-15.3190	≤8	PASS
2452 MHz	-14.1710	≤8	PASS

TX CH03

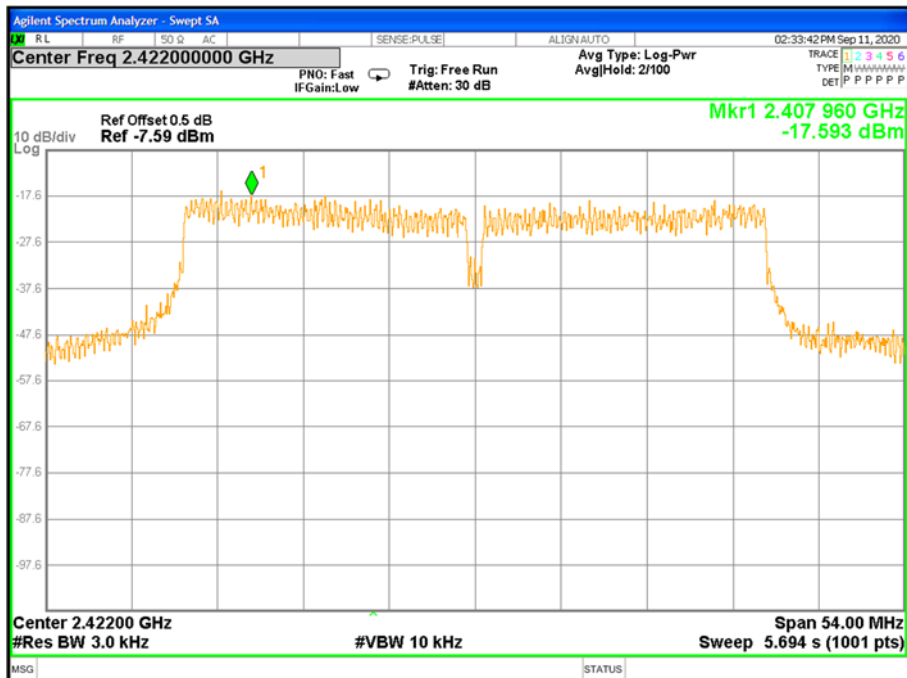



### TX CH06

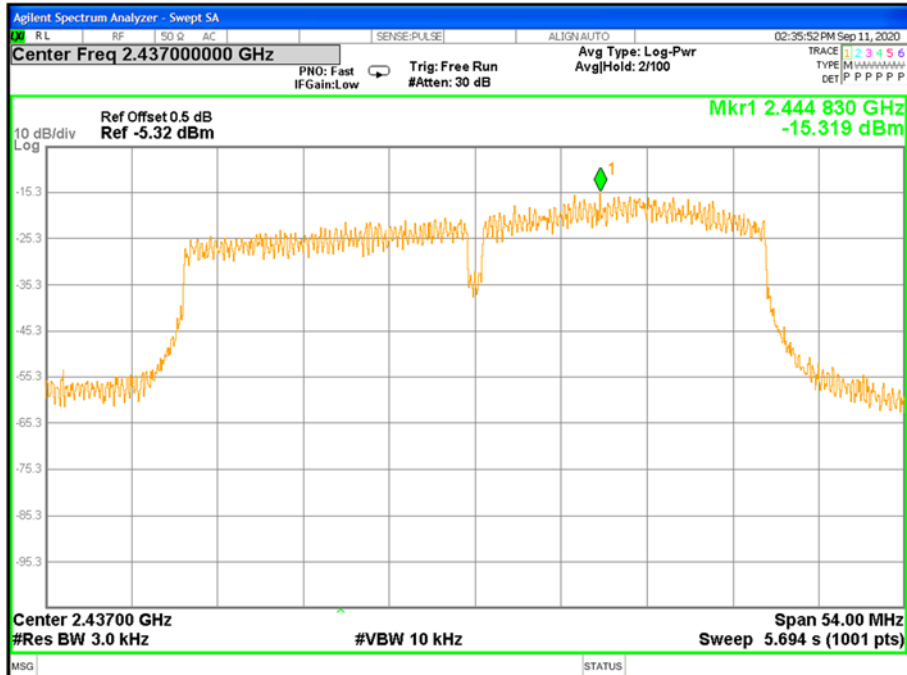

### TX CH09

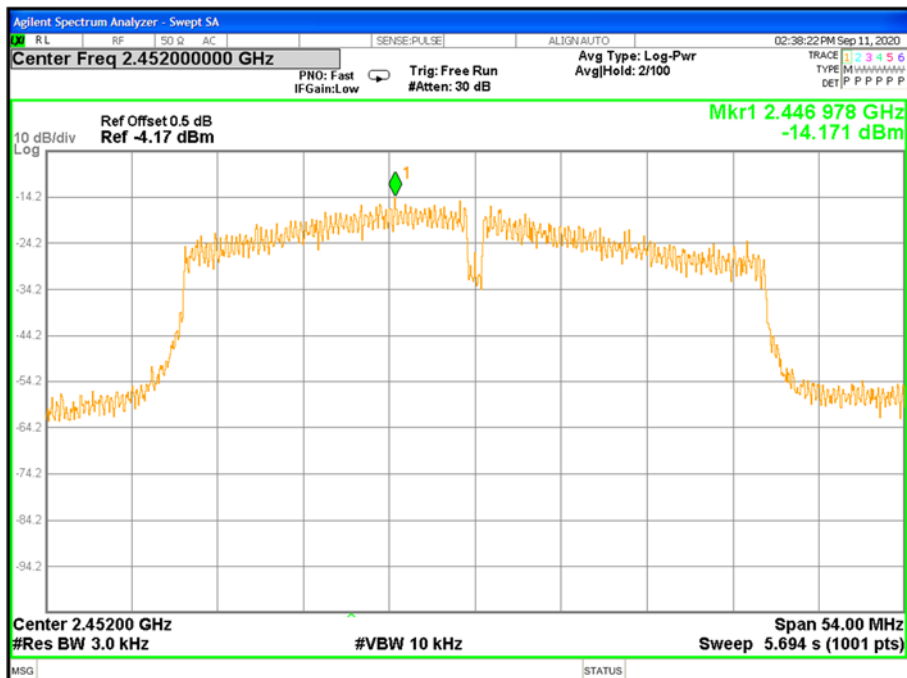



## 6. BANDWIDTH TEST

### 6.1 LIMIT

FCC Part15.247,Subpart C				
Section	Test Item	Limit	Frequency Range (MHz)	Result
15.247(a)(2)	Bandwidth	≥500KHz (6dB bandwidth)	2400-2483.5	PASS

### 6.2 TEST PROCEDURE

The automatic bandwidth measurement capability of an instrument may be employed using the X dB bandwidth mode with X set to 6 dB, if the functionality described above (i.e., RBW = 100 kHz, VBW≥3RBW, peak detector with maximum hold) is implemented by the instrumentation function. When using this capability, care shall be taken so that the bandwidth measurement is not influenced by any intermediate power nulls in the fundamental emission that might be ≥6 dB.

### 6.3 DEVIATION FROM STANDARD

No deviation.

### 6.4 TEST SETUP



### 6.5 EUT OPERATION CONDITIONS

Please refer to section 3.1.4 of this report.



6.6 TEST RESULTS

Temperature:	25°C	Relative Humidity:	60%
Test Voltage:	DC 3.7V	Test Mode:	TX b Mode /CH01, CH06, CH11

Remark: PEAK DETECTOR IS USED

Frequency	6dB Bandwidth	Limit	Result
	(MHz)	(KHz)	
2412 MHz	9.088	≥500KHz	PASS
2437 MHz	9.071	≥500KHz	PASS
2462 MHz	9.094	≥500KHz	PASS

TX CH 01

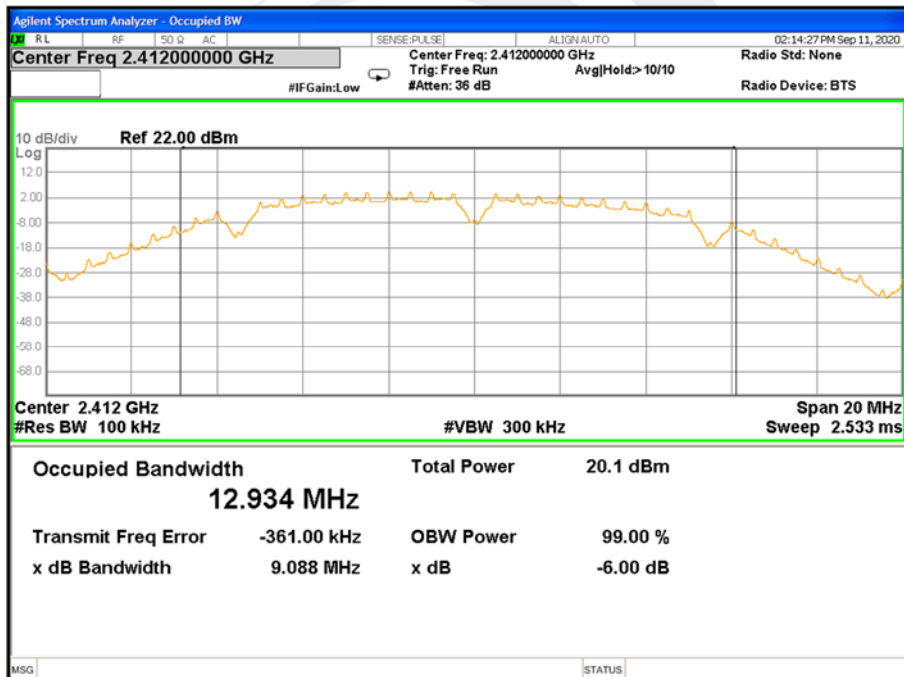



### TX CH 06

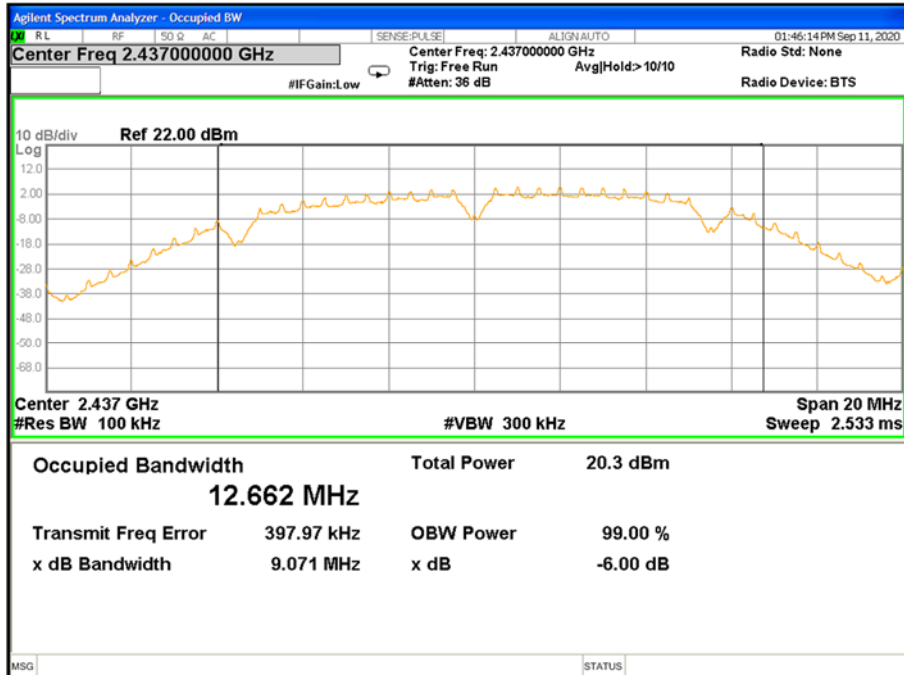

### TX CH 11

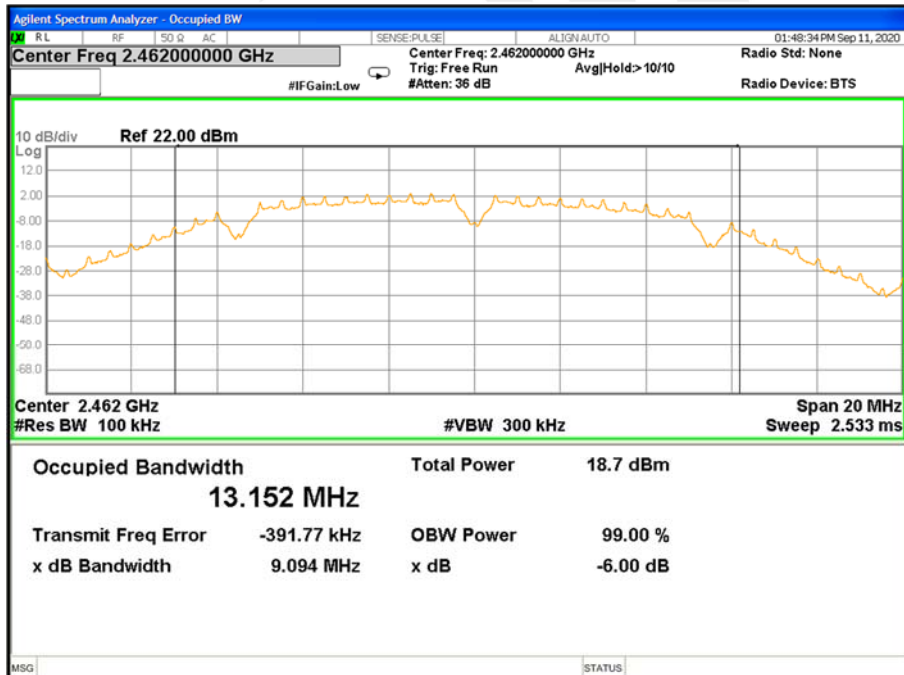



Temperature:	25°C	Relative Humidity:	60%
Test Voltage:	DC 3.7V	Test Mode:	TX g Mode /CH01, CH06, CH11

Frequency	6dB Bandwidth	Limit	Result
	(MHz)	(KHz)	
2412 MHz	15.71	≥500KHz	PASS
2437 MHz	14.50	≥500KHz	PASS
2462 MHz	15.76	≥500KHz	PASS

**TX CH 01**

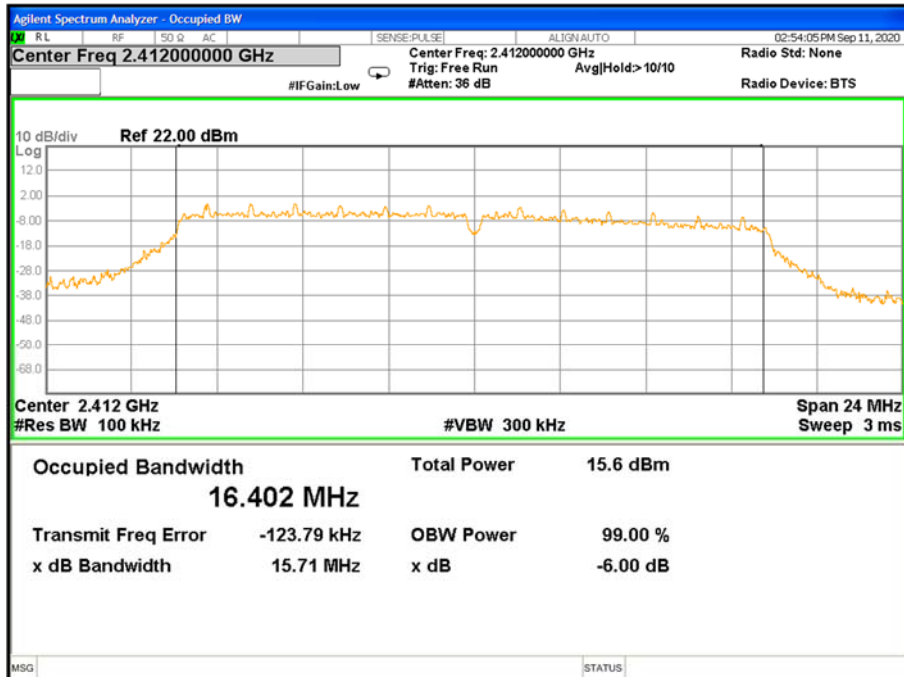



TX CH 06

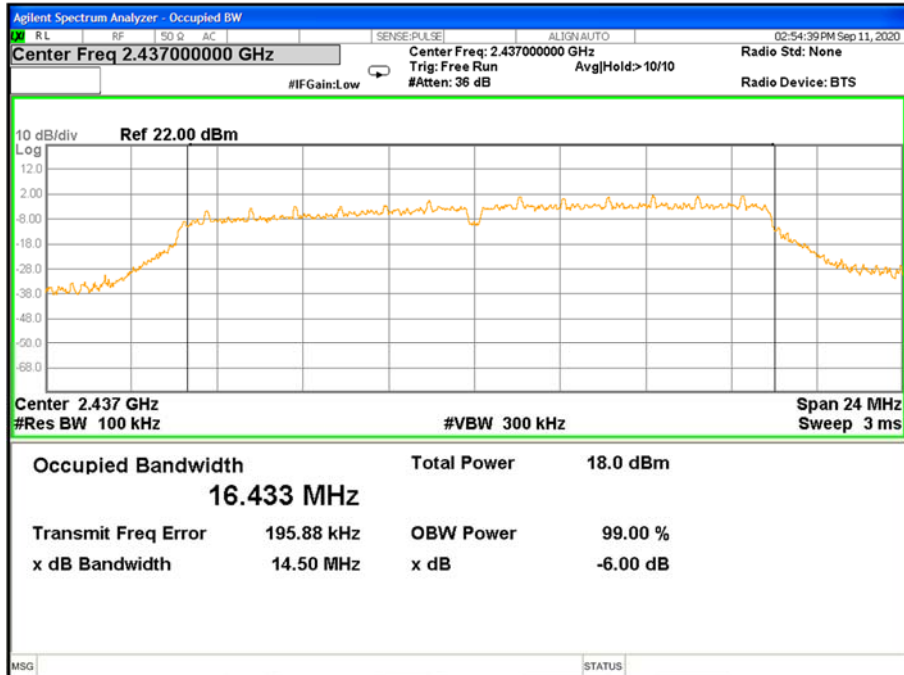

TX CH 11

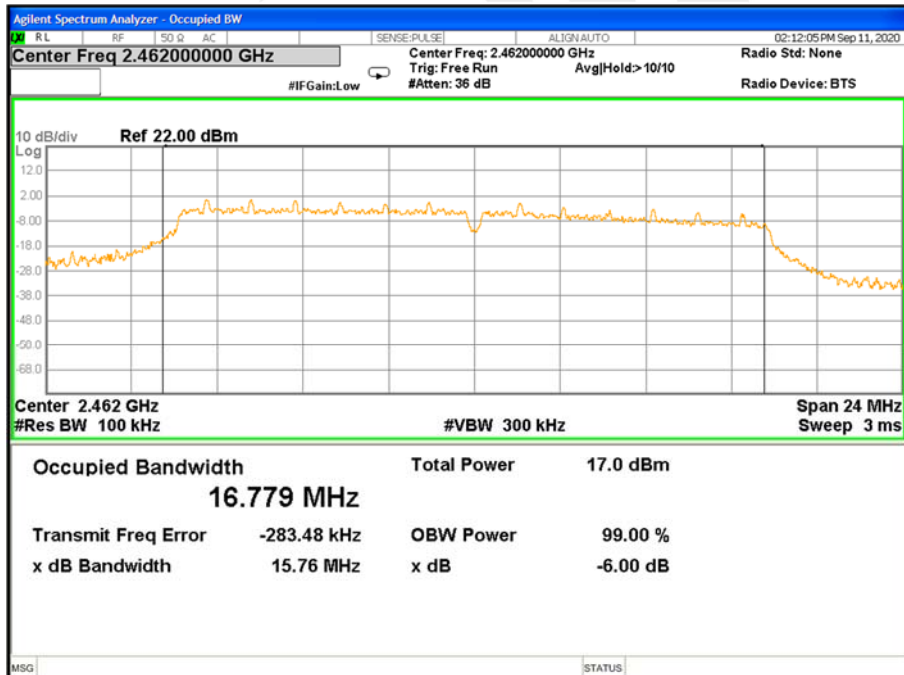



Temperature:	25°C	Relative Humidity:	60%
Test Voltage:	DC 3.7V	Test Mode:	TX n Mode(20M) /CH01, CH06, CH11

Frequency	6dB Bandwidth	Limit	Result
	(MHz)	(KHz)	
2412 MHz	16.31	≥500KHz	PASS
2437 MHz	16.35	≥500KHz	PASS
2462 MHz	16.34	≥500KHz	PASS

**TX CH 01**

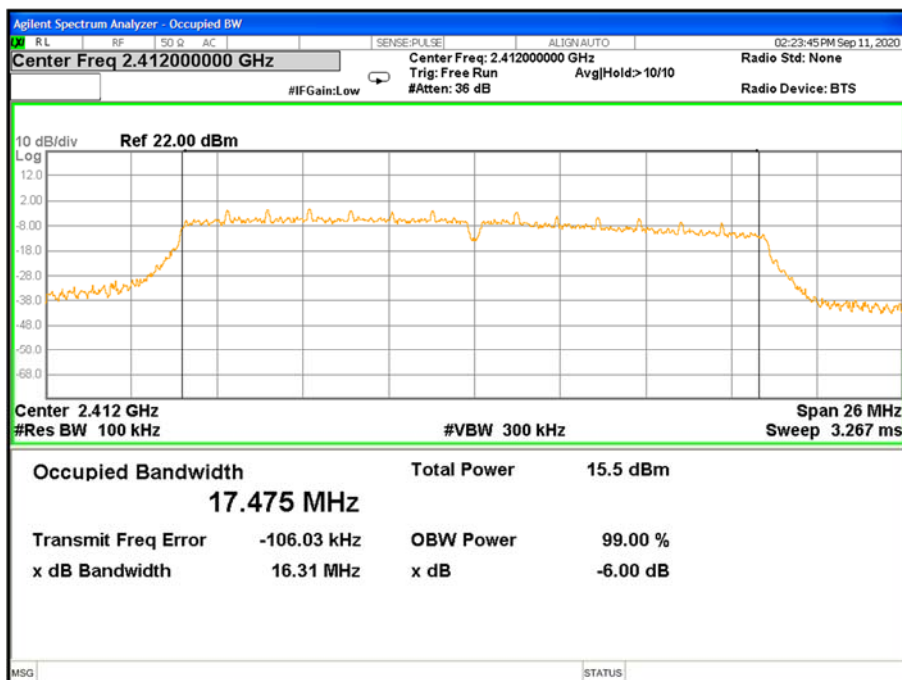



### TX CH 06

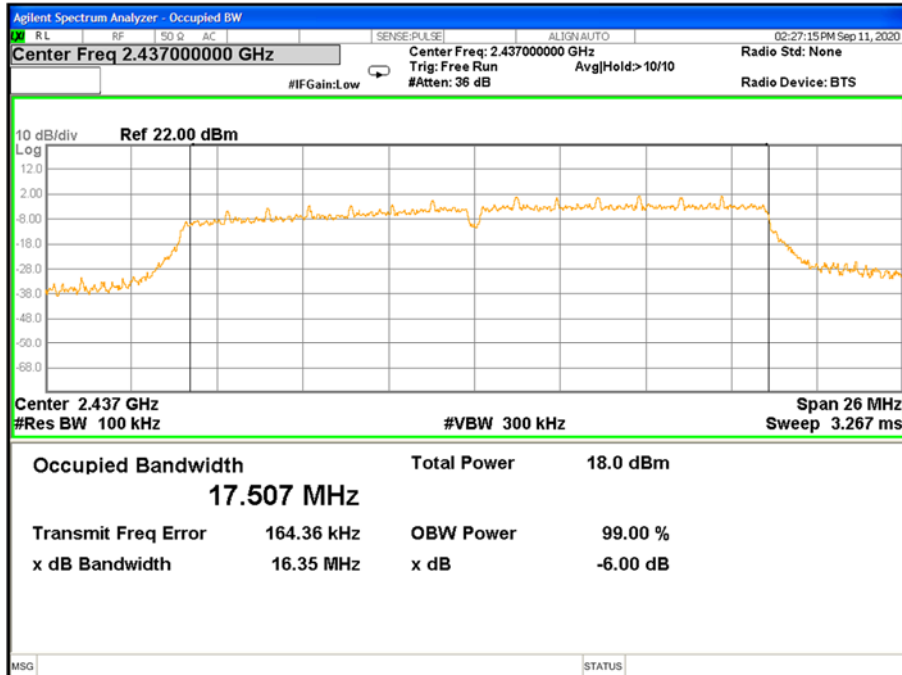

### TX CH 11

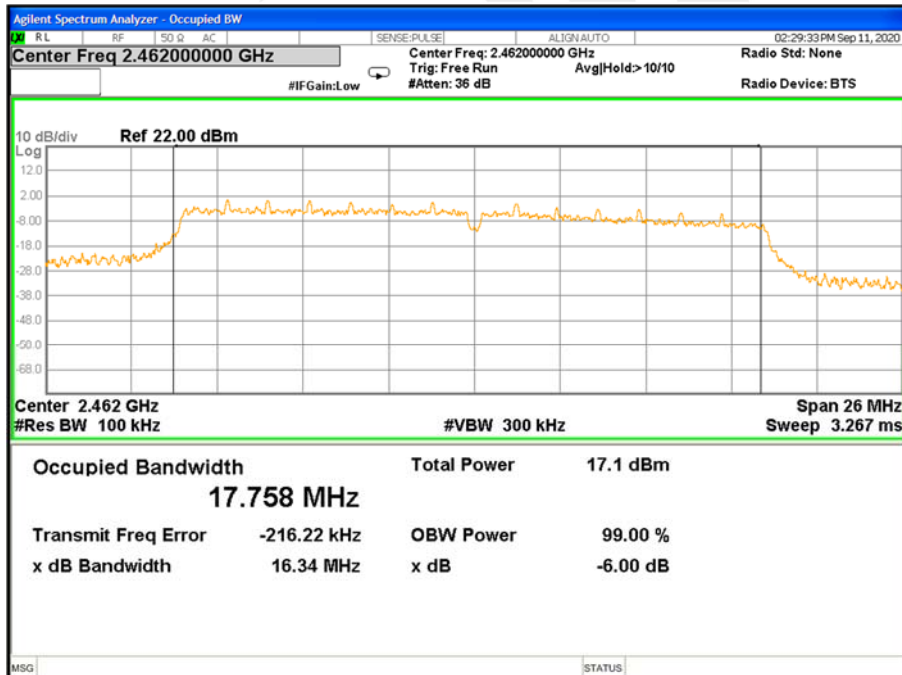



Temperature:	25°C	Relative Humidity:	60%
Test Voltage:	DC 3.7V	Test Mode:	TX n Mode(40M) /CH03, CH06, CH09

Frequency	6dB Bandwidth	Limit	Result
	(MHz)	(KHz)	
2422 MHz	35.94	≥500KHz	PASS
2437 MHz	20.09	≥500KHz	PASS
2452 MHz	17.58	≥500KHz	PASS

**TX CH 03**

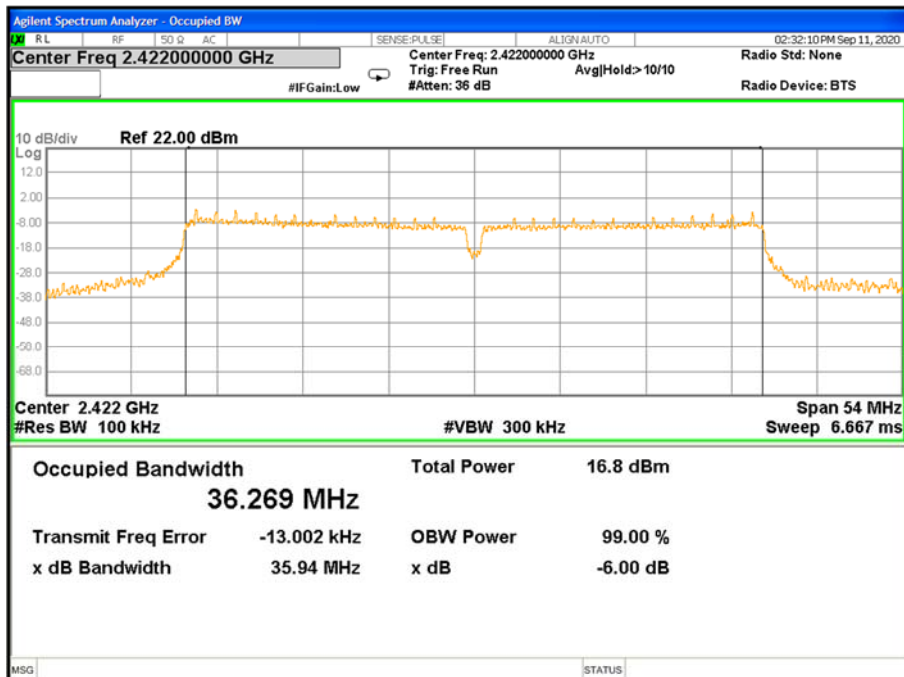





### TX CH 06

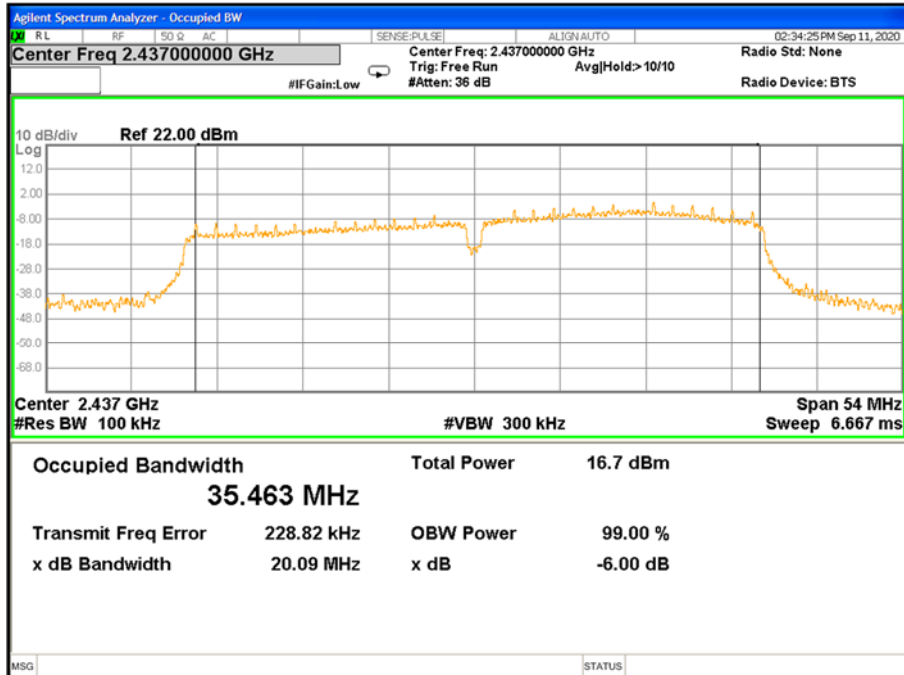

### TX CH 09

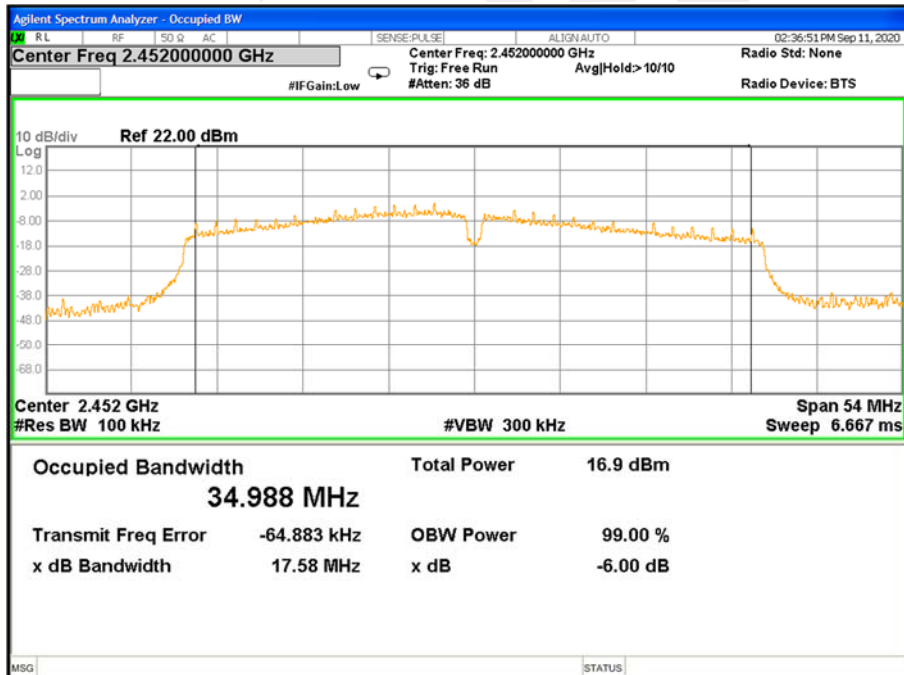

## 7. PEAK OUTPUT POWER TEST

### 7.1 LIMIT

FCC Part15.247,Subpart C				
Section	Test Item	Limit	Frequency Range (MHz)	Result
15.247(b)(3)	Output Power	1 watt or 30dBm	2400-2483.5	PASS

### 7.2 TEST PROCEDURE

This is an RF-conducted test to evaluate maximum peak output power. Use a direct connection between the antenna port of the unlicensed wireless device and the spectrum analyzer, through suitable attenuation. The hopping shall be disabled for this test:

a) Use the following spectrum analyzer settings:

- 1) Span: Approximately five times the 20 dB bandwidth, centered on a hopping channel.
- 2) RBW > 20 dB bandwidth of the emission being measured.
- 3) VBW ≥ RBW.
- 4) Sweep: Auto.

5) Detector function: Peak.

6) Trace: Max hold.

b) Allow trace to stabilize.

c) Use the marker-to-peak function to set the marker to the peak of the emission.

d) The indicated level is the peak output power, after any corrections for external attenuators and cables.

e) A plot of the test results and setup description shall be included in the test report.

NOTE—A peak responding power meter may be used, where the power meter and sensor system video bandwidth is greater than the occupied bandwidth of the unlicensed wireless device, rather than a spectrum analyzer.

PKPM1 Peak power meter method:

The maximum peak conducted output power may be measured using a broadband peak RF power meter. The power meter shall have a video bandwidth that is greater than or equal to the DSS bandwidth and shall use a fast-responding diode detector.

### 7.3 DEVIATION FROM STANDARD

No deviation.

### 7.4 TEST SETUP

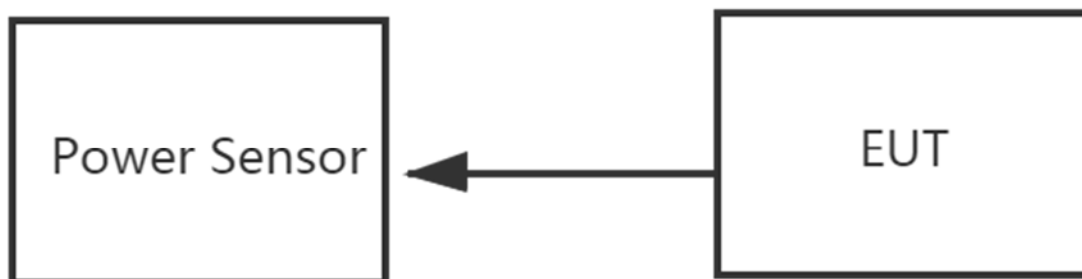

### 7.5 EUT OPERATION CONDITIONS

Please refer to section 3.1.4 of this report.



## 7.6 TEST RESULTS

Temperature:	25°C	Relative Humidity:	60%
Test Voltage:	DC 3.7V		

Mode	Test Channel	Frequency	Peak Conducted Output Power	Average Conducted Output Power	LIMIT
		(MHz)	(dBm)	(dBm)	dBm
TX 802.11b	CH01	2412	15.44	13.48	30
	CH06	2437	16.15	13.60	30
	CH11	2462	14.15	11.74	30
TX 802.11g	CH01	2412	17.13	8.95	30
	CH06	2437	16.06	7.99	30
	CH11	2462	16.78	9.87	30
TX 802.11n20	CH01	2412	17.42	8.99	30
	CH06	2437	17.86	9.38	30
	CH11	2462	15.99	8.05	30
TX 802.11n40	CH03	2422	17.70	9.97	30
	CH06	2437	18.30	10.61	30
	CH09	2452	18.13	10.02	30



## 8. ANTENNA REQUIREMENT

### 8.1 STANDARD REQUIREMENT

15.203 requirement: For intentional device, according to 15.203: an intentional radiator shall be designed to ensure that no antenna other than that furnished by the responsible party shall be used with the device.

### 8.2 EUT ANTENNA

The EUT antenna is PIFA Antenna. It comply with the standard requirement.





## APPENDIX-PHOTOS OF TEST SETUP

Note: See test photos in setup photo document for the actual connections between Product and support equipment.

※※※※※END OF THE REPORT※※※※※

