

TEST REPORT

Report Number:	90249-23-72-23-PP001	
Date of issue	2023.04.26	
Tested by (+signature)	Duke Chen	<i>Duke Chen</i>
Approved by (+signature):	Jason Gao	<i>Jason gao</i>
Testing Laboratory name:	SLG-CPC Testlaboratory Co., Ltd.	
Address	No. 11, Wu Song Road, Dongcheng District, Dongguan, Guangdong Province, China 523117	
Applicant's name	SOLA-MESSWERKZEUGE GMBH	
Address	UNTERES TOBEL 25A-6840 GOTZIS, AUSTRIA	
Manufacturer's name	GEO LASER CO., LTD.	
Address	UNIT A1, 6/F., ONE CAPITAL PLACE, 18 LUARD ROAD, WAN CHAI, HONG KONG	
Factory's name	Dongguan Sndway Electronic Co., Ltd	
Address	58 Humen Tuanjie Road, Humen Town, Dongguan City	
Standard(s)	FCC 47 CFR Part 15, Subpart C	
Test item description:	METRON 30 BT	
Series model:	VECTOR 50	
EUT:	Laser Distance Meter	
Model/Type reference	sola ◆	
FCC ID	2AW48-METRON30BT	
Date of receipt of test item	2023.03.31	
Date (s) of performance of test:	2023.03.31 - 2023.04.12	
Summary of Test Results:	Pass	

The Summary of Test Results based on a technical opinion belongs to the standard(s).

General disclaimer:

This report shall not be reproduced except in full, without the written approval of SLG-CPC Testlaboratory Co., Ltd. The test results in the report only apply to the tested sample.

Table of Contents

1	EUT TECHNICAL DESCRIPTION.....	4
2	SUMMARY OF TEST RESULT	5
3	TEST METHODOLOGY	6
3.1	GENERAL DESCRIPTION OF APPLIED STANDARDS	6
3.2	MEASUREMENT EQUIPMENT USED.....	6
3.3	DESCRIPTION OF TEST MODES	7
4	FACILITIES AND ACCREDITATIONS	8
4.1	FACILITIES	8
4.2	LABORATORY ACCREDITATIONS AND LISTINGS.....	8
5	TEST SYSTEM UNCERTAINTY	9
6	SETUP OF EQUIPMENT UNDER TEST	10
6.1	RADIO FREQUENCY TEST SETUP 1	10
6.2	RADIO FREQUENCY TEST SETUP 2	10
7	TEST REQUIREMENTS.....	12
7.1	DTS 6DB BANDWIDTH.....	12
7.2	MAXIMUM PEAK CONDUCTED OUTPUT POWER.....	15
7.3	MAXIMUM POWER SPECTRAL DENSITY	17
7.4	RADIATED SPURIOUS EMISSION.....	20
7.5	ANTENNA APPLICATION.....	30

Modified Information

Version	Report No.	Revision Data	Summary
Ver.1.0	90249-23-72-23-PP001	2023-04-26	Original Version

1 EUT TECHNICAL DESCRIPTION

Product:	Laser Distance Meter
Model Number:	METRON 30 BT, VECTOR 50
Power supply:	DC 3.0V From Battery
Modulation:	BLE
Frequency Range:	2402MHz~2480MHz
Number of Channels:	40channels
Channel Space:	1MHz
Antenna Gain:	2.04dBi
Antenna:	PCB Antenna
Temperature Range:	0°C ~ +45°C

Note: for more details, please refer to the User's manual of the EUT.

2 SUMMARY OF TEST RESULT

FCC Part Clause	Test Parameter	Verdict	Remark
15.247(a)(2)	DTS (6dB) Bandwidth	PASS	
15.247(b)(3)	Maximum Peak Conducted Output Power	PASS	
15.247(e)	Maximum Power Spectral Density Level	PASS	
15.247(d)	Unwanted Emission Into Non-Restricted Frequency Bands	PASS	
15.247(d) 15.209	Radiated Spurious Emission	PASS	
15.207	Conducted Emission Test	N/A	
15.247(b)	Antenna Application	PASS	
	NOTE1: N/A (Not Applicable) NOTE2: According to FCC OET KDB 558074, the report use radiated measurements in the restricted frequency bands. In addition, the radiated test is also performed to ensure the emissions emanating from the device cabinet also comply with the applicable limits. 15.207 only signals conducted onto the AC power lines are required to be measured. The equipment is only DC power supply, so "Power Line Conducted Emissions" is not required.		

RELATED SUBMITTAL(S) / GRANT(S):

This submittal(s) (test report) is intended for FCC ID: 2AW48-METRON30BT filing to comply with Section 15.247 of the FCC Part 15, Subpart C Rules.

3 TEST METHODOLOGY

3.1 GENERAL DESCRIPTION OF APPLIED STANDARDS

According to its specifications, the EUT must comply with the requirements of the following standards:

FCC 47 CFR Part 2, Subpart J

FCC 47 CFR Part 15, Subpart C

FCC KDB 558074 D01 15.247 Meas Guidance v05r02

3.2 MEASUREMENT EQUIPMENT USED

Equipment	Model	Manufacturer	S/N	Last Cal.	DUE Cal.
RF Connected Test					
Vector Signal Generater	Rohde & Schwarz	SMBV100B(6G)	101166	2022/06/29	1 year
Analog Signal Generator	Rohde & Schwarz	SMB100A(40G)	181333	2022/06/29	1 year
Signal Analyzer	Rohde & Schwarz	FSV40	101527	2023/03/29	1 year
Power Analyzer	Rohde & Schwarz	OSP-B157W8	N/A	2022/06/29	1 year
Wideband Radio Communication Tester	R&S	CMW270	101985	2022/07/05	1 year
Wideband Radio Communication Tester	Rohde & Schwarz	CMW500	166898	2022/07/14	1 year
Spectrum Analyzer	Agilent	E4408B	MY44211139	2022/11/07	1 year
Radiated Emission Test					
EMI Test Receiver	KEYSIGHT	N9010A	MY56070465	2022/12/07	1 year
EMI Test Receiver	Rohde & Schwarz	FSV40	101511	2023/03/29	1 year
Bilog Antenna	Schwarzbeck	VULB 9163	01335	2020/04/28	3 year
Power Amplifier	EMEC	EM330	060676	2022/12/07	3 year
Cable	Tuyue	F4309	L-400-NmNm-12000	2022/12/07	1 year
Horn Antenna	Schwarzbeck	BBHA9120D	1779	2022/04/21	3 year
Horn Antenna	Schwarzbeck	BBHA9170	00954	2022/09/13	3 year
Power Amplifier	Rohde & Schwarz	SCU-18F	180118	2022/04/21	3 year
Active Loop Antenna	ETS LINDGREN	6512	41623	2022/04/23	3 year
Test Software	Farad	EZ-EMC	Ver.CPC-3A1	/	/
Conducted Emission Test					
LISN	Schwarzbeck	NSLK 8127	8127-892	2023/03/21	1 year
LISN	Schwarzbeck	NSLK 8127	8127-437	2022/12/07	1 year
EMI Test Receiver	R&S	ESR3	102124	2022/12/07	1 year
Pulse Limiter	R&S	ESH3-Z2	357.8810.52	2023/03/21	1 year
Test Software	Farad	EZ-EMC	Ver.CPC-3A1	/	/

3.3 DESCRIPTION OF TEST MODES

The EUT has been tested under its typical operating condition.

The EUT configuration for testing is installed on RF field strength measurement to meet the Commissions requirement and operating in a manner which intends to maximize its emission characteristics in a continuous normal application.

The Transmitter was operated in the normal operating mode. The TX frequency was fixed which was for the purpose of the measurements.

Test of channel included the lowest and middle and highest frequency to perform the test, then record on this report.

Those data rates (BLE :1Mbps) were used for all test.

Pre-defined engineering program for regulatory testing used to control the EUT for staying in continuous transmitting and receiving mode is programmed.

Frequency and Channel list for BLE:

Channel	Frequency (MHz)	Channel	Frequency (MHz)	Channel	Frequency (MHz)
0	2402	19	2440
1	2404	20	2442	37	2476
2	2406	21	2444	38	2478
...	39	2480

Note: $f_c = 2402\text{MHz} + k \times 1\text{MHz}$ $k=1$ to 39

Test Frequency and channel for BLE:

Lowest Frequency		Middle Frequency		Highest Frequency	
Channel	Frequency (MHz)	Channel	Frequency (MHz)	Channel	Frequency (MHz)
0	2402	19	2440	39	2480

4 FACILITIES AND ACCREDITATIONS

4.1 FACILITIES

All measurement facilities used to collect the measurement data are located at

No. 11, Wu Song Road, Dongcheng District, Dongguan, Guangdong Province, China 523117

The sites are constructed in conformance with the requirements of ANSI C63.4, ANSI C63.10 and CISPR Publication 32.

4.2 LABORATORY ACCREDITATIONS AND LISTINGS

Site Description	:	
EMC Lab.	:	Accredited by ISED, October 04 2021 CAB identifier: CN0126 Company Number: 27767 Accredited by A2LA, October 04 2021 The Certificate Registration Number is 6325.01
Name of Firm	:	SLG-CPC Testlaboratory Co., Ltd.
Site Location	:	No. 11, Wu Song Road, Dongcheng District, Dongguan, Guangdong Province, China 523117

5 TEST SYSTEM UNCERTAINTY

The following measurement uncertainty levels have been estimated for tests performed on the apparatus:

Parameter	Uncertainty
Radio Frequency	$\pm 1 \times 10^{-5}$
Maximum Peak Output Power Test	$\pm 1.0\%$
Conducted Emissions Test	$\pm 3.08\text{dB}$
Radiated Emission Test	$\pm 4.60\text{dB}$
Power Density	$\pm 0.9\%$
Occupied Bandwidth Test	$\pm 2.3\%$
Band Edge Test	$\pm 1.2\%$
Antenna Port Emission	$\pm 3\text{dB}$
Temperature	$\pm 3.2\%$
Humidity	$\pm 2.5\%$

Measurement Uncertainty for a level of Confidence of 95%

6 SETUP OF EQUIPMENT UNDER TEST

6.1 RADIO FREQUENCY TEST SETUP 1

The BLE component's antenna ports(s) of the EUT are connected to the measurement instrument per an appropriate attenuator. The EUT is controlled by PC/software to emit the specified signals for the purpose of measurements.



6.2 RADIO FREQUENCY TEST SETUP 2

The test site semi-anechoic chamber has met the requirement of NSA tolerance 4 dB according to the standards: ANSI C63.10. The test distance is 3m. The setup is according to the requirements in Section 13.1.4.1 of ANSI C63.10-2013 and CAN/CSA-CEI/IEC CISPR 22.

Below 30MHz:

The EUT is placed on a turntable 0.8 meters above the ground in the chamber, 3 meter away from the antenna (loop antenna). The Antenna should be positioned with its plane vertical at the specified distance from the EUT and rotated about its vertical axis for maximum response at each azimuth about the EUT. The center of the loop shall be 1 m above the ground. For certain applications, the loop antenna plane may also need to be positioned horizontally at the specified distance from the EUT.

30MHz-1GHz:

The EUT is placed on a turntable 0.8 meters above the ground in the chamber, 3 meter away from the antenna. The maximal emission value is acquired by adjusting the antenna height, polarisation and turntable azimuth. Normally, the height range of antenna is 1 m to 4 m, the azimuth range of turntable is 0° to 360°, and the receive antenna has two polarizations Vertical (V) and Horizontal (H).

Above 1GHz:

The EUT is placed on a turntable 1.5 meters above the ground in the chamber, 3 meter away from the antenna. The maximal emission value is acquired by adjusting the antenna height, polarisation and turntable azimuth. Normally, the height range of antenna is 1 m to 4 m, the azimuth range of turntable is 0° to 360°, and the receive antenna has two polarizations Vertical (V) and Horizontal (H).

(a) Radiated Emission Test Set-Up, Frequency Below 30MHz

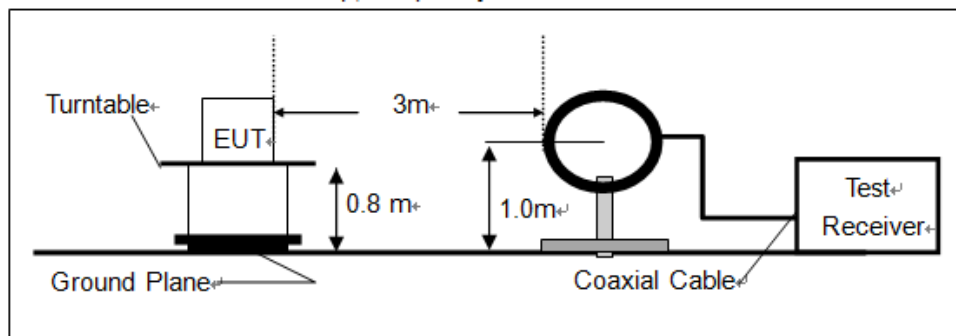

(b) Radiated Emission Test Set-Up, Frequency Below 1000MHz

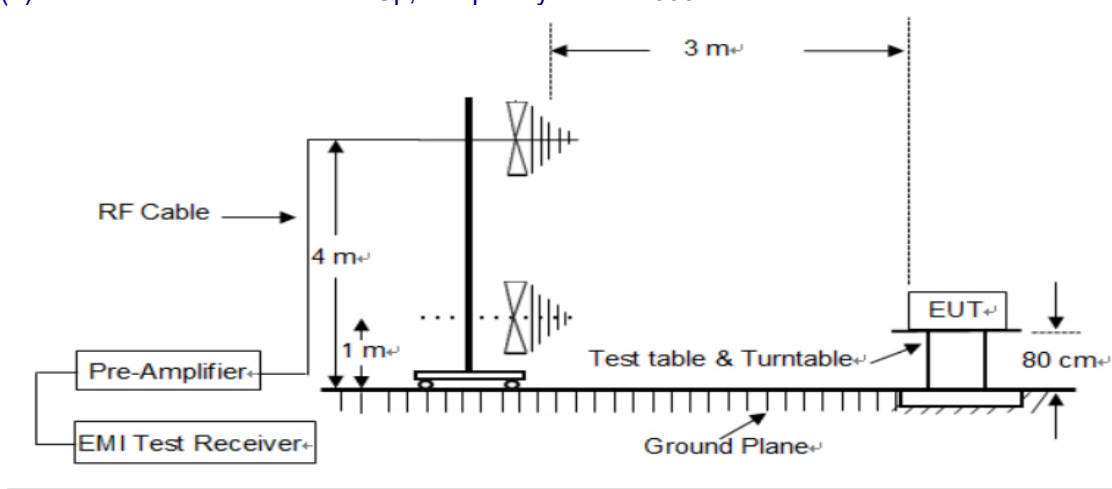

(c) Radiated Emission Test Set-Up, Frequency above 1000MHz

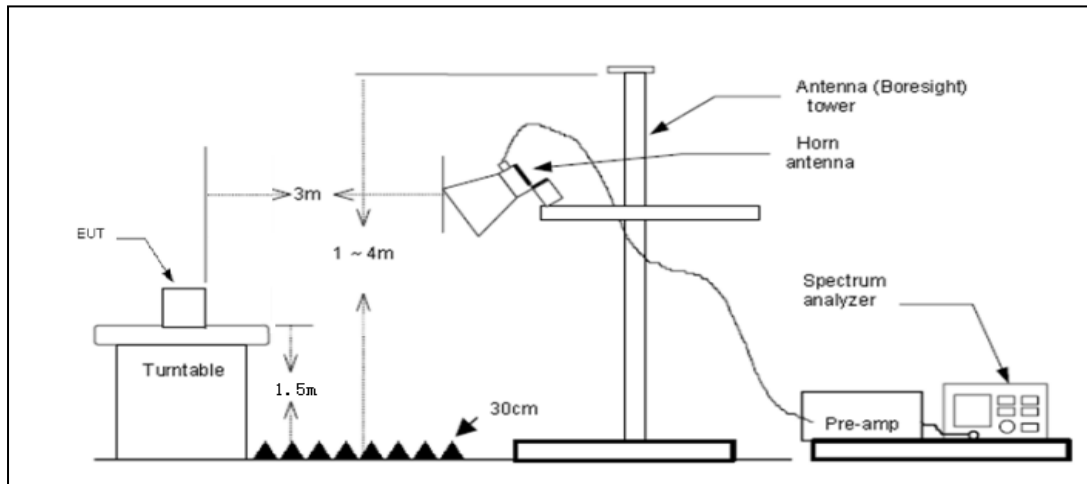

7 TEST REQUIREMENTS

7.1 DTS 6DB BANDWIDTH

7.1.1 Applicable Standard

According to FCC Part 15.247(a)(2) and KDB 558074 D01 15.247 Meas Guidance v05r02

7.1.2 Conformance Limit

The minimum -6 dB bandwidth shall be at least 500 kHz.

7.1.3 Test Configuration

Test according to clause 7.1 radio frequency test setup 1

7.1.4 Test Procedure

The EUT was operating in BLE mode and controlled its channel. Printed out the test result from the spectrum by hard copy function.

The RF output of EUT was connected to the spectrum analyzer by RF cable and attenuator. The path loss was compensated to the results for each measurement.

Set to the maximum power setting and enable the EUT transmit continuously

Set RBW = 100 kHz.

Set the video bandwidth (VBW) =300 kHz.

Set Span=2 times OBW

Set Detector = Peak.

Set Trace mode = max hold.

Set Sweep = auto couple.

Allow the trace to stabilize.

Measure the maximum width of the emission that is constrained by the frequencies associated with the two outermost amplitude points (upper and lower frequencies) that are attenuated by 6 dB relative to the maximum level measured in the fundamental emission.

Measure and record the results in the test report.

Test Results

Temperature:	23° C
Relative Humidity:	54%
ATM Pressure:	1011 mbar

Operation Mode	Channel Number	Channel Frequency (MHz)	Measurement Bandwidth (MHz)	Limit (kHz)	Verdict
BLE	0	2402	0.748	>500	PASS
	19	2440	0.741	>500	PASS
	39	2480	0.754	>500	PASS

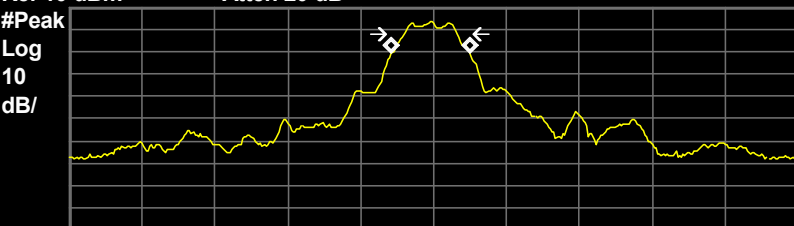
DTS (6dB) Bandwidth	
Test Model	BLE
Channel 0: 2402MHz	
<div style="display: flex; justify-content: space-between;"> Agilent Freq/Channel </div>	
<div style="display: flex; justify-content: space-between;"> Ch Freq 2.402 GHz Trig Free </div>	
<div style="display: flex; justify-content: space-between;"> Occupied Bandwidth </div>	
<div style="display: flex; justify-content: space-between;"> Ref 10 dBm Atten 20 dB </div>	
	
<div style="display: flex; justify-content: space-between;"> Center 2.402 GHz Span 10 MHz </div>	
<div style="display: flex; justify-content: space-between;"> #Res BW 100 kHz #VBW 300 kHz Sweep 4 ms (401 pts) </div>	
<div style="display: flex; justify-content: space-between;"> <div style="text-align: center;"> <p>Occupied Bandwidth</p> <p>1.0683 MHz</p> </div> <div> <p>Occ BW % Pwr 99.00 %</p> <p>x dB -6.00 dB</p> </div> </div>	
<div style="display: flex; justify-content: space-between;"> Transmit Freq Error -35.929 kHz </div>	
<div style="display: flex; justify-content: space-between;"> x dB Bandwidth 748.410 kHz </div>	
<div style="display: flex; justify-content: space-between;"> Freq/Channel </div>	
<div style="display: flex; justify-content: space-between;"> Center Freq 2.40200000 GHz </div>	
<div style="display: flex; justify-content: space-between;"> Start Freq 2.39700000 GHz </div>	
<div style="display: flex; justify-content: space-between;"> Stop Freq 2.40700000 GHz </div>	
<div style="display: flex; justify-content: space-between;"> CF Step 1.00000000 MHz </div>	
<div style="display: flex; justify-content: space-between;"> Freq Offset 0.00000000 Hz </div>	
<div style="display: flex; justify-content: space-between;"> Signal Track On Off </div>	

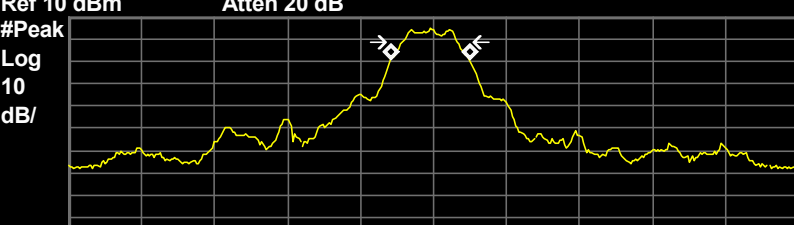
DTS (6dB) Bandwidth	
Test Model	BLE
Channel 19: 2440MHz	
<div style="display: flex; justify-content: space-between;"> Agilent Freq/Channel </div>	
<div style="display: flex; justify-content: space-between;"> Ch Freq 2.44 GHz Trig Free </div>	
<div style="display: flex; justify-content: space-between;"> Occupied Bandwidth </div>	
<div style="display: flex; justify-content: space-between;"> Ref 10 dBm Atten 20 dB </div>	
	
<div style="display: flex; justify-content: space-between;"> Center 2.44 GHz Span 10 MHz </div>	
<div style="display: flex; justify-content: space-between;"> #Res BW 100 kHz #VBW 300 kHz Sweep 4 ms (401 pts) </div>	
<div style="display: flex; justify-content: space-between;"> <div style="text-align: center;"> <p>Occupied Bandwidth</p> <p>1.0646 MHz</p> </div> <div> <p>Occ BW % Pwr 99.00 %</p> <p>x dB -6.00 dB</p> </div> </div>	
<div style="display: flex; justify-content: space-between;"> Transmit Freq Error -44.226 kHz </div>	
<div style="display: flex; justify-content: space-between;"> x dB Bandwidth 741.417 kHz </div>	
<div style="display: flex; justify-content: space-between;"> Freq/Channel </div>	
<div style="display: flex; justify-content: space-between;"> Center Freq 2.44000000 GHz </div>	
<div style="display: flex; justify-content: space-between;"> Start Freq 2.43500000 GHz </div>	
<div style="display: flex; justify-content: space-between;"> Stop Freq 2.44500000 GHz </div>	
<div style="display: flex; justify-content: space-between;"> CF Step 1.00000000 MHz </div>	
<div style="display: flex; justify-content: space-between;"> Freq Offset 0.00000000 Hz </div>	
<div style="display: flex; justify-content: space-between;"> Signal Track On Off </div>	

	DTS (6dB) Bandwidth BLE
Test Model	Channel 39: 2480MHz

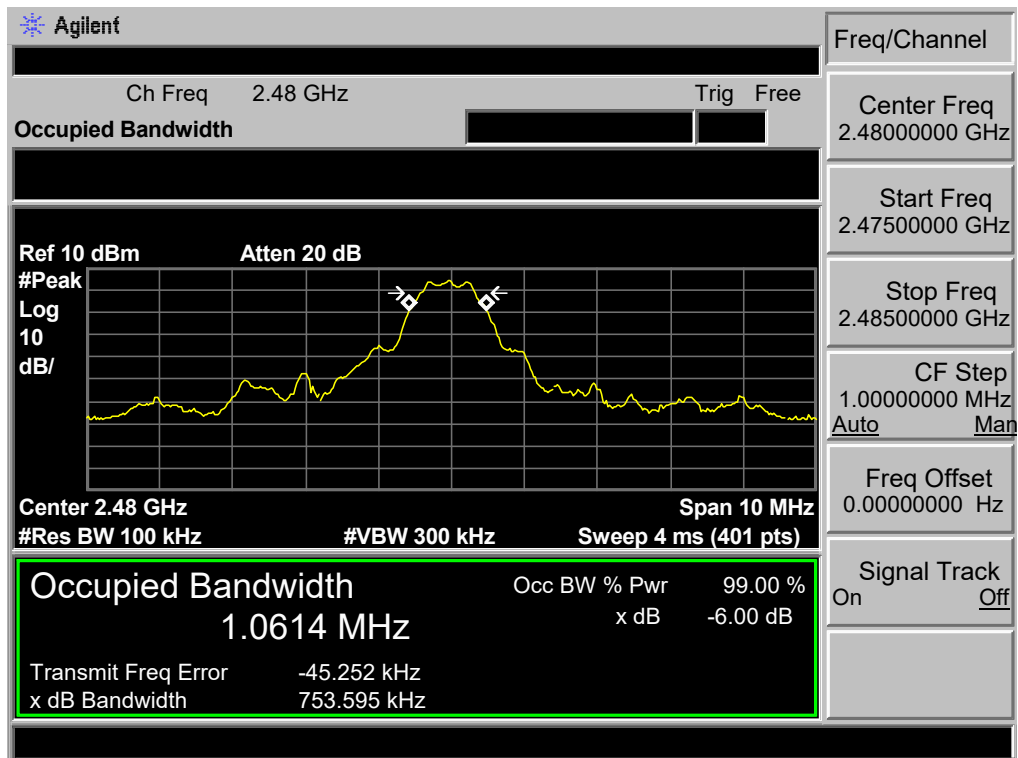

7.2 MAXIMUM PEAK CONDUCTED OUTPUT POWER

7.2.1 Applicable Standard

According to FCC Part 15.247(b)(3) and KDB 558074 D01 15.247 Meas Guidance v05r02

7.2.2 Conformance Limit

The maximum peak conducted output power of the intentional radiator for systems using digital modulation in the 2400 - 2483.5 MHz bands shall not exceed: 1 Watt (30dBm).

7.2.3 Test Configuration

Test according to clause 7.1 radio frequency test setup 1

7.2.4 Test Procedure

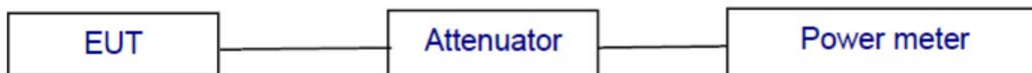

■ According to FCC Part 15.247(b)(3)

As an alternative to a peak power measurement, compliance with the one Watt limit can be based on a measurement of the maximum conducted output power. For smart system, Maximum Conducted Output Power is defined as the total transmit power delivered to all antennas and antenna elements averaged across all symbols in the signaling alphabet when the transmitter is operating at its maximum power control level. Power must be summed across all antennas and antenna elements. If multiple modes of operation are possible (e.g., alternative modulation methods), the maximum conducted output power is the highest total transmit power occurring in any mode.

Set the RBW \cong DTS bandwidth (about 1MHz).

Set VBW = 3*RBW (about 3MHz)

Set the span \cong 3*RBW

Set Sweep time = auto couple.

Set Detector = peak.

Set Trace mode = max hold.

Allow trace to fully stabilize. Use peak marker function to determine the peak amplitude level.

■ According to FCC Part 15.247(b)(4):

Conducted output power limit specified in paragraph (b) of this section is based on the use of antennas with directional gains that do not exceed 6 dBi. If transmitting antennas of directional gain greater than 6 dBi are used, the conducted output power from the intentional radiator shall be reduced below the stated values in paragraphs (b)(3) of this section, as appropriate, by the amount in dB that the directional gain of the antenna exceeds 6 dBi.

Place the EUT on the desktop and set it to launch mode. Remove the antenna from the EUT and connect the low-loss RF cable from the antenna port to the power meter. Measure the peak power of each channel.

Test Results

Temperature:	26° C
Relative Humidity:	54%
ATM Pressure:	1011 mbar

Test Mode	CH	Result (dBm)	Limit (dBm)
BLE(GFSK)	CH0	1.05	30
	CH19	0.87	30
	CH39	0.03	30
Conclusion: PASS			

7.3 MAXIMUM POWER SPECTRAL DENSITY

7.3.1 Applicable Standard

According to FCC Part 15.247(e) and KDB 558074 D01 15.247 Meas Guidance v05r02

7.3.2 Conformance Limit

The transmitter power spectral density conducted from the transmitter to the antenna shall not be greater than 8 dBm in any 3 kHz band during any time interval of continuous transmission.

7.3.3 Test Configuration

Test according to clause 7.1 radio frequency test setup 1

7.3.4 Test Procedure

This procedure shall be used if maximum peak conducted output power was used to demonstrate compliance

The transmitter output (antenna port) was connected to the spectrum analyzer

Set analyzer center frequency to DTS channel center frequency.

Set the span to 1.5 times the DTS bandwidth.

Set the RBW to: 3 kHz

Set the VBW to: 10 kHz.

Set Detector = peak.

Set Sweep time = auto couple.

Set Trace mode = max hold.

Allow trace to fully stabilize.

Use the peak marker function to determine the maximum amplitude level within the RBW.

7.3.5 Test Results

Temperature:	23° C
Relative Humidity:	54%
ATM Pressure:	1011 mbar

Test Mode	CH	Power density (dBm/3kHz)	(dBm/3kHz) Limit Limit
GFSK(BLE)	CH1	-11.13	8
	CH20	-9.89	8
	CH40	-10.31	8
Conclusion: PASS			

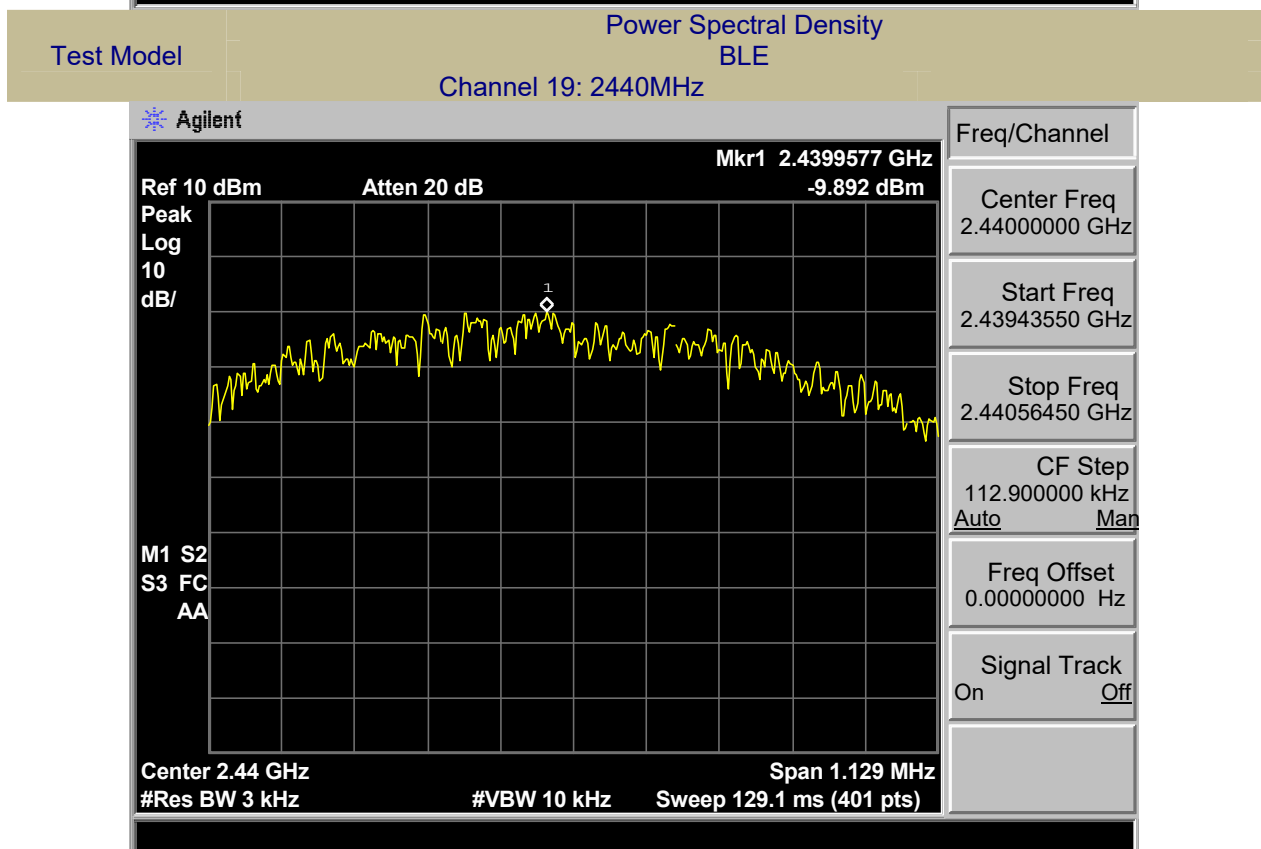
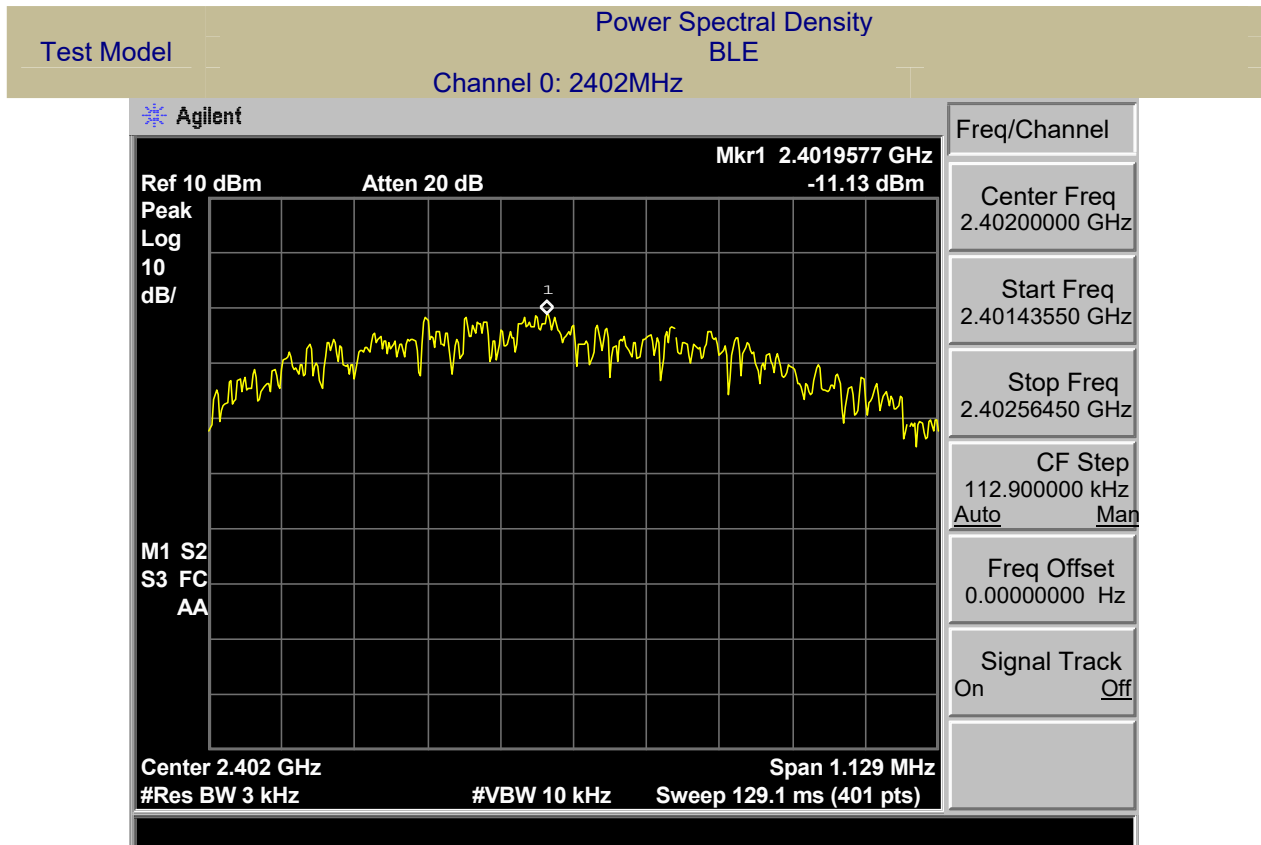

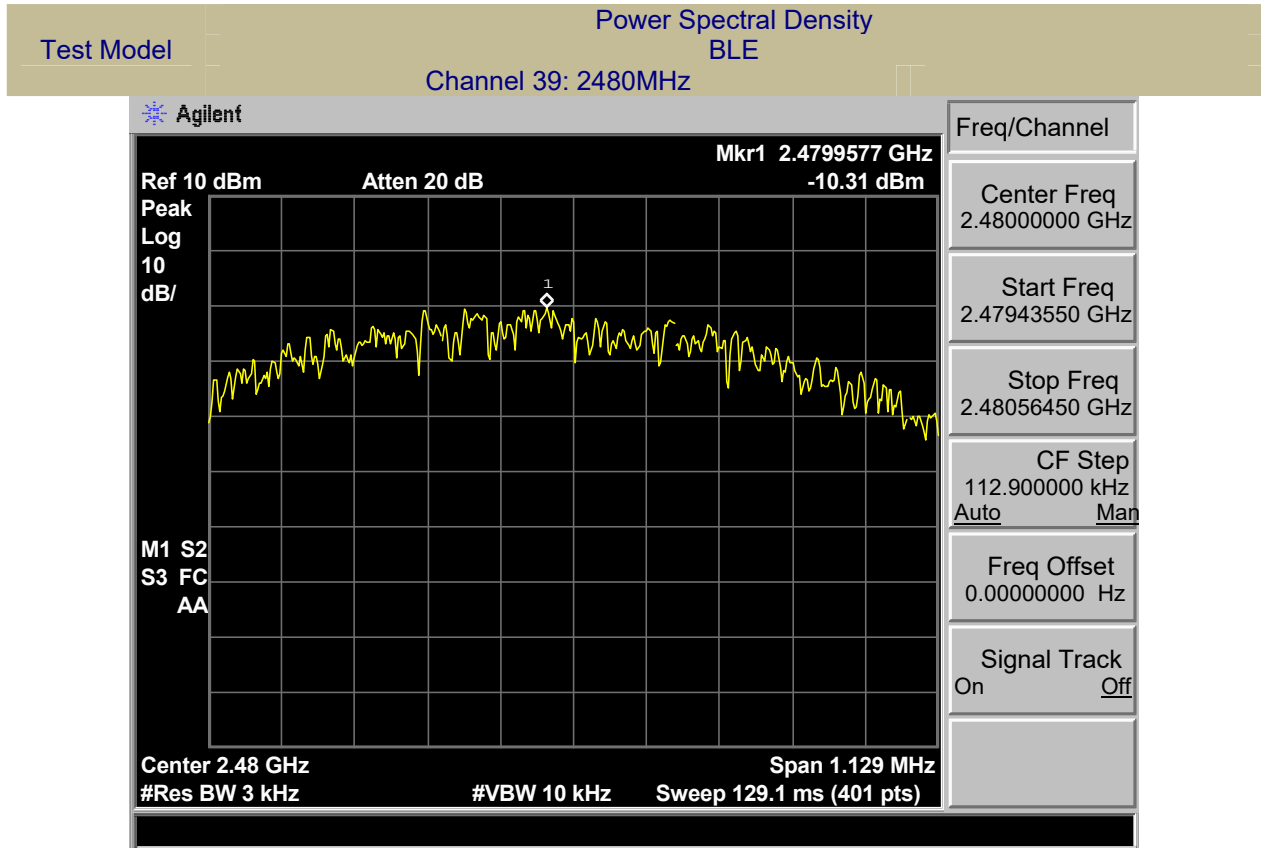

7.4 RADIATED SPURIOUS EMISSION

7.4.1 Applicable Standard

According to FCC Part 15.247(d) and 15.209 and KDB 558074 D01 15.247 Meas Guidance v05r02

7.4.2 Conformance Limit

According to FCC Part 15.247(d): radiated emissions which fall in the restricted bands, as defined in §15.205(a), must also comply with the radiated emission limits specified in §15.209(a) (see §15.205(c)).

According to FCC Part 15.205, Restricted bands

MHz	MHz	MHz	GHz
0.090-0.110	16.42-16.423	399.9-410	4.5-5.15
10.495-0.505	16.69475-16.69525	608-614	5.35-5.46
2.1735-2.1905	16.80425-16.80475	960-1240	7.25-7.75
4.125-4.128	25.5-25.67	1300-1427	8.025-8.5
4.17725-4.17775	37.5-38.25	1435-1626.5	9.0-9.2
4.20725-4.20775	73-74.6	1645.5-1646.5	9.3-9.5
6.215-6.218	74.8-75.2	1660-1710	10.6-12.7
6.26775-6.26825	123-138	2200-2300	14.47-14.5
8.291-8.294	149.9-150.05	2310-2390	15.35-16.2
8.362-8.366	156.52475-156.52525	2483.5-2500	17.7-21.4
8.37625-8.38675	156.7-156.9	2690-2900	22.01-23.12
8.41425-8.41475	162.0125-167.17	3260-3267	23.6-24.0
12.29-12.293	167.72-173.2	3332-3339	31.2-31.8
12.51975-12.52025	240-285	3345.8-3358	36.43-36.5
12.57675-12.57725	322-335.4	3600-4400	(2)
13.36-13.41			

According to FCC Part 15.205, the level of any transmitter spurious emission in Restricted bands shall not exceed the level of the emission specified in the following table

Restricted Frequency(MHz)	Field Strength (μV/m)	Field Strength (dBμV/m)	Measurement Distance
0.009-0.490	2400/F(KHz)	20 log (uV/m)	300
0.490-1.705	2400/F(KHz)	20 log (uV/m)	30
1.705-30	30	29.5	30
30-88	100	40	3
88-216	150	43.5	3
216-960	200	46	3
Above 960	500	54	3

7.4.3 Test Configuration

Test according to clause 7.2 radio frequency test setup 2

7.4.4 Test Procedure

This test is required for any spurious emission that falls in a Restricted Band, as defined in Section 15.205. It must be performed with the highest gain of each type of antenna proposed for use with the EUT. Use the following spectrum analyzer settings:

The EUT was placed on a turn table which is 0.8m above ground plane.

Maximum procedure was performed on the highest emissions to ensure EUT compliance.

Span = wide enough to fully capture the emission being measured

RBW = 1 MHz for $f \geq 1$ GHz(1GHz to 25GHz), 100 kHz for $f < 1$ GHz(30MHz to 1GHz)

VBW \geq RBW

Sweep = auto

Detector function = peak

Trace = max hold

Follow the guidelines in ANSI C63.10-2013 with respect to maximizing the emission by rotating the EUT,

measuring the emission while the EUT is situated in three orthogonal planes (if appropriate), adjusting the measurement antenna height and polarization, etc. A pre-amp and a high pass filter are required for this test, in order to provide the measuring system with sufficient sensitivity. Allow the trace to stabilize. The peak reading of the emission, after being corrected by the antenna factor, cable loss, pre-amp gain, etc., is the peak field strength, which must comply with the limit specified in Section 15.35(b). Submit this data.

Now set the VBW to 10 Hz, while maintaining all of the other instrument settings. This peak level, once corrected, must comply with the limit specified in Section 15.209. If the dwell time per channel of the hopping signal is less than 100 ms, then the reading obtained with the 10 Hz VBW may be further adjusted by a "duty cycle correction factor", derived from $20\log(\text{dwell time}/100 \text{ ms})$, in an effort to demonstrate compliance with the 15.209 limit. Submit this data.

Repeat above procedures until all frequency measured was complete.

7.4.5 Test Results

Temperature:	23° C
Relative Humidity:	54%
ATM Pressure:	1011 mbar

■ Spurious Emission below 30MHz (9KHz to 30MHz)

Freq. (MHz)	Ant.Pol. H/V	Emission Level(dBuV/m)		Limit 3m(dBuV/m)		Over(dB)	
		PK	AV	PK	AV	PK	AV
--	--	--	--	--	--	--	--

Note: the amplitude of spurious emission that is attenuated by more than 20dB below the permissible limit has no need to be reported.

Distance extrapolation factor = $40\log(\text{Specific distance}/ \text{test distance})$ (dB);

Limit line = Specific limits(dBuV) + distance extrapolation factor

- Spurious Emission Above 1GHz (1GHz to 25GHz)
 BLE mode have been tested, and the worst result was report as below:

Test mode: BLE Frequency: Channel 0: 2402MHz

Frequency (MHz)	Meter Reading (dB μ V)	Factor (dB)	Emission Level (dB μ V/m)	Limits (dB μ V/m)	Over (dB)	Detector Type	Ant. Pol.
							H/V
4804.000	58.00	-4.12	53.88	74	-20.12	peak	H
4804.000	47.02	-4.12	42.90	54	-11.10	AVG	H
7206.000	49.66	1.46	51.12	74	-22.88	peak	H
7206.000	39.69	1.46	41.15	54	-12.85	AVG	H
4804.000	59.71	-4.12	55.59	74	-18.41	peak	V
4804.000	46.67	-4.12	42.55	54	-11.45	AVG	V
7206.000	48.31	1.46	49.77	74	-24.23	peak	V
7206.000	39.00	1.46	40.46	54	-13.54	AVG	V

Test mode: BLE Frequency: Channel 19: 2440MHz

Frequency (MHz)	Meter Reading (dB μ V)	Factor (dB)	Emission Level (dB μ V/m)	Limits (dB μ V/m)	Over (dB)	Detector Type	Ant. Pol.
							H/V
4880.000	57.66	-4.03	53.63	74	-20.37	peak	H
4880.000	46.04	-4.03	41.98	54	-12.02	AVG	H
7320.000	48.54	1.66	50.20	74	-23.80	peak	H
7320.000	37.66	1.66	39.32	54	-14.68	AVG	H
4880.000	58.09	-4.03	54.06	74	-19.94	peak	V
4880.000	45.88	-4.03	41.85	54	-12.15	AVG	V
7320.000	47.55	1.66	49.21	74	-24.79	peak	V
7320.000	38.03	1.66	39.69	54	-14.31	AVG	V

Test mode: BLE

Frequency:

Channel 39: 2480MHz

Frequency	Meter Reading	Factor	Emission Level	Limits	Over	Detector Type	Ant. Pol.
(MHz)	(dBμV)	(dB)	(dBμV/m)	(dBμV/m)	(dB)		H/V
4960.000	56.54	-4.26	52.28	74	-21.72	peak	H
4960.000	44.07	-4.26	39.81	54	-14.19	AVG	H
7440.000	46.52	1.18	48.70	74	-26.30	peak	H
7440.000	38.60	1.18	39.78	54	-14.22	AVG	H
4960.000	54.67	-4.26	50.41	74	-23.59	peak	V
4960.000	44.55	-4.26	40.29	54	-13.71	AVG	V
7440.000	46.46	1.18	47.64	74	-26.36	peak	V
7440.000	37.32	1.18	38.50	54	-15.50	AVG	V

Remark:

- 1) The field strength is calculated by adding the Antenna Factor, Cable Factor & Preamplifier. The basic equation with a sample calculation is as follows:
 Final Test Level = Receiver Reading + Antenna Factor + Cable Factor – Preamplifier Factor
- 2) Scan from 9kHz to 25GHz, The disturbance above 13GHz and below 30MHz was very low, and the above harmonics were the highest point could be found when testing, so only the above harmonics had been displayed. The amplitude of spurious emissions from the radiator which are attenuated more than 20dB below the limit need not be reported.

■ Spurious Emission in Restricted Band 2310-2390MHz and 2483.5-2500MHz

Test mode: BLE(GFSK)	2402MHz	Test channel:	Lowest	Polarization	Horizontal
----------------------	---------	---------------	--------	--------------	------------

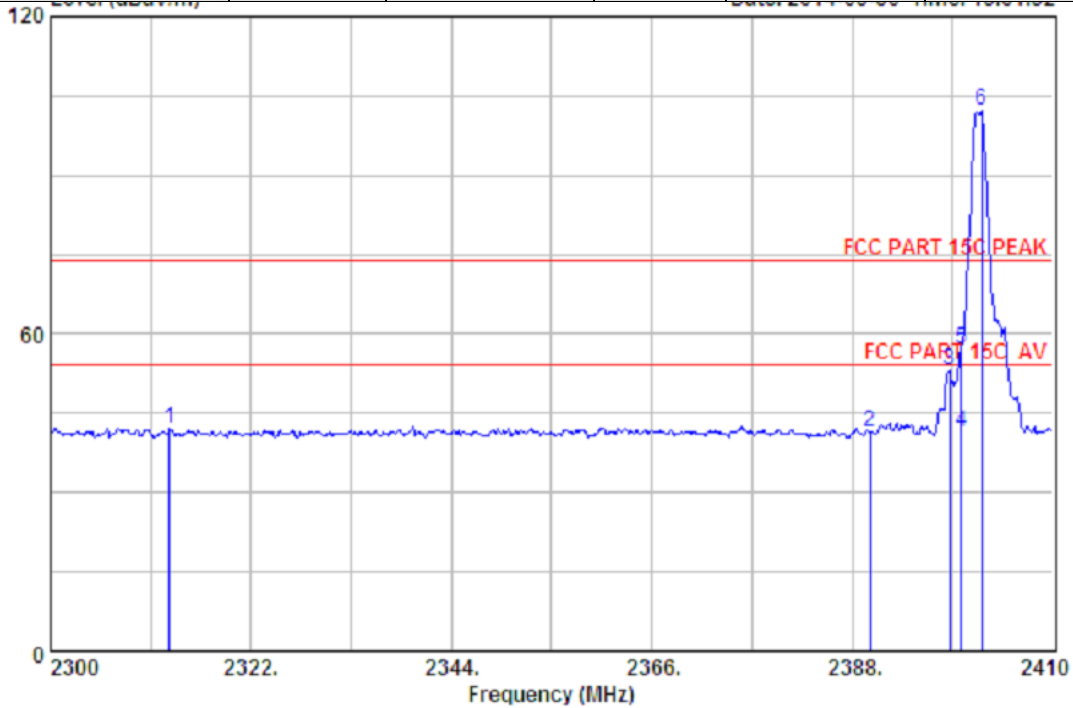

	Freq. (MHz)	Ant. Factor (dB/m)	Cable Loss (dB)	Amp Factor (dB)	Reading (dBuV)	Emission Level (dBuV/m)	Limits (dBuV/m)	Margin (dB)	Remark
1	2313.09	27.76	6.53	34.24	42.01	42.06	74.00	31.94	Peak
2	2390.00	27.64	6.62	34.19	41.35	41.42	74.00	32.58	Peak
3	2398.67	27.61	6.62	34.18	53.18	53.23	74.00	20.77	Peak
4	2400.00	27.61	6.62	34.18	41.31	41.36	54.00	12.64	Average
5	2400.00	27.61	6.62	34.18	57.23	57.28	74.00	16.72	Peak
6	2402.19	27.61	6.62	34.18	102.35	102.40	74.00	-28.40	Peak

Remarks: 1. Emission Level= Antenna Factor + Cable Loss - Amp Factor + Reading.
 2. The emission levels that are 20dB below the official limit are not reported.

Test mode: BLE(GFSK)	2402MHz	Test channel:	Lowest	Polarization	Vertical
----------------------	---------	---------------	--------	--------------	----------

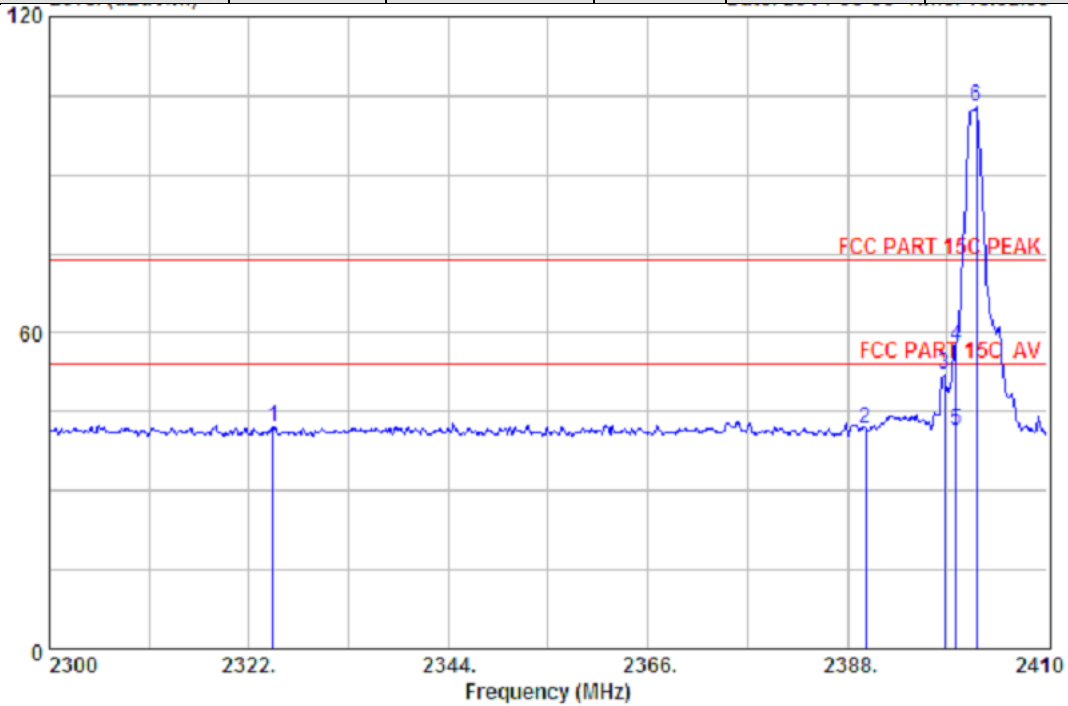

	Freq. (MHz)	Ant. Factor (dB/m)	Cable Loss (dB)	Amp Factor (dB)	Reading (dBuV)	Emission Level (dBuV/m)	Limits (dBuV/m)	Margin (dB)	Remark
1	2324.64	27.73	6.54	34.23	42.18	42.22	74.00	31.78	Peak
2	2390.00	27.64	6.62	34.19	41.68	41.75	74.00	32.25	Peak
3	2398.67	27.61	6.62	34.18	52.08	52.13	74.00	21.87	Peak
4	2400.00	27.61	6.62	34.18	57.47	57.52	74.00	16.48	Peak
5	2400.00	27.61	6.62	34.18	41.44	41.49	54.00	12.51	Average
6	2402.19	27.61	6.62	34.18	102.78	102.83	74.00	-28.83	Peak

Remarks: 1. Emission Level= Antenna Factor + Cable Loss - Amp Factor + Reading.
 2. The emission levels that are 20dB below the official limit are not reported.

Test mode: BLE(GFSK)	2480MHz	Test channel:	Highest	Polarization	Vertical
----------------------	---------	---------------	---------	--------------	----------

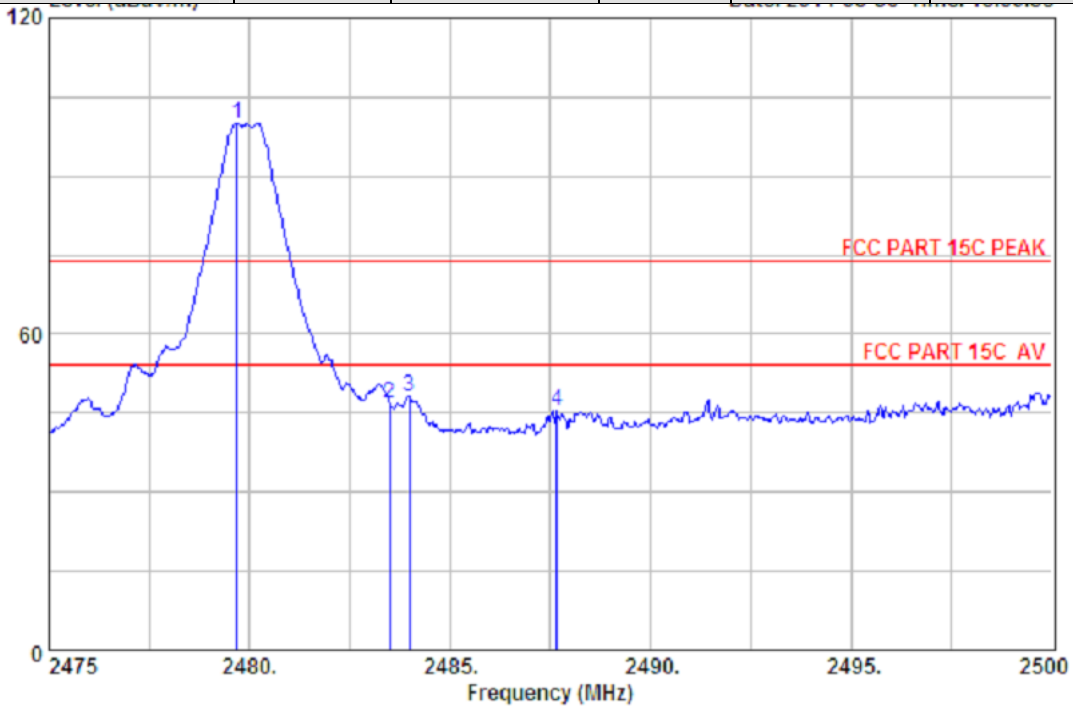

	Freq. (MHz)	Ant. Factor (dB/m)	Cable Loss (dB)	Amp Factor (dB)	Reading (dBuV)	Emission Level (dBuV/m)	Limits (dBuV/m)	Margin (dB)	Remark
1	2479.68	27.58	6.71	34.03	99.84	100.10	74.00	-26.10	Peak
2	2483.50	27.58	6.71	34.03	46.54	46.80	74.00	27.20	Peak
3	2483.98	27.58	6.71	34.03	47.84	48.10	74.00	25.90	Peak
4	2487.68	27.58	6.73	34.03	45.24	45.52	74.00	28.48	Peak

Remarks: 1. Emission Level= Antenna Factor + Cable Loss - Amp Factor + Reading.
 2. The emission levels that are 20dB below the official limit are not reported.

Test mode: BLE(GFSK)	2480MHz	Test channel:	Highest	Polarization	Horizontal
----------------------	---------	---------------	---------	--------------	------------

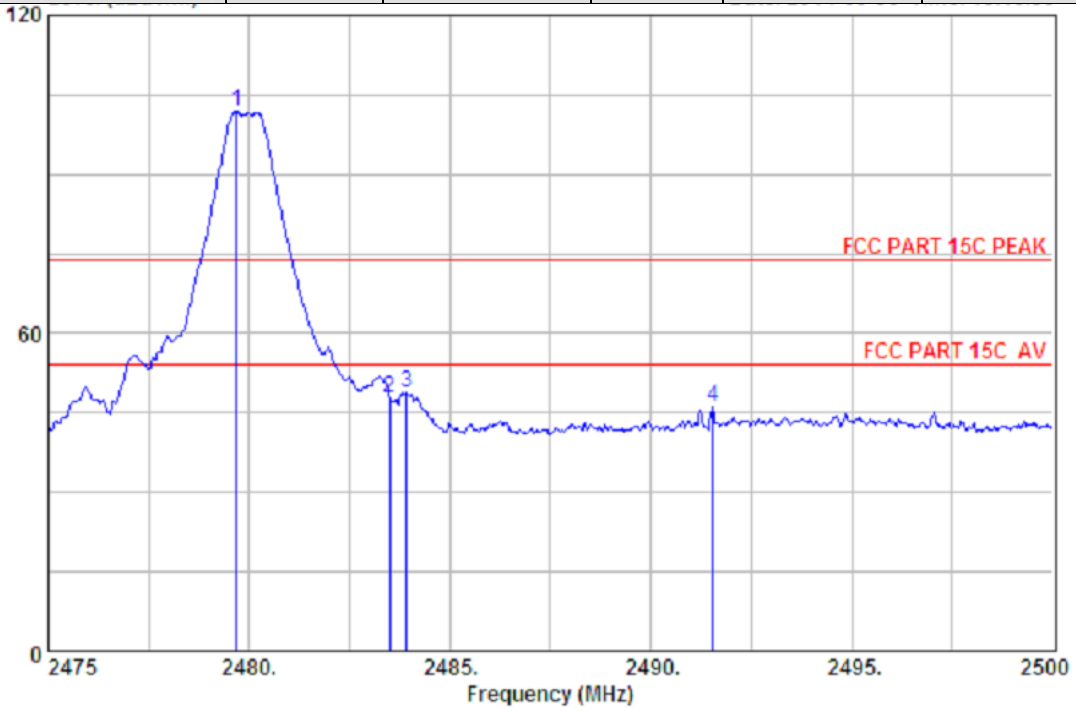

	Freq. (MHz)	Ant. Factor (dB/m)	Cable Loss (dB)	Amp Factor (dB)	Reading (dBuV)	Emission Level (dBuV/m)	Limits (dBuV/m)	Margin (dB)	Remark
1	2479.68	27.58	6.71	34.03	101.58	101.84	74.00	-27.84	Peak
2	2483.50	27.58	6.71	34.03	47.62	47.88	74.00	26.12	Peak
3	2483.93	27.58	6.71	34.03	48.55	48.81	74.00	25.19	Peak
4	2491.55	27.58	6.73	34.03	45.86	46.14	74.00	27.86	Peak

Remarks: 1. Emission Level= Antenna Factor + Cable Loss - Amp Factor + Reading.
 2. The emission levels that are 20dB below the official limit are not reported.

- Spurious Emission below 1GHz (30MHz to 1GHz)
- Only the worst numbers are in the report

Test mode: BLE(GFSK)	2402MHz	Test channel:	Highest	Polarization	Horizontal
----------------------	---------	---------------	---------	--------------	------------

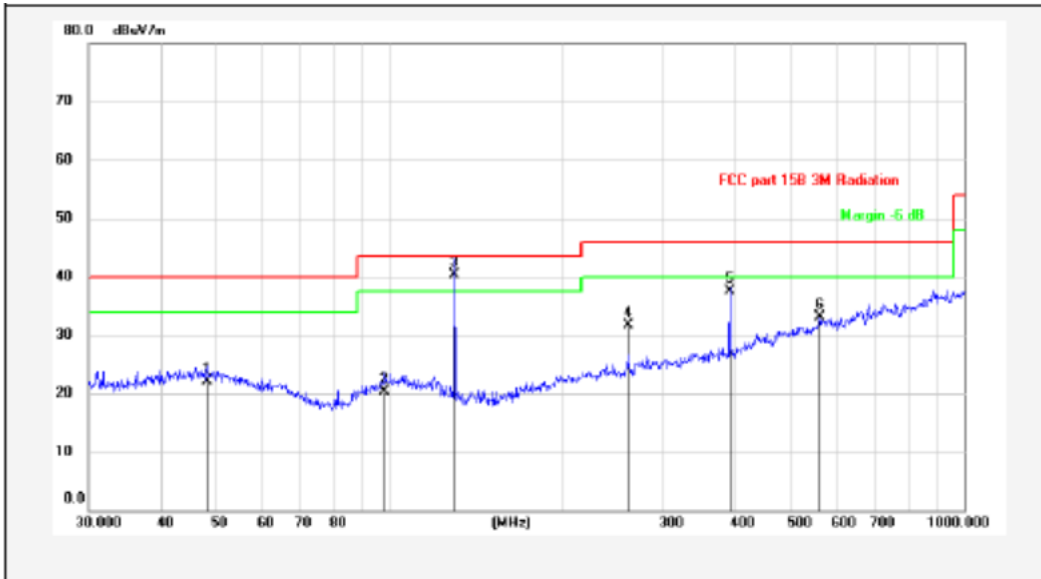

No.	Frequency (MHz)	Reading (dBuV/m)	Antenna (dB/m)	Cable (dB)	Result (dBuV/m)	Limit (dBuV/m)	Margin (dB)	Detector
1	48.1625	6.49	14.1	1.51	22.10	40.00	-17.90	QP
2	98.1419	6.04	12.22	2.04	20.30	43.50	-23.20	QP
3	129.9225	28.57	9.42	2.31	40.30	43.50	-3.20	QP
4	260.1444	15.52	13.07	3.21	31.80	46.00	-14.20	QP
5	390.7225	18.99	14.68	3.83	37.50	46.00	-8.50	QP
6	560.6928	10.31	18.28	4.53	33.12	46.00	-12.88	QP

Test mode: BLE(GFSK)	2402MHz	Test channel:	Highest	Polarization	Vertical
----------------------	---------	---------------	---------	--------------	----------

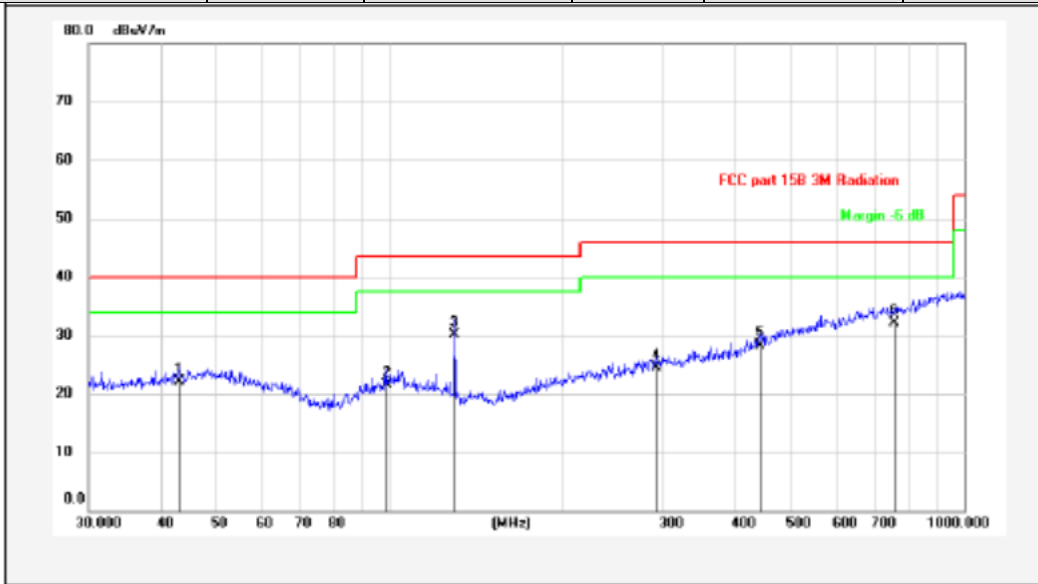

No.	Frequency (MHz)	Reading (dBuV/m)	Antenna (dB/m)	Cable (dB)	Result (dBuV/m)	Limit (dBuV/m)	Margin (dB)	Detector
1	43.0504	6.99	13.79	1.42	22.20	40.00	-17.80	QP
2	98.8324	7.15	12.4	2.05	21.60	43.50	-21.90	QP
3	129.9225	18.37	9.42	2.31	30.10	43.50	-13.40	QP
4	291.0360	7.58	13.63	3.29	24.50	46.00	-21.50	QP
5	441.7425	7.97	16.3	4.03	28.30	46.00	-17.70	QP
6	758.0407	6.65	20.26	5.19	32.10	46.00	-13.90	QP

7.5 ANTENNA APPLICATION

7.5.1 Antenna Requirement

Standard	Requirement
FCC CRF Part 15.203	<p>An intentional radiator shall be designed to ensure that no antenna other than that furnished by the responsible party shall be used with the device. The use of a permanently attached antenna or of an antenna that uses a unique coupling to the intentional radiator shall be considered sufficient to comply with the provisions of this section. The manufacturer may design the unit so that a broken antenna can be replaced by the user, but the use of a standard antenna jack or electrical connector is prohibited. This requirement does not apply to carrier current devices or to devices operated under the provisions of §15.211, §15.213, §15.217, §15.219, or §15.221. Further, this requirement does not apply to intentional radiators that must be professionally installed, such as perimeter protection systems and some field disturbance sensors, or to other intentional radiators which, in accordance with §15.31(d), must be measured at the installation site. However, the installer shall be responsible for ensuring that the proper antenna is employed so that the limits in this part are not exceeded.</p>

For intentional device, according to FCC 47 CFR Section 15.203, an intentional radiator shall be designed to ensure that no antenna other than that furnished by the responsible party shall be used with the device. And according to FCC 47 CFR Section 15.247 (b), if transmitting antennas of directional gain greater than 6dBi are used, the power shall be reduced by the amount in dB that the directional gain of the antenna exceeds 6dBi.

7.5.2 Result

PASS.

The EUT has 1 antenna: a PCB Antenna for BLE with classic model, the gain is 2.04dBi;

Note: Antenna use a permanently attached antenna which is not replaceable.
 Not using a standard antenna jack or electrical connector for antenna replacement
 The antenna has to be professionally installed (please provide method of installation)

which in accordance to section 15.203, please refer to the internal photos.

----- END OF REPORT -----