



Test report No.: 2340335R-RFUSV01S-A

# TEST REPORT

Product Name	TCx EDGE Cam+
Trademark	TOSHIBA
Model and /or type reference	6260-002
FCC ID	2AW3T-6260-002
Applicant's name / address	Toshiba Global Commerce Solutions, Inc. 3901 South Miami Blvd., Durham, North Carolina United States 27703
Manufacturer's name	Toshiba Global Commerce Solutions, Inc.
Test method requested, standard	FCC CFR Title 47 Part 15 Subpart C ANSI C63.4: 2014, ANSI C63.10: 2013
Verdict Summary	IN COMPLIANCE
Documented By (Senior Project Specialist / Genie Chang)	<i>Genie Chang</i>
Tested By (Senior Engineer / Bill Lin)	<i>Bill Lin</i>
Approved By (Senior Engineer / Alan Chen)	<i>Alan Chen</i>
Date of Receipt	2023/04/13
Date of Issue	2023/05/19
Report Version	V1.0

## INDEX

---

	Page
<b>1. General Information.....</b>	<b>6</b>
1.1. EUT Description.....	6
1.2. Tested System Details.....	8
1.3. Configuration of Tested System .....	8
1.4. EUT Exercise Software .....	10
1.5. Test Facility .....	11
1.6. List of Test Equipment.....	12
1.7. Uncertainty .....	13
<b>2. Conducted Emission .....</b>	<b>14</b>
2.1. Test Setup .....	14
2.2. Limits.....	14
2.3. Test Procedure .....	15
2.4. Test Result of Conducted Emission.....	16
<b>3. Peak Power Output.....</b>	<b>17</b>
3.1. Test Setup .....	17
3.2. Limit .....	17
3.3. Test Procedure .....	17
3.4. Test Result of Peak Power Output.....	18
<b>4. Radiated Emission .....</b>	<b>20</b>
4.1. Test Setup .....	20
4.2. Limits.....	21
4.3. Test Procedure .....	22
4.4. Test Result of Radiated Emission.....	24
<b>5. RF Antenna Conducted Test .....</b>	<b>28</b>
5.1. Test Setup .....	28
5.2. Limits.....	28
5.3. Test Procedure .....	28
5.4. Test Result of RF Antenna Conducted Test.....	29
<b>6. Band Edge .....</b>	<b>31</b>
6.1. Test Setup .....	31
6.2. Limit .....	32

---

6.3.	Test Procedure .....	32
6.4.	Test Result of Band Edge .....	34
<b>7.</b>	<b>6dB Bandwidth .....</b>	<b>40</b>
7.1.	Test Setup .....	40
7.2.	Limits.....	40
7.3.	Test Procedure .....	40
7.4.	Test Result of 6dB Bandwidth.....	41
<b>8.</b>	<b>Power Density.....</b>	<b>43</b>
8.1.	Test Setup .....	43
8.2.	Limits.....	43
8.3.	Test Procedure .....	43
8.4.	Test Result of Power Density .....	44
<b>9.</b>	<b>Duty Cycle .....</b>	<b>46</b>
9.1.	Test Setup .....	46
9.2.	Test Procedure .....	46
9.3.	Test Result of Duty Cycle.....	47

Appendix 1: EUT Test Photographs

Appendix 2: Product Photos-Please refer to the file: 2340335R-Product Photos

## Competences and Guarantees

---

DEKRA is a testing laboratory competent to carry out the tests described in this report.

In order to assure the traceability to other national and international laboratories, DEKRA has a calibration and maintenance program for its measurement equipment.

DEKRA guarantees the reliability of the data presented in this report, which is the result of the measurements and the tests performed to the item under test on the date and under the conditions stated in the report and it is based on the knowledge and technical facilities available at DEKRA at the time of performance of the test.

DEKRA is liable to the client for the maintenance of the confidentiality of all information related to the item under test and the results of the test.

The results presented in this Test Report apply only to the particular item under test established in this document.

**IMPORTANT:** No parts of this report may be reproduced or quoted out of context, in any form or by any means, except in full, without the previous written permission of DEKRA.

## General conditions

---

1. The test results relate only to the samples tested.
2. The test results shown in the test report are traceable to the national/international standard through the calibration report of the equipment and evaluated measurement uncertainty herein.
3. This report must not be used to claim product endorsement by TAF or any agency of the government.
4. The test report shall not be reproduced without the written approval of DEKRA Testing and Certification Co., Ltd.
5. Measurement uncertainties evaluated for each testing system and associated connections are given here to provide the system information for reference. Compliance determinations do not take into account measurement uncertainties for each testing system, but are based on the results of the compliance measurement.

---

## Revision History

---

Report No.	Version	Description	Issued Date
2340335R-RFUSV01S-A	V1.0	Initial issue of report.	2023/05/19

## 1. General Information

### 1.1. EUT Description

Product Name	TCx EDGE Cam+
Trademark	TOSHIBA
Model and /or type reference	6260-002
EUT Rated Voltage	PoE, 48-57V $\overline{=}$ / 25.5W max USB 12V $\overline{=}$ 2.25A / 9V $\overline{=}$ 3A / 27W max
EUT Test Voltage	DC 12V (by USB-Type C) DC 48V (by PoE)
Frequency Range	2402 - 2480 MHz
Channel Number	40 CH
Type of Modulation	GFSK (1 Mbps, 2 Mbps)
Channel Control	Auto
USB Cable	Shielded, 2.5m
RJ45 Cable	Non-shielded, 4.3m
Mounting Pipe	N/A

#### Antenna List

No.	Manufacturer	Part No.	Antenna Type	Peak Gain
1	Pulse	TZ2531W (Main)	PIFA	2.7 dBi for 2400 MHz
		TZ2530W (Aux)		3.3 dBi for 2400 MHz

Note: The antenna of EUT is conforming to FCC 15.203.

## Center Frequency of Each Channel:

Channel	Frequency (MHz)	Channel	Frequency (MHz)	Channel	Frequency (MHz)	Channel	Frequency (MHz)
00	2402	01	2404	02	2406	03	2408
04	2410	05	2412	06	2414	07	2416
08	2418	09	2420	10	2422	11	2424
12	2426	13	2428	14	2430	15	2432
16	2434	17	2436	18	2438	19	2440
20	2442	21	2444	22	2446	23	2448
24	2450	25	2452	26	2454	27	2456
28	2458	29	2460	30	2462	31	2464
32	2466	33	2468	34	2470	35	2472
36	2474	37	2476	38	2478	39	2480

## Note:

1. The EUT is a TCx EDGE Cam+ with built-in WLAN and Bluetooth transceiver, this report for BLE.
2. The radiation measurements are performed in X, Y, Z axis positioning. Only the worst case is shown in the report.
3. Regarding to the operation frequency, the lowest, middle and highest frequency are selected to perform the test.
4. DEKRA has evaluated each test mode. Only the worst case is shown in the report.
5. These tests were conducted on a sample for the purpose of demonstrating compliance of transmitter with Part 15 Subpart C Paragraph 15.247 for spread spectrum devices.

Test Mode	Mode 1	Transmit - 1 Mbps
		Transmit - 2 Mbps

## 1.2. Tested System Details

The types for all equipment, plus descriptions of all cables used in the tested system (including inserted cards) are:

### PD Mode

Product	Manufacturer	Model No.	Serial No.	Power Cord
1 Power Adapter	DELTA	DPS-180AB-21	N/A	N/A
2 Point of Sale System	TOSHIBA	6201-25C	N/A	N/A
3 Mounting Pipe	N/A	N/A	N/A	N/A

Cable Type	Cable Description
A Power Cable	Non-shielded, 1.5m, with two ferrite cores bonded.
B USB-Type C Cable	Shielded, 2.5m

### PoE Mode

Product	Manufacturer	Model No.	Serial No.	Power Cord
1 Power Adapter	NETGEAR	2ACL068S	N/A	N/A
2 PoE Switch	NETGEAR	GS305Pv2	N/A	N/A
3 Notebook PC	DELL	Latitude E5440	FS9TK32	N/A

Cable Type	Cable Description
A Power Cable	Non-shielded, 1.5m
B LAN Cable	Non-shielded, 4.2m
C USB-Type C Cable	Shielded, 2.5m



### 1.3. Configuration of Tested System

#### PD Mode

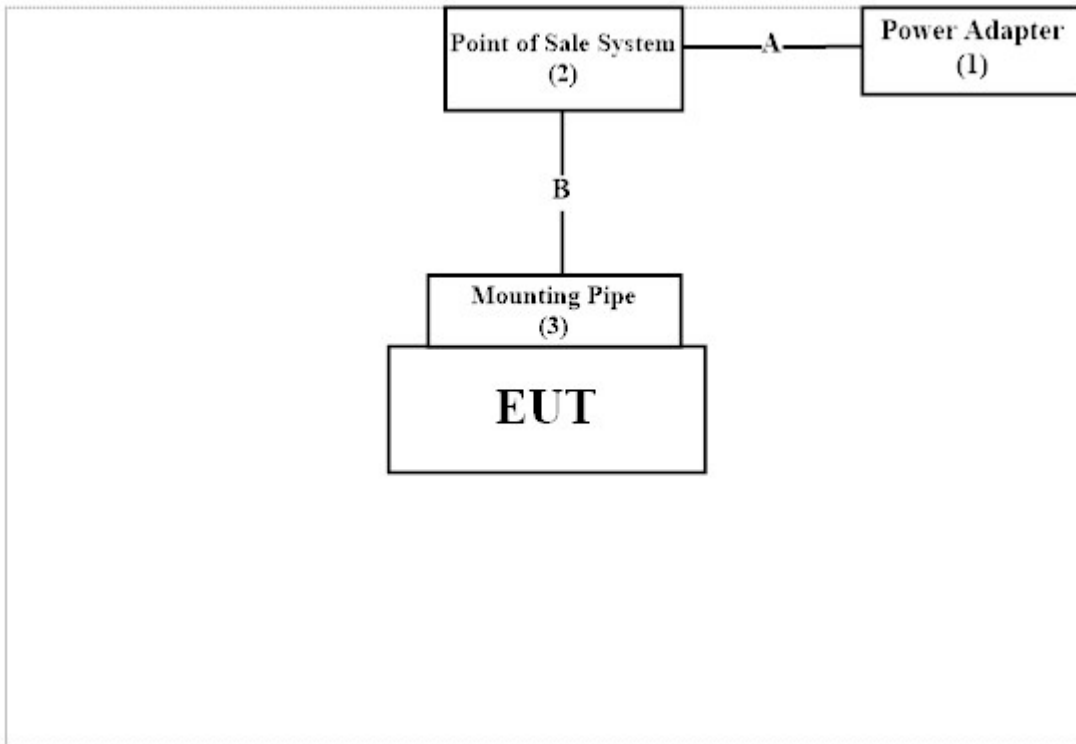

#### PoE Mode

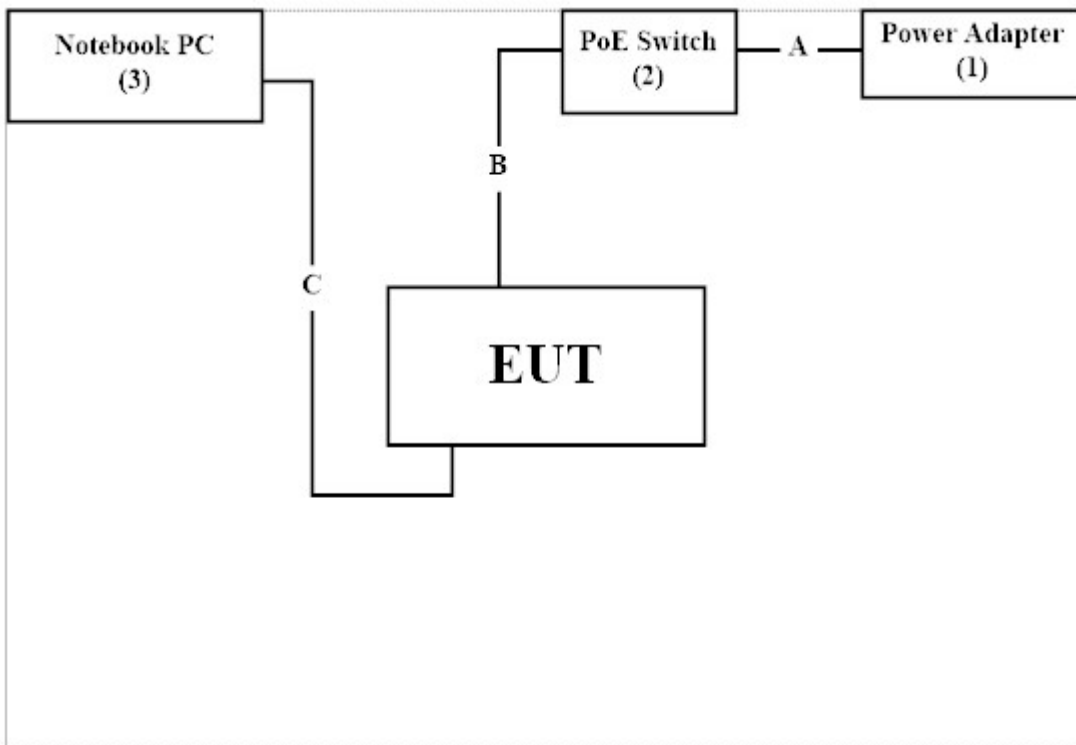

#### 1.4. EUT Exercise Software

1	Setup the EUT as shown in Section 1.3.
2	Execute software “QRCT Ver. 4.0.210.0” on the Notebook PC.
3	Configure the test mode, the test channel, and the data rate.
4	Press “OK” to start the continuous transmit.
5	Verify that the EUT works properly.

## 1.5. Test Facility

Ambient conditions in the laboratory:

Performed Item	Items	Required	Actual
Conducted Emission	Temperature (°C)	10~40 °C	23.8 °C
	Humidity (%RH)	10~90 %	52.2 %
Radiated Emission	Temperature (°C)	10~40 °C	23.4 °C
	Humidity (%RH)	10~90 %	66.8 %
Conductive	Temperature (°C)	10~40 °C	24.5 °C
	Humidity (%RH)	10~90 %	59.0 %

USA	FCC Registration Number: TW0033
Canada	CAB Identifier Number: TW3023 / Company Number: 26930

Site Description	Accredited by TAF
	Accredited Number: 3023

Test Laboratory	DEKRA Testing and Certification Co., Ltd.
	Linkou Laboratory
Address	No.5-22, Ruishukeng Linkou District, New Taipei City, 24451, Taiwan, R.O.C
Performed Location	No. 26, Huaya 1st Rd., Guishan Dist., Taoyuan City 333411, Taiwan, R.O.C.
Phone Number	+886-3-275-7255
Fax Number	+886-3-327-8031

## 1.6. List of Test Equipment

**For Conduction Measurements / HY-SR01**

	Equipment	Manufacturer	Model No.	Serial No.	Cal. Date	Due Date
V	EMI Test Receiver	R&S	ESR7	101601	2022/06/23	2023/06/22
V	Two-Line V-Network	R&S	ENV216	101306	2023/03/16	2024/03/15
V	Two-Line V-Network	R&S	ENV216	101307	2022/07/04	2023/07/03
V	Coaxial Cable	SUHNER	RG400 BNC	RF001	2022/05/24	2023/05/23

Note:

1. All equipments are calibrated every one year.
2. The test instruments marked with “V” are used to measure the final test results.
3. Test Software Version: e3 230303 dekra V9.

**For Conducted Measurements / HY-SR02**

	Equipment	Manufacturer	Model No.	Serial No.	Cal. Date	Due Date
V	Spectrum Analyzer	R&S	FSV30	103466	2022/12/22	2023/12/21
V	Peak Power Analyzer	KEYSIGHT	8990B	MY51000410	2022/08/06	2023/08/05
V	Wideband Power Sensor	KEYSIGHT	N1923A	MY56080003	2022/08/05	2023/08/04
V	Wideband Power Sensor	KEYSIGHT	N1923A	MY56080004	2022/08/05	2023/08/04

Note:

1. All equipments are calibrated every one year.
2. The test instruments marked with “V” are used to measure the final test results.
3. Test Software Version: RF Conducted Test Tools R3 V3.0.1.14.

**For Radiated Measurements / HY-CB01**

	Equipment	Manufacturer	Model No.	Serial No.	Cal. Date	Due Date
V	Loop Antenna	AMETEK	HLA6121	49611	2023/02/21	2024/02/20
V	Bi-Log Antenna	SCHWARZBECK	VULB9168	9168-0675	2021/08/11	2023/08/10
V	Horn Antenna	RF SPIN	DRH18-E	210802A18ES	2023/03/23	2024/03/22
V	Horn Antenna	Com-Power	AH-840	101101	2021/11/30	2023/11/29
V	Pre-Amplifier	SGH	0301	20211007-7	2023/01/10	2024/01/09
V	Pre-Amplifier	EMCI	EMC051845SE	980632	2023/01/10	2024/01/09
V	Pre-Amplifier	EMCI	EMC05820SE	980361	2023/01/10	2024/01/09
	Pre-Amplifier	EMCI	EMC184045SE	980369	2023/01/10	2024/01/09
V	Coaxial Cable	EMCI	EMC102-KM-KM-600	1160314		
	Coaxial Cable	EMCI	EMC102-KM-KM-7000	170242		
V	Filter	MICRO TRONICS	BRM50702	G251	2023/01/05	2024/01/04
	Filter	MICRO TRONICS	BRM50716	067	2023/01/05	2024/01/04
V	EMI Test Receiver	R&S	ESR3	102792	2022/12/29	2023/12/28
V	Spectrum Analyzer	R&S	FSV3044	101115	2023/01/06	2024/01/05
V	Coaxial Cable	SUHNER	SUCOFLEX 106	25450/6	2023/01/10	2024/01/09
	Coaxial Cable	SGH	HA800	GD20110222-8		
	Coaxial Cable	SGH	SGH18	2021003-8		
	Coaxial Cable	EMCI	EMC106	151113		

Note:

1. Bi-Log Antenna and Horn Antenna(AH-840) is calibrated every two years, the other equipments are calibrated every one year.
2. The test instruments marked with “V” are used to measure the final test results.
3. Test Software Version: e3 230303 dekra V9.

### 1.7. Uncertainty

Uncertainties have been calculated according to the DEKRA internal document.

The reported expanded uncertainties are based on a standard uncertainty multiplied by a coverage factor of  $k=2$ , providing a level of confidence of approximately 95%.

Measurement uncertainties evaluated for each testing system and associated connections are given here to provide the system information for reference. Compliance determinations do not take into account measurement uncertainties for each testing system but are based on the results of the compliance measurement.

Test item	Uncertainty
Conducted Emission	$\pm 3.50$ dB
Peak Power Output	Spectrum Analyzer: $\pm 2.14$ dB Power Meter: $\pm 1.05$ dB
Radiated Emission	9 kHz~30 MHz: $\pm 3.88$ dB 30 MHz~1 GHz: $\pm 4.42$ dB 1 GHz~18 GHz: $\pm 4.28$ dB 18 GHz~40 GHz: $\pm 3.90$ dB
RF Antenna Conducted Test	$\pm 2.14$ dB
Band Edge	9 kHz~30 MHz: $\pm 3.88$ dB 30 MHz~1 GHz: $\pm 4.42$ dB 1 GHz~18 GHz: $\pm 4.28$ dB 18 GHz~40 GHz: $\pm 3.90$ dB
6dB Bandwidth	$\pm 1580.61$ Hz
Power Density	$\pm 2.14$ dB
Duty Cycle	$\pm 0.53$ %

## 2. Conducted Emission

### 2.1. Test Setup

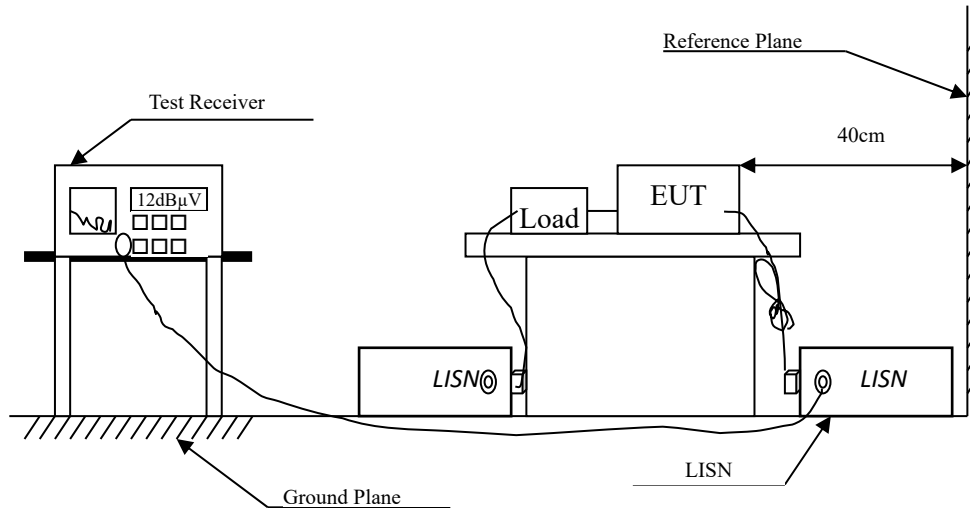

### 2.2. Limits

FCC Part 15 Subpart C Paragraph 15.207 (dB $\mu$ V) Limit		
Frequency MHz	Limits	
	QP	AV
0.15 - 0.50	66-56	56-46
0.50 - 5.0	56	46
5.0 - 30	60	50

Remarks: In the above table, the tighter limit applies at the band edges.

### 2.3. Test Procedure

The EUT and Peripherals are connected to the main power through a line impedance stabilization network (L.I.S.N.). This provides a 50 ohm /50uH coupling impedance for the measuring equipment. The peripheral devices are also connected to the main power through a LISN that provides a 50ohm /50uH coupling impedance with 50ohm termination. (Please refer to the block diagram of the test setup and photographs.)

Both sides of A.C. line are checked for maximum conducted interference. In order to find the maximum emission, the relative positions of equipment and all the interface cables must be changed according to ANSI C63.4: 2014 on conducted measurement.

Conducted emissions were investigated over the frequency range from 0.15 MHz to 30 MHz using a receiver bandwidth of 9 kHz.

The EUT was setup to ANSI C63.4, 2014; tested to DTS test procedure of FCC KDB-558074 for compliance to FCC 47CFR Subpart C requirements.

## 2.4. Test Result of Conducted Emission

### PD Mode

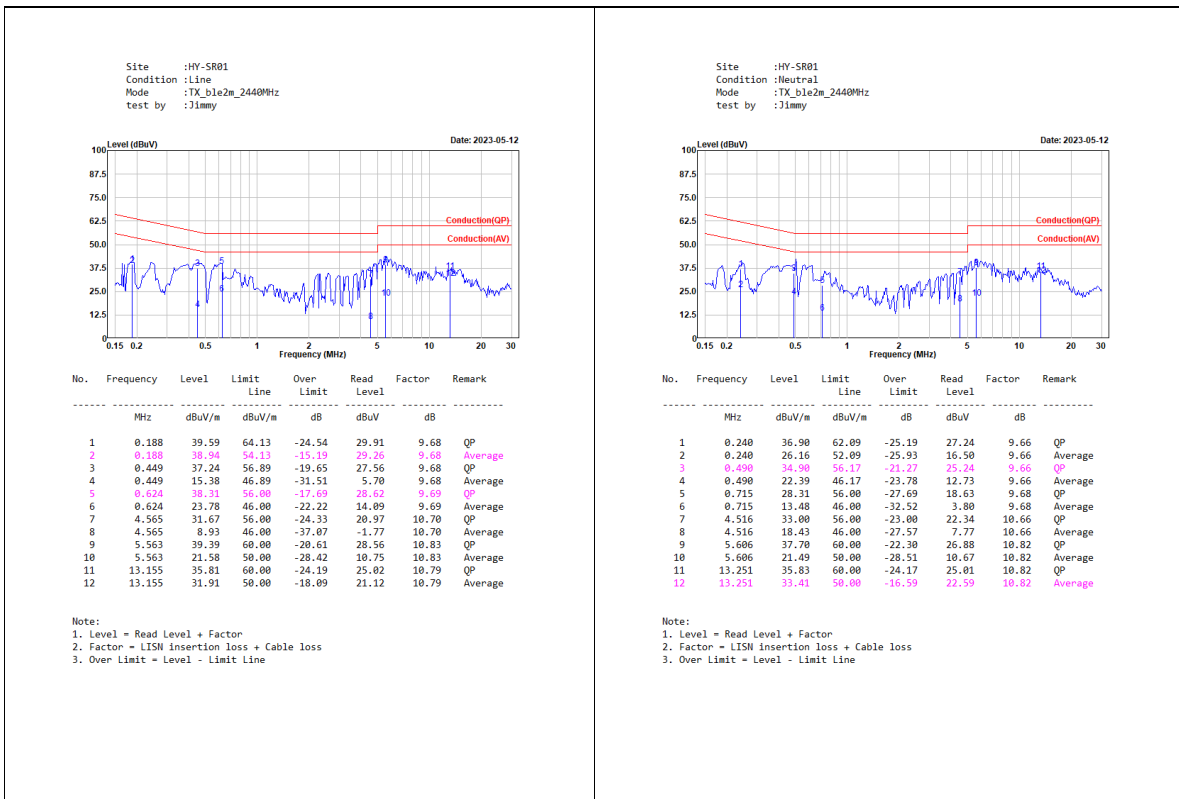

### PoE Mode

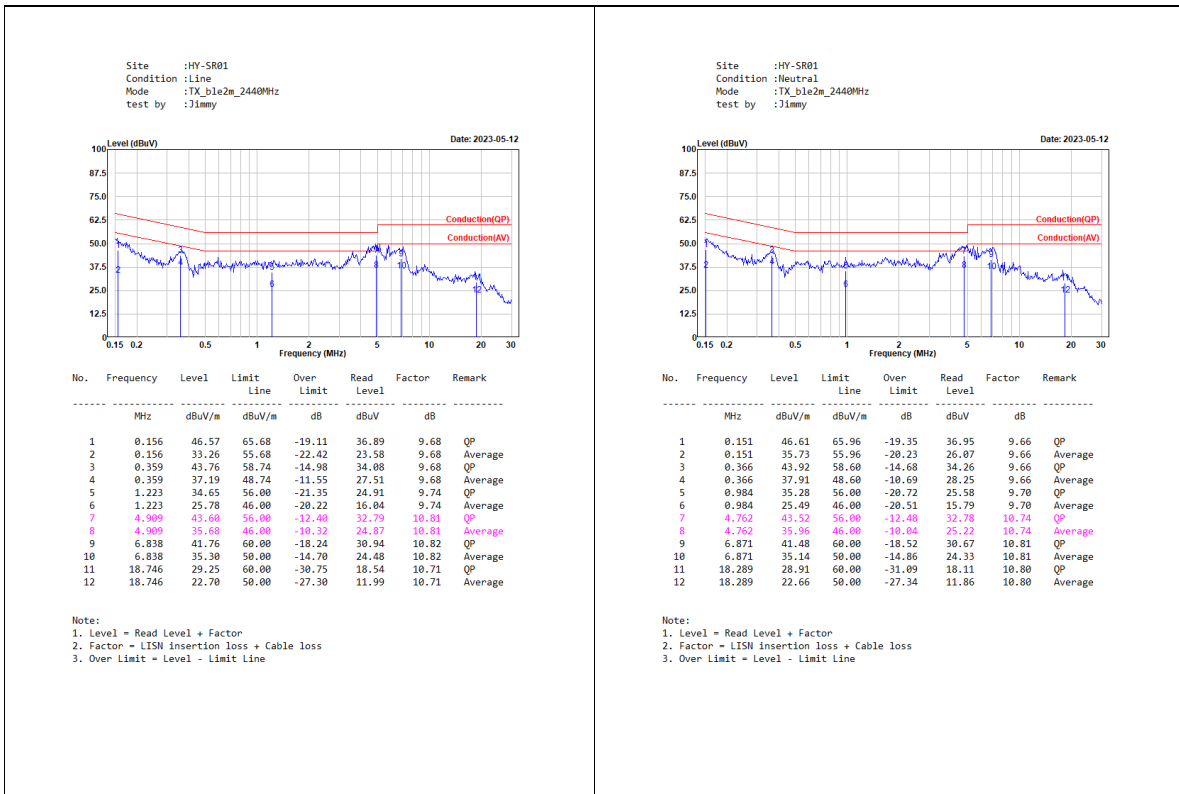



### 3. Peak Power Output

#### 3.1. Test Setup

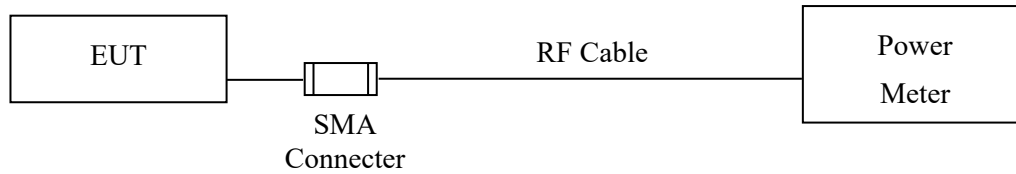

#### 3.2. Limit

The maximum peak power shall be less 1Watt.

#### 3.3. Test Procedure

The EUT was tested according to C63.10:2013 for compliance to FCC 47CFR 15.247 requirements. The maximum peak conducted output power using C63.10:2013 Section 11.9.1.3 PKPM1 Peak power meter method.

## 3.4. Test Result of Peak Power Output

Product : TCx EDGE Cam+  
Test Item : Peak Power Output  
Test Mode : Transmit - 1 Mbps  
Test Date : 2023/04/19

Channel No.	Frequency (MHz)	Measurement Level (dBm)	Required Limit	Result
00	2402	-1.12	1 Watt= 30 dBm	Pass
19	2440	-0.67	1 Watt= 30 dBm	Pass
39	2480	0.11	1 Watt= 30 dBm	Pass

Product : TCx EDGE Cam+  
Test Item : Peak Power Output  
Test Mode : Transmit - 2 Mbps  
Test Date : 2023/04/19

Channel No.	Frequency (MHz)	Measurement Level (dBm)	Required Limit	Result
00	2402	-1.03	1 Watt= 30 dBm	Pass
19	2440	-0.55	1 Watt= 30 dBm	Pass
39	2480	0.19	1 Watt= 30 dBm	Pass

#### 4. Radiated Emission

##### 4.1. Test Setup

###### Radiated Emission Under 30 MHz

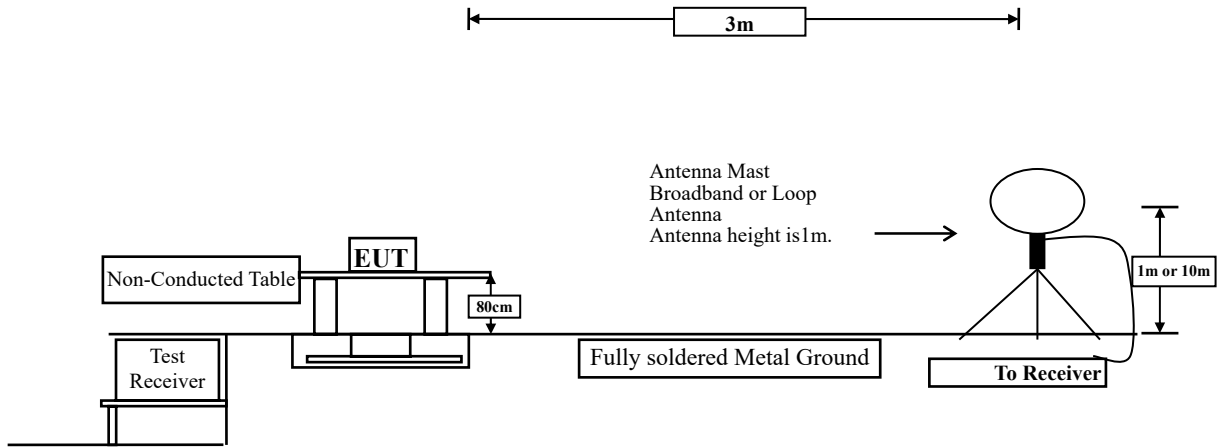

###### Radiated Emission Below 1 GHz

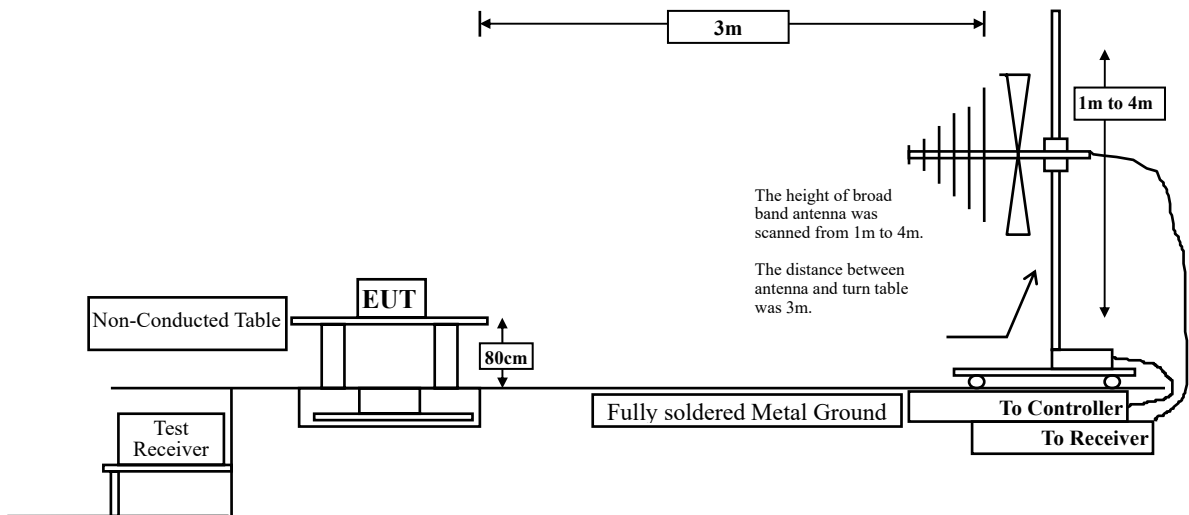

###### Radiated Emission Above 1 GHz

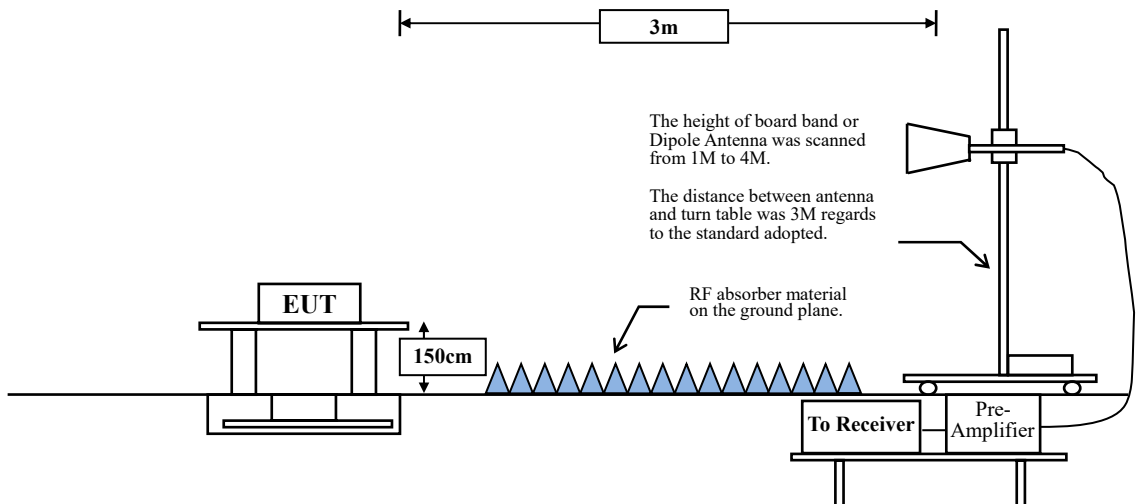

## 4.2. Limits

### ➤ General Radiated Emission Limits

Emissions radiated outside of the specified frequency bands, except for harmonics, shall be attenuated by at least 20dB below the level of the fundamental or to the general radiated emission limits in paragraph 15.209, whichever is the lesser attenuation.

FCC Part 15 Subpart C Paragraph 15.209 Limits		
Frequency MHz	Field strength (microvolts/meter)	Measurement distance (meter)
0.009-0.490	2400/F(kHz)	300
0.490-1.705	24000/F(kHz)	30
1.705-30	30	30
30-88	100	3
88-216	150	3
216-960	200	3
Above 960	500	3

#### Remarks:

1. RF Voltage (dB $\mu$ V) = 20 log RF Voltage ( $\mu$ V)
2. In the Above Table, the tighter limit applies at the band edges.
3. Distance refers to the distance in meters between the measuring instrument antenna and the closed point of any part of the device or system.

#### 4.3. Test Procedure

The EUT was setup according to ANSI C63.10: 2013 and tested according to C63.10:2013 Section 11.12.1 for compliance to FCC 47CFR 15.247 requirements.

Measuring the frequency range below 1 GHz, the EUT is placed on a turn table which is 0.8 meter above ground, when measuring the frequency range above 1 GHz, the EUT is placed on a turn table which is 1.5 meter above ground.

The turn table is rotated 360 degrees to determine the position of the maximum emission level.

The EUT was positioned such that the distance from antenna to the EUT was 3 meters.

The antenna is scanned between 1 meter and 4 meters to find out the maximum emission level. This is repeated for both horizontal and vertical polarization of the antenna. In order to find the maximum emission, all of the interface cables were manipulated according to ANSI C63.10: 2013 on radiated measurement.

The resolution bandwidth below 30 MHz setting on the field strength meter is 9 kHz and 30 MHz~1 GHz is 120 kHz and above 1 GHz is 1 MHz.

Radiated emission measurements below 30 MHz are made using Loop Antenna and 30 MHz~1 GHz are made using broadband Bilog antenna and above 1 GHz are made using Horn Antennas.

The measurement is divided into the Preliminary Measurement and the Final Measurement.

The suspected frequencies are searched for in Preliminary Measurement with the measurement antenna kept pointed at the source of the emission both in azimuth and elevation, with the polarization of the antenna oriented for maximum response. The antenna is pointed at an angle towards the source of the emission, and the EUT is rotated in both height and polarization to maximize the measured emission. The emission is kept within the illumination area of the 3 dB bandwidth of the antenna.

The measurement frequency range form 9 kHz - 10th Harmonic of fundamental was investigated.

**RBW and VBW Parameter setting:**

According to C63.10 Section 11.12.2.4 Peak measurement procedure.

RBW = as specified in Table 1.

VBW  $\geq$  3 x RBW.

**Table 1 - RBW as a function of frequency**

Frequency	RBW
9-150 kHz	200-300 Hz
0.15-30 MHz	9-10 kHz
30-1000 MHz	100-120 kHz
> 1000 MHz	1 MHz

According to C63.10 Section 11.12.2.5 Average measurement procedure.

RBW = 1 MHz.

VBW = 10 Hz, when duty cycle  $\geq$  98 %

VBW  $\geq$  1/T, when duty cycle < 98 %

(T refers to the minimum transmission duration over which the transmitter is on and is transmitting at its maximum power control level for the tested mode of operation.)

2.4GHz band	Duty Cycle (%)	T (ms)	1/T (Hz)	VBW (Hz)
BLE (1 Mbps)	84.89	2.1240	471	500
BLE (2 Mbps)	56.73	1.0620	942	1000

Note: Duty Cycle Refer to Section 9.

#### 4.4. Test Result of Radiated Emission

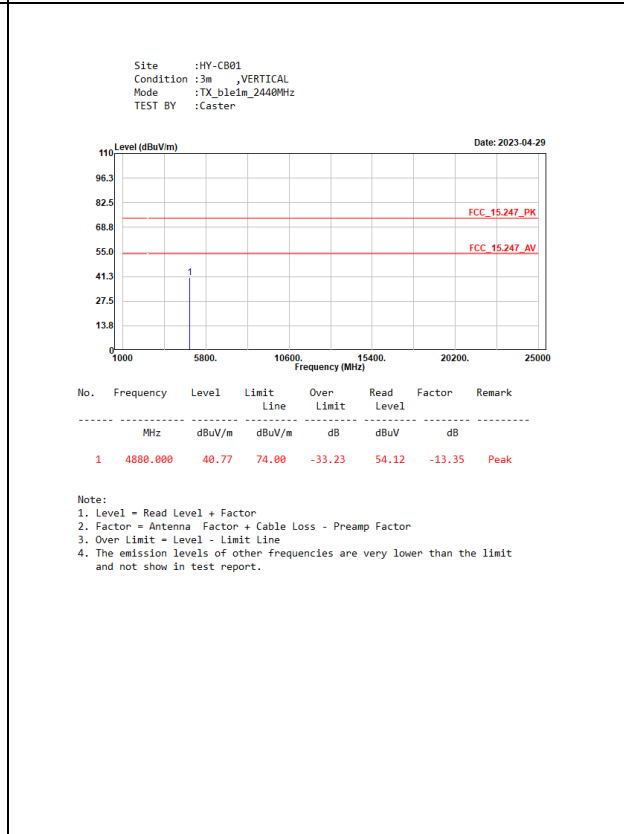
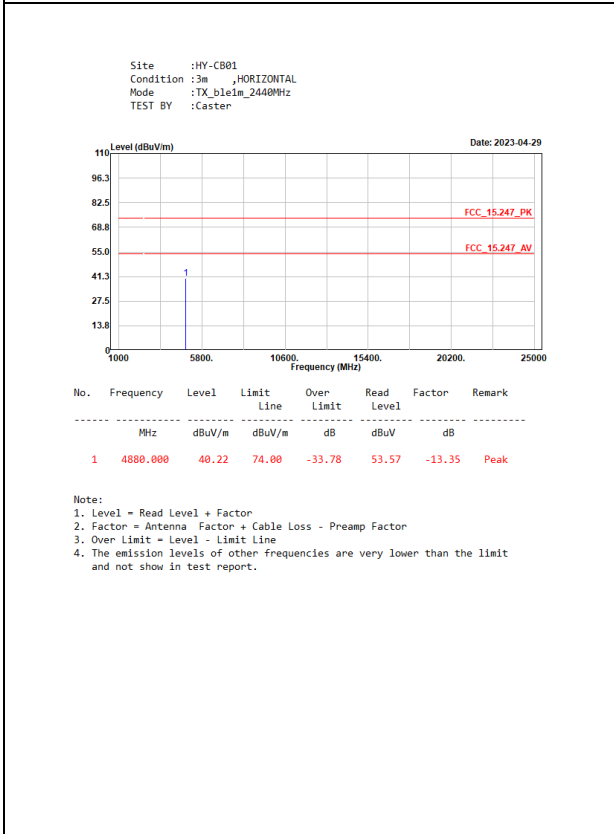
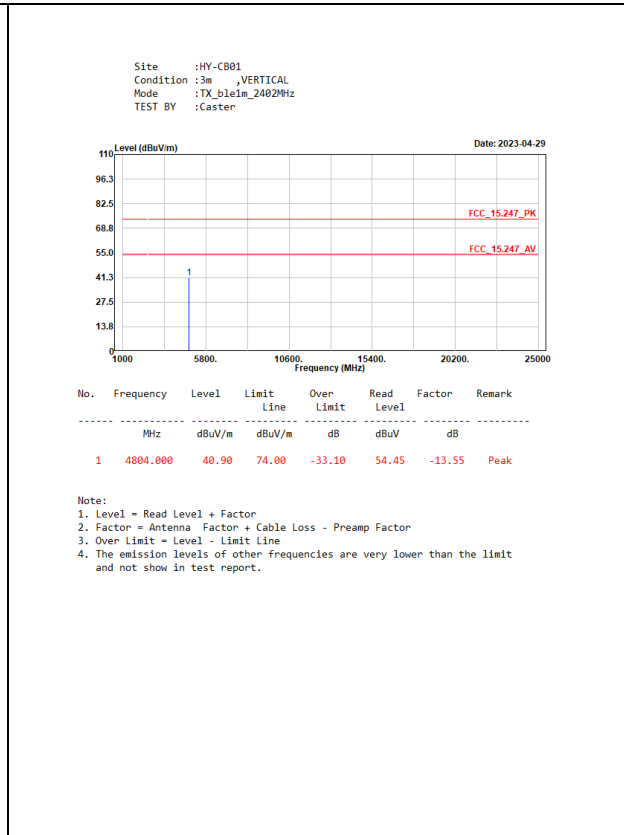
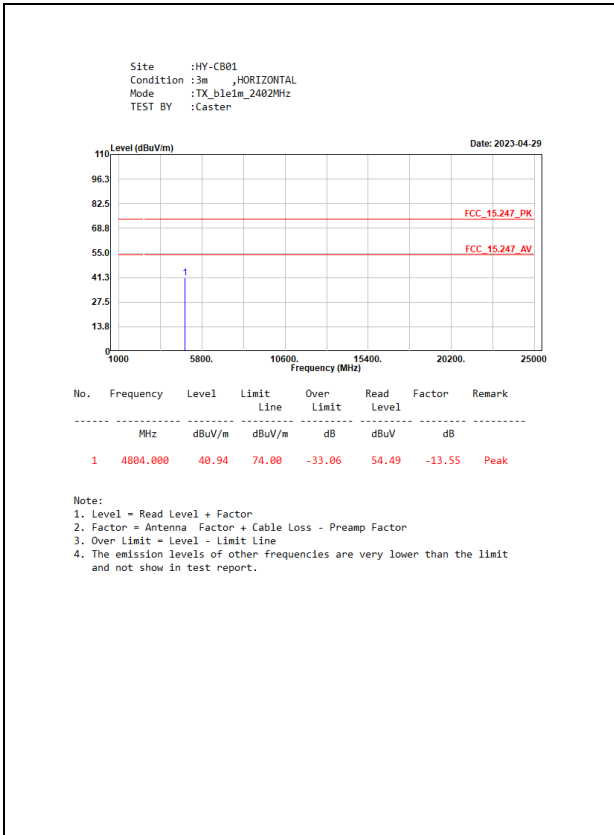



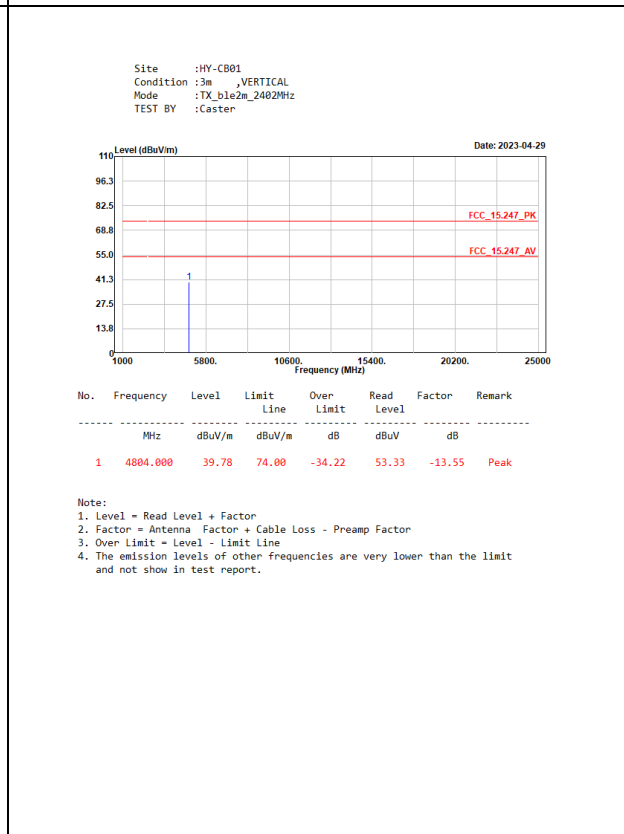
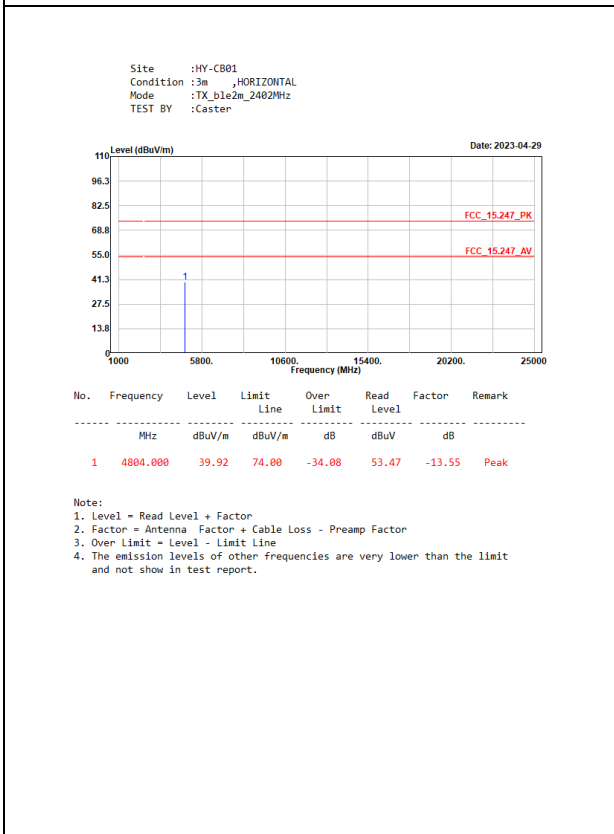
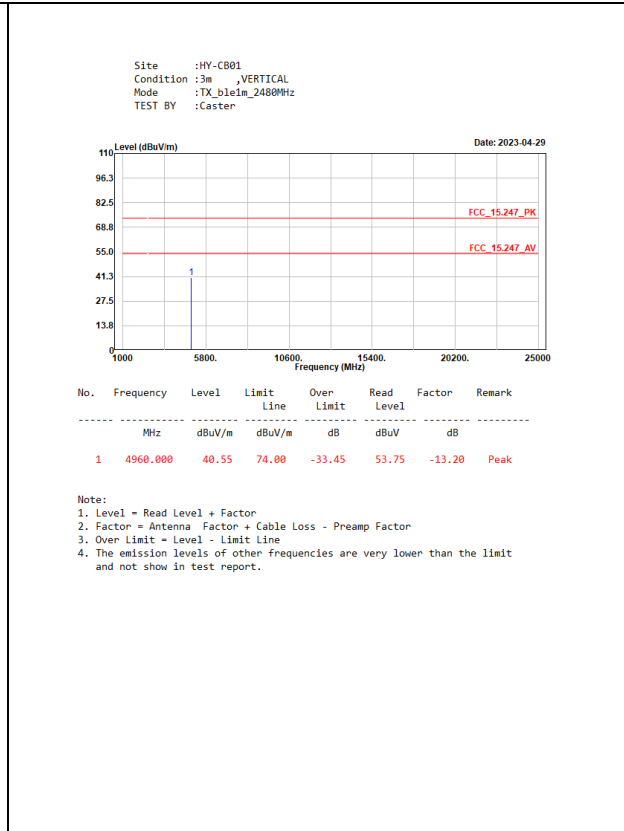
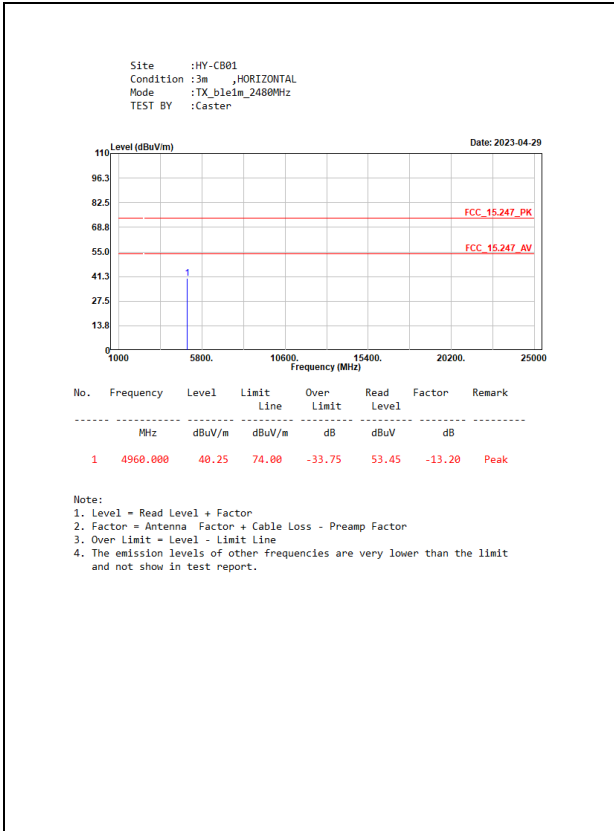

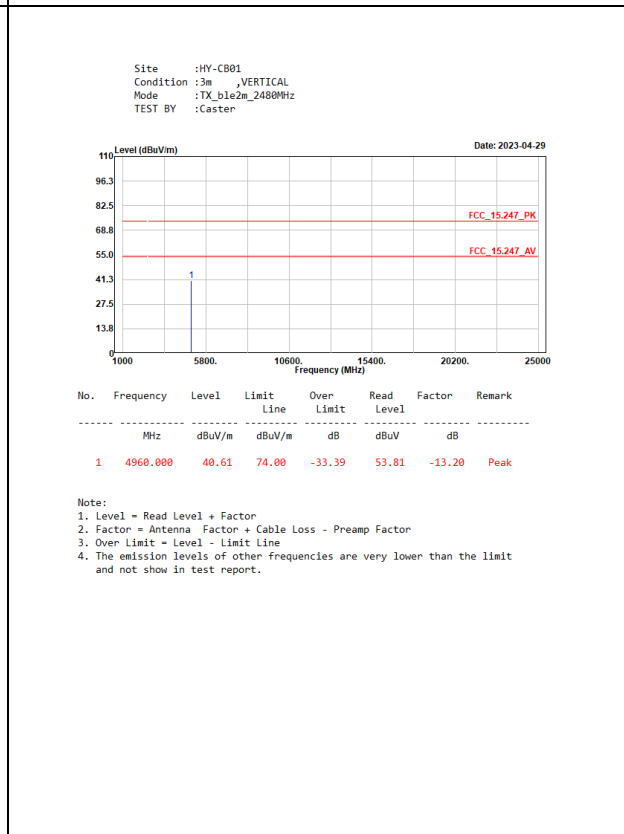
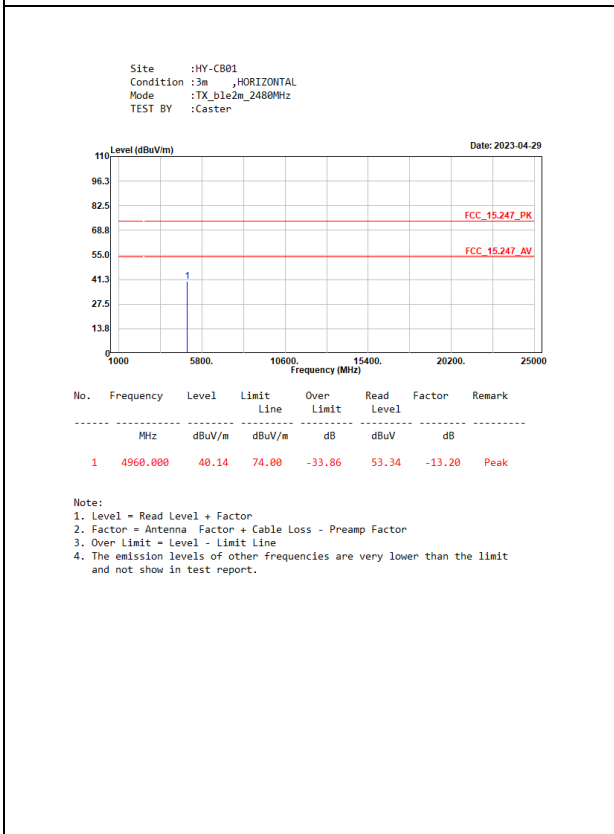
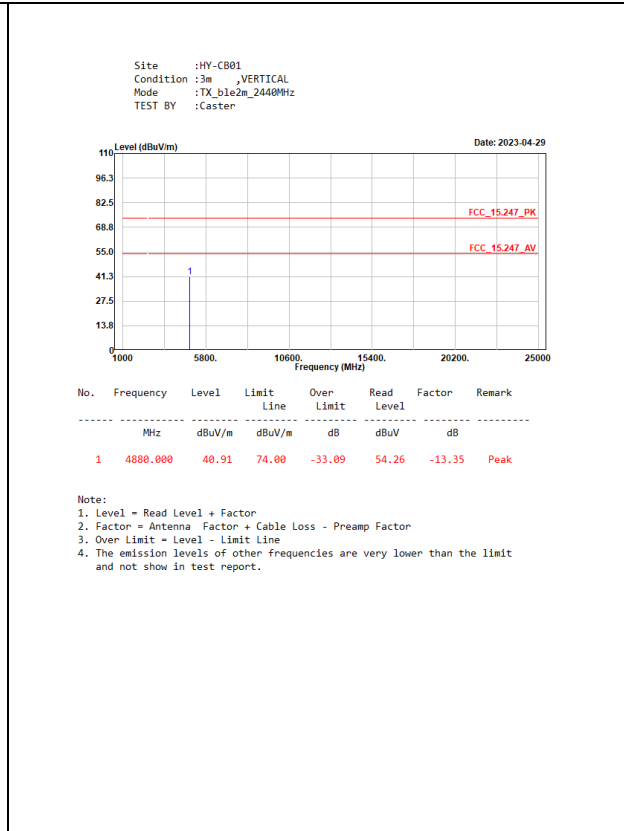
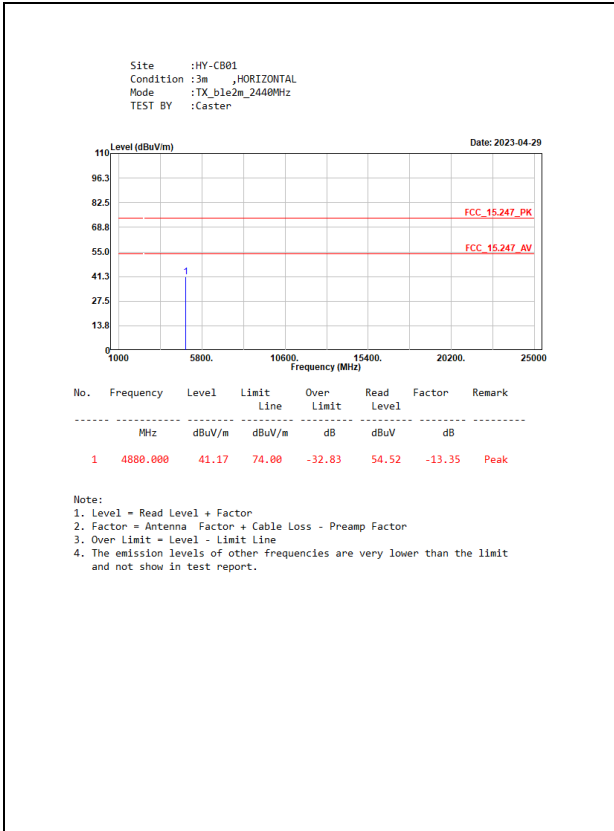

PD Mode

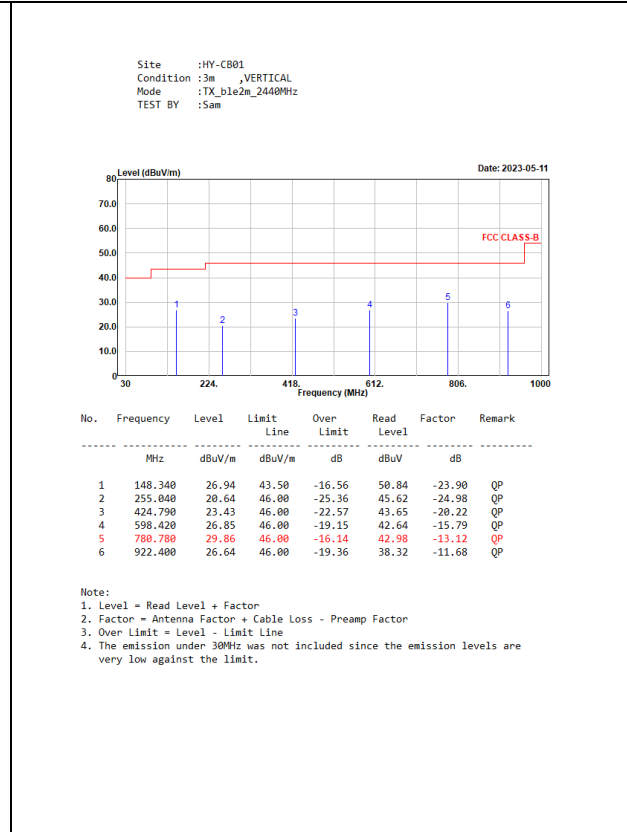
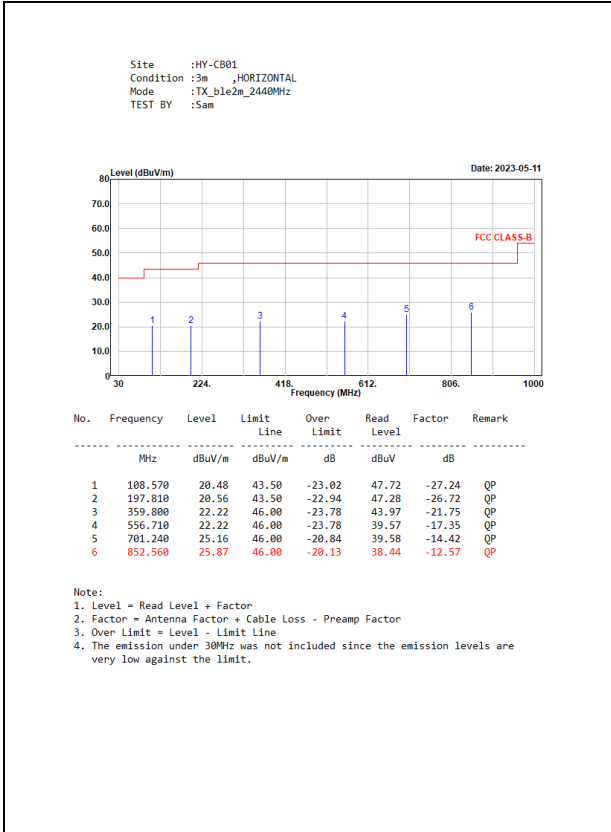

PoE Mode

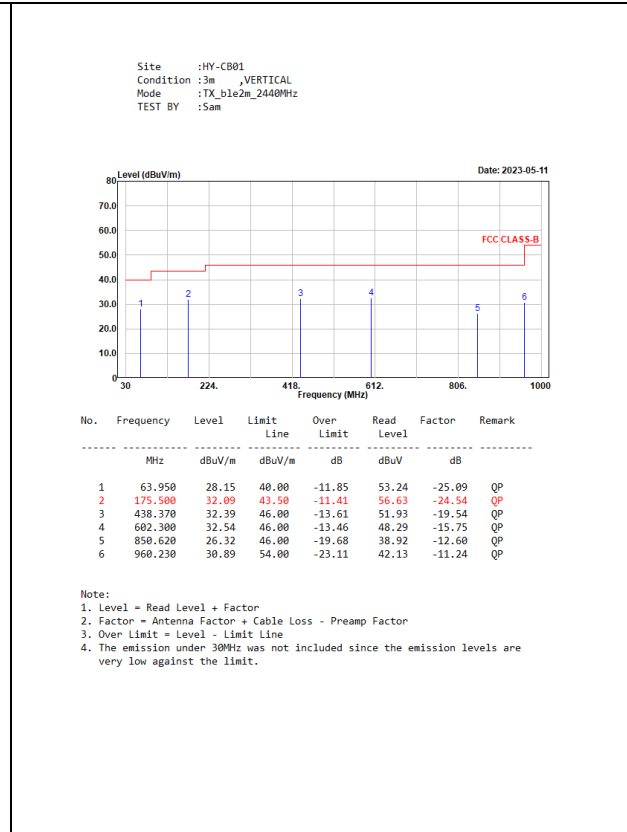
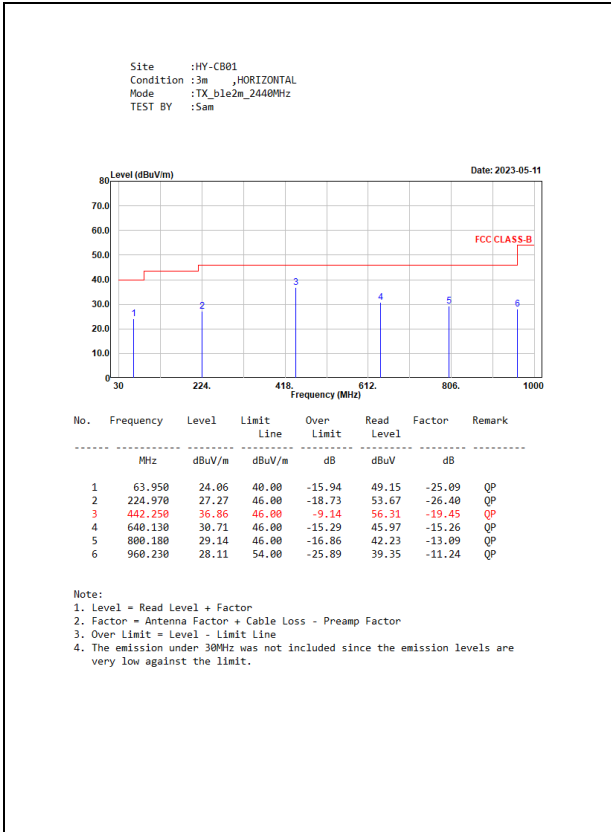

## 5. RF Antenna Conducted Test

### 5.1. Test Setup

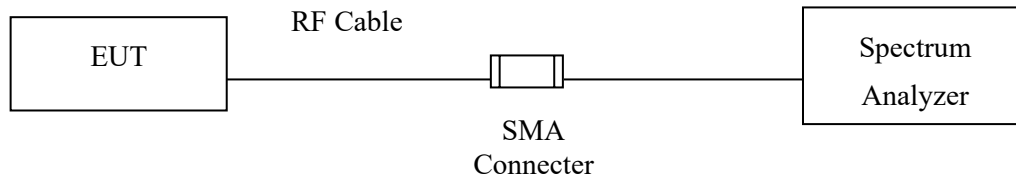

### 5.2. Limits

According to FCC Section 15.247(d). In any 100 kHz bandwidth outside the frequency band in which the spread spectrum or digitally modulated intentional radiator is operating, the radio frequency power that is produced by the intentional radiator shall be at least 20 dB below that in the 100 kHz bandwidth within the band that contains the highest level of the desired power, based on either an RF conducted or measurement, provided the transmitter demonstrates compliance with the peak conducted power limits. If the transmitter complies with the conducted power limits based on the use of RMS averaging over a time interval, the attenuation required under this paragraph shall be 30 dB instead of 20 dB.

### 5.3. Test Procedure

The EUT was tested according to C63.10:2013 Section 11.11 for compliance to FCC 47CFR 15.247 requirements.

Set RBW = 100 kHz, Set VBW > RBW, scan up through 10th harmonic.

5.4. Test Result of RF Antenna Conducted Test

Product : TCx EDGE Cam+  
 Test Item : RF Antenna Conducted Test  
 Test Mode : Transmit - 1 Mbps  
 Test Date : 2023/04/18

Channel 39:

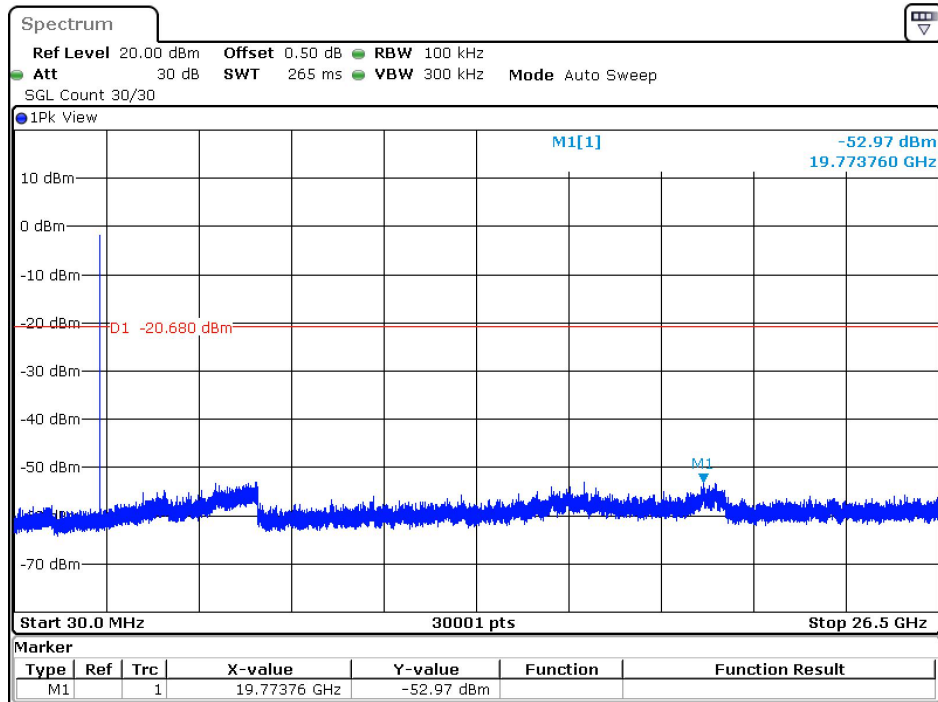

Date: 18.APR.2023 21:15:56

Product : TCx EDGE Cam+  
 Test Item : RF Antenna Conducted Test  
 Test Mode : Transmit - 2 Mbps  
 Test Date : 2023/04/18

Channel 39:

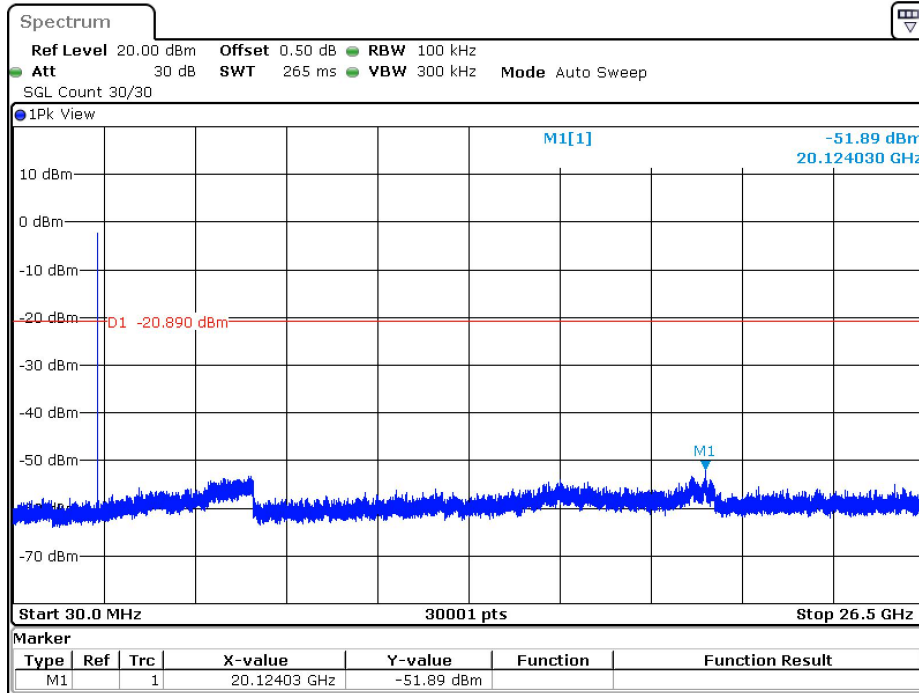

Date: 18.APR.2023 21:21:57

## 6. Band Edge

### 6.1. Test Setup

#### RF Conducted Measurement

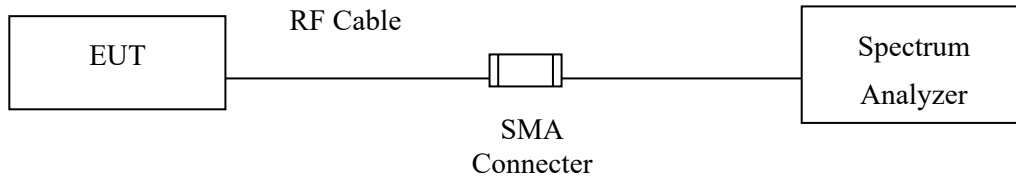

#### RF Radiated Measurement:

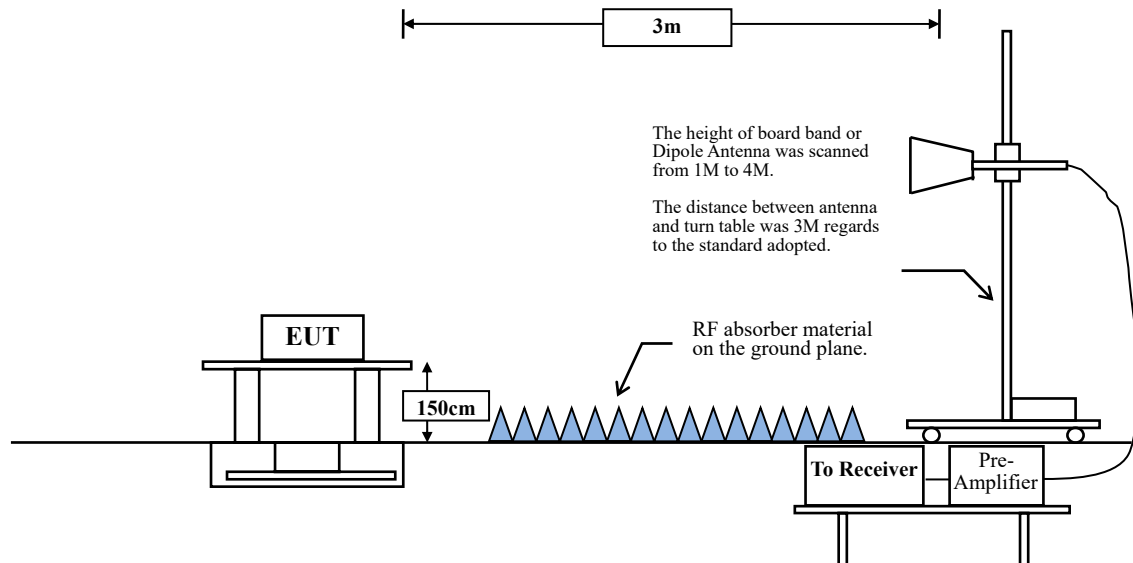

## 6.2. Limit

According to FCC Section 15.247(d). In any 100 kHz bandwidth outside the frequency band in which the spread spectrum or digitally modulated intentional radiator is operating, the radio frequency power that is produced by the intentional radiator shall be at least 20 dB below that in the 100 kHz bandwidth within the band that contains the highest level of the desired power, based on either an RF conducted or measurement, provided the transmitter demonstrates compliance with the peak conducted power limits. If the transmitter complies with the conducted power limits based on the use of RMS averaging over a time interval, the attenuation required under this paragraph shall be 30 dB instead of 20 dB. Attenuation below the general limits specified in Section 15.209(a) is not required. In addition, radiated emissions which fall in the restricted bands, as defined in Section 15.205(a), must also comply with the radiated emission limits specified in Section 15.209(a) (see Section 15.205(c)).

## 6.3. Test Procedure

The EUT was setup according to ANSI C63.10, 2013 and tested according to C63.10:2013 Section 11.12.1 for compliance to FCC 47CFR 15.247 requirements.

The EUT is placed on a turn table which is 1.5 meter above ground. The turn table is rotated 360 degrees to determine the position of the maximum emission level. The EUT was positioned such that the distance from antenna to the EUT was 3 meters.

The antenna is scanned from 1 meter to 4 meters to find out the maximum emission level. This is repeated for both horizontal and vertical polarization of the antenna. In order to find the maximum emission, all of the interface cables were manipulated according to ANSI C63.10:2013 on radiated measurement.



**RBW and VBW Parameter setting:**

According to C63.10 Section 11.12.2.4 Peak measurement procedure.

RBW = as specified in Table 1.

VBW  $\geq$  3 x RBW.

**Table 1 - RBW as a function of frequency**

Frequency	RBW
9-150 kHz	200-300 Hz
0.15-30 MHz	9-10 kHz
30-1000 MHz	100-120 kHz
> 1000 MHz	1 MHz

According to C63.10 Section 11.12.2.5 Average measurement procedure.

RBW = 1 MHz.

VBW = 10 Hz, when duty cycle  $\geq$  98 %

VBW  $\geq$  1/T, when duty cycle < 98 %

(T refers to the minimum transmission duration over which the transmitter is on and is transmitting at its maximum power control level for the tested mode of operation.)

2.4GHz band	Duty Cycle (%)	T (ms)	1/T (Hz)	VBW (Hz)
BLE (1 Mbps)	84.89	2.1240	471	500
BLE (2 Mbps)	56.73	1.0620	942	1000

Note: Duty Cycle Refer to Section 9.

### 6.4. Test Result of Band Edge

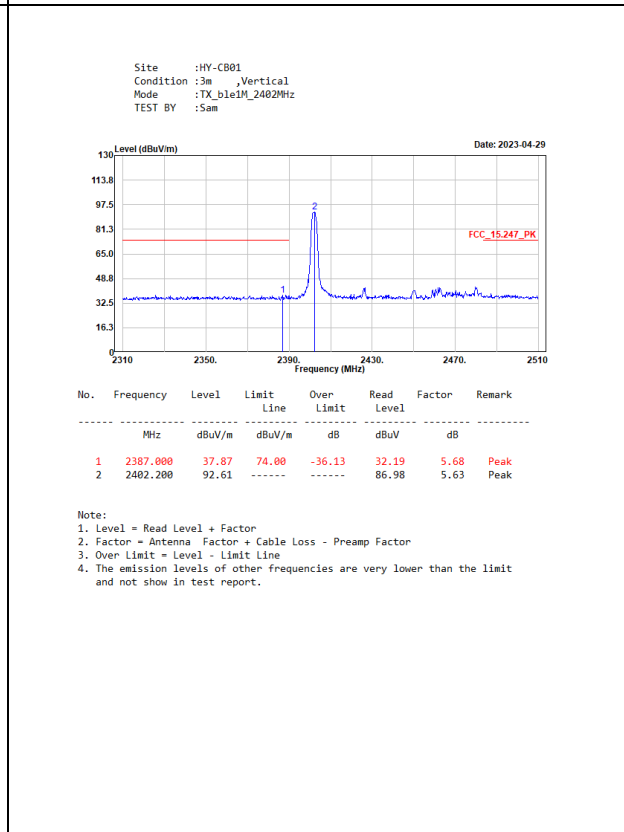
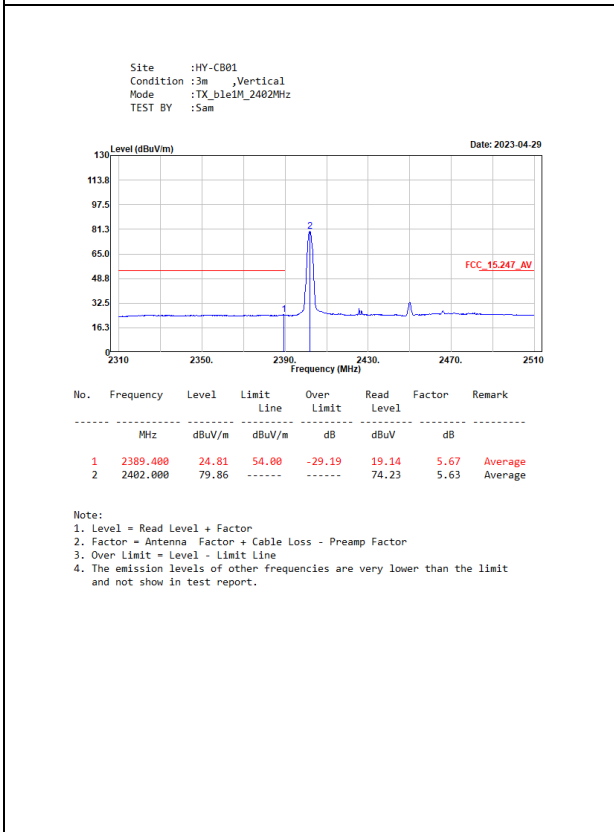
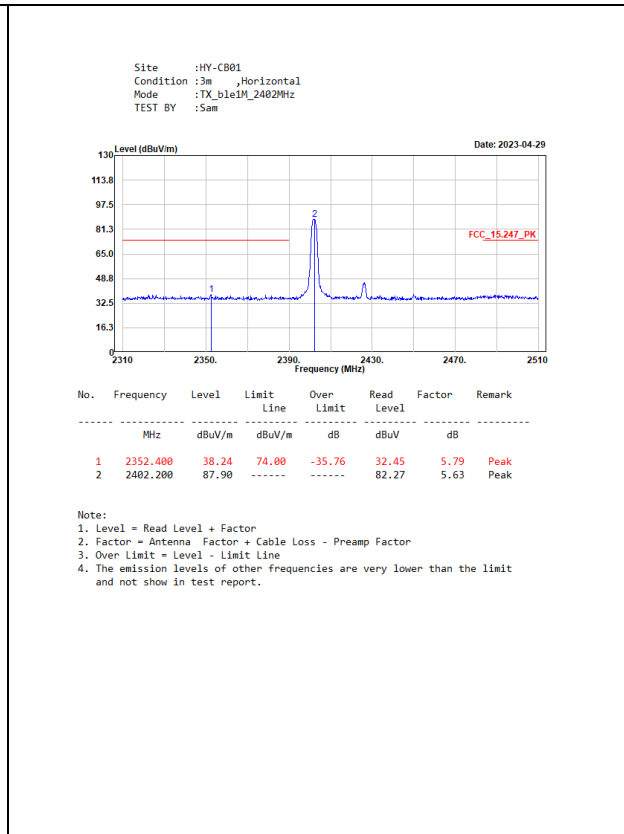
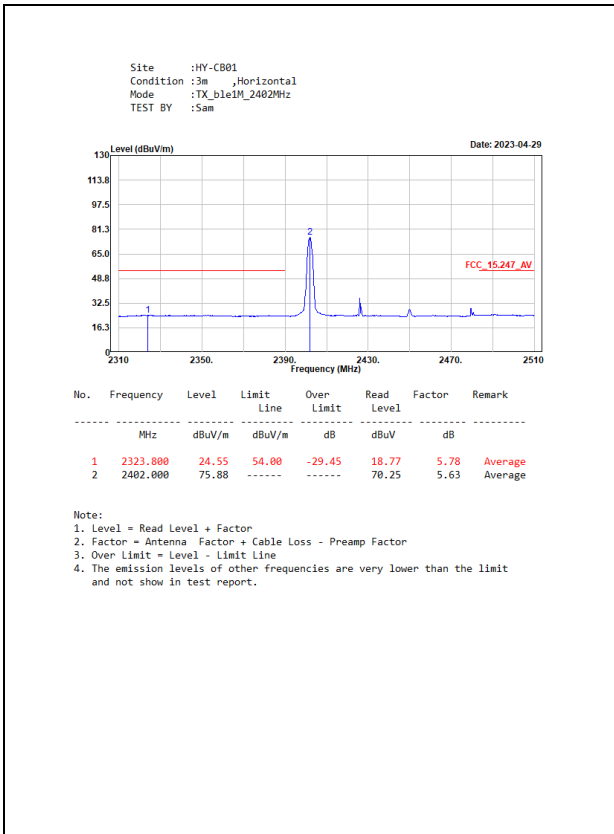

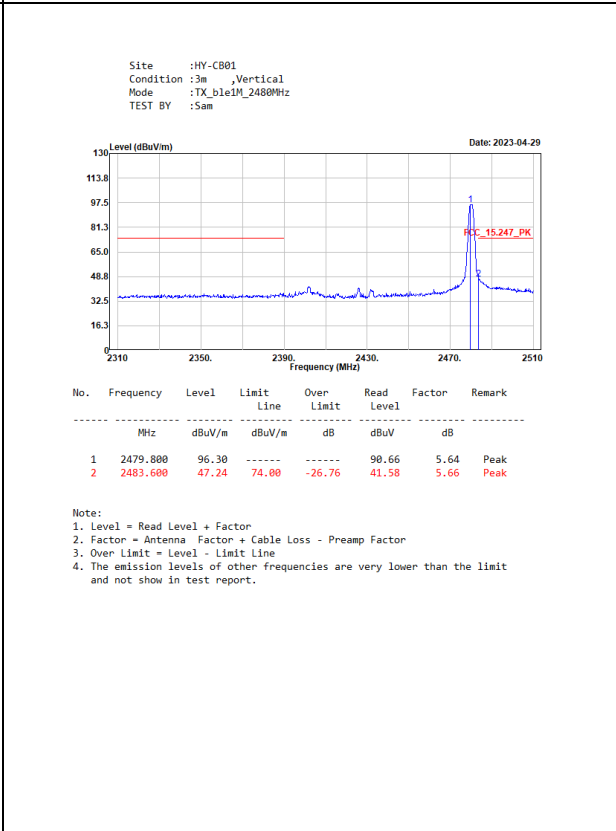
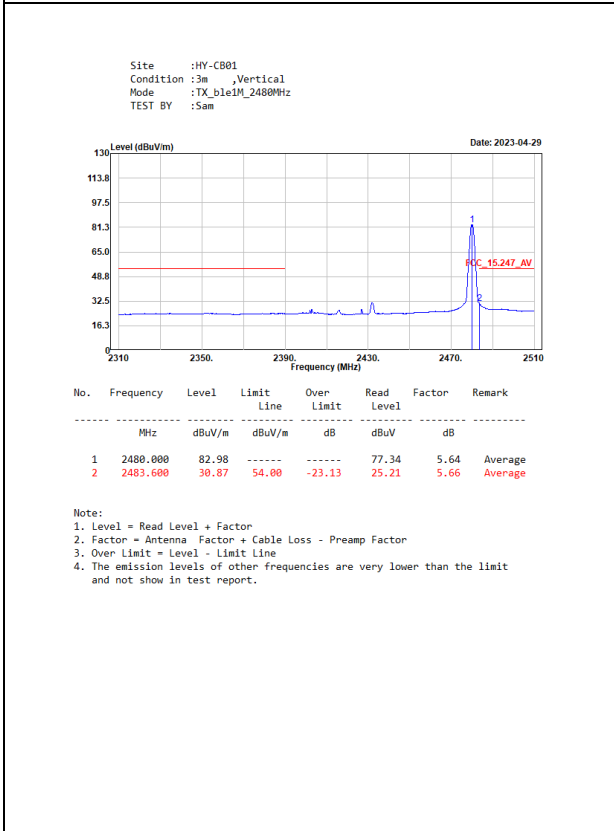
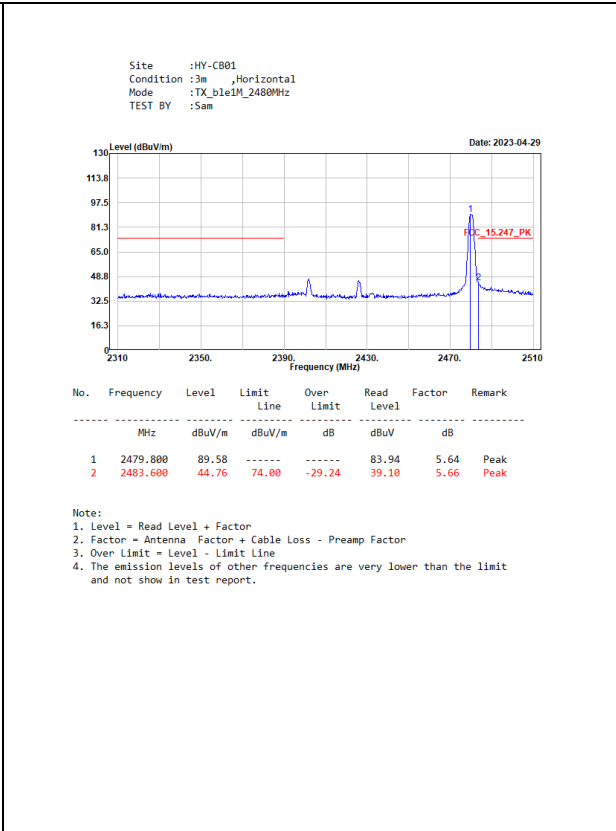
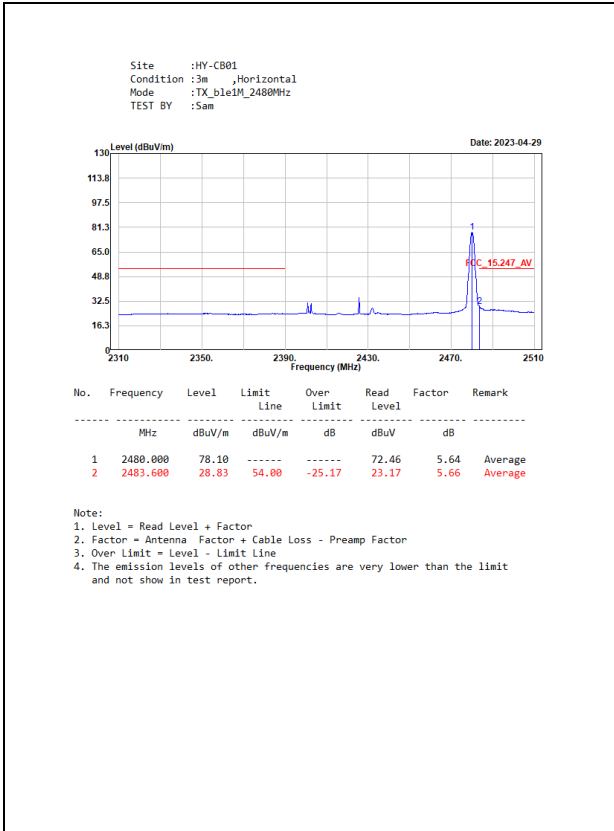

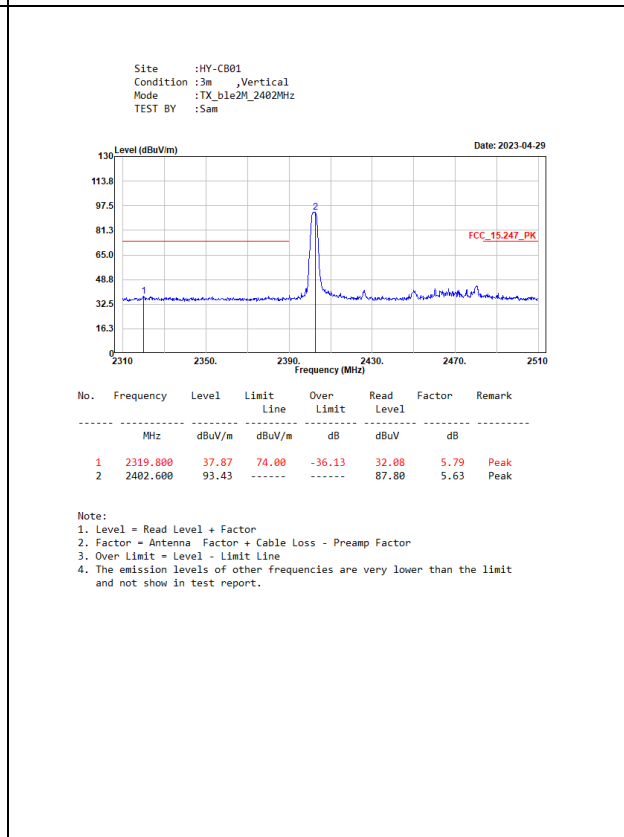
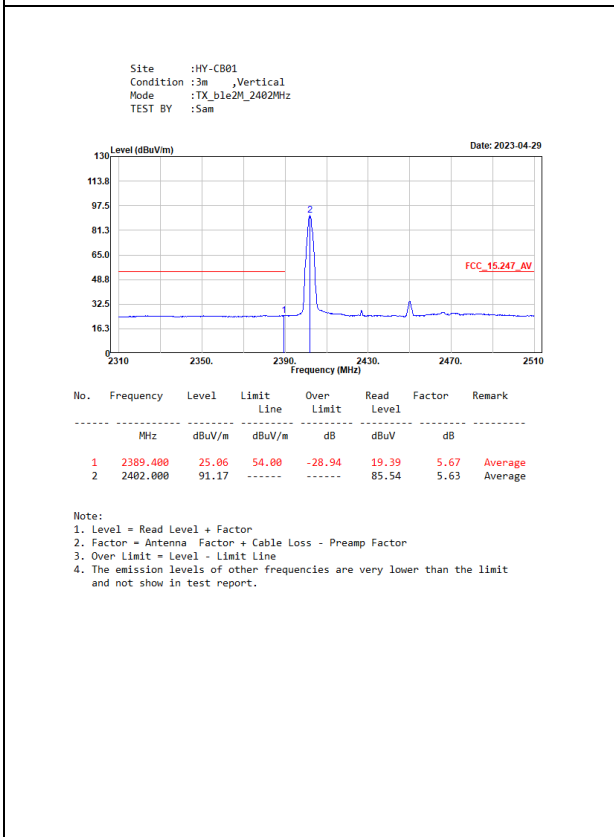
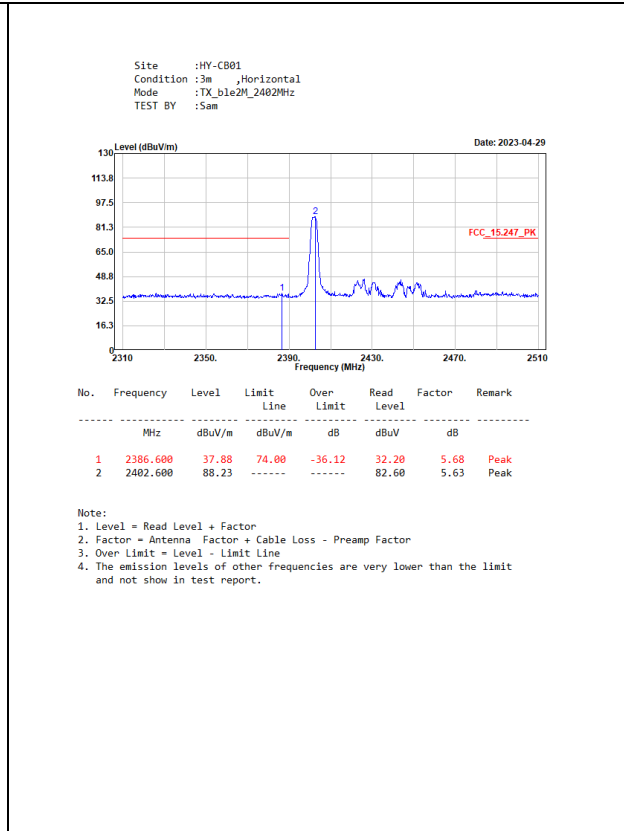
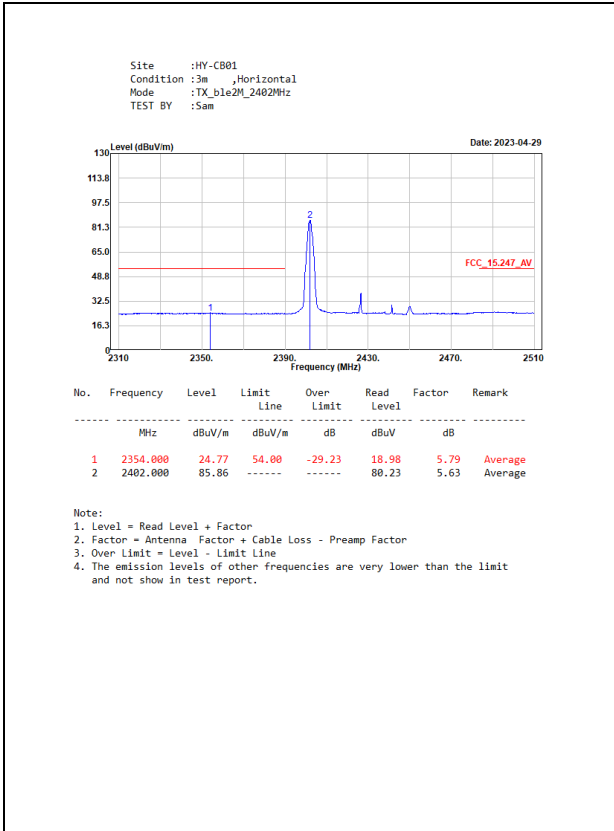

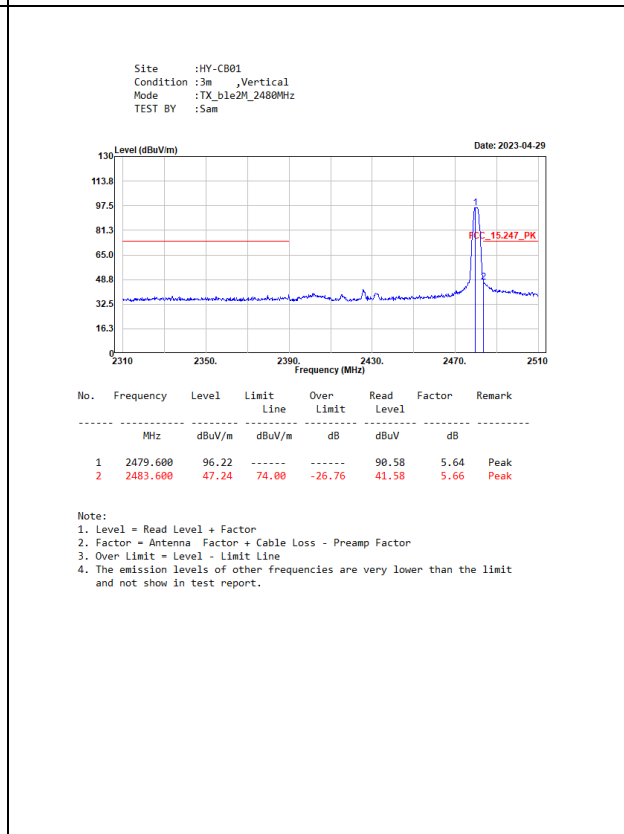
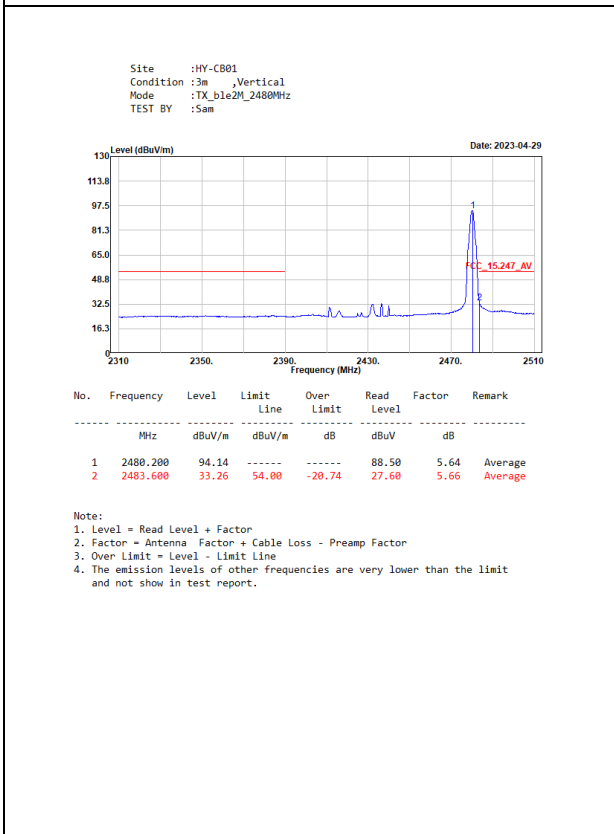
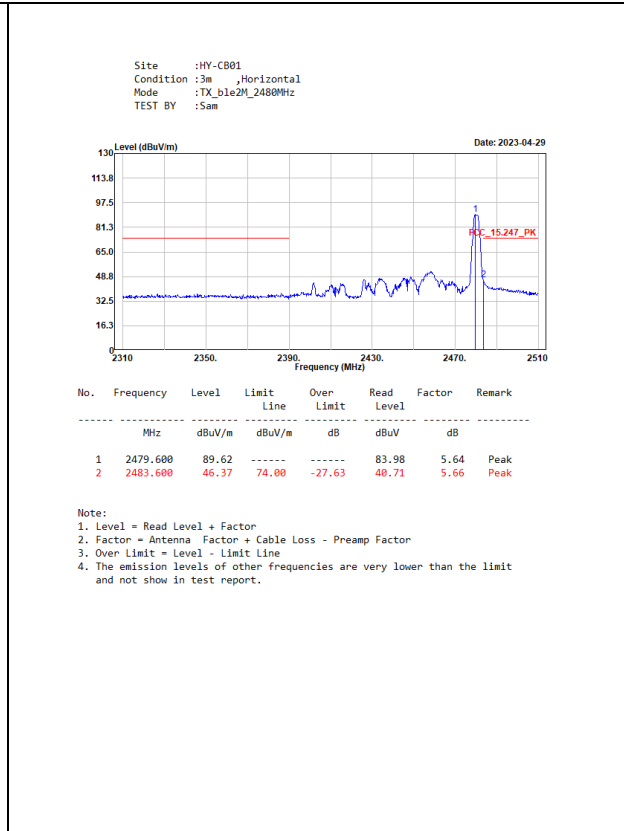
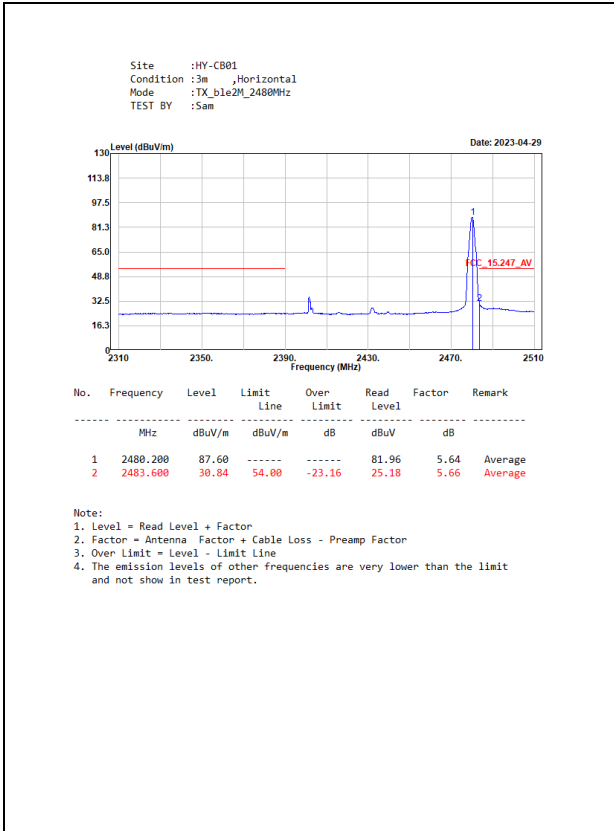

Product : TCx EDGE Cam+  
 Test Item : Band Edge  
 Test Mode : Transmit - 1 Mbps  
 Test Date : 2023/04/18

Measurement Level $\Delta$ (dB)	Result
> 20	PASS

Channel 00:

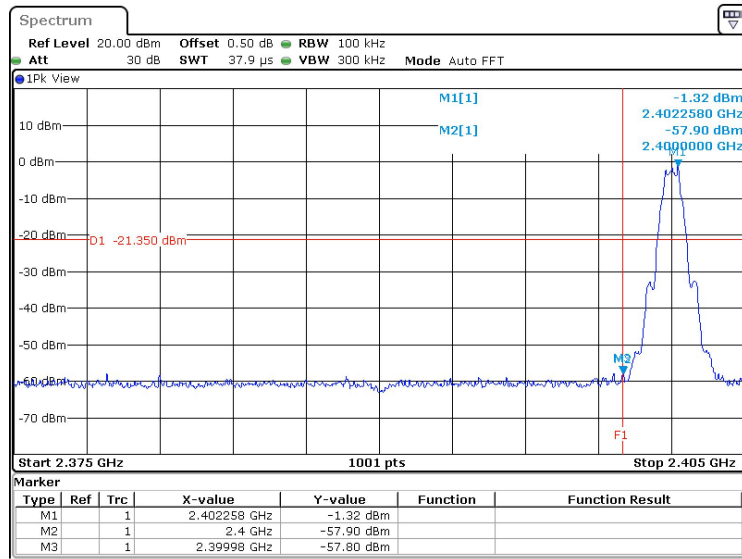

Date: 18.APR.2023 21:11:21

Channel 39:

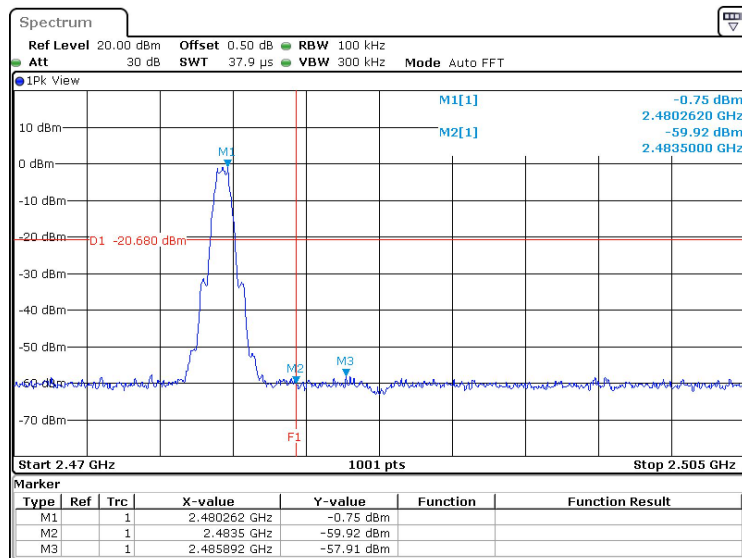

Date: 18.APR.2023 21:15:26

Product : TCx EDGE Cam+  
 Test Item : Band Edge  
 Test Mode : Transmit - 2 Mbps  
 Test Date : 2023/04/18

Measurement Level	Result
$\Delta$ (dB)	
> 20	PASS

Channel 00:

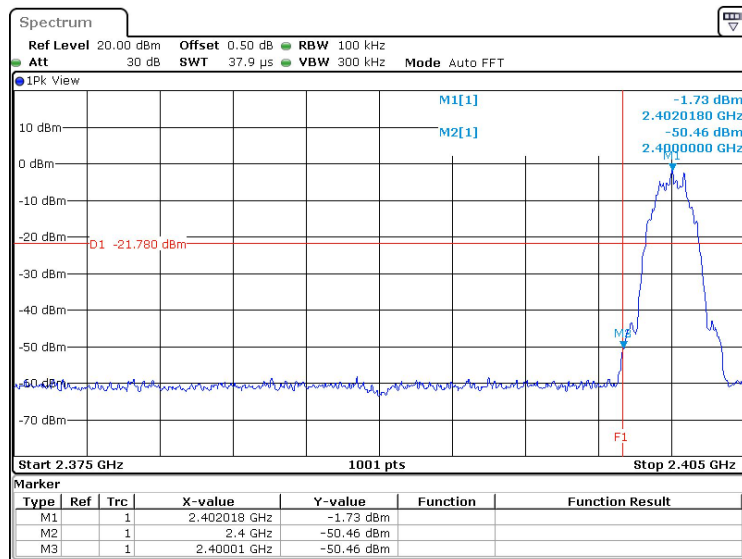

Date: 18.APR.2023 21:17:21

Channel 39:

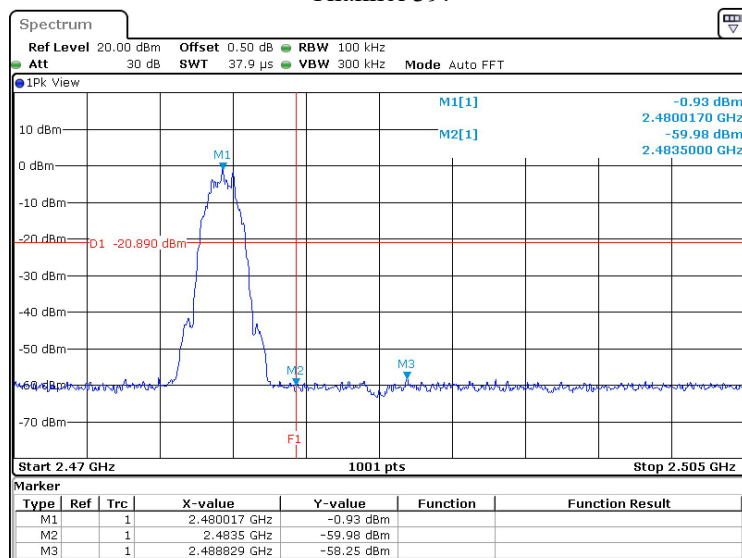

Date: 18.APR.2023 21:21:26

## 7. 6dB Bandwidth

### 7.1. Test Setup

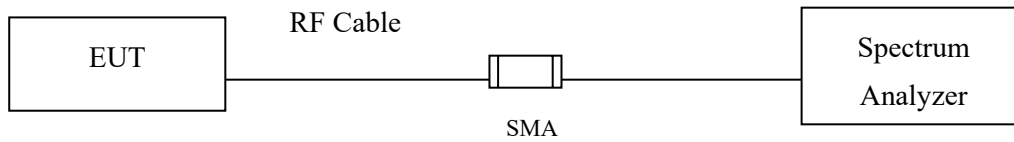

### 7.2. Limits

The minimum bandwidth shall be at least 500 kHz.

### 7.3. Test Procedure

The EUT was setup according to ANSI C63.4, 2014; tested according to ANSI C63.10 Section 11.8 for compliance to FCC 47CFR 15.247 requirements.



7.4. Test Result of 6dB Bandwidth

Product : TCx EDGE Cam+  
 Test Item : 6dB Bandwidth Data  
 Test Mode : Transmit - 1 Mbps  
 Test Date : 2023/04/18

Channel No.	Frequency (MHz)	Measurement Level (kHz)	Required Limit (kHz)	Result
00	2402	659	>500	Pass
19	2440	659	>500	Pass
39	2480	664	>500	Pass

Channel 39:

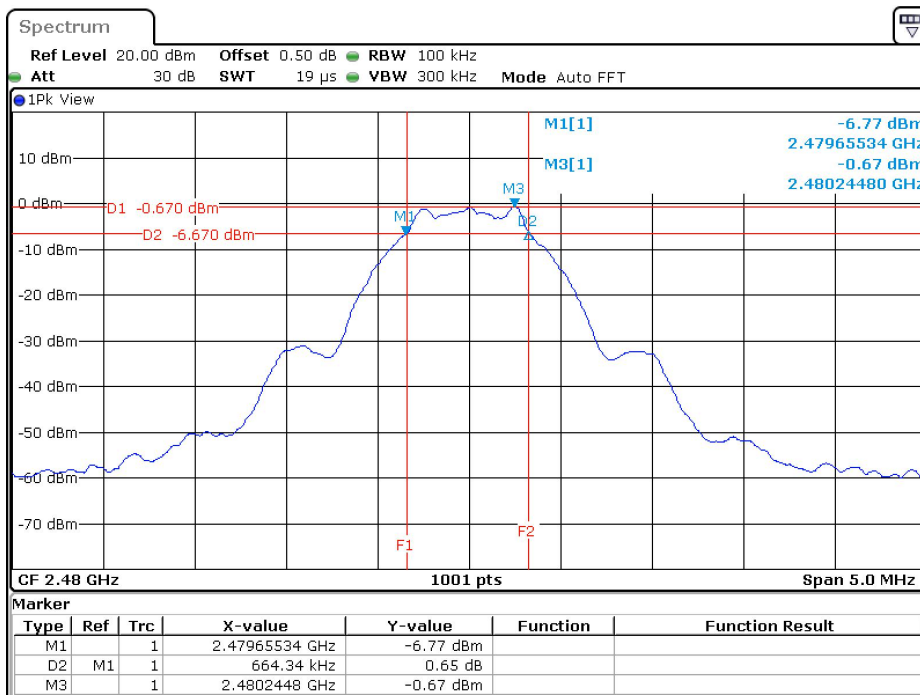

Date: 18.APR.2023 21:14:50

Product : TCx EDGE Cam+  
 Test Item : 6dB Bandwidth Data  
 Test Mode : Transmit - 2 Mbps  
 Test Date : 2023/04/18

Channel No.	Frequency (MHz)	Measurement Level (kHz)	Required Limit (kHz)	Result
00	2402	1143	>500	Pass
19	2440	1148	>500	Pass
39	2480	1153	>500	Pass

Channel 39:

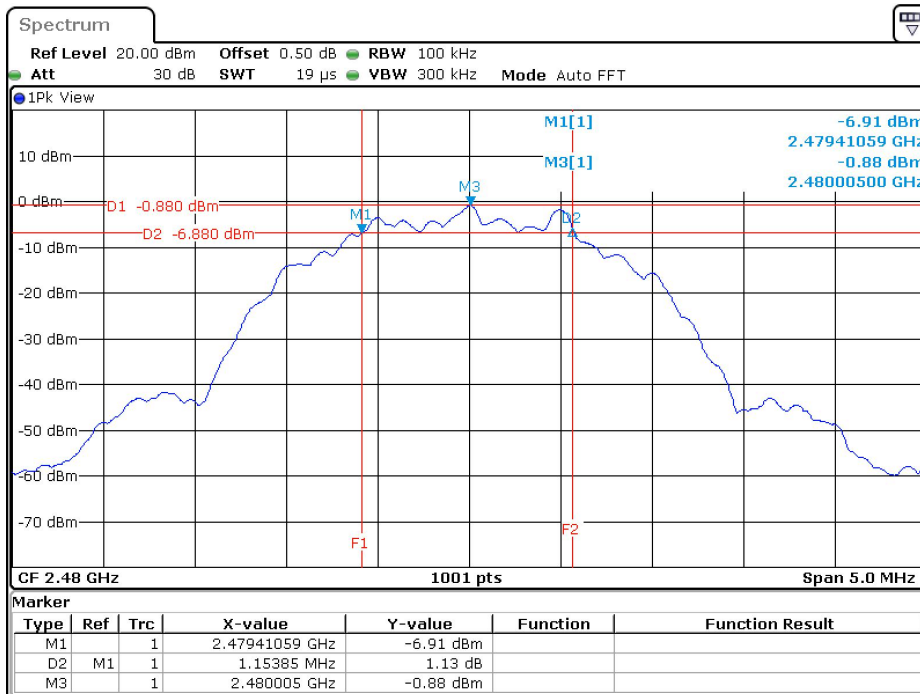

Date: 18.APR.2023 21:20:50

## 8. Power Density

### 8.1. Test Setup

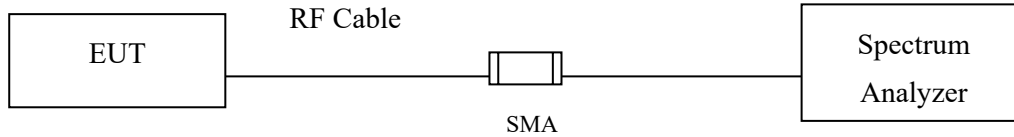

### 8.2. Limits

The transmitted power density averaged over any 1 second interval shall not be greater +8dBm in any 3 kHz bandwidth.

### 8.3. Test Procedure

The EUT was setup according to ANSI C63.10, 2013; tested according to DTS test procedure of KDB 558074 for compliance to FCC 47CFR 15.247 requirements.

The maximum power spectral density using C63.10 Section 11.10.2 Method PKPSD (peak PSD)

8.4. Test Result of Power Density

Product : TCx EDGE Cam+  
 Test Item : Power Density Data  
 Test Mode : Transmit - 1 Mbps  
 Test Date : 2023/04/18

Channel No.	Frequency (MHz)	Measurement Level (dBm)	Limit (dBm)	Result
00	2402	-17.89	≤ 8dBm	Pass
19	2440	-17.46	≤ 8dBm	Pass
39	2480	-17.01	≤ 8dBm	Pass

Channel 39:

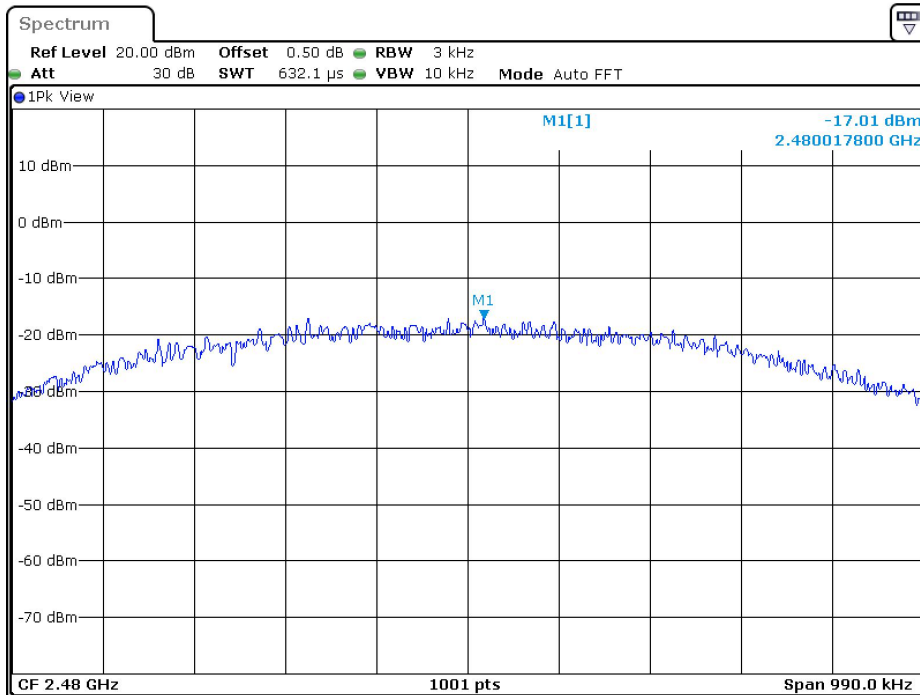

Date: 18.APR.2023 21:15:08

Product : TCx EDGE Cam+  
 Test Item : Power Density Data  
 Test Mode : Transmit - 2 Mbps  
 Test Date : 2023/04/18

Channel No.	Frequency (MHz)	Measure Level (dBm)	Limit (dBm)	Result
00	2402	-20.58	≤ 8dBm	Pass
19	2440	-20.14	≤ 8dBm	Pass
39	2480	-19.59	≤ 8dBm	Pass

Channel 39:

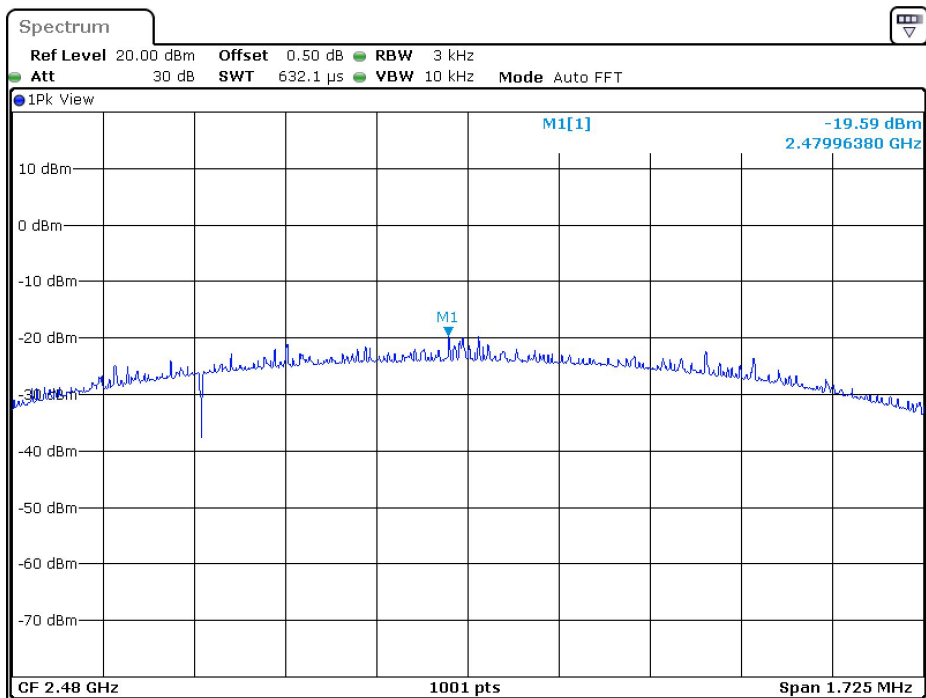

Date: 18.APR.2023 21:21:09

## 9. Duty Cycle

### 9.1. Test Setup

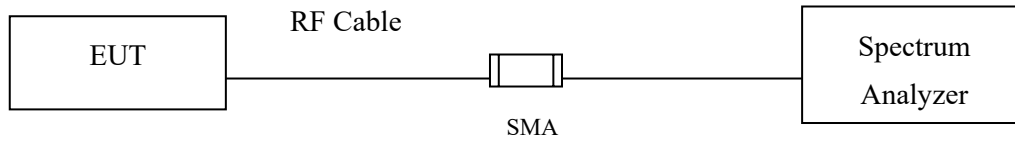

### 9.2. Test Procedure

The EUT was setup according to ANSI C63.10 2013; tested according to ANSI C63.10 2013 for compliance to FCC 47CFR 15.247 requirements.

### 9.3. Test Result of Duty Cycle

Product : TCx EDGE Cam+  
 Test Item : Duty Cycle  
 Test Mode : Transmit - 1 Mbps

Formula:

$$\text{Duty Cycle} = \text{Ton} / (\text{Ton} + \text{Toff})$$

$$\text{Duty Factor} = 10 \text{ Log} (1/\text{Duty Cycle})$$

2.4 GHz Band	Ton (ms)	Ton + Toff (ms)	Duty Cycle (%)	Duty Factor (dB)
BLE (1 Mbps)	2.1240	2.5020	84.89	0.71

BLE 1 Mbps

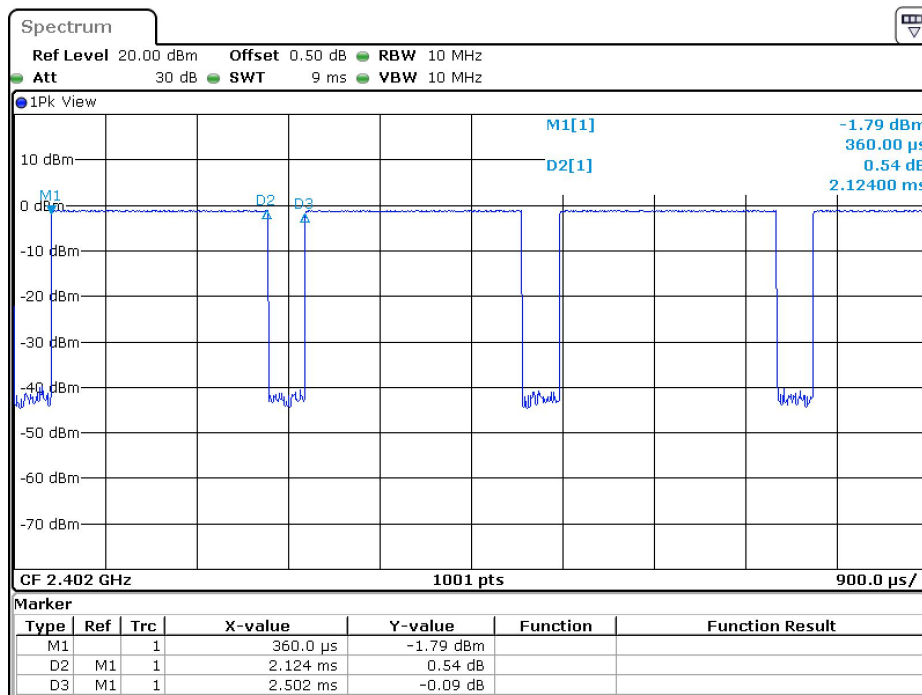

Date: 18.APR.2023 21:10:21

Product : TCx EDGE Cam+  
 Test Item : Duty Cycle  
 Test Mode : Transmit - 2 Mbps

Formula:

$$\text{Duty Cycle} = \text{Ton} / (\text{Ton} + \text{Toff})$$

$$\text{Duty Factor} = 10 \text{ Log} (1/\text{Duty Cycle})$$

2.4 GHz Band	Ton (ms)	Ton + Toff (ms)	Duty Cycle (%)	Duty Factor (dB)
BLE (2 Mbps)	1.0620	1.8720	56.73	2.46

### BLE 2 Mbps

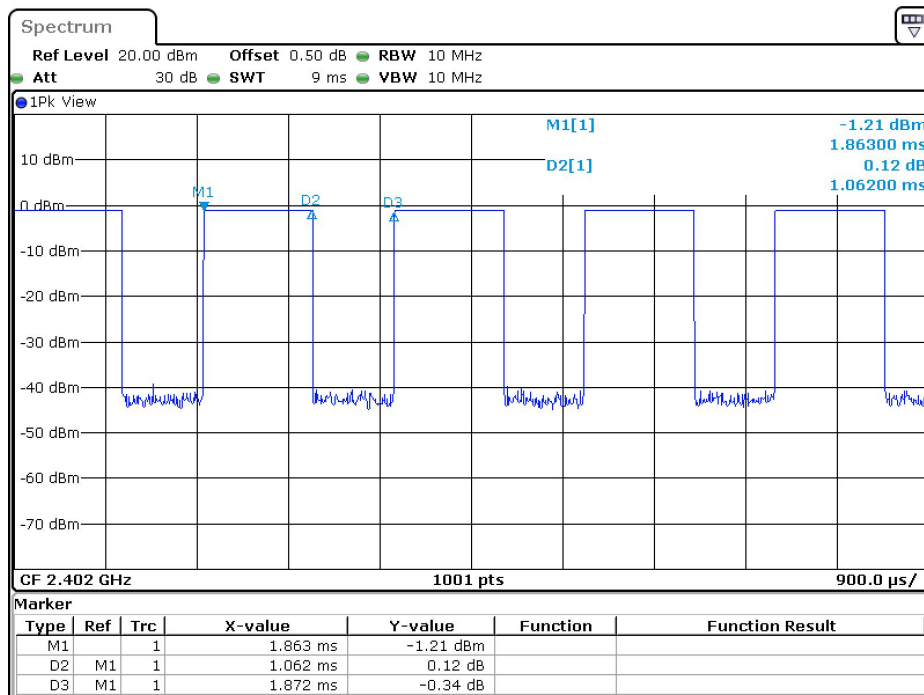

Date: 18.APR.2023 21:16:23