



Test report No.: 2340335R-RFUSV01S-B

TEST REPORT

Product Name	TCx EDGE Cam+
Trademark	TOSHIBA
Model and /or type reference	6260-002
FCC ID	2AW3T-6260-002
Applicant's name / address	Toshiba Global Commerce Solutions, Inc. 3901 South Miami Blvd., Durham, North Carolina United States 27703
Manufacturer's name	Toshiba Global Commerce Solutions, Inc.
Test method requested, standard	FCC CFR Title 47 Part 15 Subpart C ANSI C63.4: 2014, ANSI C63.10: 2013
Verdict Summary	IN COMPLIANCE
Documented By (Senior Project Specialist / Genie Chang)	<i>Genie Chang</i>
Tested By (Senior Engineer / Bill Lin)	<i>Bill Lin</i>
Approved By (Senior Engineer / Alan Chen)	<i>Alan Chen</i>
Date of Receipt	2023/04/13
Date of Issue	2023/05/19
Report Version	V1.0

INDEX

	Page
1. General Information	6
1.1. EUT Description.....	6
1.2. Tested System Details.....	8
1.3. Configuration of Tested System	8
1.4. EUT Exercise Software	10
1.5. Test Facility	11
1.6. List of Test Equipment.....	12
1.7. Uncertainty	13
2. Conducted Emission	14
2.1. Test Setup	14
2.2. Limits.....	14
2.3. Test Procedure	15
2.4. Test Result of Conducted Emission.....	16
3. Peak Power Output	17
3.1. Test Setup	17
3.2. Limit	17
3.3. Test Procedure	17
3.4. Test Result of Peak Power Output.....	18
4. Radiated Emission	20
4.1. Test Setup	20
4.2. Limits.....	21
4.3. Test Procedure	22
4.4. Test Result of Radiated Emission.....	23
5. RF Antenna Conducted Test.....	27
5.1. Test Setup	27
5.2. Limits.....	27
5.3. Test Procedure	27
5.4. Test Result of RF Antenna Conducted Test.....	28
6. Band Edge	30
6.1. Test Setup	30
6.2. Limit	31

6.3.	Test Procedure	31
6.4.	Test Result of Band Edge	32
7.	Channel Number	44
7.1.	Test Setup	44
7.2.	Limit	44
7.3.	Test Procedure	44
7.4.	Test Result of Channel Number.....	45
8.	Channel Separation	47
8.1.	Test Setup	47
8.2.	Limit	47
8.3.	Test Procedure	47
8.4.	Test Result of Channel Separation.....	48
9.	Dwell Time.....	50
9.1.	Test Setup	50
9.2.	Limit	50
9.3.	Test Procedure	50
9.4.	Test Result of Dwell Time	51
10.	Occupied Bandwidth	53
10.1.	Test Setup	53
10.2.	Limits.....	53
10.3.	Test Procedure	53
10.4.	Test Result of Occupied Bandwidth	54
11.	Duty Cycle.....	56
11.1.	Test Setup	56
11.2.	Test Result of Duty Cycle.....	57

Appendix 1: EUT Test Photographs

Appendix 2: Product Photos-Please refer to the file: 2340335R-Product Photos

Competences and Guarantees

DEKRA is a testing laboratory competent to carry out the tests described in this report.

In order to assure the traceability to other national and international laboratories, DEKRA has a calibration and maintenance program for its measurement equipment.

DEKRA guarantees the reliability of the data presented in this report, which is the result of the measurements and the tests performed to the item under test on the date and under the conditions stated in the report and it is based on the knowledge and technical facilities available at DEKRA at the time of performance of the test.

DEKRA is liable to the client for the maintenance of the confidentiality of all information related to the item under test and the results of the test.

The results presented in this Test Report apply only to the particular item under test established in this document.

IMPORTANT: No parts of this report may be reproduced or quoted out of context, in any form or by any means, except in full, without the previous written permission of DEKRA.

General conditions

1. The test results relate only to the samples tested.
2. The test results shown in the test report are traceable to the national/international standard through the calibration report of the equipment and evaluated measurement uncertainty herein.
3. This report must not be used to claim product endorsement by TAF or any agency of the government.
4. The test report shall not be reproduced without the written approval of DEKRA Testing and Certification Co., Ltd.
5. Measurement uncertainties evaluated for each testing system and associated connections are given here to provide the system information for reference. Compliance determinations do not take into account measurement uncertainties for each testing system, but are based on the results of the compliance measurement.

Revision History

Report No.	Version	Description	Issued Date
2340335R-RFUSV01S-B	V1.0	Initial issue of report.	2023/05/19

1. General Information

1.1. EUT Description

Product Name	TCx EDGE Cam+
Trademark	TOSHIBA
Model and /or type reference	6260-002
EUT Rated Voltage	PoE, 48-57V $\overline{=}$ / 25.5W max USB 12V $\overline{=}$ 2.25A / 9V $\overline{=}$ 3A / 27W max
EUT Test Voltage	DC 12V (by USB-Type C) DC 48V (by PoE)
Frequency Range	2402 - 2480 MHz
Channel Number	79 CH
Type of Modulation	GFSK(1 Mbps) / π /4DQPSK(2 Mbps) / 8DPSK(3 Mbps)
Channel Control	Auto
USB Cable	Shielded, 2.5m
RJ45 Cable	Non-shielded, 4.3m
Mounting Pipe	N/A

Antenna List

No.	Manufacturer	Part No.	Antenna Type	Peak Gain
1	Pulse	TZ2531W (Main)	PIFA	2.7 dBi for 2400 MHz
		TZ2530W (Aux)		3.3 dBi for 2400 MHz

Note: The antenna of EUT conforms to FCC 15.203.

Center Frequency of Each Channel:

Channel	Frequency (MHz)	Channel	Frequency (MHz)	Channel	Frequency (MHz)	Channel	Frequency (MHz)
00	2402	01	2403	02	2404	03	2405
04	2406	05	2407	06	2408	07	2409
08	2410	09	2411	10	2412	11	2413
12	2414	13	2415	14	2416	15	2417
16	2418	17	2419	18	2420	19	2421
20	2422	21	2423	22	2424	23	2425
24	2426	25	2427	26	2428	27	2429
28	2430	29	2431	30	2432	31	2433
32	2434	33	2435	34	2436	35	2437
36	2438	37	2439	38	2440	39	2441
40	2442	41	2443	42	2444	43	2445
44	2446	45	2447	46	2448	47	2449
48	2450	49	2451	50	2452	51	2453
52	2454	53	2455	54	2456	55	2457
56	2458	57	2459	58	2460	59	2461
60	2462	61	2463	62	2464	63	2465
64	2466	65	2467	66	2468	67	2469
68	2470	69	2471	70	2472	71	2473
72	2474	73	2475	74	2476	75	2477
76	2478	77	2479	78	2480	--	--

Note:

1. The EUT is a TCx EDGE Cam+ with built-in WLAN and Bluetooth transceiver, this report for Bluetooth V2.1+EDR.
2. The radiation measurements are performed in X, Y, Z axis positioning. Only the worst case is shown in the report.
3. Regarding to the operation frequency, the lowest, middle and highest frequency are selected to perform the test.
4. DEKRA has evaluated each test mode. Only the worst case is shown in the report.
5. These tests were conducted on a sample for the purpose of demonstrating compliance of transmitter with Part 15 Subpart C Paragraph 15.247 for spread spectrum devices.
6. The test mode is based on the Bluetooth technology, while testing 1Mbps, 2Mbps and 3Mbps, the worst case is 1Mbps and 3Mbps, and only worse case data is recorded in this report.

Test Mode	Mode 1	Transmit - 1 Mbps
		Transmit - 3 Mbps

1.2. Tested System Details

The types for all equipment, plus descriptions of all cables used in the tested system (including inserted cards) are:

PD Mode

Product	Manufacturer	Model No.	Serial No.	Power Cord
1 Power Adapter	DELTA	DPS-180AB-21	N/A	N/A
2 Point of Sale System	TOSHIBA	6201-25C	N/A	N/A
3 Mounting Pipe	N/A	N/A	N/A	N/A

Cable Type	Cable Description
A Power Cable	Non-shielded, 1.5m, with two ferrite cores bonded.
B USB-Type C Cable	Shielded, 2.5m

PoE Mode

Product	Manufacturer	Model No.	Serial No.	Power Cord
1 Power Adapter	NETGEAR	2ACL068S	N/A	N/A
2 PoE Switch	NETGEAR	GS305Pv2	N/A	N/A
3 Notebook PC	DELL	Latitude E5440	FS9TK32	N/A

Cable Type	Cable Description
A Power Cable	Non-shielded, 1.5m
B LAN Cable	Non-shielded, 4.2m
C USB-Type C Cable	Shielded, 2.5m

1.3. Configuration of Tested System

PD Mode

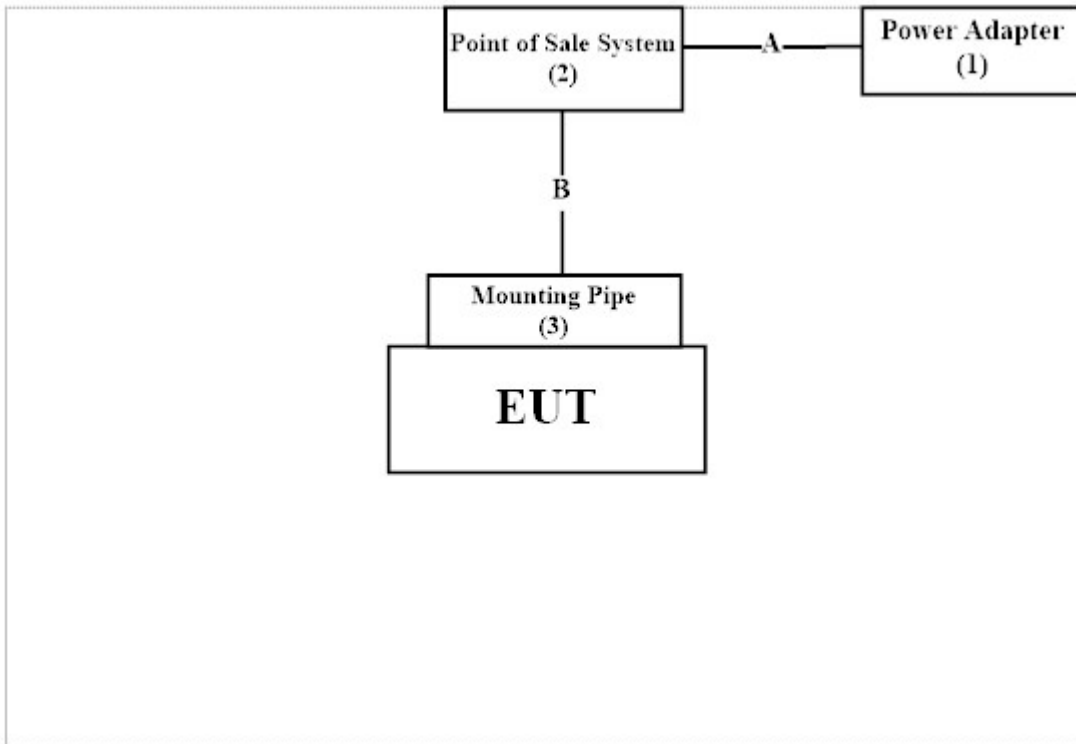

PoE Mode

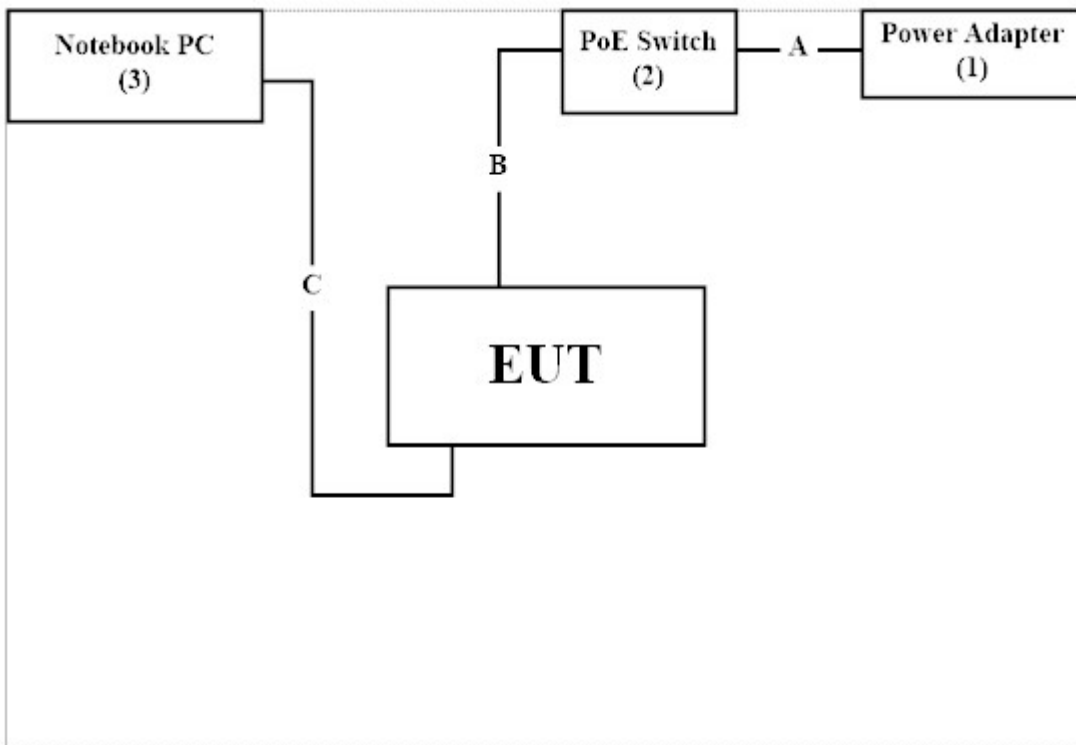

1.4. EUT Exercise Software

1	Setup the EUT as shown in Section 1.3.
2	Execute software “QRCT Ver. 4.0.210.0” on the Notebook PC.
3	Configure the test mode, the test channel, and the data rate.
4	Press “OK” to start the continuous transmit.
5	Verify that the EUT works properly.

1.5. Test Facility

Ambient conditions in the laboratory:

Performed Item	Items	Required	Actual
Conducted Emission	Temperature (°C)	10~40 °C	23.8 °C
	Humidity (%RH)	10~90 %	52.2 %
Radiated Emission	Temperature (°C)	10~40 °C	23.4 °C
	Humidity (%RH)	10~90 %	66.8 %
Conductive	Temperature (°C)	10~40 °C	24.5 °C
	Humidity (%RH)	10~90 %	59.0 %

USA	FCC Registration Number: TW0033
Canada	CAB Identifier Number: TW3023 / Company Number: 26930

Site Description	Accredited by TAF
	Accredited Number: 3023

Test Laboratory	DEKRA Testing and Certification Co., Ltd.
	Linkou Laboratory
Address	No.5-22, Ruishukeng Linkou District, New Taipei City, 24451, Taiwan, R.O.C
Performed Location	No. 26, Huaya 1st Rd., Guishan Dist., Taoyuan City 333411, Taiwan, R.O.C.
Phone Number	+886-3-275-7255
Fax Number	+886-3-327-8031

1.6. List of Test Equipment

For Conduction Measurements / HY-SR01

	Equipment	Manufacturer	Model No.	Serial No.	Cal. Date	Due Date
V	EMI Test Receiver	R&S	ESR7	101601	2022/06/23	2023/06/22
V	Two-Line V-Network	R&S	ENV216	101306	2023/03/16	2024/03/15
V	Two-Line V-Network	R&S	ENV216	101307	2022/07/04	2023/07/03
V	Coaxial Cable	SUHNER	RG400 BNC	RF001	2022/05/24	2023/05/23

Note:

1. All equipments are calibrated every one year.
2. The test instruments marked with “V” are used to measure the final test results.
3. Test Software Version: e3 230303 dekra V9.

For Conducted Measurements / HY-SR02

	Equipment	Manufacturer	Model No.	Serial No.	Cal. Date	Due Date
V	Spectrum Analyzer	R&S	FSV30	103466	2022/12/22	2023/12/21
V	Peak Power Analyzer	KEYSIGHT	8990B	MY51000410	2022/08/06	2023/08/05
V	Wideband Power Sensor	KEYSIGHT	N1923A	MY56080003	2022/08/05	2023/08/04
V	Wideband Power Sensor	KEYSIGHT	N1923A	MY56080004	2022/08/05	2023/08/04

Note:

1. All equipments are calibrated every one year.
2. The test instruments marked with “V” are used to measure the final test results.
3. Test Software Version: RF Conducted Test Tools R3 V3.0.1.14.

For Radiated Measurements / HY-CB01

	Equipment	Manufacturer	Model No.	Serial No.	Cal. Date	Due Date
V	Loop Antenna	AMETEK	HLA6121	49611	2023/02/21	2024/02/20
V	Bi-Log Antenna	SCHWARZBECK	VULB9168	9168-0675	2021/08/11	2023/08/10
V	Horn Antenna	RF SPIN	DRH18-E	210802A18ES	2023/03/23	2024/03/22
V	Horn Antenna	Com-Power	AH-840	101101	2021/11/30	2023/11/29
V	Pre-Amplifier	SGH	0301	20211007-7	2023/01/10	2024/01/09
V	Pre-Amplifier	EMCI	EMC051845SE	980632	2023/01/10	2024/01/09
V	Pre-Amplifier	EMCI	EMC05820SE	980361	2023/01/10	2024/01/09
	Pre-Amplifier	EMCI	EMC184045SE	980369	2023/01/10	2024/01/09
V	Coaxial Cable	EMCI	EMC102-KM-KM-600	1160314		
	Coaxial Cable	EMCI	EMC102-KM-KM-7000	170242		
V	Filter	MICRO TRONICS	BRM50702	G251	2023/01/05	2024/01/04
	Filter	MICRO TRONICS	BRM50716	067	2023/01/05	2024/01/04
V	EMI Test Receiver	R&S	ESR3	102792	2022/12/29	2023/12/28
V	Spectrum Analyzer	R&S	FSV3044	101115	2023/01/06	2024/01/05
V	Coaxial Cable	SUHNER	SUCOFLEX 106	25450/6	2023/01/10	2024/01/09
	Coaxial Cable	SGH	HA800	GD20110222-8		
	Coaxial Cable	SGH	SGH18	2021003-8		
	Coaxial Cable	EMCI	EMC106	151113		

Note:

1. Bi-Log Antenna and Horn Antenna(AH-840) is calibrated every two years, the other equipments are calibrated every one year.
2. The test instruments marked with “V” are used to measure the final test results.
3. Test Software Version: e3 230303 dekra V9.

1.7. Uncertainty

Uncertainties have been calculated according to the DEKRA internal document.

The reported expanded uncertainties are based on a standard uncertainty multiplied by a coverage factor of $k=2$, providing a level of confidence of approximately 95%.

Measurement uncertainties evaluated for each testing system and associated connections are given here to provide the system information for reference. Compliance determinations do not take into account measurement uncertainties for each testing system but are based on the results of the compliance measurement.

Test item	Uncertainty
Conducted Emission	± 3.50 dB
Peak Power Output	Spectrum Analyzer: ± 2.14 dB Power Meter: ± 1.05 dB
Radiated Emission	9 kHz~30 MHz: ± 3.88 dB 30 MHz~1 GHz: ± 4.42 dB 1 GHz~18 GHz: ± 4.28 dB 18 GHz~40 GHz: ± 3.90 dB
RF Antenna Conducted Test	± 2.14 dB
Band Edge	9 kHz~30 MHz: ± 3.88 dB 30 MHz~1 GHz: ± 4.42 dB 1 GHz~18 GHz: ± 4.28 dB 18 GHz~40 GHz: ± 3.90 dB
Channel Number	N/A
Channel Separation	± 1580.61 Hz
Dwell Time	± 0.53 %
Occupied Bandwidth	± 1580.61 Hz
Duty Cycle	± 0.53 %

2. Conducted Emission

2.1. Test Setup

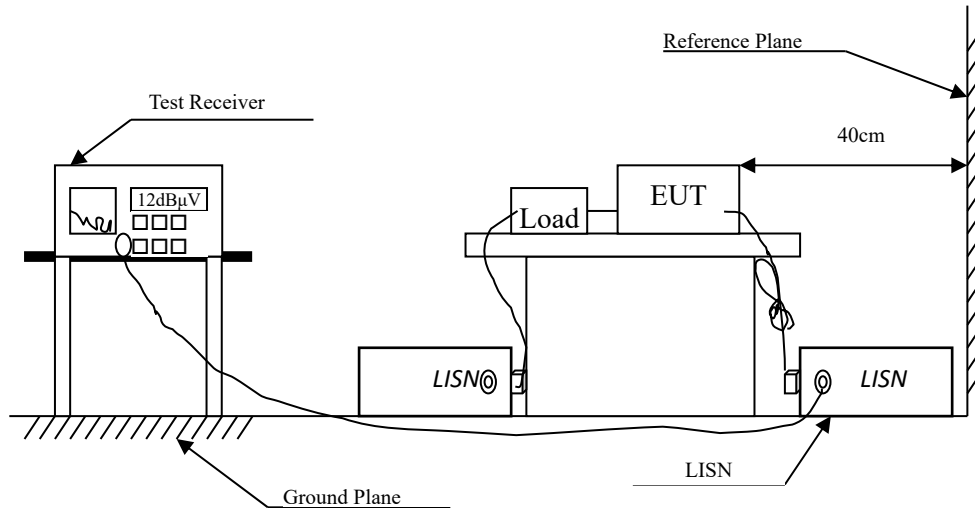

2.2. Limits

FCC Part 15 Subpart C Paragraph 15.207 (dB μ V) Limit		
Frequency MHz	Limits	
	QP	AV
0.15 - 0.50	66-56	56-46
0.50 - 5.0	56	46
5.0 - 30	60	50

Remarks: In the above table, the tighter limit applies at the band edges.

2.3. Test Procedure

The EUT and Peripherals are connected to the main power through a line impedance stabilization network (L.I.S.N.). This provides a 50 ohm /50uH coupling impedance for the measuring equipment. The peripheral devices are also connected to the main power through a LISN that provides a 50ohm /50uH coupling impedance with 50ohm termination. (Please refer to the block diagram of the test setup and photographs.)

Both sides of A.C. line are checked for maximum conducted interference. In order to find the maximum emission, the relative positions of equipment and all the interface cables must be changed according to ANSI C63.4: 2014 on conducted measurement.

Conducted emissions were investigated over the frequency range from 0.15MHz to 30MHz using a receiver bandwidth of 9kHz.

The EUT setup and the test procedure are according to ANSI C63.4, 2014 to comply with the requirements of FCC 47CFR Subpart C.

2.4. Test Result of Conducted Emission

PD Mode

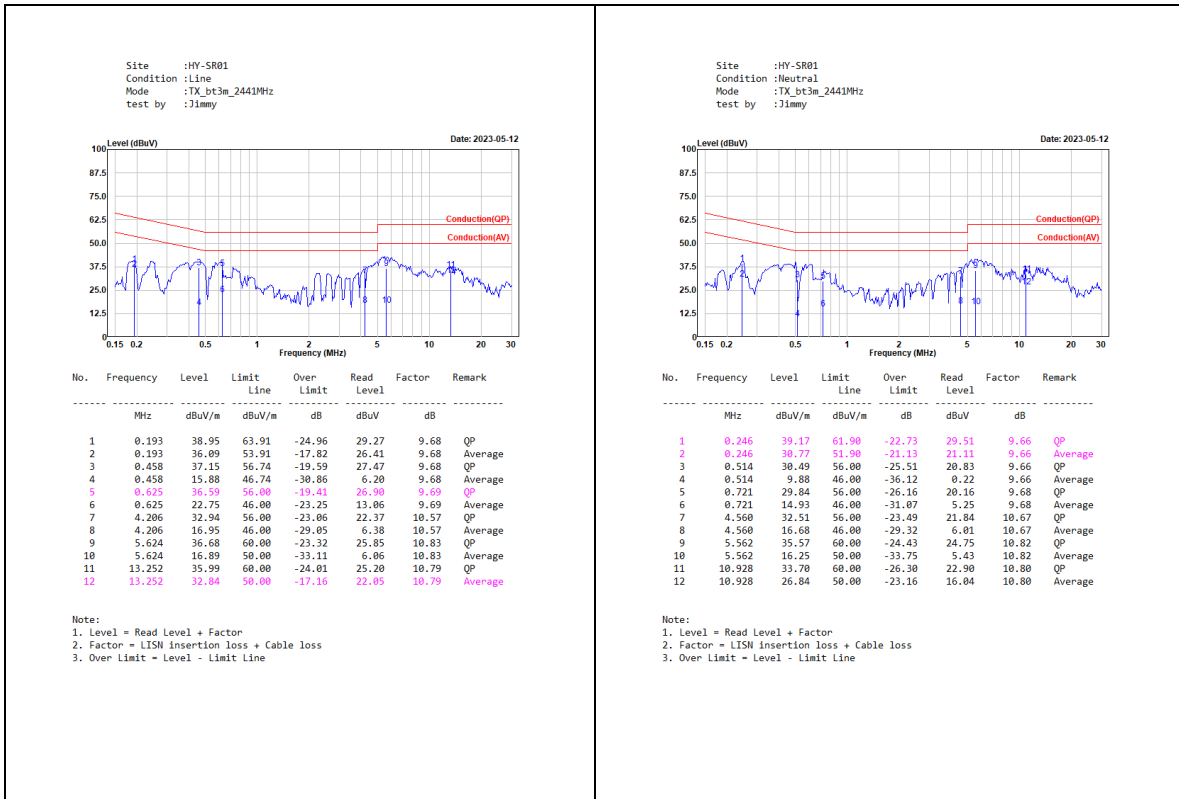

PoE Mode

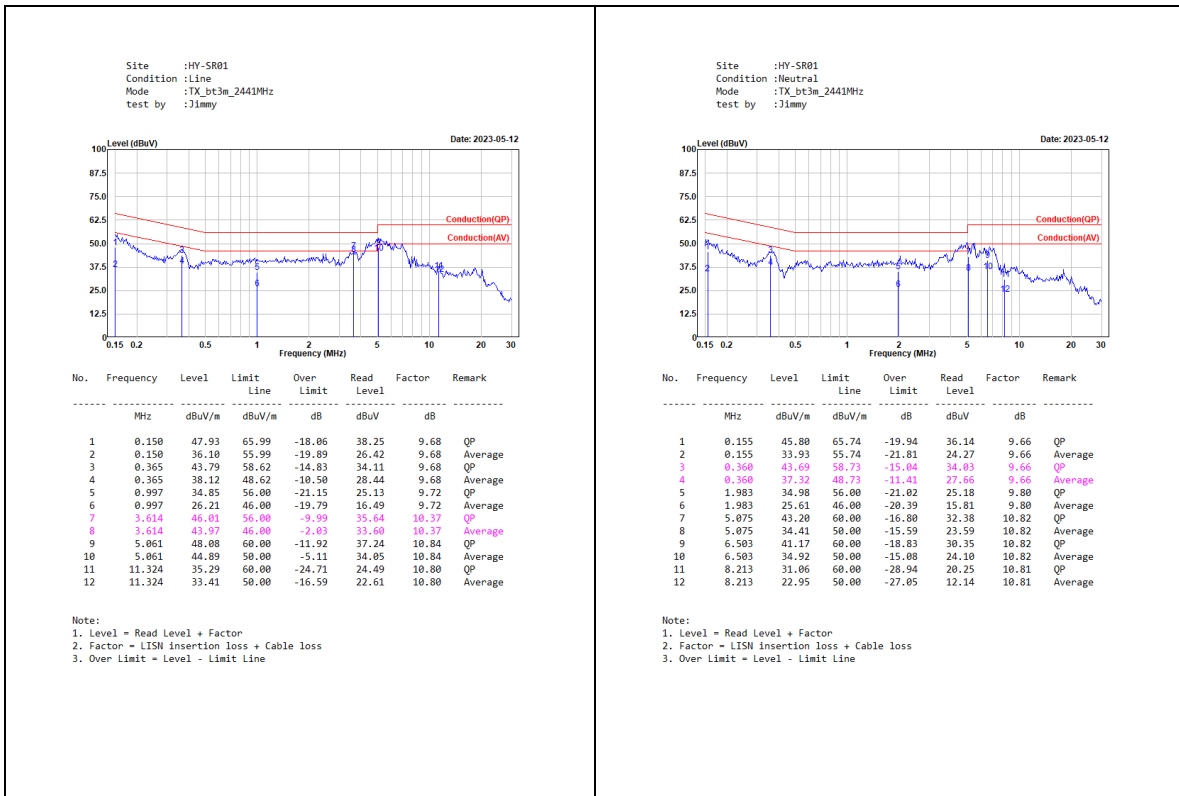

3. Peak Power Output

3.1. Test Setup

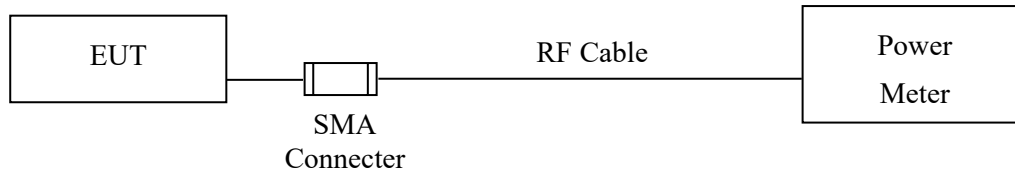

3.2. Limit

The maximum peak power shall be less 1 Watt, for all other frequency hopping systems in the 2400-2483.5MHz band: 0.125 watts.

3.3. Test Procedure

Tested according to FHSS test procedure of KDB 558074 section 9 (b for compliance to FCC 47CFR 15.247 requirements.

3.4. Test Result of Peak Power Output

Product : TCx EDGE Cam+
Test Item : Peak Power Output
Test Mode : Transmit - 1 Mbps
Test Date : 2023/04/19

Channel No.	Frequency (MHz)	Measurement Level (dBm)	Required Limit	Result
00	2402	7.10	0.125Watt= 21 dBm	Pass
39	2441	7.48	0.125Watt= 21 dBm	Pass
78	2480	8.05	0.125Watt= 21 dBm	Pass

Product : TCx EDGE Cam+
Test Item : Peak Power Output
Test Mode : Transmit - 3 Mbps
Test Date : 2023/04/19

Channel No.	Frequency (MHz)	Measurement Level (dBm)	Required Limit	Result
00	2402	10.72	0.125Watt= 21 dBm	Pass
39	2441	11.32	0.125Watt= 21 dBm	Pass
78	2480	7.98	0.125Watt= 21 dBm	Pass

4. Radiated Emission

4.1. Test Setup

Radiated Emission Under 30 MHz

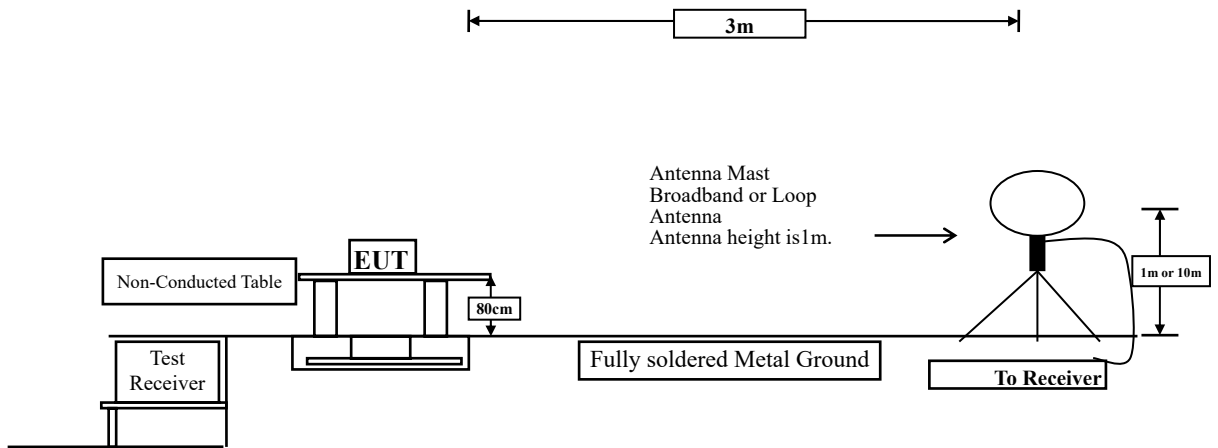

Radiated Emission Below 1 GHz

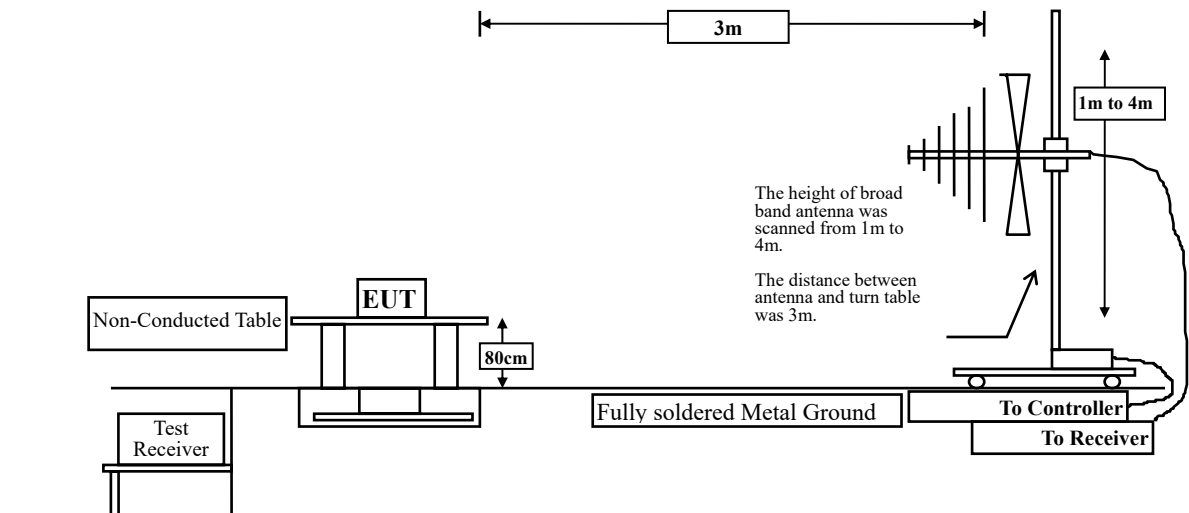

Radiated Emission Above 1 GHz

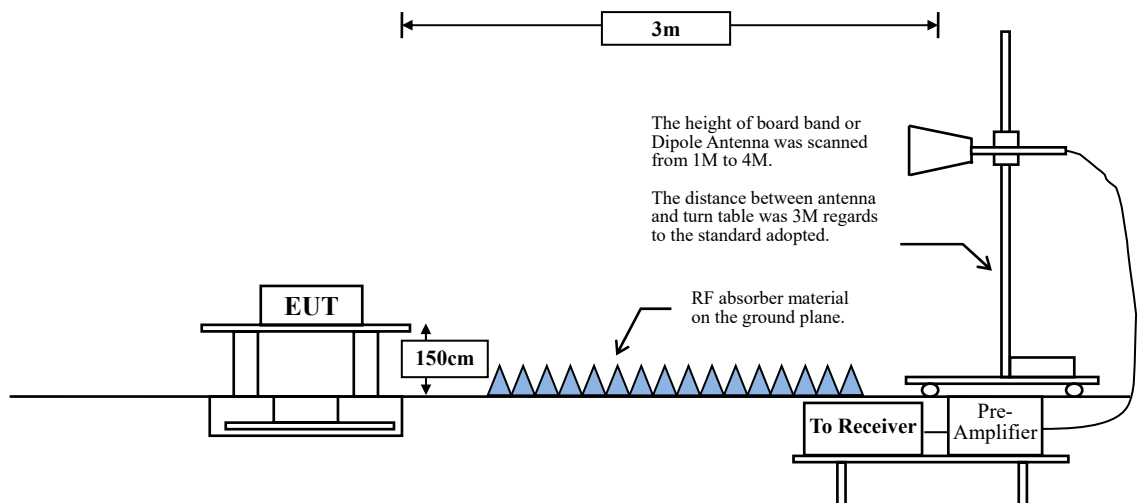

4.2. Limits

➤ General Radiated Emission Limits

Emissions radiated outside of the specified frequency bands, except for harmonics, shall be attenuated by at least 20dB below the level of the fundamental or to the general radiated emission limits in paragraph 15.209, whichever is the lesser attenuation.

FCC Part 15 Subpart C Paragraph 15.209 Limits		
Frequency MHz	Field strength (microvolts/meter)	Measurement distance (meter)
0.009-0.490	2400/F(kHz)	300
0.490-1.705	24000/F(kHz)	30
1.705-30	30	30
30-88	100	3
88-216	150	3
216-960	200	3
Above 960	500	3

Remarks:

1. RF Voltage (dB μ V) = 20 log RF Voltage (μ V)
2. In the Above Table, the tighter limit applies at the band edges.
3. Distance refers to the distance in meters between the measuring instrument antenna and the closed point of any part of the device or system.

4.3. Test Procedure

The EUT was setup according to ANSI C63.10, 2013 and tested compliance to FCC 47CFR 15.247 requirements.

Measuring the frequency range below 1 GHz, the EUT is placed on a turn table which is 0.8 meter above ground, when measuring the frequency range above 1GHz, the EUT is placed on a turn table which is 1.5 meter above ground.

The turn table is rotated 360 degrees to determine the position of the maximum emission level.

The EUT was positioned such that the distance from antenna to the EUT was 3 meters.

The antenna is scanned between 1 meter and 4 meters to find out the maximum emission level. This is repeated for both horizontal and vertical polarization of the antenna. In order to find the maximum emission, all of the interface cables were manipulated according to ANSI C63.10: 2013 on radiated measurement.

The resolution bandwidth below 30 MHz setting on the field strength meter is 9kHz and 30 MHz~1 GHz is 120 kHz and above 1 GHz is 1 MHz.

Radiated emission measurements below 30 MHz are made using Loop Antenna and 30 MHz~1 GHz are made using broadband Bilog antenna and above 1 GHz are made using Horn Antennas.

The measurement is divided into the Preliminary Measurement and the Final Measurement.

The suspected frequencies are searched for in Preliminary Measurement with the measurement antenna kept pointed at the source of the emission both in azimuth and elevation, with the polarization of the antenna oriented for maximum response. The antenna is pointed at an angle towards the source of the emission, and the EUT is rotated in both height and polarization to maximize the measured emission. The emission is kept within the illumination area of the 3 dB bandwidth of the antenna.

The measurement frequency range form 9 kHz - 10th Harmonic of fundamental was investigated.

4.4. Test Result of Radiated Emission

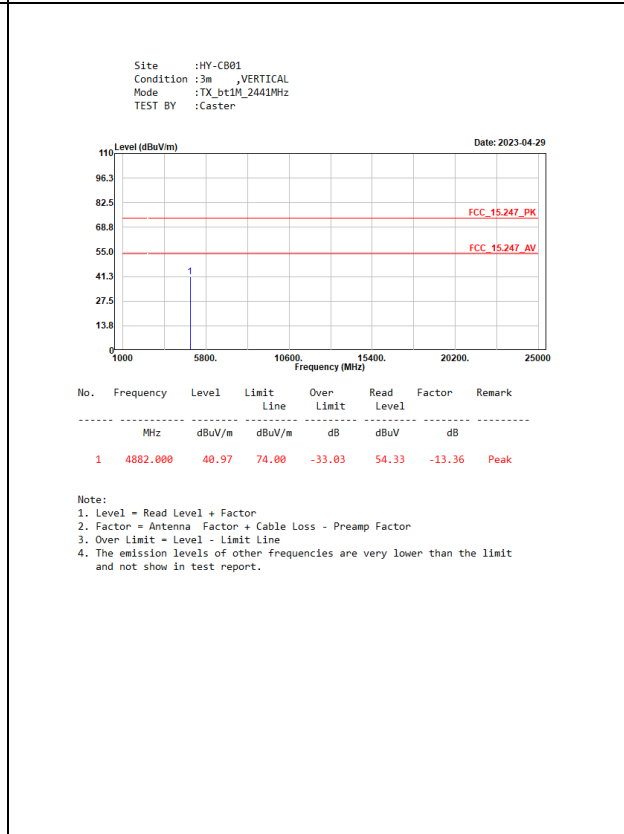
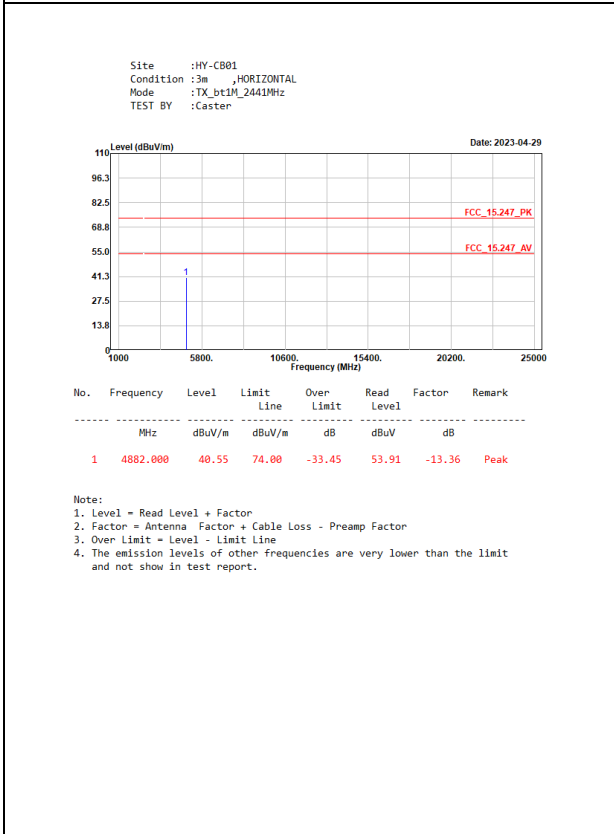
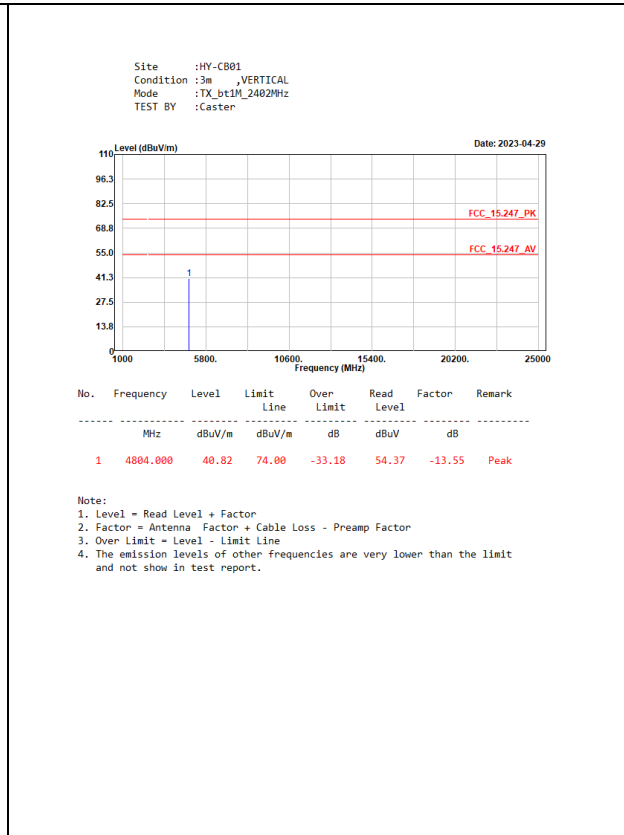
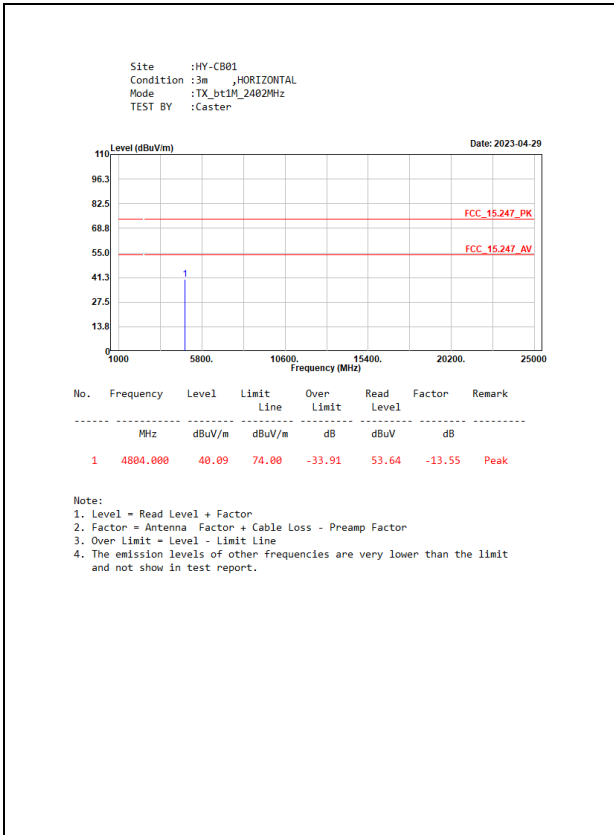

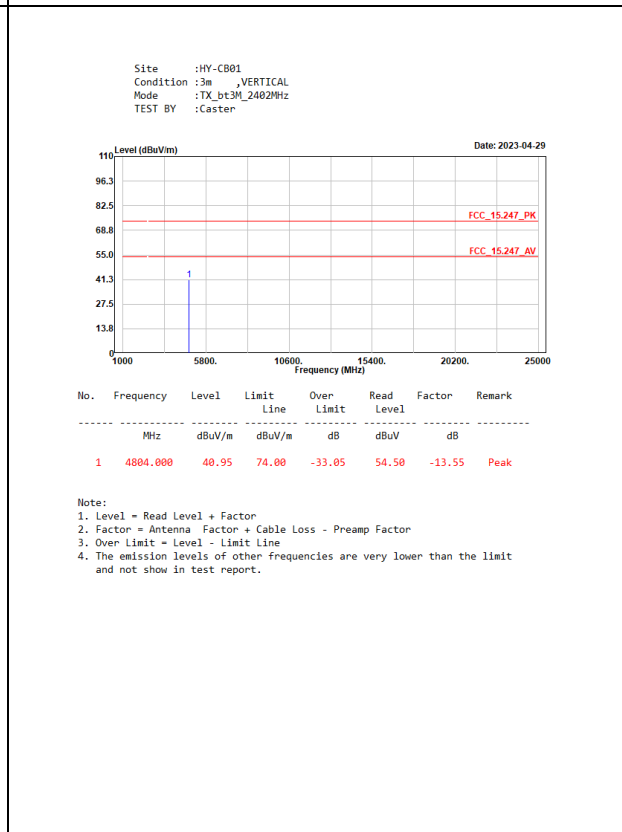
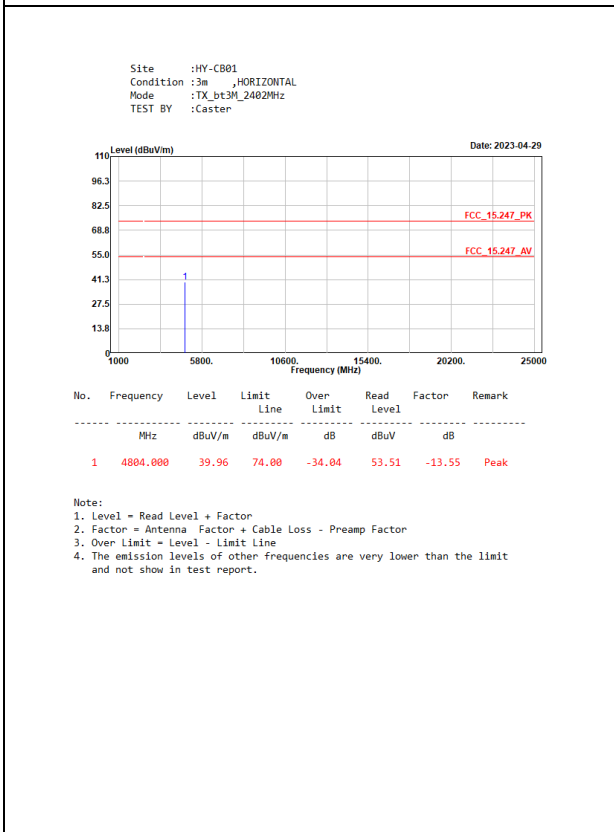
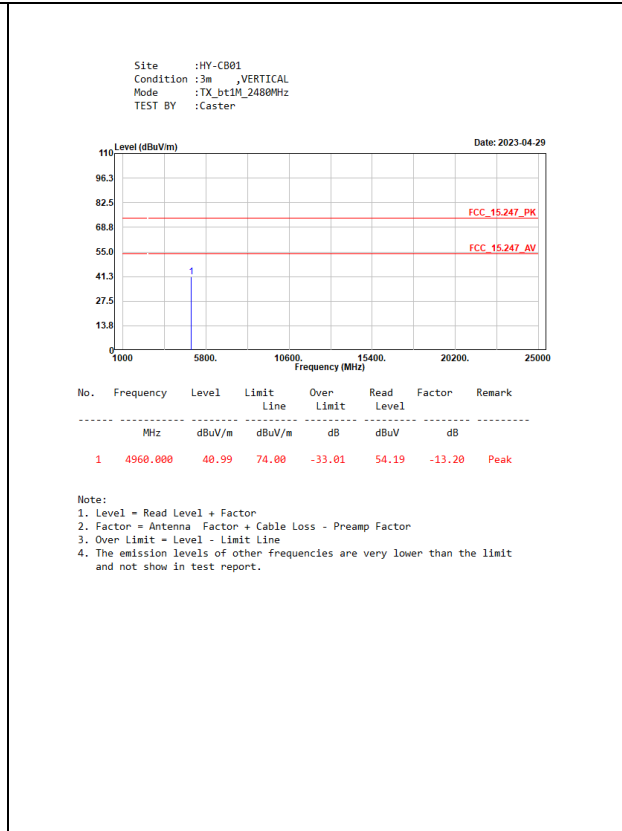
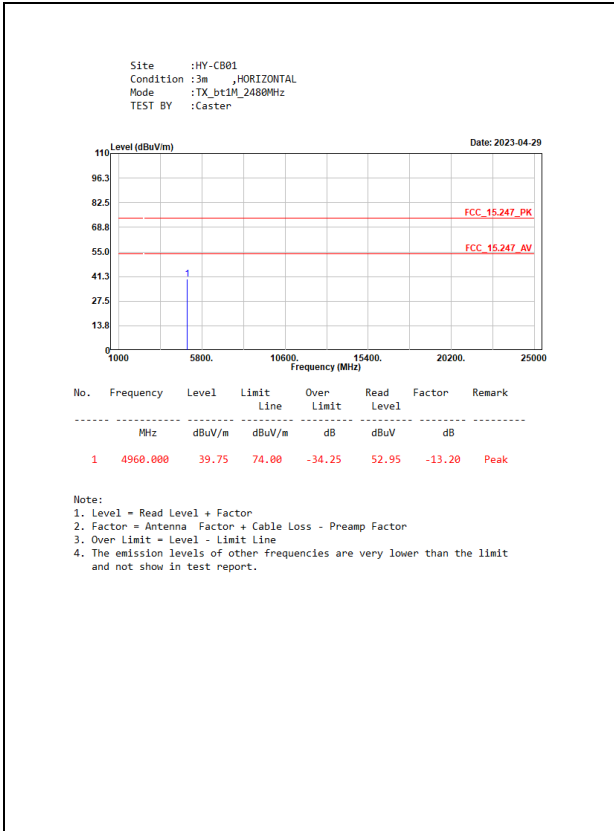

TX_bt3M_2402MHz_H_001

TX_bt3M_2402MHz_V_001

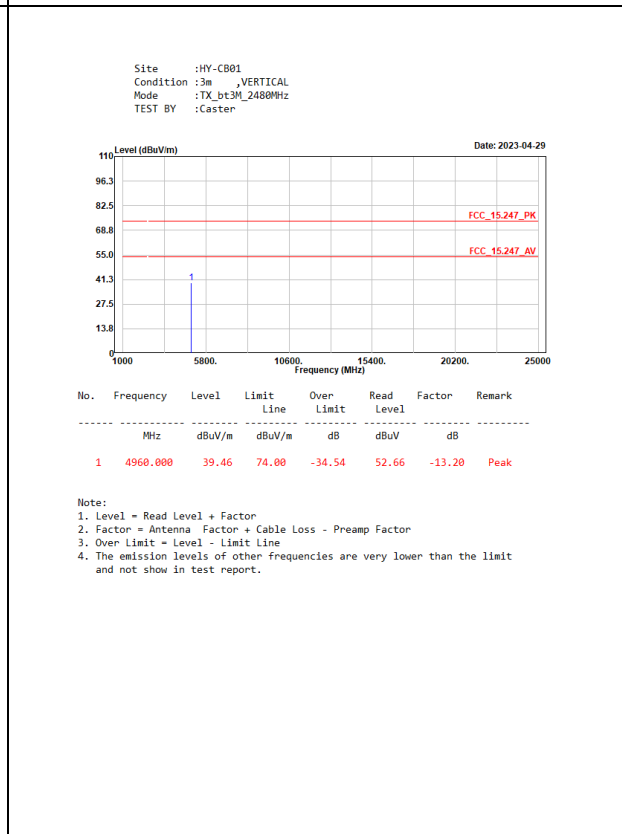
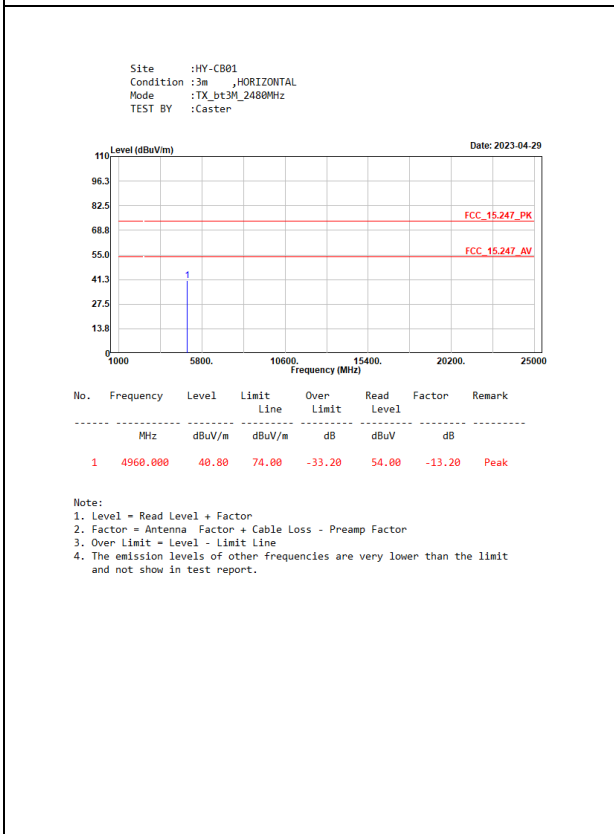
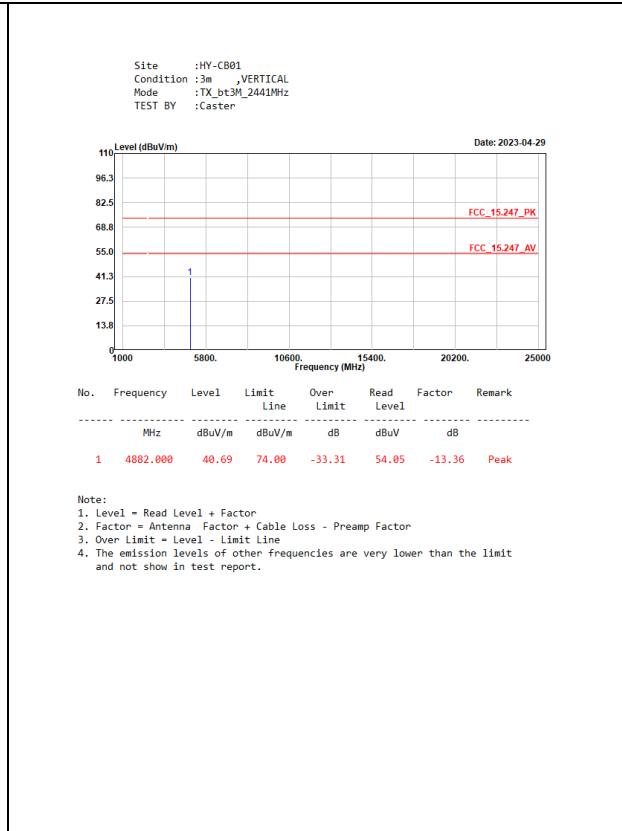
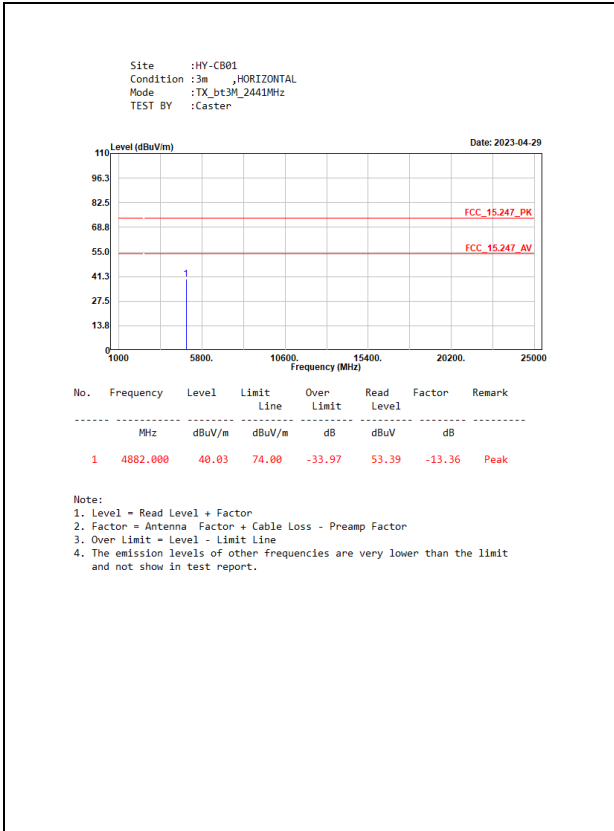

PD Mode

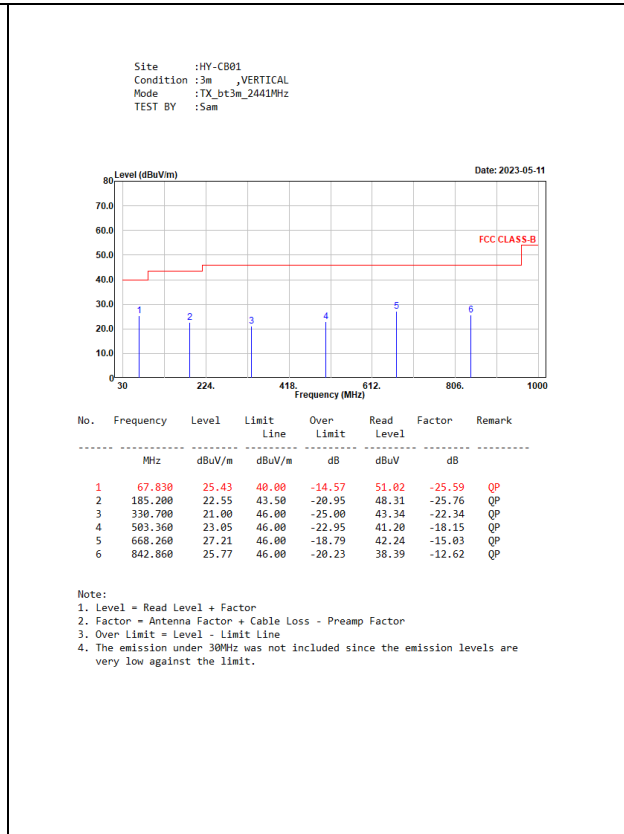
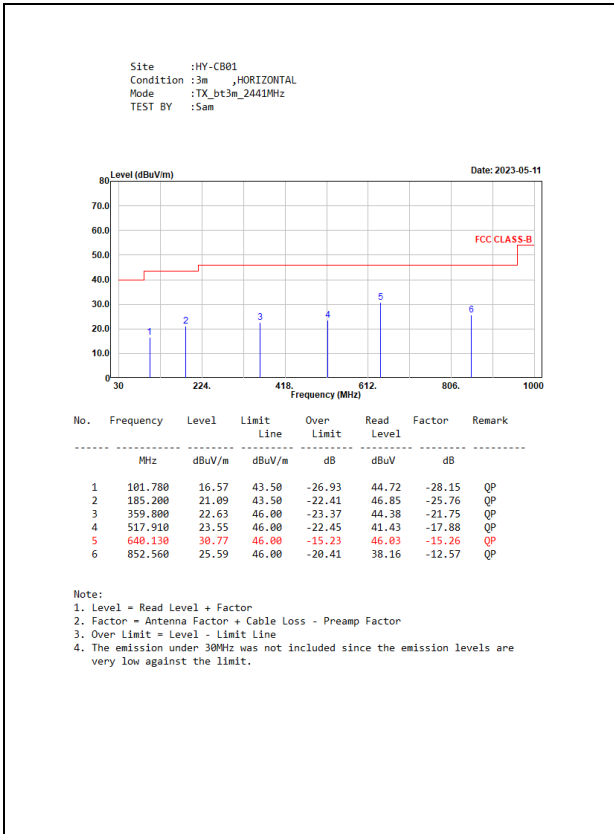

PoE Mode

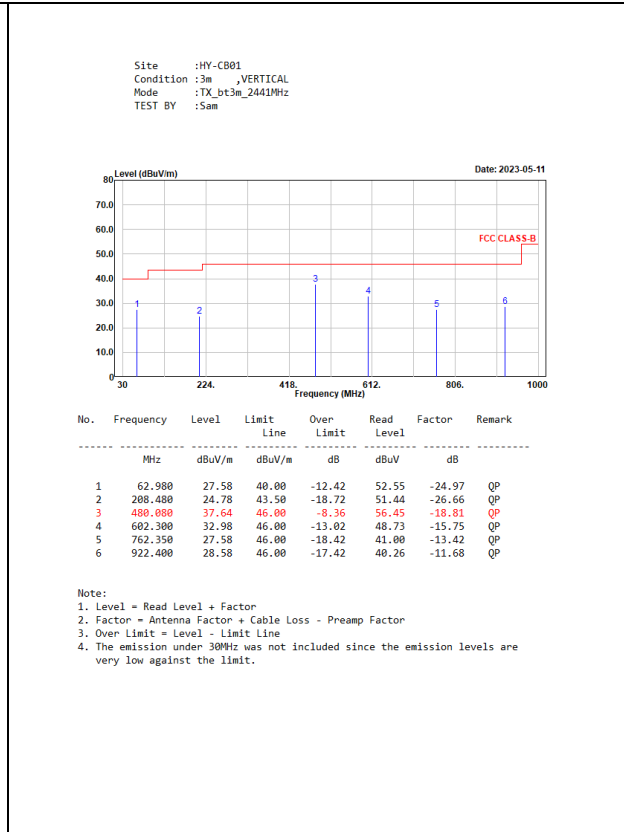
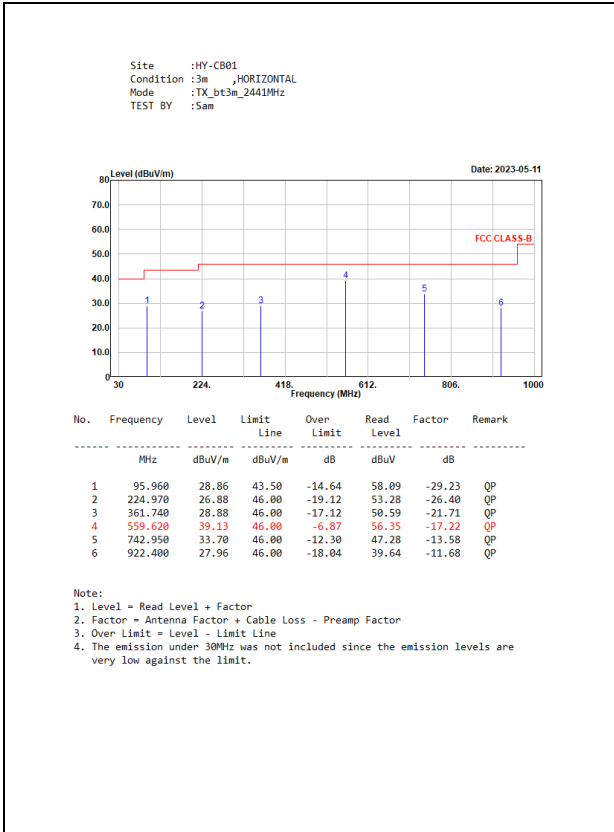

5. RF Antenna Conducted Test

5.1. Test Setup

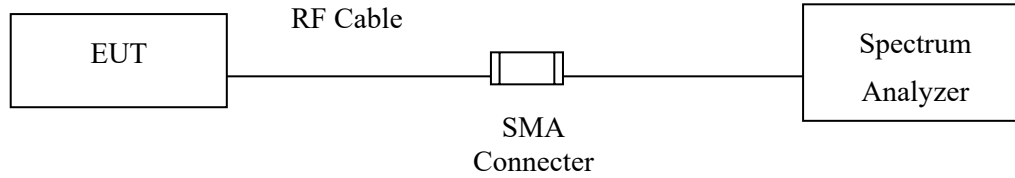

5.2. Limits

According to FCC Section 15.247(d). In any 100 kHz bandwidth outside the frequency band in which the spread spectrum or digitally modulated intentional radiator is operating, the radio frequency power that is produced by the intentional radiator shall be at least 20 dB below that in the 100 kHz bandwidth within the band that contains the highest level of the desired power, based on either an RF conducted or measurement, provided the transmitter demonstrates compliance with the peak conducted power limits. If the transmitter complies with the conducted power limits based on the use of RMS averaging over a time interval, the attenuation required under this paragraph shall be 30 dB instead of 20 dB.

5.3. Test Procedure

Tested according to FHSS test procedure of KDB558074 section 9 b) for compliance to FCC 47CFR 15.247 requirements.

5.4. Test Result of RF Antenna Conducted Test

Product : TCx EDGE Cam+
 Test Item : RF Antenna Conducted Test
 Test Mode : Transmit - 1 Mbps
 Test Date : 2023/04/25

Channel 39:

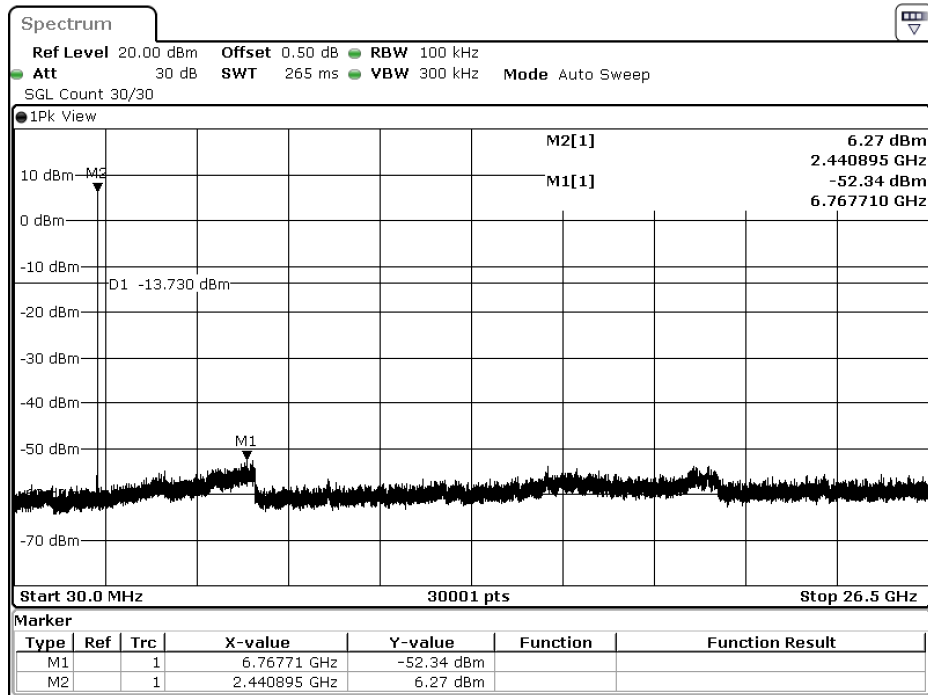

Date: 25.APR.2023 14:49:23

Product : TCx EDGE Cam+
 Test Item : RF Antenna Conducted Test
 Test Mode : Transmit - 3 Mbps
 Test Date : 2023/04/25

Channel 39:

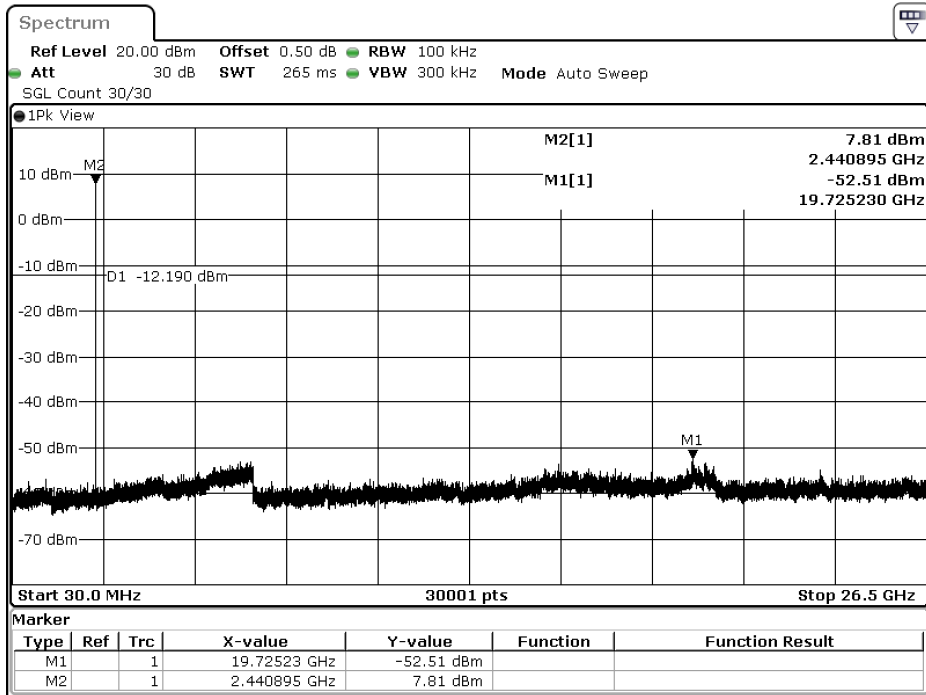

Date: 25.APR.2023 14:59:11

6. Band Edge

6.1. Test Setup

RF Conducted Measurement

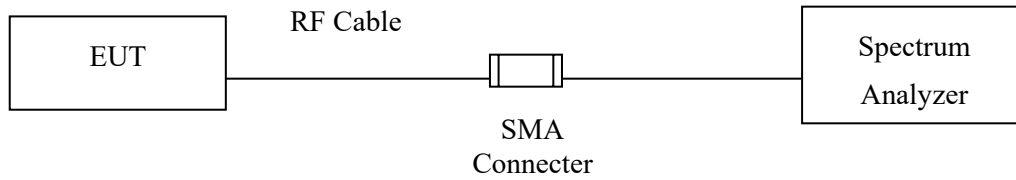

RF Radiated Measurement:

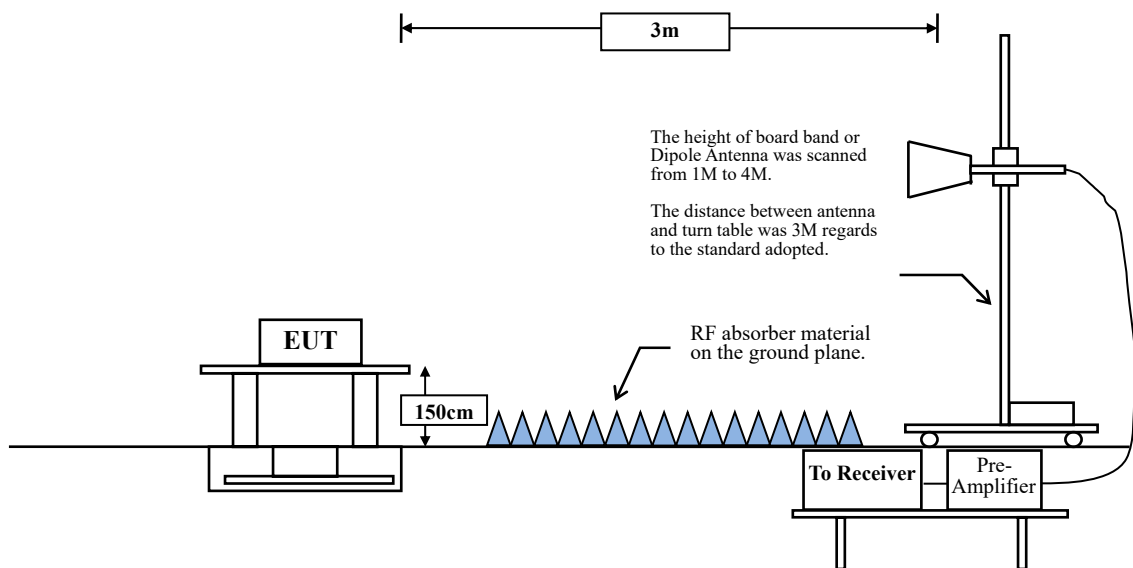

6.2. Limit

According to FCC Section 15.247(d). In any 100 kHz bandwidth outside the frequency band in which the spread spectrum or digitally modulated intentional radiator is operating, the radio frequency power that is produced by the intentional radiator shall be at least 20 dB below that in the 100 kHz bandwidth within the band that contains the highest level of the desired power, based on either an RF conducted or measurement, provided the transmitter demonstrates compliance with the peak conducted power limits. If the transmitter complies with the conducted power limits based on the use of RMS averaging over a time interval, the attenuation required under this paragraph shall be 30 dB instead of 20 dB. Attenuation below the general limits specified in Section 15.209(a) is not required. In addition, radiated emissions which fall in the restricted bands, as defined in Section 15.205(a), must also comply with the radiated emission limits specified in Section 15.209(a) (see Section 15.205(c)).

6.3. Test Procedure

The EUT is placed on a turn table which is 1.5 meter above ground. The turn table is rotated 360 degrees to determine the position of the maximum emission level. The EUT was positioned such that the distance from antenna to the EUT was 3 meters.

The antenna can move up and down between 1 meter and 4 meters to find out the maximum emission level.

Both horizontal and vertical polarization of the antenna are set on measurement. In order to find the maximum emission, all of the interface cables must be manipulated according to ANSI C63.10: 2013 on radiated measurement.

The bandwidth setting below 1 GHz and above 1 GHz on the field strength meter is 120 kHz and 1MHz, respectively.

6.4. Test Result of Band Edge

Site :HY-CB01
 Condition :3m ,Horizontal
 Mode :TX_bt1M_2402MHz
 TEST BY :Sam

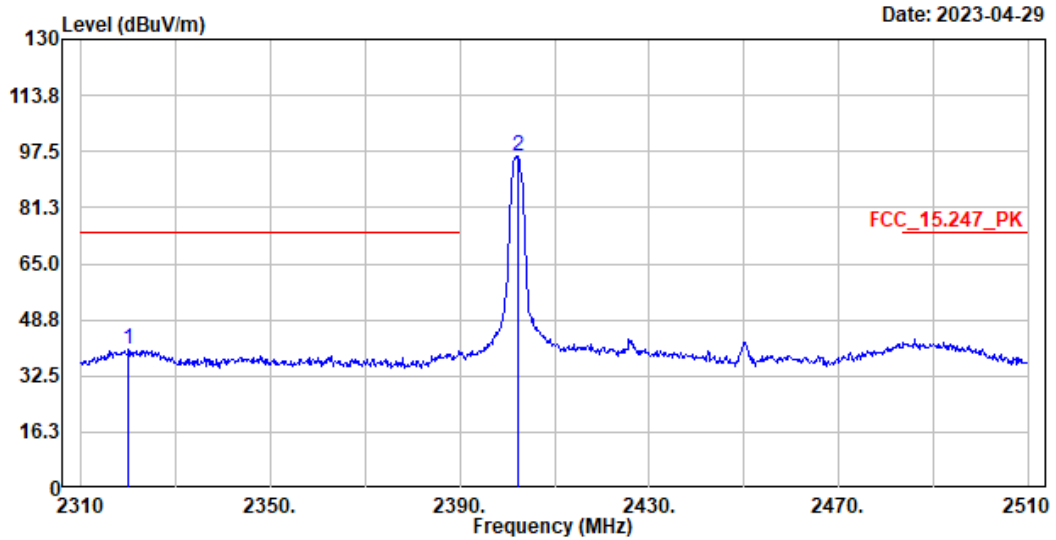

No.	Frequency	Level	Limit	Over	Read	Factor	Remark
	MHz	dBuV/m	dBuV/m	dB	dBuV	dB	
1	2320.000	40.20	74.00	-33.80	34.41	5.79	Peak
2	2402.200	96.06	-----	-----	90.43	5.63	Peak

Note:

1. Level = Read Level + Factor
2. Factor = Antenna Factor + Cable Loss - Preamp Factor
3. Over Limit = Level - Limit Line
4. The emission levels of other frequencies are very lower than the limit and not show in test report.

Horizontal-Average Detector:

Frequency (MHz)	Peak Measurement (dBμV/m)	Duty Cycle Factor (dB)	Measurement Level (dBμV/m)	Margin (dB)	Limit (dBμV/m)
2320	40.2	-30.752	9.448	-44.552	54.000
2402.2	96.06	-30.752	65.308	--	--

Site :HY-CB01
 Condition :3m ,Vertical
 Mode :TX_bt1M_2402MHz
 TEST BY :Sam

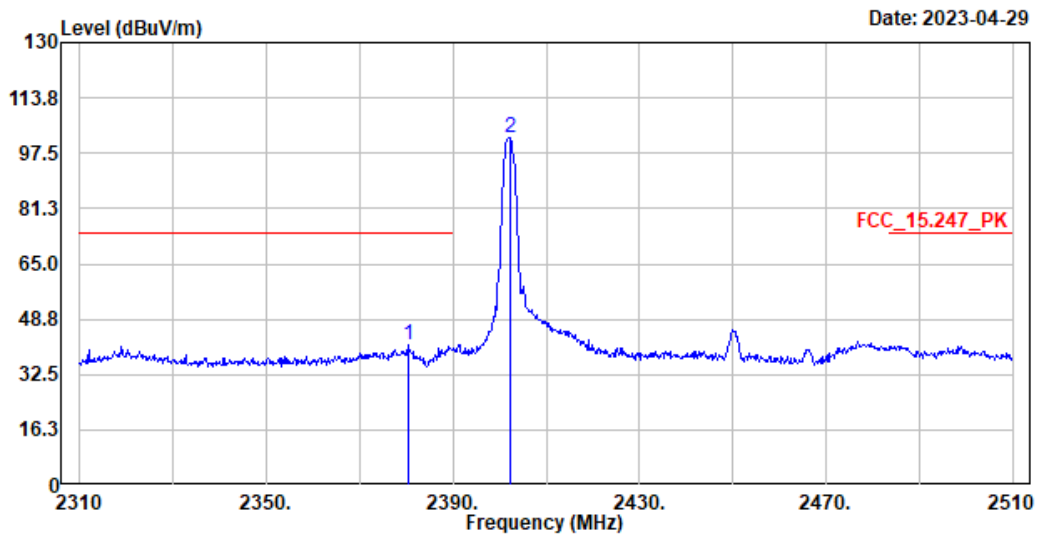

No.	Frequency	Level	Limit	Over	Read	Factor	Remark
	MHz	dBuV/m	dBuV/m	dB	dBuV	dB	
1	2380.400	40.97	74.00	-33.03	35.26	5.71	Peak
2	2402.200	102.04	-----	-----	96.41	5.63	Peak

Note:

1. Level = Read Level + Factor
2. Factor = Antenna Factor + Cable Loss - Preamp Factor
3. Over Limit = Level - Limit Line
4. The emission levels of other frequencies are very lower than the limit and not show in test report.

Vertical-Average Detector:

Frequency (MHz)	Peak Measurement (dBμV/m)	Duty Cycle Factor (dB)	Measurement Level (dBμV/m)	Margin (dB)	Limit (dBμV/m)
2380.4	40.97	-30.752	10.218	-43.782	54.000
2402.2	102.04	-30.752	71.288	--	--

Site :HY-CB01
 Condition :3m ,Horizontal
 Mode :TX_bt1M_2480MHz
 TEST BY :Sam

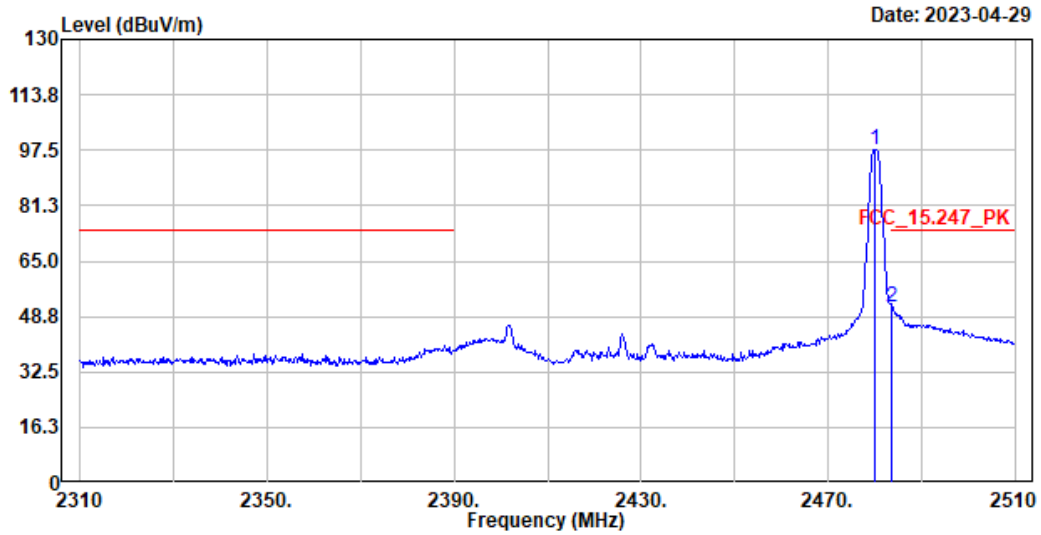

No.	Frequency	Level	Limit	Over	Read	Factor	Remark
	MHz	dBuV/m	dBuV/m	dB	dBuV	dB	
1	2480.000	97.83	-----	-----	92.19	5.64	Peak
2	2483.600	51.58	74.00	-22.42	45.92	5.66	Peak

Note:

1. Level = Read Level + Factor
2. Factor = Antenna Factor + Cable Loss - Preamp Factor
3. Over Limit = Level - Limit Line
4. The emission levels of other frequencies are very lower than the limit and not show in test report.

Horizontal-Average Detector:

Frequency (MHz)	Peak Measurement (dBμV/m)	Duty Cycle Factor (dB)	Measurement Level (dBμV/m)	Margin (dB)	Limit (dBμV/m)
2480	97.83	-30.752	67.078	--	--
2483.6	51.58	-30.752	20.828	-33.172	54.000

Site :HY-CB01
 Condition :3m ,Vertical
 Mode :TX_bt1M_2480MHz
 TEST BY :Sam

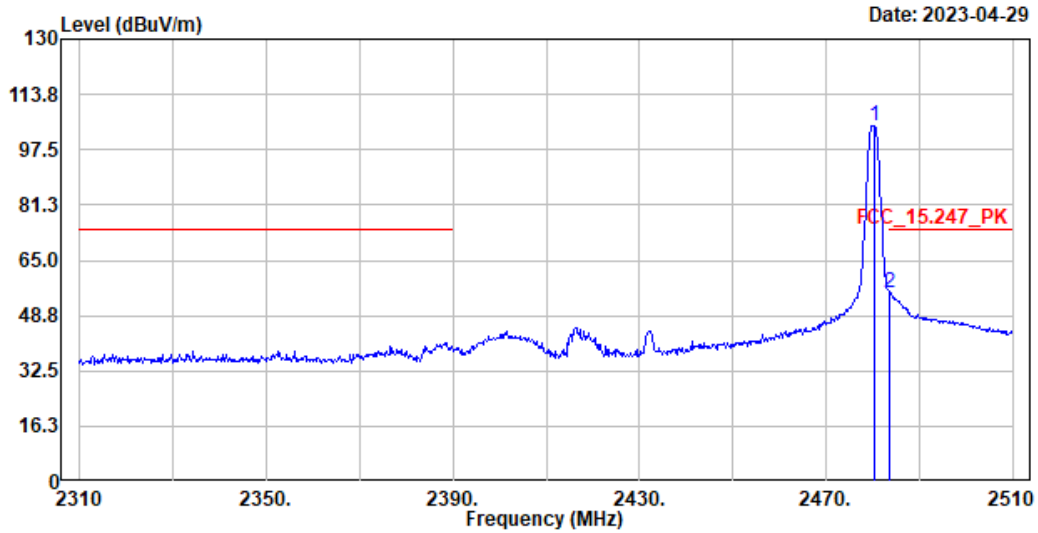

No.	Frequency	Level	Limit	Over	Read	Factor	Remark
	MHz	dBuV/m	dBuV/m	dB	dBuV	dB	
1	2480.200	104.45	-----	-----	98.81	5.64	Peak
2	2483.600	55.52	74.00	-18.48	49.86	5.66	Peak

Note:

1. Level = Read Level + Factor
2. Factor = Antenna Factor + Cable Loss - Preamp Factor
3. Over Limit = Level - Limit Line
4. The emission levels of other frequencies are very lower than the limit and not show in test report.

Vertical-Average Detector:

Frequency (MHz)	Peak Measurement (dBμV/m)	Duty Cycle Factor (dB)	Measurement Level (dBμV/m)	Margin (dB)	Limit (dBμV/m)
2480.2	104.45	-30.752	73.698	--	--
2483.6	55.52	-30.752	24.768	-29.232	54.000

Site :HY-CB01
 Condition :3m ,Horizontal
 Mode :TX_bt3M_2402MHz
 TEST BY :Sam

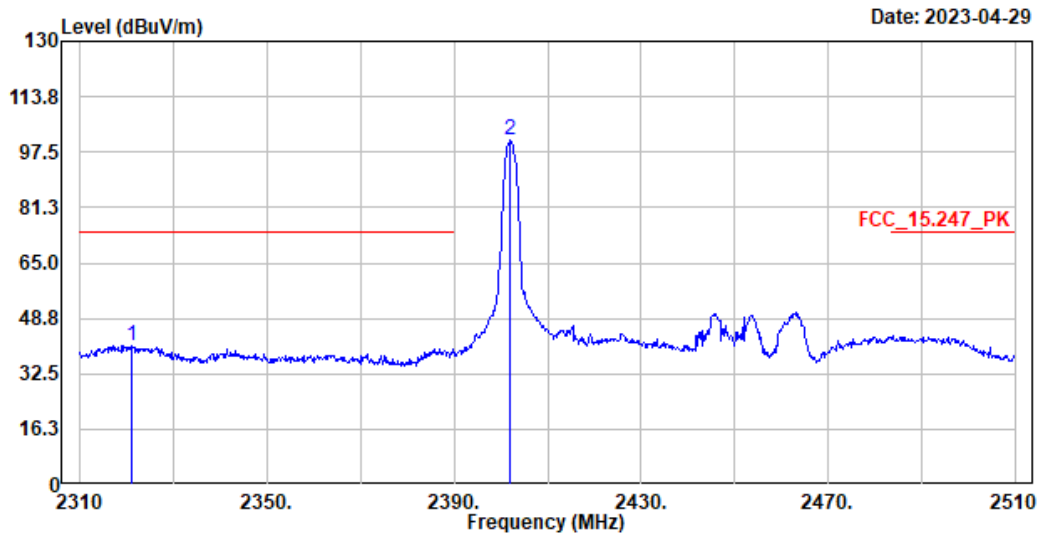

No.	Frequency	Level	Limit	Over	Read	Factor	Remark
	MHz	dBuV/m	dBuV/m	Limit	Level	dB	
1	2321.200	40.85	74.00	-33.15	35.06	5.79	Peak
2	2402.000	100.82	-----	-----	95.19	5.63	Peak

Note:

1. Level = Read Level + Factor
2. Factor = Antenna Factor + Cable Loss - Preamp Factor
3. Over Limit = Level - Limit Line
4. The emission levels of other frequencies are very lower than the limit and not show in test report.

Horizontal-Average Detector:

Frequency (MHz)	Peak Measurement (dBμV/m)	Duty Cycle Factor (dB)	Measurement Level (dBμV/m)	Margin (dB)	Limit (dBμV/m)
2321.2	40.85	-24.731	16.119	-37.881	54.000
2402.2	100.82	-24.731	76.089	--	--

Site :HY-CB01
 Condition :3m ,Vertical
 Mode :TX_bt3M_2402MHz
 TEST BY :Sam

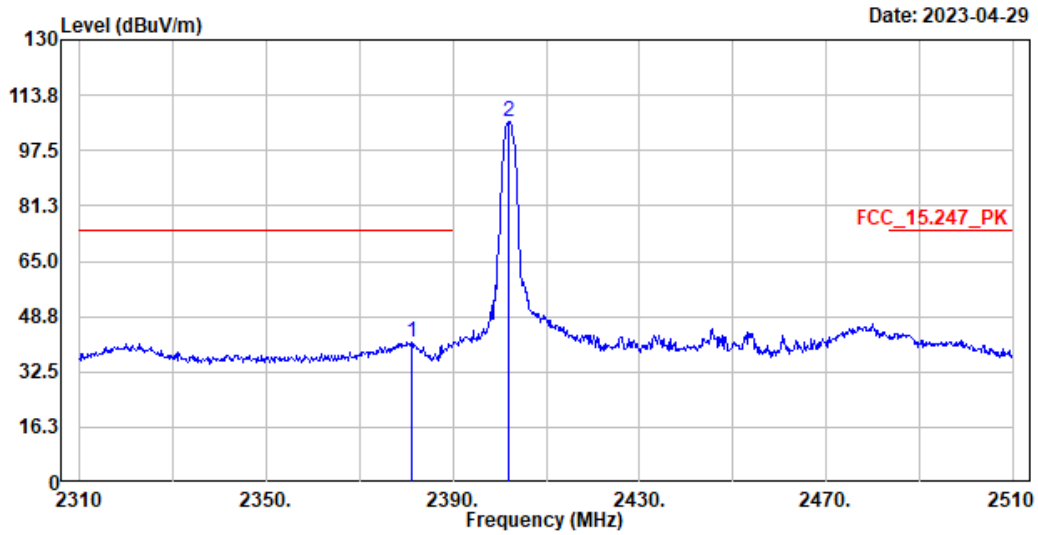

No.	Frequency	Level	Limit Line	Over Limit	Read Level	Factor	Remark
	MHz	dBuV/m	dBuV/m	dB	dBuV	dB	
1	2381.200	41.38	74.00	-32.62	35.67	5.71	Peak
2	2402.000	106.08	-----	-----	100.45	5.63	Peak

Note:

1. Level = Read Level + Factor
2. Factor = Antenna Factor + Cable Loss - Preamp Factor
3. Over Limit = Level - Limit Line
4. The emission levels of other frequencies are very lower than the limit and not show in test report.

Vertical-Average Detector:

Frequency (MHz)	Peak Measurement (dBμV/m)	Duty Cycle Factor (dB)	Measurement Level (dBμV/m)	Margin (dB)	Limit (dBμV/m)
2381.2	41.38	-24.731	16.649	-37.351	54.000
2402	106.08	-24.731	81.349	--	--

Site :HY-CB01
 Condition :3m ,Horizontal
 Mode :TX_bt3M_2480MHz
 TEST BY :Sam

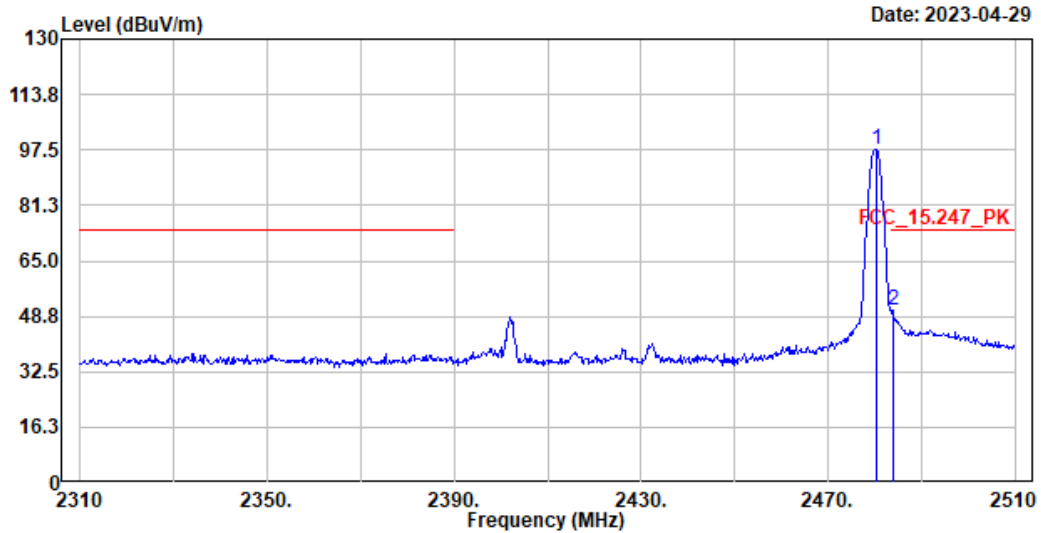

No.	Frequency	Level	Limit	Over	Read	Factor	Remark
	MHz	dBuV/m	dBuV/m	dB	dBuV	dB	
1	2480.200	97.74	-----	-----	92.10	5.64	Peak
2	2483.800	50.51	74.00	-23.49	44.85	5.66	Peak

Note:

1. Level = Read Level + Factor
2. Factor = Antenna Factor + Cable Loss - Preamp Factor
3. Over Limit = Level - Limit Line
4. The emission levels of other frequencies are very lower than the limit and not show in test report.

Horizontal-Average Detector:

Frequency (MHz)	Peak Measurement (dBμV/m)	Duty Cycle Factor (dB)	Measurement Level (dBμV/m)	Margin (dB)	Limit (dBμV/m)
2480.2	97.74	-24.731	73.009	--	--
2483.8	50.51	-24.731	25.779	-28.221	54.000

Site :HY-CB01
 Condition :3m ,Vertical
 Mode :TX_bt3M_2480MHz
 TEST BY :Sam

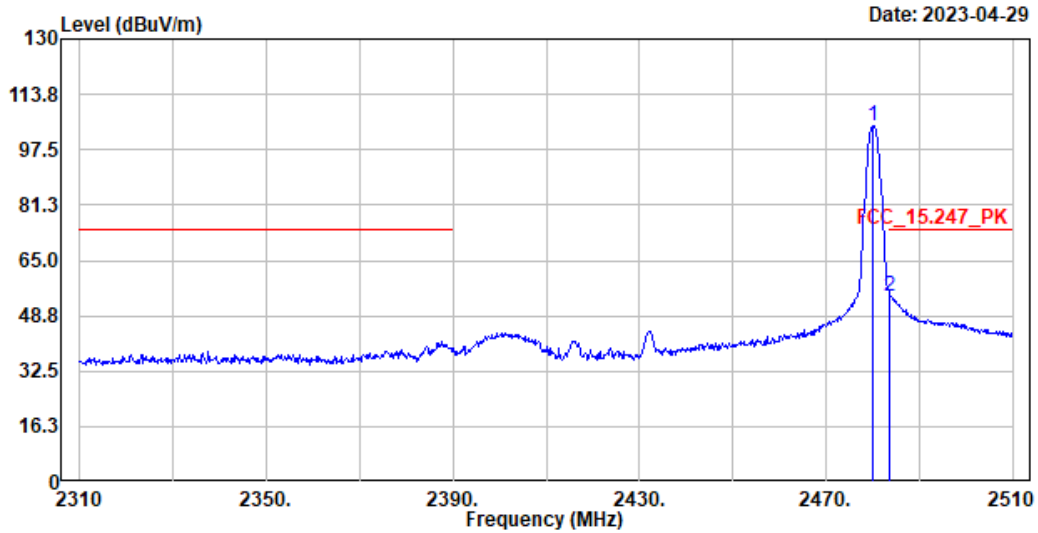

No.	Frequency	Level	Limit	Over	Read	Factor	Remark
	MHz	dBuV/m	dBuV/m	dB	dBuV	dB	
1	2480.000	104.36	-----	-----	98.72	5.64	Peak
2	2483.600	54.70	74.00	-19.30	49.04	5.66	Peak

Note:

1. Level = Read Level + Factor
2. Factor = Antenna Factor + Cable Loss - Preamp Factor
3. Over Limit = Level - Limit Line
4. The emission levels of other frequencies are very lower than the limit and not show in test report.

Vertical-Average Detector:

Frequency (MHz)	Peak Measurement (dBμV/m)	Duty Cycle Factor (dB)	Measurement Level (dBμV/m)	Margin (dB)	Limit (dBμV/m)
2480	104.36	-24.731	79.629	--	--
2483.6	54.7	-24.731	29.969	-24.031	54.000

Product : TCx EDGE Cam+
 Test Item : Band Edge
 Test Mode : Transmit - 1 Mbps (Hopping off)
 Test Date : 2023/04/25

Measurement Level	Result
Δ (dB)	
> 20	PASS

Channel 00:

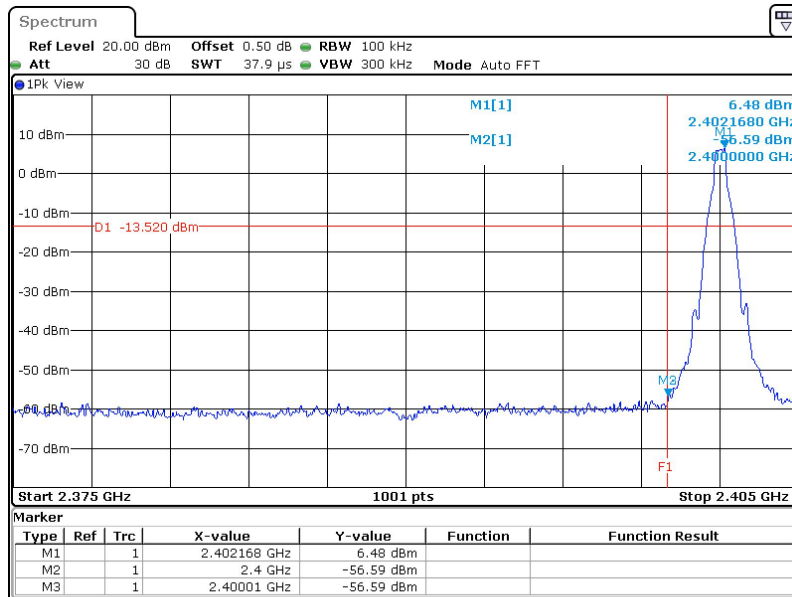

Channel 78:

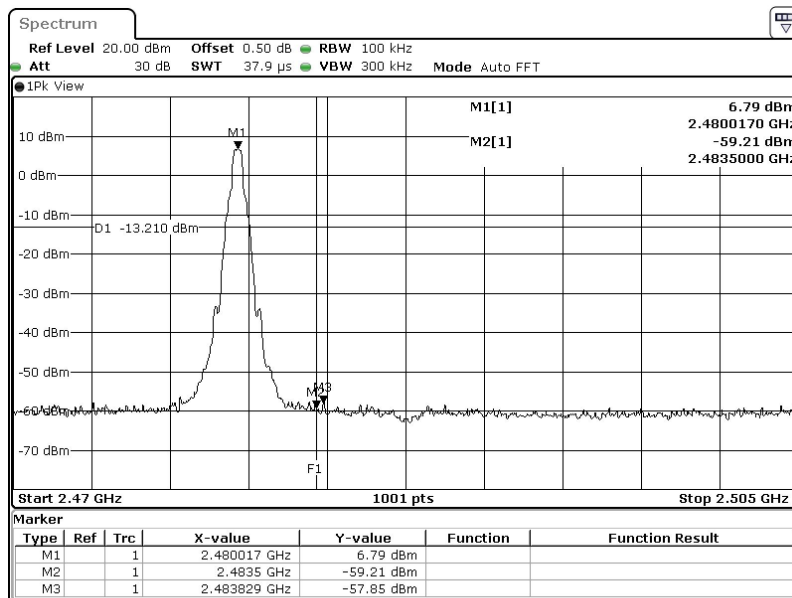

Product : TCx EDGE Cam+
 Test Item : Band Edge
 Test Mode : Transmit - 3 Mbps (Hopping off)
 Test Date : 2023/04/25

Measurement Level	Result
Δ (dB)	
> 20	PASS

Channel 00:

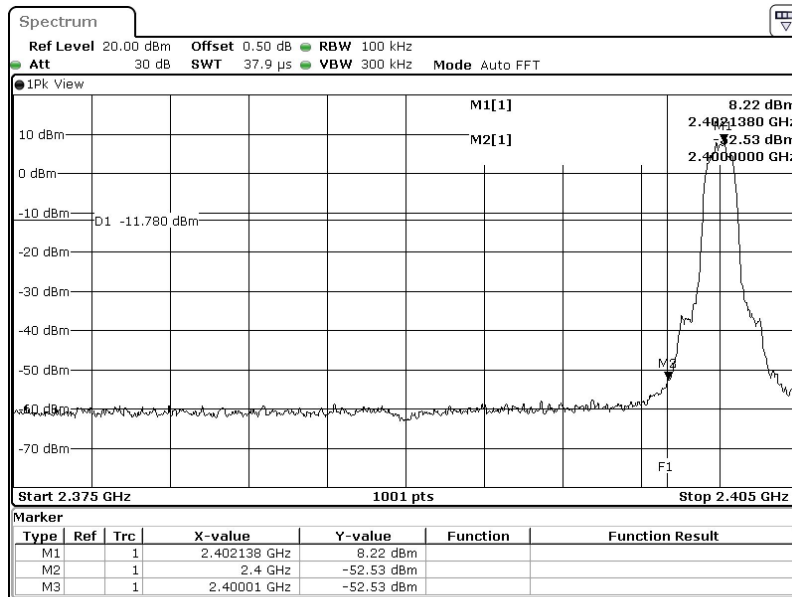

Date: 25.APR.2023 14:53:41

Channel 78:

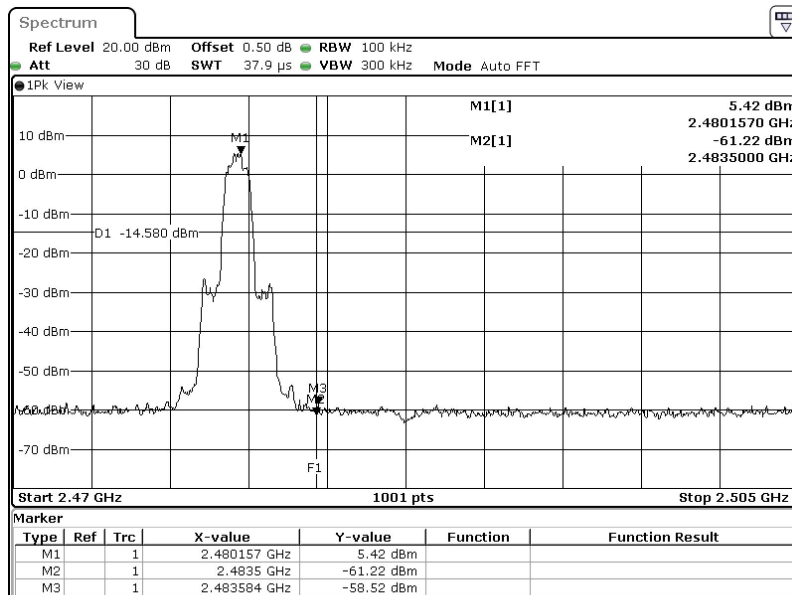

Date: 25.APR.2023 14:55:10

Product : TCx EDGE Cam+
 Test Item : Band Edge
 Test Mode : Transmit - 1 Mbps (Hopping on)
 Test Date : 2023/04/25

Measurement Level	Result
Δ (dB)	
> 20	PASS

Channel Hopping:

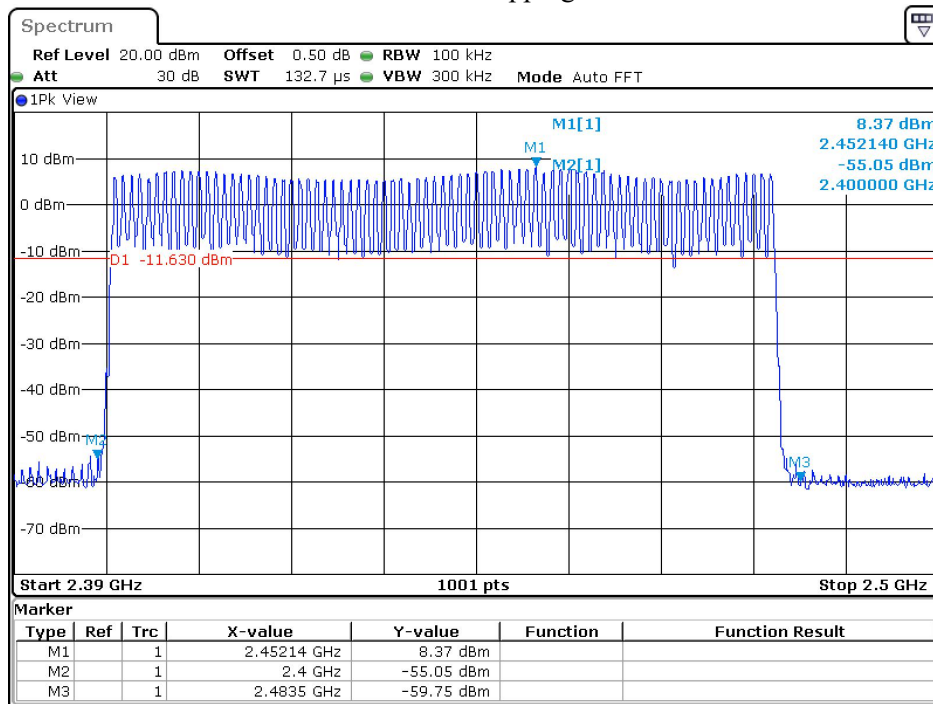

Date: 25.APR.2023 14:43:13

Product : TCx EDGE Cam+
 Test Item : Band Edge
 Test Mode : Transmit - 3 Mbps (Hopping on)
 Test Date : 2023/04/25

Measurement Level	Result
Δ (dB)	
> 20	PASS

Channel Hopping:

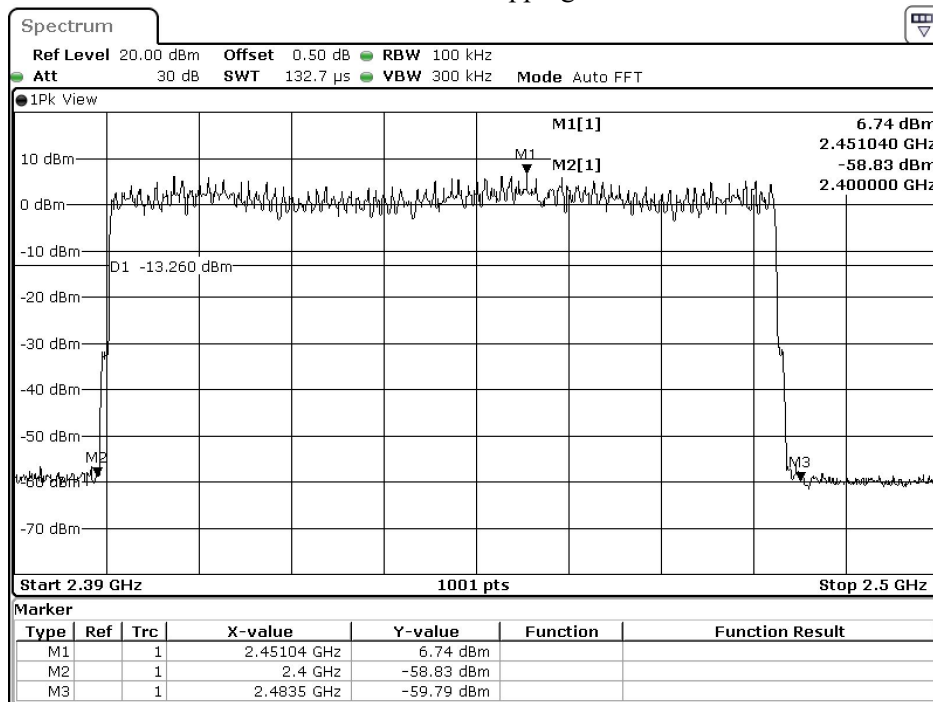

Date: 25.APR.2023 14:56:45

7. Channel Number

7.1. Test Setup

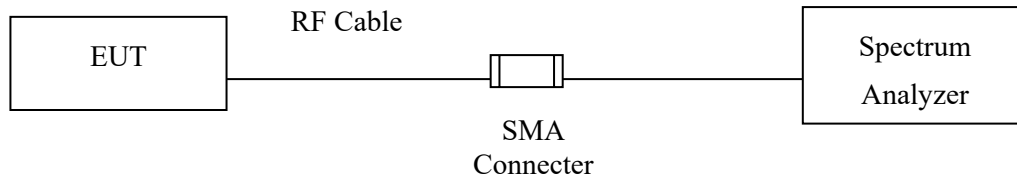

7.2. Limit

Frequency hopping systems operating in the 2400-2483.5 MHz bands shall use at least 15 hopping frequencies.

7.3. Test Procedure

Tested according to FHSS test procedure of KDB558074 section 9 (b for compliance to FCC 47CFR 15.247 requirements.

7.4. Test Result of Channel Number

Product : TCx EDGE Cam+
 Test Item : Channel Number
 Test Mode : Transmit - 1 Mbps
 Test Date : 2023/04/18

Frequency Range (MHz)	Measurement (Hopping Channel)	Required Limit (Hopping Channel)	Result
2402 ~ 2480	79	>15	Pass

2402 MHz

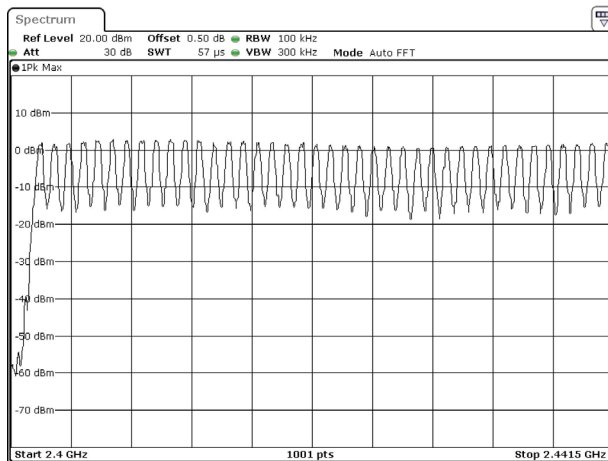

Date: 18 APR 2023 21:36:35

2480 MHz

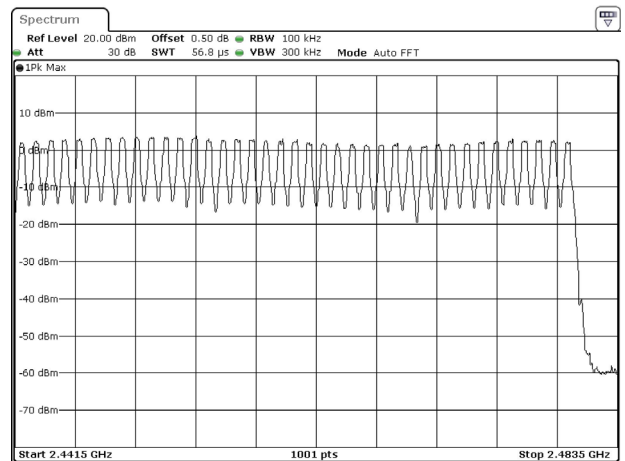

Date: 18 APR 2023 21:37:45

Product : TCx EDGE Cam+
 Test Item : Channel Number
 Test Mode : Transmit - 3 Mbps
 Test Date : 2023/04/18

Frequency Range (MHz)	Measurement (Hopping Channel)	Required Limit (Hopping Channel)	Result
2402 ~ 2480	79	>15	Pass

2402 MHz

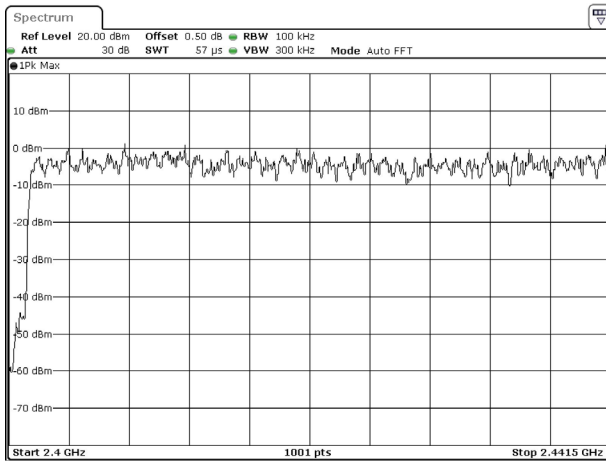

2480 MHz

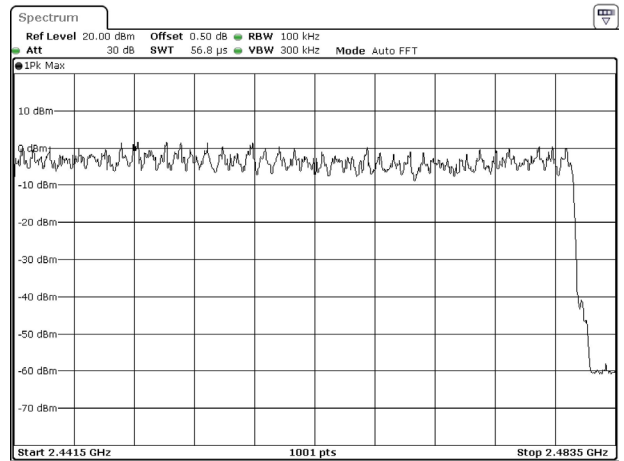

8. Channel Separation

8.1. Test Setup

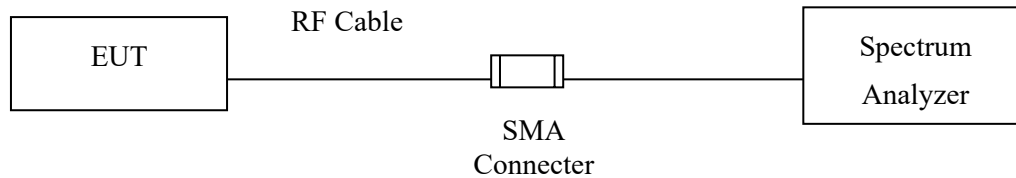

8.2. Limit

Frequency hopping systems shall have hopping channel carrier frequencies separated by a minimum of 25 kHz or the 20 dB bandwidth of the hopping channel, whichever is greater. **Alternatively**, frequency hopping systems operating in the 2400-2483.5 MHz band may have hopping channel carrier frequencies that are separated by 25 kHz or two-thirds of the 20 dB bandwidth of the hopping channel, whichever is greater.

8.3. Test Procedure

Tested according to FHSS test procedure of KDB558074 section 9 (b for compliance to FCC 47CFR 15.247 requirements.

8.4. Test Result of Channel Separation

Product : TCx EDGE Cam+
 Test Item : Channel Separation
 Test Mode : Transmit - 1 Mbps
 Test Date : 2023/04/18

Channel No.	Frequency (MHz)	Measurement Level (kHz)	Limit (kHz)	Limit of (2/3)*20dB Bandwidth (kHz)	Result
00	2402	1001	>25	621.4	Pass
39	2441	1001	>25	621.4	Pass
78	2480	1001	>25	619.4	Pass

Note: The 20dB Bandwidth is refer to section 10.

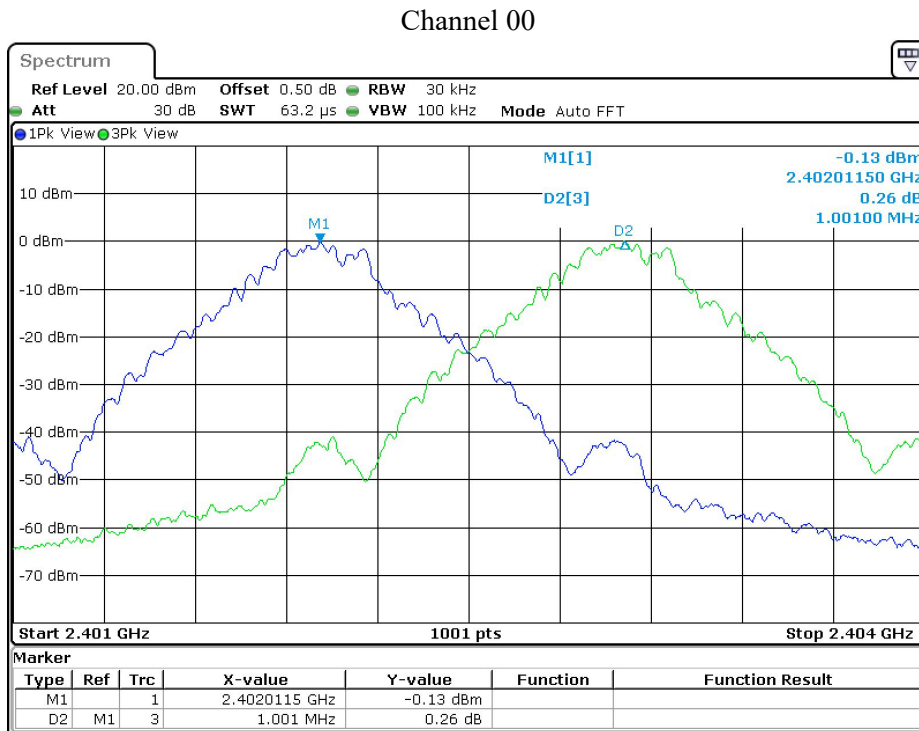

Date: 18.APR.2023 21:26:27

Product : TCx EDGE Cam+
 Test Item : Channel Separation
 Test Mode : Transmit - 3 Mbps
 Test Date : 2023/04/18

Channel No.	Frequency (MHz)	Measurement Level (kHz)	Limit (kHz)	Limit of (2/3)*20dB Bandwidth (kHz)	Result
00	2402	998	>25	860.7	Pass
39	2441	998	>25	858.7	Pass
78	2480	1001	>25	858.7	Pass

Note: The 20dB Bandwidth is refer to section 10.

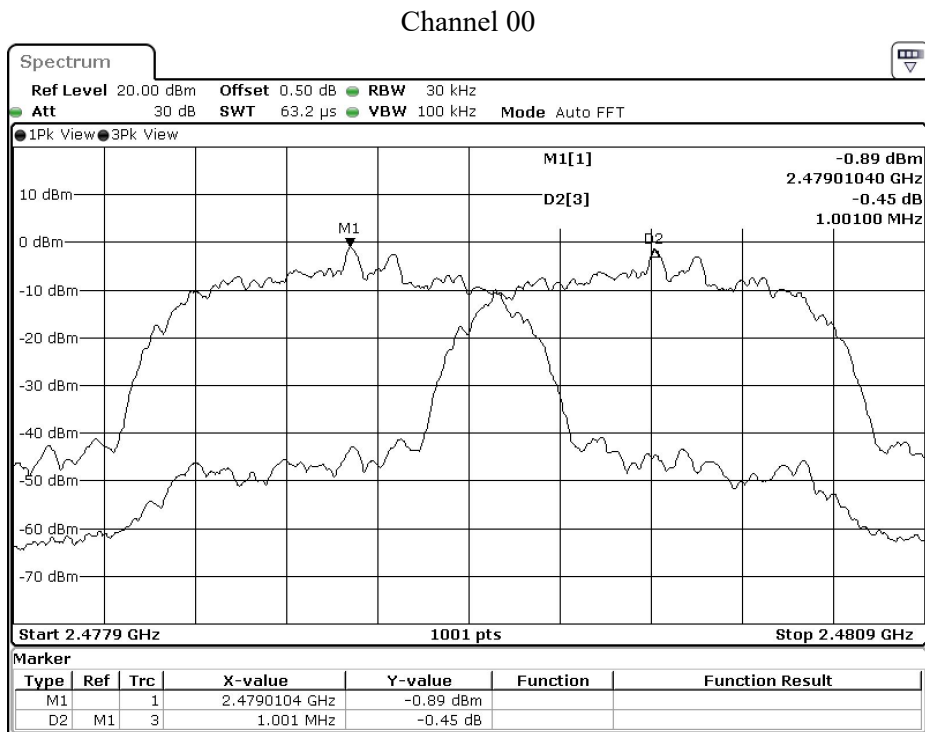

Date: 18.APR.2023 21:50:52

9. Dwell Time

9.1. Test Setup

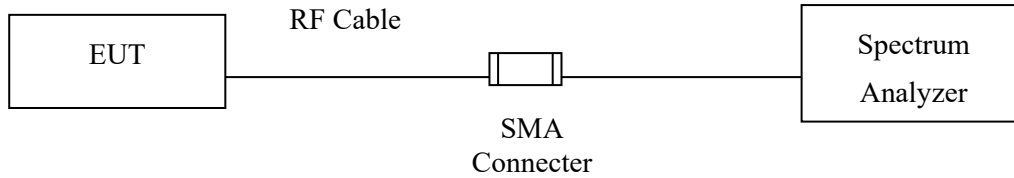

9.2. Limit

The average time of occupancy on any channel shall not be greater than 0.4 seconds within a period of 0.4 seconds multiplied by the number of hopping channels employed.

9.3. Test Procedure

Tested according to FHSS test procedure of KDB558074 section 9 (b for compliance to FCC 47CFR 15.247 requirements.

9.4. Test Result of Dwell Time

Product : TCx EDGE Cam+
 Test Item : Dwell Time
 Test Mode : Transmit - 1 Mbps (Channel 00,39,78)
 Test Date : 2023/04/18

Frequency (MHz)	Time slot length (ms)	Period (sec)	(calculation)	Dwell Time (ms)	Limit (ms)	Result
2402	2.880	31.6	Time(sec)*(266.67/79)*31.6	307.204	400	Pass
2441	2.880	31.6	Time(sec)*(266.67/79)*31.6	307.204	400	Pass
2480	2.880	31.6	Time(sec)*(266.67/79)*31.6	307.204	400	Pass

Note: Dwell time =Time slot length* calculation

CH 00 Time slot length

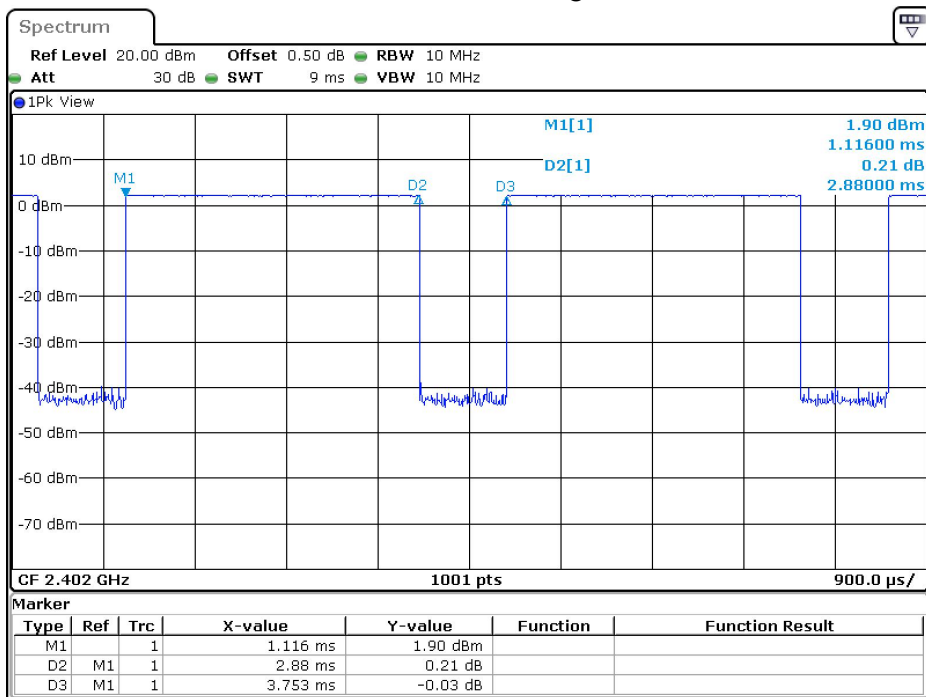

Date: 18.APR.2023 21:25:37

Product : TCx EDGE Cam+
 Test Item : Dwell Time
 Test Mode : Transmit - 3 Mbps (Channel 00,39,78)
 Test Date : 2023/04/18

Frequency (MHz)	Time slot length (ms)	Period (sec)	(calculation)	Dwell Time (ms)	Limit (ms)	Result
2402	2.880	31.6	Time(sec)*(266.67/79)*31.6	307.204	400	Pass
2441	2.880	31.6	Time(sec)*(266.67/79)*31.6	307.204	400	Pass
2480	2.880	31.6	Time(sec)*(266.67/79)*31.6	307.204	400	Pass

Note: Dwell time =Time slot length* calculation

CH 39 Time slot length

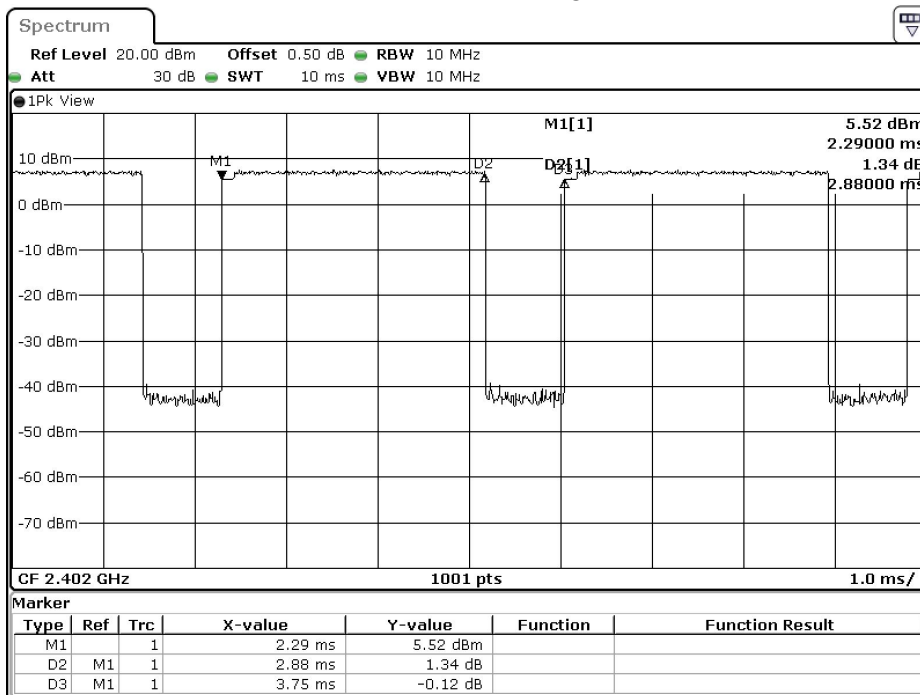

Date: 18.APR.2023 21:40:16

10. Occupied Bandwidth

10.1. Test Setup

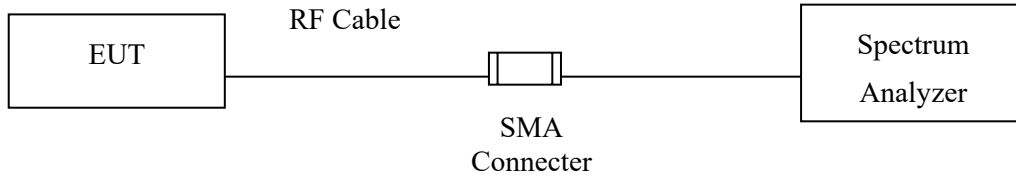

10.2. Limits

N/A

10.3. Test Procedure

Tested according to FHSS test procedure of KDB558074 section 9 (b for compliance to FCC 47CFR 15.247 requirements.

10.4. Test Result of Occupied Bandwidth

Product : TCx EDGE Cam+
 Test Item : Occupied Bandwidth Data
 Test Mode : Transmit - 1 Mbps
 Test Date : 2023/04/25

Channel No.	Frequency (MHz)	Measurement Level (kHz)	Required Limit (kHz)	Result
00	2402	932	--	NA
39	2441	932	--	NA
78	2480	929	--	NA

Channel 00:

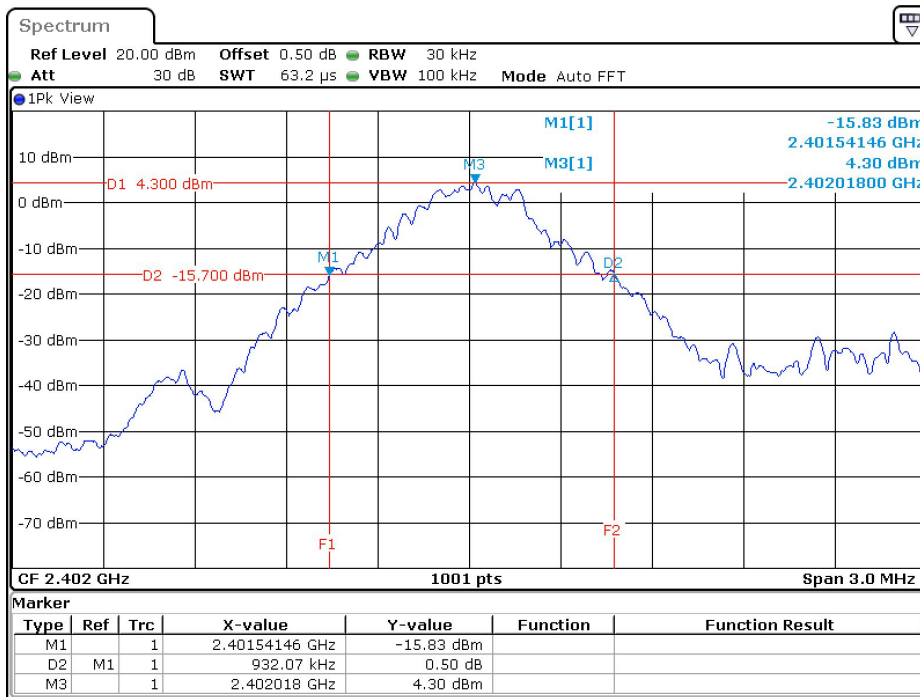

Date: 25.APR.2023 14:41:33

Product : TCx EDGE Cam+
 Test Item : Occupied Bandwidth Data
 Test Mode : Transmit - 3 Mbps
 Test Date : 2023/04/25

Channel No.	Frequency (MHz)	Measurement Level (kHz)	Required Limit (kHz)	Result
00	2402	1291	--	NA
39	2441	1288	--	NA
78	2480	1288	--	NA

Channel 00:

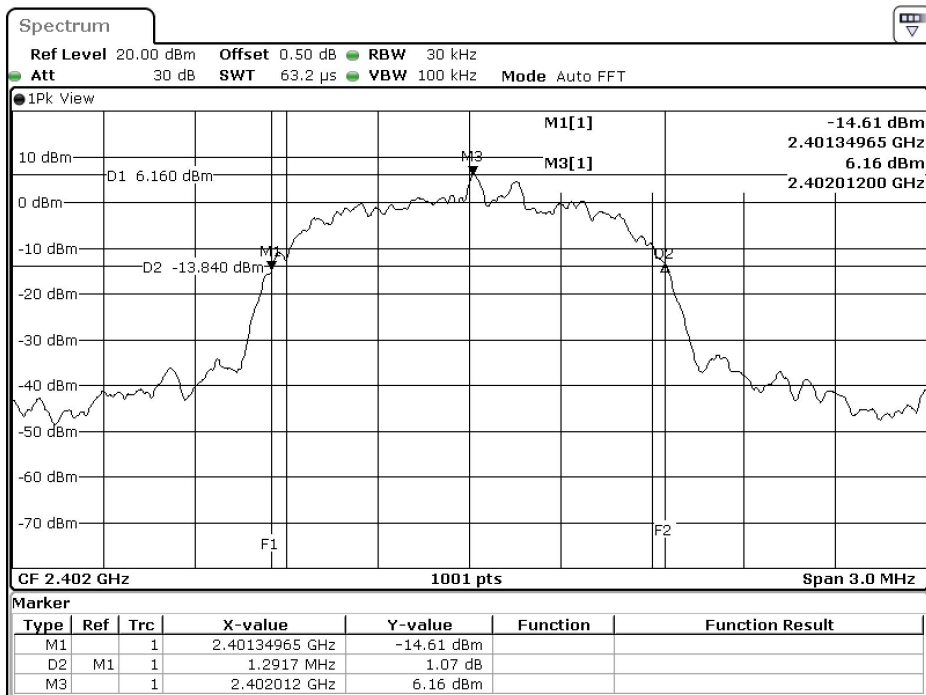

Date: 25.APR.2023 14:53:25

11. Duty Cycle

11.1. Test Setup

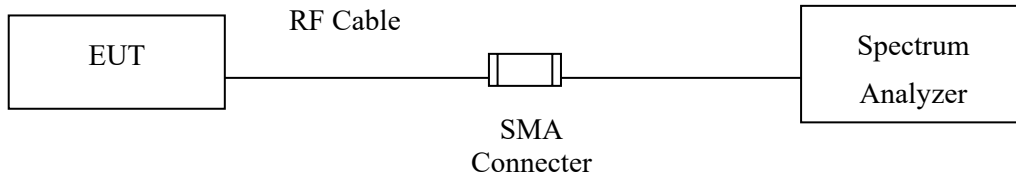

11.2. Test Result of Duty Cycle

Product : TCx EDGE Cam+
 Test Item : Duty Cycle Data
 Test Mode : Transmit - 1 Mbps

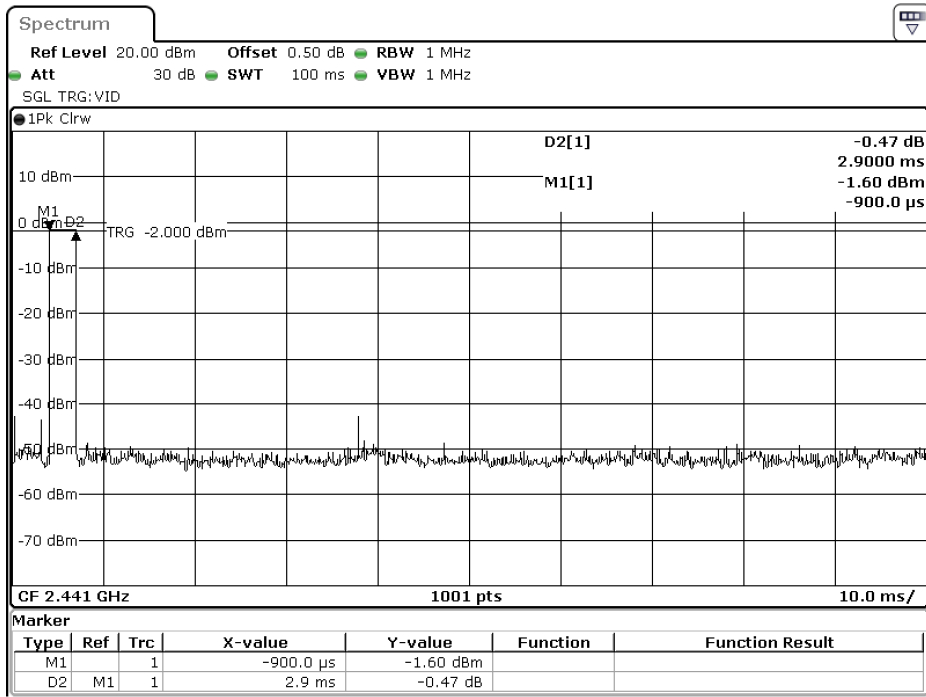

Date: 19.APR.2023 18:42:28

Time on of 100ms = 2.90 msec

Duty Cycle = 2.90 msec / 100msec = 0.029

Duty Cycle correction factor = 20 LOG 0.029 = -30.752 dB

Duty Cycle correction factor	-30.752 dB
-------------------------------------	-------------------

Product : TCx EDGE Cam+
 Test Item : Duty Cycle Data
 Test Mode : Transmit - 3 Mbps

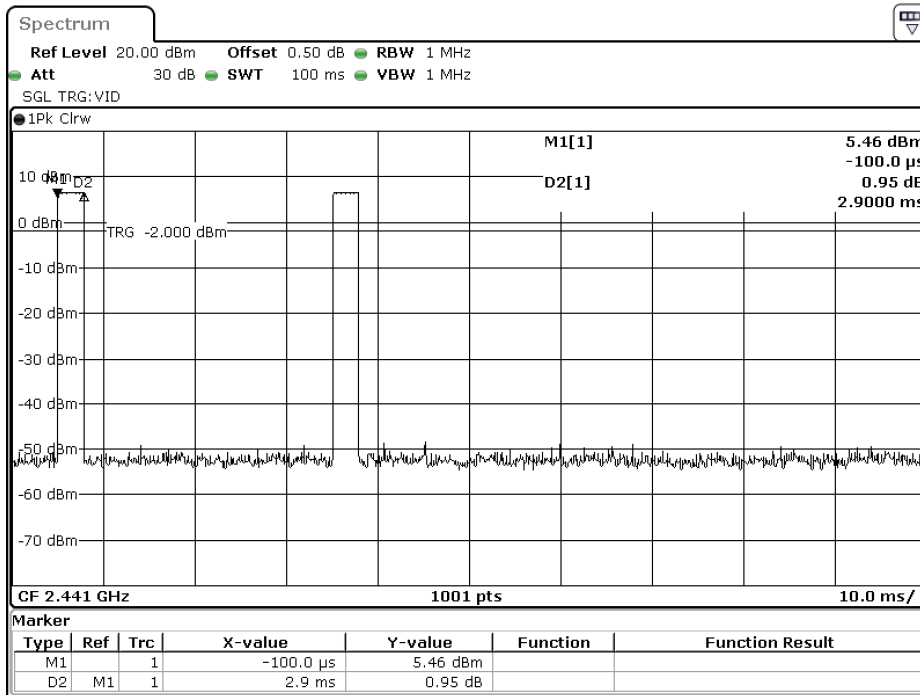

Date: 19.APR.2023 18:40:26

Time on of 100ms = 5.80 msec

Duty Cycle = 5.80 msec / 100msec = 0.058

Duty Cycle correction factor = 20 LOG 0.058 = -2.731 dB

Duty Cycle correction factor	-24.731 dB
-------------------------------------	-------------------